



EW87501
Transmission Fluid Exchange Machine
w/ Dipstick Mode



Operations Manual

TABLE OF CONTENTS

INTRODUCTION TO THE MACHINE	2
CUSTOMER SERVICE CONTACT INFO	2
I. SAFETY INFORMATION	3
- Section 1.01: Important Safety Notice.....	3
- Section 1.02: Important Safety Instructions.....	5
II. MACHINE SPECIFICATIONS & FEATURES	9
- Section 2.01: Specifications.....	9
- Section 2.02: Features.....	9
- Section 2.03: Machine Overview.....	10
III. OPERATING INSTRUCTIONS	11
IV. TROUBLESHOOTING & MAINTENANCE	18
- Section 4.01: Common Problems / Solutions	18
- Section 4.02: Maintenance	18
V. REPLACEMENT PARTS	19
WARRANTY	21

CUSTOMER SERVICE CONTACT INFORMATION

For product information, tech support, or to order replacement parts,
 please call: **833-303-4644**
 or visit: **equipment.wynnsusa.com**

INTRODUCTION to the Wynn's Transmission Fluid Exchange Machine w/ Dipstick Mode

Congratulations on the purchase of your Wynn's Transmission Fluid Exchange Machine w/ Dipstick Mode!

Simply put, this machine is the cleanest, safest, easiest, fastest, most thorough, and most cost-efficient method of fluid exchange ever devised. Suddenly, regular automatic transmission maintenance becomes a more realistic proposition. With this machine, you can exchange the transmission fluid either through the transmission cooler lines OR through the vehicle's dipstick. Transmission fluid exchanging is cleaner and easier than ever!

Transmission Fluid Exchange:

To attain the highest level of protection for internal transmission components and increase the transmission's life span to the maximum, it is recommended that the transmission's lubrication system is serviced every 15,000 miles (or according to the vehicle owner's manual). This machine exchanges virtually all of the used transmission fluid to new, without even requiring the transmission pan to be dropped. There is no spillage, and no mess.

- **The machine can be used practically anywhere – and with almost any vehicle.**
- **It is compact, mobile, and self-contained.**
- **It operates off the 12-volt battery of the vehicle being serviced.**
- **It does not require a pit, lift, or ramp.**
- **The machine hooks up directly to one of the vehicle's transmission cooler lines for a transmission fluid exchange or through the dipstick.**
- **The transmission fluid exchange, from setup to finish, typically takes 15 minutes or less for inline mode, and 10 minutes or less for dipstick mode!**

A transmission fluid exchange is the most requested method of preventative automatic transmission maintenance today.

Please take time to read through this manual to familiarize yourself with the machine before performing your first transmission exchange.

CUSTOMER SERVICE CONTACT INFORMATION

For product information, tech support, or to order replacement parts,
please call: **833-303-4644**
or visit: ***equipment.wynnsusa.com***

I. SAFETY INFORMATION

1.01 IMPORTANT SAFETY NOTICE

For your safety, read this manual thoroughly before operating your machine. Your machine is intended for use by properly trained, skilled professional automotive technicians. The safety messages presented below and throughout this user's manual are reminders to the operator to exercise care when using this unit. Before using your machine, always refer to and follow the safety messages and applicable service procedures provided by the manufacturer of the vehicle being serviced.

• Read All Safety Instructions

Read, understand and follow all safety messages and instructions in this manual. Safety messages in this section of the manual contain a signal word with a three-part message and, in some instances, an icon.

• Signal Words

The signal word indicates the level of the hazard in a situation:

DANGER

Indicates an imminently hazardous situation which, if not avoided, will result in death or serious injury to the operator or to bystanders.

WARNING

Indicates a potentially hazardous situation which, if not avoided, could result in death or serious injury to the operator or to bystanders.

CAUTION

Indicates a potentially hazardous situation which, if not avoided, may result in moderate or minor injury to the operator or to bystanders.

IMPORTANT

Indicates a situation which, if not avoided, may result in damage to the machine or the vehicle being serviced.

• Safety Messages

Safety messages in this section contain three different type styles:

- Normal type states the hazard.
- **Bold type** states how to avoid the hazard.
- *Italic type* states the possible consequences of not avoiding the hazard.

• **Safety Symbols**

A safety symbol, when present, gives a graphical description of the potential hazard, and how to avoid the hazard:



Risk of Fire



Read Instructions Before Use



Risk of Explosion



Mandatory Eye Protection



Risk of Entanglement



Mandatory Protective Gloves



Dangerous Fumes



Mandatory Protective Clothing



Do Not Pull or Move

1.02 IMPORTANT SAFETY INSTRUCTIONS

DANGER



Engine exhaust contains toxic gases.

- **Vent vehicle's exhaust away from work area.**
- **Do not breathe exhaust.**

Exhaust gases will cause injury or death.

WARNING



Improper use and operation.

- **Read, understand and follow all safety messages and operational procedures in this manual before operating the machine.**
- **This equipment should be operated only by qualified personnel.**
- **Use this equipment only as described in this manual.**

Improper use and operation of this product can result in injury.

WARNING



Engine systems can malfunction, expelling fuel, oil vapors, hot steam, hot toxic exhaust gases and other debris.

- **Wear safety goggles and protective clothing, user and bystander.**

Engine systems that fail can cause serious injury.

WARNING



Risk of expelling pressurized fluids.

- **Wear safety goggles and protective clothing, user and bystander.**
- **Verify that engine and machine are off before connecting or disconnecting cooler lines and adapter hoses.**
- **Always unplug the machine from its power source when not in use.**
- **Keep the service hoses away from hot or moving engine parts. Hoses can split or burst causing fluid to be expelled.**
- **Tighten all connections properly. Insufficient or excessive torque can result in fluid leakage.**
- **Avoid contact with automatic transmission fluid.**
- **Treatment methods are as follows:**
 - Eyes:** Flush eyes with plenty of water.
 - Skin:** Wash with soap and water.

Inhalation: Move to uncontaminated area.

Ingestion: If large amount, get medical attention.

If any irritation persists, get medical attention.

- **Dispose of used fluid according to environmental laws and regulations.**

Although automatic transmission fluid poses no significant health hazards, some individuals may experience adverse reactions upon contact. Pressurized fluid can cause serious injury.

WARNING

Risk of unexpected vehicle movement.

- **Block drive wheels before starting vehicle's engine to begin an exchange.**
- **Unless instructed otherwise, set parking brake and put gear selector in park.**
- **Do not leave a running vehicle unattended.**

A moving vehicle can cause injury.

WARNING



Engine has moving parts. Risk of entanglement.

- **Do not place tools on fenders or other places in engine compartment.**
- **Keep yourself, clothing, battery cables and service hoses clear of moving parts such as fan blades, belts and pulleys.**

Contact with moving parts can cause injury.

WARNING



Risk of fire or explosion.

- **Do not operate the machine in the vicinity of open containers of flammable liquids such as gasoline.**
- **Keep hoses and jumper cables away from heat sources and sharp edges.**
- **Do not operate equipment with damaged cords or hoses until they have been examined by a qualified serviceman.**

Fire or explosion can cause injury.

WARNING



Risk of fire or explosion. Gases produced by a battery are highly explosive.

- **Wear safety goggles and protective clothing, user and bystander.**
- **This machine is equipped to operate on 12-volt DC power only. A power source greater than this can result in serious injury to the user as well as damage to the machine.**
- **Do not smoke, place metal tools on battery or allow a spark or flame in vicinity of battery.**
- **Clean battery terminals before hooking the machine's battery clips to them. During cleaning, keep airborne corrosion from eyes, nose and mouth.**

- Be sure both battery cables are tightly connected to the battery terminals as instructed before proceeding with a fluid exchange.
- Never remove battery cables from the battery terminals while the machine is operating. Only use the “EMERGENCY STOP” button located on the control panel to stop an exchange.

Battery explosion can cause injury.

WARNING



Battery acid is a highly corrosive sulfuric acid.

- **Wear safety goggles and protective gloves, user and bystander.**
- **Have plenty of fresh water and soap nearby. If battery acid contacts skin, clothing, or eyes, flush exposed area with soap and water for 10 minutes.**
- **While cleaning battery's terminals, keep airborne corrosion from eyes, nose and mouth.**
- **Do not touch eyes while working near battery.**

Battery acid can burn eyes and skin.

WARNING



Risk of burns.

- **Wear gloves when working near hot engine components.**
- **Do not touch hot exhaust systems, manifolds, engines, radiators, etc.**
- **The automatic transmission fluid coming from the vehicle along with some of the machine's components that the fluid comes into direct contact with (i.e. external: hoses and quick-disconnect fittings; internal: hoses and all fittings) may reach temperatures uncomfortable to the touch. Exercise caution in avoiding contact with these items.**

Hot components can cause injury or discomfort.

CAUTION

Ratchet mechanisms and tools may slip or break if dirty. Mismatched or partially worn parts can cause ratchet or any tool to slip or break.

- **Frequently inspect and clean any tools used, and lubricate all non-sealed ratchet mechanisms with light oil.**
- **Do not replace worn parts individually. If adapter hose fittings become worn, see “Appendix C – Replacement Parts” to order new hoses.**
- **The use of any other accessories not specified in this manual may create a hazard.**

Tools that slip or break can cause injury.



Risk of injury.

- This equipment should be operated by qualified personnel only.
- Use this equipment only as described in this manual.
- Always unplug the machine from its power source when not in use.
- Loop the power cord loosely in its proper location when machine is not in use.
- Do not operate equipment with a damaged battery cables or hoses, or if the equipment has been dropped or damaged, until it has been examined by a qualified service representative.
- Care should be taken to arrange the battery cables and service hoses so that they will not be tripped over or pulled.
- Never pull on the power cables or service hoses to transport the machine. Damage may occur to these components, or machine may tip over.
- Keep area of operation clear of unnecessary tools and equipment. Utilize recessed tool storage areas on the top of the machine.
- Never leave the machine running unattended.
- This machine is not designed for any other purpose than the exchanging of automatic transmission fluid.

Operation of your machine by anyone other than qualified personnel may result in injury.

IMPORTANT

Risk of equipment damage.

- Servicing high mileage cars that have not been previously serviced can cause operating problems in the transmission.
- Connect battery cables to a 12-volt power source only (i.e. vehicle's battery).
- Servicing, transporting, or storing this machine in an attitude other than the normal operating position can result in fluid spillage and/or component damage.
- Use only the manufacturer's recommended attachments.
- This machine is fully automatic. Refer to your control panel at all times.
- Never pull on the power cables or service hoses to transport the machine. Damage may occur to these components, or machine may tip over.
- Periodically clean the machine by wiping down with a clean, soft, dry cloth.

Improper operation of equipment may result in damage to machine or components.

SAVE AND FOLLOW THESE INSTRUCTIONS!

II. MACHINE SPECIFICATIONS & FEATURES

2.01 SPECIFICATIONS

Dimensions: 38" H x 24" W x 26" D

Weight: 90 lbs.

New Fluid Bottle: 24 Qt.

Waste Fluid Bottle: 24 Qt.

Power: 12V DC Power

2.02 FEATURES

Extending the life of a transmission has just been made easier with the Wynn's Transmission Fluid Exchange Machine with Dipstick Mode providing ability to service most vehicles.

- ✓ Cooler Line & Dipstick Exchange Modes
- ✓ Quart Counter (1-20 Quarts)
- ✓ Power Interruption Memory
- ✓ Complete Transmission Drainage for Filter Change
- ✓ Integrated Additive Injection
- ✓ Full Evacuation of Waste Fluid
- ✓ Proven, Accurate Fluid Measurement (+/-3%)
- ✓ Separate Add/Remove Fluid Buttons
- ✓ Voltmeter
- ✓ Large Back-Lit Trilingual LCD Display with Operational Prompts
- ✓ Standard & Metric Measuring Options
- ✓ Clear Service Hoses for Visual Fluid Flow
- ✓ Adapter Drainage-Style Rack
- ✓ Convenient, Portable Roll-Around Unit

2.03 MACHINE OVERVIEW

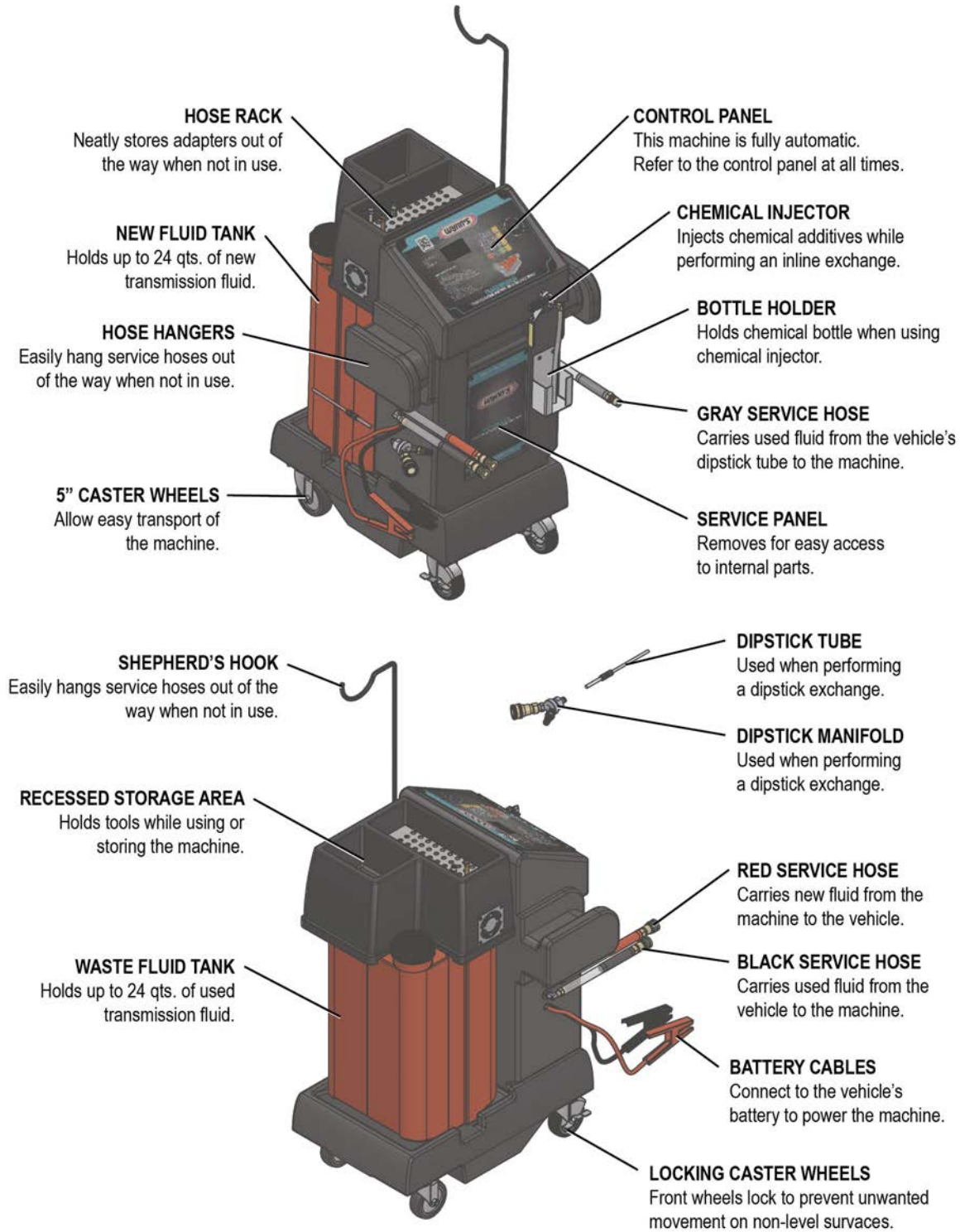

III. OPERATING INSTRUCTIONS





OPERATION



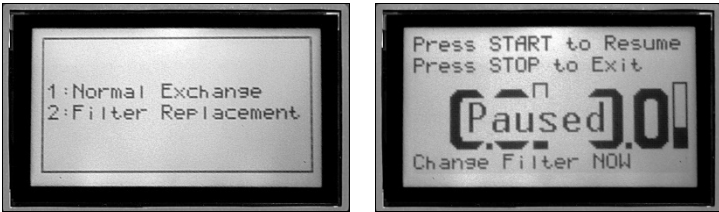

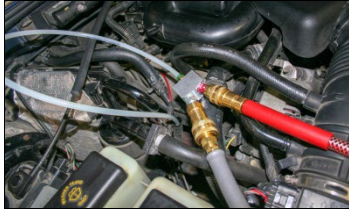
NOTE: This machine is fully interactive. Always follow the on-screen instructions.

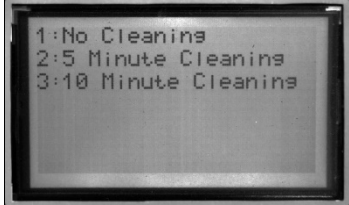
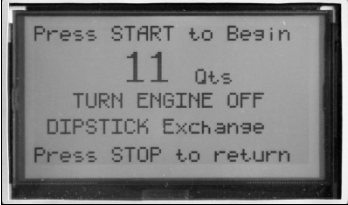
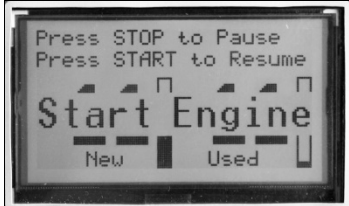



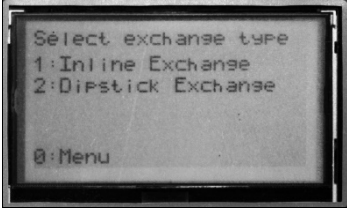

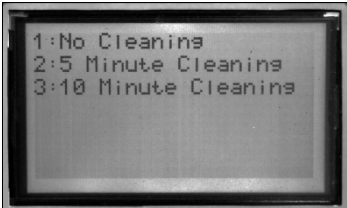
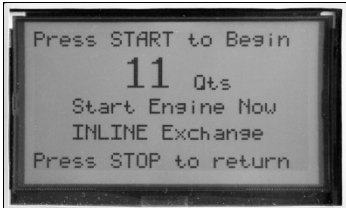

SAFETY RECOMMENDATIONS		
<p>Use extreme safety measures when working around a running engine.</p> <p>Always block the vehicle's drive wheels.</p> <p>Ventilate the vehicle's exhaust.</p> <p>Always wear safety glasses.</p> <p>It's a good idea to wear gloves.</p>		 <p>Dipstick Mode</p>
		 <p>Inline Mode</p>

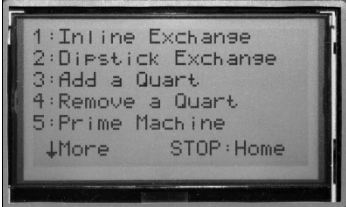
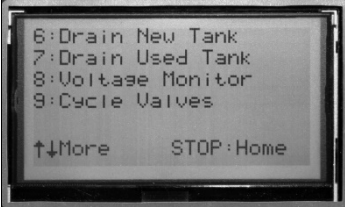
PREPARATION	
<p>Road test the vehicle for at least one mile.</p> <p>Make sure there are no problems with the transmission such as leaks, low fluid level, shifting issues, etc.</p> <p>Connect battery cables to vehicle's battery.</p>	

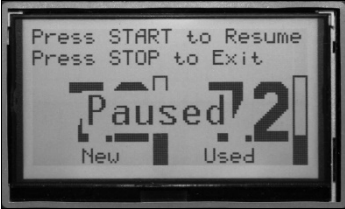
PERFORMING A DIPSTICK EXCHANGE	
<p>Press 2 for Dipstick Exchange.</p> <p>Add Wynn's Transmission Cleaner.</p> <p>See "Adding Chemicals" section below.</p>	
<p>Press 1 for Normal Exchange. When this is selected, the machine will complete the exchange without prompting you to change the vehicle's transmission filter.</p> <p>Press 2 for Filter Replacement. When this is selected, the machine will pause during the exchange and prompt you to change the vehicle's transmission filter. Follow the on-screen instructions.</p>	

<p>Connect red and gray service hoses to chrome manifold. Insert nylon tube down dipstick tube the same length as the dipstick, being cautious not to insert too far.</p> <p>Use the yellow ▲ ▼ arrow keys to select the desired amount to be exchanged. Press the green button to proceed.</p>	 
<p>When prompted, select a cleaning mode to circulate additives through the vehicle's transmission.</p> <p>Press 3 for 10 Minute Cleaning</p> <p>Press the Green Button to begin the exchange.</p>	 
<p>Start the vehicle's engine when the display prompts you to do so. Then press the Green Button to proceed.</p> <p>Once the exchange is finished, the screen will beep and display "Complete".</p> <p>Add Wynn's Transmission Treatment.</p> <p>See "Adding Chemicals" section below.</p>	 

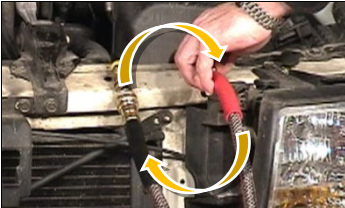
PERFORMING AN INLINE EXCHANGE	
<p>Press 1 for Inline Exchange.</p> <p>Vehicles with Internal Transmission Thermostats: Before a transmission fluid exchange service can be performed, refer to O.E. recommended procedure to ensure transmission fluid flow through transmission cooler.</p>	
<p>Connect appropriate adapters to vehicle's cooler line fittings. Connect the red and black service hoses to the quick disconnect adapters on the end of the cooler line adapters.</p> <p>Add Wynn's Transmission Cleaner.</p> <p>See "Adding Chemicals" section below.</p> <p>Use the yellow ▲ ▼ arrow keys to select the desired amount to be exchanged. Press the Green Button to proceed.</p>	 
<p>When prompted, select a cleaning mode to circulate additives through the vehicle's transmission.</p> <p>Press 3 for 10 Minute Cleaning</p> <p>Start the vehicle's engine when the display prompts you to do so. Then press the Green Button to begin the exchange.</p>	 
<p>Once the exchange is finished, the screen will beep and display "Complete".</p> <p>Add Wynn's Transmission Treatment.</p> <p>See "Adding Chemicals" section below.</p>	 

FUNCTIONS USED DURING AN EXCHANGE		
<p>Press 0 at any time to return to the main menu.</p>		
<p>If needed, while running, press the Red Button once to pause the exchange.</p> <p>Press the Green Button to resume from pause.</p> <p>Press the Red Button a second time to cancel the exchange.</p>		
<p>When checking the fluid level:</p> <p>Press + or - to add or remove fluid in 2/10 of a quart increments.</p> <p>Use Option 3 in the main menu to add a full quart, and Option 4 to remove a full quart.</p>		
<p>If the exchange stops and the display reads "Halted – Reverse Hoses", turn the vehicle off, switch the red and black service hoses, restart the vehicle, and press the Green Button to resume the exchange.</p>		
<p>If the exchange stops and the display reads "Halted – Shift to Neutral", set the vehicle's parking brake, shift to neutral, and press the Green Button to resume the exchange.</p>		

ADDING CHEMICALS

When cleaning or conditioning the vehicles transmission it is recommended to add chemicals through the dipstick. Always check the transmission fluid level prior to, and after, performing the service. The Instructions below assume a proper fluid level before beginning.

ADDING CHEMICALS THROUGH THE DIPSTICK TUBE (PREFERRED METHOD)

Pour Wynn's Transmission Cleaner or Wynn's Transmission Treatment directly into the dipstick tube using a suitably sized funnel.



FOR SEALED TRANSMISSIONS & INLINE SERVICE

Place bottle into bottle holder on front of cabinet. Insert draw tube into bottle. While holding the yellow handle up, press the + button. Release the handle when the bottle is empty. Press the + button a second time.



ADDITIONAL FUNCTIONS

MAIN MENU

Press 0 at any time to return to the main menu.

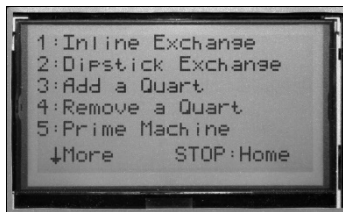

PRIMING THE MACHINE

Press 5 to select Prime Machine.

The machine will prompt you to join the red and black service hoses.

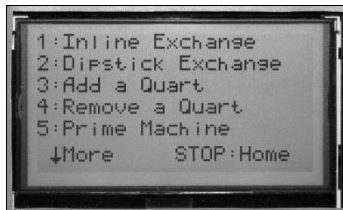

Make sure there is fluid in the new fluid tank.



<p>Connect the red and black service hoses together using any two mating adapters.</p> <p>Press the Green Button to begin the process.</p> <p>The unit will shut off when complete.</p>	 
--	---

DRAINING THE TANKS

<p>From the main menu, press ▼ to proceed to the next menu. Press 6 to drain the NEW FLUID tank, or 7 to drain the USED FLUID tank.</p> <p>To fully drain a fluid tank, press ▼ <i>twice</i> from the main menu. Press 1 to fully drain the NEW FLUID tank, or 2 to fully drain the USED FLUID tank. After fully draining either fluid tank, the machine must be primed.</p>	 
---	---

<p>Connect any open-ended adapter to the red service hose and insert into an appropriate disposal container. Make sure all other hoses are disconnected!</p> <p>Press the Green Button to begin the process.</p> <p>The unit will shut off when complete.</p> <p>NOTE: When fully draining a tank, the machine will not stop automatically when the tank is empty. You must push the Red Button on the control panel when the machine begins to pump air out of the red service hose.</p>	 
---	---

VOLTAGE MONITOR

From the main menu, press ▼ to proceed to the next menu. Press 8 to display the voltage.



TOTAL FILTER USE

From the main menu, press ▼ twice. Press 3 to display the total filter use. Press 2 to reset.



FILTER CHANGE DUE

The machine will indicate when the canister filters need to be replaced. Remove service panel. Use a standard filter band clamp tool to unscrew old filters, and replace them with new filters. Make sure new filters are on tight.

IMPORTANT: Machine must be primed after filter change.



POWER FAILURE MEMORY

If there is a power failure during a fluid exchange, the procedure can be continued seamlessly.

Simply reconnect the battery cables and press the Green Button. The exchange will resume where it left off.

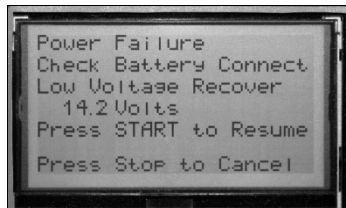

CYCLE VALVES

From the main menu, press ▼ to proceed to the next menu. Press 9 to cycle the valves.



IV. TROUBLESHOOTING & MAINTENANCE

4.01 COMMON PROBLEMS / SOLUTIONS

Problem: "Power Failure" screen displays

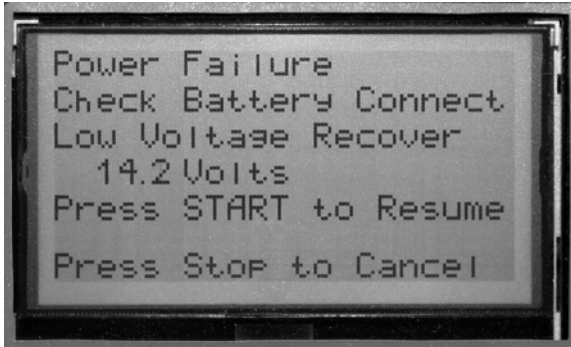

Solution 1: Check battery connection. Make sure there are no loose connections, and the machine's battery clips are not reversed. Remove all corrosion from the battery terminals. Make sure vehicle's A/C system is turned off.

Solution 2: The vehicle's battery is not putting out enough voltage to run the machine. Connect the machine to a better 12V power source. Stand-alone shelf batteries will not work.

4.02 MAINTENANCE

• **Replace Canister Filters (Part#: 940796A) when machine prompts you to do so:**

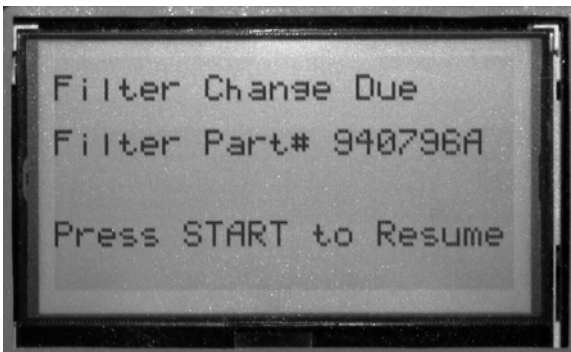

Use a standard filter band clamp tool to unscrew old filters, and replace them with new filters. Make sure new filters are on tight.

• **Clean Waste Fluid Screen (Located in bottom of recessed hose tray area)**

This helps eliminate surface tension caused by debris and contamination from the air. Using a sharp pick, remove screen. Clean using degreaser and brush, and blow out with air compressor.

• **Periodically Wipe Down Exterior using a soft, damp cloth.**

V. REPLACEMENT PARTS

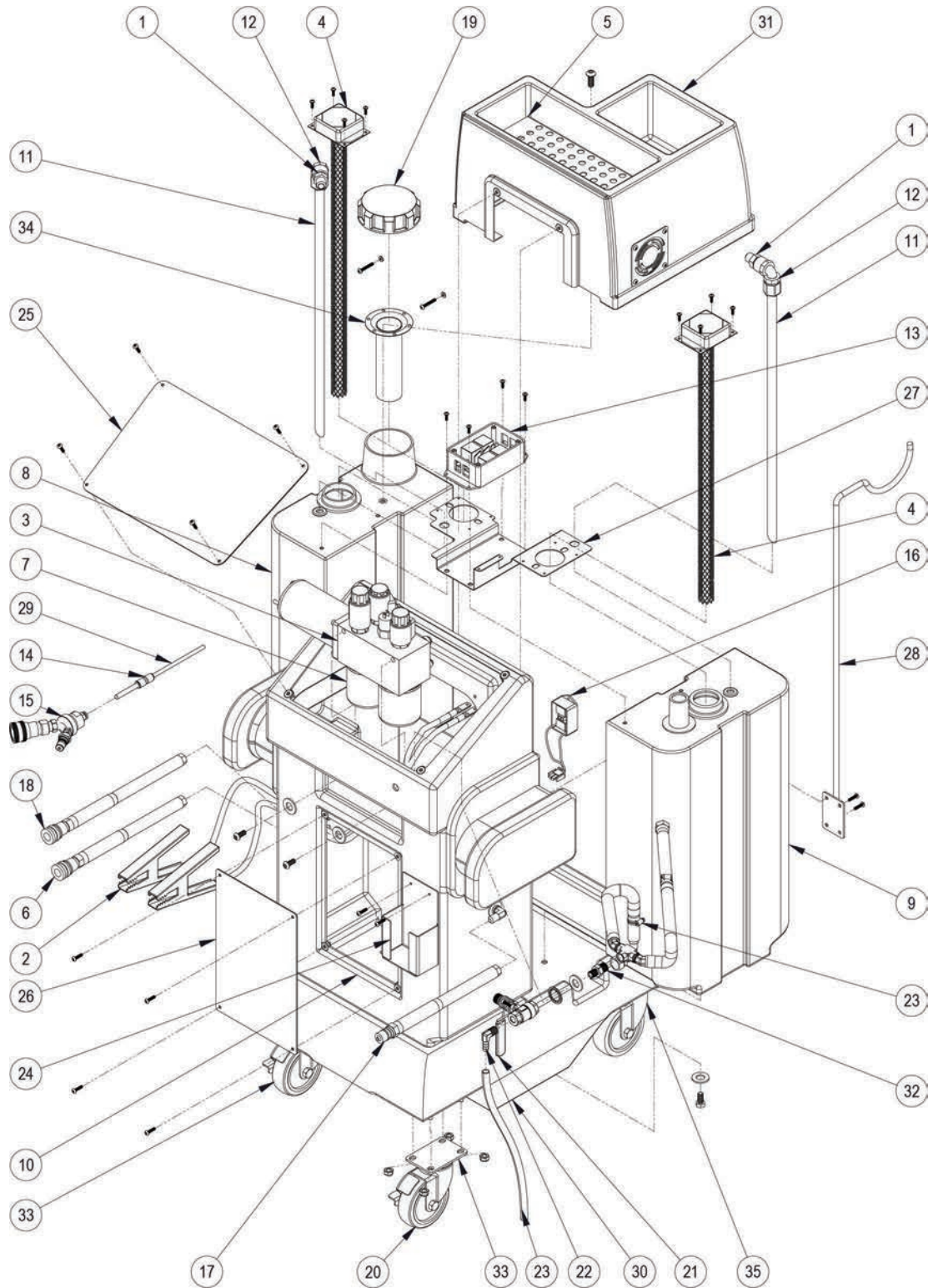

ITEM NO.	PART NO.	DESCRIPTION	QTY.
1	940125	MALE CONNECTOR 1/2 NPT X 1/2 JIC	2
2	940307	6 GA BATTERY CABLES	1
3	940468	MANIFOLD W/RPUMP NO PRO PORT	1
4	940474	FLUID LEVEL SENSOR SHORT	2
5	940772	HOSE TRAY	1
6	940785	SERVICE HOSE (BLACK)	1
7	940796A	CANISTER FILTER	2
8	941202	NEW FLUID TANK	1
9	941203	USED FLUID TANK	1
10	941205	CONSOLE - BLACK	1
11	941225	TUBE ALUMINUM 5/8 X 23.81	2
12	941226	ELBOW PLASTIC FEMALE 1/2NPT X 5/8TU	2
13	941617W	MOTOR CONTROL BOX	1
14	941708	ADAPTER - DIPSTICK REDUCER HOSE	1
15	941716W	"Y" MANIFOLD FOR DIPSTICK SERVICE MACHINES	1
16	941726OV	OVER - VOLTAGE PROTECTOR	1
17	941728	SERVICE HOSE (GREY)	1
18	941786	SERVICE HOSE (RED)	1
19	942113	TANK CAP	1
20	942137W	WHEEL ONLY 4" CASTERS	4
21	40200455	BALL VALVE WITH SPRING HANDLE 1/4" NPT	1
22	40200483	ELBOW 1/4 X 3/8	1
23	40200591	NEW TANK INTERNAL HOSE SET	1
24	40300262	BOTTLE HOLDER	1
25	40300298	PANEL - OVERLAY ASSEMBLY	1
26	40300305	SERVICE PANEL - OVERLAY ASSEMBLY	1
27	P941234	TANK BRACKET- BLACK FORMED	1
28	P941725	SHORT SHEPHERD HOOK ASSEMBLY	1
29	R940557	5/16" X 6' POLY TUBE (PER FT.)	1
30	R940750	CHASSIS - BLACK	1
31	R940752	TOP - BLACK	1
32	R940817	HEX NIPPLE 3/8 X 1/4 NPT	1
33	R942118	CASTER 4" WITH BRAKE	2
34	R942129	SCREEN BASKET	1
35	R942137	CASTER 4" SWIVEL	2

Wynn's Equipment Limited Warranty Terms and Conditions

(1 Year on Equipment / 2 Years on Parts)

Seller warrants to its distributors that under normal use, care and service, the Equipment (except as otherwise provided herein) shall be free from defects in material and workmanship for One (1) year from the date of original invoice (unless a machine was put into inventory and later sold (such sale from inventor to occur no later than [six (6) months] after the date of original invoice), and a distributor can provide proof of sale and registered warranty card, then the one-year warranty will begin on the registration date) for all Equipment with an additional 12 months of coverage for **parts only**. External hoses, remote control modules, adapters and all other attachments, supplies and consumables (except as otherwise provided herein) are warranted for 90 calendar days from the date of original invoice. Filter elements are not warranted. Printed circuit boards purchased from Seller will be warrantable for a period of one (1) years from original purchase date, and any repair services for machines under warranty or to a purchased circuit board by an ITW employee or authorized representative shall be reimbursed.

SELLER'S OBLIGATIONS UNDER THIS WARRANTY ARE LIMITED SOLELY TO THE REPAIR OR, AT SELLER'S OPTION, REPLACEMENT OF EQUIPMENT OR PARTS, AND LABOR COSTS ASSOCIATED WHICH TO SELLER'S SATISFACTION ARE DETERMINED TO BE DEFECTIVE AND WHICH ARE NECESSARY, IN SELLER'S JUDGEMENT, TO RETURN THE EQUIPMENT TO GOOD OPERATING CONDITION. NO OTHER WARRANTIES EXPRESS OR IMPLIED OR STATUTORY, INCLUDING WITHOUT LIMITATION ANY IMPLIED WARRANTY OF MERCHANTABILITY OR FITNESS FOR A PARTICULAR PURPOSE, SHALL APPLY AND ALL SUCH WARRANTIES ARE HEREBY EXPRESSLY DISCLAIMED.

This warranty does not cover (and separate charges for parts, labor and related expenses shall apply to) any damage to, malfunctioning, inoperability or improper operation of the Equipment caused by, resulting from or attributable to (A) abuse, misuse or tampering; (B) alteration, modification or adjustment of the Equipment by anyone other than Seller's authorized representatives; (D) improper or negligent use, application, operation, care, cleaning, storage or handling; (E) fire, water, wind, lightning or other natural causes; (F) adverse environmental conditions, including, without limitation, excessive heat, moisture, corrosive elements, or dust or other air contaminants, radio frequency interference, electric power failure, power line voltages beyond those specified for the equipment, unusual physical, electrical or electromagnetic stress, and/or any other condition outside of Seller's environmental specifications; (G) use of the Equipment in combination or connection with other equipment, attachments, supplies or consumables not manufactured or supplied by Seller; or (H) failure to comply with any applicable federal, state or local regulation.

Repairs or replacements qualifying under this Warranty will be performed on regular business days during Seller's normal working hours within a similar timeframe and process as BUYER already has in place, to be accomplished by Wynn's/QMI distributors with the support and cooperation of the SELLER, or by SELLER or SELLER's subcontractors if that is acceptable to the BUYER following Purchaser's request or if agreed to between Seller and Buyer by Purchaser's/ ITW staff if necessary. All requests for Warranty service must be made during the stated Warranty period. **This warranty is non-transferable.**

