



2026 LIGHTING PRODUCT GUIDE

| MARINE | TERRESTRIAL | DOCK & DECK | CUSTOM/SPECIALTY APPLICATIONS | DIGITAL LIGHTING CONTROL |

A photograph of a boat at night, viewed from the rear. The boat is illuminated by a bright light on the deck, and the two outboard motors are visible. The sky is dark with a hint of sunset colors. The text '| PERFORMANCE | RELIABILITY | QUALITY |' is overlaid in the center.

| PERFORMANCE | RELIABILITY | QUALITY |



Lumitec is a global leader in extreme-environment LED lighting, with worldwide distribution and a reputation for setting the standard in performance and reliability. Our products are built to exceed expectations and set new standards in quality and durability.

Every Lumitec fixture is designed with a clear understanding of its application and environment, ensuring superior performance where it matters most. Backed by our world-class engineering team and state-of-the-art R&D facility, Lumitec delivers groundbreaking innovation, unmatched reliability, and uncompromising quality.

CONTACT INFORMATION:

Sales:

Tel. 561.272.9840

Fax. 561.272.9839

Email. sales@lumiteclighting.com

Address:

Lumitec

1055 SW 15th Avenue, Suite 7

Delray Beach, Florida 33444

TABLE OF CONTENTS:

Digital Lighting Control	02
- Control Modules	03
Flood and Specialty Lighting	04
- Flood Lights	05
Down Lighting	08
- Illusion Down Light	09
- Down Lights	10
- Dome Lights	13
Courtesy & Accent Lighting	14
- Courtesy Lights	15
Linear Lighting	17
- Flex Lights	18
Utility Lighting	20
- Engine Room Lights	21
- Positionable Lights	22
- Utility lights	23
Underwater Lighting	24
- Underwater Lights	25
- Wet Space Lights	29
Navigation Lighting	30
- Anchor/Masthead Lights	31
- Navigation Lights	32
Dock & Deck Lighting Systems	34
- Below Water Lights	35
- Above Water Lights	36
Customer Support/Warranty	37



lumiteclighting.com

Digital Lighting Control

Lumitec's Poco Digital Lighting Control is a powerful and cost-effective onboard solution that puts lighting control at your fingertips. Designed for simplicity, it enables seamless touch control of Lumitec PLI-enabled lights through a compatible MFD or a connected smart device, all managed by a compact, easy-to-install control module.

The system is fully expandable with the addition of the Pico Modules, delivering the same advanced, sophisticated lighting control once reserved exclusively for high-end yachts.





Poco 4 Module
3.5" W X 5.5" H X 1.25" D

Poco™ Digital Control Module

Poco Digital Lighting Control delivers powerful, low-cost, on-board lighting control through a compatible MFD or connected smart device in a simple, easy-to-install control module.

Poco 4 is the latest iteration of the award-winning Poco system and introduces new innovative features such as intelligent sound-to-light, NMEA 2000 compatibility, and CAN bus integration. When installed with Lumitec's PLI-enabled lights, even more functionality is unleashed – precise control over color selection and intensity, custom lighting scene creation with interactive sound-to-light, and the ability to add 'virtual circuits' on a single channel, allowing aftermarket installers to add lights and improve on-board lighting designs without adding any additional wire runs.

Poco Digital Lighting Control Module

SKU	Description	Channels	Voltage	Max Amps
101925	Poco 4 Digital Lighting Control Module	4	10-30vDC	10A/ch

The Poco Digital Control Module can be controlled through a compatible MFD or connected smart device (not included).



Applies to Poco and
all Pico Modules

Pico Modules (S8 & C4)
2" W X 2.75" H X 0.5" D



Pico S8

Pico C4

Pico C4-MAX
3.1" W X 3.5" H X 0.88" D



Pico C4 Max

Inline Fuse
Included

Pico Module (OHM)
1.5" W X 1.35" H X 0.3" D



Pico OHM

Sold in
packs of 4

Pico™ Expansion Modules

Pico Expansion Modules are designed to expand the capabilities of the already powerful Poco Digital Lighting Control system. There are currently four modules available.

Pico C4 - Provides TTP functionality or Poco control of third-party RGB or RGBW lighting accessories such as lighted speakers and LED boat lettering. Max load of 2.5A.

Pico C4-MAX - Similar function to the standard C4 (above) but with higher output and incorporates a low current signal wire control to reduce the load on the Poco channels. Max load of 10A.

Pico S8 - Provides the ability to assign Poco virtual switch commands to mechanical switches (8 max). Physical switch will activate the virtual switch command through the Poco module.

Pico OHM - Provides efficient Poco-only control of third-party RGB lighting accessories (no TTP). Connects in-line at RGB accessory, max load of 400mA. Sold in packs of four (4) modules.

SKU	Description	Voltage	Max Amps
101609	Pico C4 Module	10-30vDC	2.5A
101873	Pico C4-MAX Module	10-30vDC	10A
101684	Pico S8 Module	10-30vDC	100mA
101829	Pico OHM Module (4 pack)	10-16vDC	400mA

Flood & Specialty Lighting

Lumitec delivers an unmatched range of flood lighting solutions, from versatile, positionable spreader lights to sleek, compact deck lights and powerful commercial-grade work lights. Designed to withstand the harshest marine environments, every light is engineered for superior durability and performance.

Illusion Spreader

4.50" W X 1.81" H X 1.08"D
Mounting Hole Size: 4.00" W X 1.25" H

NEW



Illusion™ Spreader Light

The all-new Illusion Spreader Light expands the Illusion Series with a sleek, ultra-thin flush mount design and durable cast aluminum housing. Delivering 1,200 lumens with full-color or single-color output, it's available in white, black, or mirrored finishes. IP67 rated the Illusion Spreader Lights delivers a perfect blend of style and performance.



Lumen Output



Third Party Dimmer



Color Match Commitment



IP Rated



2-Wire Hookup



5 Year Warranty

SKU	FINISH	COLOR	OUTPUT	CRI*	CCT*	VOLTAGE	12VDC	24VDC	LUMENS†
Illusion Spreader Light									
117223	White	Cool White	Non-Dimming	70+	5000	10-30vDC	1A	0.5A	1200
117253	Black	Cool White	Non-Dimming	70+	5000	10-30vDC	1A	0.5A	1200
117243	Mirror	Cool White	Non-Dimming	70+	5000	10-30vDC	1A	0.5A	1200
117227	White	Cool White	Spectrum (PLI)	70+	5000	10-30vDC	1A	0.5A	1200
117257	Black	Cool White	Spectrum (PLI)	70+	5000	10-30vDC	1A	0.5A	1200
117247	Mirror	Cool White	Spectrum (PLI)	70+	5000	10-30vDC	1A	0.5A	1200

Capri Retrofit Kit Available

CapriLT
4.94" W X 1.75" H X 1.57"D
Mounting Hole Size: 3.96" W X 1.36" H



Capri2
4.94" W X 1.75" H X 1.57"D
Mounting Hole Size: 3.96" W X 1.36" H



Caprera3
3.79" W X 1.10" H X 2.49" D



Capri3
4.08" W X 1.39" H X 1.43"D
Mounting Hole Size: 3.86" W X 1.24" H



Available with black housing



CapriLT/2

The CapriLT and Capri2 flush mount spreader lights have been the benchmark for OEM manufacturers for many years, offering exceptional reliability and performance. The single color LT is the perfect cost-effective solution, with fewer features yet solid and dependable. In contrast, the feature-rich dual-color Capri2 option offers Poco system compatibility, either red or blue second color, and is dimmable. Compatible with PWM** LED dimmers. IP67 compliant.

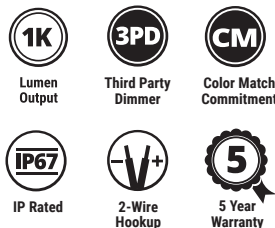

SKU	FINISH	COLOR OUTPUT	CRI*	CCT*	VOLTAGE	12VDC	24VDC	LUMENS†
Capri LT								
101288	White	White Non-Dimming	70+	5000	10-30vDC	1.3A	600mA	1000
101289	Black	White Non-Dimming	70+	5000	10-30vDC	1.3A	600mA	1000
Capri 2								
101099	White	White Dimming, Blue Dimming (PLI)	70+	5000	10-30vDC	1.3A	600mA	1000
101100	White	White Dimming, Red Dimming (PLI)	70+	5000	10-30vDC	1.3A	600mA	1000
101186	Black	White Dimming, Blue Dimming (PLI)	70+	5000	10-30vDC	1.3A	600mA	1000
101187	Black	White Dimming, Red Dimming (PLI)	70+	5000	10-30vDC	1.3A	600mA	1000

** Pulse Width Modulation (PWM)
* Lumens, CRI & CCT applies only to white light.
W=Width, H=Height, D=Depth, Dia=Diameter
† Integrating sphere measured lumens within 1 minute of initial startup

Capri3/Caprera3

The Capri3/Caprera3 builds on the huge success of the Capri/Caprera line of spreader lights. Designed with a 1,200 lumen output, a smaller, more thermally efficient powder-coated die-cast aluminum housing with improved optical beam pattern and no exposed fasteners (on flush mount lights). But the innovation doesn't stop there; Capri3 has our innovative easy fit butterfly clip mounting system to greatly simplify the installation process. IP67 compliant, and PLI enabled (Poco compatible) on most models.

HOUSING	COLOR OUTPUT	CRI*	CCT*	VOLTAGE	12VDC	24VDC	LUMENS†
Capri3							
White	Black						
101720	101725	RGBW Spectrum	70+	5000	10-30vDC	1A	0.5A 1200
101721	101726	White Dimming, Blue Dimming	70+	5000	10-30vDC	1A	0.5A 1200
101722	101727	White Dimming, Red Dimming	70+	5000	10-30vDC	1A	0.5A 1200
101723	101728	White Non-Dimming	70+	5000	10-30vDC	1A	0.5A 1200
101724	101729	White Dimming	70+	5000	10-30vDC	1A	0.5A 1200
Caprera3							
White	Black						
101710	101715	RGBW Spectrum	70+	5000	10-30vDC	1A	0.5A 1200
101711	101716	White Dimming, Blue Dimming	70+	5000	10-30vDC	1A	0.5A 1200
101712	101717	White Dimming, Red Dimming	70+	5000	10-30vDC	1A	0.5A 1200
101713	101718	White Non-Dimming	70+	5000	10-30vDC	1A	0.5A 1200
101714	101719	White Dimming	70+	5000	10-30vDC	1A	0.5A 1200

6,000+
Lumens

Trunnion Mount
7.13" W X 3.15" H X 2.6" D



Available with black housing

Flush Mount
8.3" W X 2.72" H X 2.5" D
Mounting Hole Size: 7.2" W X 2.44" H

Flush Mount
9.6" W X 6.6" H X 3.1" D
Mounting Hole Size: 8.2" W X 5.7" H

12,000+
Lumens



Available with black housing

Trunnion Mount
8" W X 6" H X 3.32" D

Maxillume h60

From the world's top custom yacht builders to the US Coast Guard, customers with high expectations rely on the Maxillume h60 flood light. Packing more than 6,000 TRUE lumens* (dimmmable), the h60 is available with two mounting options and our tried and tested internal dimmer control. Each light is completely water-sealed (IP67 compliant) and rigorously tested for shock and vibration. The h60 is PLI enabled (Poco compatible) and has a 3-wire configuration (additional orange signal wire).



SKU	FINISH	COLOR OUTPUT	CRI*	CCT*	VOLTAGE	12VDC	24VDC	LUMENS†
Trunnion Mount								
101334	White	White Dimming	70+	5000	10-30vDC	5A	2.5A	6000
101335	Black	White Dimming	70+	5000	10-30vDC	5A	2.5A	6000
Flush Mount								
101336	White	White Dimming	70+	5000	10-30vDC	5A	2.5A	6000

Maxillume h120

The Maxillume h120 has set the standard in DC-powered deck/work lights. Delivering more than 12,000 TRUE lumens* (dimmmable) and housed in a heavy-duty, powder-coated, die-cast aluminum housing. The polished 316 Stainless Steel bracket on the trunnion mount version offers maximum flexibility for positioning and will ensure the light stays put through rigorous vibration and shock. The h120 is PLI enabled (Poco compatible) and has a 3-wire configuration (additional orange signal wire).

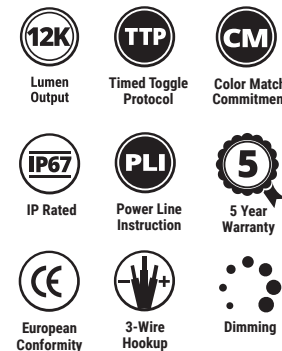

SKU	FINISH	COLOR OUTPUT	CRI*	CCT*	VOLTAGE	12VDC	24VDC	LUMENS†
Trunnion Mount								
101346	White	White Dimming	70+	5000	10-30vDC	10A	5A	12,000
101347	Black	White Dimming	70+	5000	10-30vDC	10A	5A	12,000
Flush Mount								
101348	White	White Dimming	70+	5000	10-30vDC	10A	5A	12,000

* Lumens, CRI & CCT applies only to white light.

W=Width, H=Height, D=Depth, Dia=Diameter

† Integrating sphere measured lumens within 1 minute of initial startup

Semi-Recessed
17.25" W X 9.12" H X 1.5" D
Mounting Hole Size: 15.5" W X 7.25" H

Surface Mount
13.7" W X 5.1" H X 2.36" D

Trunnion Mount
13.7" W X 7.8" H X 3.76" D

20,000+
Lumens

Maxillume tr150

Rugged, reliable, with 20,000 TRUE lumens[†] - the Maxillume tr150 will change how you work at night. Rock solid reliability and a durable powder-coated, die-cast aluminum construction, guarantees light when you need it. Your crew will be safer, faster, more effective, and more productive. Completely sealed to IP67 standards and tested to military specifications for shock and vibration. The Maxillume tr150 is the new standard for 200W LED spot/flood lighting.



Lumen Output



Timed Toggle Protocol



Color Match Commitment



IP Rated



5 Year Warranty



European Conformity



2-Wire Hookup

SKU	MOUNT	BEAM	VOLTAGE	CRI*	CCT*	12VDC	24VDC	LUMENS [†]
101413	Trunnion	Flood	10-36vDC	70+	5000	17.5A	8.75A	20,000
101414	Recessed	Flood	10-36vDC	70+	5000	17.5A	8.75A	20,000
101415	Surface	Flood	10-36vDC	70+	5000	17.5A	8.75A	20,000

* Lumens, CRI & CCT applies only to white light.

W=Width, H=Height, D=Depth, Dia=Diameter

† Integrating sphere measured lumens within 1 minute of initial startup

10,000+
Lumens

Flood

Available with spot or flood beam pattern.

Spot

Available with black housing

18" W X 1.5" H X 3.5" D

Razor™ Light Bar

Sleek, streamlined, and powerful, Razor is specifically designed for marine applications. PLI enabled (Poco compatible) with a 3-wire configuration, the Razor Light Bar is designed to be easily integrated into most existing hardtop, arch, and pilothouse designs, or it can surface-mount directly to unmodified hardtop surfaces for an equally clean look. But don't let the small footprint fool you; Razor packs a punch with over 10,000 night-piercing lumens of dimmable light. Available in two beam patterns, spot, or flood with a choice of a white or black finish.



Lumen Output



Timed Toggle Protocol



Color Match Commitment



Power Line Instruction



IP Rated



5 Year Warranty



European Conformity



3-Wire Hookup



Dimming

SKU	FINISH	BEAM	VOLTAGE	CRI*	CCT*	12VDC	24VDC	LUMENS [†]
101586	White (Dimming)	Flood	10-30vDC	70+	5000	9A	4.2A	10,000
101587	White (Dimming)	Spot	10-30vDC	70+	5000	9A	4.2A	10,000
101588	Black (Dimming)	Flood	10-30vDC	70+	5000	9A	4.2A	10,000
101589	Black (Dimming)	Spot	10-30vDC	70+	5000	9A	4.2A	10,000

Inverted Logo Part Numbers

101590	White (Dimming)	Flood	10-30vDC	70+	5000	9A	4.2A	10,000
101603	White (Dimming)	Spot	10-30vDC	70+	5000	9A	4.2A	10,000
101912	Black (Dimming)	Flood	10-30vDC	70+	5000	9A	4.2A	10,000

Down Lighting

Delivering incredible output with profiles that are among the slimmest in the industry, Lumitec's Down Lights remain the best-performing products in the category. IP67 rated and completely sealed, making them perfectly suited for a variety of indoor or outdoor overhead lighting needs. Enhance textures and surfaces with output options that include architectural-grade High CRI warm white and full-color RGBW Spectrum, offering nearly infinite output color possibilities.





Much lower profile than competitor down lights.



Seamless flush mount design.

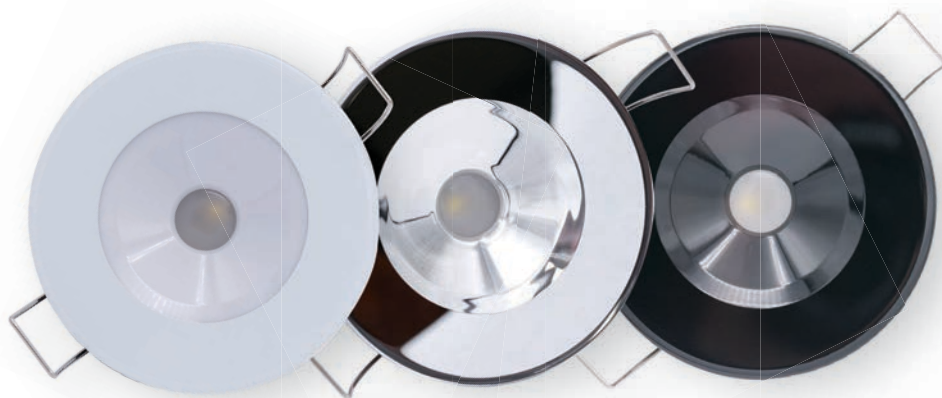

White

Mirror

Black

Illusion™ Down Light

Sleek and stylish, the Illusion Down Light features an ultra-thin, bezel-free design that creates a seamless flush-mount installation on hardtops, arches, and salon ceilings. Its chemically hardened, wafer-thin glass and reduced mounting depth - shorter than the Mirage - combine with the convenient butterfly clip system eliminate exposed fasteners for a clean sophisticated look.

As part of the Illusion Series, this Down Light is fully compatible with Poco 4 and color output options include warm white/spectrum, cool white/spectrum, and single-color warm or cool white. IP67 compliant.



White/White Window	White/Mirror Window	Mirror/Mirror Window	Black/Black Window	Black/Mirror Window	COLOR OUTPUT	CRI*	CCT*	VOLTAGE	12VDC	24VDC	LUMENS†
117123	117133	117143	117153	117163	White Non-Dimming	80+	5000	10-30vDC	360mA	180mA	115-140
117129	117139	117149	117159	117169	Warm White Dimming	90+	3000	10-30vDC	480mA	260mA	200-245
117127	117137	117147	117157	117167	Cool White RGBW Spectrum	80+	5000	10-30vDC	430mA	230mA	250-310
117125	117135	117145	117155	117165	Warm White RGBW Spectrum	90+	3000	10-30vDC	430mA	230mA	250-310

* Lumens, CRI & CCT applies only to white light. W=Width, H=Height, D=Depth, Dia=Diameter

**Only 6 watt lights, have output greater than a 20 watt halogen in white mode

† Integrating sphere measured lumens within 1 minute of initial startup

NOTE: Custom finishes are available with a minimum purchase required.

3.25" Dia. X 1" D



Polished



White

2.5" Dia. X 1" D

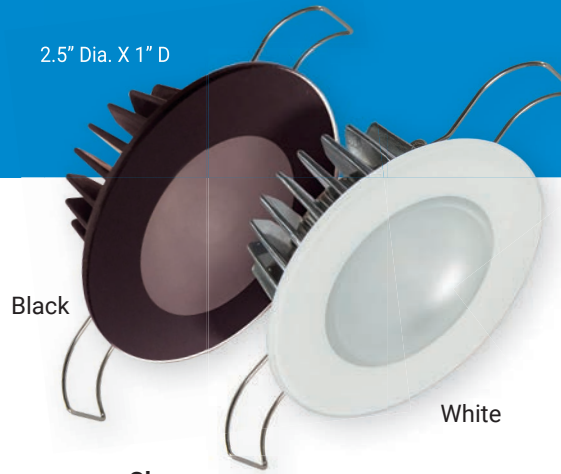

Black

White

Glass

3.5" Dia. X 1" D @ 0°, 2" D @ 33.5°
Mounting Hole Size: 2.875" Dia.



POSITIONABLE MIRAGE

MIRAGE

Mirage/Positionable Mirage/Square Mirage Flush Mount Down Lights

The Mirage Down Light series remains the best-performing down lights in the category. Delivering incredible output and a profile that is among the slimmest in the industry. Completely sealed and IP67 rated, it is perfectly suited for a variety of indoor or outdoor overhead lighting needs. Output options include architectural-grade High CRI warm white, white/blue/red multi-color, and RGBW Spectrum, offering nearly infinite output color possibilities.

The Mirage series includes positionable (gimbal) and square models. The Positionable Mirage offers up to 30 degrees of pivot for wall wash, art lighting, and other dramatic lighting effects. The Square Mirage blends harmoniously with today's more contemporary and forward-thinking designs. All boast Mirage's industry-leading output, features, and contemporary good looks.

Mirage Features:

- 
TTP
 Timed Toggle Protocol
- 
3PD
 Third Party Dimmer
- 
CM
 Color Match Commitment
- 
PLI
 Power Line Instruction
- 
IP67
 IP Rated
- 
CE
 European Conformity
- 
5
 5 Year Warranty
- 
-V+
 2-Wire Hookup
- 
Color Change
- 
Dimming
- 
Color Cycle
- 
RGBW Full-Color

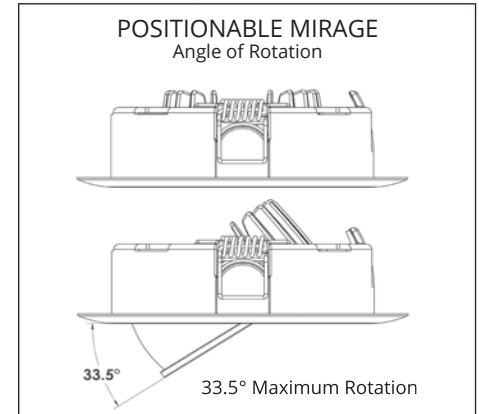

3.45" W X 3.45" H X 1" D



Polished

3.45" W X 3.45" H X 1" D



White

2.63" W X 2.63" H X 1" D



Glass

SQUARE MIRAGE

Available in 6 watt outputs or 3 watt "white non-dimming"

SKU: White	Black Glass	White Glass	Polished	COLOR OUTPUT	CRI*	CCT*	VOLTAGE	12VDC	24VDC	LUMENS†
MIRAGE										
113120	N/A	113190	113110	White Non-Dimming, Red Non-Dimming, Blue Non-Dimming, Purple Non-Dimming	80+	5000	10-30vDC	430mA	230mA	380
113123	113153	113193	113113	White (Dimming 3PD Only)	80+	5000	10-30vDC	360mA	180mA	172
113128	N/A	113198	113118	White Dimming, Red Non-Dimming, Blue Non-Dimming	80+	5000	10-30vDC	430mA	230mA	380
113129	N/A	113199	113119	Warm White Dimming (Hi CRI)	90+	3000	10-30vDC	480mA	260mA	300
113127	113157	113197	113117	RGBW Spectrum	80+	5000	10-30vDC	430mA	230mA	380
SQUARE MIRAGE										
116129	N/A	116199	116119	Warm White Dimming (Hi CRI)	90+	3000	10-30vDC	480mA	260mA	300
116127	N/A	116197	116117	RGBW Spectrum	80+	5000	10-30vDC	430mA	230mA	380
POSITIONABLE MIRAGE										
115129	N/A	N/A	115119	Warm White Dimming (Hi CRI)	90+	3000	10-30vDC	480mA	260mA	300
115127	N/A	N/A	115117	RGBW Spectrum	80+	5000	10-30vDC	430mA	230mA	380

* Lumens, CRI & CCT applies only to white light. W=Width, H=Height, D=Depth, Dia=Diameter

**Only 6 watt lights, have output greater than a 20 watt halogen in white mode

† Integrating sphere measured lumens within 1 minute of initial startup

2" Dia. X 0.75" D
Mounting Hole Size: 1.25" Dia.



Brushed



White

2" Dia. X 0.75" D
Mounting Hole Size: 1.25" Dia.



Brushed

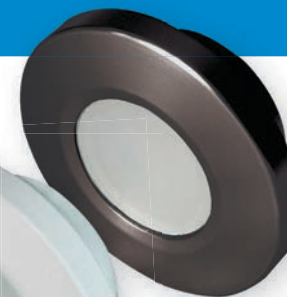

Black



White

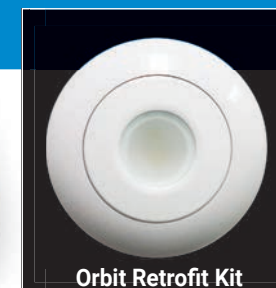

Orbit Retrofit Kit

SKU# 101073

Halo

Class-leading output, weatherproof construction, and one of the simplest installations in the industry. With a shallow-depth profile (less than 1/2" mounting depth) and a secure composite mounting system, Halo lights are ideal for a variety of indoor and outdoor uses. Intelligent circuitry enables advanced features like dimming and multi-color control without external control modules, specialized switches, or additional wire runs. Completely sealed and IP67 compliant.

Halo/Orbit
Features:



Timed Toggle
Protocol



Third Party
Dimmer



Color Match
Commitment



Power Line
Instruction



IP Rated



European
Conformity



5 Year
Warranty



2-Wire
Hookup



Color Change



Dimming



RGBW
Full-Color

Only available in 3 watt outputs

HALO

ORBIT

Brushed	White	Brushed	White	Black	COLOR OUTPUT	CRI*	CCT*	VOLTAGE	12VDC	24VDC	LUMENS†
112800	112820	112500	112520	N/A	White Non-Dimming, Red Non-Dimming, Blue Non-Dimming, Purple Non-Dimming	80+	5000	10-30vDC	430mA	230mA	340
112803	112823	112503	112523	112553	White (Dimming 3PD Only)	80+	5000	10-30vDC	360mA	180mA	160
112808	112828	112508	112528	N/A	White Dimming, Red Non-Dimming, Blue Non-Dimming	80+	5000	10-30vDC	430mA	230mA	340
112809	112829	112509	112529	N/A	Warm White Dimming (Hi CRI)	90+	3000	10-30vDC	480mA	260mA	250
112807	112827	112507	112527	112557	RGBW Spectrum	80+	5000	10-30vDC	430mA	230mA	340

Orbit Down Lights stand apart from the crowd with a stylish look, shallow-depth profile (less than 1/2" mounting depth) and a secure composite mounting system. The lights are ideal for a variety of indoor and outdoor uses (IP67 compliant) and include dimming and multi-color control without external control modules.

The Orbit Retrofit Kit covers oversized holes (1.875" to 2.750") from old style halogen lights. The ingenious clamp-in design has no exposed fasteners for a clean look inside and out.



* Lumens, CRI & CCT applies only to white light.

W=Width, H=Height, D=Depth, Dia=Diameter

† Integrating sphere measured lumens within 1 minute of initial startup



Stainless Steel

6.75" Dia X 1.13" D



Stainless Steel

White

4.0" Dia X 0.73" D

Touch Dome

Brilliant, innovative with a completely sealed design and no O-rings, baffles, or switches to wear out. Touch Dome promises reliable "touch" operation even when wet or wearing gloves. The proprietary Optical Field Sense technology provides on/off, color change, and even dimming. Ideal for switch free locations like galleys and heads. Touch Dome is beautifully designed and elegantly functional.

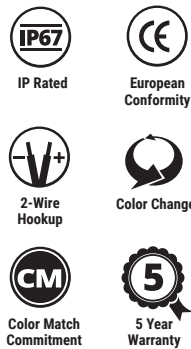

Touch Dome

SKU	FINISH	COLOR OUTPUT	CRI*	CCT*	VOLTAGE	12VDC	24VDC	LUMENS†
101097	Stainless Steel	White Dimming, Blue Dimming	70+	5000	10-30VDC	410mA	215mA	244
101098	Stainless Steel	White Dimming, Red Dimming	70+	5000	10-30VDC	410mA	215mA	244

Aurora Surface Mount Dome Light

The high-quality Aurora Surface Mount Dome Light stands apart from other LED replacements for ubiquitous dome lights. Bright, with wide even light, a clean look, and a reliable, intuitive built-in switch. Aurora offers dual-color output options with dimming, IP67 immersion protection, and a notable level of superior quality. It's no surprise that Aurora is a top seller with our OEM customers.



Aurora Surface Mount

SKU	FINISH	COLOR OUTPUT	CRI*	CCT*	VOLTAGE	12VDC	24VDC	LUMENS†
101138	Stainless Steel	White Dimming, Blue Dimming	70+	5000	10-30VDC	330mA	210mA	180
101139	Stainless Steel	White Dimming, Red Dimming	70+	5000	10-30VDC	330mA	210mA	180
101075	White	White Dimming, Blue Dimming	70+	5000	10-30VDC	330mA	210mA	180
101076	White	White Dimming, Red Dimming	70+	5000	10-30VDC	330mA	210mA	180

* Lumens, CRI & CCT applies only to white light.

W=Width, H=Height, D=Depth, Dia=Diameter

† Integrating sphere measured lumens within 1 minute of initial startup



Courtesy & Accent Lighting

Engineered for reliability and performance, Lumitec Courtesy Lighting has become the benchmark for marine accent lighting. Available in single-color or full-color output, with surface or flush mount configurations and multiple housing finishes, our lights are designed to deliver dependable, versatile solutions for any installation.





2" W. X 1" H X 0.43" D



Also available with white or black housing



Direct Beam Pattern



Indirect Beam Pattern

Fiji Full-Color Courtesy Light

Fiji brings style and versatility to your onboard lighting. This full-color, 2-wire courtesy light works seamlessly with a Poco module (required), giving you unlimited color options at your fingertips. Its compact design features no exposed fasteners and a sleek, contemporary look, while offering the flexibility of direct or indirect beam patterns. Available in white, black, or stainless-steel finishes, Fiji is IP67 rated for reliable performance in any marine environment.

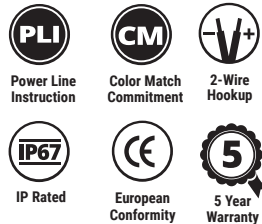

Note: Sold in packs of four (4) lights.

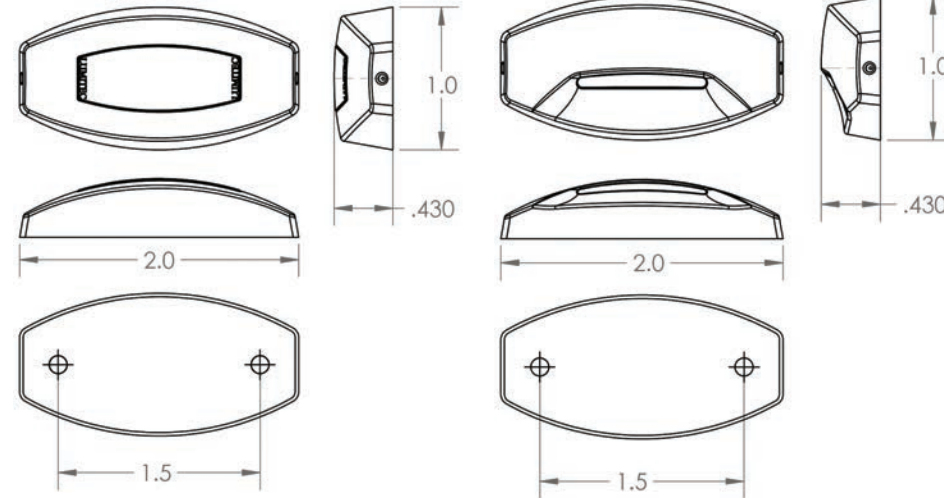

Poco Module Required:
Important: The Fiji courtesy light is required to be connected to a Poco Module for color control (no TTP available).

SKU	QUANTITY	FINISH	COLOR OUTPUT	CRI*	CCT*	VOLTAGE	12VDC	LUMENS†
101756	4 per pack	Polished	RGBW Spectrum Direct	70+	5000	10-16vDC	33mA	26
101763	4 per pack	White	RGBW Spectrum Direct	70+	5000	10-16vDC	33mA	26
101758	4 per pack	Black	RGBW Spectrum Direct	70+	5000	10-16vDC	33mA	26
101753	4 per pack	Polished	RGBW Spectrum Indirect	70+	5000	10-16vDC	33mA	5
101754	4 per pack	White	RGBW Spectrum Indirect	70+	5000	10-16vDC	33mA	5
101755	4 per pack	Black	RGBW Spectrum Indirect	70+	5000	10-16vDC	33mA	5

* Lumens, CRI & CCT applies only to white light.

† Integrating sphere measured lumens within 1 minute of initial startup

* Lumens, CRI & CCT applies only to white light.

† Integrating sphere measured lumens within 1 minute of initial startup



Echo

1.24" Dia. X 0.75" D
Mounting Hole Size: 0.6875" Dia. (11/16)



Andros

1.0" W X 1.0" H X 0.50" D



Exuma

0.98" Dia. X 0.44" D



Aruba

0.93" Dia. X 0.50" D
Mounting Hole Size: 0.6875" Dia. (11/16)



Barbados

1.81" W X 1.15" H X 0.53" D

Courtesy & Accent Lights

Small, attractive, and discreet, Lumitec accent lights offer more light output than many "full-size" overhead lights. All measure about 1" in diameter or less. Echo is clean, almost flush, and easy to install. Andros and Aruba offer a wide, bright indirect beam. Exuma and Barbados are surface mount and fit almost anywhere. All are suitable for interior or exterior courtesy and accent lighting needs. Fully sealed, IP67 compliant. Not compatible with Poco module or 24 vDC systems.



Third Party Dimmer



Color Match Commitment



5 Year Warranty



IP Rated



European Conformity



2-Wire Hookup

TECHNICAL SPECIFICATIONS FOR ALL MODELS

Voltage	10-16vDC
12vDC	45mA
CRI	70+ (White Only)
CCT.....	5000 (White Only)
CCT.....	3000 (Warm White)
Lumens [†]	45 (White Only)

	ECHO			ANDROS		EXUMA		ARUBA	BARBADOS
COLOR OUTPUT	BRUSHED	WHITE	BLACK	POLISHED SS	WHITE	POLISHED SS	WHITE	STAINLESS	BLACK
White Light	112203	112223	112253	101043	101046	101049	101052	101144	101059
Blue Light	112204	112224	112254	101044	101047	101050	101053	101145	101060
Red Light	112205	112225	112255	101045	101048	101051	101054	101146	101061
Warm White	101227	101228	N/A	101223	101224	101225	101226	101230	NA

* Lumens, CRI & CCT applies only to white light.

W=Width, H=Height, D=Depth, Dia=Diameter

† Integrating sphere measured lumens within 1 minute of initial startup

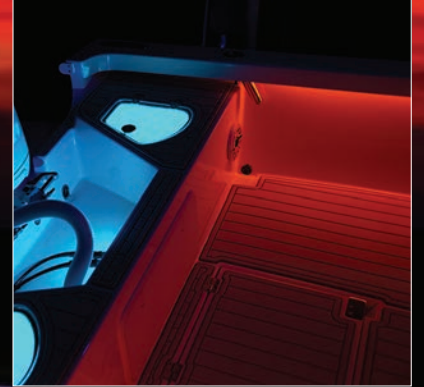
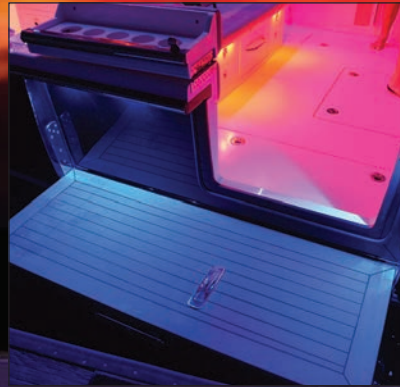

Introducing a New Direction in Linear Lighting



Lumitec has reimagined linear lighting with unmatched versatility and customization. With ultra-high LED density, our fixtures provide flawless light uniformity - no dots, no gaps, just smooth, continuous brilliance in some of the industry's thinnest profiles.

Engineered for premium applications, Lumitec's linear lights shine where clean, direct-view lighting is essential. With up to 900 LEDs per meter, they deliver consistent, even lighting with multiple mounting options and the flexibility to adapt to any installation.

Available in 12V or 24V, choose from single-color blue or white (3000K or 5000K), or elevate your design with RGB or RGBW outputs using 4- or 5-wire control. Standard lengths extend to 5 meters, with custom options available upon request*.

Unmatched versatility. Uncompromising quality. Linear lighting - redefined.

**Based on order volume.*

Contact your sales representative for more information.



Hydra Series

Slim, flexible and versatile with three width options available to start. The Hydra Series will go where Moray cannot. Ideal for direct view and more challenging application locations. Hydra is not PLI or TTP compatible and requires a Pico C4 module for integration into the Poco system.

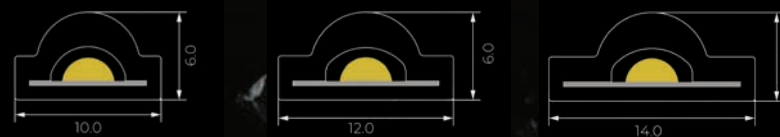

Hydra Series Profile Cross Section

Conger Series

The Conger Series will be available in two profiles for launch with a top and side emitter option. More conventional in appearance and like Hydra will be available with a selection of color, power and control options. Conger is also not PLI or TTP compatible and requires a Pico C4 module for integration into the Poco system.

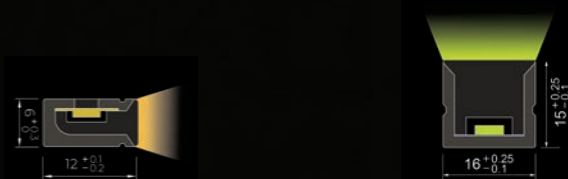

Conger Series Profile Cross Section

Light Surface



Moray Flex Light - With Integrated Lighting Controller

The Moray Flex Light is the only RGBW marine flex light to have an internal color output controller. This means that Moray can be connected directly to a 2-wire DC electrical system, allowing for color and dimming control with any standard on/off switch, with no external driver required. PLI enabled, Moray is also compatible with our Poco Digital Lighting Control system for advanced color control through an onboard MFD or smart device via a connected Poco module. Available in eight convenient sizes, Moray is a versatile and reliable flex light solution that will reduce wiring cost, time, and complexity.

White	Length	COLOR OUTPUT	CRI*	CCT*	VOLTAGE	12VDC	24VDC	LUMENS†
101647	1.5'	RGBW Spectrum	80+	5000	10-16vDC	312mA	N/A	113
101640	3'	RGBW Spectrum	80+	5000	10-16vDC	625mA	N/A	225
101648	4.5'	RGBW Spectrum	80+	5000	10-16vDC	938mA	N/A	338
101641	6'	RGBW Spectrum	80+	5000	10-16vDC	1.25A	N/A	450
101649	7.5'	RGBW Spectrum	80+	5000	10-16vDC	1.56A	N/A	563
101642	9'	RGBW Spectrum	80+	5000	10-16vDC	1.88A	N/A	675
101650	10.5'	RGBW Spectrum	80+	5000	10-16vDC	2.19A	N/A	788
101643	12'	RGBW Spectrum	80+	5000	10-16vDC	2.5A	N/A	900

* Lumens, CRI & CCT applies only to white light.

† Integrating sphere measured lumens within 1 minute of initial startup.

Utility Lighting

Utility lights may be the unsung heroes of the lighting world, but their impact is undeniable. Lumitec's versatile lineup - from engine room and compartment lights to full-color under-gunwale lighting - delivers essential functionality while seamlessly enhancing any lighting setup.





9"W x 2"H x 1" D



1.73" Dia. X 0.44" D



NevisLT

Nevis2
5.0" W X 2.5" H X 0.63" D

Ibiza Engine Room Light

Delivering 1,000 integrating-sphere-measured lumens and dual-color output options, Ibiza is as beautiful as it is brilliant. Designed for the harsh environment of the engine room with a nearly perfect 180-degree beam pattern to illuminate even the darkest corners. Ignition protected, IP67 compliant, completely sealed, and compatible with most PWM** LED dimmers.

Anywhere Light

Where can you use a light that is attractive, bright, small, completely sealed, and withstands the elements yet blends with well-appointed interiors? Well, anywhere! The Anywhere Light is surface mountable and constructed with a quality aluminum housing that is completely water sealed to withstand the elements (IP67 compliant).

Nevis2/NevisLT Engine Room Light

With more than 1,000 TRUE lumens (integrating sphere tested†), the Nevis2 and NevisLT illuminates hard-to-light areas with a 180-degree spread of bright, even light. Available in white/red or white/blue and certified as ignition protected, Nevis is completely sealed, IP67 compliant and compatible with most PWM** LED dimmers. Nevis - still the original and still the best!

Ibiza Engine Room Light

SKU	FINISH	COLOR OUTPUT	CRI*	CCT*	VOLTAGE	12VDC	24VDC	LUMENS†
101520	White	White Non-Dimming	70+	5000	10-30vDC	1.3A	600mA	1000
101521	White	White Dimming, Red Dimming (PLI)	70+	5000	10-30vDC	1.3A	600mA	1000
101522	White	White Dimming, Blue Dimming (PLI)	70+	5000	10-30vDC	1.3A	600mA	1000

Anywhere Light

SKU	FINISH	COLOR OUTPUT	CRI*	CCT*	VOLTAGE	12VDC	24VDC	LUMENS†
101033	Brushed	White Non-Dimming	70+	5000	10-30vDC	360mA	180mA	150
101034	Brushed	Blue Non-Dimming	NA	NA	10-30vDC	360mA	180mA	NA
101035	Brushed	Red Non-Dimming	NA	NA	10-30vDC	160mA	100mA	NA
101037	Brushed	RGBW Spectrum (PLI)	80+	5000	10-30vDC	430mA	230mA	320

Nevis Engine Room Light

SKU	COLOR OUTPUT	CRI*	CCT*	VOLTAGE	12VDC	24VDC	LUMENS†
Nevis2							
101147	White Dimming, Blue Dimming (PLI)	70+	5000	10-30vDC	1.3A	600mA	1000
101148	White Dimming, Red Dimming (PLI)	70+	5000	10-30vDC	1.3A	600mA	1000
NevisLT							
101296	White Non-Dimming	70+	5000	10-30vDC	1.3A	600mA	1000



2-Wire Hookup



IP Rated



Ignition Protected



European Conformity



5 Year Warranty

* Lumens, CRI & CCT applies only to white light.

** Pulse Width Modulation (PWM)

† Integrating sphere measured lumens within 1 minute of initial startup



Brushed
2.4" Dia X 3" D
Mounting Hole Size: 0.375" Dia.

White



2.75" Dia. X 2" D

Available with white
or black base

GAI2 Heavy Duty Base

The General Area Illumination (GAI) light is a versatile light in an elegant package. Fully positionable and available in various finishes and outputs, the GAI is perfect as a reading light, task light, or chart light in a navigation station. Fully sealed and IP67 compliant, the GAI makes for a great exterior deck light.



RGBW
Full-Color



IP Rated



European
Conformity



Power Line
Instruction



5 Year
Warranty



Timed Toggle
Protocol

GAI2 Heavy Duty Base

SKU	FINISH	COLOR OUTPUT	CRI*	CCT*	VOLTAGE	12VDC	24VDC	LUMENS†
111801	Brushed	Warm White Dimming (Hi CRI)	90+	3000	10-30vDC	480mA	260mA	250
111800	Brushed	White Dimming, Red Non-Dimming, Blue Non-Dimming	80+	5000	10-30vDC	430mA	230mA	340
111830	Brushed	RGBW Spectrum	80+	5000	10-30vDC	480mA	230mA	340
111803	White	Warm White Dimming (Hi CRI)	90+	3000	10-30vDC	480mA	260mA	250
111802	White	White Dimming, Red Non-Dimming, Blue Non-Dimming	80+	5000	10-30vDC	430mA	230mA	340
111831	White	RGBW Spectrum	80+	5000	10-30vDC	430mA	230mA	340

Zephyr Spreader/Deck Light

The Zephyr spreader light is equally well suited to lighting the fore-deck of an elegant sloop or the cockpit of a sport yacht. Mounted on spreaders, spars, radar arches or towers, and fly-bridges at a mounting height of 16 feet, this spreader light brightly illuminates an area nearly 24 feet in diameter with more than 1,000 lumens†.



1K
Lumen
Output



IP Rated



European
Conformity



5 Year
Warranty



2-Wire
Hookup

Zephyr Spreader/Deck Light

SKU	FINISH	COLOR OUTPUT	CRI*	CCT*	VOLTAGE	12VDC	24VDC	LUMENS†
101325	Brushed/White	White	70+	5000	10-30vDC	1.3A	600mA	1000
101326	Brushed/Black	White	70+	5000	10-30vDC	1.3A	600mA	1000

* Lumens, CRI & CCT applies only to white light.
W=Width, H=Height, D=Depth, Dia=Diameter

† Integrating sphere measured lumens within 1 minute of initial startup

Available with
Stainless Steel housing



White

6.36" W X 1.75" H X 1.48" D



Rail2
11.72" W X 1.11" H X 0.60" D



Mini Rail2
5.9" W X 1.11" H X 0.60" D



Perimeter Light

The Perimeter Light is versatile, attractive, and powerful. With more than 1,000 true lumens[†] and an optical system designed to spread light very widely and evenly, it is uniquely suited to various specialty applications. An aluminum housing and impact-resistant window means years of trouble-free service, even in the most extreme environments.



1K
Lumen
Output



CE
European
Conformity



IP67
IP Rated



PLI
Power Line
Instruction



TTP
Timed Toggle
Protocol



5
5 Year
Warranty

Rail2 & Mini Rail2

The versatile Rail2 is perfect for interior and covered exterior spaces, featuring a downward-facing design for optimal illumination. Available in 6" and 12" sizes, it offers single-color, multi-color, and full-color options - multi-color models are Poco-compatible. Designed to mount seamlessly to soft top rails, the Rail2 adapts effortlessly to a variety of applications.

SKU	FINISH	COLOR OUTPUT	CRI*	CCT*	VOLTAGE	12VDC	24VDC	LUMENS [†]
Rail2								
101243	Brushed	White Dimming, Red Non-Dimming, Blue Non-Dimming	70+	5000	10-30vDC	880mA	460mA	900
101242	Brushed	Warm White Dimming	80+	3000	10-30vDC	1.3A	600mA	800
101283	Brushed	RGBW Spectrum	70+	5000	10-30vDC	880mA	460mA	900
Mini Rail2								
101078	Brushed	White (Dim 3PD Only, Non PLI)	70+	5000	10-30vDC	360mA	180mA	145
101079	Brushed	Blue (Dim 3PD Only, Non PLI)	NA	NA	10-30vDC	360mA	180mA	NA
101080	Brushed	Red (Dim 3PD Only, Non PLI)	NA	NA	10-30vDC	160mA	100mA	NA
101241	Brushed	Warm White (Dim 3PD Only, Non PLI)	80+	3000	10-30vDC	360mA	180mA	95
101545	Brushed	RGBW Spectrum	70+	5000	10-30vDC	510mA	280mA	300

Perimeter Light

SKU	FINISH	COLOR OUTPUT	CRI*	CCT*	VOLTAGE	12VDC	24VDC	LUMENS [†]
101475	White	White Non-Dimming (Non TTP)	70+	5000	10-30vDC	1.3A	600mA	1000
101476	White	White Dimming, Blue Dimming	70+	5000	10-30vDC	1.3A	600mA	1000
101477	White	White Dimming, Red Dimming	70+	5000	10-30vDC	1.3A	600mA	1000

* Lumens, CRI & CCT applies only to white light.

W=Width, H=Height, D=Depth, Dia=Diameter

† Integrating sphere measured lumens within 1 minute of initial startup

Underwater Lighting

Renowned globally for unmatched performance and reliability, Lumitec's underwater lighting sets the industry benchmark. With a diverse product lineup, a legacy of innovation, and an unwavering commitment to quality, Lumitec continues to lead the way - setting the standard for years to come.

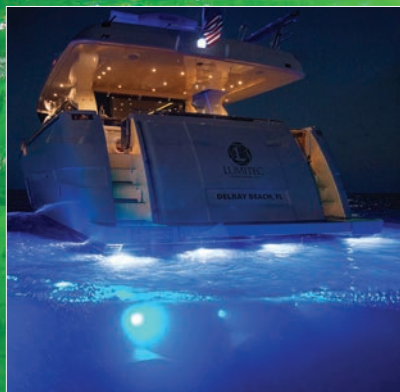
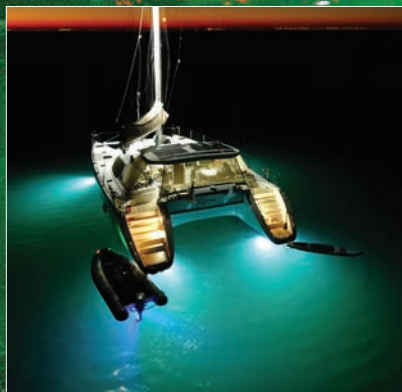

The Next Evolution of Surface-Mount Underwater Lighting is Here!

SeaBlazeX3™



The SeaBlazeX3 is in the final stage of development and will be our latest, and most advanced addition to the top-selling SeaBlaze lineup. Delivering an estimated 7,500+ lumens in a refined new design, X3 is engineered to become the new benchmark for surface-mount underwater lighting.

A ground-up redesign incorporates Lumitec's latest innovative proprietary technology to ensure an unparalleled lighting experience from a surface-mounted fixture. The X3 retains the legendary bronze construction and hole pattern of the X2 for effortless upgrades, while our enhanced design and production methods will make it the most reliable SeaBlaze ever.

SKU	HOUSING	COLOR OUTPUT	CRI*	CCT*	VOLTAGE	12VDC	24VDC	LUMENS†
101945	Bronze	Dual-Color White/Blue	70+	6500	10-30vDC	5A	2.5A	7500+
101946	Bronze	RGBW Spectrum	70+	6500	10-30vDC	5A	2.5A	7500+

* Lumens, CRI & CCT applies only to white light.



6,000+ Lumens



3.8094" Dia. X 0.72" D
Mounting Hole Size: 0.5" Dia.

SeaBlazeX2™

SeaBlazeX2 continues the legacy of the phenomenally successful SeaBlazeX series. The dual-color SeaBlazeX2 offers an internally synchronized white/blue crossfade mode as well as white or blue color output. The Spectrum offers a nearly limitless palette of intense, vivid colors complemented with a relaxing color cycle mode. Both versions deliver more than 6,000 lumens, easy surface mount installation, require no external drivers, Poco digital lighting control system compatibility, and a pedigree of reliability recognized the world over. SeaBlazeX2 is available with a bronze or polished finish option.

- 6K Lumen Output
- RGBW Full-Color
- TTP Timed Toggle Protocol
- IP68 IP Rated
- Color Cycle
- PLI Power Line Instruction
- CE European Conformity
- Dry Operation
- 5 Year Warranty

SKU	HOUSING	COLOR OUTPUT	CRI*	CCT*	VOLTAGE	12VDC	24VDC	LUMENS†
101516	Bronze	Dual-Color White/Blue	70+	6500	10-30vDC	5A	2.5A	6000+
101592	Polished	Dual-Color White/Blue	70+	6500	10-30vDC	5A	2.5A	6000+
101515	Bronze	RGBW Spectrum	70+	6500	10-30vDC	5A	2.5A	6000+
101591	Polished	RGBW Spectrum	70+	6500	10-30vDC	5A	2.5A	6000+

* Lumens, CRI & CCT applies only to white light.
W=Width, H=Height, D=Depth, Dia=Diameter

† Integrating sphere measured lumens within 1 minute of initial startup

10,000+
Lumens



4.75" Dia. X 5.125" D
Mounting Hole Size: 3.625" Dia.

4" Dia. X 5.125" D
Mounting Hole Size: 3" Dia.

Available as Transom
or Flush Mount Option

SeaBlaze™ Typhoon

Through-Hull Underwater Light

The SeaBlaze Typhoon redefines through-hull underwater lighting with excellent performance, reliability, and value.

Boasting over 10,000 measured lumens (white) and a modular quick-change design, it makes in-water servicing and upgrades effortless. An innovative internal relay streamlines wiring, cutting installation time and complexity. Housed in solid bronze, Typhoon fits a 3" mounting hole (3.625" for flush mount) and delivers full-color control - use any standard on/off switch or unlock advanced features with Lumitec's Poco Digital Lighting Control (sold separately).



Lumen
Output



RGBW
Full-Color



Timed Toggle
Protocol



IP Rated



Color Cycle



Power Line
Instruction



European
Conformity



Dry Operation



5 Year
Warranty

SKU	MOUNT	COLOR OUTPUT	CRI*	CCT*	VOLTAGE	12VDC	24VDC	LUMENS†
101448	Transom	Dual-Color White/Blue, Cross Fade	70+	6500	10-30vDC	10A	4.5A	10,000+
101449	Transom	RGBW Spectrum	70+	6500	10-30vDC	10A	4.5A	10,000+
101450	Flush	Dual-Color White/Blue, Cross Fade	70+	6500	10-30vDC	10A	4.5A	10,000+
101451	Flush	RGBW Spectrum	70+	6500	10-30vDC	10A	4.5A	10,000+

8"W X 2" H X 0.67"D
Mounting Hole Size: 0.5" Dia.

6,000+
Lumens



Javelin600X

Style meets performance in the Javelin 600X underwater light. Built for trailer boats, the Javelin 600X features a solid naval bronze housing with a proprietary plating process that delivers a brilliant, high-luster finish. Incorporating the same "smart light" technology as our market-leading SeaBlazeX2 series, Javelin provides high-performance, full-color RGBW output, simple surface-mount installation, and the intuitive operation that defines Lumitec products. PLI-enabled and fully compatible with the Poco System.



Lumen
Output



RGBW
Full-Color



Timed Toggle
Protocol



IP Rated



Color Cycle



Power Line
Instruction



European
Conformity



Dry Operation



5 Year
Warranty

SKU	HOUSING	COLOR OUTPUT	CRI*	CCT*	VOLTAGE	12VDC	24VDC	LUMENS†
101705	Polished	RGBW Spectrum	70+	6500	10-30vDC	5A	2.5A	6000+

* Lumens, CRI & CCT applies only to white light.

W=Width, H=Height, D=Depth, Dia=Diameter

† Integrating sphere measured lumens within 1 minute of initial startup

2,000+
Lumens



3.80" Dia. X 0.72" D
Mounting Hole Size: 0.5" Dia.

890+
Lumens



2.98" Dia. X 0.63" D
Mounting Hole Size: 0.5" Dia.

Single colors sold as a pair.

690+
Lumens



Power Line Instruction

Spectrum light sold individually.

SeaBlaze™ Quattro

The SeaBlaze Quattro delivers the advanced technology of its big brother, the SeaBlazeX2, into a cost-effective package. Outputting more than 2,000 lumens, it features cross-fade and color cycle modes and is constructed with a navel bronze housing with heat-tempered glass. Available in dual-color white/blue or vibrant full-color Spectrum, the SeaBlaze Quattro has set the benchmark for high-performance value in a surface mount underwater light.

- 2K
Lumen Output
- RGBW
Full-Color
- TTP
Timed Toggle Protocol
- IP68
IP Rated
- Color Cycle
- Dry Operation
- CE
European Conformity
- 5
Year Warranty
- 2-Wire
Hookup

SeaBlaze™ Mini

SeaBlaze Mini packs a surprising punch! Leveraging many of the technologies utilized in our market-leading SeaBlaze series, ensuring years of trouble-free service. Available with a full-color Spectrum (690 lumens*) option that is Poco System compatible, there is simply no better value in underwater lighting. SeaBlaze Mini and SeaBlaze Mini Spectrum are perfect for smaller trailer boats, skiffs, or dinghies. Single-color lights are sold as a pair.

- RGBW
Full-Color
- 3PD
Third Party Dimmer
- TTP
Timed Toggle Protocol
- IP68
IP Rated
- Color Cycle
- Dry Operation
- CE
European Conformity
- 2-Wire
Hookup
- 5
Year Warranty

SKU	HOUSING	COLOR OUTPUT	CRI*	CCT*	VOLTAGE	12VDC	24VDC	LUMENS†
101511	Bronze	Dual Color White/Blue	70+	6500	10-30vDC	2.1A	1.1A	2000
101510	Bronze	RGBW Spectrum	70+	6500	10-30vDC	2.1A	1.1A	2000

SKU	COLOR OUTPUT	CRI*	CCT*	VOLTAGE	12VDC	24VDC	LUMENS†
101245	White Non-Dimming	70+	6500	10-30vDC	990mA	450mA	890
101246	Blue Non-Dimming	NA	NA	10-30vDC	990mA	450mA	NA
101832	RGBW Spectrum	70+	6500	10-30vDC	580mA	320mA	690

* Lumens, CRI & CCT applies only to white light.

W=Width, H=Height, D=Depth, Dia=Diameter

† Integrating sphere measured lumens within 1 minute of initial startup

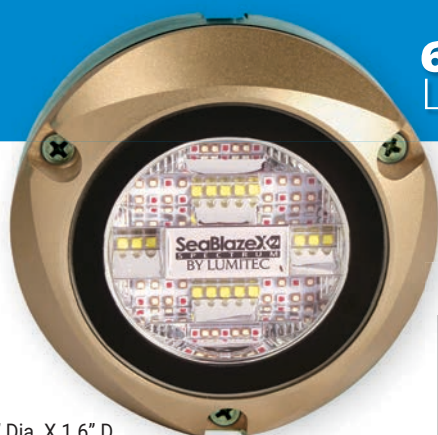

4" Dia. X 1.6" D

6,000+
Lumens

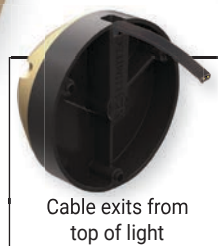
Cable exits from
top of light

4" Dia. X 1.6" D

2,000+
Lumens



3" Dia. X 1.2" D



Power Line
Instruction



Zambezi X2™

Surface Mount Underwater Light

The most powerful option of the Zambezi™ Series, the Zambezi X2 outputs over 6,000 lumens and is compatible with our award-winning Poco Digital Lighting Control system, providing advanced color control via a compatible MFD or connected smart device (Poco module is required). Choose from two color output options, brilliant dual-color white/blue or dazzling full-color Spectrum output. Perfect for mounting on typical transducer/accessory brackets.

Zambezi X2

SKU	COLOR OUTPUT	CRI*	CCT*	VOLTAGE	12VDC	24VDC	LUMENS†
101708	Dual Color White/Blue, Cross Fade	70+	6500	10-30vDC	5A	2.5A	6000
101700	RGBW Spectrum	70+	6500	10-30vDC	5A	2.5A	6000

Zambezi Quattro

SKU	COLOR OUTPUT	CRI*	CCT*	VOLTAGE	12VDC	24VDC	LUMENS†
101459	Dual Color White/Blue, Cross Fade	70+	6500	10-30vDC	2.1A	1.1A	2000
101460	RGBW Spectrum	70+	6500	10-30vDC	2.1A	1.1A	2000

Zambezi™ Quattro

Surface Mount Underwater Light

Zambezi Quattro is the perfect combination of output and value for larger pontoon boats, aluminum skiffs, and floating docks. Choose from white/blue dual-color or the vivid full-color Spectrum output, each delivering more than 2,000 lumens and stunning color. Completely sealed with no external drivers. All Zambezi products include a self-isolating spacer to separate metallic mounting surfaces to prevent galvanic corrosion.

Zambezi Mini

SKU	COLOR OUTPUT	CRI*	CCT*	VOLTAGE	12VDC	24VDC	LUMENS†
101456	White Non-Dimming	70+	6500	10-30vDC	990mA	450mA	890
101457	Blue Non-Dimming	NA	NA	10-30vDC	990mA	450mA	NA
101833	RGBW Spectrum	70+	6500	10-30vDC	580mA	320mA	690

Zambezi™ Mini

Surface Mount Underwater Light

Perfect for smaller pontoons and skiffs, Zambezi Mini is small, easy to mount, easy on the wallet, yet packs a visual punch. Choose single-color or full-color Spectrum. Color selection is simple and can be controlled from a standard power switch, or pair with a Poco module (sold separately) for advanced color control through an onboard MFD or connected smart device via the Poco app (spectrum only).

* Lumens, CRI & CCT applies only to white light.

W=Width, H=Height, D=Depth, Dia=Diameter

† Integrating sphere measured lumens within 1 minute of initial startup



2" Dia. X 2.21" D
Mounting Hole Size: 1.375" Dia.



0.88" Dia. X 0.50" D
Mounting Hole Size: 0.6875" Dia. (1 1/16)

Lutra Livewell/Utility Light

Bright, durable, and completely water sealed, the Lutra is built for the harsh environment of livewells and fish boxes. With more than four times the lumen output of other livewell lights, Lutra is ideal for today's larger livewells, fish boxes, and splash wells. Full-color spectrum output, PLI and TTP enabled, Lutra is compatible with the Digital Lighting Control system for seamless color integration into any on board lighting scheme. IP68 compliant.

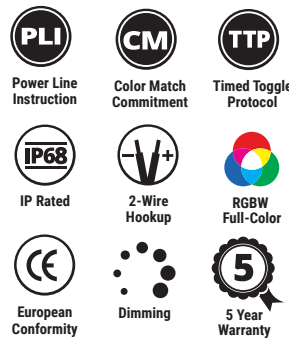

SKU	FINISH	COLOR OUTPUT	CRI*	CCT*	VOLTAGE	12VDC	24VDC	LUMENS†
101621	White	RGBW Spectrum	80+	5000	10-30vDC	430mA	230mA	340

Newt Livewell/Utility Light

Small, convenient, and extremely durable, the Newt is the go-anywhere, fully submersible utility light. Perfect for livewell and splashwell locations, Newt provides just enough light where you need it most. Available in four single-color output options, the Newt is the cost-effective solution for all wet area locations. Completely water sealed, IP68 compliant. 12vDC system only.



SKU	COLOR OUTPUT	CRI*	CCT*	VOLTAGE	12VDC	24VDC	LUMENS†
101084	White, Non-Dimming	70+	5000	10-16vDC	45mA	N/A	45
101085	Blue, Non-Dimming	70+	5000	10-16vDC	45mA	N/A	45
101086	Red, Non-Dimming	70+	5000	10-16vDC	45mA	N/A	45
101240	Warm White, Non-Dimming	90+	3000	10-16vDC	45mA	N/A	45

* Lumens, CRI & CCT applies only to white light.

** Pulse Width Modulation (PWM)

† Integrating sphere measured lumens within 1 minute of initial startup

Navigation Lighting

Lumitec is redefining navigation lighting. From sleek inset and drop-in designs to the slimmest masthead and anchor lights on the market, our innovative approach pushes the boundaries of what navigation lighting can be.



NEW

Available in 39" with a White or Black Finish



Angler Motorized Base

CONTOUR™
SERIES

Masthead 360 All-Round Anchor Combo Light

Elevate your vessel's lighting with the Contour Masthead 360 All-Round Anchor Combo Light - where style meets innovation. Designed to be sleek, lightweight, and ultra-low profile, it's the slimmest masthead/anchor combo light on the market. Engineered to exceed USCG and NMMA C5 2021 standards and rated for 3 nautical miles, the Contour Masthead/Anchor Combo Light comes in a 39" (1 m) length with two versatile mounting options: a motorized base or an antenna mount (shaft only; antenna base not included). Available in white or black finishes, and fully IP67 compliant, this light combines cutting-edge design with uncompromising performance.

SKU	FINISH/MOUNT	COLOR OUTPUT	LENGTH	VOLTAGE	12VDC	24VDC	VISIBILITY
101904	White/Antenna	White	39"	10-30vDC	185mA	95mA	3NM
101905	Black/Antenna	White	39"	10-30vDC	185mA	95mA	3NM
101906	White/Motorized	White	39"	10-30vDC	185mA	95mA	3NM
101907	Black/Motorized	White	39"	10-30vDC	185mA	95mA	3NM



Conforms to ABYC C5 Standard
Meets USCG requirements: 0-20 meters vessels



Lockable base design

Available lengths: 12" (one foot) and 39" (one meter) with black or white sleeve.



CONTOUR™
SERIES

2.5" Dia X 12" or 39" H

Available with Angler Motorized Base.



Anchor Light

The Contour Anchor Light features the slimmest profile of any anchor light on the market, combining a lightweight design with a locking, retractable base. Its folding base has a compact footprint, making storage during transport effortless. The innovative, user-friendly design allows quick setup, and the light locks securely into place for worry-free use. Available in 12" and 39" (1 m) lengths with a white or black shaft, and U.S. Coast Guard approved for 2 nm.

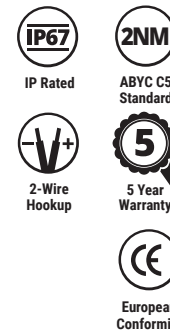

SKU	FINISH/MOUNT	COLOR OUTPUT	LENGTH	VOLTAGE	12VDC	24VDC	VISIBILITY
101585	Black Sleeve	White	12"	10-30vDC	80mA	45mA	2NM
101584	Black Sleeve	White	39"	10-30vDC	80mA	45mA	2NM
101692	White Sleeve	White	12"	10-30vDC	80mA	45mA	2NM
101693	White Sleeve	White	39"	10-30vDC	80mA	45mA	2NM
101918	White/Motorized	White	39"	10-30vDC	80mA	45mA	2NM
101919	Black/Motorized	White	39"	10-30vDC	80mA	45mA	2NM

Conforms to ABYC A16 and ABYC C5 Standards
Meets USCG requirements: 0-20 meters vessels



Drop-in Mount
2.5"W X 1.17H X 1.5" D
Requires Custom Mold



USCG
COMPLIANT

Drop-in Navigation Light (Port/Starboard/Stem)

Contour's Drop-in series leverages a single, symmetrical universal pocket design that is molded into the hardtop during the manufacturing process, for a low profile with no exposed fasteners. A clean, modern monochromatic finish adds to the seamless integration, with careful consideration given to mating the draft angles and part radii. U.S. Coast Guard approved to 2nm.



IP Rated



ABYC C5 Standard



2-Wire Hookup



5 Year Warranty



European Conformity

CONTOUR
SERIES

SKU	FINISH	COLOR OUTPUT	VOLTAGE	12VDC	24VDC	VISIBILITY
101846	White	Port/Red	10-30vDC	67mA	33mA	2NM
101836	White	Starboard/Green	10-30vDC	34mA	17mA	2NM
101866	White	Stern/White	10-30vDC	50mA	25mA	2NM

Conforms to ABYC A16 and ABYC C-5 Standards
Meets USCG requirements: 0-20 meters vessels



Inset Mount
2.67"W X 1H X 1.32" D



USCG
COMPLIANT

Inset Navigation Light (Port/Starboard/Stem)

Designed specifically for custom builders, Contour's Inset series is designed to be inset into the face of a hardtop or pilothouse with no exposed fasteners. Its small appearance makes it almost disappear, but the output is more than large enough to exceed U.S. Coast Guard's 2 nautical miles requirements. U.S. Coast Guard approved 2nm for vessels up to 50m/165 feet.



IP Rated



ABYC C5 Standard



2-Wire Hookup



5 Year Warranty



European Conformity

CONTOUR
SERIES

SKU	FINISH	COLOR OUTPUT	VOLTAGE	12VDC	24VDC	VISIBILITY
101847	White	Port/Red	10-30vDC	67mA	33mA	2NM
101837	White	Starboard/Green	10-30vDC	34mA	17mA	2NM
101867	White	Stern/White	10-30vDC	50mA	25mA	2NM

* Lumens, CRI & CCT applies only to white light.
W=Width, H=Height, D=Depth, Dia=Diameter

† Integrating sphere measured lumens within 1 minute of initial startup

Conforms to ABYC A16 and ABYC C-5 Standards
Meets USCG requirements: 0-20 meters vessels

World's First Nav/Docking Combination Light

Mold Mount
4"W X 1H X 1.8" D
Requires Custom Mold



USCG
COMPLIANT

Combination Navigation/Docking Light

Innovation – plain and simple. Lumitec's engineers have combined a bright, sharp 1,000 lumen dock light with a U.S. Coast Guard approved 2nm navigation light. This innovative, easy-to-install, great looking, combination light is designed to be molded into the hardtop during the manufacturing process, resulting in a very clean profile, with all the reliability you've come to expect from the Lumitec brand.



IP Rated



ABYC C5 Standard



2-Wire Hookup



5 Year Warranty



European Conformity

CONTOUR
SERIES

SKU	FINISH	COLOR OUTPUT	VOLTAGE	12VDC	24VDC	VISIBILITY
101849	White	Port/Red/Flood White	10-30vDC	36mA	18mA	2NM
101839	White	Starboard/Green/Flood White	10-30vDC	25mA	13mA	2NM

Conforms to ABYC A16 and ABYC C-5 Standards
Meets USCG requirements: 0-20 meters vessels

Built-in Floodlight (applies to all SKU numbers)

White Non-Dimming | CRI-70+ | CCT-5000 | Voltage-10-30vDC | 1.3A @12vDC | 600mA @ 24vDC | 1000 Lumens

* Lumens, CRI & CCT applies only to white light.

W=Width, H=Height, D=Depth, Dia=Diameter

† Integrating sphere measured lumens within 1 minute of initial startup

Composite Navigation Light



4.5"W X 1H X 2.1" D

USCG
COMPLIANT

Classic Aluminum Navigation Light



3.6"W X 1H X 2.2" D

Surface Mount Navigation Lights

For retrofit and new applications where a molded-in pocket is not possible or practical, we offer our surface mount navigation lights. Clean styling and unmatched reliability. Choose classic aluminum half-round design for mounting to vertical surfaces, or the more contemporary composite version for horizontal mounting surfaces. U.S. Coast Guard approved 2nm for vessels up to 50m/165 feet.



IP Rated



ABYC C5 Standard



2-Wire Hookup



5 Year Warranty



European Conformity

Composite Navigation Light

SKU	FINISH	COLOR OUTPUT	VOLTAGE	12VDC	24VDC	VISIBILITY
101848	White	Port/Red	10-30vDC	67mA	33mA	2NM
101838	White	Starboard/Green	10-30vDC	34mA	17mA	2NM
101868	White	Stern/White	10-30vDC	50mA	25mA	2NM

Conforms to ABYC A16 and ABYC C-5 Standards
Meets USCG requirements: 0-20 meters vessels

Classic Aluminum Navigation Light

SKU	FINISH	COLOR OUTPUT	VOLTAGE	12VDC	24VDC	VISIBILITY
101845	Brushed	Port/Red	10-30vDC	34mA	17mA	2NM
101835	Brushed	Starboard/Green	10-30vDC	67mA	33mA	2NM

Conforms to ABYC A16 and ABYC C-5 Standards
Meets USCG requirements: 0-20 meters vessels



Dock & Deck Lighting Systems

Elevate your waterfront experience with Lumitec's Dock and Deck lights - the perfect blend of performance, reliability, and striking design from the world leader in marine lighting. Whether you're a DIY enthusiast seeking simple plug-and-play solutions or managing a commercial project that demands fully customizable modular systems, Lumitec's Dock and Deck lighting transforms any outdoor space into a stunning, illuminated waterfront destination.



4" Dia. X 2.1" D



Mantis™ Dock Lighting Kit

Illuminate your dock like never before with the Mantis Dock Light Kit. Featuring three Quattro Spectrum underwater lights and a revolutionary zip-mount universal system, installation is effortless - perfect for both square and round pilings. Choose from a dazzling full-color RGBW crossfade, ultra-bright fish-attracting white (2,000+ lumens), or any custom color you desire. The 150W weatherproof power supply (supports up to 4 lights) plugs directly into any standard 110V AC GFCI outlet (*110V AC only). Everything you need is included - wiring, connectors, mounts, and hardware - plus a 5-year warranty on all electrical components.

- 2K Lumen Output
- RGBW Full-Color
- TTP Timed Toggle Protocol
- IP68 IP Rated
- Color Cycle
- Color Change
- Dry Operation
- 5 Year Warranty

SKU	DESCRIPTION	NUMBER OF LIGHTS
101525	Mantis Dock Light Kit (110vAC only)	3
101526	Mantis Dock Light Add-On Light	1
101527	Mantis Dock Light 50' Cable Extension Kit	N/A

* The Mantis Dock Light Kit can only be connected to 110vAC and not 220vAC. 220vAC custom kits are available upon request. Contact your sales representative for more product information.

The Mantis Dock Light Kit leverages SeaBlaze Quattro technology. Refer to the underwater light section for specifications on this light.



4" Dia. X 2.1" D



Wireless Control

Smartphone Not Included

Kraken Command Box includes Poco module and 480w power supply.

Kraken™ Dock Lighting System

The Kraken Dock Lighting Modular System - engineered for commercial applications, but versatile enough for residential installations. A single Kraken Command Box (compatible with 110 V AC or 220 V AC) powers and controls up to six Kraken underwater lights (sold separately), each producing over 6,000 lumens of white light. Built on our proven SeaBlazeX2 platform, Kraken underwater lights are available in dual-color white/blue or full-color RGBW output. Enhance your waterfront space by adding the Nautilus Piling Light and Scallop Pathway Light for walkways and decks, all designed to seamlessly integrate into the Kraken System.

- 6K Lumen Output
- RGBW Full-Color
- TTP Timed Toggle Protocol
- IP68 IP Rated
- Color Cycle
- PLI Power Line Instruction
- Color Change
- 5 Year Warranty

SKU	DESCRIPTION	NUMBER OF LIGHTS
101636	Kraken Dock Light - Dual-Color white/blue	1
101637	Kraken Dock Light - RGBW Spectrum	1
101638	Kraken Command Box (with Poco)	N/A
101680	Kraken Secondary Box (no Poco)	N/A

The Kraken Dock Light System leverages SeaBlazeX2 technology. Refer to the underwater light section for specifications on this light.

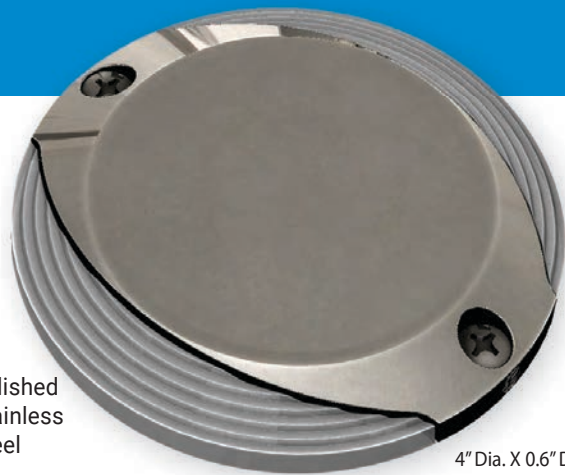

Polished Stainless Steel

4" Dia. X 0.6" D

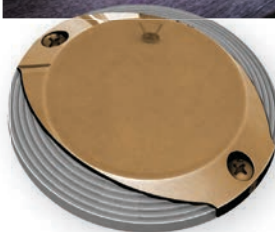
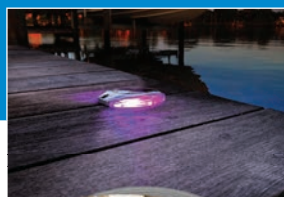

Polished Bronze

Scallop

Surface Mount Pathway Light

Lumitec's Scallop Pathway Light combines a slim, low-profile design with industry-first innovation as the world's first ADA-compliant, PLI-compatible dock and pathway light. Its engineered beam angle minimizes glare while illuminating walkway surfaces for safe, comfortable use. Offered in hand-polished 316 stainless steel or bronze finishes, Scallop is available in warm white or RGBW full-color output. PLI and TTP enabled, it can be added to a Mantis Dock Light Kit or integrated into a Kraken Dock Lighting System. Fully water-sealed and IP67 compliant.

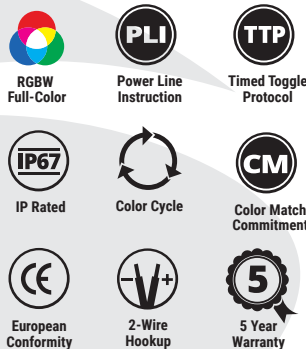

SKU	HOUSING	COLOR OUTPUT	CRI*	CCT*	VOLTAGE	12VDC	24VDC	LUMENS†
101627	Stainless Steel	Cool White RGBW Spectrum	70+	5000	10-30vDC	340mA	190mA	100
101628	Bronze	Cool White RGBW Spectrum	70+	5000	10-30vDC	340mA	190mA	100
101672	Stainless Steel	Warm White RGBW Spectrum	80+	3000	10-30vDC	340mA	190mA	80
101673	Bronze	Warm White RGBW Spectrum	80+	3000	10-30vDC	340mA	190mA	80
101629	Stainless Steel	Warm White	80+	3000	10-30vDC	340mA	190mA	80
101630	Bronze	Warm White	80+	3000	10-30vDC	340mA	190mA	80



Polished Stainless Steel

1.6" W X 4.2" H X 1.5" D

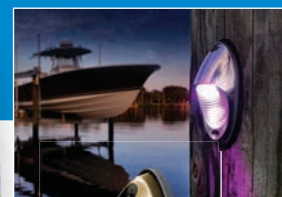

Polished Bronze

Nautilus

Surface Mount Piling Light

Compact and versatile, the Nautilus light is designed for pilings, posts, pathways, and wall-wash applications. The included adapter allows for surface mounting on both flat and curved surfaces. Nautilus is offered in hand-polished 316 stainless steel or bronze finishes and provides output options in warm white or full-color RGBW. PLI and TTP enabled, the fixture integrates with the Mantis Dock Light Kit or the Kraken Dock Lighting System. Fully water-sealed and IP67 compliant for reliable performance in marine environments.



SKU	HOUSING	COLOR OUTPUT	CRI*	CCT*	VOLTAGE	12VDC	24VDC	LUMENS†
101631	Stainless Steel	Spectrum (cool wht)	80+	5000	10-30vDC	430mA	230mA	340
101632	Bronze	Spectrum (cool wht)	80+	5000	10-30vDC	430mA	230mA	340
101670	Stainless Steel	Spectrum (warm wht)	90+	3000	10-30vDC	430mA	230mA	255
101671	Bronze	Spectrum (warm wht)	90+	3000	10-30vDC	430mA	230mA	255
101633	Stainless Steel	White (warm wht)	90+	3000	10-30vDC	480mA	260mA	255
101634	Bronze	White (warm wht)	90+	3000	10-30vDC	480mA	260mA	255

* Lumens, CRI & CCT applies only to white light. W=Width, H=Height, D=Depth, Dia=Diameter
 † Integrating sphere measured lumens within 1 minute of initial startup

Power Supply

A 150w power supply is available for above water lighting.
SKU: 101528





As of January 1, 2025, all Lumitec products carry a 5-year warranty from the date of purchase. If you purchased a product before January 1, 2025, your product will retain the original 3-year warranty from the date of purchase.

Customer Support

Lumitec's phenomenal growth is due in large part to our ever-growing base of loyal OEMs, channel partners, and end-users. We take this loyalty seriously and strive to ensure that each interaction with Lumitec is a satisfying one.

Our newly enhanced website includes a comprehensive "Support Center." Here, you will find frequently asked questions, Getting Started installation guides, technical details, wiring information, product use videos, and other invaluable product information, all just a click away.

Visit **LumitecPro.com** for more advanced training and useful refresher courses.

1055 SW 15TH AVENUE, SUITE 7
 DELRAY BEACH, FLORIDA 33444

TEL. 561.272.9840
 FAX. 561.272.9839
 WEB. LUMITECLIGHTING.COM

Feature Icons

- | | |
|---|--|
|  TTP Timed Toggle Protocol (TTP) enabled
(visit lumiteclighting.com/support/ttp for information) |  RGBW Spectrum Color |
|  3PD Third Party Dimmer switch compatibility
(PWM type dimmer required) |  Internal Dimmer-TTP dimming
with no external controllers |
|  CM Color Match guarantee on all lights in the
same light family |  Color Cycle mode |
|  PLI Power Line Instruction (PLI) enabled
(visit lumiteclighting.com/pli for information) |  Strobe or Flashing feature |
|  IP Ingress Protected (IP) product rating |  Ignition Protected |
|  CE Meets European Conformity Standards |  Dry Operation - light can operate
out of water without damage |
|  5 5-Year warranty |  Color Change mode |

Lumitec Limited Warranty

Lumitec, LLC ("Lumitec") warrants, to the original purchaser only, that the Lumitec product will be free from defects in manufacturing, workmanship, and materials for a period of five (5) years from the date of original purchase. This Limited Warranty is not transferable for any reason, including in the event the applicable product is sold, traded, transferred or otherwise disposed of in any manner by the original purchaser to another party. Lumitec is not responsible for product failure caused by abuse, neglect, improper installation, or failure in applications other than those for which it was designed, intended, and marketed. Lumitec assumes no responsibility whatsoever for any damage, loss, or injury that may result from the incorrect installation of this product, including but not limited to structural damage due to water intrusion, electrical malfunction or vessel sinking when used in maritime applications. Lumitec is not responsible for damage to products caused by fire, explosion, implosion, flood, hurricane, earthquake, lightning strike, acid rain, chemical fallout, catastrophic event, or other act of God or nature.



Tel. 561.272.9840
Fax. 561.272.9839
Web. lumiteclighting.com

1055 SW 15th Avenue, Suite 7
Delray Beach, Florida 33444

| PERFORMANCE | RELIABILITY | QUALITY |