

ET-HP® Epoxy Adhesive

ET-HP Cure Schedule

Base Material Temperature		Gel Time (minutes)	Cure Time ¹ (hrs.)
°F	°C		
50	10	45	72
60	16	30	24
80	27	20	24
100	38	15	24

1. For water-saturated concrete, the cure times must be doubled.

ET-HP Typical Properties

Property		Class B	Class C	Test Method
		(40°–60°F)	(>60°F)	
Consistency		Non-sag	Non-sag	ASTM C881
Bond Strength, Slant Shear	Hardened to Hardened Concrete, 2-Day Cure ¹	1,300 psi	2,300 psi	ASTM C882
	Hardened to Hardened Concrete, 14-Day Cure ¹	1,750 psi	2,400 psi	
	Fresh to Hardened Concrete, 14-Day Cure ²	2,800 psi	2,800 psi	
Compressive Yield Strength, 7-Day Cure ²		11,800 psi	16,300 psi	ASTM D695
Compressive Modulus, 7-Day Cure ²		453,000 psi	595,000 psi	ASTM D695
Heat Deflection Temperature, 7-Day Cure ²		133°F (56°C)		ASTM D648
Glass Transition Temperature, 7-Day Cure ²		121°F (49°C)		ASTM E1356
Decomposition Temperature, 24-Hour Cure ²		500°F (260°C)		ASTM E2550
Water Absorption, 24-Hours, 7-Day Cure ²		0.34%		ASTM D570
Shore D Hardness, 24-Hour Cure ²		86		ASTM D2240
Linear Coefficient of Shrinkage, 7-Day Cure ²		0.001 in./in.		ASTM D2566
Coefficient of Thermal Expansion ²		2.1 x 10 ⁻⁵ in./in.°F		ASTM C531

1. Material and curing conditions: Class B at 40° ± 2°F, Class C at 60° ± 2°F.

2. Material and curing conditions: 73° ± 2°F.

ET-HP Installation Information and Additional Data for Threaded Rod and Rebar¹



Characteristic	Symbol	Units	Nominal Anchor Diameter (in.) / Rebar Size						
			3/8 / #3	1/2 / #4	5/8 / #5	3/4 / #6	7/8 / #7	1 / #8	1 1/4 / #10
Installation Information									
Drill Bit Diameter	d_{hole}	in.	1/2	5/8	3/4	7/8	1	1 1/8	1 3/8
Maximum Tightening Torque	T_{inst}	ft.-lb.	15	25	40	50	60	80	150
Permitted Embedment Depth Range	Minimum	h_{ef}	2 3/8	2 3/4	3 1/8	3 1/2	3 3/4	4	5
	Maximum	h_{ef}	4 1/2	6	7 1/2	9	10 1/2	12	15
Minimum Concrete Thickness	h_{min}	in.	$h_{ef} + 5d_{hole}$						
Critical Edge Distance ²	c_{ac}	in.	See footnote 2						
Minimum Edge Distance	c_{min}	in.	1 3/4						2 3/4
Minimum Anchor Spacing	s_{min}	in.	3						6

1. The information presented in this table is to be used in conjunction with the design criteria of ACI 318-14 and ACI 318-11.

2. $c_{ac} = h_{ef}(\tau_{k,uncr}/1160)^{0.4} \times [3.1 - 0.7(h/h_{ef})]$, where:

$$[h/h_{ef}] \leq 2.4$$

$\tau_{k,uncr}$ = the characteristic bond strength in uncracked concrete, given in the tables that follow $\leq k_{uncr} ((h_{ef} \times f'_c)^{0.5} / (\pi \times d_a))$

h = the member thickness (inches)

h_{ef} = the embedment depth (inches)

* See p. 12 for an explanation of the load table icons.

ET-HP® Design Information — Concrete

ET-HP Tension Strength Design Data for Threaded Rod¹



Characteristic		Symbol	Units	Nominal Anchor Diameter (in.)							
				3/8	1/2	5/8	3/4	7/8	1	1 1/4	
Steel Strength in Tension											
Threaded Rod	Minimum Tensile Stress Area	A_{se}	in. ²	0.078	0.142	0.226	0.334	0.462	0.606	0.969	
	Tension Resistance of Steel — ASTM F1554, Grade 36	N_{sa}	lb.	4,525	8,235	13,110	19,370	26,795	35,150	56,200	
	Tension Resistance of Steel — ASTM A193, Grade B7			9,750	17,750	28,250	41,750	57,750	75,750	121,125	
	Tension Resistance of Steel — Type 410 Stainless (ASTM A193, Grade B6)			8,580	15,620	24,860	36,740	50,820	66,660	106,590	
	Tension Resistance of Steel — Type 304 and 316 Stainless (ASTM A193, Grade B8 & B8M)			4,445	8,095	12,880	19,040	26,335	34,540	55,235	
	Strength Reduction Factor — Steel Failure			ϕ	—	0.75 ⁶					
Concrete Breakout Strength in Tension (2,500 psi ≤ f'_c ≤ 8,000 psi)¹²											
Effectiveness Factor — Uncracked Concrete		k_{uncr}	—	24							
Effectiveness Factor — Cracked Concrete		k_{cr}	—	17							
Strength Reduction Factor — Breakout Failure		ϕ	—	0.65 ⁸							
Bond Strength in Tension (2,500 psi ≤ f'_c ≤ 8,000 psi)¹²											
Uncracked Concrete ^{2,3,4}	Characteristic Bond Strength ^{5,13}	$\tau_{k,uncr}$	psi	390	380	370	360	350	335	315	
	Permitted Embedment Depth Range	Minimum	h_{ef}	in.	2 3/8	2 3/4	3 1/8	3 1/2	3 3/4	4	5
		Maximum	h_{ef}	in.	4 1/2	6	7 1/2	9	10 1/2	12	15
Cracked Concrete ^{2,3,4}	Characteristic Bond Strength ^{5,9,10,11,12,13}	$\tau_{k,cr}$	psi	160	200	160	205	190	165	140	
	Permitted Embedment Depth Range	Minimum	h_{ef}	in.	3	3	3 1/8	3 1/2	3 3/4	4	5
		Maximum	h_{ef}	in.	4 1/2	6	7 1/2	9	10 1/2	12	15
Bond Strength in Tension — Bond Strength Reduction Factors for Periodic Special Inspection											
Strength Reduction Factor — Dry Concrete		ϕ_{dry}	—	0.65 ⁷							
Strength Reduction Factor — Water-Saturated Concrete		ϕ_{sat}	—	0.45 ⁷							

- The information presented in this table is to be used in conjunction with the design criteria of ACI 318-14 or ACI 318-11.
- Temperature Range: Maximum short-term temperature of 150°F (66°C). Maximum long-term temperature of 110°F (43°C).
- Short-term concrete temperatures are those that occur over short intervals (diurnal cycling).
- Long-term concrete temperatures are constant temperatures over a significant time period.
- For anchors that only resist wind or seismic loads, bond strengths may be multiplied by 2.70.
- The value of ϕ applies when the load combinations of ACI 318-14 5.3 or ACI 318-11 Section 9.2 are used. If the load combinations of ACI 318 Appendix C are used, refer to ACI 318-11 D.4.4 to determine the appropriate value of ϕ .
- The value of ϕ applies when both the load combinations of ACI 318-14 5.3 or ACI 318-11 Section 9.2 are used and the requirements of ACI 318-14 17.3.3 or ACI 318-11 D.4.4 (c) for Condition B are met. If the load combinations of ACI 318 Appendix C are used, refer to ACI 318-11 D.4.5 to determine the appropriate value of ϕ .
- The value of ϕ applies when both the load combinations of ACI 318-14 5.3 or ACI 318-11 Section 9.2 are used and the requirements of ACI 318-14 17.3.3 or ACI 318-11 D.4.4 (c) for Condition B are met. If the load combinations of ACI 318-14 5.3 or ACI 318-11 Section 9.2 are used and the requirements of ACI 318-11 D.4.4 (c) for Condition A are met, refer to ACI 318-11 D.4.4 to determine the appropriate value of ϕ . If the load combinations of ACI 318 Appendix C are used, refer to ACI 318-11 D.4.5 to determine the appropriate value of ϕ .
- For anchors installed in regions assigned to Seismic Design Category C, D, E or F, the bond strength values for 3/8" and 1 1/4" anchors must be multiplied by $\alpha_{N,seis} = 0.78$.
- For anchors installed in regions assigned to Seismic Design Category C, D, E or F, the bond strength values for 1/2", 5/8" and 3/4" anchors must be multiplied by $\alpha_{N,seis} = 0.85$.
- For anchors installed in regions assigned to Seismic Design Category C, D, E or F, the bond strength values for 7/8" anchors must be multiplied by $\alpha_{N,seis} = 0.82$.
- For anchors installed in regions assigned to Seismic Design Category C, D, E or F, the bond strength values for 1" anchors must be multiplied by $\alpha_{N,seis} = 0.70$.

* See p. 12 for an explanation of the load table icons.

ET-HP® Design Information — Concrete

ET-HP Tension Strength Design Data for Rebar¹



Characteristic		Symbol	Units	Rebar Size							
				#3	#4	#5	#6	#7	#8	#10	
Steel Strength in Tension											
Rebar	Minimum Tensile Stress Area	A_{se}	in ²	0.11	0.2	0.31	0.44	0.6	0.79	1.27	
	Tension Resistance of Steel — Rebar (ASTM A615 Grade 60)	N_{sa}	lb.	9,900	18,000	27,900	39,600	54,000	71,100	114,300	
	Strength Reduction Factor — Steel Failure	ϕ	—	0.65 ⁶							
Concrete Breakout Strength in Tension (2,500 psi ≤ f_c ≤ 8,000 psi)											
Effectiveness Factor — Uncracked Concrete		k_{uncr}	—	24							
Effectiveness Factor — Cracked Concrete		k_{cr}	—	17							
Strength Reduction Factor — Breakout Failure		ϕ	—	0.65 ⁸							
Bond Strength in Tension (2,500 psi ≤ f_c ≤ 8,000 psi)											
Uncracked Concrete ^{2,3,4}	Characteristic Bond Strength ^{5,9}		$\tau_{k,uncr}$	psi	370	360	350	335	325	315	295
	Permitted Embedment Depth Range	Minimum	h_{ef}	in.	2 ³ / ₈	2 ³ / ₄	3 ¹ / ₂	3 ¹ / ₂	3 ³ / ₄	4	5
		Maximum			4 ¹ / ₂	6	7 ¹ / ₂	9	10 ¹ / ₂	12	15
Cracked Concrete ^{2,3,4}	Characteristic Bond Strength ^{5,9}		$\tau_{k,cr}$	psi	130	140	155	165	180	190	215
	Permitted Embedment Depth Range	Minimum	h_{ef}	in.	3	3	3 ¹ / ₂	3 ¹ / ₂	3 ³ / ₄	4	5
		Maximum			4 ¹ / ₂	6	7 ¹ / ₂	9	10 ¹ / ₂	12	15
Bond Strength in Tension — Bond Strength Reduction Factors for Periodic and Continuous Special Inspection											
Strength Reduction Factor — Dry Concrete		ϕ_{dry}	—	0.65 ⁷							
Strength Reduction Factor — Water-Saturated Concrete		ϕ_{sat}	—	0.45 ⁷							

- The information presented in this table is to be used in conjunction with the design criteria of ACI 318-14 or ACI 318-11.
- Temperature Range: Maximum short-term temperature of 150°F (66°C). Maximum long-term temperature of 110°F (43°C).
- Short-term concrete temperatures are those that occur over short intervals (diurnal cycling).
- Long-term concrete temperatures are constant temperatures over a significant time period.
- For anchors that only resist wind or seismic loads, bond strengths may be multiplied by 2.70.
- The value of ϕ applies when the load combinations of ACI 318-14 5.3 or ACI 318-11 Section 9.2 are used. If the load combinations of ACI 318 Appendix C are used, refer to ACI 318-11 D.4.4 to determine the appropriate value of ϕ .
- The value of ϕ applies when both the load combinations of ACI 318-14 5.3 or ACI 318-11 Section 9.2 are used and the requirements of ACI 318-14 17.3.3 or ACI 318-11 D.4.4 (c) for Condition B are met. If the load combinations of ACI 318 Appendix C are used, refer to ACI 318-11 D.4.5 to determine the appropriate value of ϕ .
- The value of ϕ applies when both the load combinations of ACI 318-14 5.3 or ACI 318-11 Section 9.2 are used and the requirements of ACI 318-14 17.3.3 or ACI 318-11 D.4.4 (c) for Condition B are met. If the load combinations of ACI 318-14 5.3 or ACI 318-11 Section 9.2 are used and the requirements of ACI 318-11 D.4.4 (c) for Condition A are met, refer to ACI 318-11 D.4.4 to determine the appropriate value of ϕ . If the load combinations of ACI 318 Appendix C are used, refer to ACI 318-11 D.4.5 to determine the appropriate value of ϕ .

* See p. 12 for an explanation of the load table icons.

ET-HP® Design Information — Concrete

ET-HP Shear Strength Design Data for Threaded Rod¹



Characteristic		Symbol	Units	Nominal Anchor Diameter (in.)						
				3/8	1/2	5/8	3/4	7/8	1	1 1/4
Steel Strength in Shear										
Threaded Rod	Minimum Shear Stress Area	A_{se}	in. ²	0.078	0.142	0.226	0.334	0.462	0.606	0.969
	Shear Resistance of Steel — ASTM F1554, Grade 36	V_{sa}	lb.	2,260	4,940	7,865	11,625	16,080	21,090	33,720
	Shear Resistance of Steel — ASTM A193, Grade B7			4,875	10,650	16,950	25,050	34,650	45,450	72,675
	Shear Resistance of Steel — Type 410 Stainless (ASTM A193, Grade B6)			4,290	9,370	14,910	22,040	30,490	40,000	63,955
	Shear Resistance of Steel — Type 304 and 316 Stainless (ASTM A193, Grade B8 & B8M)			2,225	4,855	7,730	11,425	15,800	20,725	33,140
	Reduction for Seismic Shear — ASTM F1554, Grade 36	αV_{seis} ⁵	—	0.63		0.85		0.75		
	Reduction for Seismic Shear — ASTM A193, Grade B7			0.63		0.85		0.75		
	Reduction for Seismic Shear — Stainless (ASTM A193, Grade B6)			0.60		0.85		0.75		
	Reduction for Seismic Shear — Stainless (ASTM A193, Grade B8 & B8M)			0.60		0.85		0.75		
	Strength Reduction Factor — Steel Failure	ϕ	—	0.65 ²						
Concrete Breakout Strength in Shear										
Outside Diameter of Anchor	d_o	in.	0.375	0.5	0.625	0.75	0.875	1	1.25	
Load Bearing Length of Anchor in Shear	ℓ_e	in.	Min. of h_{ef} and 8 times anchor diameter							
Strength Reduction Factor — Breakout Failure	ϕ	—	0.70 ³							
Concrete Pryout Strength in Shear										
Coefficient for Pryout Strength	k_{cp}	—	1.0 for $h_{ef} < 2.50"$; 2.0 for $h_{ef} \geq 2.50"$							
Strength Reduction Factor — Pryout Failure	ϕ	—	0.70 ⁴							

- The information presented in this table is to be used in conjunction with the design criteria of ACI 318-14 and ACI 318-11.
- The value of ϕ applies when the load combinations of ACI 318-14 5.3 or ACI 318-11 Section 9.2 are used.
If the load combinations of ACI 318 Appendix C are used, refer to ACI 318-11 D.4.4 to determine the appropriate value of ϕ .
- The value of ϕ applies when both the load combinations of ACI 318-14 5.3 or ACI 318-11 Section 9.2 are used and the requirements of ACI 318-14 17.3.3 and ACI 318-11 D.4.3 (c) for Condition B are met. If the load combinations of ACI 318-14 5.3 or ACI 318-11 Section 9.2 are used and the requirements of ACI 318-14 17.3.3 and ACI 318-11 D.4.3 (c) for Condition A are met, refer to ACI 318-14 17.3.3 and ACI 318-11 D.4.3 to determine the appropriate value of ϕ . If the load combinations of ACI 318 Appendix C are used, refer to ACI 318-14 and ACI 318-11 D.4.4 to determine the appropriate value of ϕ .
- The value of ϕ applies when both the load combinations of ACI 318-14 5.3 or ACI 318-11 Section 9.2 are used and the requirements of ACI 318-14 17.3.3 and ACI 318-11 D.4.3 (c) for Condition B are met. If the load combinations of ACI 318 Appendix C are used, refer to ACI 318-14 and ACI 318-11 D.4.4 to determine the appropriate value of ϕ .
- The values of V_{sa} are applicable for both cracked concrete and uncracked concrete. For anchors installed in regions assigned to Seismic Design Category C, D, E or F, V_{sa} must be multiplied by αV_{seis} for the corresponding anchor steel type.

⁵ See p. 12 for an explanation of the load table icons.

ET-HP® Design Information — Concrete

ET-HP Shear Strength Design Data for Rebar¹



Characteristic	Symbol	Units	Rebar Size							
			#3	#4	#5	#6	#7	#8	#10	
Steel Strength in Shear										
Rebar	Minimum Shear Stress Area	A_{se}	in. ²	0.11	0.2	0.31	0.44	0.6	0.79	1.27
	Shear Resistance of Steel — Rebar (ASTM A615 Grade 60)	V_{sa}	lb.	4,950	10,800	16,740	23,760	32,400	42,660	68,580
	Reduction for Seismic Shear — Rebar (ASTM A615 Grade 60)	$\alpha_{V_{seis}}$ ⁵	—	0.6		0.8			0.75	
	Strength Reduction Factor — Steel Failure	ϕ	—	0.60 ²						
Concrete Breakout Strength in Shear										
Outside Diameter of Anchor	d_o	in.	0.375	0.5	0.625	0.75	0.875	1	1.25	
Load-Bearing Length of Anchor in Shear	ℓ_e	in.	Min. of h_{ef} and 8 times anchor diameter							
Strength Reduction Factor — Breakout Failure	ϕ	—	0.70 ³							
Concrete Pryout Strength in Shear										
Coefficient for Pryout Strength	k_{cp}	—	1.0 for $h_{ef} < 2.50"$; 2.0 for $h_{ef} \geq 2.50"$							
Strength Reduction Factor — Pryout Failure	ϕ	—	0.70 ⁴							

- The information presented in this table is to be used in conjunction with the design criteria of ACI 318-14 or ACI 318-11.
- The value of ϕ applies when the load combinations of ACI 318-14 5.3 or ACI 318-11 Section 9.2 are used. If the load combinations of ACI 318 Appendix C are used, refer to ACI 318-11 D.4.4 to determine the appropriate value of ϕ .
- The value of ϕ applies when both the load combinations of ACI 318-14 5.3 or ACI 318-11 Section 9.2 are used and the requirements of ACI 318-14 17.3.3 and ACI 318-11 D.4.3 (c) for Condition B are met. If the load combinations of ACI 318-14 5.3 or ACI 318-11 Section 9.2 are used and the requirements of ACI 318-14 17.3.3 and ACI 318-11 D.4.3 (c) for Condition A are met, refer to ACI 318-14 17.3.3 and ACI 318-11 D.4.3 to determine the appropriate value of ϕ . If the load combinations of ACI 318 Appendix C are used, refer to ACI 318-14 and ACI 318-11 D.4.4 to determine the appropriate value of ϕ .
- The value of ϕ applies when both the load combinations of ACI 318-14 5.3 or ACI 318-11 Section 9.2 are used and the requirements of ACI 318-14 17.3.3 and ACI 318-11 D.4.3 (c) for Condition B are met. If the load combinations of ACI 318 Appendix C are used, refer to ACI 318-14 and ACI 318-11 D.4.4 to determine the appropriate value of ϕ .
- The values of V_{sa} are applicable for both cracked concrete and uncracked concrete. For anchors installed in regions assigned to Seismic Design Category C, D, E or F, V_{sa} must be multiplied by $\alpha_{V_{seis}}$.

For additional load tables, visit strongtie.com.



Anchor Designer™ Software for ACI 318, ETAG and CSA

Simpson Strong-Tie® Anchor Designer software accurately analyzes existing design or suggests anchor solutions based on user-defined design elements in cracked and uncracked concrete conditions.

* See p. 12 for an explanation of the load table icons.

ET-HP® Design Information — Masonry

ET-HP Allowable Tension and Shear Loads for Threaded Rod and Rebar in the Face of Fully Grouted CMU Wall Construction^{1, 3, 4, 5, 6, 8, 9, 10, 11, 12}

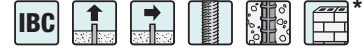

Diameter (in.) or Rebar Size No.	Drill Bit Diameter (in.)	Minimum Embedment ² (in.)	Allowable Load Based on Bond Strength ⁷ (lb.)	
			Tension Load	Shear Load
Threaded Rod Installed in the Face of CMU Wall				
3/8	1/2	3 3/8	1,425	845
1/2	5/8	4 1/2	1,425	1,470
5/8	3/4	5 5/8	1,560	1,835
3/4	7/8	6 3/4	1,560	2,050
Rebar Installed in the Face of CMU Wall				
#3	1/2	3 3/8	1,275	1,335
#4	5/8	4 1/2	1,435	1,355
#5	3/4	5 5/8	1,550	1,355

1. Allowable load shall be the lesser of the bond values shown in this table and steel values, shown on p. 52.
2. Embedment depth shall be measured from the outside face of masonry wall.
3. Critical and minimum edge distance and spacing shall comply with the information on p. 51. Figure 2 on p. 51 illustrates critical and minimum edge and end distances.
4. Minimum allowable nominal width of CMU wall shall be 8". The minimum allowable member thickness shall be no less than 1 1/2 times the actual anchor embedment.
5. No more than one anchor shall be permitted per masonry cell.
6. Anchors shall be permitted to be installed at any location in the face of the fully grouted masonry wall construction (cell, web, bed joint), except anchors shall not be installed within 1 1/2" of the head joint, as show in Figure 2 on p. 51.
7. Tabulated allowable load values are for anchors installed in fully grouted masonry walls.
8. Tabulated allowable loads are based on a safety factor of 5.0.
9. Tabulated allowable load values shall be adjusted for increased base material temperatures in accordance with Figure 1 below, as applicable.
10. Threaded rod and rebar installed in fully grouted masonry walls with ET-HP® are permitted to resist dead, live, seismic and wind loads.
11. Threaded rod shall meet or exceed the tensile strength of ASTM F1554, Grade 36 steel, which is 58,000 psi.
12. For installations exposed to severe, moderate or negligible exterior weathering conditions, as defined in Figure 1 of ASTM C62, allowable tension loads shall be multiplied by 0.80.

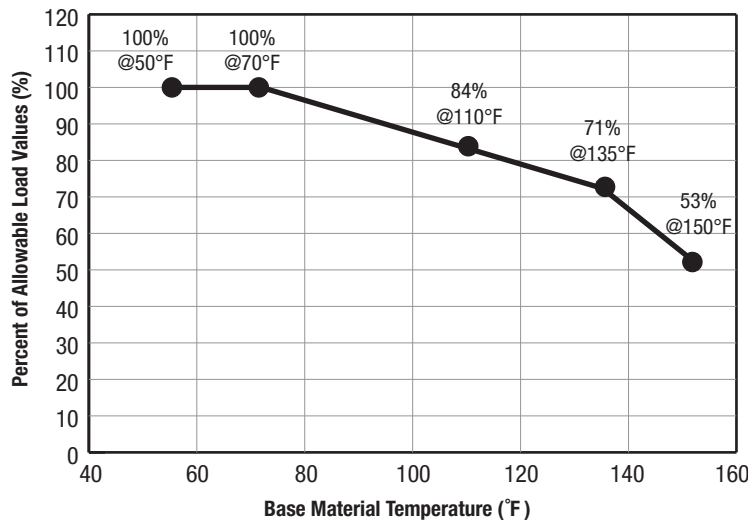
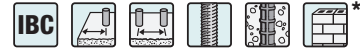

Figure 1. Load Capacity Based on In-Service Temperature for ET-HP Epoxy Adhesive in the Face of Fully Grouted CMU Wall Construction

* See p. 12 for an explanation of the load table icons.

ET-HP® Design Information — Masonry

ET-HP Edge Distance and Spacing Requirements and Allowable Load Reduction Factors — Threaded Rod and Rebar in the Face of Fully Grouted CMU Wall Construction^{2,7}



Adhesive Anchors

Rod Dia. (in.) or Rebar Size No.	Minimum Embed. Depth (in.)	Edge or End Distance ^{1,8}						Spacing ^{2,9}				
		Critical (Full Anchor Capacity) ³		Minimum (Reduced Anchor Capacity) ⁴				Critical (Full Anchor Capacity) ⁵		Minimum (Reduced Anchor Capacity) ⁶		
		Critical Edge or End Distance, C_{cr} (in.)	Allowable Load Reduction Factor	Minimum Edge or End Distance, C_{min} (in.)	Allowable Load Reduction Factor		Critical Spacing, S_{cr} (in.)	Allowable Load Reduction Factor	Minimum Spacing, S_{min} (in.)	Allowable Load Reduction Factor		
		Load Direction		Load Direction				Load Direction		Load Direction		
		Tension or Shear	Tension or Shear	Tension or Shear	Tension	Shear ¹⁰		Tension or Shear	Tension or Shear	Tension or Shear	Tension	Shear
					Perp.	Parallel						
¾	3¾	12	1.00	4	0.76	1.00	1.00	8	1.00	4	0.47	0.94
½	4½	12	1.00	4	1.00	0.92	0.9	8	1.00	4	0.60	0.96
¾	5¾	12	1.00	4	1.00	0.55	0.86	8	1.00	4	0.72	0.98
¾	6¾	12	1.00	4	1.00	0.55	0.86	8	1.00	4	0.85	1.00
#3	3¾	12	1.00	4	0.96	0.86	1.00	8	1.00	4	0.37	0.92
#4	4½	12	1.00	4	1.00	0.71	1.00	8	1.00	4	0.69	0.96
#5	5¾	12	1.00	4	1.00	0.71	1.00	8	1.00	4	1.00	1.00

- Edge distance (C_{cr} or C_{min}) is the distance measured from anchor centerline to edge or end of CMU masonry wall. Refer to Figure 2 below for an illustration showing critical and minimum edge and end distances.
- Anchor spacing (S_{cr} or S_{min}) is the distance measured from centerline to centerline of two anchors.
- Critical edge distance, C_{cr} , is the least edge distance at which tabulated allowable load of an anchor is achieved where a load reduction factor equals 1.0 (no load reduction).
- Minimum edge distance, C_{min} , is the least edge distance where an anchor has an allowable load capacity which shall be determined by multiplying the allowable loads assigned to anchors installed at critical edge distance, C_{cr} , by the load reduction factors shown above.
- Critical spacing, S_{cr} , is the least anchor spacing at which tabulated allowable load of an anchor is achieved such that anchor performance is not influenced by adjacent anchors.
- Minimum spacing, S_{min} , is the least spacing where an anchors has an allowable load capacity, which shall be determined by multiplying the allowable loads assigned to anchors installed at critical spacing distance, S_{cr} , by the load reduction factors shown above.
- Reduction factors are cumulative. Multiple reduction factors for more than one spacing or edge or end distance shall be calculated separately and multiplied.
- Load reduction factor for anchors loaded in tension or shear with edge distances between critical and minimum shall be obtained by linear interpolation.
- Load reduction factor for anchors loaded in tension with spacing between critical and minimum shall be obtained by linear interpolation.
- Perpendicular shear loads act towards the edge or end. Parallel shear loads act parallel to the edge or end (see Figure 3 below). Perpendicular and parallel shear load reduction factors are cumulative when the anchor is located between the critical minimum edge and end distance.

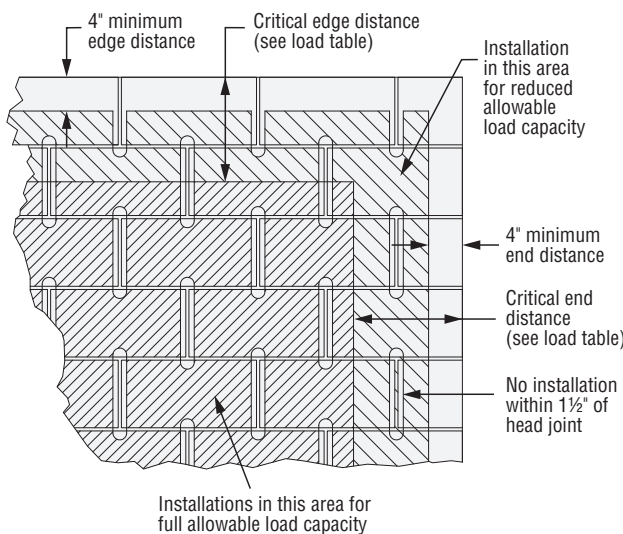

Figure 2. Allowable Anchor Placement in Grouted CMU Face Shell

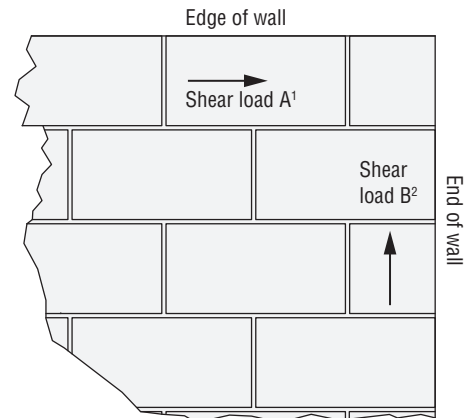

Figure 3. Direction of Shear Load in Relation to Edge and End of Wall

- Direction of Shear Load A is parallel to edge of wall and perpendicular to end of wall.
- Direction of Shear Load B is parallel to end of wall and perpendicular to edge of wall.

* See p. 12 for an explanation of the load table icons.

ET-HP® Design Information — Steel

ET-HP Allowable Tension and Shear Loads — Threaded Rod Based on Steel Strength¹

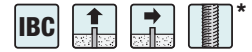

Threaded Rod Diameter (in.)	Tensile Stress Area (in. ²)	Tension Load Based on Steel Strength ² (lb.)				Shear Load Based on Steel Strength ³ (lb.)			
		ASTM F1554 Grade 36 ⁴	ASTM A193 Grade B7 ⁶	Stainless Steel		ASTM F1554 Grade 36 ⁴	ASTMA 193 Grade B7 ⁶	Stainless Steel	
				ASTM A193 Grade B6 ⁵	ASTM A193 Grades B8 and B8M ⁷			ASTM A193 Grade B6 ⁵	ASTM A193 Grades B8 and B8M ⁷
3/8	0.078	1,495	3,220	2,830	1,930	770	1,660	1,460	995
1/2	0.142	2,720	5,860	5,155	3,515	1,400	3,020	2,655	1,810
5/8	0.226	4,325	9,325	8,205	5,595	2,230	4,805	4,225	2,880
3/4	0.334	6,395	13,780	12,125	8,265	3,295	7,100	6,245	4,260

1. Allowable load shall be the lesser of bond values given on p. 50 and steel values in the table above.
2. Allowable Tension Steel Strength is based on the following equation: $F_v = 0.33 \times F_u \times \text{Tensile Stress Area}$.
3. Allowable Shear Steel Strength is based on the following equation: $F_v = 0.17 \times F_u \times \text{Tensile Stress Area}$.
4. Minimum specified tensile strength ($F_u = 58,000$ psi) of ASTM F1554, Grade 36 used to calculate allowable steel strength.
5. Minimum specified tensile strength ($F_u = 110,000$ psi) of ASTM A193, Grade B6 used to calculate allowable steel strength.
6. Minimum specified tensile strength ($F_u = 125,000$ psi) of ASTM A193, Grade B7 used to calculate allowable steel strength.
7. Minimum specified tensile strength ($F_u = 75,000$ psi) of ASTM A193, Grades B8 and B8M used to calculate allowable steel strength.

ET-HP Allowable Tension and Shear Loads — Deformed Reinforcing Bar Based on Steel Strength¹



Rebar Size	Tensile Stress Area (in. ²)	Tension Load (lb.)		Shear Load (lb.)	
		Based on Steel Strength		Based on Steel Strength	
		ASTM A615 Grade 40 ²	ASTM A615 Grade 60 ³	ASTM A615 Grade 40 ^{4,5}	ASTM A615 Grade 60 ^{4,6}
#3	0.11	2,200	2,640	1,310	1,685
#4	0.20	4,000	4,800	2,380	3,060
#5	0.31	6,200	7,440	3,690	4,745

1. Allowable load shall be the lesser of bond values given on p. 50 and steel values in the table above.
2. Allowable Tension Steel Strength is based on AC58 Section 3.3.3 (20,000 psi x tensile stress area) for Grade 40 rebar.
3. Allowable Tension Steel Strength is based on AC58 Section 3.3.3 (24,000 psi x tensile stress area) for Grade 60 rebar.
4. Allowable Shear Steel Strength is based on AC58 Section 3.3.3 ($F_v = 0.17 \times F_u \times \text{Tensile Stress Area}$).
5. $F_u = 70,000$ psi for Grade 40 rebar.
6. $F_u = 90,000$ psi for Grade 60 rebar.

* See p. 12 for an explanation of the load table icons.

ET-HP® Design Information — Masonry

ET-HP Allowable Tension and Shear Loads for Installations in Unreinforced Brick Masonry Walls — Minimum URM Wall Thickness is 13" (3 wythes thick)



Rod Dia. in. (mm)	Drill Bit Dia. in.	Embed. Depth in. (mm)	Min. Wall Thickness in. (mm)	Min. Edge/End Dist. in. (mm)	Min. Vertical Spacing Dist. in. (mm)	Min. Horiz. Spacing Dist. in. (mm)	Tension Load Based on URM Strength		Shear Load Based on URM Strength	
							Minimum Net Mortar Strength = 50 psi		Minimum Net Mortar Strength = 50 psi	
							Allowable lb. (kN)		Allowable lb. (kN)	
Configuration A (Simpson Strong-Tie® ETS Screen Tube Required)										
3/4 (19.1)	1	8 (203)	13 (330)	24 (610)	18 (457)	18 (457)	—		1,000 (4.4)	
Configuration B (Simpson Strong-Tie® ETS Screen Tube Required)										
3/4 (19.1)	1	Within 1" of opposite wall surface	13 (330)	16 (406)	18 (457)	24 (610)	1,200 (5.3)		1,000 (4.4)	

1. Threaded rods must comply with ASTM F1554 Grade 36 minimum.
2. All holes are drilled with a 1"-diameter carbide-tipped drill bit with the drill set in the rotation-only mode.
3. The unreinforced brick walls must have a minimum thickness of 13" (three wythes of brick).
4. The allowable load is applicable only where in-place shear tests indicate minimum net mortar strength of 50 psi.
5. The allowable load for Configuration B anchor subjected to a combined tension and shear load is determined by assuming a straight-line relationship between allowable tension and shear.
6. The anchors installed in unreinforced brick walls are limited to resisting seismic or wind forces only.
7. Configuration A has a straight threaded rod or rebar embedded 8" into the wall with a 3/8"-diameter by 8"-long screen tube (part # ETS758). This configuration is designed to resist shear loads only.
8. Configuration B has a 3/4" threaded rod bent and installed at a 22.5-degree angle and installed 13" into the wall, to within 1" (maximum) of the exterior wall surface. This configuration is designed to resist tension and shear loads. The pre-bent threaded rod is installed with a 3/8" diameter by 13"-long screen tube (part # ETS7513).
9. Special inspection requirements are determined by local jurisdiction and must be confirmed by the local building official.
10. Refer to in-service temperature sensitivity chart for allowable load adjustment for temperature.

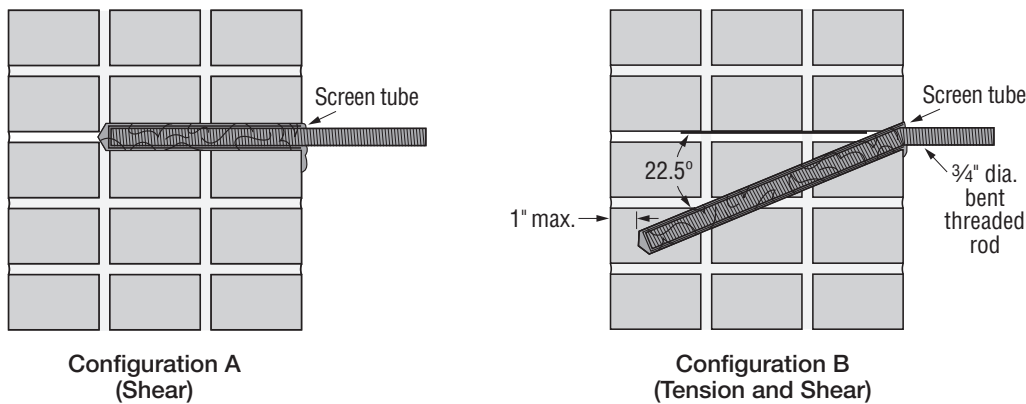

* See p. 12 for an explanation of the load table icons.