

Set-up Instructions

1982, 1983 Models ATC 200E



AMERICAN HONDA MOTOR CO., INC.
100 WEST ALONDRA BOULEVARD, GARDENA, CALIFORNIA 90247

AUG: 1 7 1982

WARNING

WARNING

WARNING

WARNING

SET-UP AND PRE-DELIVERY SERVICE MUST BE PERFORMED BY AN AUTHORIZED HONDA MOTORCYCLE DEALER. Proper set-up and pre-delivery service is essential to rider safety and reliability of the ATC. When a customer takes delivery of his brand new ATC, he expects it to be in excellent running condition. There are few things that will cause greater customer dissatisfaction than poor preparation of a new unit. An error or oversight made by the mechanic assembling and servicing a new unit can easily result in faulty operation, damage to the machine, or even injury to the rider.

THIS ISSUE OF THE ATC 200E SET-UP INSTRUCTIONS REPLACES THE 1982 MODEL ATC 200E SET-UP INSTRUCTIONS DATED 1/82 REMOVE AND DESTROY SUPERSEDED SET-UP INSTRUCTIONS.

1983 MODEL SHOWN; 1982 MODEL SIMILAR

COPY



NOTES:

- All steps apply to both the 1982 and 1983 models unless otherwise noted.
- Right and left are determined from the rider's view.

Date of Issue: 8/82

© American Honda Motor Co., Inc. 1982 - All Rights Reserved

1 of 30

SET-UP INSTRUCTION REVISED PAGES

Pages Affected

1 through 30

Orig. Issue Date

8/82

Rev. Date

Original

Remove and destroy superseded pages.

Pay special attention to warnings, cautions, and notes.

WARNING means hazards or unsafe practices which could cause severe personal injury or death.

CAUTION: means hazards or unsafe practices which could cause minor personal injury or product or property damage.

NOTE: gives helpful information.

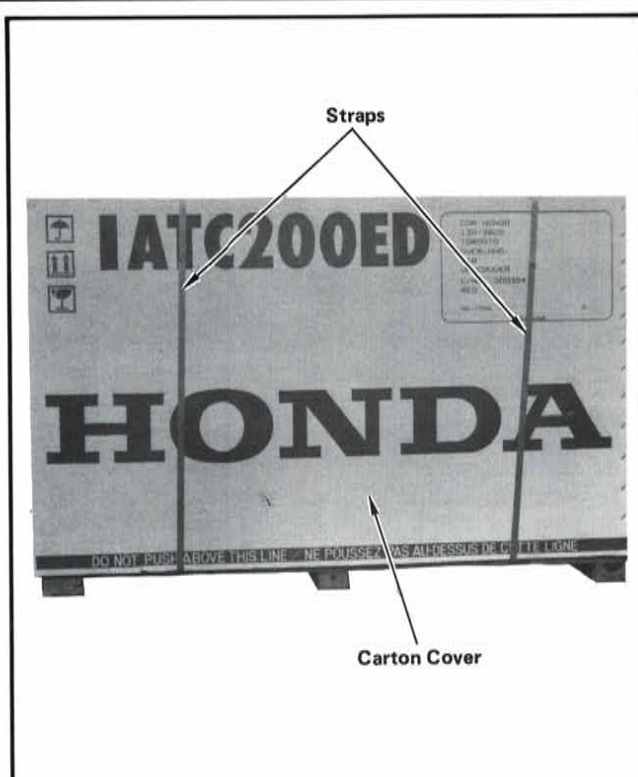

STEP 1—Cut straps and remove carton cover by lifting it up.

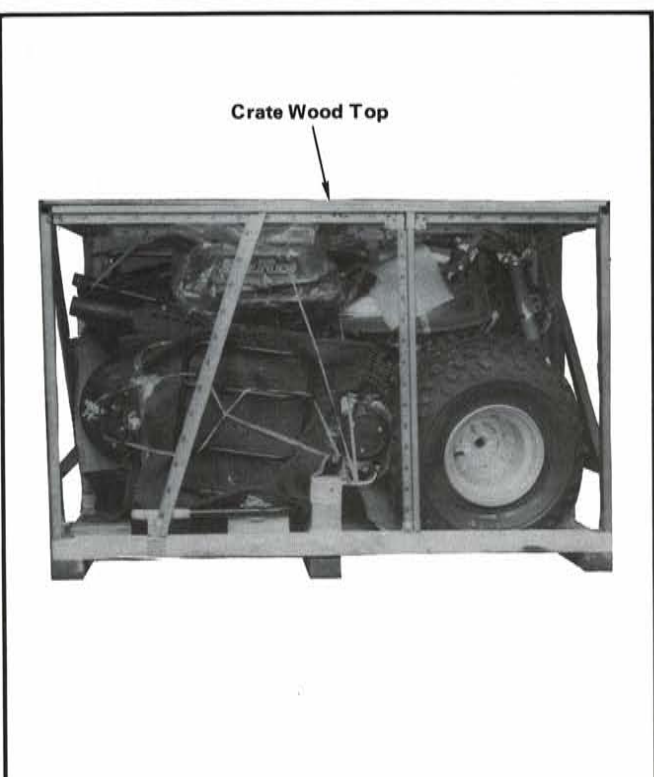

STEP 2—Remove crate wood top.

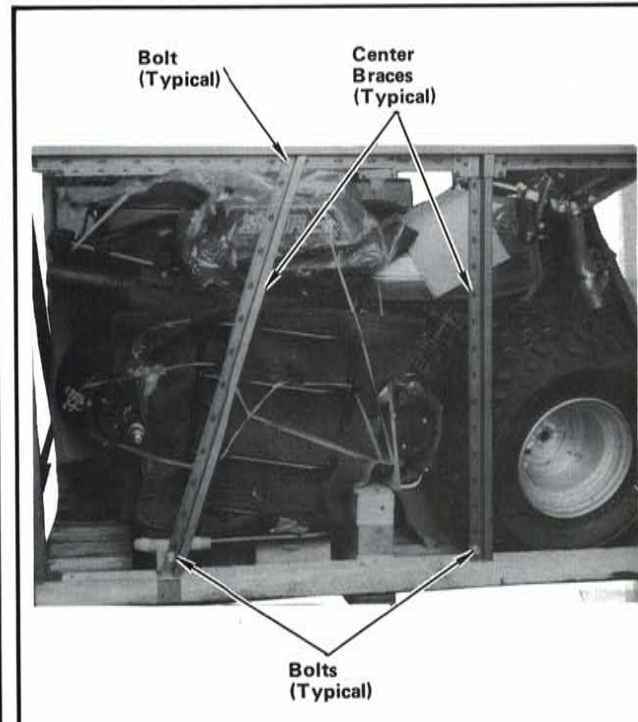

STEP 3—Remove bolts attaching center braces to crate base and crate top. Discard bolts and remove loose braces.

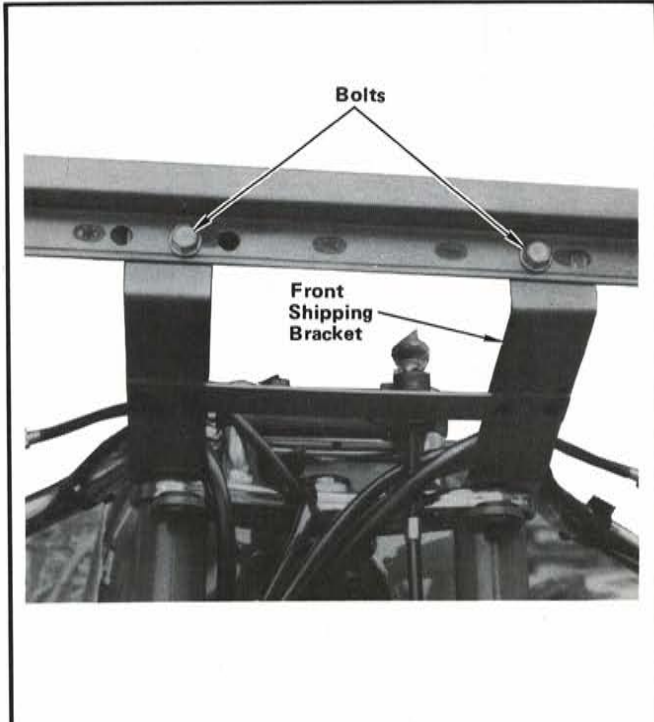

STEP 4—Remove two bolts attaching front shipping bracket to crate top. Discard bolts.

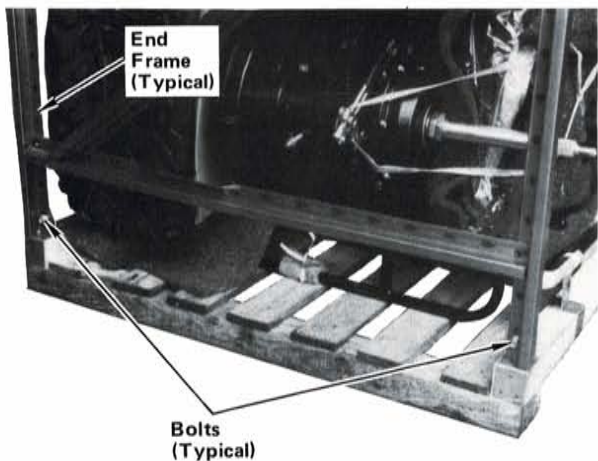

STEP 5—Remove bolts attaching front and rear end frames to crate base. Carefully lift off crate metal frame using two people. Discard crate frame and bolts.

CAUTION: Use care not to damage ATC when lifting crate frame.

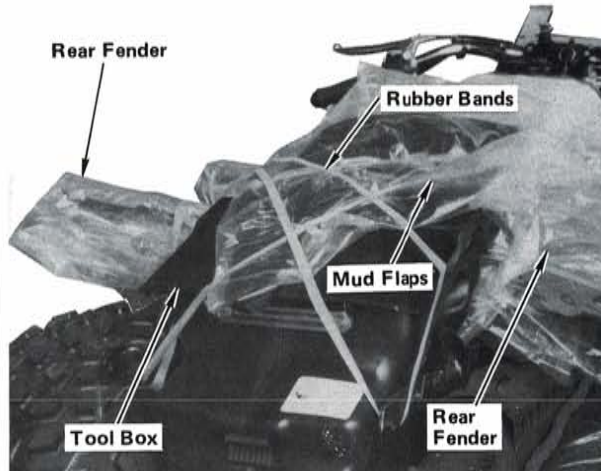

STEP 6—Remove mud flaps, tool box, rear fenders, front fender, and trailer hitch by removing rubber bands.

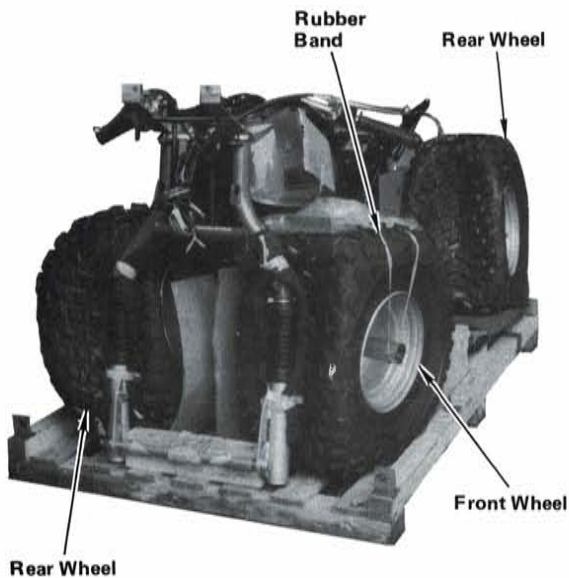

STEP 7—Remove front wheel and rear wheels by removing rubber band.

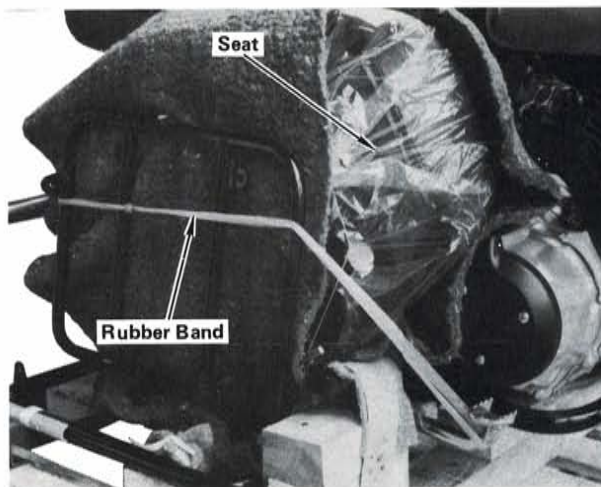

STEP 8—Remove seat and front carrier by removing rubber band.

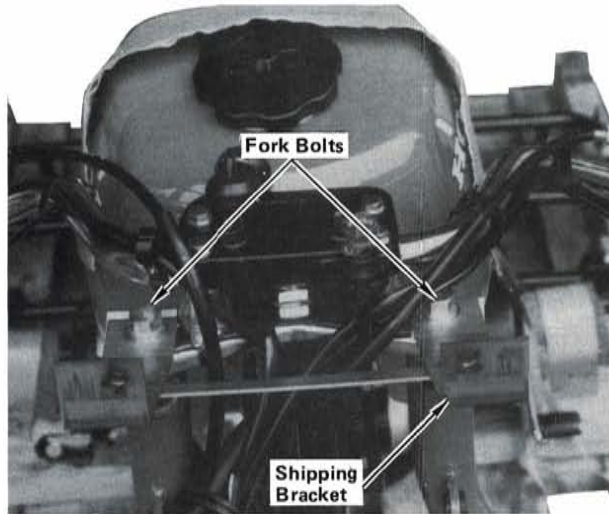

STEP 9—Loosen two fork bolts and remove shipping bracket. Retighten bolts to specified torque.

Torque specification:
6.0 kg-m (44 lb-ft)

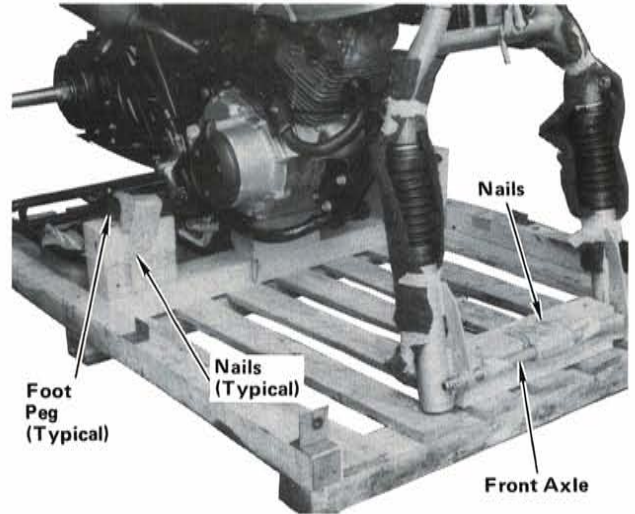

STEP 10—Remove nails and remove lower shipping retainers holding front axle and foot pegs to crate base. Discard attaching retainers.

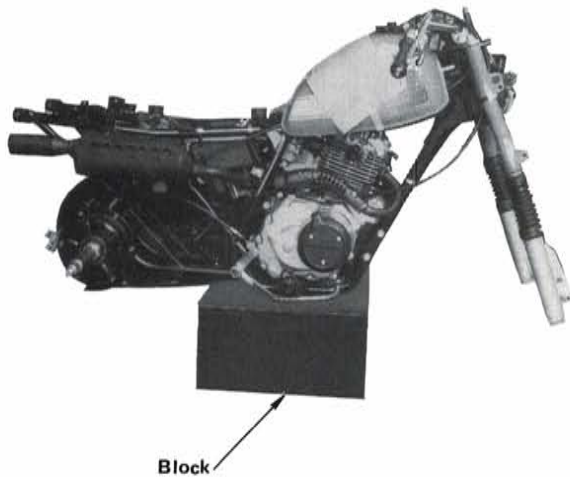

STEP 11—Carefully remove ATC from crate base using two people and support on a padded block centered under engine as shown.

CAUTION: The ATC can easily be tipped over until it is resting on front and rear wheels.

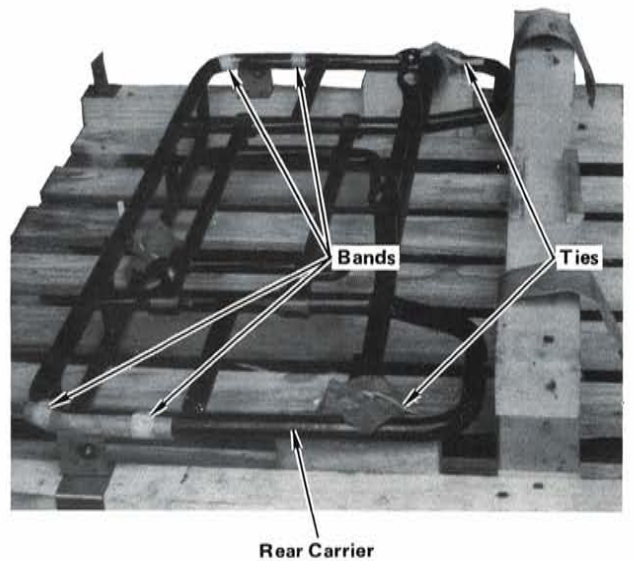

STEP 12—Remove rear carrier from crate base by removing ties and bands.



STEP 13—Unpack remaining loose parts and check against this illustration. Report any damaged or missing parts immediately to American Honda Motor Co., Inc., 100 West Alondra Blvd., Gardena, California 90247.

Damaged or Missing Parts

Identify missing parts by referring to the "Loose Parts List" at the end of the set-up. Order parts through normal parts ordering procedures.

It is necessary to differentiate between parts lost or damaged in transit, and parts left out by the factory.

- For parts lost or damaged in transit, file a SHIPPING DAMAGE CLAIM.
- For parts left out by the factory, file a WARRANTY CLAIM W.O.2.

Refer to the Warranty Policy and Procedures Manual (SO 945) under **Shipping Damage and Crate Shortage** for further information.

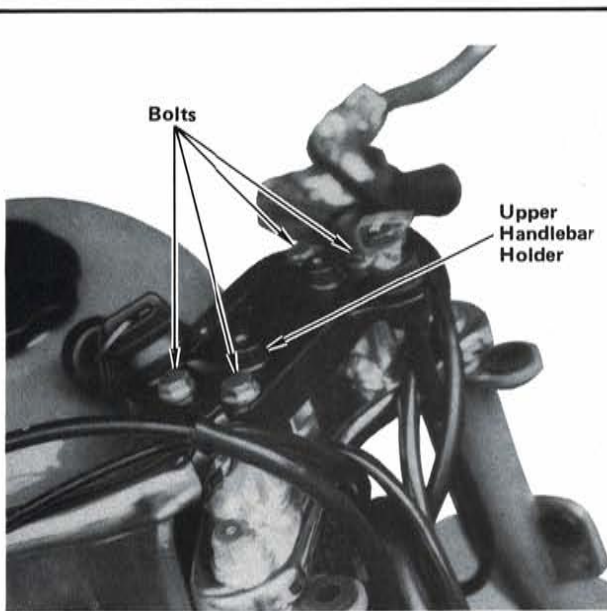

STEP 14—Loosen four bolts attaching handlebar upper holder.

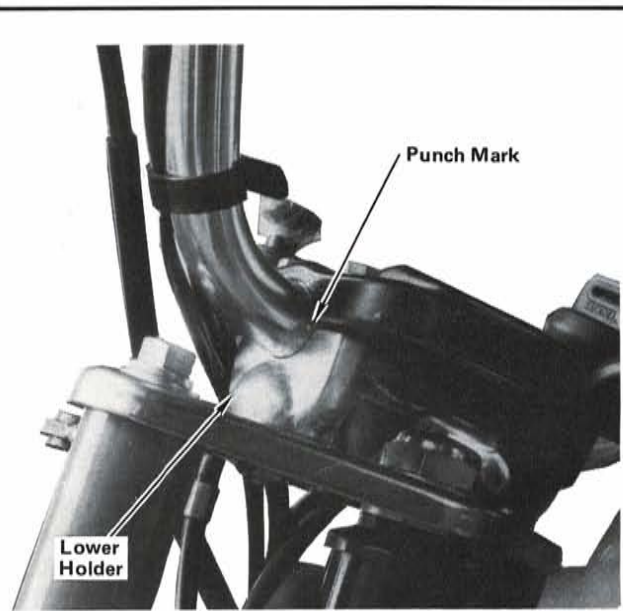

STEP 15—Lift handlebar grips up until punch mark on handlebar is aligned with top of lower holder. Tighten front bolts to specified torque first, then tighten rear bolts to same torque.

Torque specification:
1.0 kg-m (8 lb-ft)

1983 MODEL ONLY

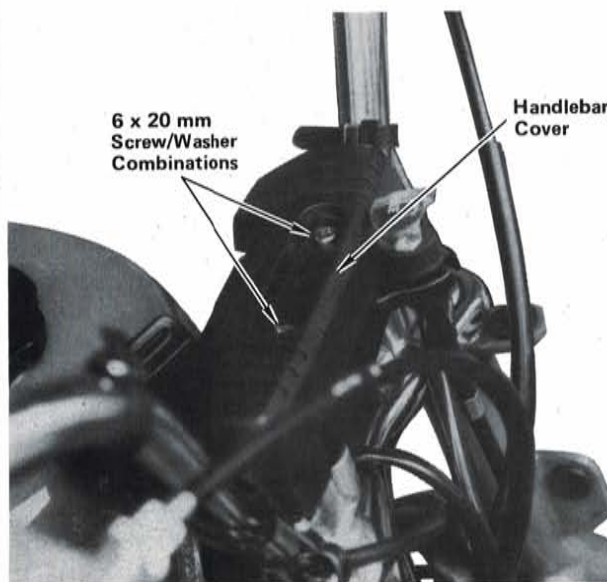

STEP 16—Install handlebar cover as shown using two 6 x 20mm screw/washer combinations. Tighten screws securely.

1983 MODEL ONLY

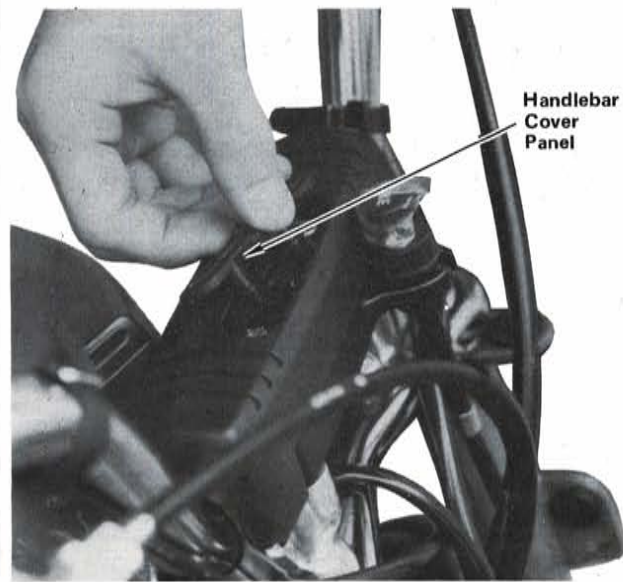

STEP 17—Install handlebar cover panel as shown.

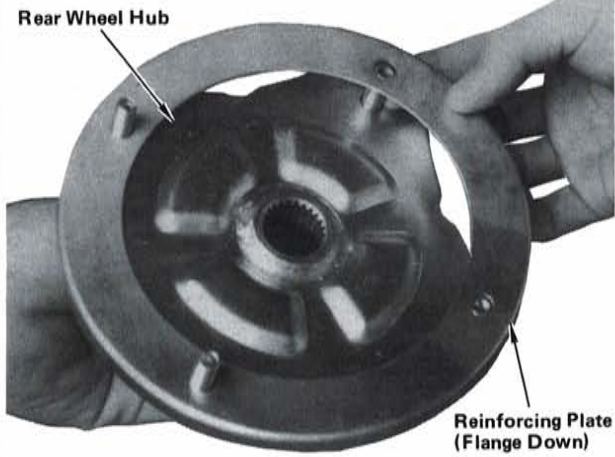

STEP 18—Slip rear wheel reinforcing plate, with flange down, over studs on rear wheel hub as shown.

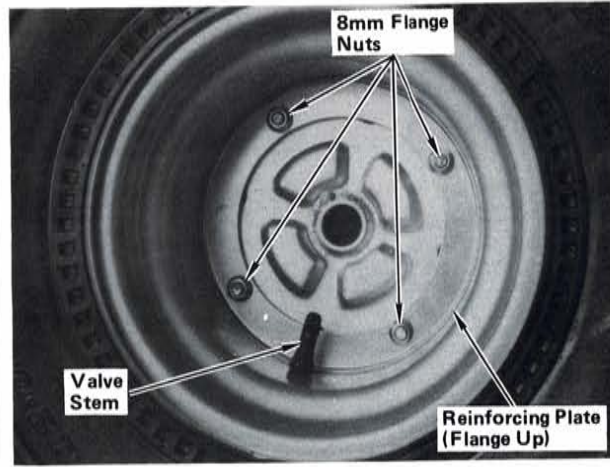

STEP 19—Insert studs of rear wheel hub through holes in rear wheel as shown and install using another reinforcing plate (flange up) and four 8mm flange nuts. Tighten nuts to specified torque. Note position of valve stem.

Torque specification:
2.2 kg-m (16 lb-ft)

Inflate and check tire pressure of all three tires.

Tire pressure: 2.2 psi.

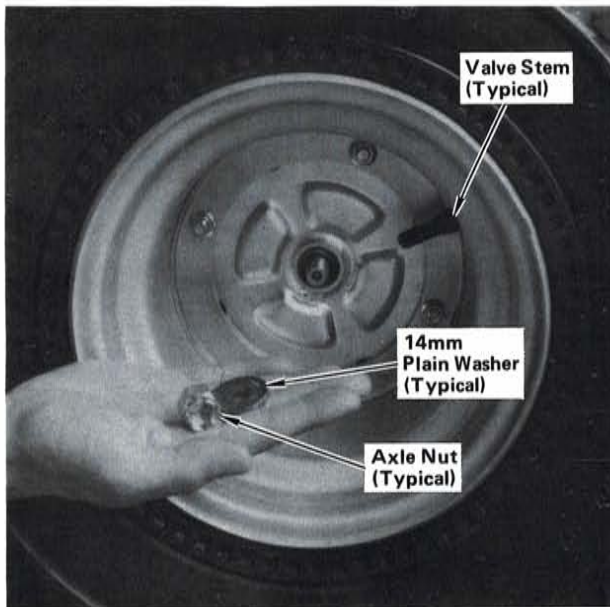

STEP 20—Grease rear axle splines and install rear wheels, with valve stems to the outside, using a 14mm plain washer and castle nut for each. Tighten both axle nuts to specified torque.

Torque specification:
7.0 kg-m (51 lb-ft)

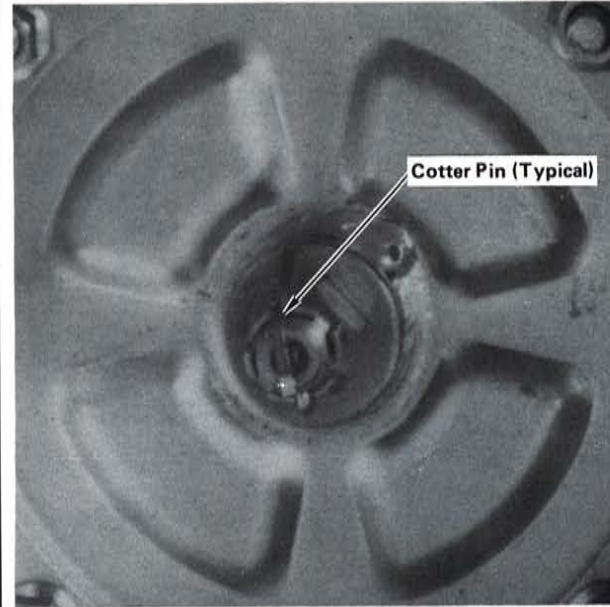

STEP 21—Install a cotter pin through each axle nut. Spread ends of cotter pins as shown.

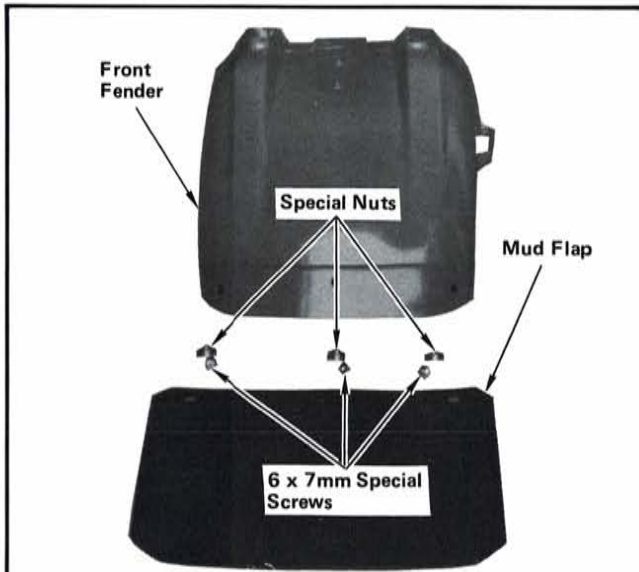

STEP 22—Check front fender, mud flap, and attaching hardware as shown. Position mud flap under front fender and install using three 6 x 7mm special screws inserted down through fender and mud flap, with special nuts up through mud flap. Position special nuts across mud flap as shown. Tighten screws securely.

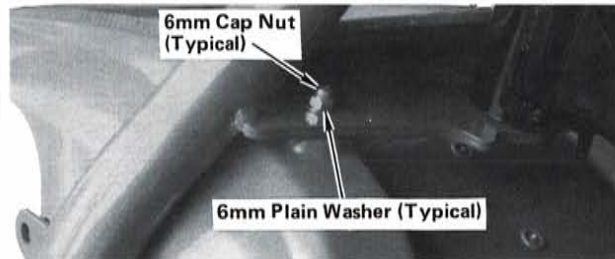
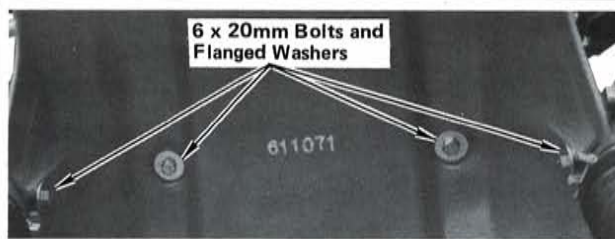

STEP 23—Position front fender between fork legs with mud flap towards rear. Install front fender using four 6 x 20mm bolts and flanged washers. Two into fork legs, and two up through fender and lower fork bridge with a 6mm cap nut and plain washer above lower fork bridge. Tighten bolts and nuts to specified torque.

Torque specification:
0.9 kg-m (6 lb-ft)

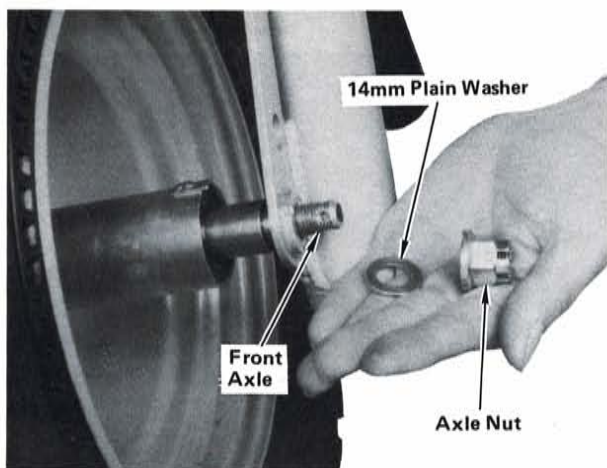

STEP 24—Position front wheel between fork legs with brake panel on right. Insert front axle from right side through fork leg, front brake panel, front wheel, collar, and left fork leg. Install 14mm plain washer and axle nut on axle. Tighten axle nut to specified torque while aligning cotter pin holes.

Torque specification:
7.0 kg-m (51 lb-ft)

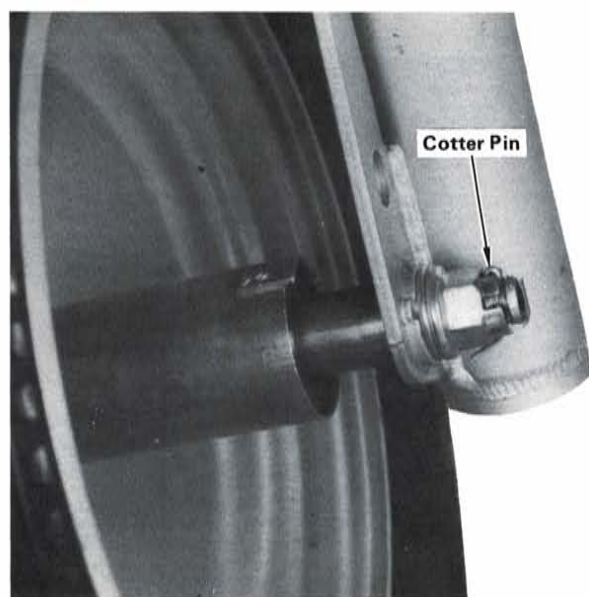

STEP 25—Insert cotter pin and spread ends of cotter pin as shown.

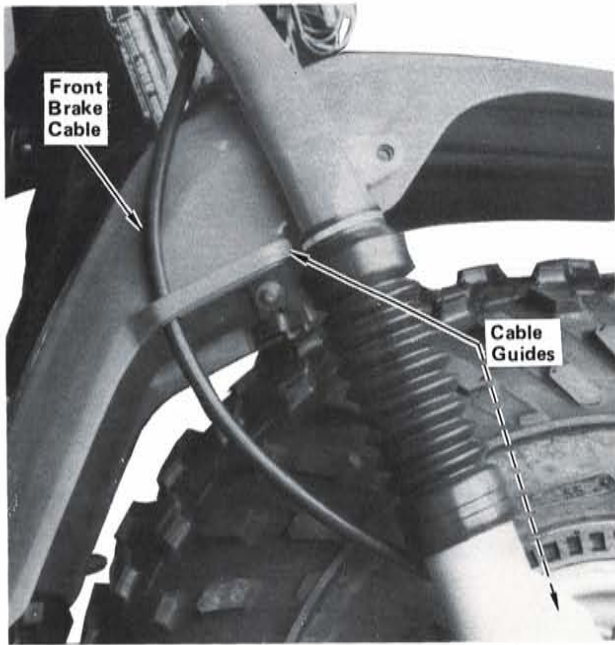

STEP 26—Route front brake cable down through cable guide on front fender and on front brake panel as shown.

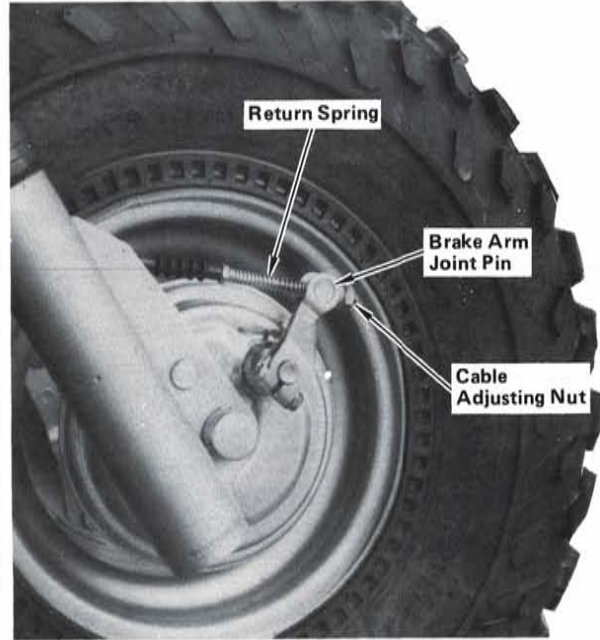

STEP 27—Slip brake return spring over end of front brake cable. Connect brake cable to brake arm using a joint pin and cable adjusting nut. Adjust front and rear brakes as described in Steps 67 through 71.

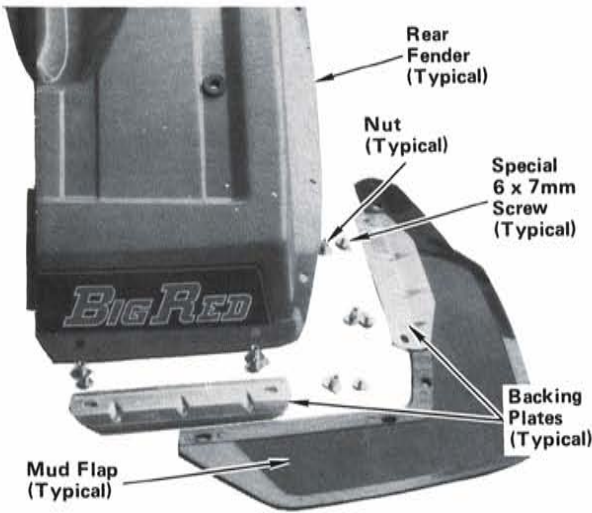

STEP 28—For each rear fender, position rear mud flap under fender and install using five 6 x 7mm special screws inserted down through fender, mud flap, backing plates, and into special 6mm nuts. (Forward screw does not go through a backing plate.) Tighten all screws securely.

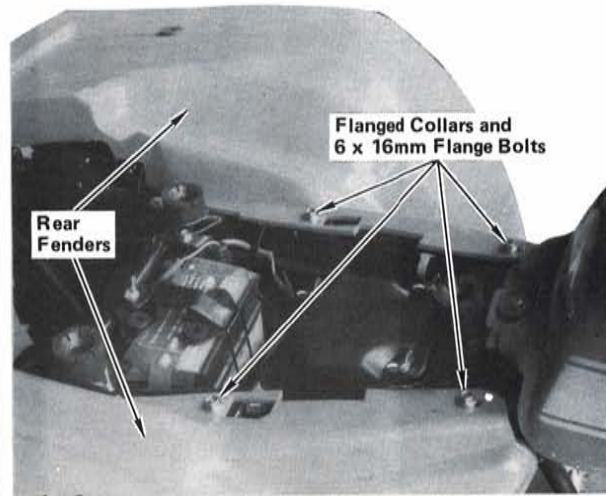

STEP 29—Install right and left rear fenders as shown using four 6 x 16mm flange bolts and flanged collars. Do not tighten bolts at this time.

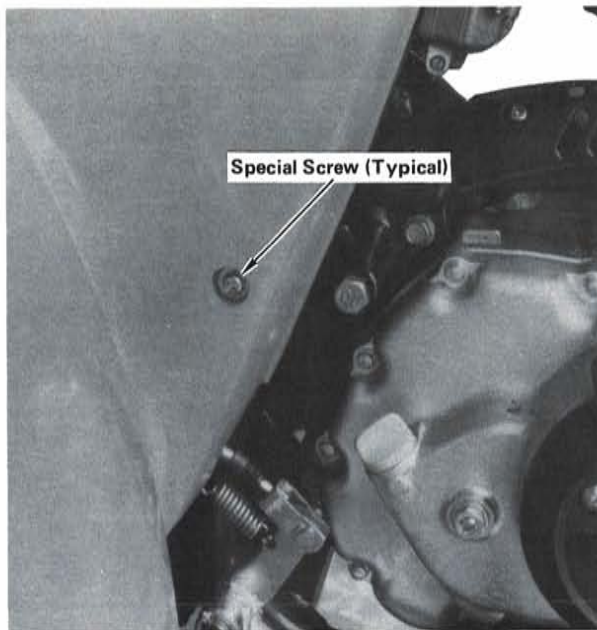

Special Screw (Typical)

STEP 30—Attach forward end of rear fenders using a special screw for each side as shown. Do not tighten screws at this time.

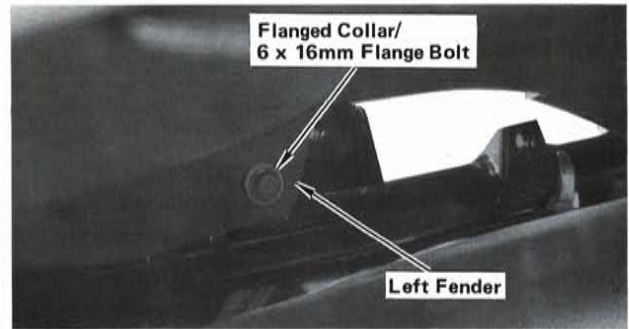

Flanged Collar/
6 x 16mm Flange Bolt

Left Fender

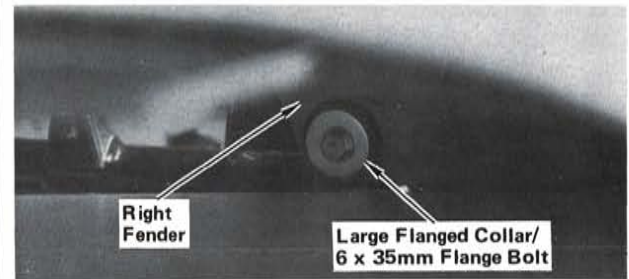

Right
Fender

Large Flanged Collar/
6 x 25mm Flange Bolt

STEP 31—Attach rear end of rear fenders using a 6 x 16mm flange bolt and flanged collar for left side and a 6 x 25mm flange bolt and large flanged collar for right side. Tighten all seat attaching bolts and screws securely.

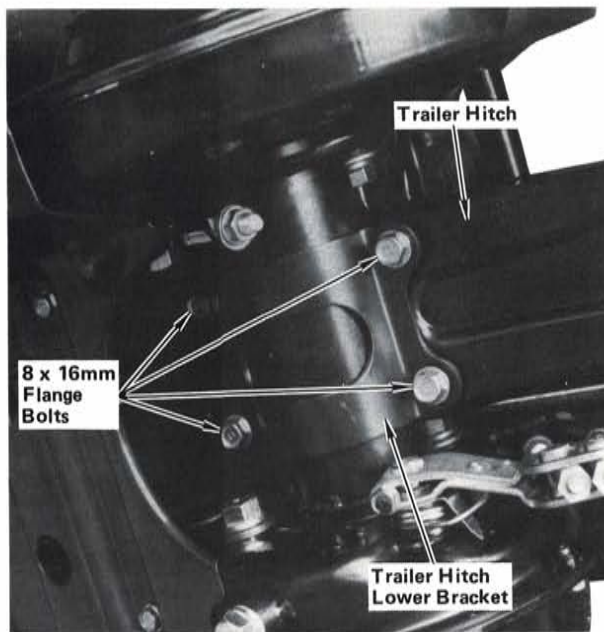

Trailer Hitch

8 x 16mm
Flange
Bolts

Trailer Hitch
Lower Bracket

STEP 32—Position trailer hitch and lower bracket on rear axle housing as shown and install using four 8 x 16mm flange bolts. Do not tighten bolts at this time.



Taillight Assy

STEP 33—Install taillight on tool box as shown using two 6 x 25mm flange bolts and flanged collars. Tighten bolts securely.

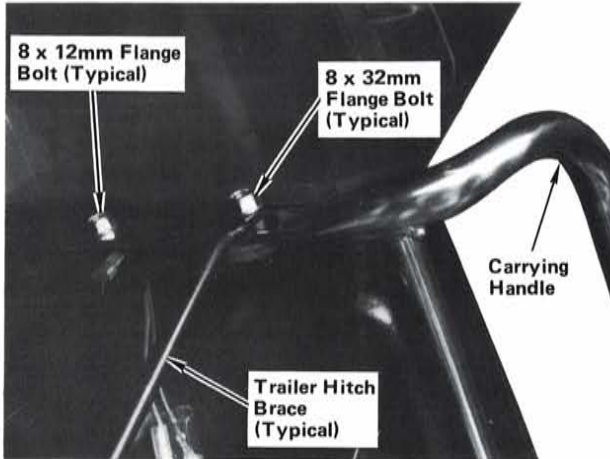

STEP 34—Position tool box between rear fenders and install carrying handle against tool box using two 8 x 12mm flange bolts through forward holes of handle. Align holes of trailer hitch braces with rear holes of handle and install using two 8 x 32mm flange bolts. Tighten bolts to specified torque.

Torque specification:
2.2 kg-m (16 lb-ft)

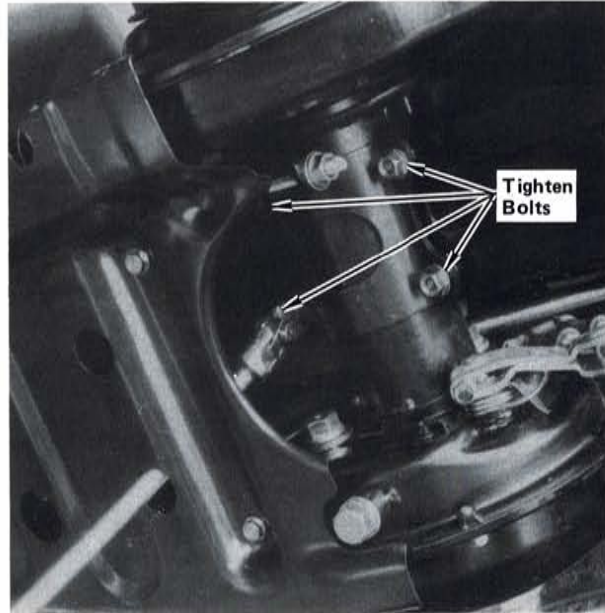

STEP 35—Tighten trailer hitch lower bolts to specified torque.

Torque specification:
2.2 kg-m (16 lb-ft)



STEP 36—Connect taillight wires to wire harness color-to-color.

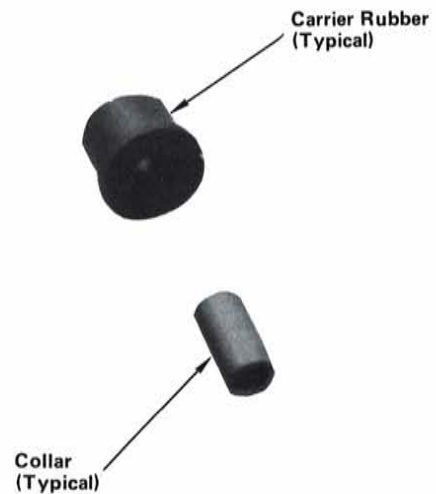

STEP 37—Insert a collar into each rear carrier rubber.



STEP 38—Insert a carrier rubber into right and left sides of rear carrier as shown.



STEP 39—Position rear carrier on frame as shown and install using an 8 x 32mm flange bolt on each side.

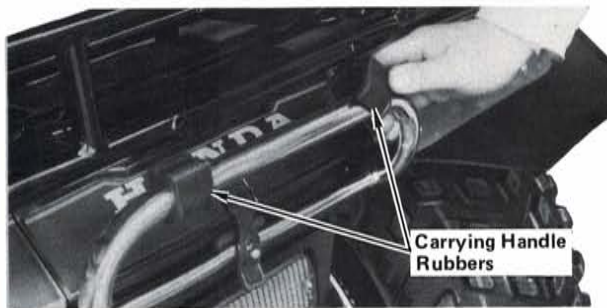

STEP 40—Install carrying handle rubbers on carrying handle as shown and slip a rear carrier bracket over each rubber as shown.

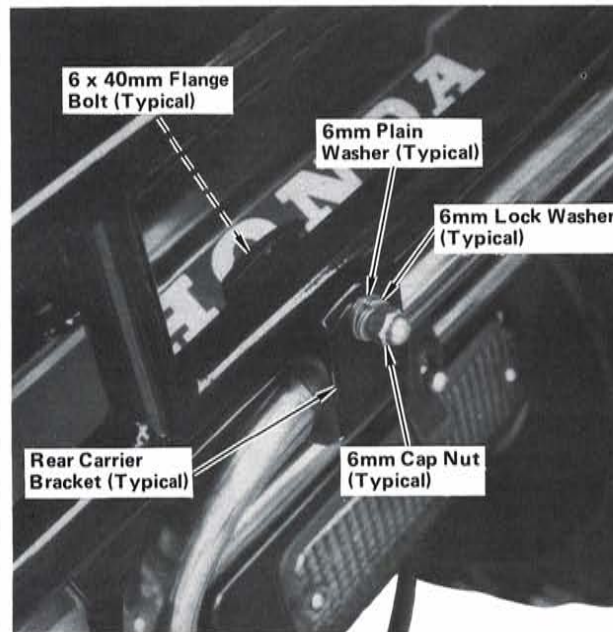

STEP 41—Attach rear carrier brackets to rear carrier as shown using a 6 x 40mm flange bolt, plain washer, lock washer, and cap nut for each. Tighten bolts securely.

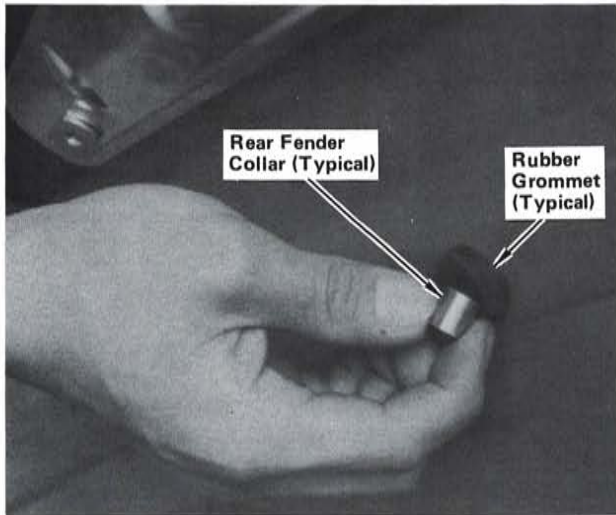

STEP 42—Insert collar up through each rubber grommet in rear fender.

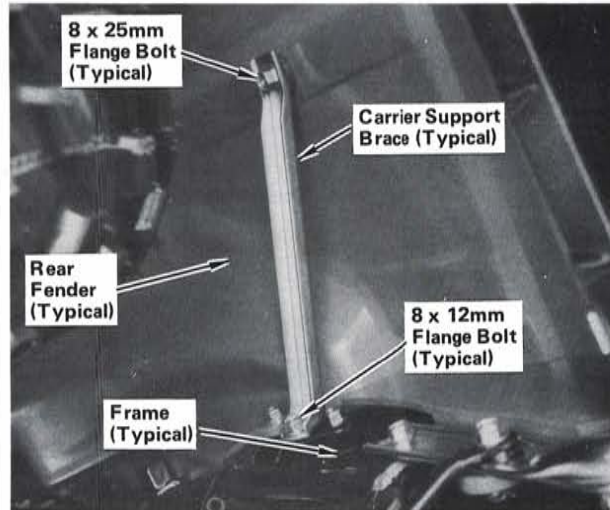

STEP 43—Position rear carrier support braces under each rear fender as shown and install using an 8 x 25mm flange bolt through upper hole and into rear carrier, and an 8 x 12mm flange bolt through lower hole into frame for each. Tighten bolts securely.

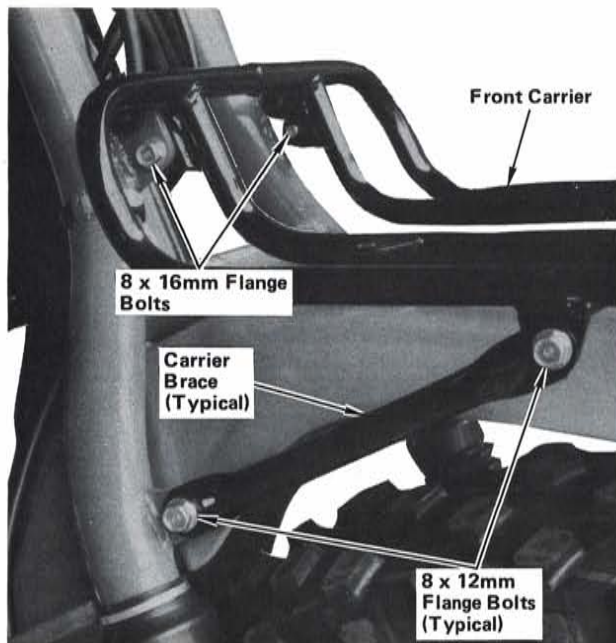

STEP 44—Position front carrier as shown and install using two 8 x 16mm flange bolts into fork tabs as shown. Install lower braces using two 8 x 12mm flange bolts for each. Tighten bolts securely.

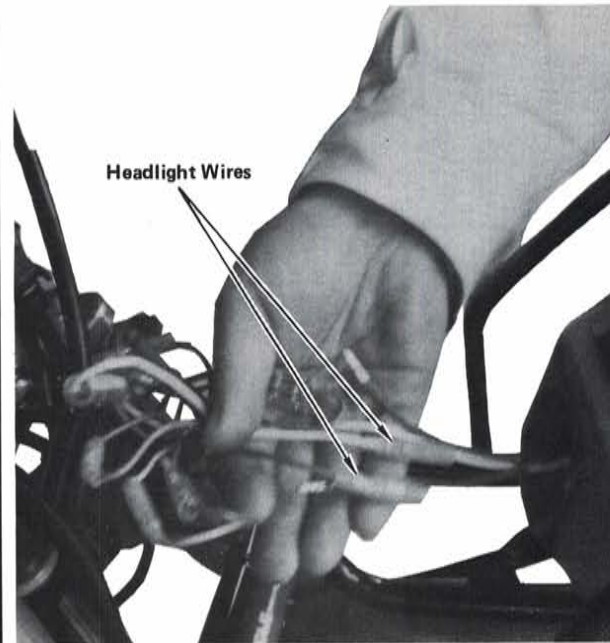

STEP 45—Connect headlight wires to wire harness color-to-color.

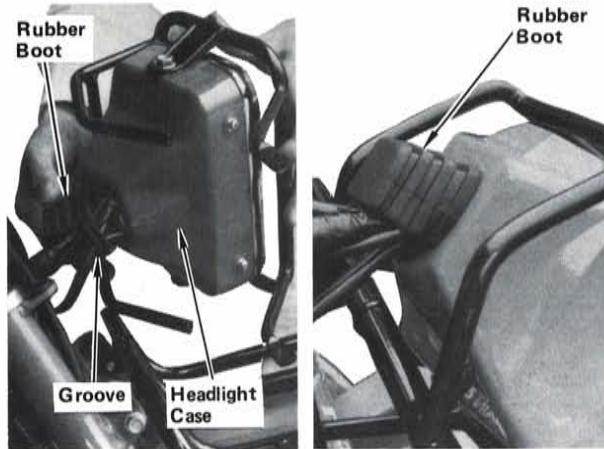

STEP 46—Insert connectors into headlight case and hook first groove of rubber boot into hole in headlight case as shown.

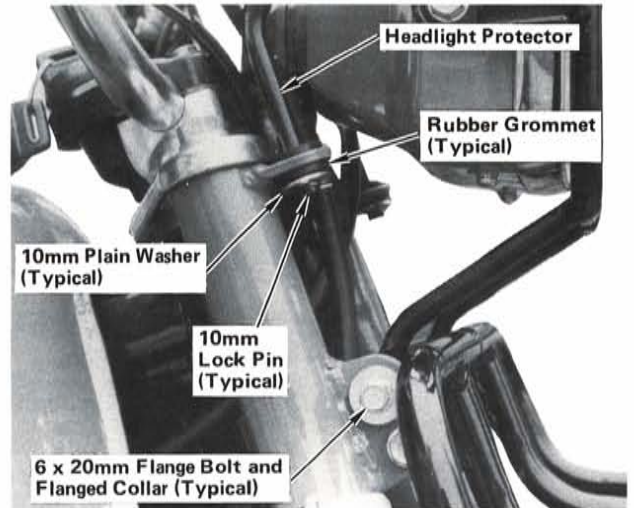

STEP 47—Insert upper arms of headlight protector down through rubber grommets as shown and install using a 10mm plain washer and lock pin for each arm. Attach lower arms of protector using a 6 x 20mm flange bolt and flanged collar for each. Tighten bolts securely.

1983 MODEL ONLY

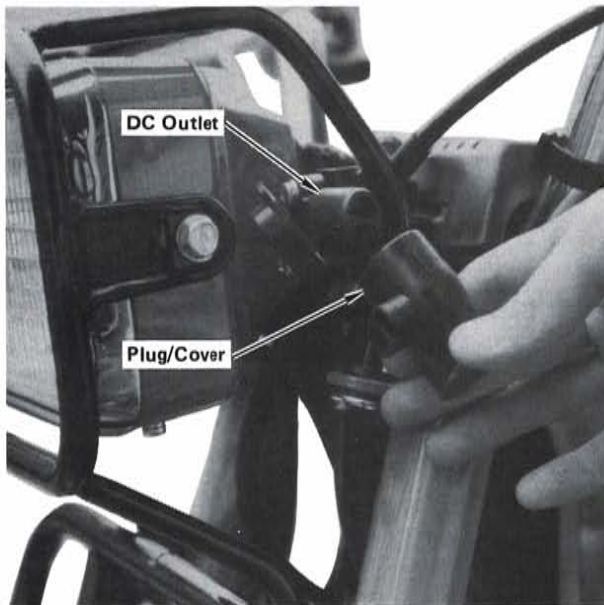

STEP 48—Insert plug into DC outlet.

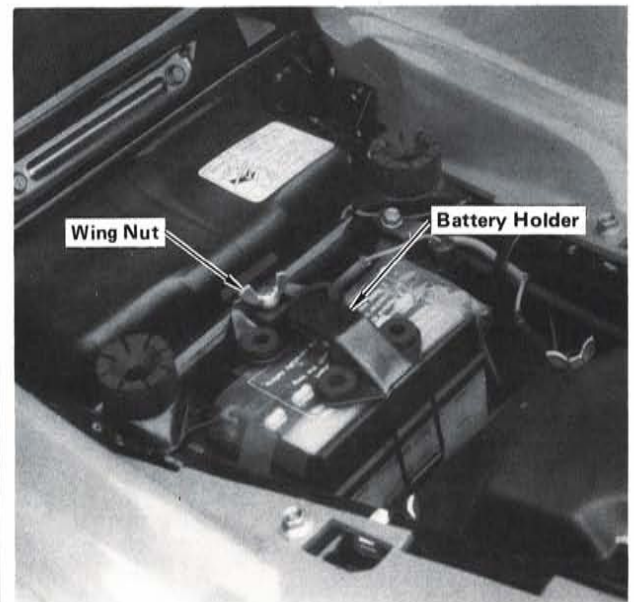

STEP 49—Remove battery holder by loosening wing nut. Remove battery.

1982 MODEL ONLY

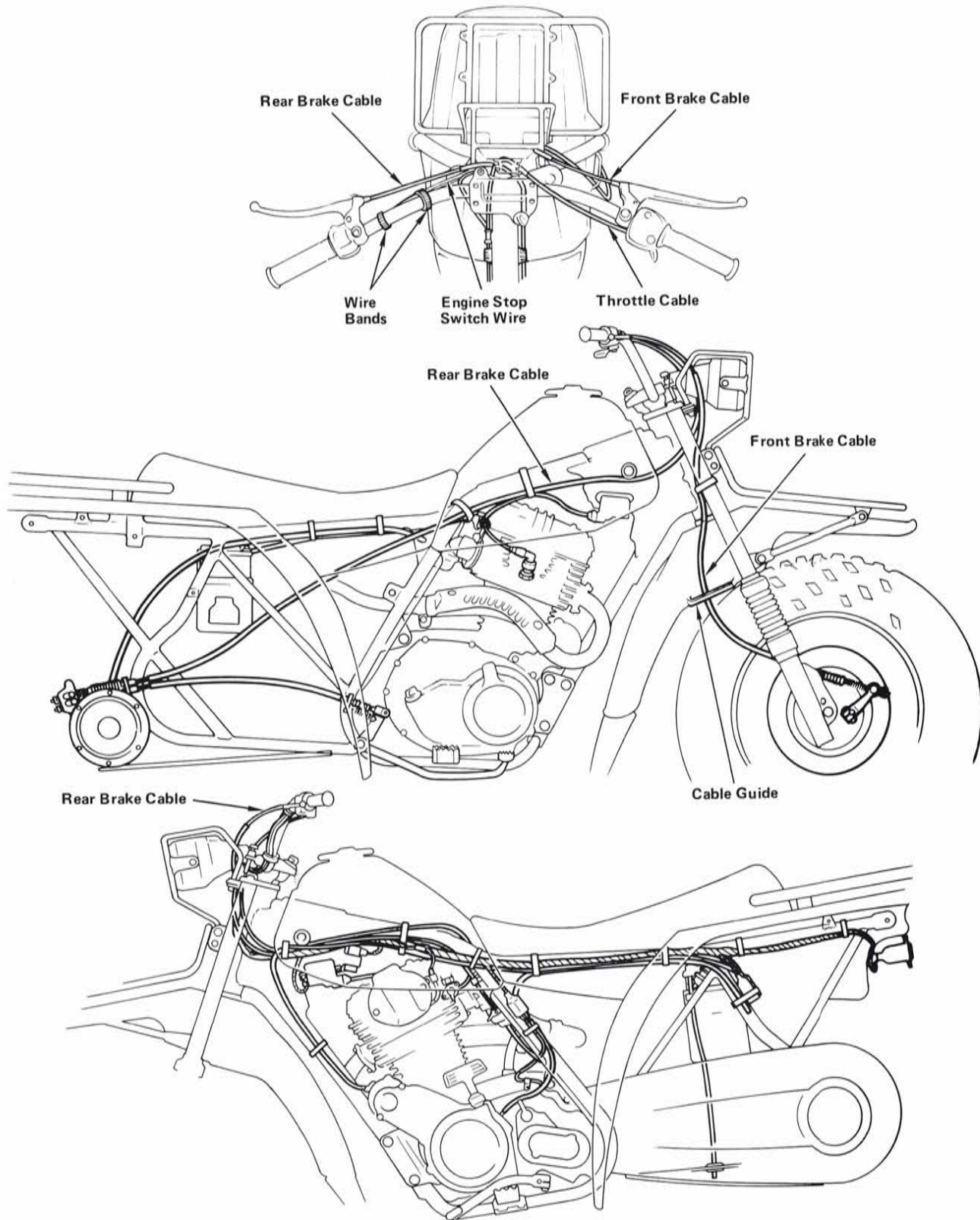

STEP 50—Check routing of front and rear brake cables, throttle cable, engine stop switch wire, and headlight switch wire as shown.

1983 MODEL ONLY

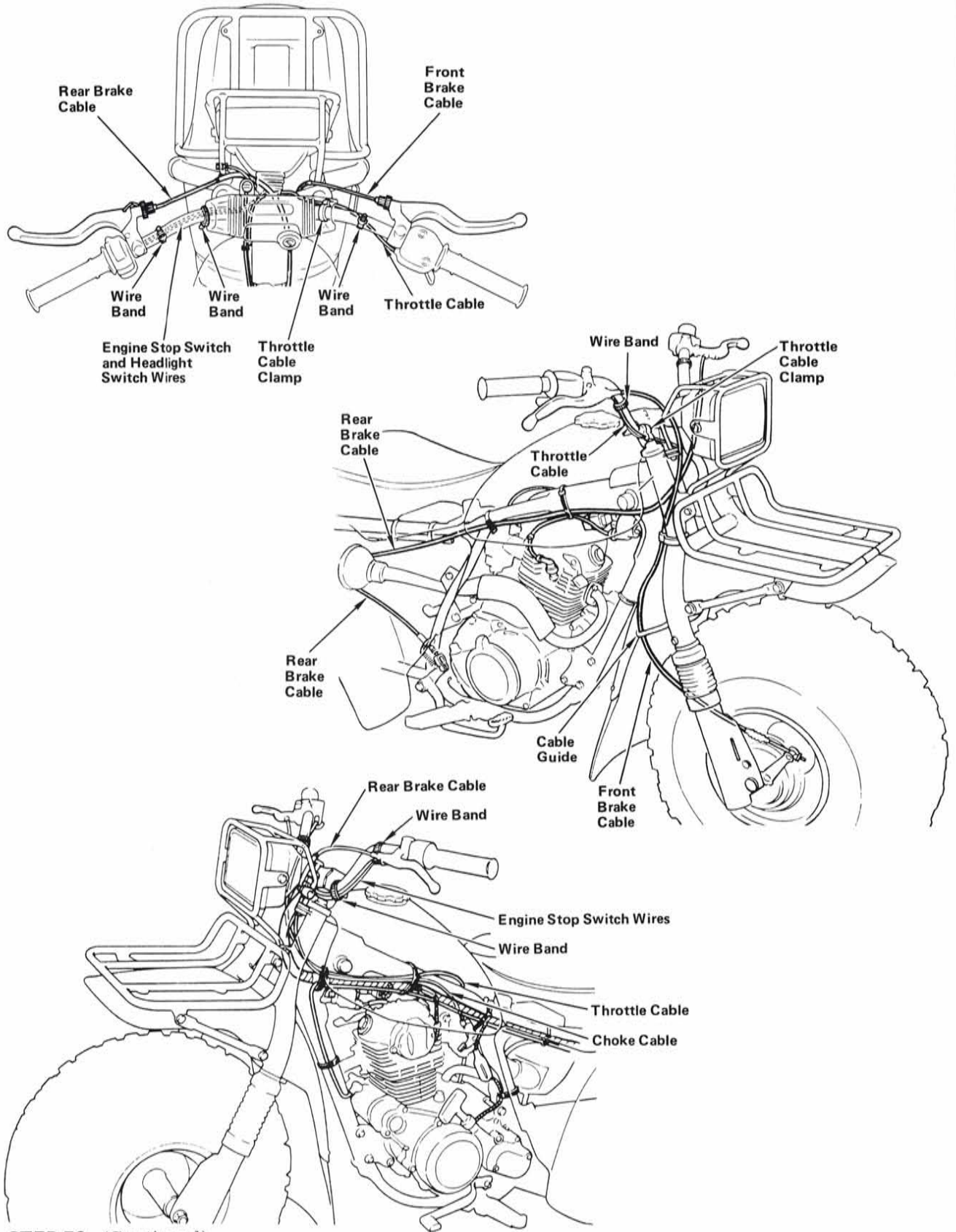

STEP 50—(Continued).

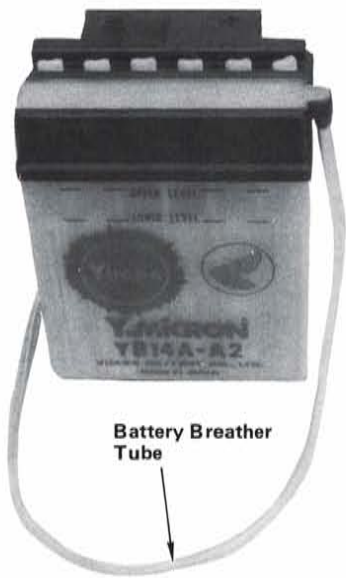

Battery Breather Tube

STEP 51—Service battery as described in shop manual or battery preparation booklet packed with battery. Attach battery breather tube.

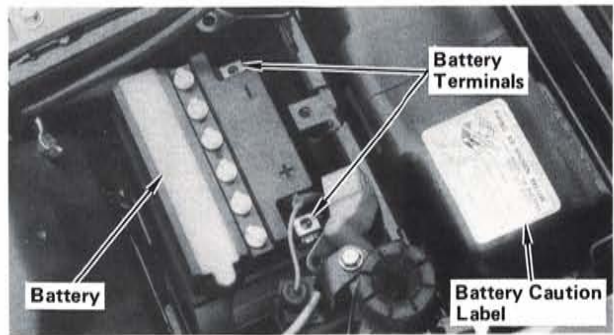

Battery

Battery Terminals

Battery Caution Label

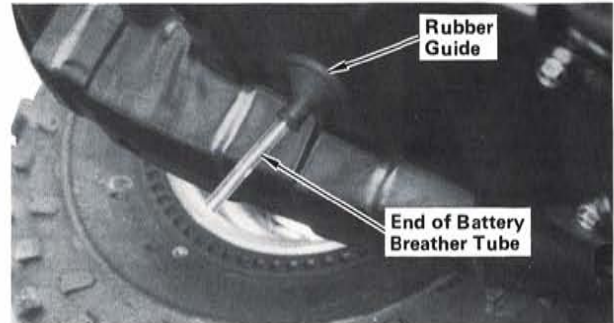

Rubber Guide

End of Battery Breather Tube

STEP 52—Place battery into battery compartment with terminals facing the rear, while routing battery breather tube through rubber guide on bottom of frame as shown.

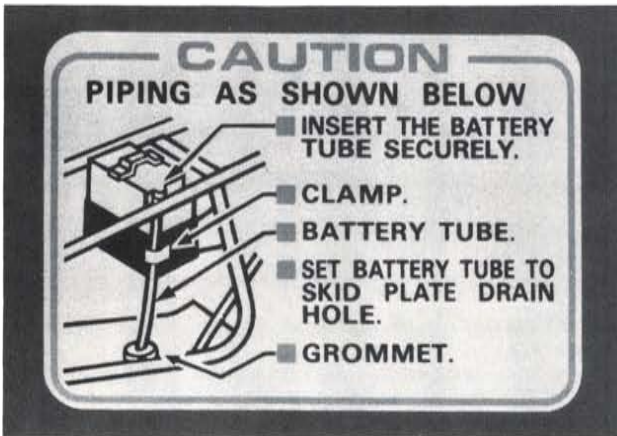

CAUTION
PIPING AS SHOWN BELOW

- INSERT THE BATTERY TUBE SECURELY.
- CLAMP.
- BATTERY TUBE.
- SET BATTERY TUBE TO SKID PLATE DRAIN HOLE.
- GROMMET.

STEP 53—Check routing of battery breather tube as shown in battery caution label located on the frame.

CAUTION: Check that battery breather tube is not kinked, twisted, or pinched. Otherwise battery may be damaged.

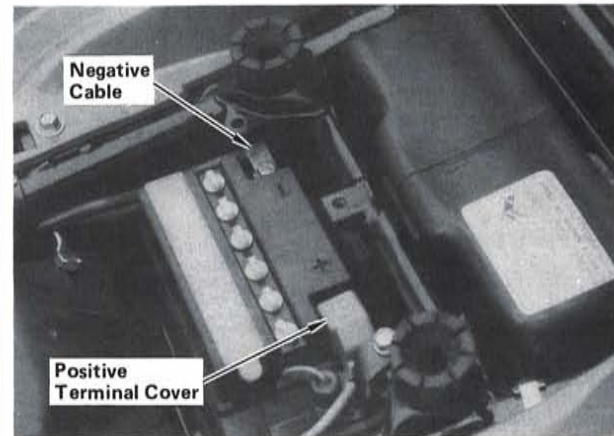

Negative Cable

Positive Terminal Cover

STEP 54—Check that ignition switch is off. Connect positive (+) battery cable first, then connect negative (-) cable. Tighten securely and coat battery terminals with clean grease. Slip terminal cover over positive terminal.

CAUTION: Make sure positive (+) battery cable is not forced against any metal parts.

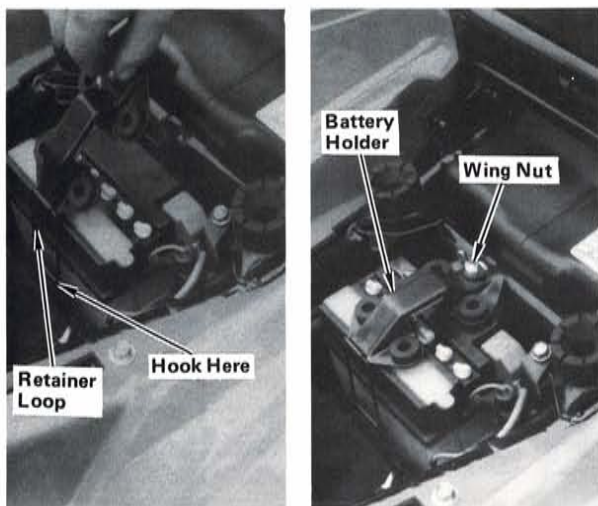

STEP 55—Reinstall battery holder as shown, being sure retainer loop is hooked. Tighten wing nut securely.

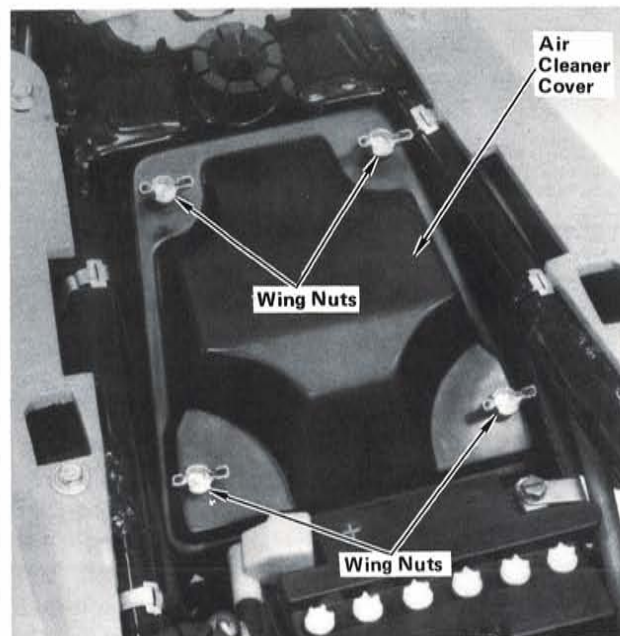

STEP 56—Remove air cleaner cover by removing four wing nuts. Remove air cleaner assembly from air cleaner case and remove filter element from its core.

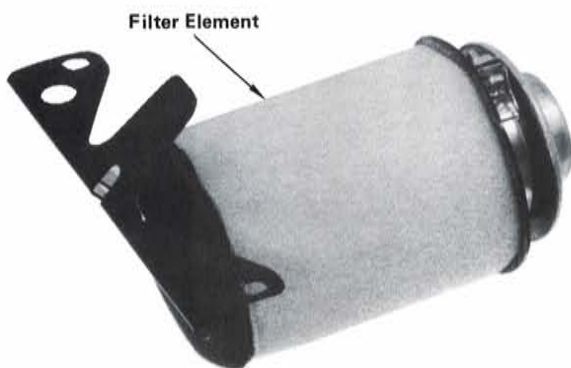

STEP 57—Check condition of filter element. If necessary, clean and oil element as described in owner's manual or shop manual. Reinstall element on its core and reinstall assembly in air cleaner case. Reinstall air cleaner cover and tighten the four wing nuts securely.

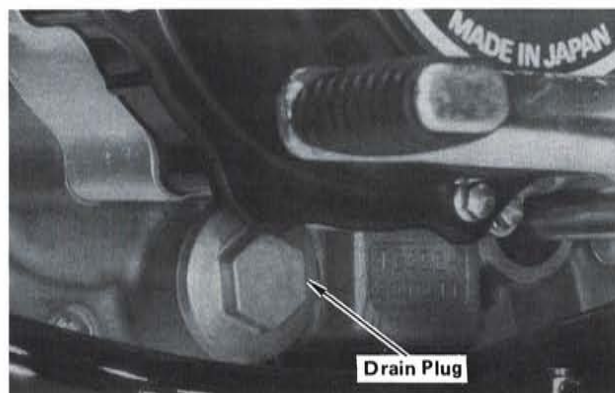

STEP 58—On 1982 Model, remove crankcase drain plug and drain engine oil. Reinstall and tighten drain plug.

NOTE: Not required on 1982 Model if less than 4 months have elapsed since date of manufacture shown on identification plate on steering head. On 1983 Model, do not drain oil until break-in period is completed.

Fill crankcase with recommended oil as described in owner's manual.



STEP 59—Drain fuel tank as described in shop manual. Remove fuel tank by removing mounting bolt at rear of tank and disconnecting fuel line. Inspect and flush fuel tank. Reinstall fuel tank, connect fuel line, fill tank, turn on fuel valve and check for leaks and flow through fuel filter. Tighten mounting bolt securely.

WARNING Fuel must be drained into a proper container. Gasoline is flammable and explosive under certain conditions. Do not smoke or allow flames or sparks near while draining fuel.

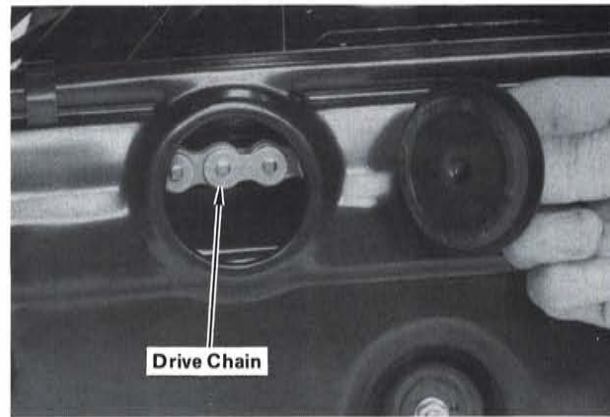

STEP 60—Check drive chain slack and lubrication. If necessary, adjust and lubricate drive chain as described in owner's manual or shop manual.

Slack: 10-20mm (3/8–3/4 in.)

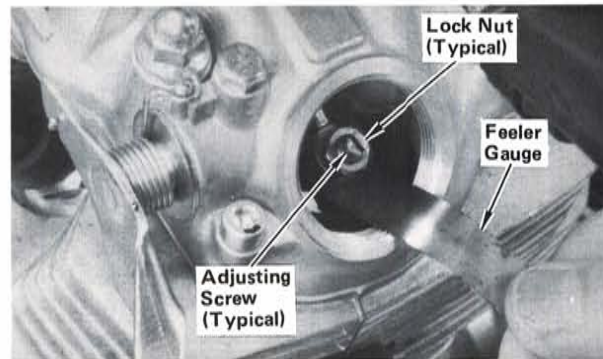
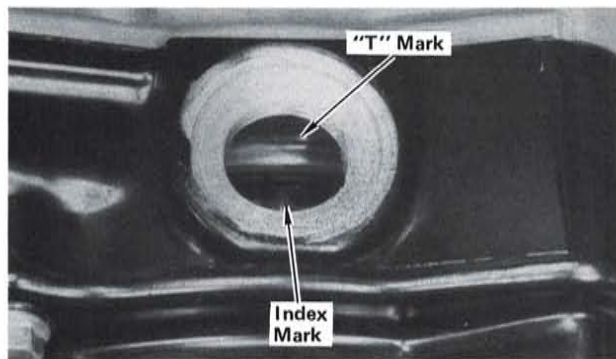

STEP 61—Check valve clearance and adjust if necessary as follows:

NOTE: Valve clearance adjustment must be done while engine is cold (below 35°C; 95°F).

1. Remove timing mark cap and valve adjuster hole caps.
2. Rotate crankshaft using recoil starter and align "T" mark on rotor with index mark on crankcase. Piston must be at T.D.C. (Top Dead Center) of compression stroke.
3. Insert feeler gauge between adjusting screw and valve stem of intake and exhaust valves.
4. If adjustment is necessary, loosen lock nut and turn adjusting screw as required.
5. After adjustment, hold adjusting screw and tighten lock nut.
6. Recheck valve clearance.
7. Reinstall valve adjuster hole caps.

Intake and Exhaust: 0.05mm (0.002 in.)



STEP 62—Connect a tachometer and check transmission in neutral. Start engine and allow it to warm up to operating temperature and check idle speed at $1,400 \pm 100$ rpm. If necessary, adjust idle speed using throttle stop screw. Remove tachometer.

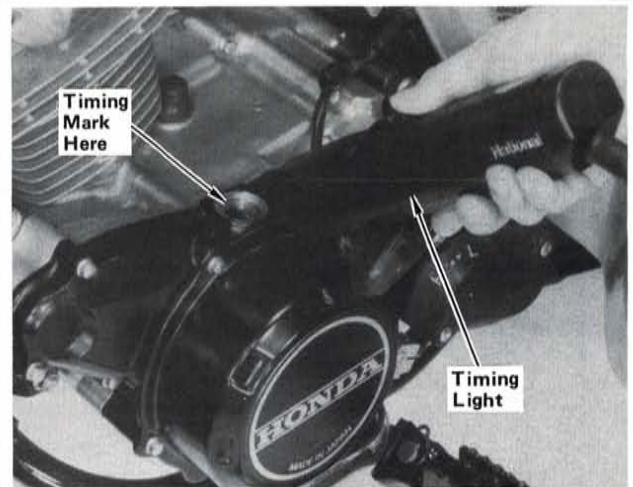

STEP 63—Connect a stroboscopic timing light and check transmission in neutral. Start engine and allow it to idle. Aim timing light at timing mark hole and check that "F" mark is aligned with index mark at idle. Reinstall timing hole cap. Remove timing light.

NOTE: The C.D.I. (Capacitor Discharge Ignition) system is factory preset and cannot be adjusted. If timing is incorrect, check C.D.I. units as described in shop manual.

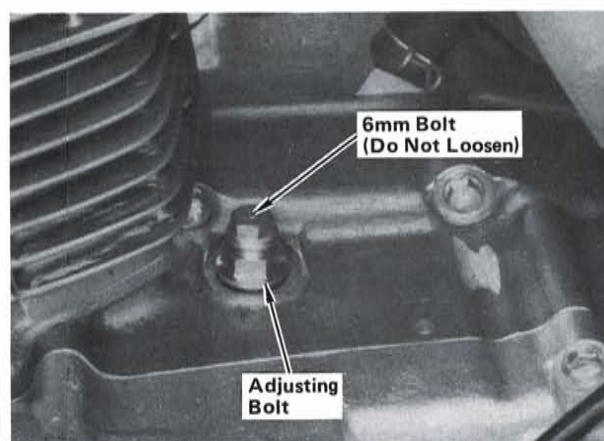

STEP 64—Adjust cam chain as follows:

1. Start engine and allow it to idle.
2. Remove rubber cap from tensioner adjusting bolt.
3. Loosen cam chain tensioner adjusting bolt to allow cam chain to automatically adjust itself to correct tension.

NOTE: Do not loosen the 6mm bolt.

4. Retighten cam chain tensioner adjusting bolt.
5. Reinstall rubber cap over tensioner adjusting bolt.

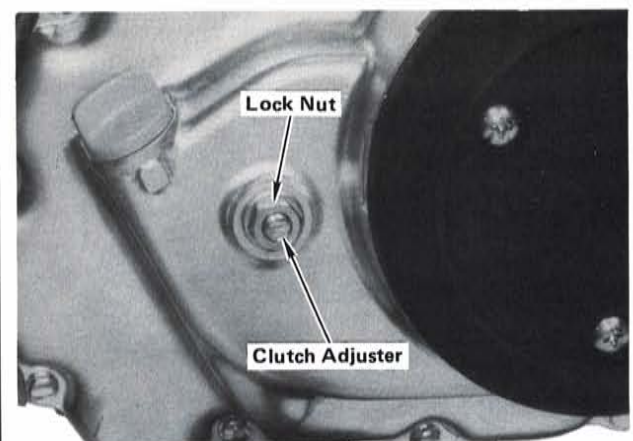

STEP 65—Check clutch operation. If adjustment is necessary, use the following procedure. Loosen lock nut and turn clutch adjuster counter-clockwise until resistance is felt, then turn clutch adjuster 1/4 turn clockwise and tighten lock nut. Recheck clutch operation.

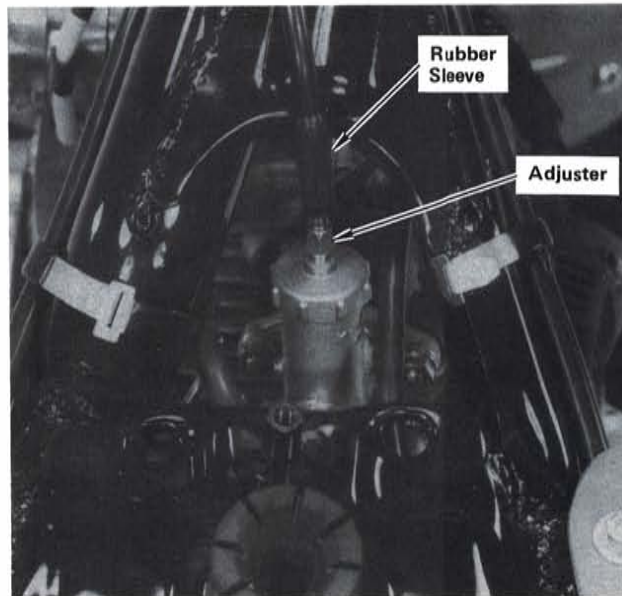
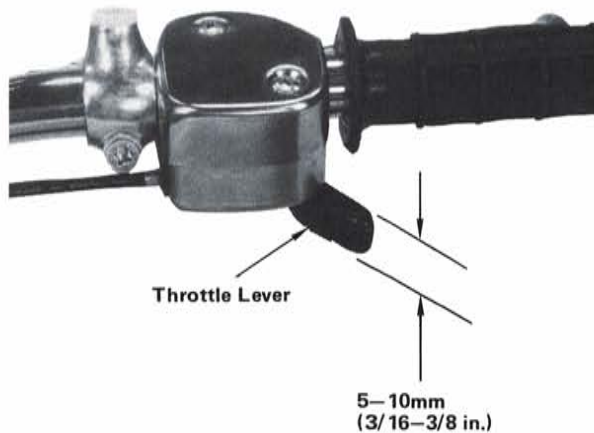

STEP 66—Check throttle cable for condition. Check that throttle lever free play is within 5–10mm (3/16–3/8 in.) at tip of throttle lever. Check for smooth operation of throttle lever from fully closed to fully open in all steering positions and that throttle lever automatically returns from fully open to fully closed when released. If necessary to adjust free play, slide rubber sleeve back to expose adjuster on top of carburetor. Turn adjuster as required and slide rubber sleeve back over cable adjuster.

1982 MODEL ONLY

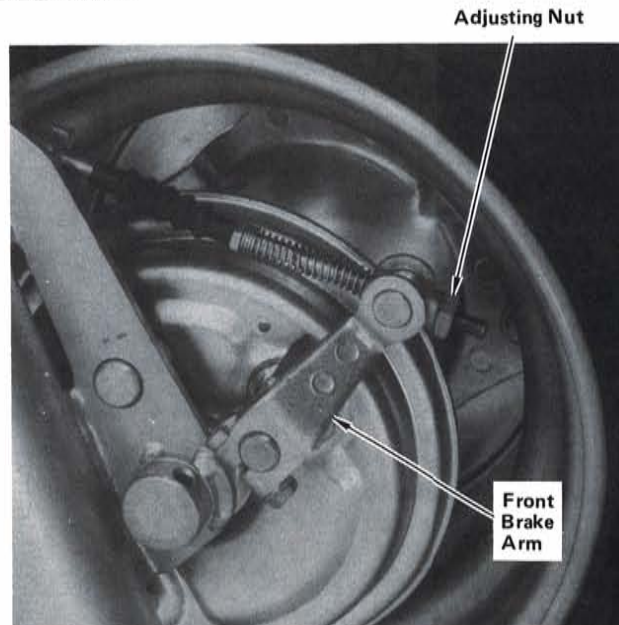
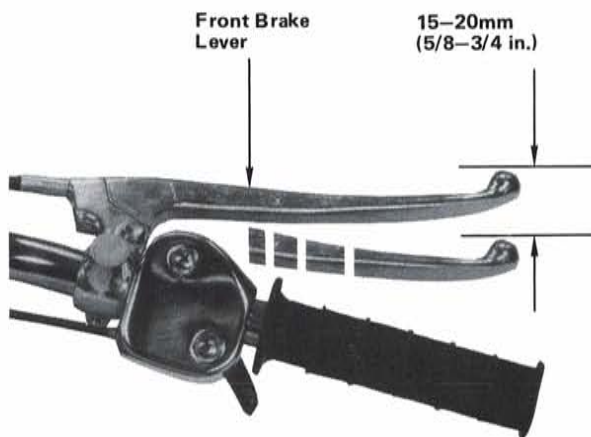

STEP 67—Raise front wheel off ground using a support block under engine. Spin front wheel by hand and measure free play of front brake lever before brake starts to engage. Free play, measured at tip of brake lever, should be between 15 and 20mm (5/8–3/4 in.). If adjustment is necessary, turn adjusting nut on front brake arm. Remove support block under engine.

1983 MODEL ONLY

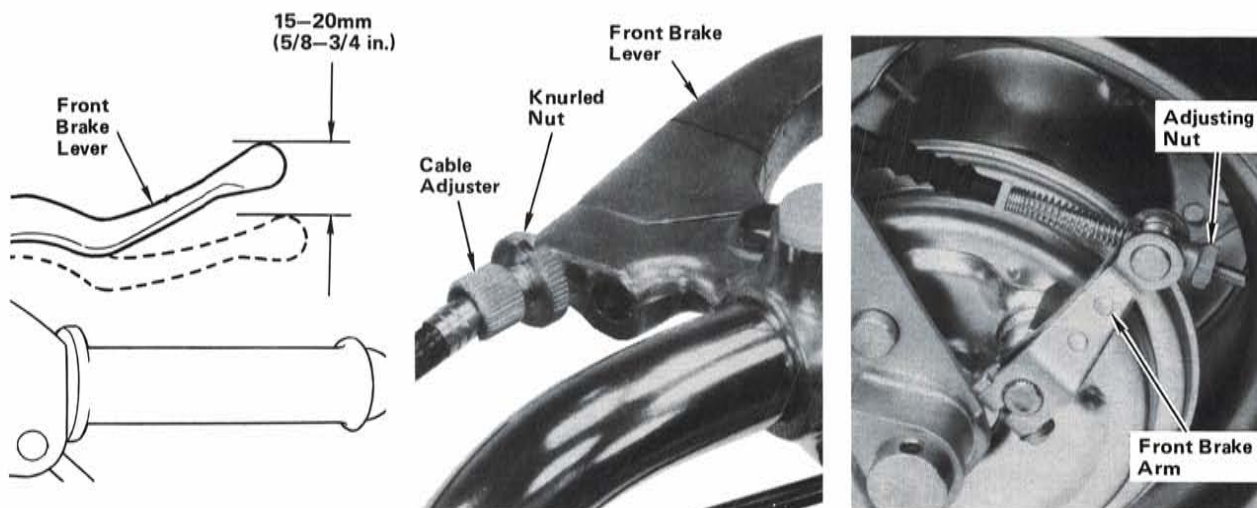

STEP 68—Raise front wheel off ground using a support block under engine. Spin front wheel by hand and measure free play of front brake lever before brake starts to engage. Free play, measured at tip of brake lever should be between 15 and 20mm (5/8—3/4 in.). Use lower adjusting nut to make large adjustments. Small adjustments are made at front brake lever by loosening knurled nut and turning cable adjuster. After adjustment, tighten knurled nut. Remove support block under engine.

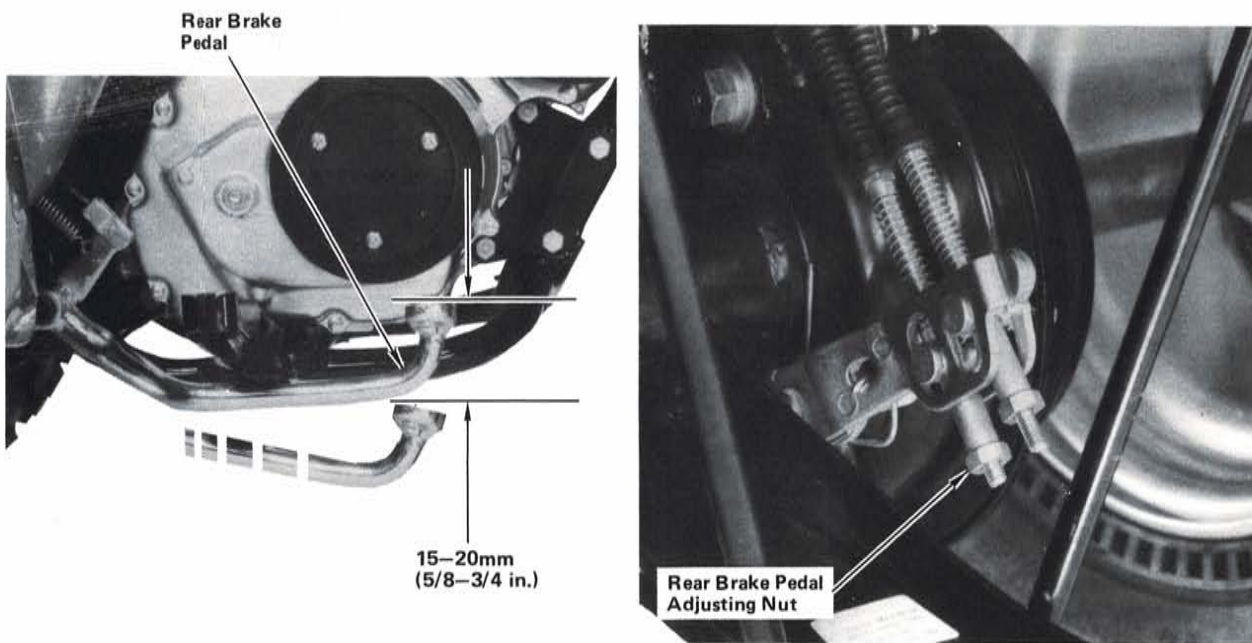

STEP 69—Raise rear wheels off ground using a support block under ATC. Rotate rear wheels by hand and measure free play before brake starts to engage. Free play, measured at tip of brake pedal, should be maintained between 15 and 20mm (5/8—3/4 in.). To adjust free play, turn adjusting nut. Turning adjusting nut clockwise will decrease free play.

1982 MODEL ONLY

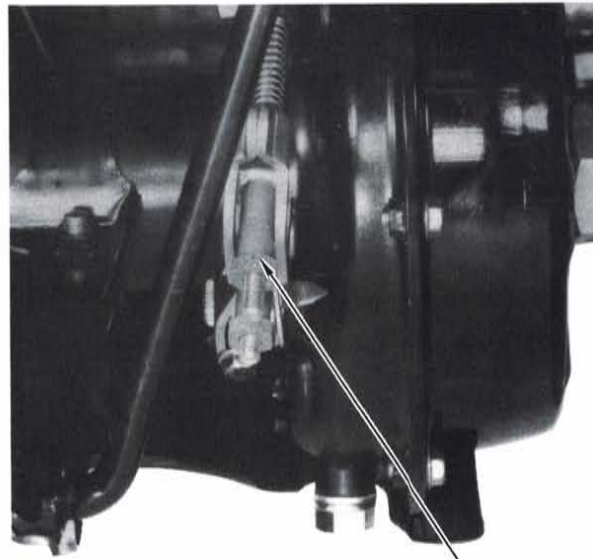
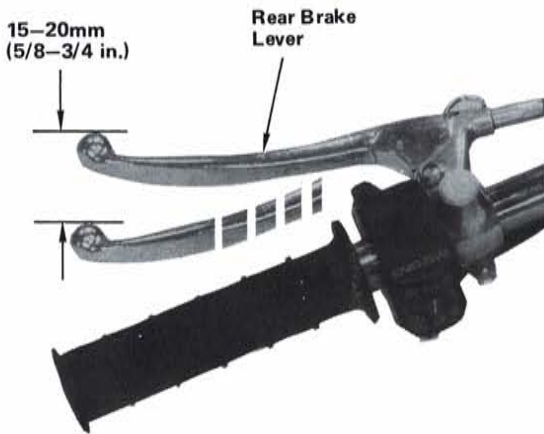

Brake Hand Lever Adjusting Nut

STEP 70—Spin rear wheels by hand and measure free play of rear brake lever before brake starts to engage. Free play, measured at tip of brake lever, should be between 15 and 20mm (5/8-3/4 in.). If adjustment is necessary, turn adjusting nut. Turning adjusting nut clockwise will decrease free play. Remove block from under ATC.

1983 MODEL ONLY

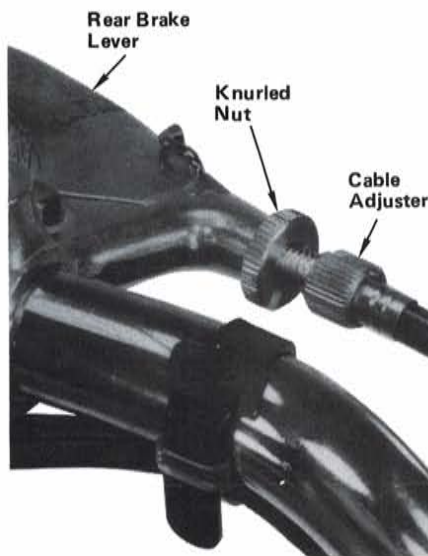
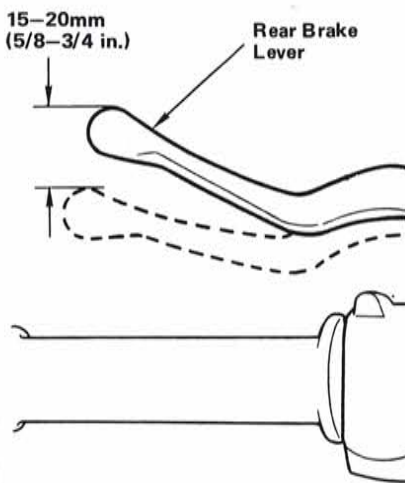

Brake Hand Lever Adjusting Nut

STEP 71—Spin rear wheels by hand and measure free play of rear brake lever before brake starts to engage. Free play, measured at tip of rear brake lever should be between 15 and 20mm (5/8-3/4 in.). Use adjusting nut on rear brake arm to make large adjustments. Small adjustments are made at rear brake hand lever by loosening knurled nut and turning cable adjuster. After adjustment, tighten knurled nut. Remove block from under ATC.

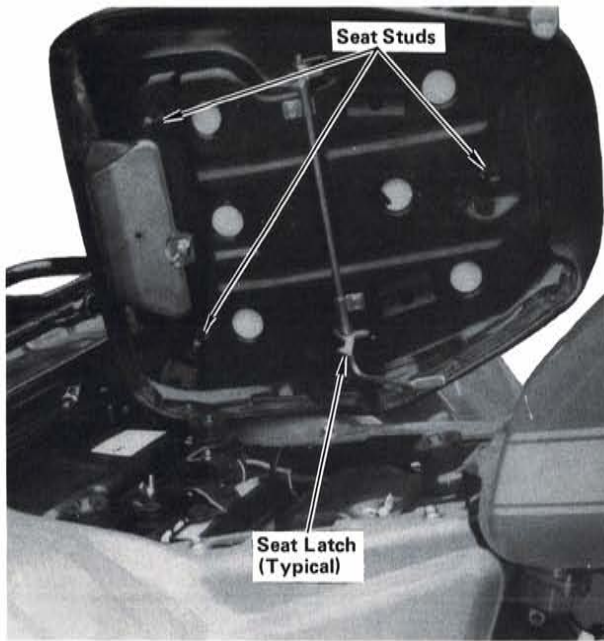

STEP 72—Insert seat studs into holes in seat mounts and engage seat latches.

NOTE: Check that seat latches are fully engaged.

CAUTION

REMOVE BATTERY AND MAINTAIN IN FULLY CHARGED CONDITION UNLESS MOTORCYCLE IS TO BE DELIVERED IMMEDIATELY. REFER TO SERVICE BULLETIN SL #48. DO NOT USE ELECTRIC STARTER IMMEDIATELY AFTER INSTALLATION OF A FRESHLY CHARGED BATTERY, SOME TIME IS REQUIRED FOR BATTERY TO ATTAIN FULL CAPACITY.

TORQUE TABLE

ITEM	SIZE	TORQUE
Front fork bolts	-----	6.0 kg-m (44 lb-ft)
Handlebar upper holder bolts	-----	1.0 kg-m (8 lb-ft)
Rear wheel hub nuts	8mm	2.2 kg-m (16 lb-ft)
Rear axle nuts	-----	7.0 kg-m (51 lb-ft)
Front fender bolts	6mm	0.9 kg-m (6 lb-ft)
Front fender cap nuts	6mm	0.9 kg-m (6 lb-ft)
Front axle nut	-----	7.0 kg-m (51 lb-ft)
Carrying handle bolts	8mm	2.2 kg-m (16 lb-ft)
Trailer hitch bolts	8mm	2.2 kg-m (16 lb-ft)

1982 MODEL ONLY

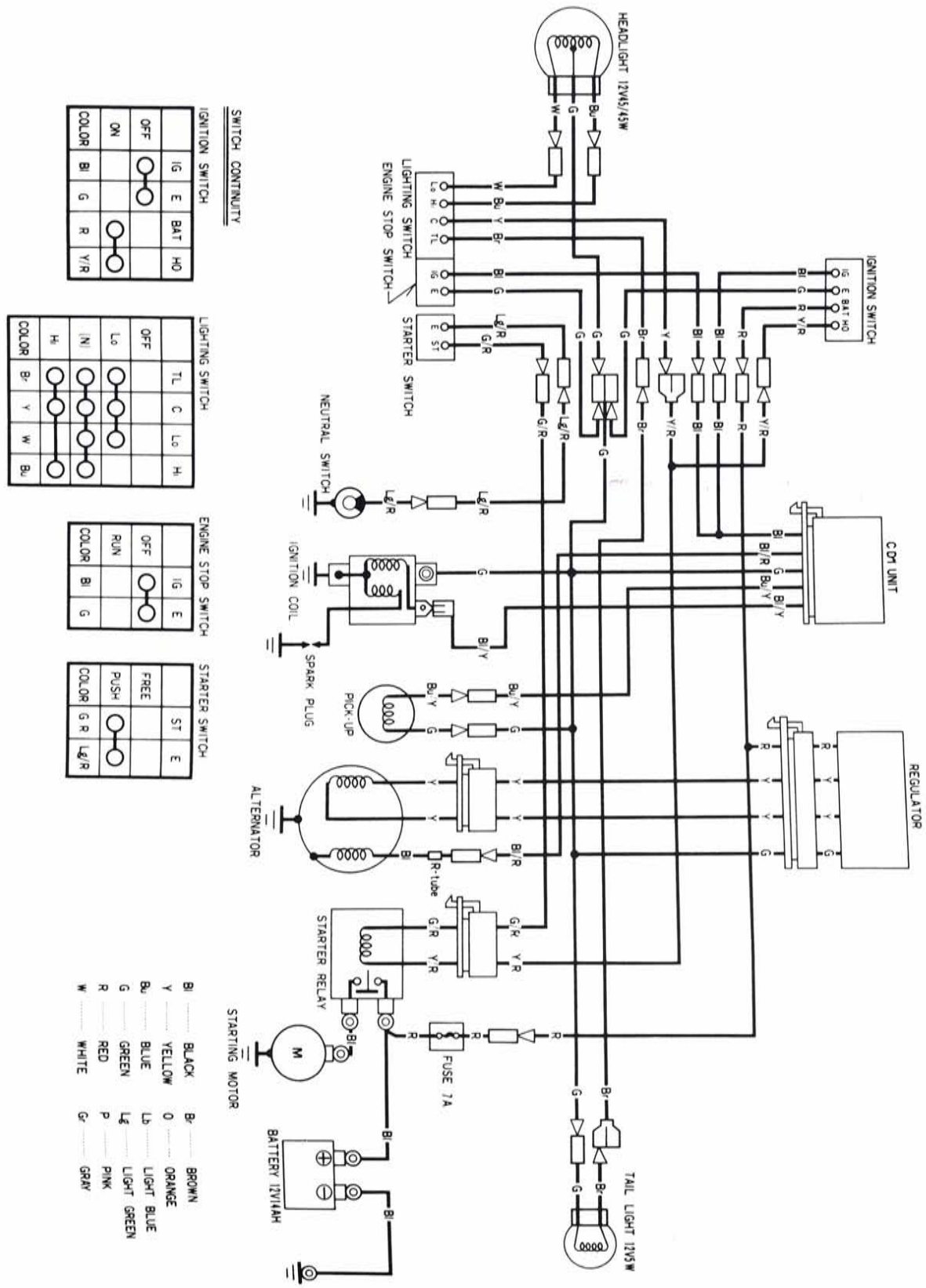

SWITCH CONTINUITY

IGNITION SWITCH		BAT		HO	
OFF	IG	OFF	E	OFF	HO
ON	BI	ON	G	ON	Y/R
COLOR		COLOR		COLOR	

LIGHTING SWITCH		C		Lo		Hi	
OFF	TL	OFF	C	OFF	Lo	OFF	Hi
ON	Hi	ON	Lo	ON	Lo	ON	Hi
COLOR		COLOR		COLOR		COLOR	

ENGINE STOP SWITCH		E	
OFF	IG	OFF	E
ON	BI	ON	G
COLOR		COLOR	

STARTER SWITCH		E	
PUSH	ST	PUSH	E
COLOR		COLOR	

- BI BLACK
- Y YELLOW
- G GREEN
- R RED
- W WHITE
- Br BROWN
- O ORANGE
- Lb LIGHT BLUE
- Lg LIGHT GREEN
- P PINK
- Gr GRAY

1983 MODEL ONLY

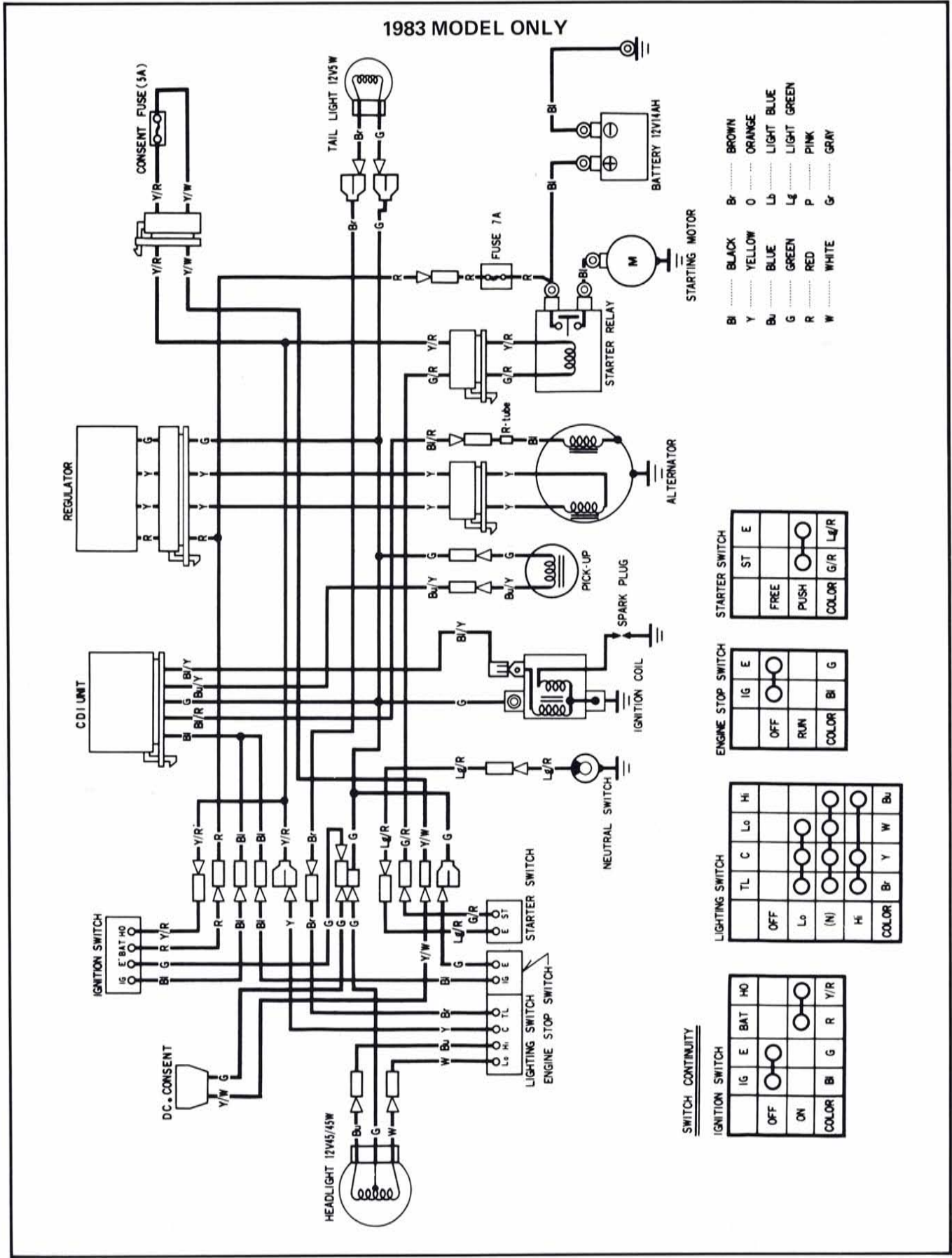

- BI BLACK
- Y YELLOW
- Bu BLUE
- G GREEN
- R RED
- W WHITE
- Br BROWN
- O ORANGE
- Lb LIGHT BLUE
- Lg LIGHT GREEN
- P PINK
- Gr GRAY

STARTER SWITCH

ST	E
FREE	
PUSH	
COLOR	G/R Lg/R

ENGINE STOP SWITCH

IG	E
OFF	
RUN	
COLOR	BI G

LIGHTING SWITCH

TL	C	Lo	Hi
OFF			
Lo			
(N)			
Hi			
COLOR	Br	Y	W Bu

IGNITION SWITCH

IG	E	BAT	HO
OFF			
ON			
COLOR	B	G	R Y/R

SWITCH CONTINUITY

NOTE: Check all items listed on the following Pre-delivery Service Check List. Refer to owner's manual or shop manual for specifications and detailed procedures. Always test ride the unit to make sure that it is functioning properly.

PRE-DELIVERY SERVICE CHECK LIST

- | | |
|---|--|
| <ul style="list-style-type: none"> <input type="checkbox"/> Adjust front and rear brakes, check cable routing and check operation. <input type="checkbox"/> Drain oil from crankcase (if necessary). Fill crankcase with recommended oil. <input type="checkbox"/> Remove and inspect fuel tank, drain and flush. Reinstall fuel tank, fill, turn on petcock and check for leaks. <input type="checkbox"/> Check air filter element. Clean and oil if necessary. <input type="checkbox"/> Check valve clearance; adjust if necessary. <input type="checkbox"/> Check operation of decompression system. <input type="checkbox"/> Check ignition timing. <input type="checkbox"/> Adjust idle speed. <input type="checkbox"/> Check throttle lever free play, cable routing, and operation in all steering position. <input type="checkbox"/> Adjust cam chain tension. <input type="checkbox"/> Adjust and lubricate drive chain. <input type="checkbox"/> Check tire pressure. <input type="checkbox"/> Inspect electrical components for proper operation and adjustment. <ul style="list-style-type: none"> • Headlight switch. • Headlight: Adjust high and low beam aim. | <ul style="list-style-type: none"> • Taillight. • Engine stop switch. • Starter. • Battery charging system. <ul style="list-style-type: none"> <input type="checkbox"/> Check security of all nuts, bolts, and other fasteners. <input type="checkbox"/> Check to ensure that all applicable recall and product update campaigns are complied with. <input type="checkbox"/> TEST RIDE: Check performance, handling, and operation. <ul style="list-style-type: none"> • Transmission and clutch: Ease of shifting, clutch operation, etc. • Acceleration: Smoothness, etc. • Cruising: Smoothness, etc. • Handling: Stability and cornering. • Brakes: Smoothness and stopping power. • Idling: Smoothness, throttle response, and return to idle. • Recheck idle speed after 10 minutes of stop and go operation. • Upon completion of test ride, check for fuel and oil leaks. |
|---|--|

LOOSE PARTS

The following is a list of items contained in the parts package carton and loose parts in the crate:

PART NAME	QTY	H/C	PART NUMBER
Rear wheel assy.	2	-----	-----
Rear wheel hub	1	084239	42410-958-000
14mm plain washer	2	107432	42322-950-000
8mm flange nut	4	048114	94050-08000
Rim support patch	2	122133	44714-958-680
14mm castle nut	2	023402	94011-14000-0S
3 x 45mm cotter pin	2	005845	94201-30450
Front wheel assy.	1	-----	-----
Front wheel axle	1	104611	44301-961-000
14mm plain washer	1	022838	94102-14000
14mm axle nut	1	046725	90305-401-680
3 x 45mm cotter pin	1	005845	94201-30450
Trailer hitch comp.	1	122200	50810-958-680
Trailer hitch bracket	1	122201	50812-958-680
8 x 16mm flange bolt	4	034764	95700-08016-08
Front fender	1	122266	61100-958-681ZA
Front fender mud flap	1	084221	61861-958-000
Headlight mounting nut	3	102159	61304-162-013
6 x 7 screw	13	081065	90102-673-003
6 x 20mm hex bolt	4	044210	92000-06020-0H
Front cover washer	4	029937	64348-086-000
6mm plain washer	2	005907	94101-06000
6mm cap nut	2	-----	06000-0S
Front carrier	1	122300	81100-958-680
Front carrier mount brace	2	122301	81101-958-680
Headlight assy.	1	-----	-----
Front fender collar	2	068678	61105-428-000
Lock pin 10mm	2	015926	94251-10000
8 x 16mm flange bolt	2	063124	95700-08016-00
6 x 20mm flange bolt	2	048868	95700-06020-00
8 x 12m flange bolt	4	049645	95700-08012-00
10mm plain washer	2	005911	94101-10000
Left rear fender	1	122285	80100-958-681ZA
Right rear fender	1	122293	80150-958-681ZA
Rear mud flap	2	122290	80111-958-680
Rear fender plate	2	122291	80112-958-680
Rear fender side plate	2	122292	80113-958-680
6mm lock washer	2	005897	94111-06000
Number plate bracket collar	7	084361	84706-415-00
6 x 16mm flange bolt	5	025226	95700-06016-08
8 x 12mm flange bolt	2	068127	95700-08012-08
6mm special nut	10	122367	90302-958-680

LOOSE PARTS (Continued)

PART NAME	QTY	H/C	PART NUMBER
Tool box assy.	1	-----	-----
Taillight assy.	1	-----	-----
Front fender collar	2	068678	61105-428-000
6 x 25mm flange bolt	3	025873	95700-06025-08
6mm plain washer	2	005907	94101-06000
Carrier pipe comp.	1	122302	81200-958-680
Rear carrier assy.	1	-----	-----
Rear carrier support	2	122304	81302-958-680
Rear carrier rubber	2	122306	81304-958-680
Rubber bushing collar	2	018365	52486-074-000
8mm collar cushion	2	122368	90324-449-000
8 x 32mm flange bolt	2	034498	95700-08032-08
Rear carrier bracket	2	122307	81305-958-680
6 x 40mm flange bolt	2	048396	95700-06040-00
6mm cap nut	2	005789	94021-06020
Owner's manual (1982)	1	120382	3195870
Owner's manual (1983)	1	130113	31958700
Seat assy.	1	-----	-----

○

○

○

○

○

○

○

READ THIS READ THIS READ THIS

READ THIS READ THIS READ THIS

HONDA

MODIFICATIONS WHICH YOU HAVE MADE, OR SHOULD MAKE IN THE FUTURE, TO ANY HONDA MOTORCYCLE, SHALL BE DEEMED BY OUR COMPANY TO HAVE BEEN PERFORMED AT YOUR SOLE RISK AND RESPONSIBILITY, AND WITHOUT OUR COMPANY'S OR THE MANUFACTURER'S APPROVAL OR CONSENT, IMPLIED OR EXPRESSED. WE FURTHER DISCLAIM ANY AND ALL LIABILITY, OBLIGATION, OR RESPONSIBILITY FOR ANY DEFECTS OF MODIFIED PARTS OR OF THE MODIFIED MOTORCYCLE, AND FOR ANY CLAIMS, DEMANDS, OR CAUSES OF ACTION FOR DAMAGE TO PROPERTY OR FOR PERSONAL INJURIES RESULTING FROM THE MODIFICATION OF SAID HONDA MOTORCYCLE.

READ THIS READ THIS READ THIS