

# Set-up Instructions

# 1985 Model ATC 200S



MPD 7574 8407

AMERICAN HONDA MOTOR CO., INC.  
100 WEST ALONDRA BOULEVARD, GARDENA, CALIFORNIA 90247

**WARNING**

**WARNING**

**WARNING**

**WARNING**

**SET-UP AND PRE-DELIVERY SERVICE MUST BE PERFORMED BY AN AUTHORIZED HONDA ALL TERRAIN VEHICLE (ATV) DEALER.** Proper set-up and pre-delivery service is essential to rider safety and reliability of the vehicle. When a customer takes delivery of his brand new vehicle he expects it to be in excellent running condition. There are few things that will cause greater customer dissatisfaction than poor preparation of a new vehicle. An error or oversight made by the mechanic assembling and servicing a new unit can easily result in faulty operation, damage to the vehicle, or even injury to the rider.



*NOTE: Right and left are determined from the rider's view.*

Date of Issue: 7/84

© American Honda Motor Co., Inc. 1984 - All Rights Reserved

1 of 21

# SET-UP INSTRUCTION REVISED PAGES

**Pages Affected**

1 through 21

**Orig. Issue Date**

7/84

**Rev. Date**

Original

**Remove and destroy superseded pages.**

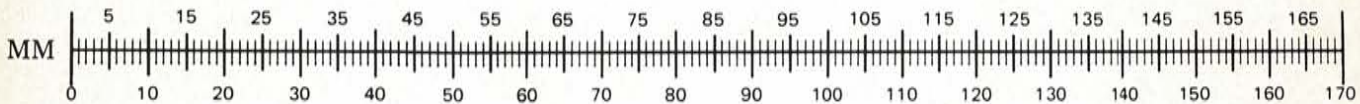

METRIC SCALE FOR DETERMINING BOLT LENGTHS/DIAMETERS

Pay special attention to warnings, cautions, and notes.

**WARNING** means hazards or unsafe practices which could cause severe personal injury or death.

**CAUTION:** means hazards or unsafe practices which could cause minor personal injury or product or property damage.

*NOTE:* gives helpful information.

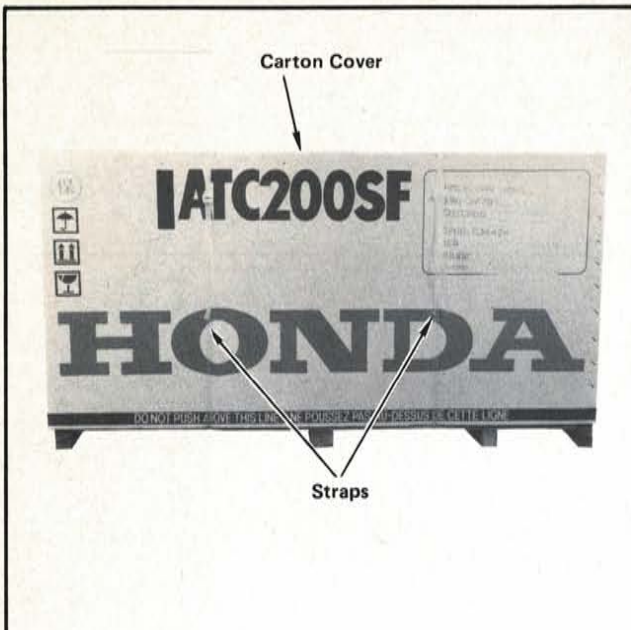

**STEP 1**—Cut straps and remove carton cover by lifting it up.

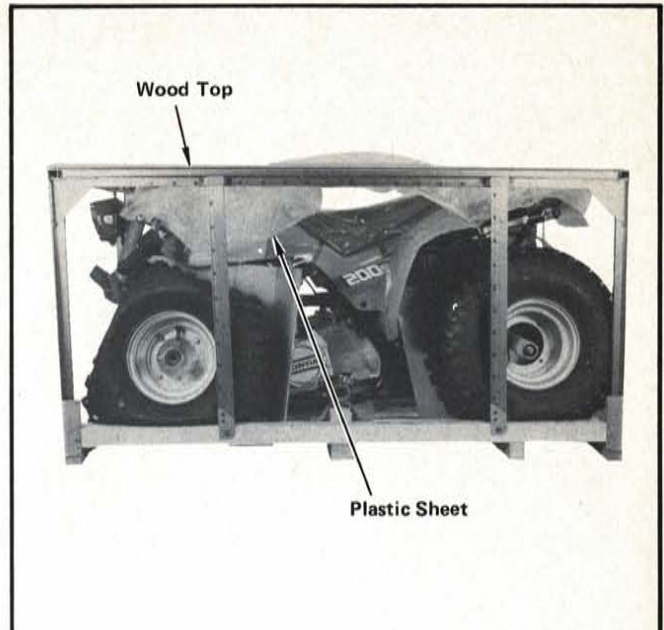

**STEP 2**—Remove crate wood top and plastic sheet.

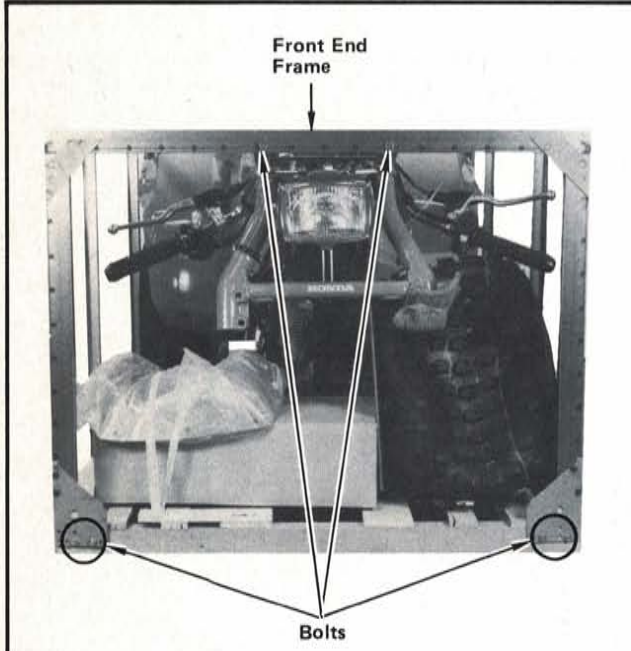

**STEP 3**—Remove four bolts attaching crate front end frame. Discard bolts.

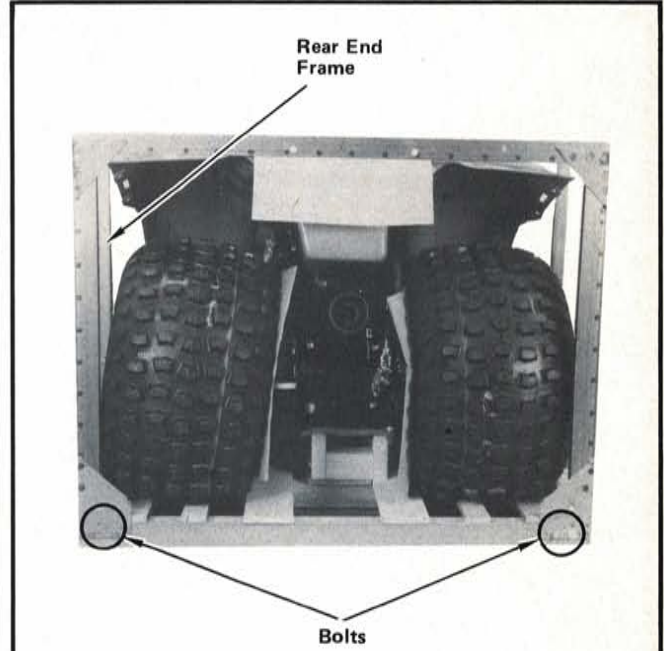

**STEP 4**—Remove two bolts attaching crate rear end frame to crate base. Discard bolts.

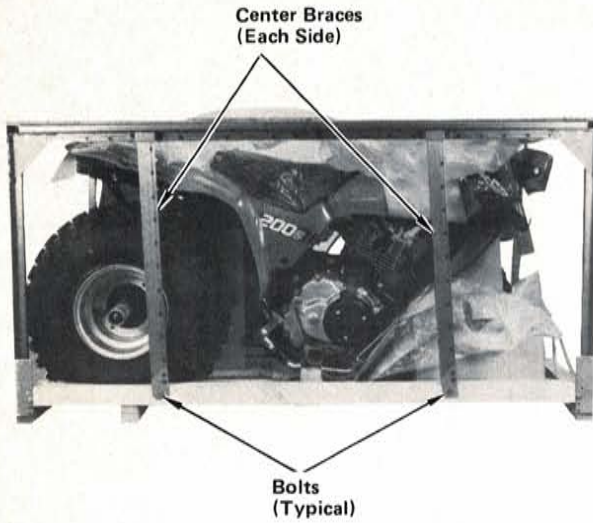

**STEP 5**—Remove bolts attaching center braces to crate base on each side. Discard bolts. Carefully lift off crate frame using two people.

**CAUTION:** Use extreme care not to damage vehicle with crate frame.

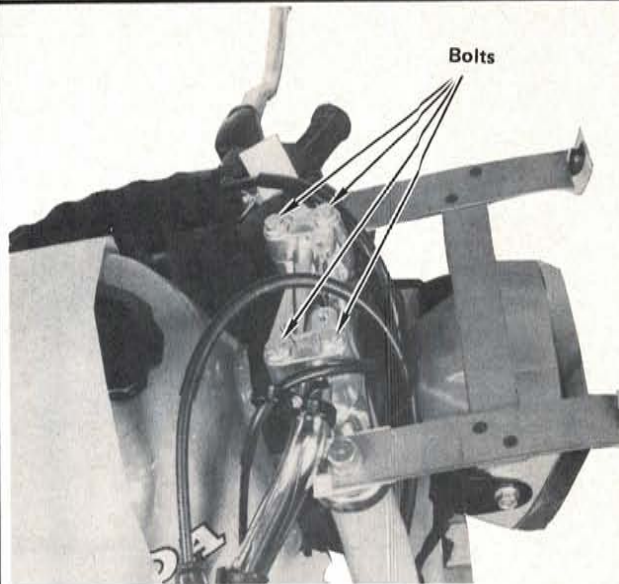

**STEP 6**—Loosen four bolts attaching upper handlebar holder.



**STEP 7**—Raise handlebar grips until punch mark on handlebar is aligned with top of lower holder and serrations are aligned with lower holders. Tighten forward bolts to specified torque first, then tighten rear bolts to same torque.

**Torque specification:**  
2.7 kg-m (19 lb-ft)

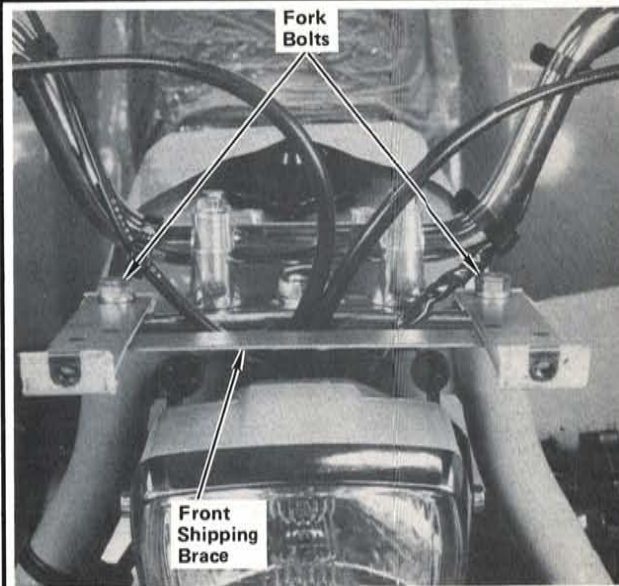

**STEP 8**—Loosen fork bolts and remove front shipping brace. Retighten fork bolts to specified torque.

**Torque specification:**  
6.0 kg-m (44 lb-ft)

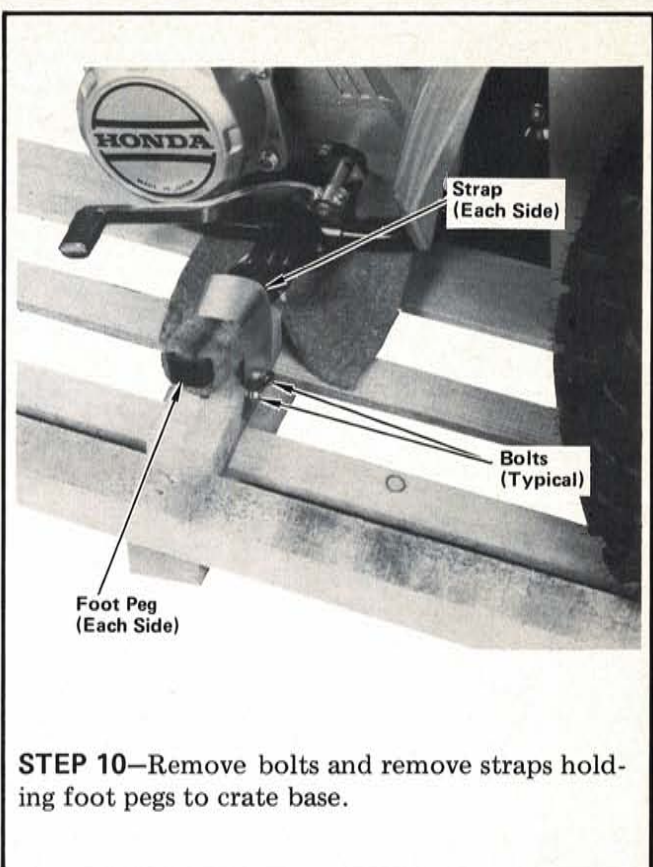
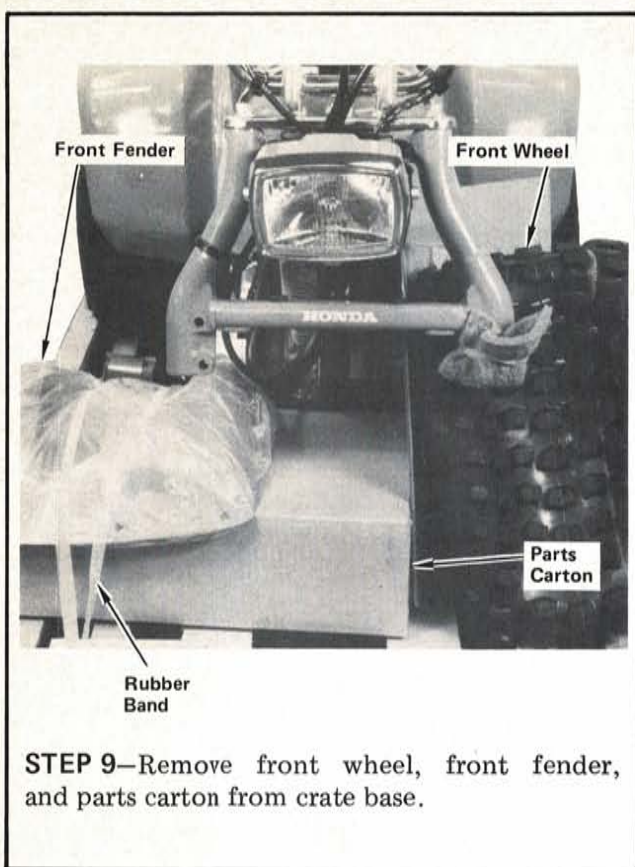

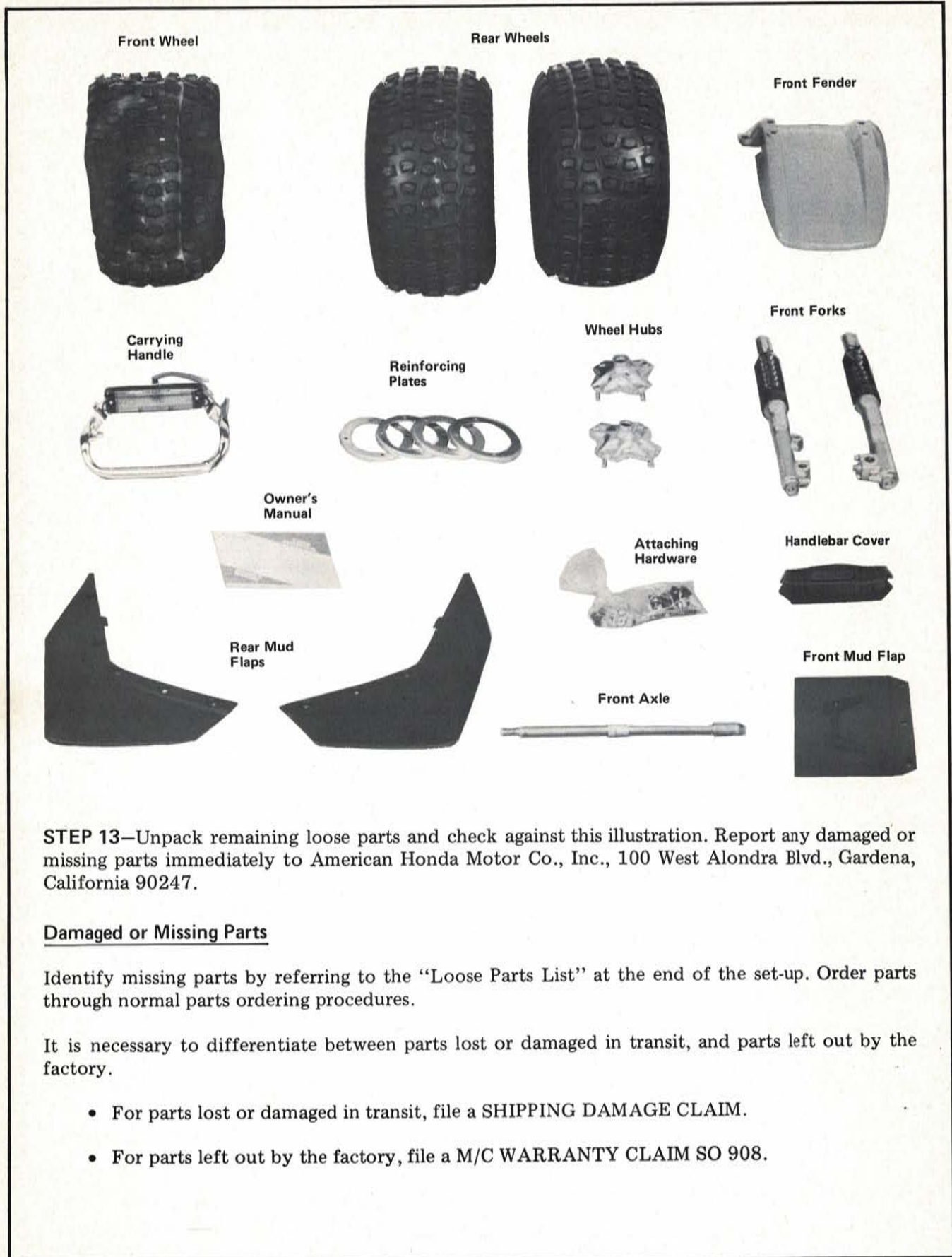

**STEP 13**—Unpack remaining loose parts and check against this illustration. Report any damaged or missing parts immediately to American Honda Motor Co., Inc., 100 West Alondra Blvd., Gardena, California 90247.

#### Damaged or Missing Parts

Identify missing parts by referring to the "Loose Parts List" at the end of the set-up. Order parts through normal parts ordering procedures.

It is necessary to differentiate between parts lost or damaged in transit, and parts left out by the factory.

- For parts lost or damaged in transit, file a SHIPPING DAMAGE CLAIM.
- For parts left out by the factory, file a M/C WARRANTY CLAIM SO 908.

Front Fender

Rubber Grommets (4)

Flanged Collars (4)

6 x 7 mm Special Screws

Special Nuts

Mud Flap

**STEP 14**—Check front fender mud flap and attaching hardware.

Rubber Grommets And Flanged Collars

Front Mud Flap

6 x 7 mm Special Screws And Nuts

**STEP 15**—Position mud flap under front fender as shown and install using three 6 x 7 mm special screws inserted down through fender, and special nuts under fender as shown. Tighten screws securely.

*NOTE: Note position of special nuts.*

Install rubber grommets into four holes in fender and insert flanged collars into holes in grommets from under fender.

10 x 35 mm Flange Bolts

Fork Legs

**STEP 16**—Insert left and right fork legs up into lower fork bridge. (Fork leg with axle holder goes on left side.) Push fork legs up tight against stop in lower fork bridge and install using four 10 x 35 mm flange bolts as shown. Tighten bolts to specified torque.

**Torque specification:**  
4.5 kg-m (32 lb-ft)

Install upper ends of fork boots as shown and tighten clamp screws.

**CAUTION:** Do not twist fork boots while tightening clamp screws.

Front Fender

6 x 25 mm Flange Bolts

**STEP 17**—Position front fender between fork legs with mud flap towards rear and install using four 6 x 25 mm flange bolts. Be sure flanged collars are in place. Tighten bolts to specified torque.

**Torque specification:**  
1.0 kg-m (8 lb-ft)

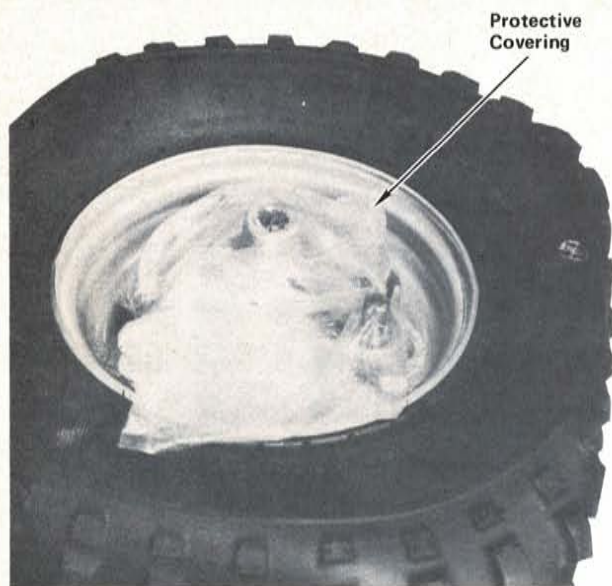

**STEP 18**—Remove rubber band and protective covering from front brake. Remove front brake and check that brake linings and brake drum are clean. Check that grease seal is full of grease. If necessary, wipe brake drum with a clean cloth. Reinstall brake panel.

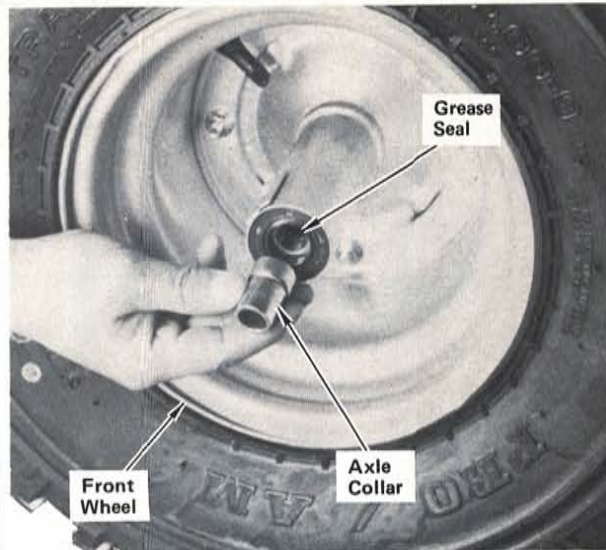

**STEP 19**—Insert large end of axle collar into grease seal on valve stem side of front wheel as shown.

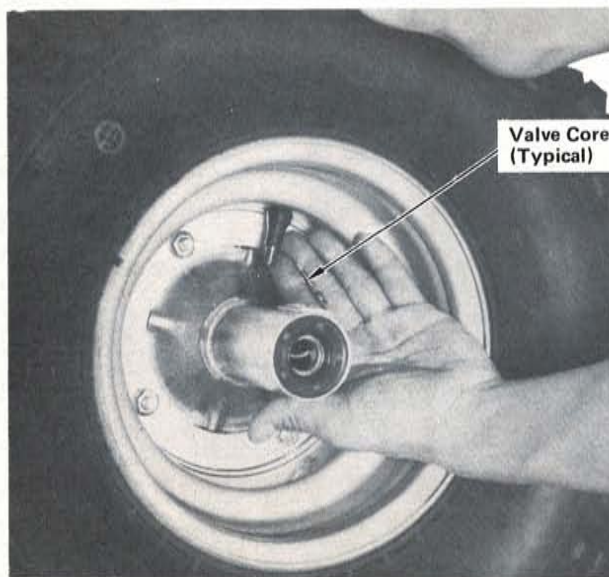

**STEP 20**—Remove valve caps from all three tires and tighten valve cores. Inflate and check tire pressure of all three tires. Reinstall valve caps.

Tire pressure: 2.2 psi.

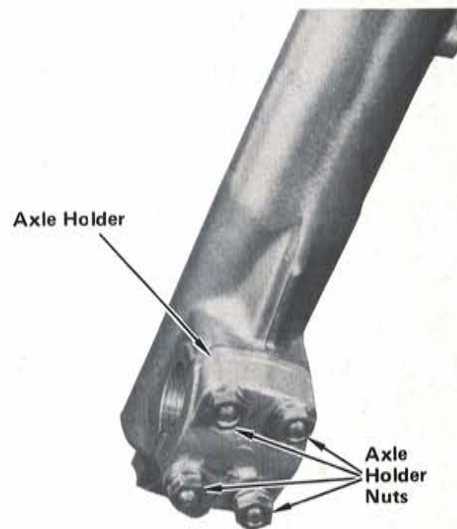

**STEP 21**—Loosen four axle holder nuts.





**STEP 22**—Rotate sliders of fork legs so axle holder and brake mounting bosses are towards the rear. Insert front axle through axle holder, collar, wheel hub, brake panel, and screw into right fork leg.

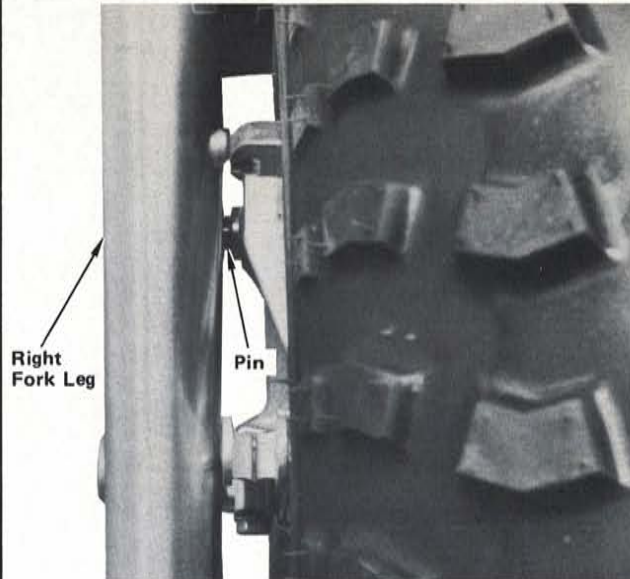

**STEP 23**—Check that pin on brake panel is inserted into hole in right fork leg.

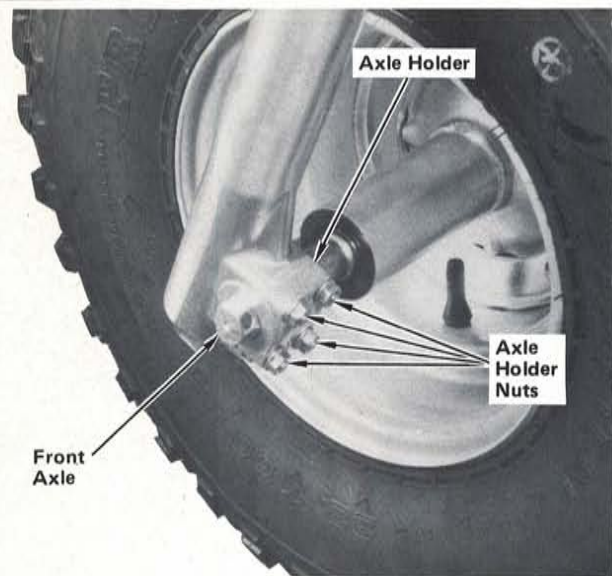

**STEP 24**—Tighten front axle to specified torque. Tighten upper axle holder nuts to specified torque first, then tighten lower nuts to same torque.

**Torque specifications:**

- Front axle: 9.0 kg-m (70 lb-ft)
- Axle holder nuts: 1.2 kg-m ( 9 lb-ft)

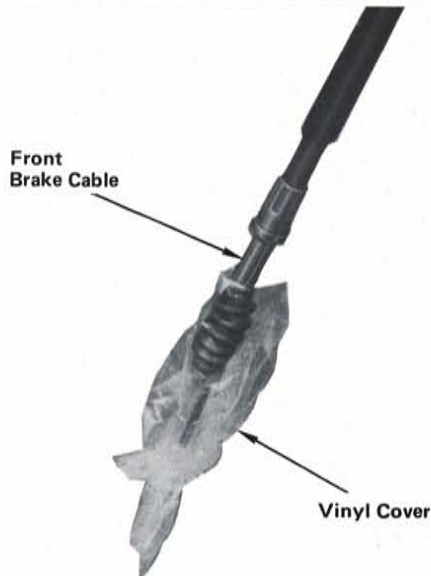

**STEP 25**—Remove vinyl cover from end of front brake cable.

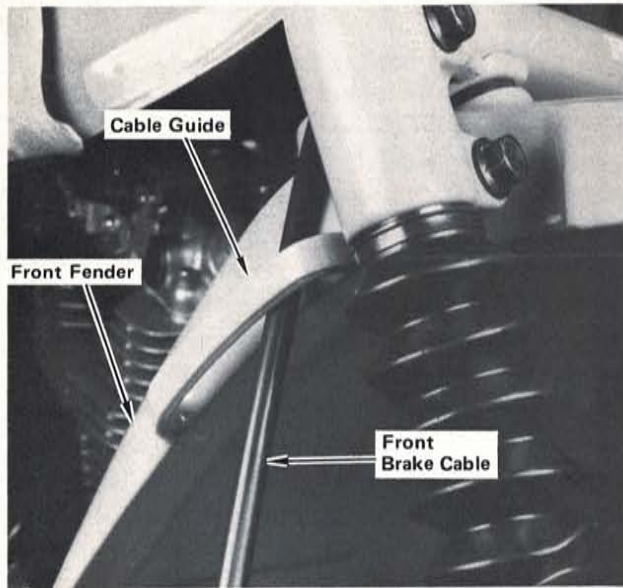

**STEP 26**—Route front brake cable down through cable guide on front fender.

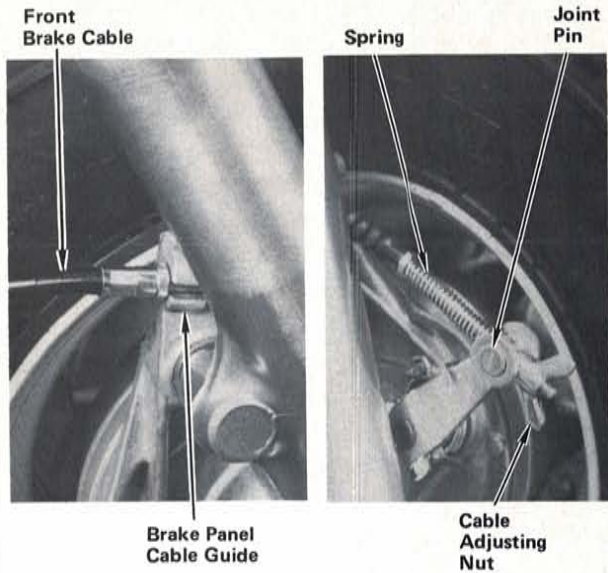

**STEP 27**—Route front brake cable through cable guide on front brake panel. Slip brake return spring over end of front brake cable. Connect brake cable to brake arm using a joint pin and cable adjusting nut. Adjust front and rear brakes as described in Steps 45 through 47.

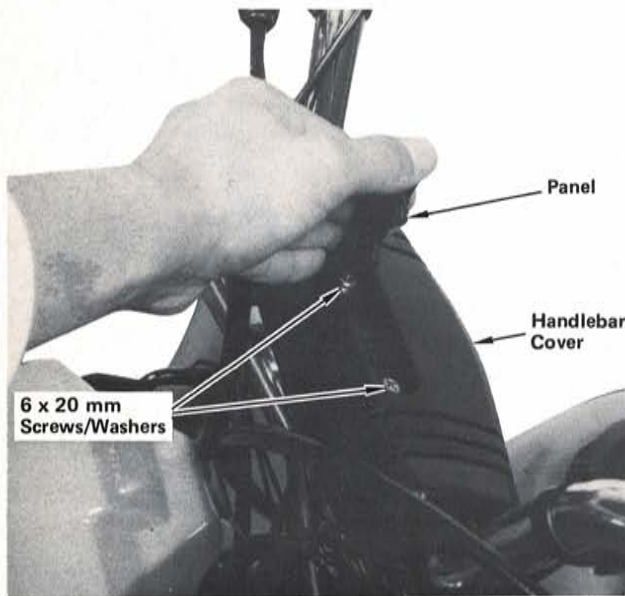

**STEP 28**—Remove panel from handlebar cover and install cover as shown using two 6 x 20 mm screws/washers. Tighten screws securely and re-install panel as shown.

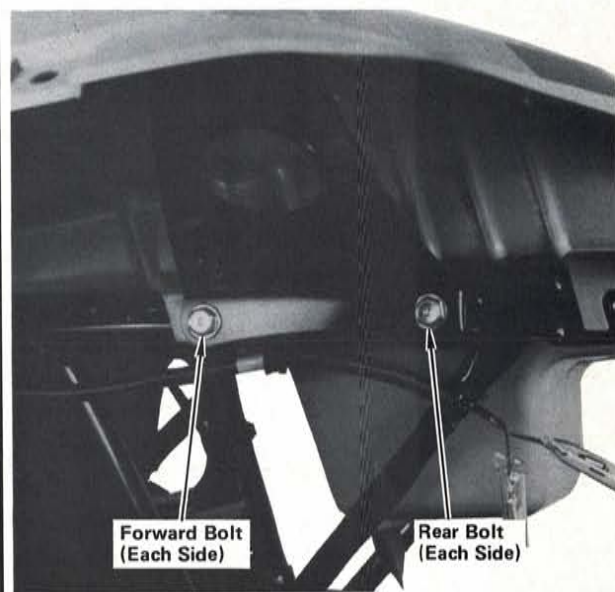

**STEP 29**—Loosen two forward rear fender bracket bolts. Remove and retain two rear bolts.

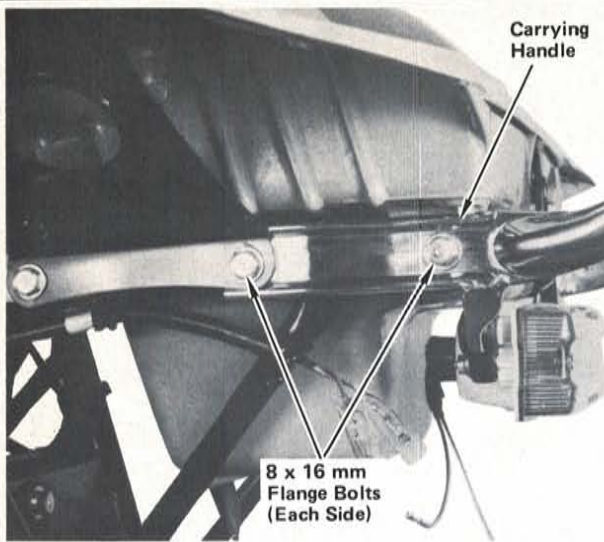

**STEP 30**—Position ends of carrying handle between rear fender and frame and align holes of frame and handle. Install handle using two 8 x 16 mm flange bolts on each side. (Two removed in previous step and two additional bolts.) Tighten all six bolts to specified torque.

**Torque specification:**  
2.7 kg-m (19 lb-ft)

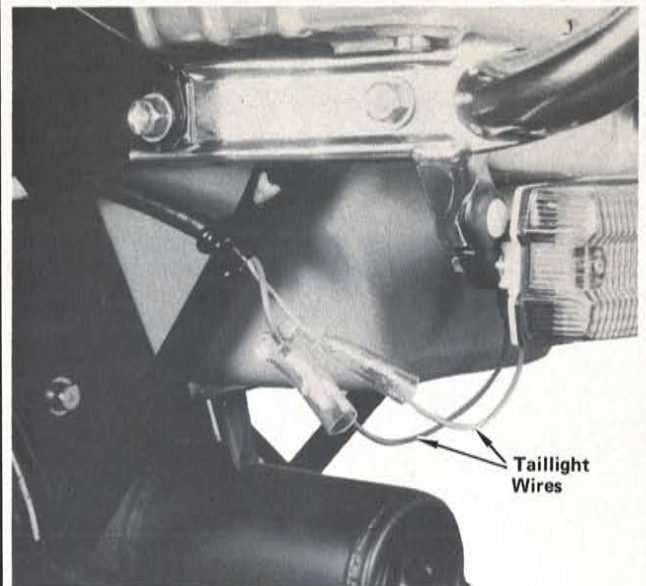

**STEP 31**—Connect taillight wires to wire harness color-to-color.

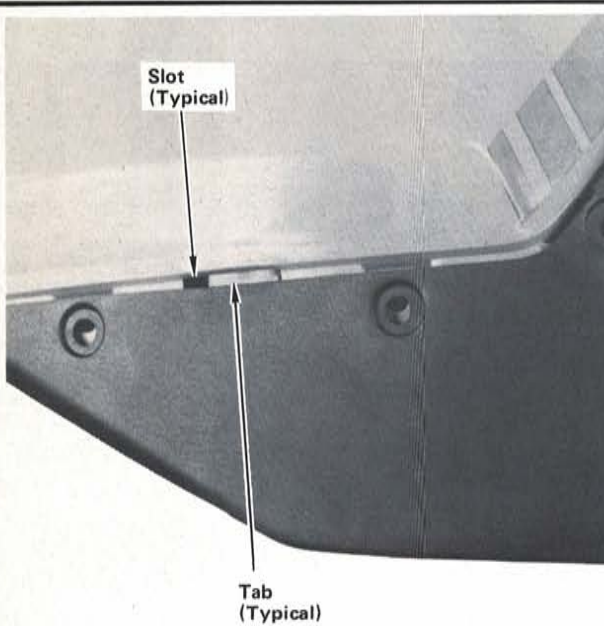

**STEP 32**—Insert tabs of rear mud flaps into slots of rear fenders as shown.

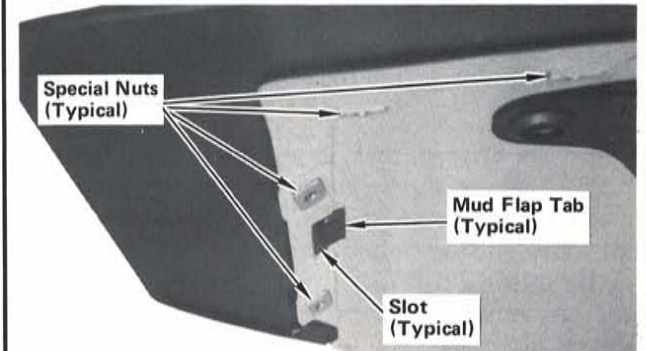
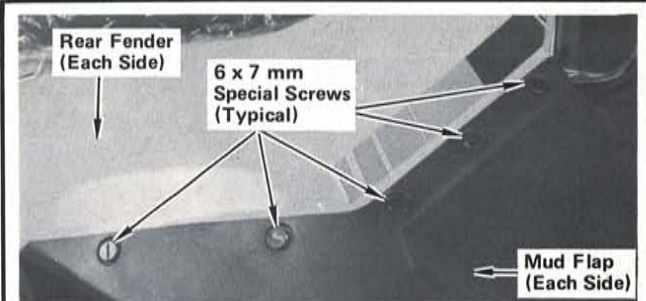

**STEP 33**—Position rear mud flaps on rear fenders as shown and install using five 6 x 7 mm special screws and special nuts for each as shown. Tighten all screws securely.

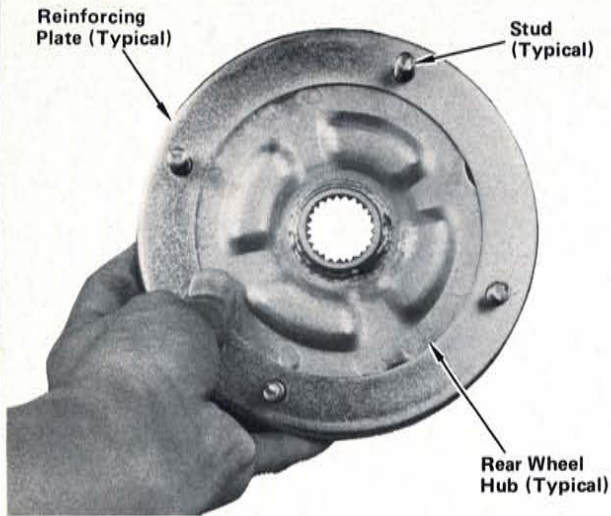

**STEP 34**—Slip a rear wheel reinforcing plate over studs of each rear wheel hub as shown, with flange towards hub.

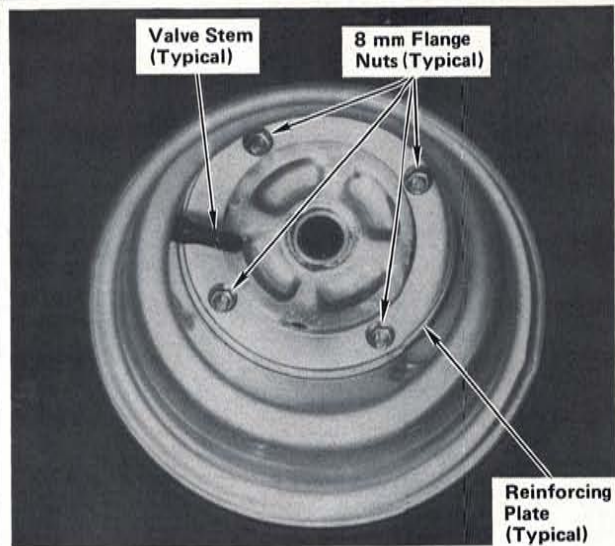

**STEP 35**—Insert studs of rear wheel hubs through rear wheels, from side opposite valve stems. Install each hub using a reinforcing plate (flange up) and four 8 mm flange nuts for each. Tighten nuts to specified torque.

**Torque specification:**  
2.2 kg-m (16 lb-ft)

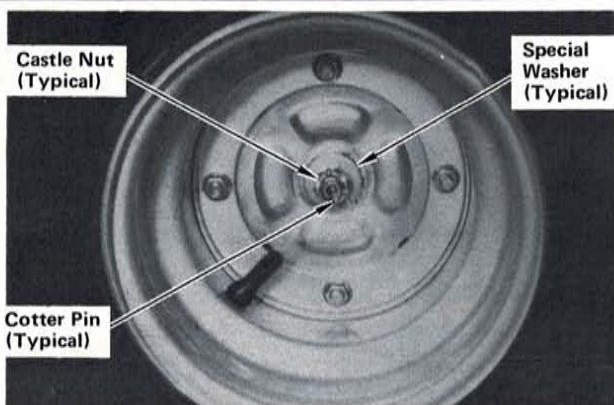

**STEP 36**—Grease rear axle splines and install rear wheels, with tire valves to the outside, using a special washer (with “OUTSIDE” marking facing out) and castle nut for each. Tighten both castle nuts to specified torque and install a cotter pin in each. Spread ends of cotter pins as shown.

*NOTE: Install rear wheels so tire tread directional pattern will be same as front tire.*

**Torque specification:**  
7.0 kg-m (51 lb-ft)



**STEP 37**—Remove protective covering from fuel tank.

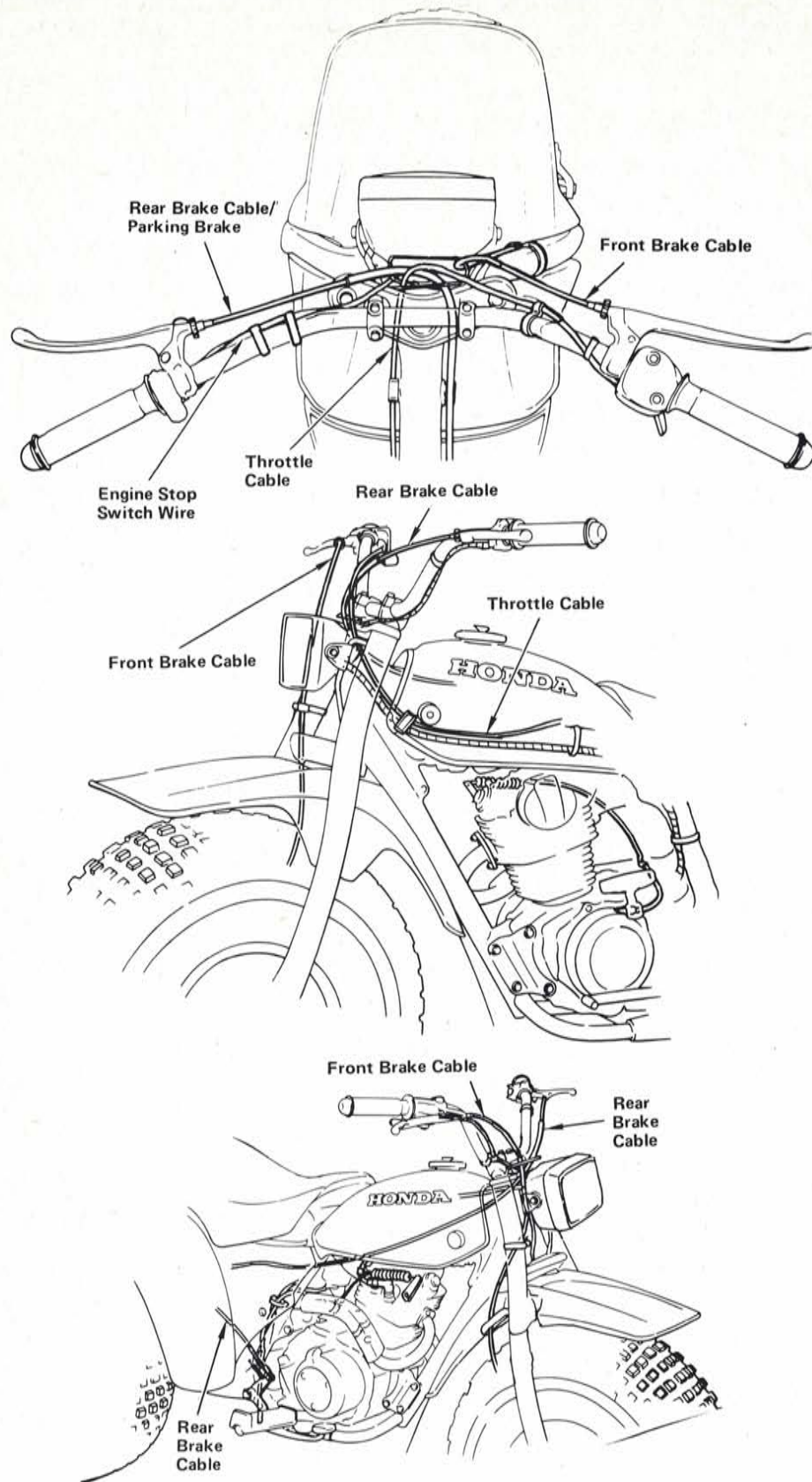

**STEP 38**—Check routing of front and rear brake cables, throttle cable, engine stop switch wires, and headlight switch wires as shown.

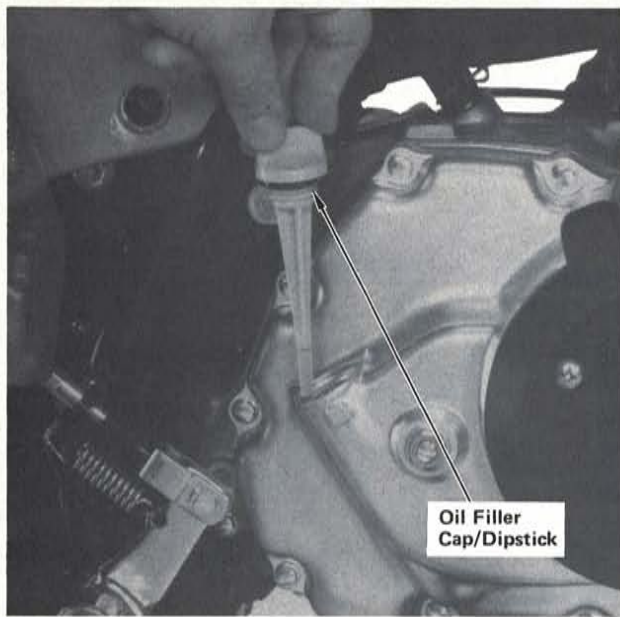

**STEP 39**—Remove oil filler cap/dipstick and fill crankcase with recommended oil as described in owner's manual. Reinstall and tighten oil filler cap/dipstick.

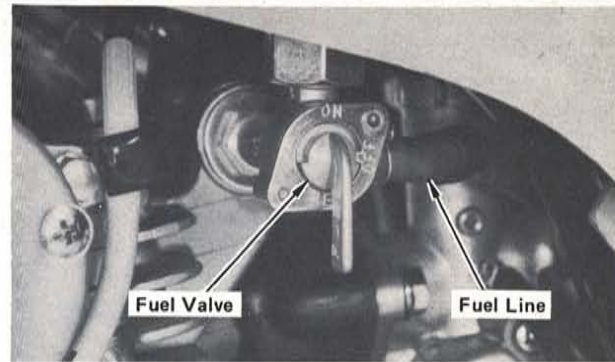

**STEP 40**—Drain fuel tank as described in shop manual. Remove fuel tank by removing mounting bolt at rear of tank and disconnecting fuel line. Inspect and flush fuel tank. Clean fuel filter. Reinstall fuel tank, connect fuel line, fill tank, turn on fuel valve and check for leaks and flow through fuel filter. Tighten mounting bolt securely. Drain residual fuel from carburetor.

**WARNING**

Fuel must be drained into a proper container. Gasoline is flammable and explosive under certain conditions. Do not smoke or allow flames or sparks near while draining fuel.

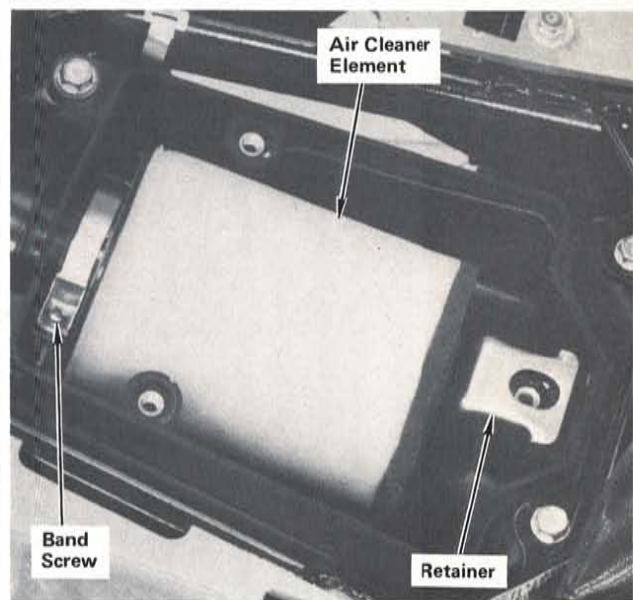
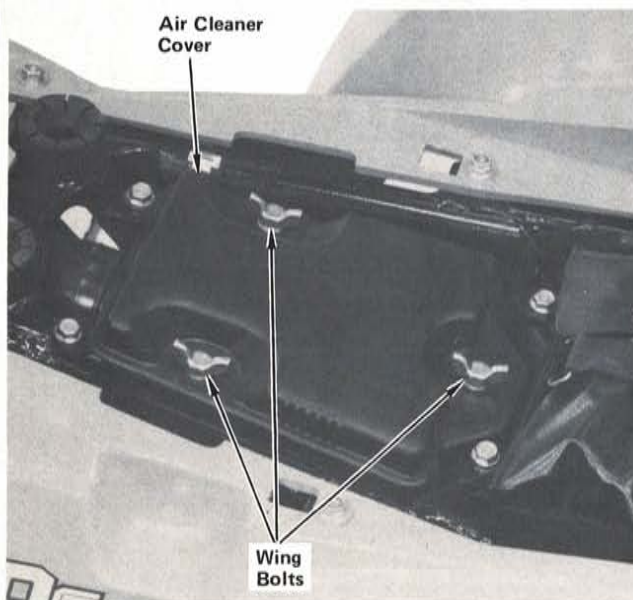

**STEP 41**—Remove three wing bolts attaching air cleaner cover. Loosen air cleaner band screw. Remove air cleaner element assembly from air cleaner case. Remove retainer from air cleaner core and remove air cleaner element. Check condition of element. If necessary, clean element as described in owner's manual or shop manual. Reinstall element, retainer, and assembly into air cleaner case. Tighten air cleaner band screw. Reinstall air cleaner cover and tighten wing bolts securely.



**STEP 42**—Connect a tachometer and check transmission in neutral. Start engine and allow it to warm up to operating temperature and check idle speed at  $1,400 \pm 100$  rpm. If necessary, adjust idle speed using throttle stop screw. Remove tachometer.

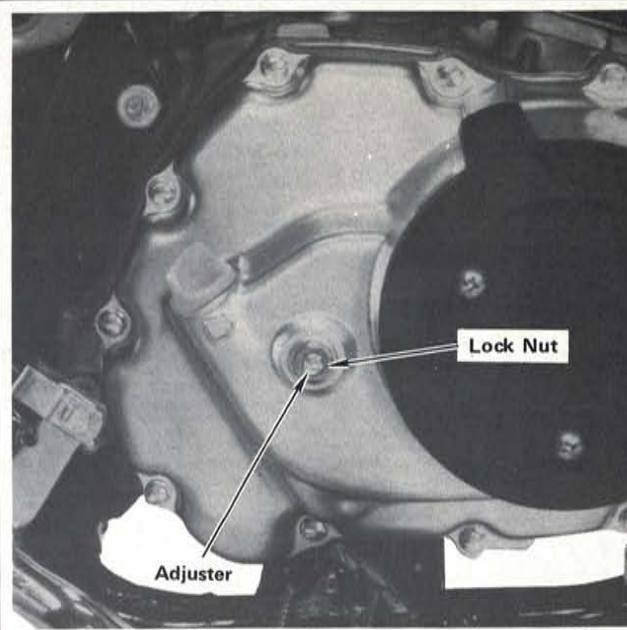

**STEP 43**—Check clutch operation. If adjustment is necessary, use the following procedure. Loosen lock nut and turn clutch adjuster counterclockwise until resistance is felt, then turn clutch adjuster  $1/4$  turn clockwise and tighten lock nut. Recheck clutch operation.

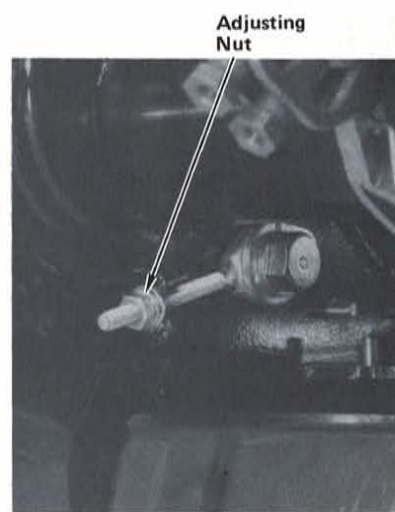
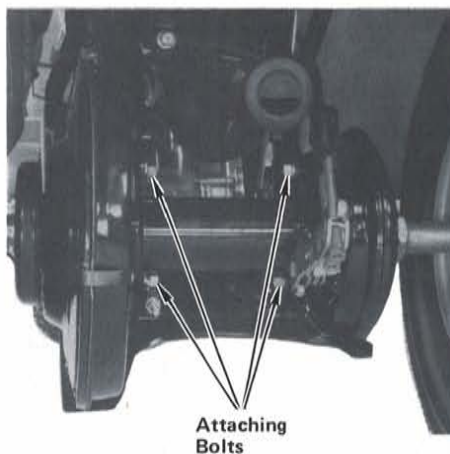
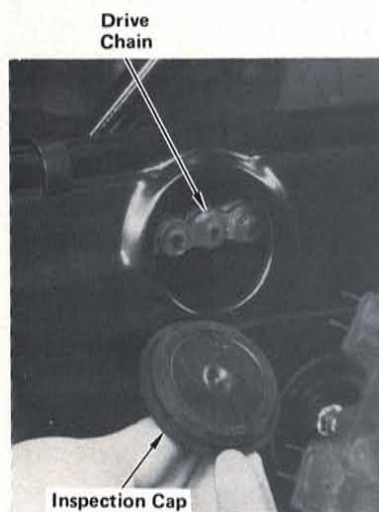

**STEP 44**—Remove drive chain inspection cap and check chain slack. If adjustment is necessary, loosen rear hub bolts and turn adjusting nut to obtain correct slack. After adjustment, tighten rear hub bolts and lock nut then recheck chain slack. Lubricate drive chain as described in owner's manual or shop manual and reinstall chain inspection cap.

Drive chain slack: 15–25 mm (5/8–1 in.)

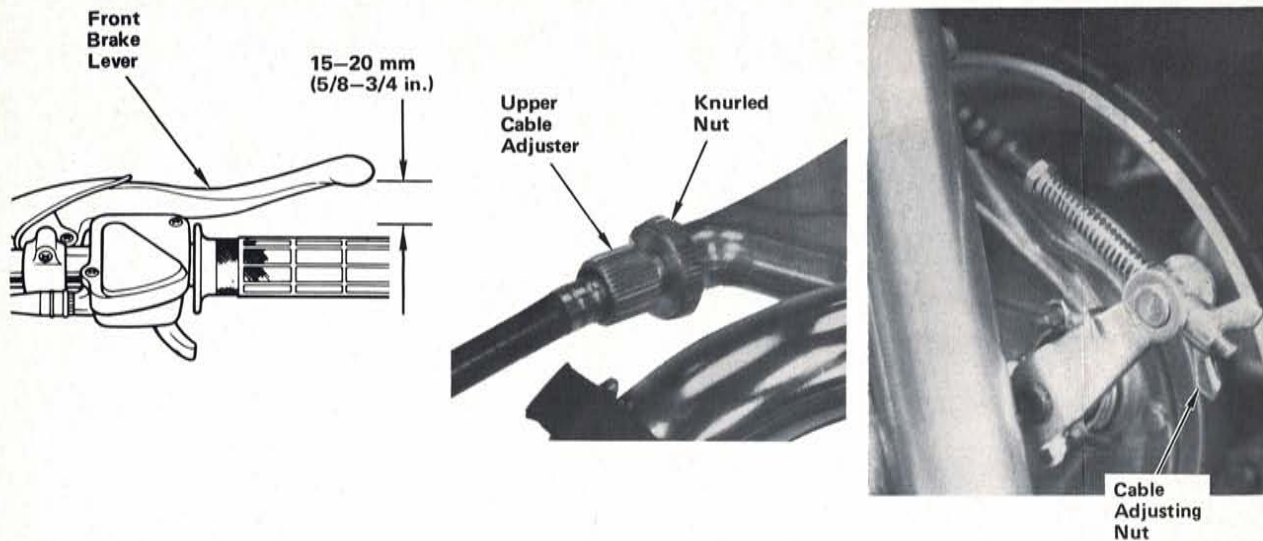

**STEP 45**—Raise front wheel off ground using a support block under engine. Spin front wheel by hand and measure free play of front brake hand lever before brake starts to engage. Free play, measured at tip of brake hand lever, should be between 15 and 20 mm (5/8—3/4 in.). Use lower adjuster to make large adjustments. Small adjustments are made at brake hand lever by loosening knurled nut and turning upper adjuster. After adjustment, tighten knurled nut.

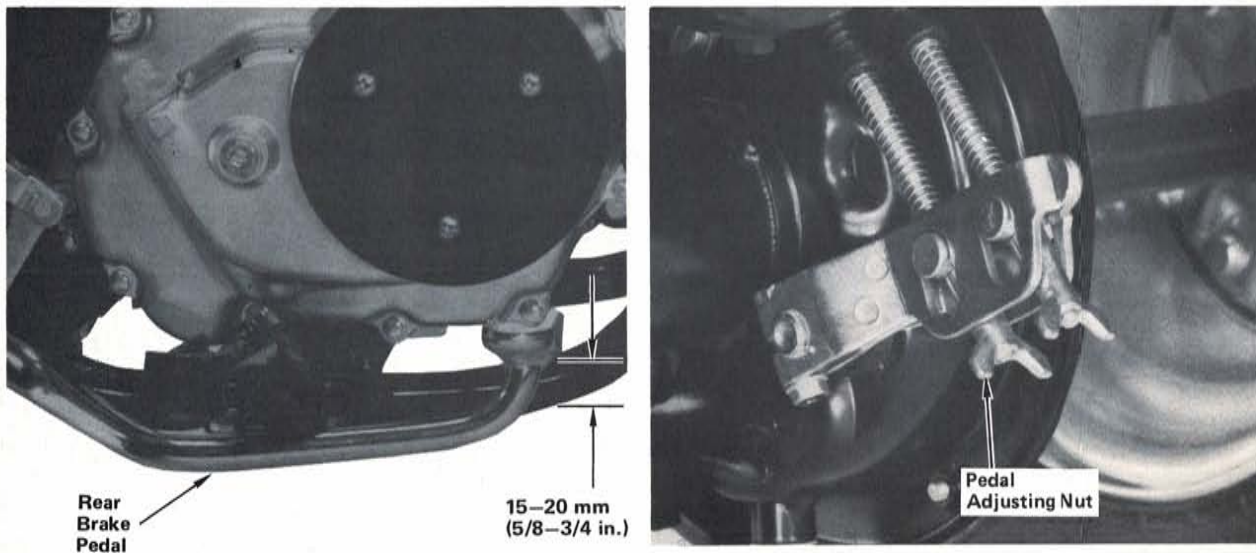

**STEP 46**—Raise rear wheels off ground using a support block under ATC. Rotate rear wheels by hand and measure free play before brake starts to engage. Free play, measured at tip of brake pedal, should be between 15 and 20 mm (5/8—3/4 in.). To adjust free play, turn adjusting nut. Turning adjusting nut clockwise will decrease free play.



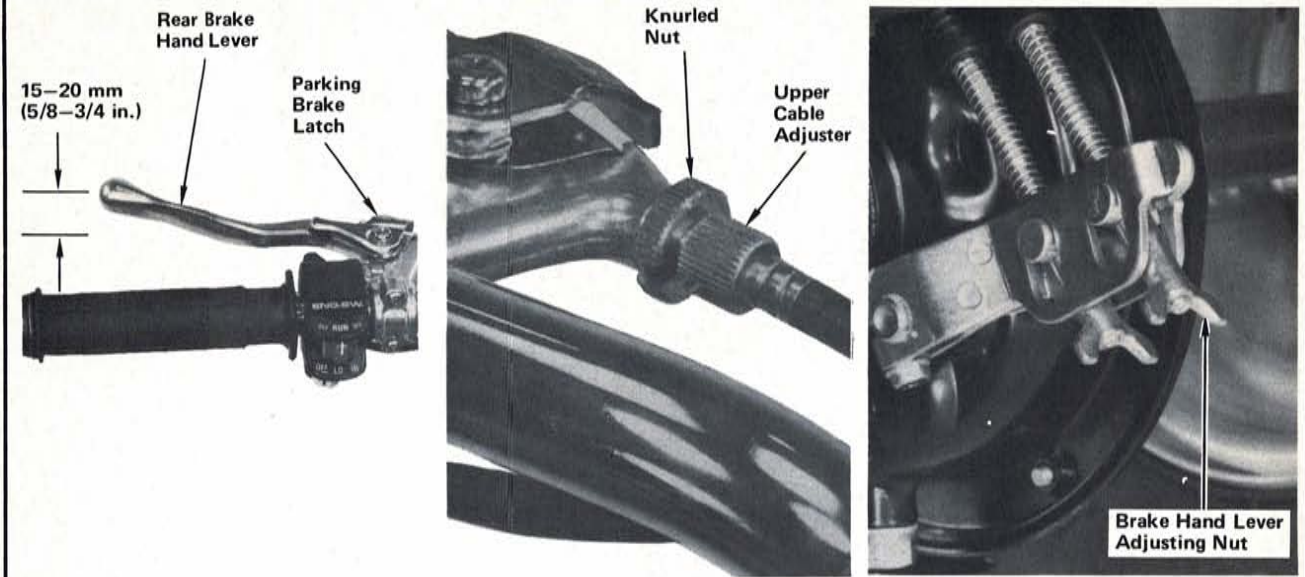

**STEP 47**—Raise rear wheels off ground using a support block under engine. Spin rear wheels by hand and measure free play of rear brake hand lever before brake starts to engage. Free play, measured at tip of brake hand lever, should be between 15 and 20 mm (5/8–3/4 in.). Use lower adjuster to make large adjustments. Small adjustments are made at rear brake hand lever by loosening knurled nut and turning upper adjuster. After adjustment, tighten knurled nut. Remove block under engine. Check parking brake operation.

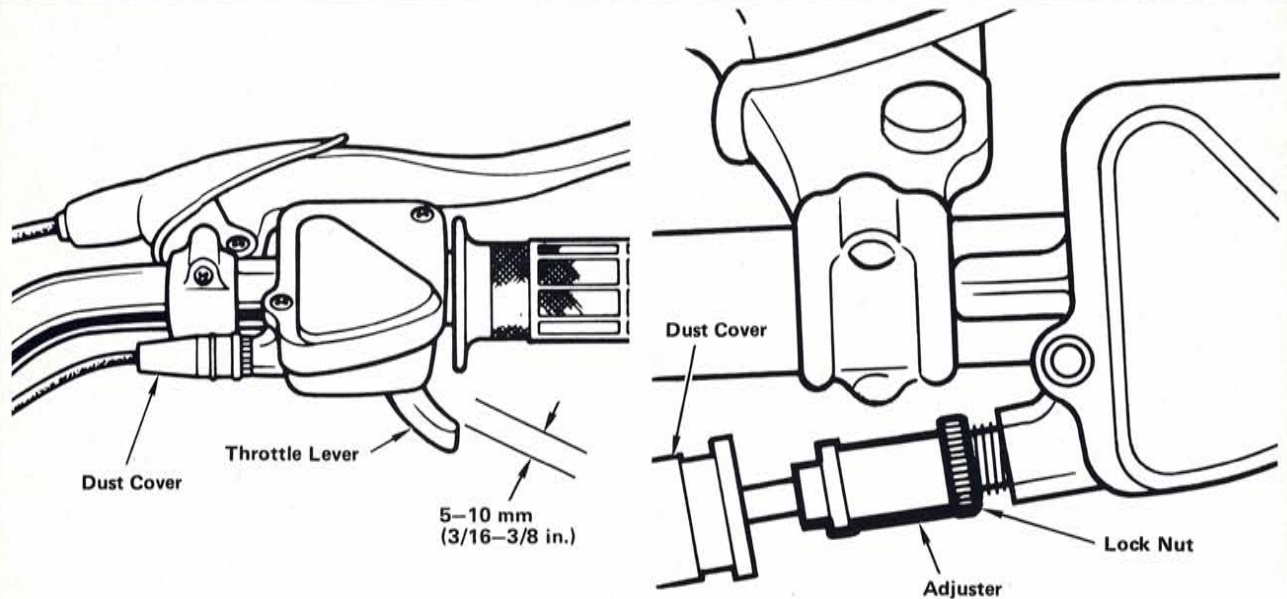

**STEP 48**—Check throttle cable for condition. Check that throttle lever free play is within 5–10 mm (3/16–3/8 in.) at tip of throttle lever. Check for smooth operation of throttle lever from fully closed to fully open in all steering positions and that throttle lever automatically returns from fully open to fully closed when released. If necessary to adjust free play, slide dust cover back to expose adjuster, loosen lock nut and turn adjuster to obtain correct free play. After adjustment, tighten lock nut and reinstall dust cover.

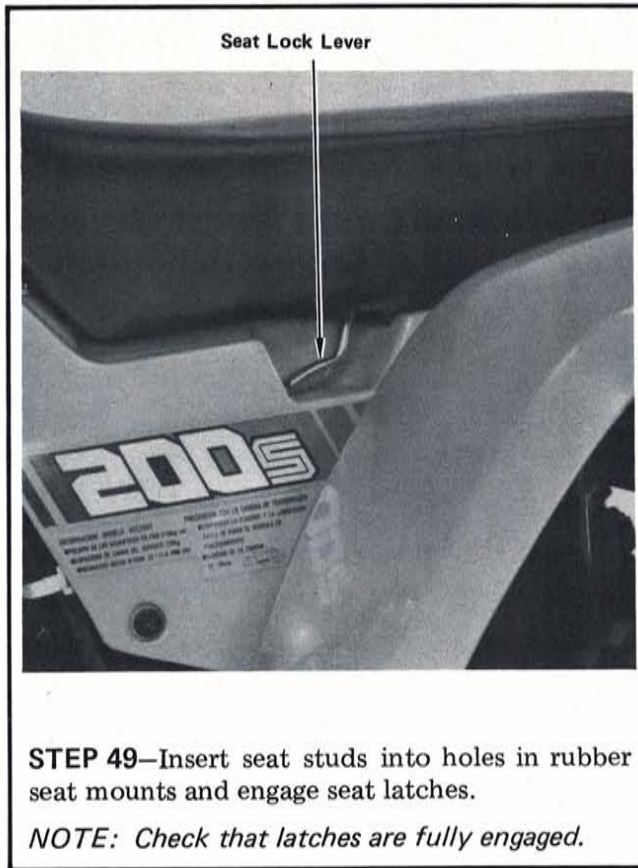

**STEP 49**—Insert seat studs into holes in rubber seat mounts and engage seat latches.

*NOTE: Check that latches are fully engaged.*

**TORQUE TABLE**

ITEM	SIZE	TORQUE
Fork bolts	-----	6.0 kg-m (44 lb-ft)
Handlebar upper holder bolts	-----	2.7 kg-m (19 lb-ft)
Fork leg bolts	10 mm	4.5 kg-m (32 lb-ft)
Front fender bolts	6 mm	1.0 kg-m ( 8 lb-ft)
Front axle	-----	9.0 kg-m (70 lb-ft)
Axle holder nuts	-----	1.2 kg-m ( 9 lb-ft)
Carrying handle bolts	8 mm	2.7 kg-m (19 lb-ft)
Rear hub nuts	8 mm	2.2 kg-m (16 lb-ft)
Rear axle nuts	14 mm	7.0 kg-m (51 lb-ft)

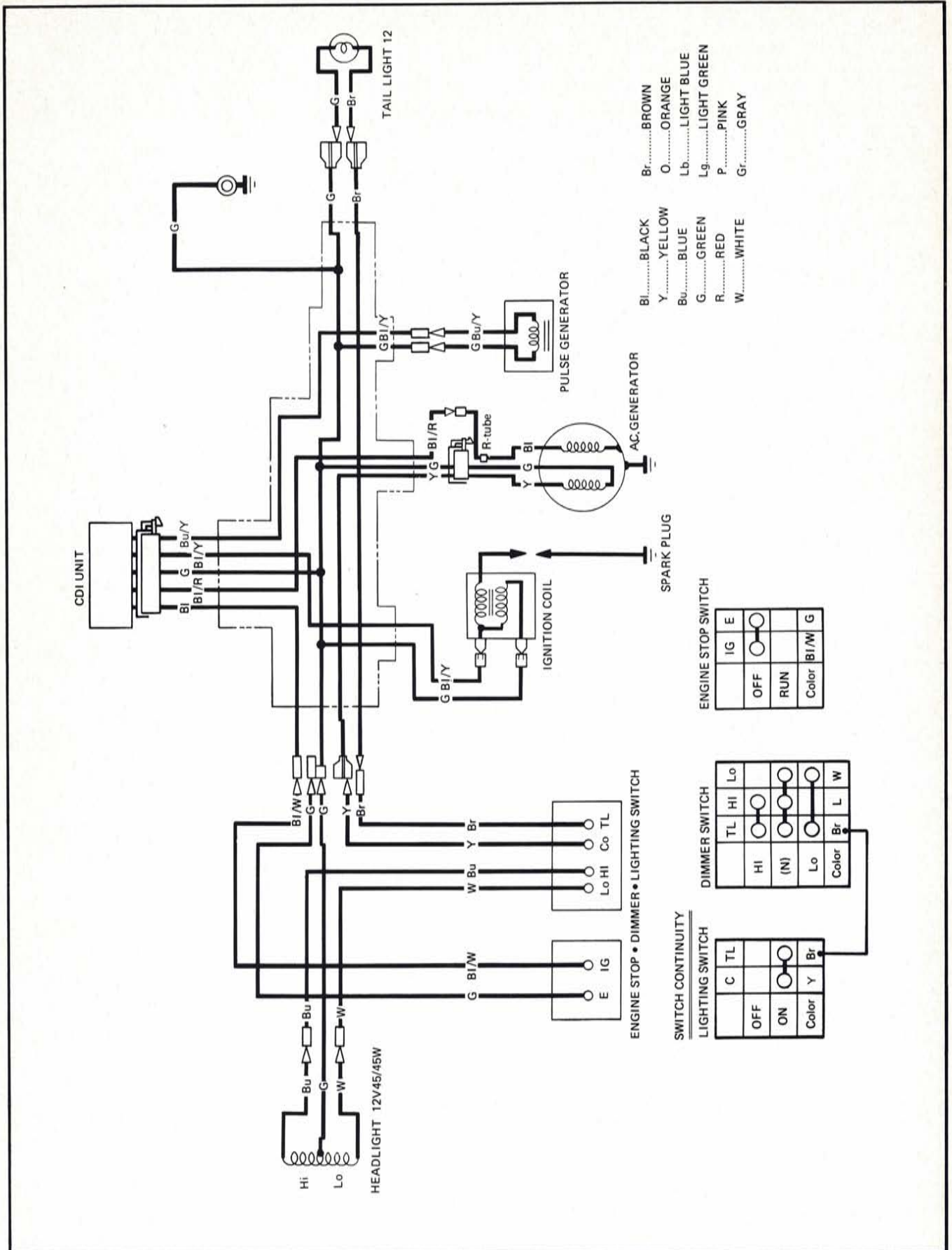

*NOTE: Check all items listed on the following Pre-delivery Service Check List. Refer to owner's manual or shop manual for specifications and detailed procedures. Always test ride the unit to make sure that it is functioning properly.*

### PRE-DELIVERY SERVICE CHECK LIST

- |  |   |
|--|---|
| <input type="checkbox"/> Adjust front and rear brakes, check cable routing and check operation.                  | <input type="checkbox"/> Check security of all nuts, bolts, and other fasteners.                                    |
| <input type="checkbox"/> Fill crankcase with recommended oil.  | <input type="checkbox"/> Check to ensure that all applicable recall and product update campaigns are complied with. |
| <input type="checkbox"/> Remove and inspect fuel tank, drain and flush.  | <input type="checkbox"/> <b>TEST RIDE:</b> Check performance, handling, and operation.                              |
| <input type="checkbox"/> Drain residual fuel from carburetor.  | <ul style="list-style-type: none"><li>• Transmission and clutch: Ease of shifting, clutch operation, etc.</li></ul> |
| <input type="checkbox"/> Check air filter element. Clean and oil if necessary.                                   | <ul style="list-style-type: none"><li>• Acceleration: Smoothness, etc.</li></ul>                                    |
| <input type="checkbox"/> Check operation of decompression system.  | <ul style="list-style-type: none"><li>• Cruising: Smoothness, etc.</li></ul>  |
| <input type="checkbox"/> Reinstall fuel tank, fill, turn on petcock and check for leaks.                         | <ul style="list-style-type: none"><li>• Handling: Stability and cornering.</li></ul>                                |
| <input type="checkbox"/> Adjust idle speed.  | <ul style="list-style-type: none"><li>• Brakes: Smoothness and stopping power.</li></ul>                            |
| <input type="checkbox"/> Check throttle lever free play, cable routing, and operation in all steering positions. | <ul style="list-style-type: none"><li>• Idling: Smoothness, throttle response, and return to idle.</li></ul>        |
| <input type="checkbox"/> Adjust and lubricate drive chain.   | <ul style="list-style-type: none"><li>• Recheck idle speed after 10 minutes of stop and go operation.</li></ul>     |
| <input type="checkbox"/> Check tire pressure.  | <ul style="list-style-type: none"><li>• Parking brake operation.</li></ul>  |
| <input type="checkbox"/> Inspect electrical components for proper operation and adjustment.                      | <ul style="list-style-type: none"><li>• Upon completion of test ride, check for fuel and oil leaks.</li></ul>       |
| <ul style="list-style-type: none"><li>• Headlight switch.</li></ul>  |   |
| <ul style="list-style-type: none"><li>• Headlight: Adjust high beam aim.</li></ul>                               |   |
| <ul style="list-style-type: none"><li>• Taillight.</li></ul>   |   |
| <ul style="list-style-type: none"><li>• Engine stop switch.</li></ul>  |   |

## LOOSE PARTS

The following is a list of loose parts contained in the crate.

PART NAME	QTY	H/C	PART NUMBER
Handlebar cover	1	1274745	53205-958-003
Panel, handlebar cover	1	1274760	53206-958-003
Screw-washer, 6 x 20 mm	2	0878538	93891-06020-08
Front fender	1	-----	61100-958-670
Front mud guard	1	1647627	61111-VM4-000
Special nut, 6 x 7 mm	13	0955575	61304-958-003
Screw, 6 x 7 mm	3	0810655	90102-673-003
Front fender mounting collar	4	0763946	61104-444-000
Front fender mounting rubber	4	0680678	61103-430-000
Bolt, flange, 10 x 35 mm	4	1299189	90118-958-000
Bolt, flange, 6 x 25 mm	4	0484485	95700-06025-00
Right front fork	1	1671445	51400-VM4-003
Left front fork	1	1671452	51500-VM4-003
Brake return spring	1	0271056	95014-73100
Brake arm joint	1	0257758	95015-32000
Brake rod adjusting nut	1	0710921	43459-434-000
Front wheel	1	-----	-----
Front axle	1	1813450	44301-VM4-680
Axle collar	1	1813468	44312-VM4-680
Rear wheel	2	-----	-----
Washer, 14 mm	2	1074327	42322-950-000
Castle nut, 14 mm	2	0109454	94011-14000
Cotter pin	2	0058420	94201-30250
Rear wheel hub	2	-----	42410-VM4-680
Reinforcement plate	4	1647478	44714-958-670
Nut, flange, 8 mm	8	1420231	90309-KF0-003
Right rear mud guard	1	1647676	80111-VM4-003
Left rear mud guard	1	1647692	80112-VM4-003
Screw, mud guard	10	1798339	90103-VM4-003
Carrying handle	1	1647759	81200-VM4-000
Bolt, flange, 8 x 16 mm	4	0631242	95700-08016-00
Owner's manual	1	-----	31VM4610
Front brake panel	1	-----	45000-VM4-680
Skid plate	1	-----	50355-VM4-680
Bolt, skid plate	4	1647882	90118-VM4-000
Washer, plain, 6 mm	4	0059071	94101-06000

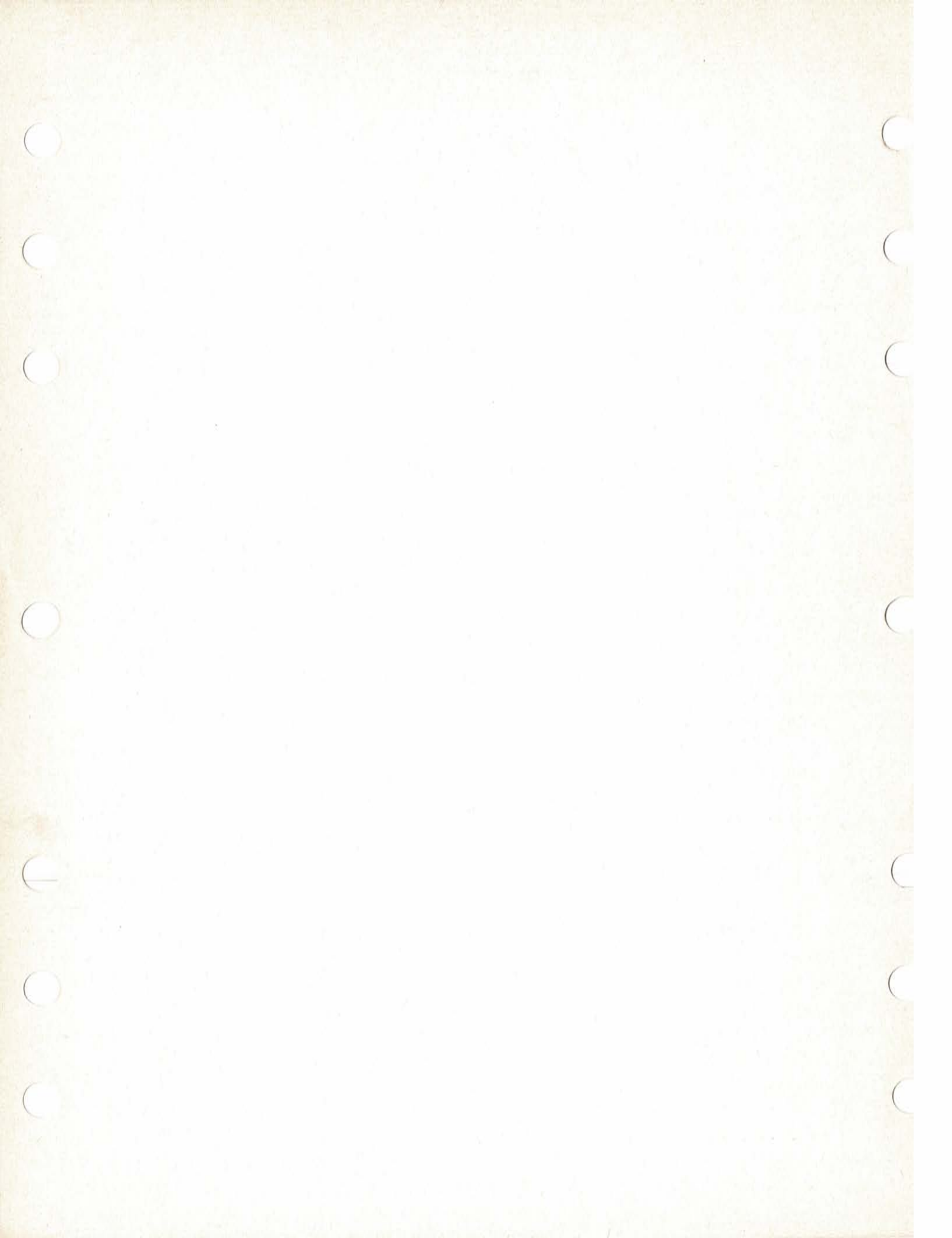



READ THIS READ THIS READ THIS

READ THIS READ THIS READ THIS

# HONDA

Modifications which you have made, or should make in the future, to any Honda product, shall be deemed by our company to have been performed at your sole risk and responsibility, and without our company's or the manufacturer's approval or consent, implied or expressed. We further disclaim any and all liability, obligation, or responsibility for any defects of modified parts or of the modified product, and for any claims, demands, or causes of action for damage to property or for personal injuries resulting from the modification of said Honda product.

READ THIS READ THIS READ THIS