

Set-up Instructions

1985 Model ATC 250ES



MPD 7632-8750 8504

AMERICAN HONDA MOTOR CO., INC.
100 WEST ALONDRA BOULEVARD, GARDENA, CALIFORNIA 90247

WARNING

WARNING

WARNING

WARNING

SET-UP AND PRE-DELIVERY SERVICE MUST BE PERFORMED BY AN AUTHORIZED HONDA ALL TERRAIN VEHICLE (ATV) DEALER. Proper set-up and pre-delivery service is essential to rider safety and reliability of the vehicle. When a customer takes delivery of his brand new vehicle he expects it to be in excellent running condition. There are few things that will cause greater customer dissatisfaction than poor preparation of a new vehicle. An error or oversight made by the mechanic assembling and servicing a new unit can easily result in faulty operation, damage to the vehicle, or even injury to the rider.

NOTE: The black vertical bars near the edge of the pages as shown here, indicate changes. Read carefully.



NOTE: Right and left are determined from the rider's view.

Date of Issue: 7/84 This page supersedes page 1 revised 10/84. Remove and destroy superseded page. Rev. 4/85

Set-up Instructions

1985 Model ATC 250ES



MPD 7632-8144 8410

AMERICAN HONDA MOTOR CO., INC.
100 WEST ALONDRA BOULEVARD, GARDENA, CALIFORNIA 90247

WARNING

WARNING

WARNING

WARNING

SET-UP AND PRE-DELIVERY SERVICE MUST BE PERFORMED BY AN AUTHORIZED HONDA ALL TERRAIN VEHICLE (ATV) DEALER. Proper set-up and pre-delivery service is essential to rider safety and reliability of the vehicle. When a customer takes delivery of his brand new vehicle he expects it to be in excellent running condition. There are few things that will cause greater customer dissatisfaction than poor preparation of a new vehicle. An error or oversight made by the mechanic assembling and servicing a new unit can easily result in faulty operation, damage to the vehicle, or even injury to the rider.

NOTE: The black vertical bars near the edge of the pages as shown here, indicate changes. Read carefully.



NOTE: Right and left are determined from the rider's view.

Date of Issue: 7/84 This page supersedes page 1 dated 7/84. Remove and destroy superseded page. Rev. 10/84

SET-UP INSTRUCTION REVISED PAGES

Pages Affected	Orig. Issue Date	Rev. Date
1 through 38	7/84	Original
1, 2, and 31	7/84	10/84
1, 2, 11, 15, and 37	7/84	4/85

Remove and destroy superseded pages.

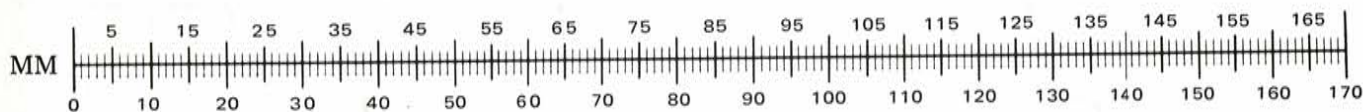

METRIC SCALE FOR DETERMINING BOLT LENGTHS/DIAMETERS

Pay special attention to warnings, cautions, and notes.

WARNING means hazards or unsafe practices which could cause severe personal injury or death.

CAUTION: means hazards or unsafe practices which could cause minor personal injury or product or property damage.

NOTE: gives helpful information.

This page supersedes page 2 revised 10/84. Remove and destroy superseded page.

Rev. 4/85

SET-UP INSTRUCTION REVISED PAGES

Pages Affected	Orig. Issue Date	Rev. Date
1 through 38	7/84	Original
1, 2, and 31	7/84	10/84

Remove and destroy superseded pages.

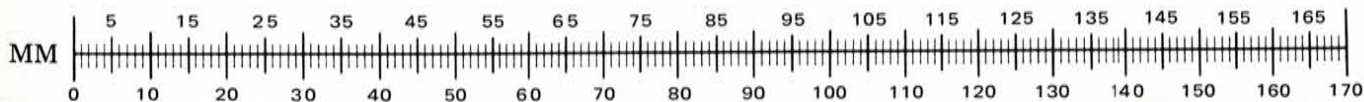

METRIC SCALE FOR DETERMINING BOLT LENGTHS/DIAMETERS

Pay special attention to warnings, cautions, and notes.

WARNING means hazards or unsafe practices which could cause severe personal injury or death.

CAUTION: means hazards or unsafe practices which could cause minor personal injury or product or property damage.

NOTE: gives helpful information.

This page supersedes page 2 dated 7/84. Remove and destroy superseded page.

Rev. 10/84

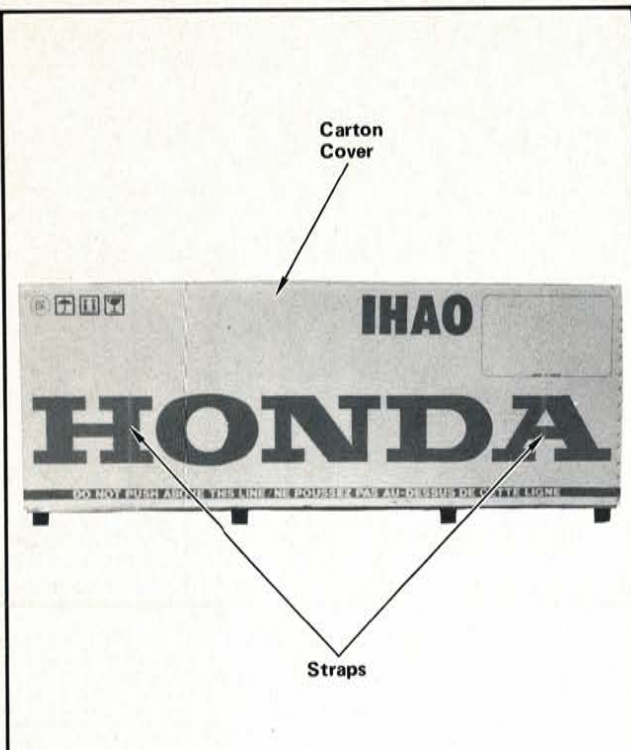

STEP 1—Cut straps and remove carton cover by lifting it up.

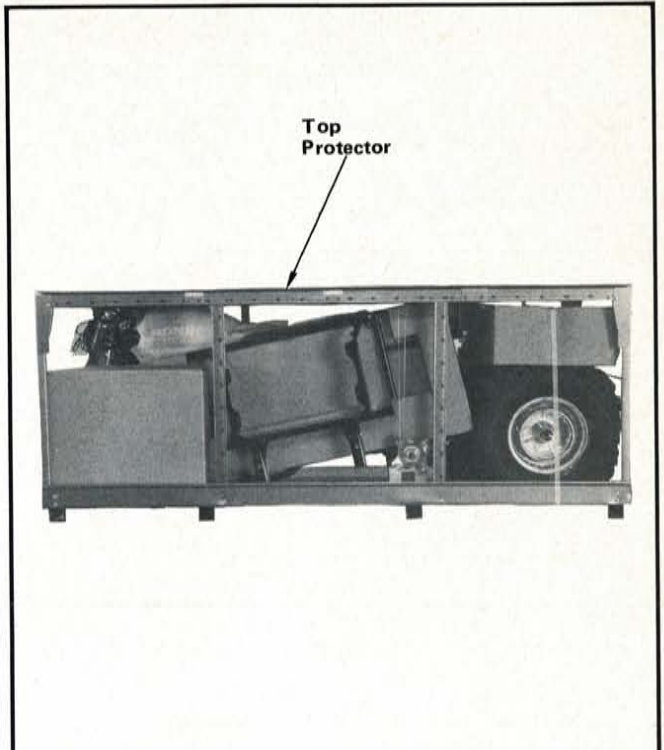

STEP 2—Remove and discard crate top protector.

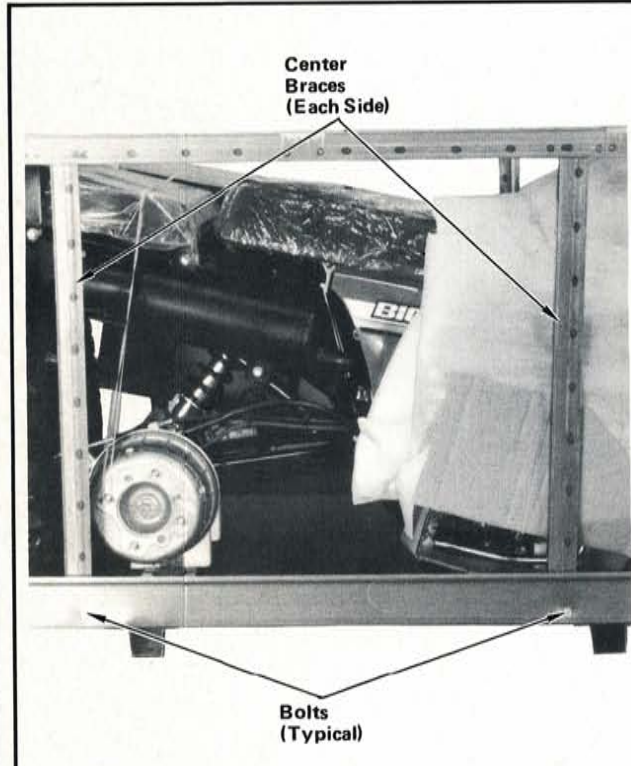

STEP 3—Remove bolts attaching center braces to crate base. Discard bolts and loose braces.

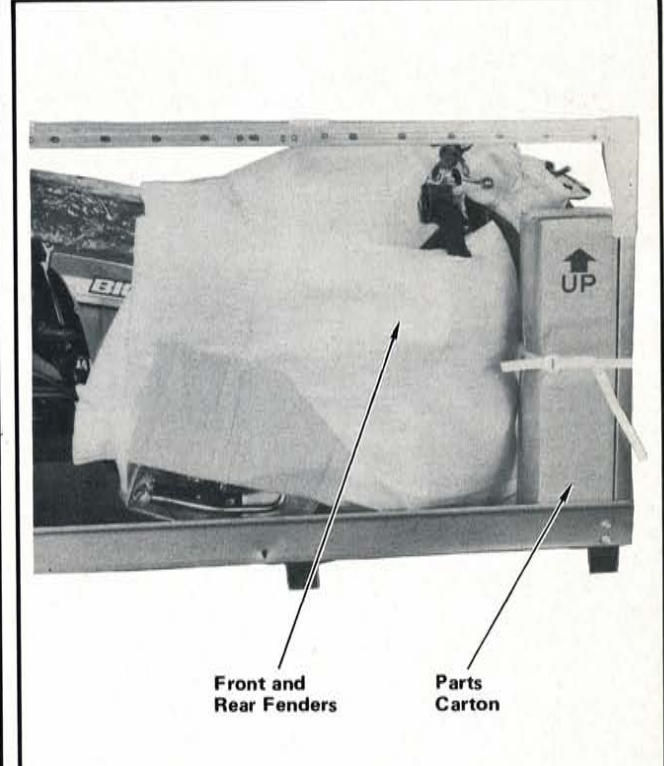

STEP 4—Remove parts carton and fenders.

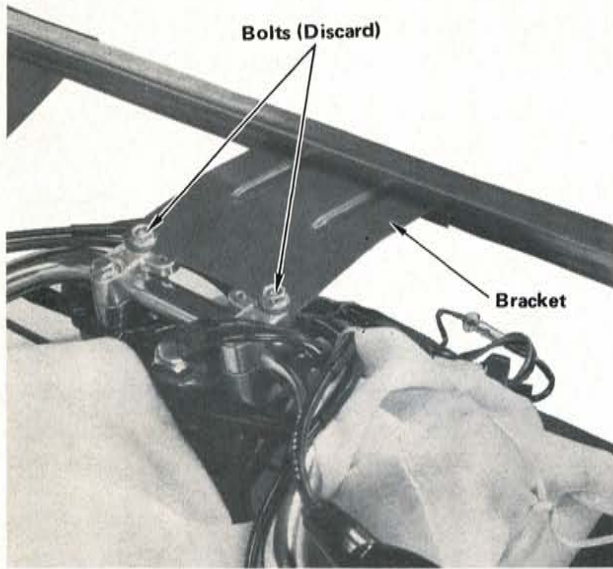

STEP 5—Remove and discard two bolts attaching front shipping brace bracket to handlebar upper holders.

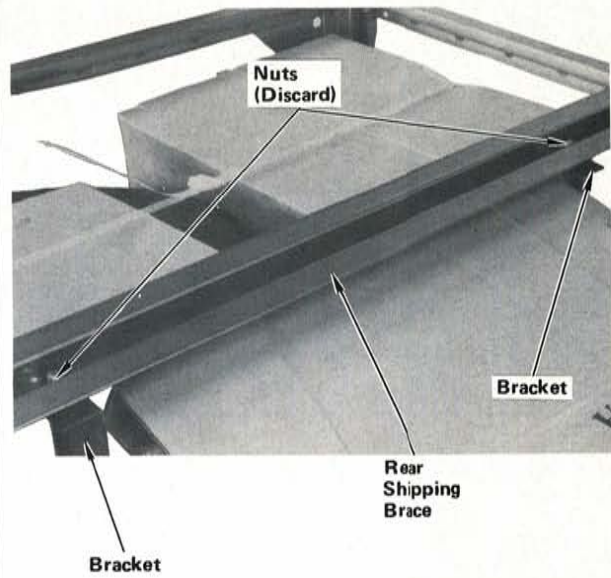

STEP 6—Remove and discard nuts attaching rear shipping brace to rear shipping brace brackets.

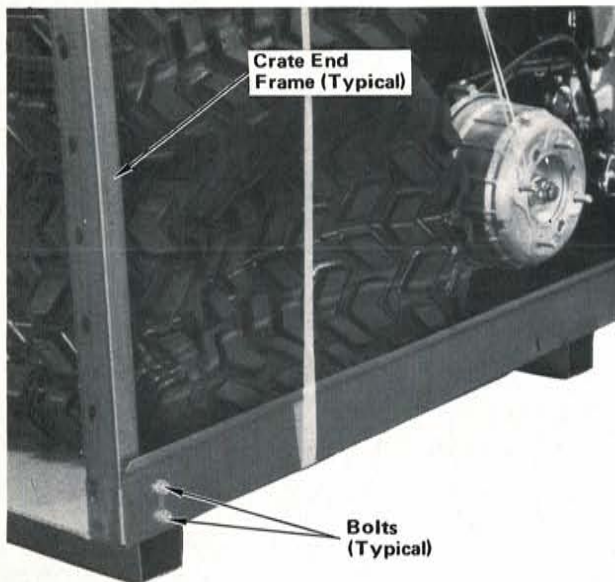

STEP 7—Remove and discard bolts attaching crate end frames to crate base. Carefully lift off crate frame using two people.

CAUTION: Use extreme care not to damage vehicle or parts with crate frame.

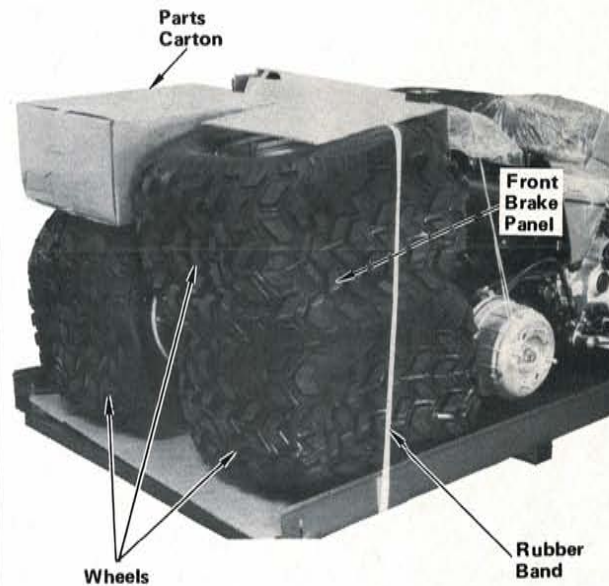

STEP 8—Remove parts carton, wheels, and front brake panel, by removing rubber band.

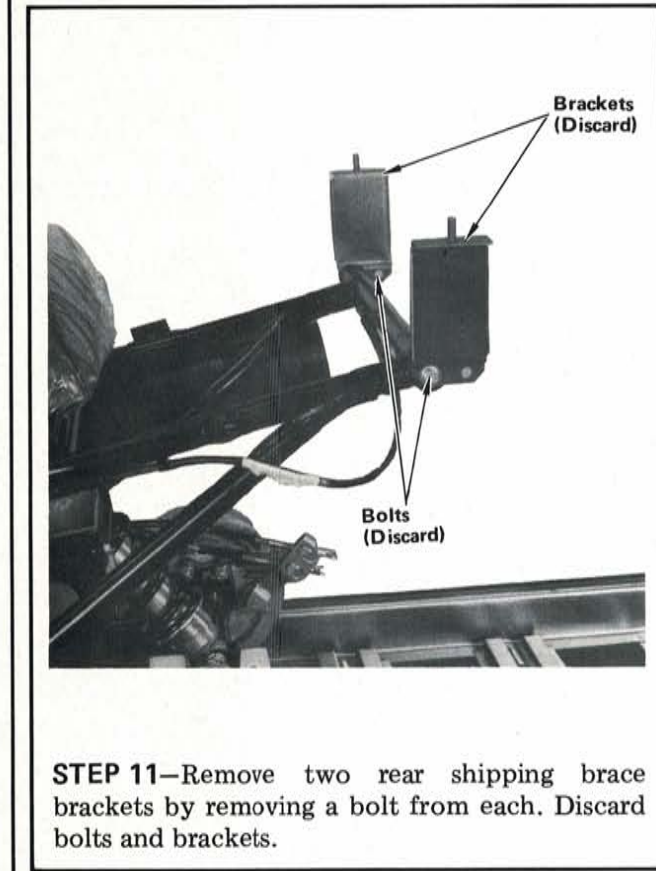
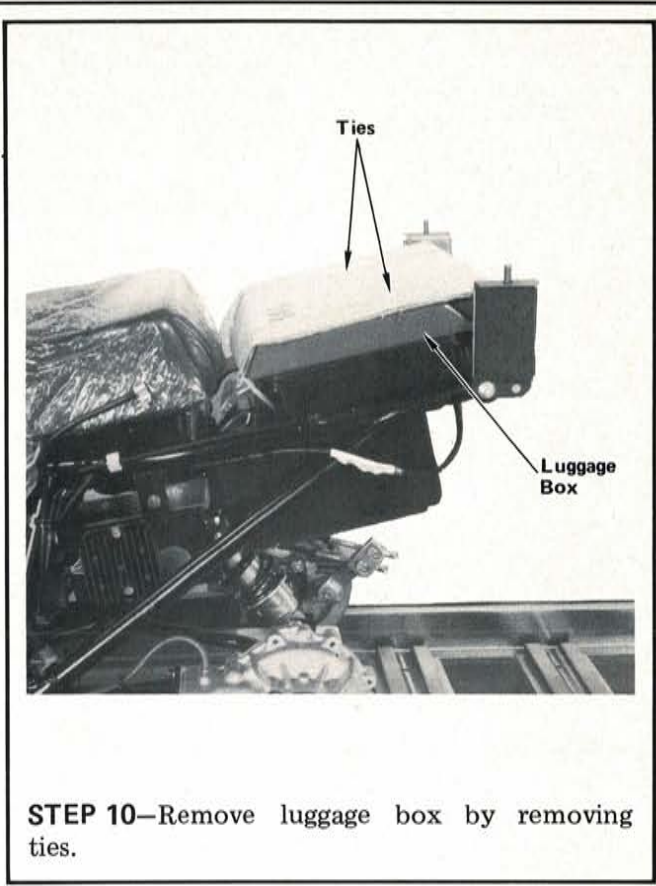
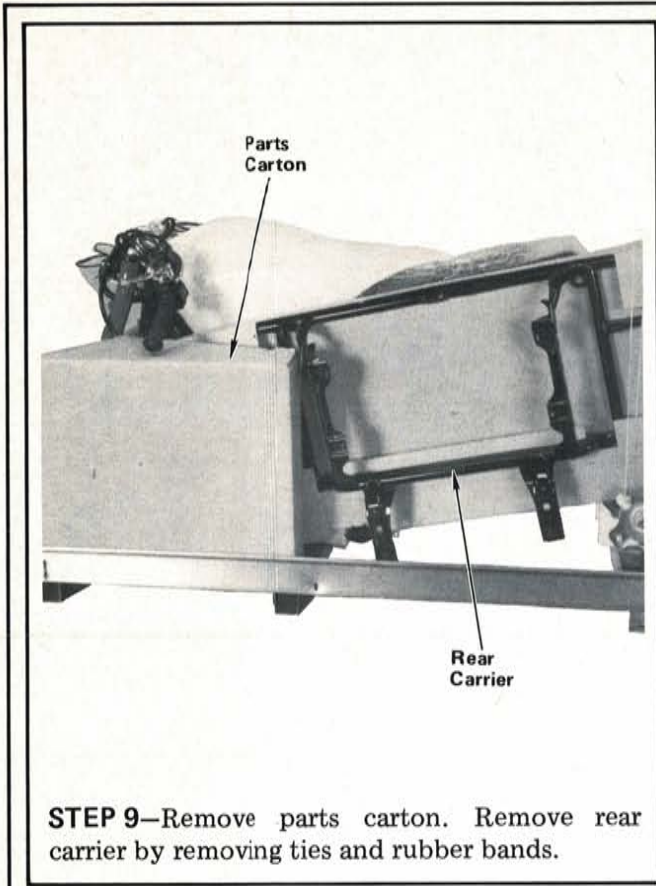

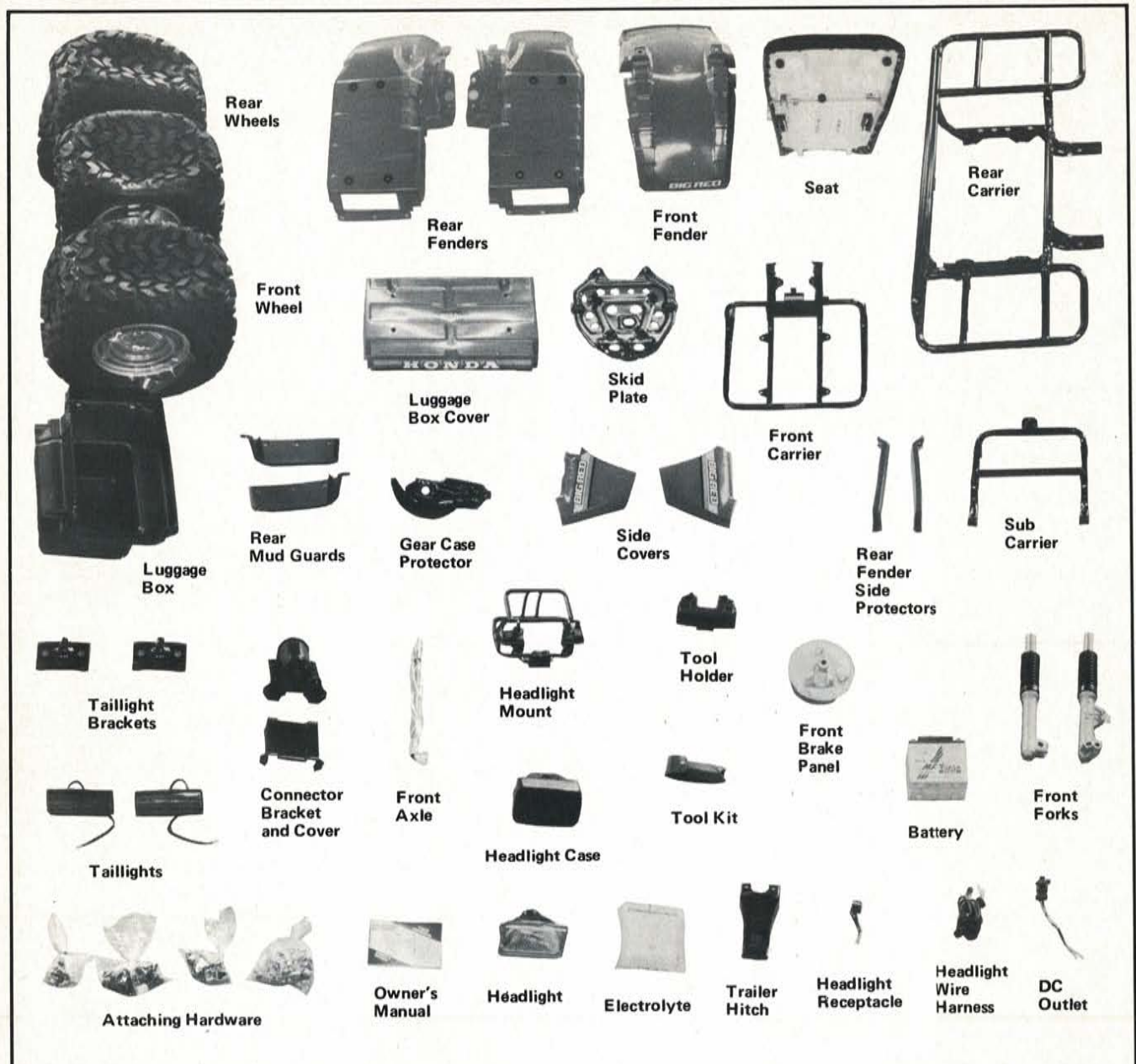

STEP 13—Unpack remaining loose parts and check against this illustration. Report any damaged or missing parts immediately to American Honda Motor Co., Inc., 100 West Alondra Blvd., Gardena, California 90247.

Damaged or Missing Parts

Identify missing parts by referring to the “Loose Parts List” at the end of the set-up. Order parts through normal parts ordering procedures.

It is necessary to differentiate between parts lost or damaged in transit, and parts left out by the factory.

- For parts lost or damaged in transit, file a SHIPPING DAMAGE CLAIM.
- For parts left out by the factory, file a M/C WARRANTY CLAIM SO 908.

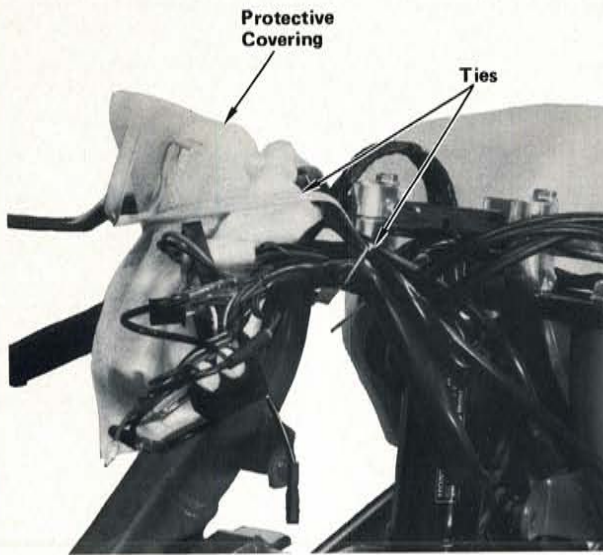

STEP 14—Remove protective covering and release wire harnesses by removing ties.

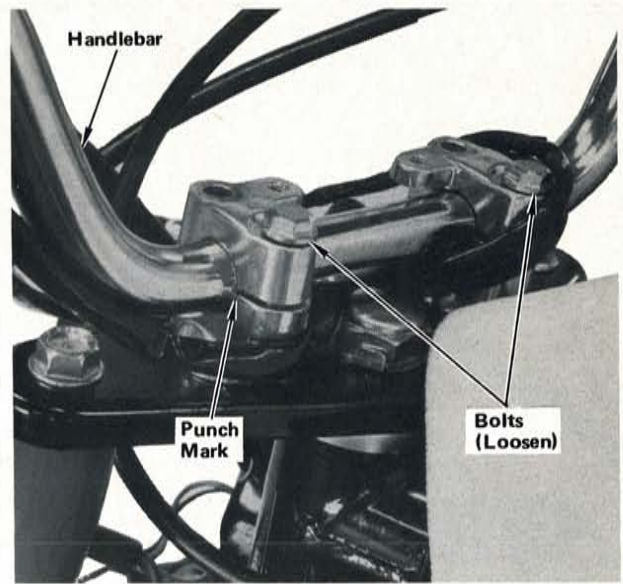

STEP 15—Loosen handlebar holder bolts. Lift handlebar grips up until punch mark on handlebar is aligned with top of lower holder.

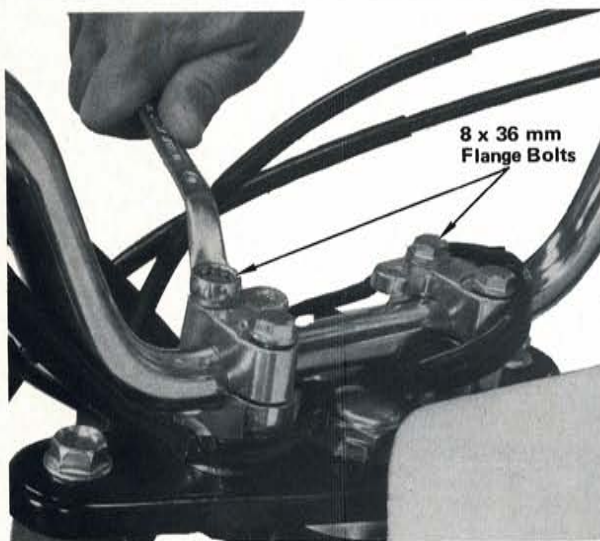

STEP 16—Insert two 8 x 36 mm flange bolts through forward holes of handlebar upper holders. Tighten forward bolts to specified torque first then tighten rear bolts to same torque.

Torque specification:
2.4 kg-m (18 lb-ft)

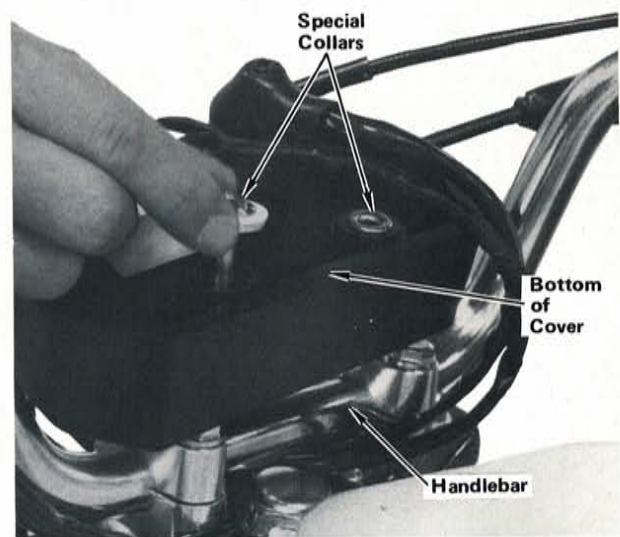

STEP 17—Press two special collars up through holes of handlebar cover from underneath as shown.

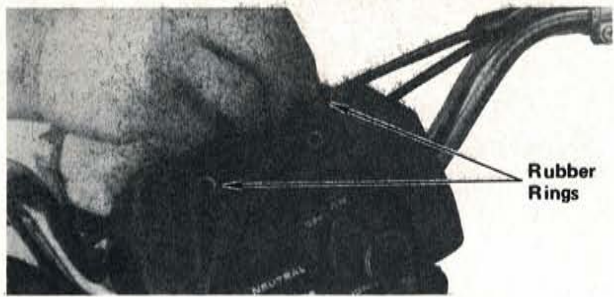

Rubber Rings

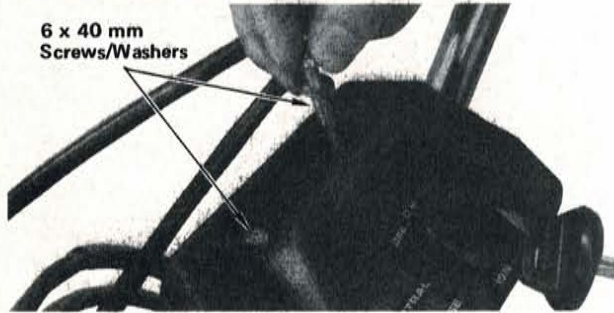

6 x 40 mm
Screws/Washers

STEP 18—Press a rubber ring over each collar and down into recesses of handlebar cover. Position cover over handlebar upper holders as shown and install using two 6 x 40 mm screws/washers. Tighten screws securely.

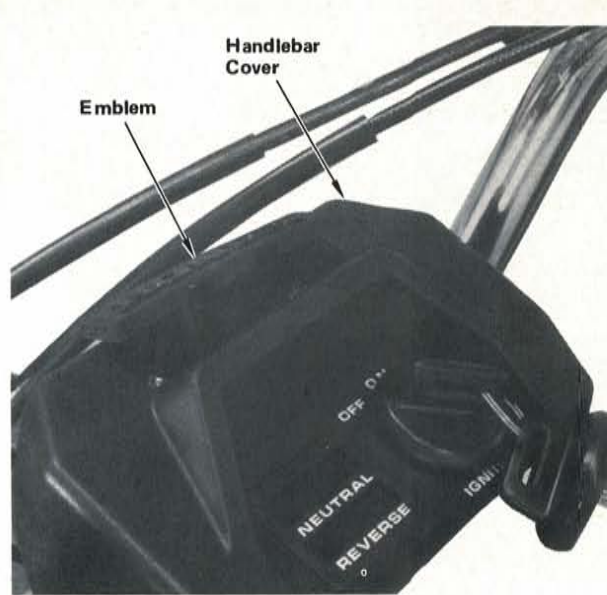

Handlebar
Cover

Emblem

STEP 19—Press emblem into handlebar cover as shown.

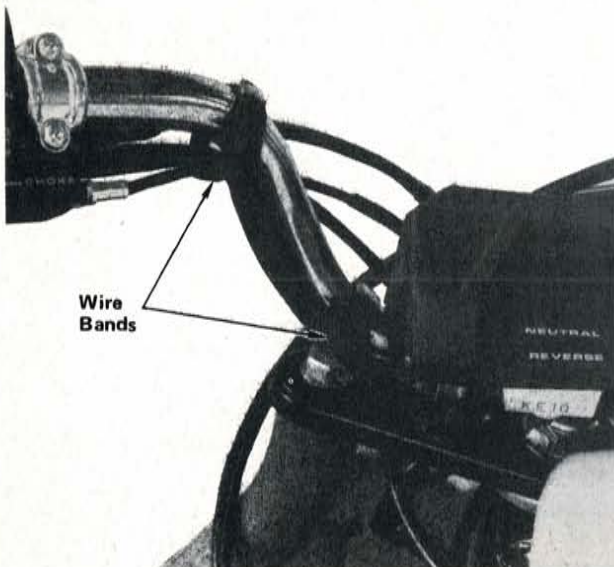

Wire
Bands

STEP 20—Secure left handlebar switch wires to handlebar using two wire bands positioned where shown.

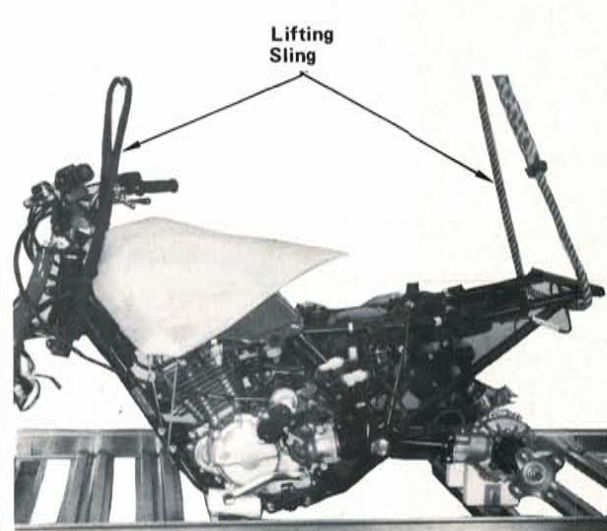

Lifting
Sling

STEP 21—Position a lifting sling as shown and carefully lift vehicle off of crate base. Remove and discard crate base.

CAUTION: Use extreme care not to damage fuel tank, wire harnesses, or cables with lifting sling.

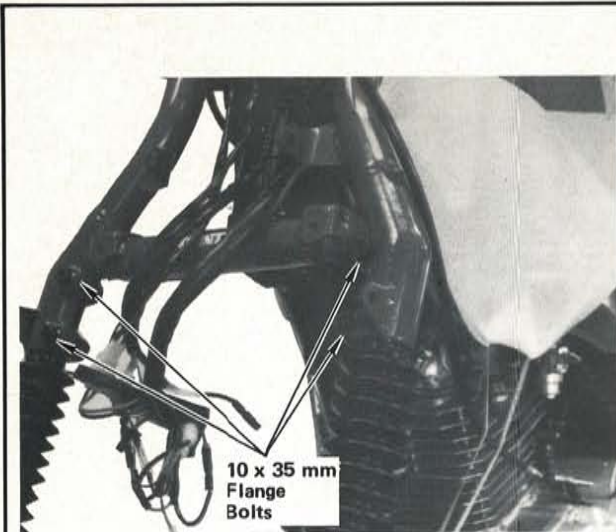

STEP 22—Insert left and right fork legs up into lower fork bridge. (Fork leg with axle holder goes on right side.) Align groove in upper end of each fork leg with upper hole in lower fork bridge. Install four 10 x 35 mm black flange bolts through fork holes as shown. Do not tighten bolts at this time.



STEP 23—Remove valve caps from all three tires and tighten valve cores. Inflate and check tire pressure of all three tires. Reinstall valve caps.

Tire pressure: 2.2 psi.



STEP 24—Insert axle collar into front wheel grease seal as shown.

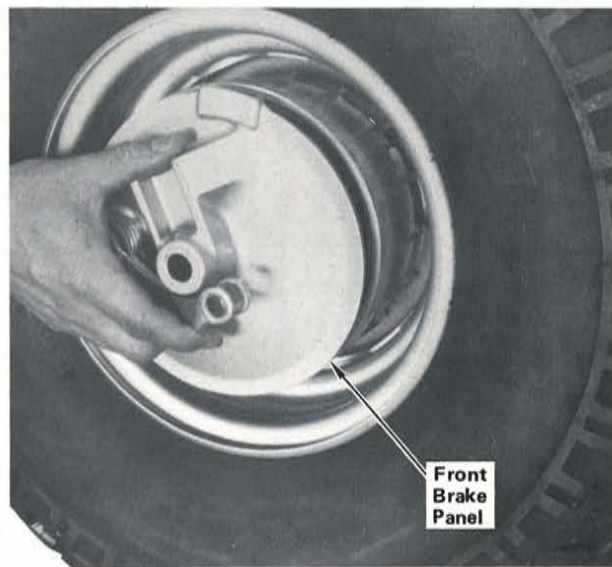

STEP 25—Clean front wheel brake drum and brake linings. Insert front brake panel into brake drum as shown.

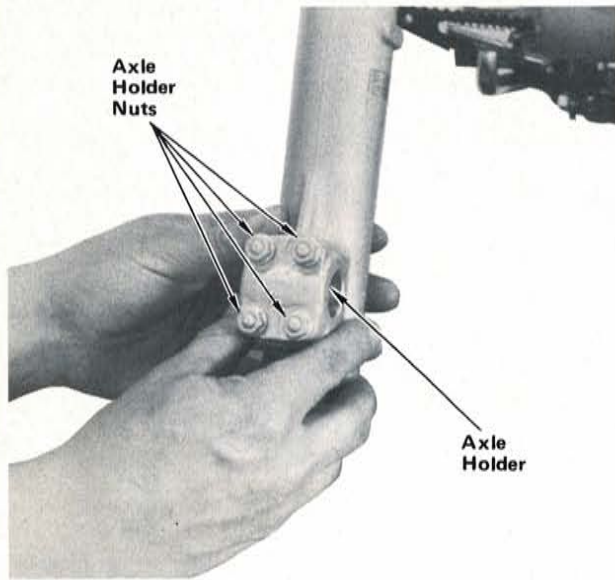

Axle Holder Nuts

Axle Holder

STEP 26—Loosen four axle holder nuts.

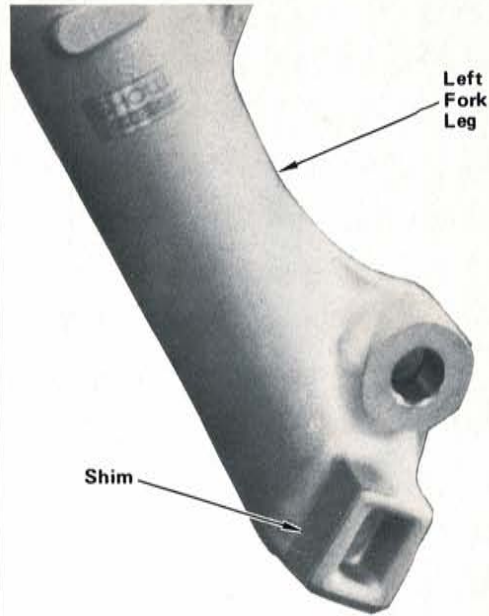

Left Fork Leg

Shim

STEP 27—On early models, it is necessary to place a shim on the left fork leg tongue as shown.

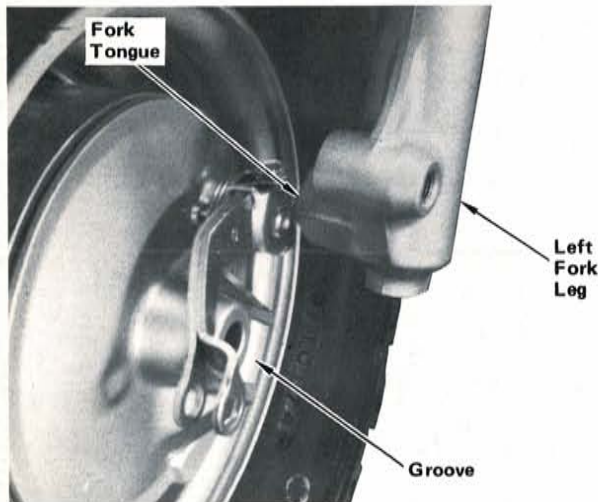

Fork Tongue

Left Fork Leg

Groove

STEP 28—Position front wheel between front fork legs with brake panel on left, and align groove on brake panel with tongue on left fork leg.

NOTE: On early models, be sure shim is still installed properly.

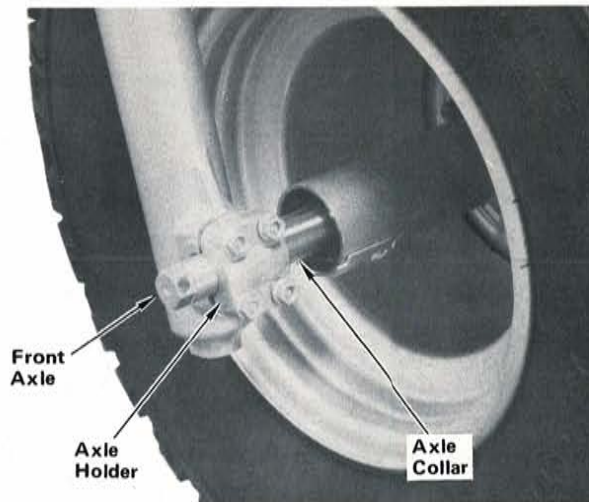

Front Axle

Axle Holder

Axle Collar

STEP 29—Insert front axle from right side, between axle holder and right fork leg, through axle collar, wheel hub, and screw into left fork leg. Tighten axle to specified torque.

Torque specification:
9.0 kg-m (68 lb-ft)

Axle Holder Nuts

Tightening Sequence

STEP 30—Tighten axle holder nuts to specified torque in sequence shown.

NOTE: Be sure to retighten #3 nut after tightening #4 nut.

Torque specification:
1.2 kg-m (9 lb-ft)

10 x 35 mm Flange Bolts

STEP 31—Tighten the four fork leg bolts to specified torque.

Torque specification:
5.5 kg-m (40 lb-ft)

Rear Wheel (Typical)

10 mm Nuts/Washers (Typical)

STEP 32—Insert studs of rear wheel hubs through rear wheels as shown. Install each hub using four 10 mm nuts/washers. Tighten nuts to specified torque. Remove lifting sling.

NOTE: Install rear wheels so tire tread directional pattern will be same as front tire.

Torque specification:
5.5 kg-m (40 lb-ft)

Protective Covering

STEP 33—Remove protective covering from fuel tank.

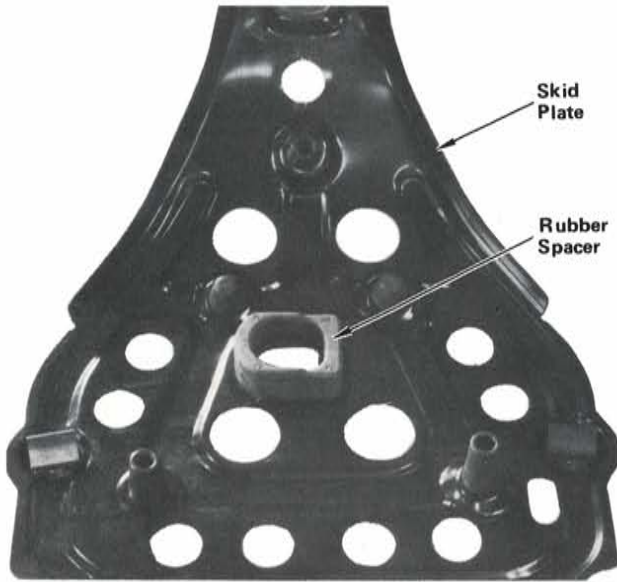

STEP 34—Position rubber spacer over drain plug hole in skid plate as shown.

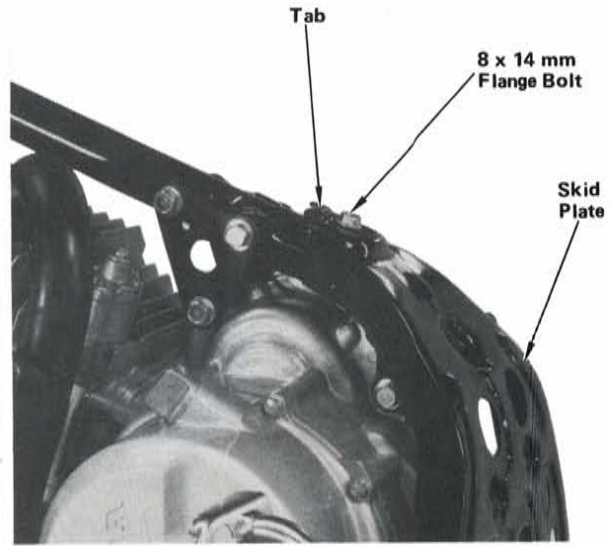

STEP 35—Insert tab on frame into slot in skid plate as shown. Attach front of skid plate to frame using an 8 x 14 mm flange bolt. Do not tighten bolt at this time.

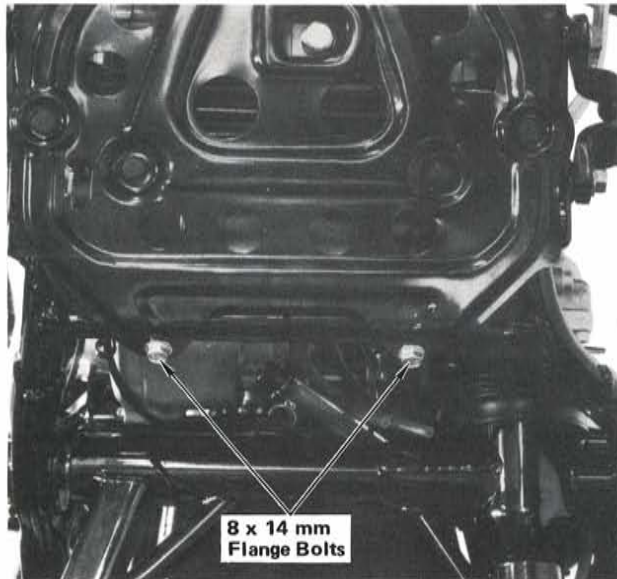

STEP 36—Attach rear of skid plate to frame using two 8 x 14 mm flange bolts. Tighten all three skid plate bolts to specified torque.

Torque specification:
2.7 kg-m (19 lb-ft)

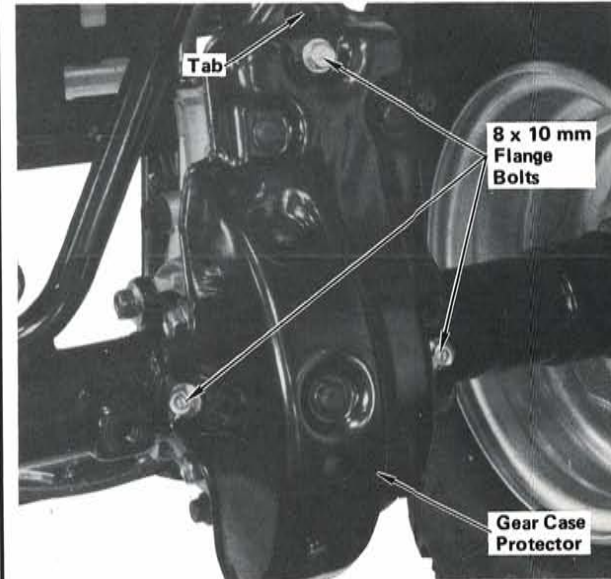

STEP 37—Hook tab on final drive gear case into slot in gear case protector and install using three 8 x 10 mm flange bolts as shown. Tighten bolts to specified torque.

Torque specification:
2.7 kg-m (19 lb-ft)

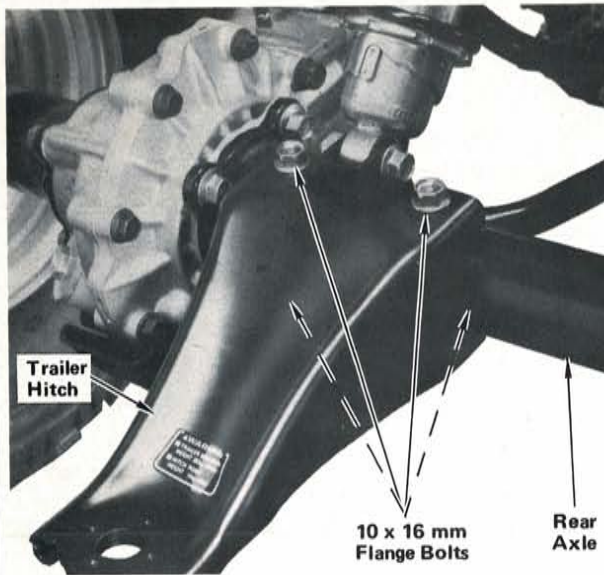

STEP 38—Position trailer hitch on rear axle as shown and install using four 10 x 16 mm flange bolts. Tighten bolts to specified torque.

Torque specification:
4.0 kg-m (30 lb-ft)

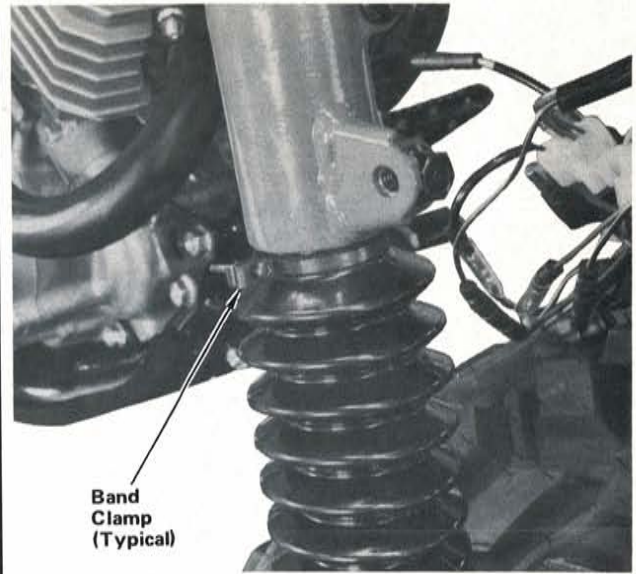

STEP 39—Position front fork boot band clamp screws towards the outside as shown, to prevent damaging front fender during installation. Tighten screws to prevent rotation of boots.

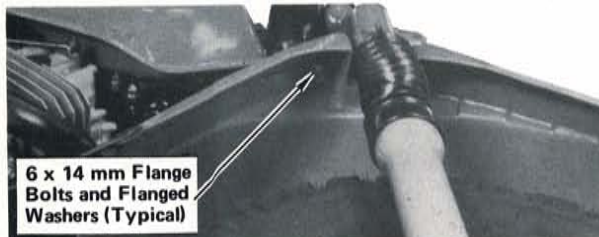
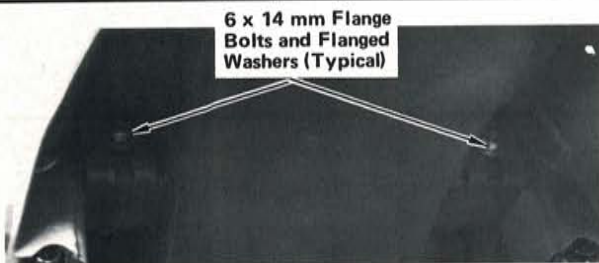

STEP 40—Position front fender between front fork legs with mud guard towards the rear. Install fender using four 6 x 14 mm bolts and flanged washers. Tighten bolts to specified torque.

Torque specification:
1.0 kg-m (8 lb-ft)

Reposition boot band clamp screws towards the rear and tighten securely.

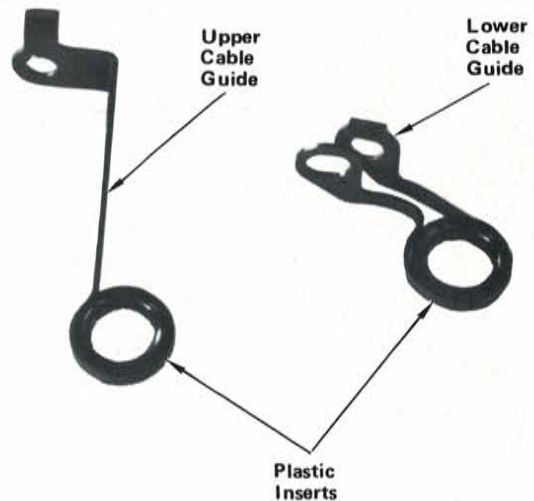

STEP 41—Install plastic inserts in upper and lower cable guides as shown.

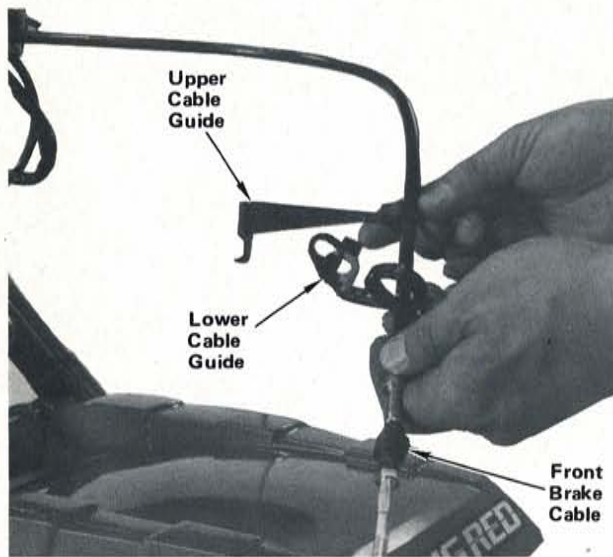

STEP 42—Route front brake cable through upper and lower cable guides as shown.

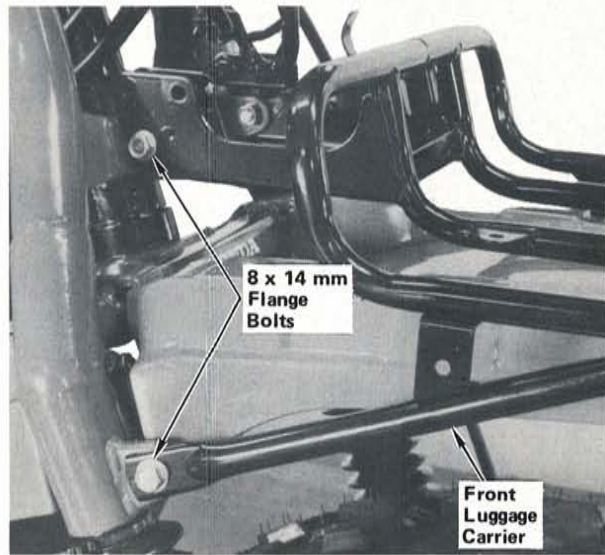

STEP 43—Position front luggage carrier on front fork tabs as shown, and install right side using two 8 x 14 mm flange bolts as shown. Do not tighten bolts at this time.

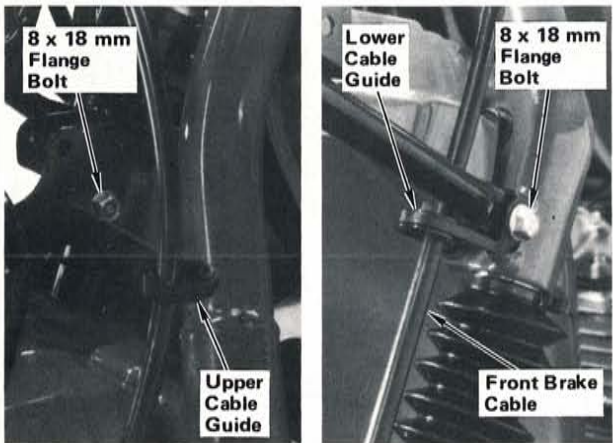

STEP 44—Position upper and lower front brake cable guides on front luggage carrier as shown, and install using two 8 x 18 mm flange bolts through cable guides, luggage carrier, and into front fork. Tighten all four luggage carrier bolts to specified torque.

Torque specification:
2.7 kg-m (19 lb-ft)

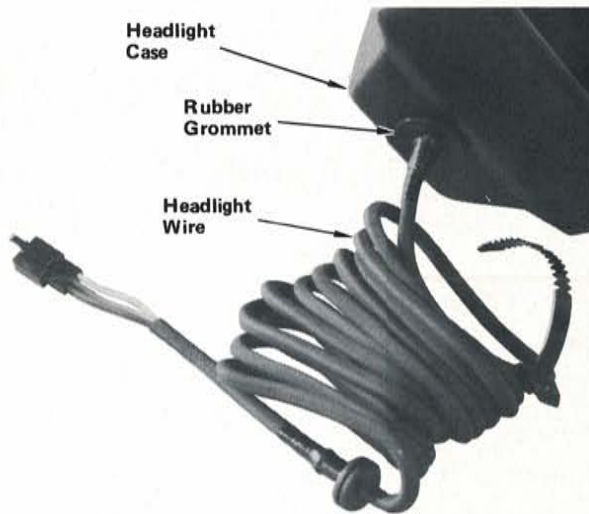

STEP 45—Insert indicated end of headlight wires into hole in headlight case and seat grommet.

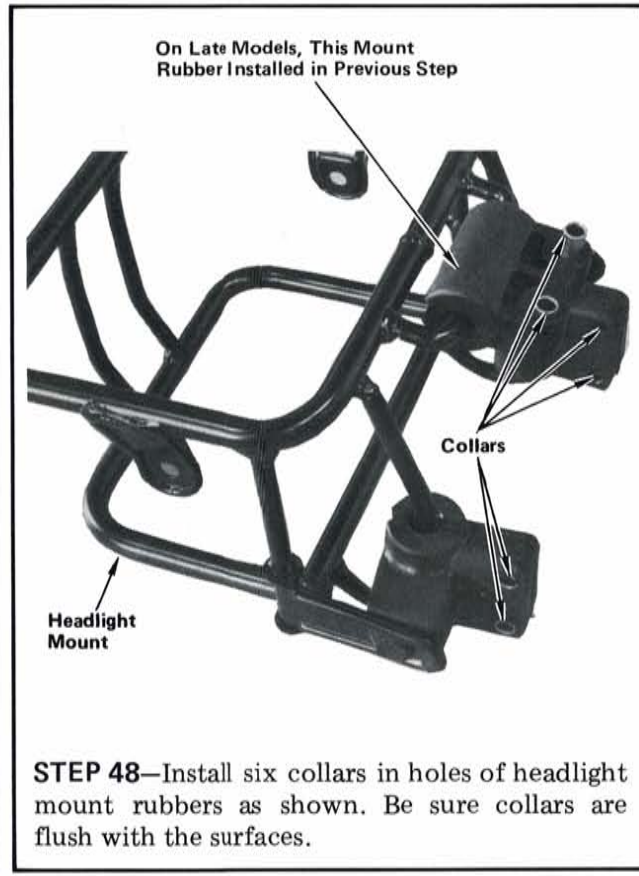
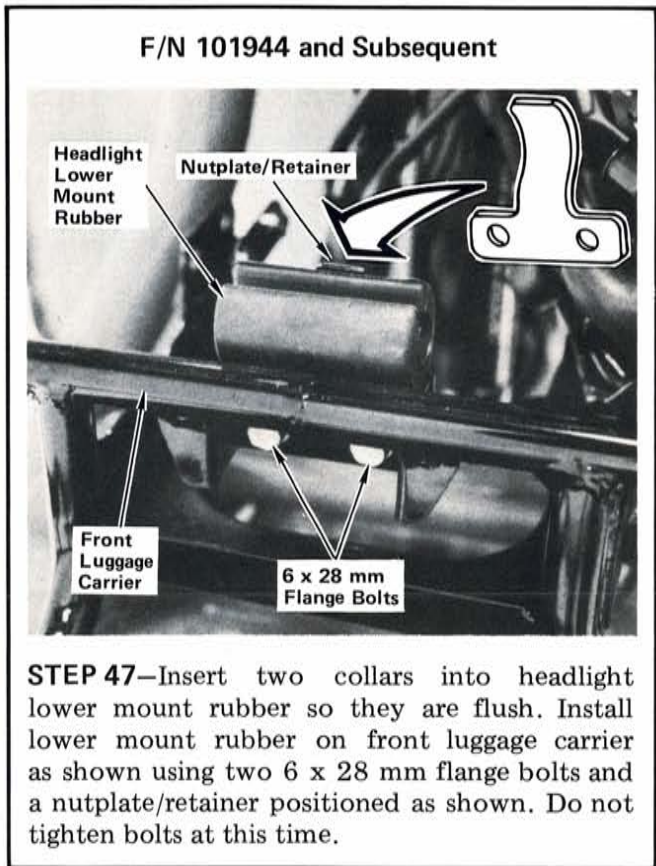

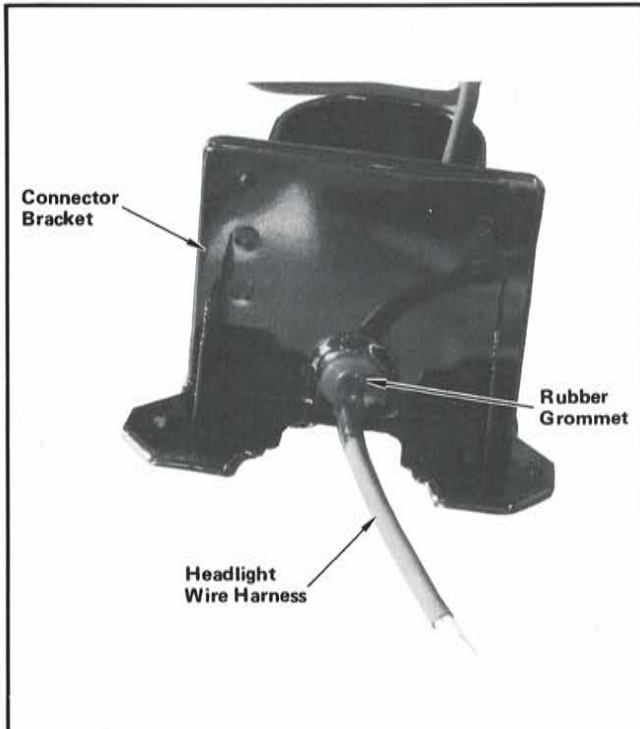

STEP 50—Route headlight wire harness through hole in connector bracket as shown, and install grommet in hole.

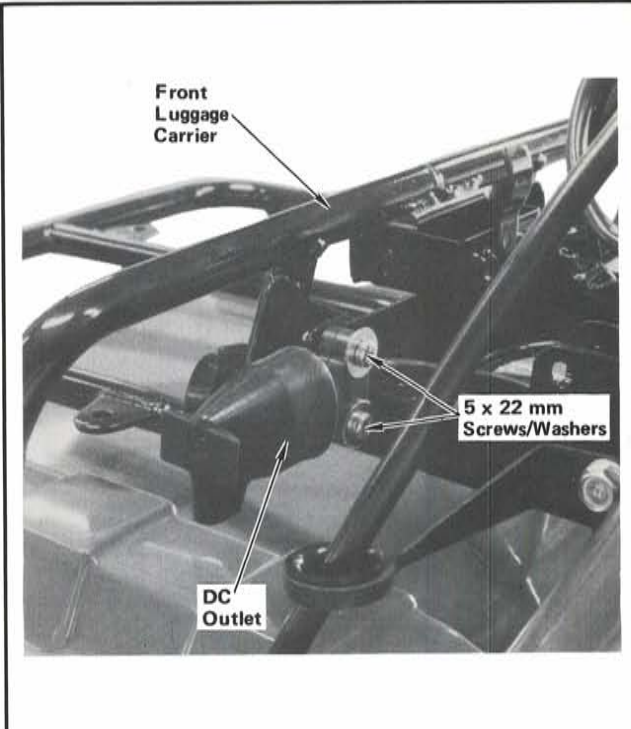

STEP 51—Install DC outlet as shown using two 5 x 22 mm screws/washers. Tighten screws securely.

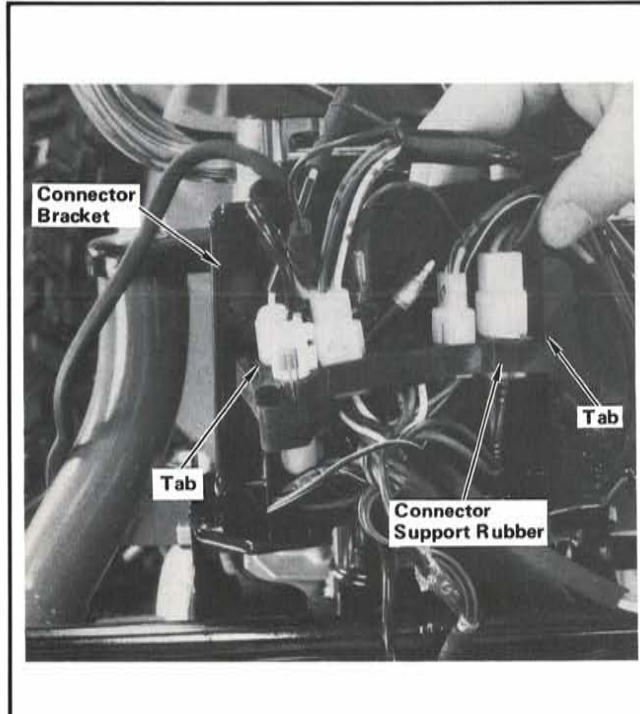

STEP 52—Position connector support rubber as shown and insert tabs of connector bracket into slits in ends of support rubber.

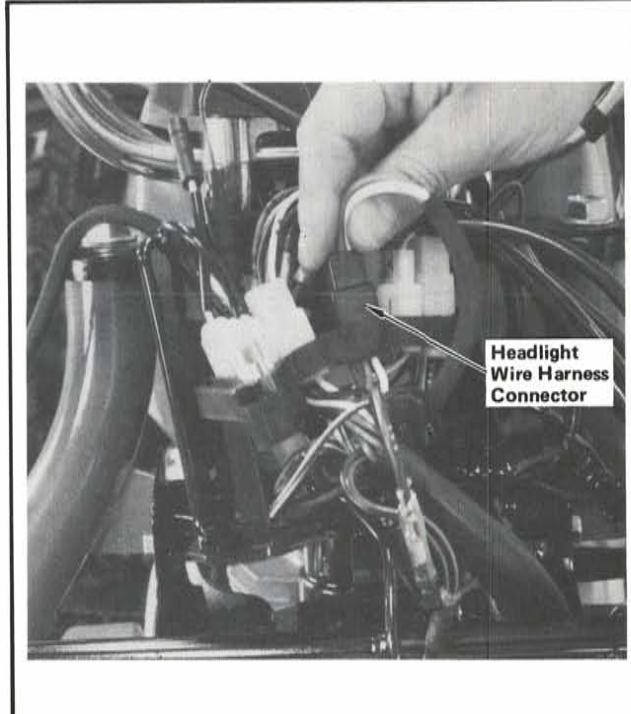

STEP 53—Connect headlight wire harness connector to connector in support rubber as shown.

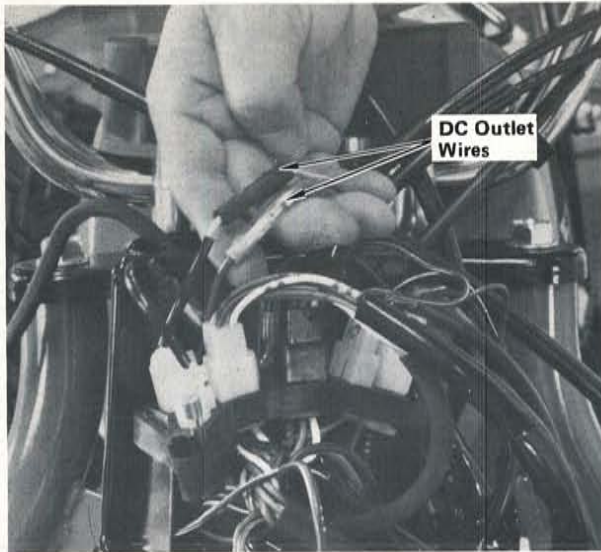

STEP 54—Connect DC outlet wires to wire harness color-to-color.



STEP 55—Insert the connector wires into the two holes of the wire protector grommet, and install the grommet on the bottom of the connector bracket as shown.

NOTE: If connector bracket has a protective rubber around the opening at the bottom, installation of the wire protector grommet is not required.

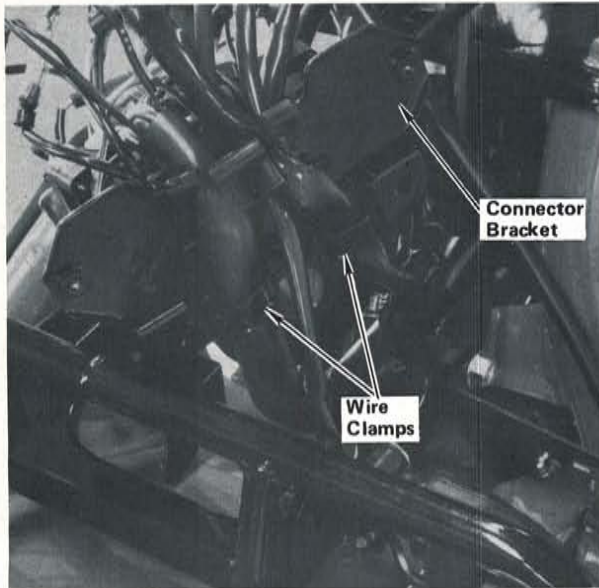

STEP 56—Secure the two main wire harnesses to the bottom of the connector bracket with the two wire clamps as shown.

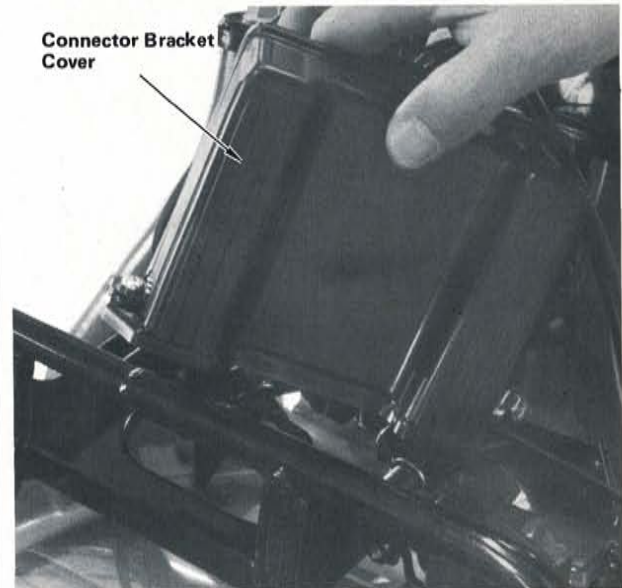

STEP 57—Slip connector bracket cover over connector bracket as shown.

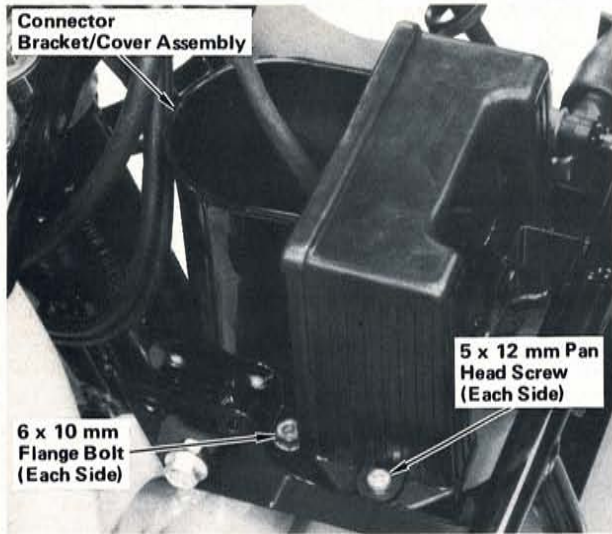

STEP 58—Position connector bracket/cover assembly as shown and install, using two 6 x 10 mm flange bolts for the bracket and two 5 x 12 mm pan head screws for the cover. Tighten flange bolts to specified torque, and tighten cover screws securely.

Torque specification:
1.2 kg-m (9 lb-ft)

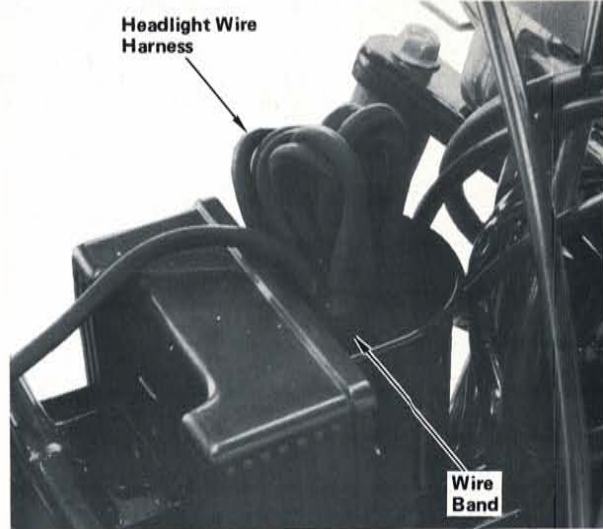

STEP 59—Coil headlight wire harness as shown and secure with attached wire band. Insert coil of wire into compartment on back of connector bracket as shown.

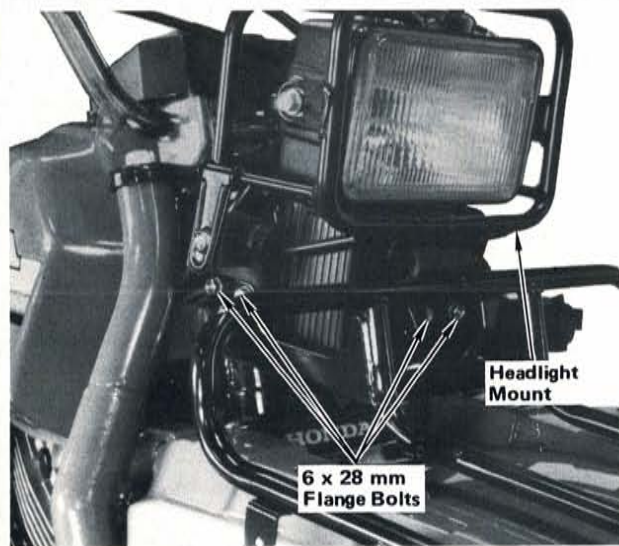

STEP 60—Align headlight mount rubbers/collars with holes in brackets as shown. Install right side and front using four 6 x 28 mm flange bolts. Do not tighten bolts at this time.

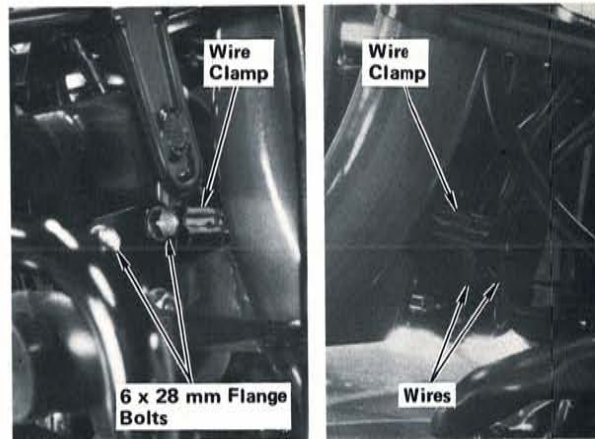

STEP 61—Install left side of headlight mount using two 6 x 28 mm flange bolts, with a wire clamp under head of rear, left bolt as shown. Position wire clamp as shown and tighten all six headlight mount bolts to specified torque. Secure wires with wire clamp as shown.

Torque specification:
1.2 kg-m (9 lb-ft)

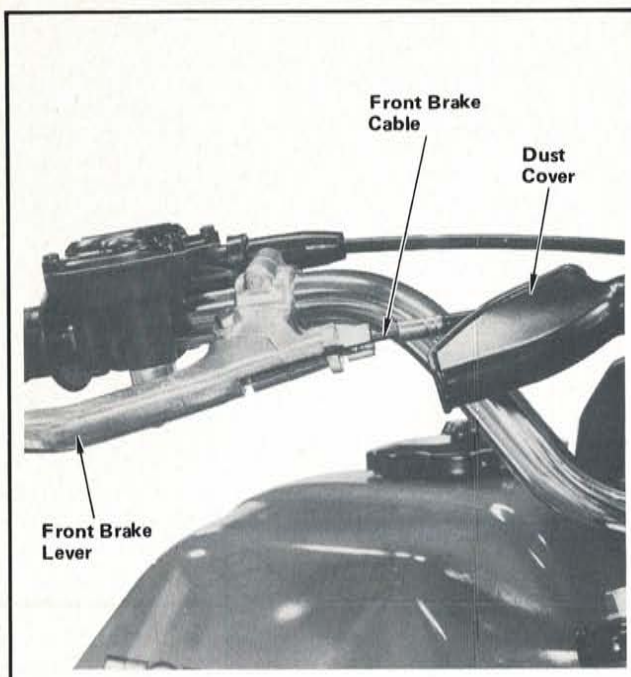

STEP 62—Slide dust cover down front brake cable and disconnect front brake cable from front brake hand lever.

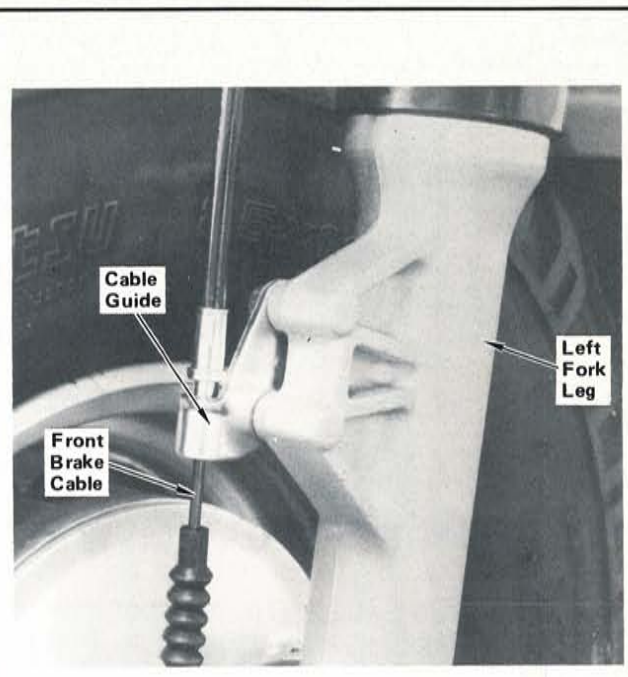

STEP 63—Insert front brake cable into slot of cable guide on left fork leg as shown.

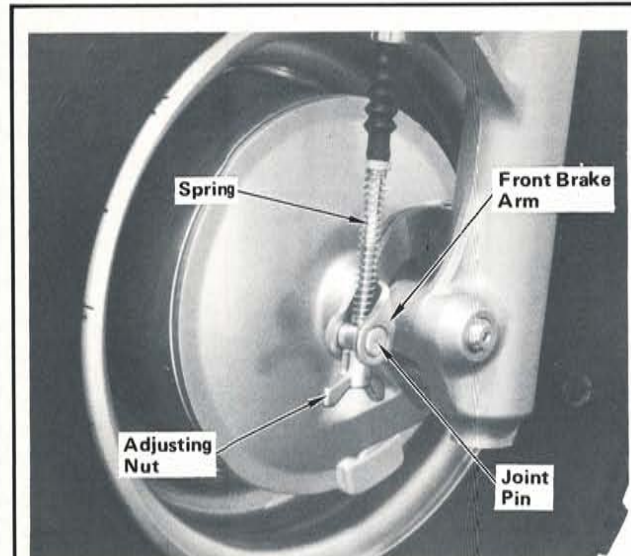

STEP 64—Slip spring over end of front brake cable. Connect cable to brake arm using a joint pin and adjusting nut as shown. Insert cable end into slot in front brake hand lever and pull back through slots in knurled nut and cable adjuster. Adjust front and rear brakes as described in Steps 97 through 99.

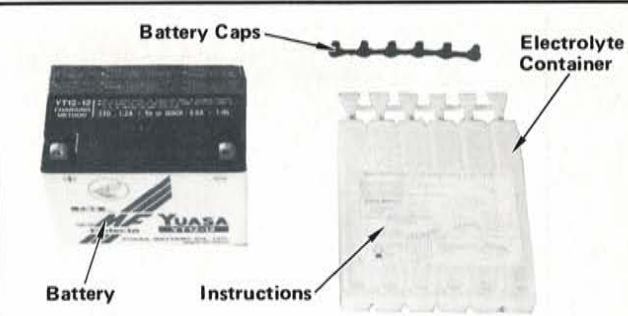

STEP 65—Service battery as described on battery preparation label on battery electrolyte container.

WARNING Battery electrolyte contains sulfuric acid. Avoid contact with skin, eyes, or clothing. Antidote: Flush with water and get prompt medical attention.

CAUTION:

- Remove battery from vehicle whenever filling it with battery electrolyte.
- Do not use battery liquids other than that furnished with battery.
- After filling battery, check that there is no electrolyte left in the container.
- Dispose of container properly.

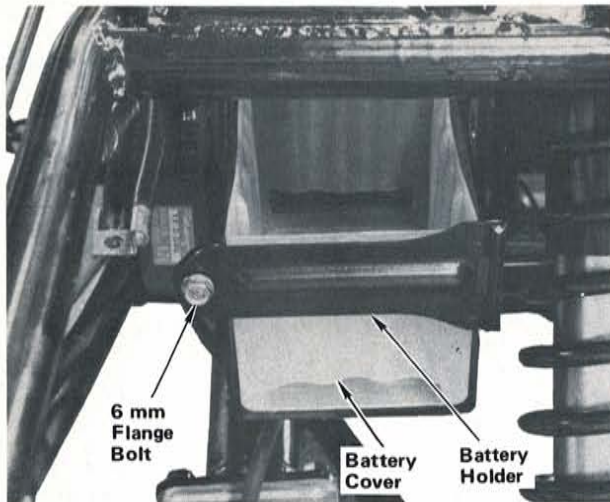

STEP 66—Remove and retain flange bolt attaching battery holder. Swing open battery holder and remove battery cover.

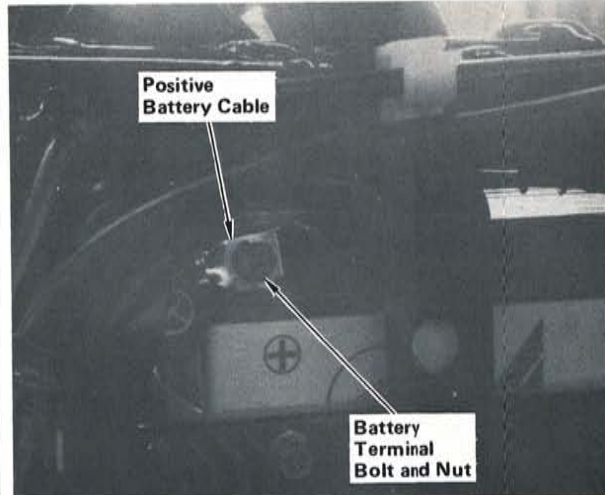

STEP 67—Check that ignition switch is off. Place battery in battery cover and slide into battery compartment with terminals facing left side. Connect positive battery cable (cable with terminal cover) to battery positive (+) terminal using a battery terminal bolt and nut as shown. Tighten bolt securely and coat terminal with clean grease.

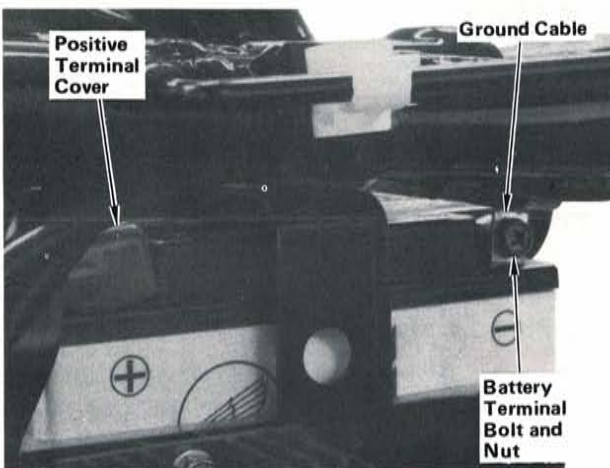

STEP 68—Slip terminal cover over positive terminal. Connect ground cable to battery negative (-) terminal using a battery terminal bolt and nut as shown. Tighten bolt securely and coat terminal with clean grease.

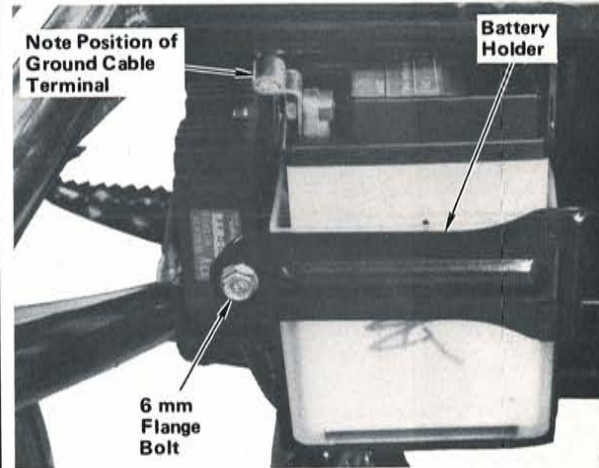

STEP 69—Close battery holder and secure with flange bolt removed in Step 66. Tighten bolt securely.

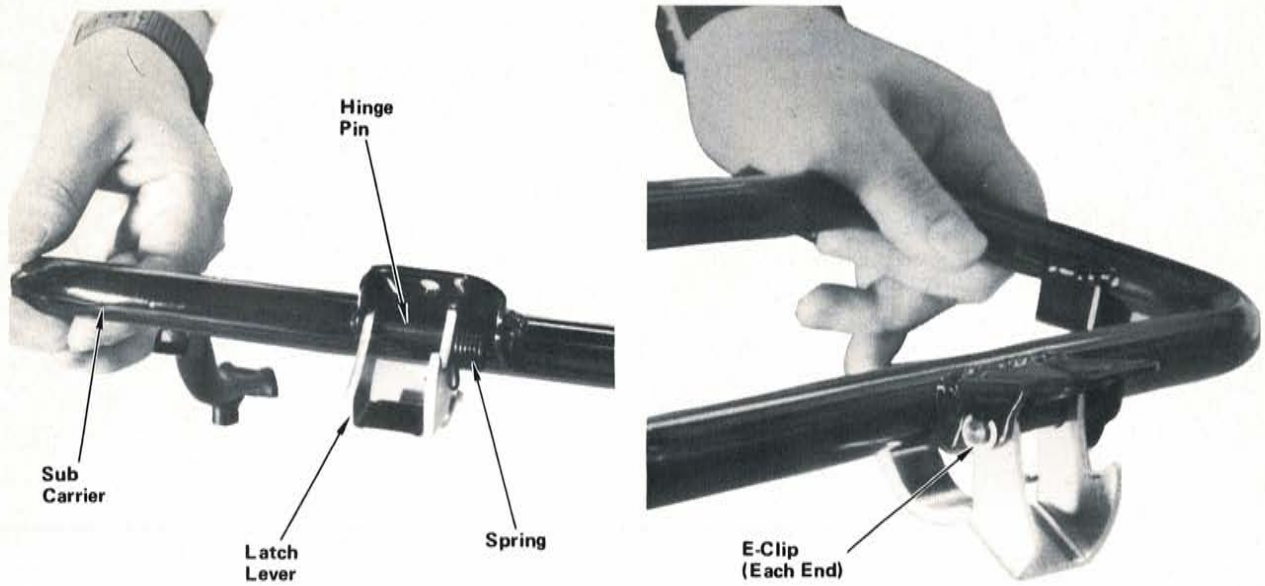

STEP 70—Install latch lever on sub carrier bracket as shown, using a hinge pin and spring. Hook curved end of spring into latch lever as shown. Secure hinge pin using an E-clip inserted in groove at each end. Check operation of latch.

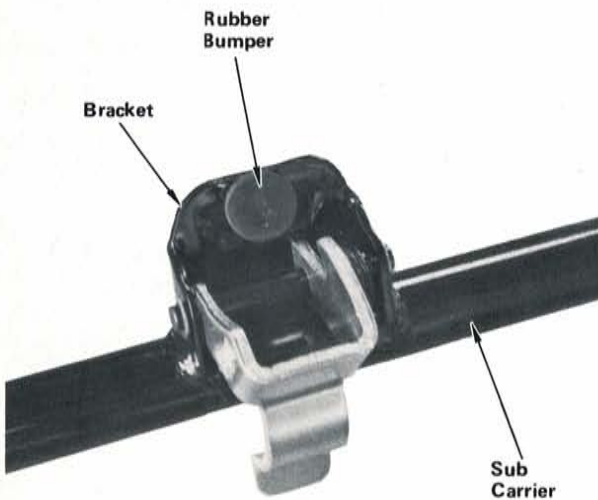

STEP 71—Press rubber bumper up through hole of sub carrier bracket as shown.

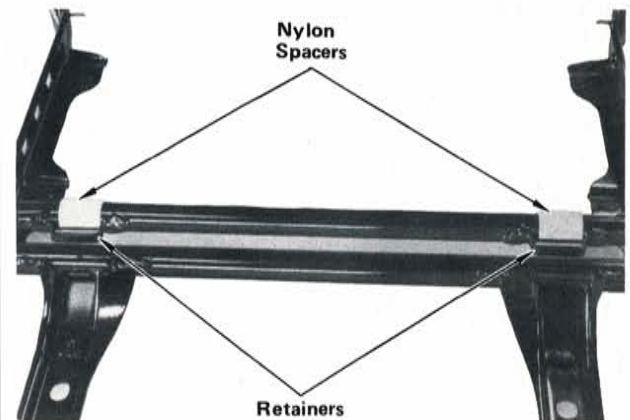

STEP 72—Slip nylon spacers onto rear carrier where shown.

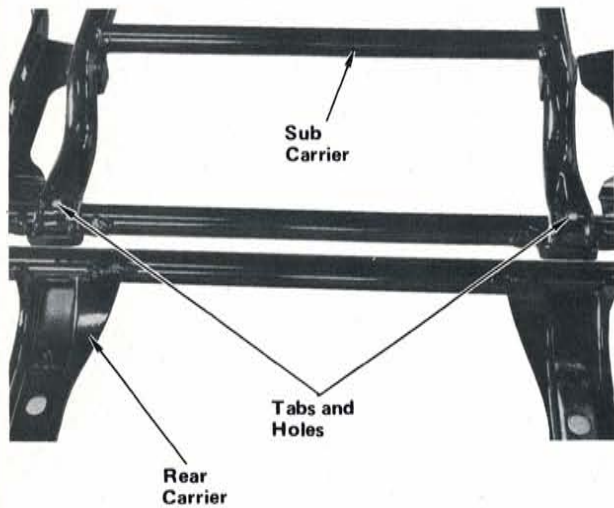

STEP 73—Position sub carrier on rear carrier as shown, with tabs of spacers inserted into holes of sub carrier as shown.

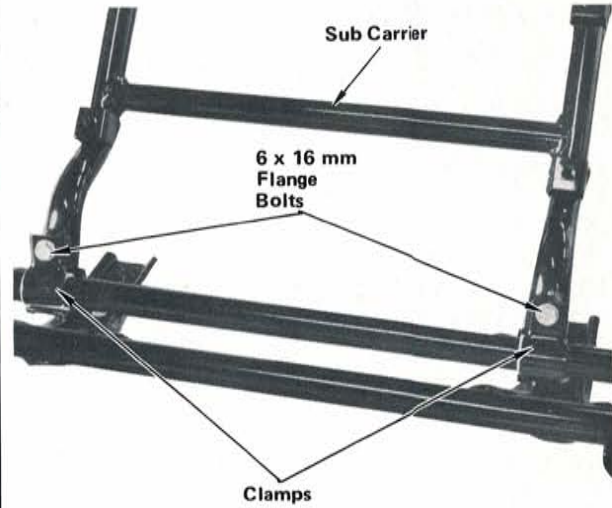

STEP 74—Clamp sub carrier to nylon spacers using two clamps and a 6 x 16 mm flange bolt for each. Tighten bolts to specified torque.

Torque specification:
1.2 kg-m (9 lb-ft)

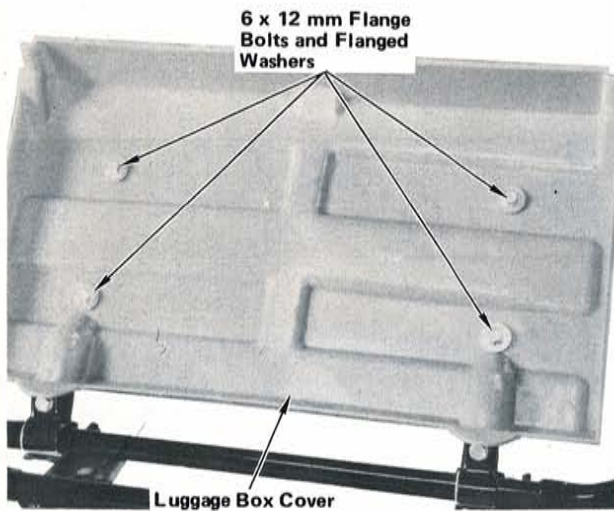

STEP 75—Position luggage box cover on sub carrier as shown and align holes. Install cover using four 6 x 12 mm flange bolts and flanged washers. Tighten bolts to specified torque.

Torque specification:
1.2 kg-m (9 lb-ft)

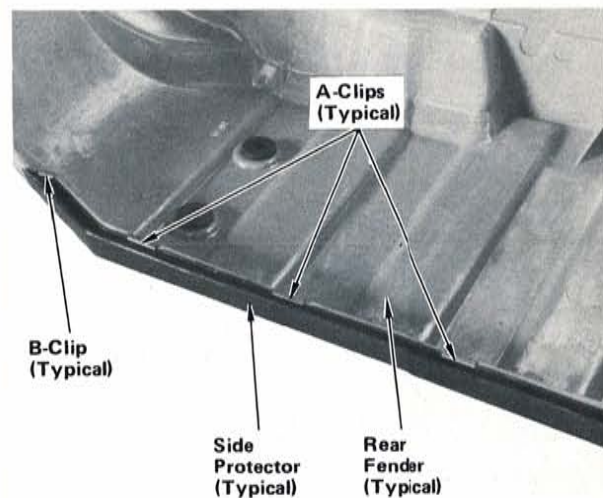

STEP 76—Slide right and left side protectors onto right and left rear fenders as shown, and secure each with a B-clip (narrow) at the front and three A-clips (wide) positioned along the edge where shown.

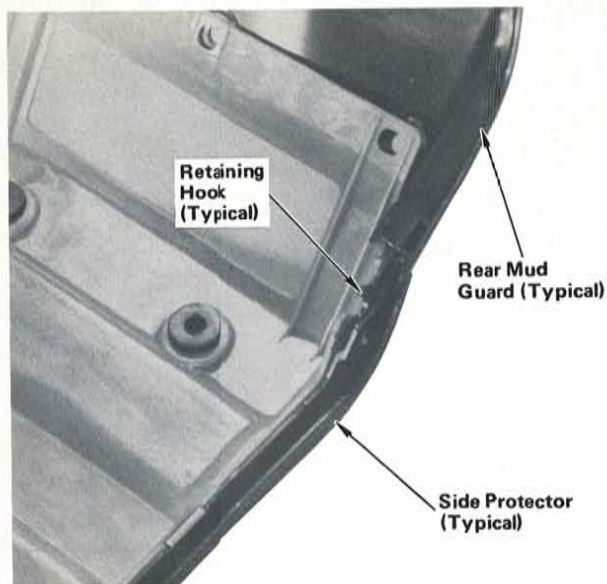

STEP 77—Position rear mud guards on rear fenders as shown, with retaining hooks of mud guards inserted between fender and side protector as shown.

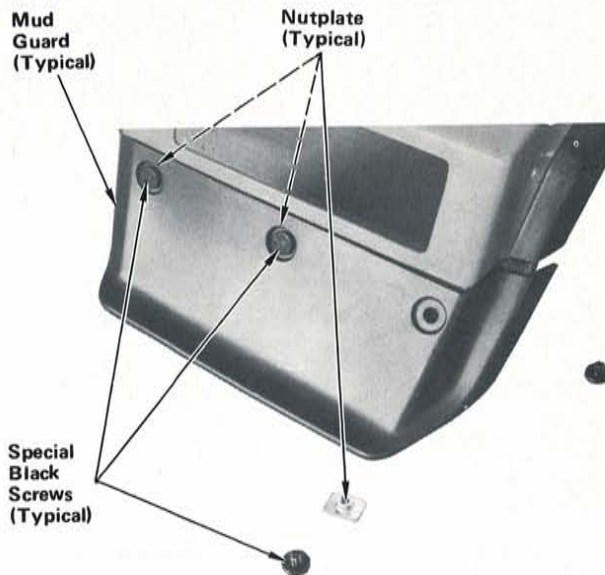

STEP 78—Loosely install rear mud guards as shown using three special black screws with nutplates under fender.

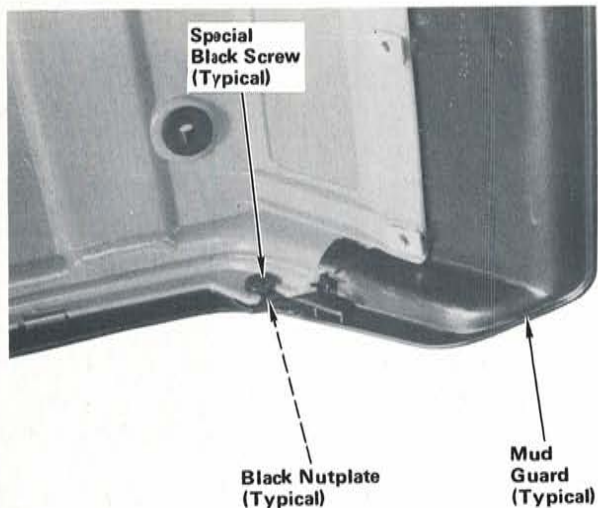

STEP 79—Align cutouts of retaining hooks on mud guards with holes in side protectors and fenders. Install hooks using a special black screw from underneath with a black nutplate for each mud guard. Tighten all mud guard screws to specified torque.

Torque specification:
0.35 kg-m (3 lb-ft)

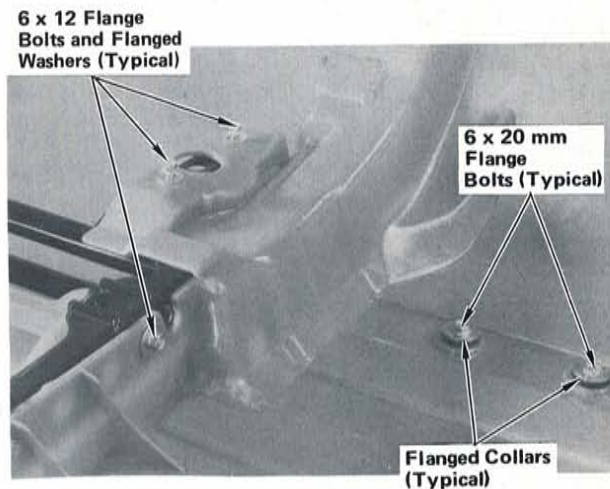

STEP 80—Position rear fenders on rear carrier and press flanged collars into rubber grommets in fenders where shown. Install fenders using three 6 x 12 mm flange bolts and flanged washers and two 6 x 20 mm flange bolts where shown for each fender. Do not tighten bolts at this time.

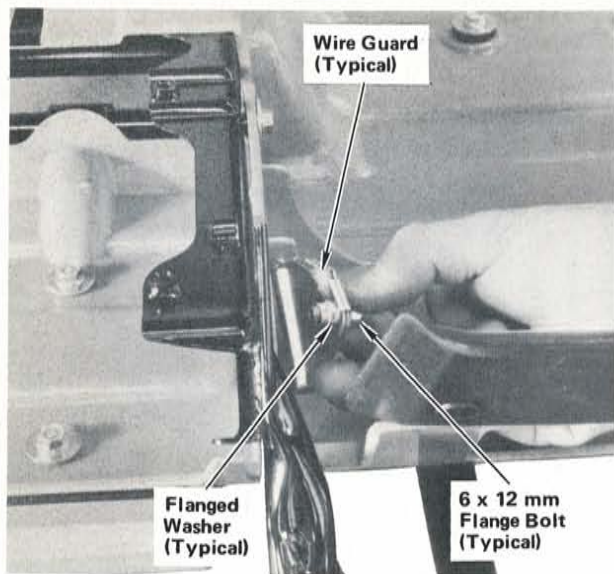

STEP 81—Loosely install taillight wire guide using a 6 x 12 mm flange bolt through wire guide and a flanged collar through fender and into rear carrier as shown for each fender. Do not tighten bolts at this time.

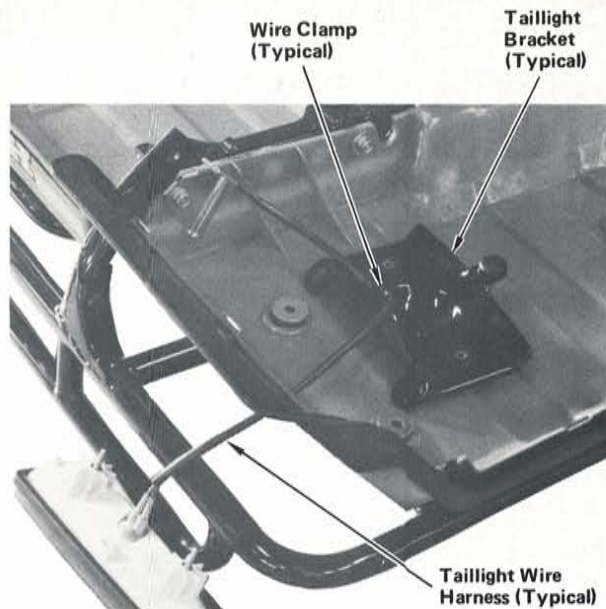

STEP 82—Route taillight wire harness through opening in rear fender and wire clamp of taillight bracket for each rear fender as shown.

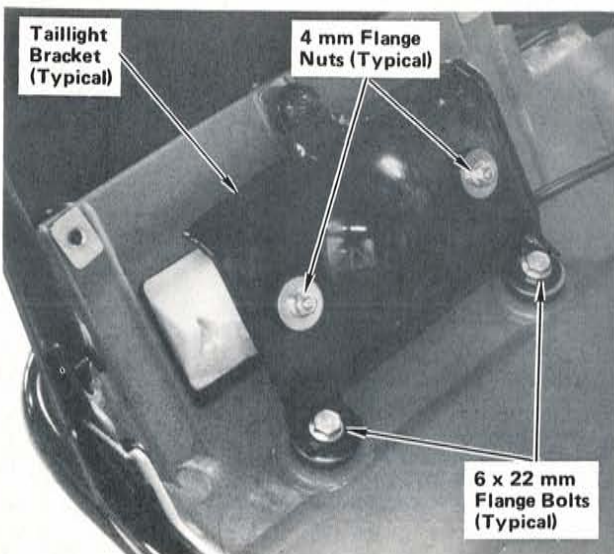

STEP 83—Position each taillight bracket as shown and insert studs of each taillight into bracket as shown. Install taillights using two 4 mm flange nuts on each. Tighten nuts securely. Install taillight bracket under each fender as shown using two 6 x 22 mm flange bolts for each. Do not tighten 6 mm bolts at this time.

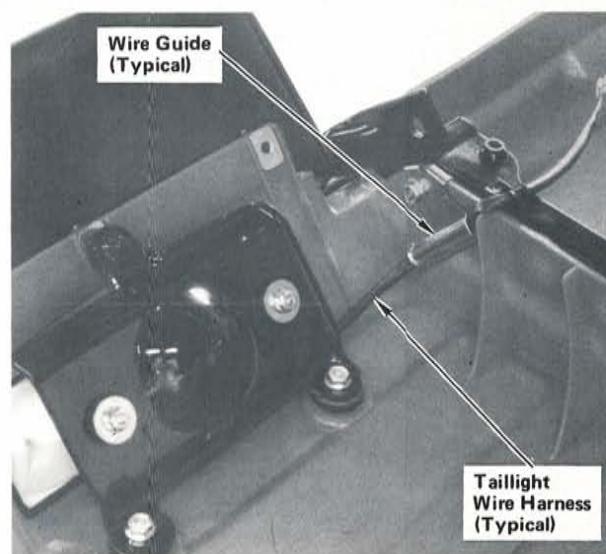

STEP 84—Route taillight wire harness through wire guide and wire clip for each taillight as shown. Tighten all 6 mm bolts installed in Steps 80, 81, and 83 to specified torque.

Torque specification:
1.2 kg-m (9 lb-ft)

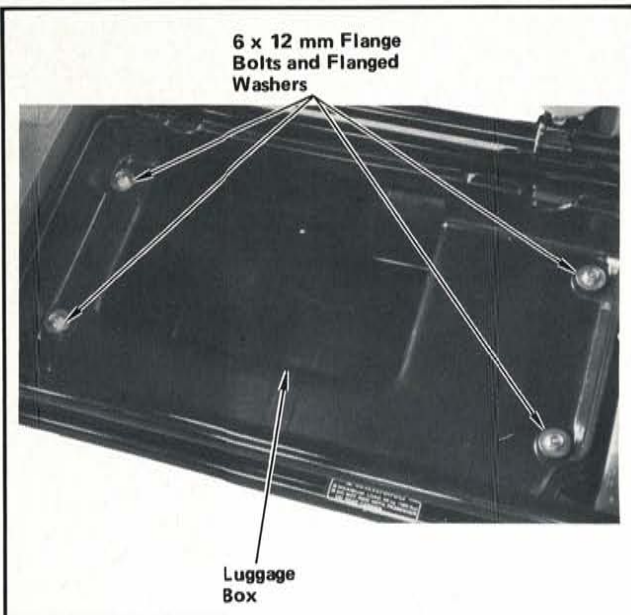

STEP 85—Position luggage box on rear carrier as shown and install using four flanged washers and 6 x 12 mm flange bolts. Tighten bolts to specified torque.

Torque specification:
1.2 kg-m (9 lb-ft)

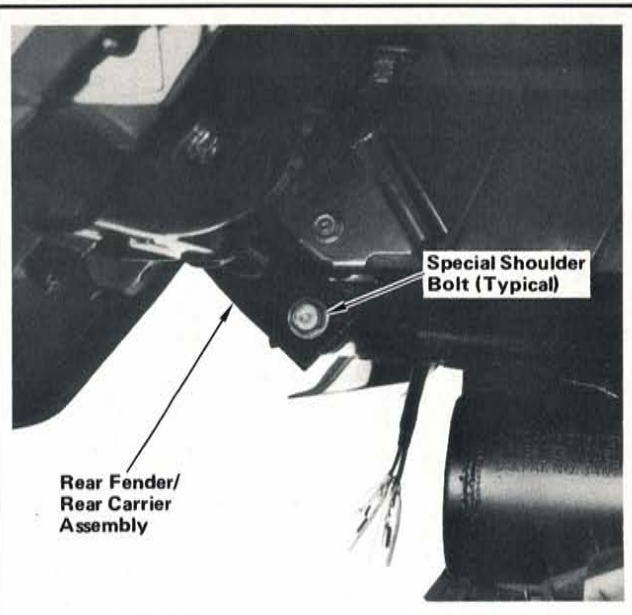

STEP 86—Position rear fender/rear carrier on frame as shown and install using two special shoulder bolts through carrier into frame. Tighten bolts to specified torque.

Torque specification:
2.7 kg-m (20 lb-ft)

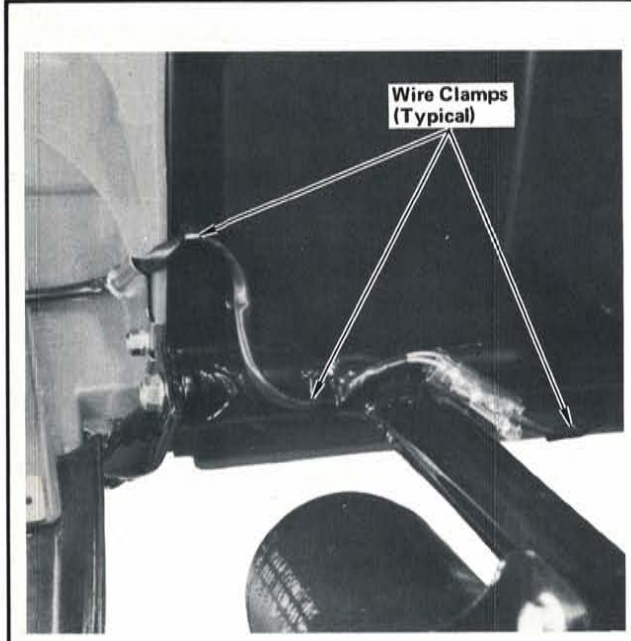

STEP 87—Connect taillight wire harnesses to wire harness color-to-color. Secure taillight wire harnesses on each side with wire clamps as shown.

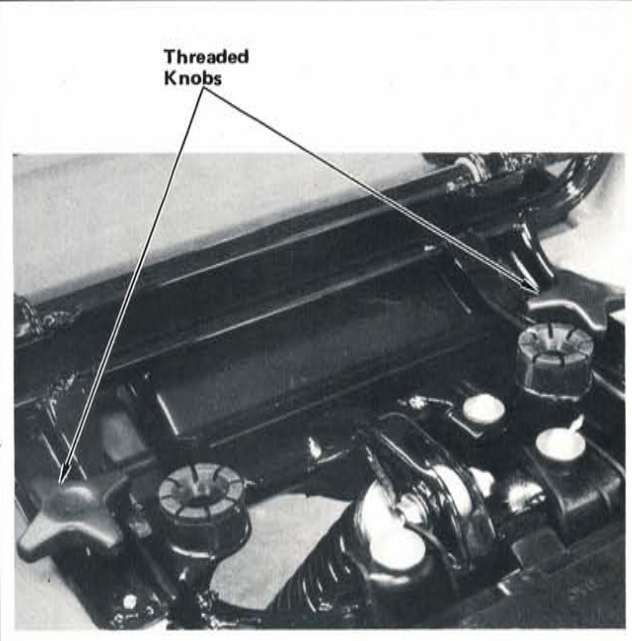

STEP 88—Lower rear fender and secure with two threaded knobs as shown.

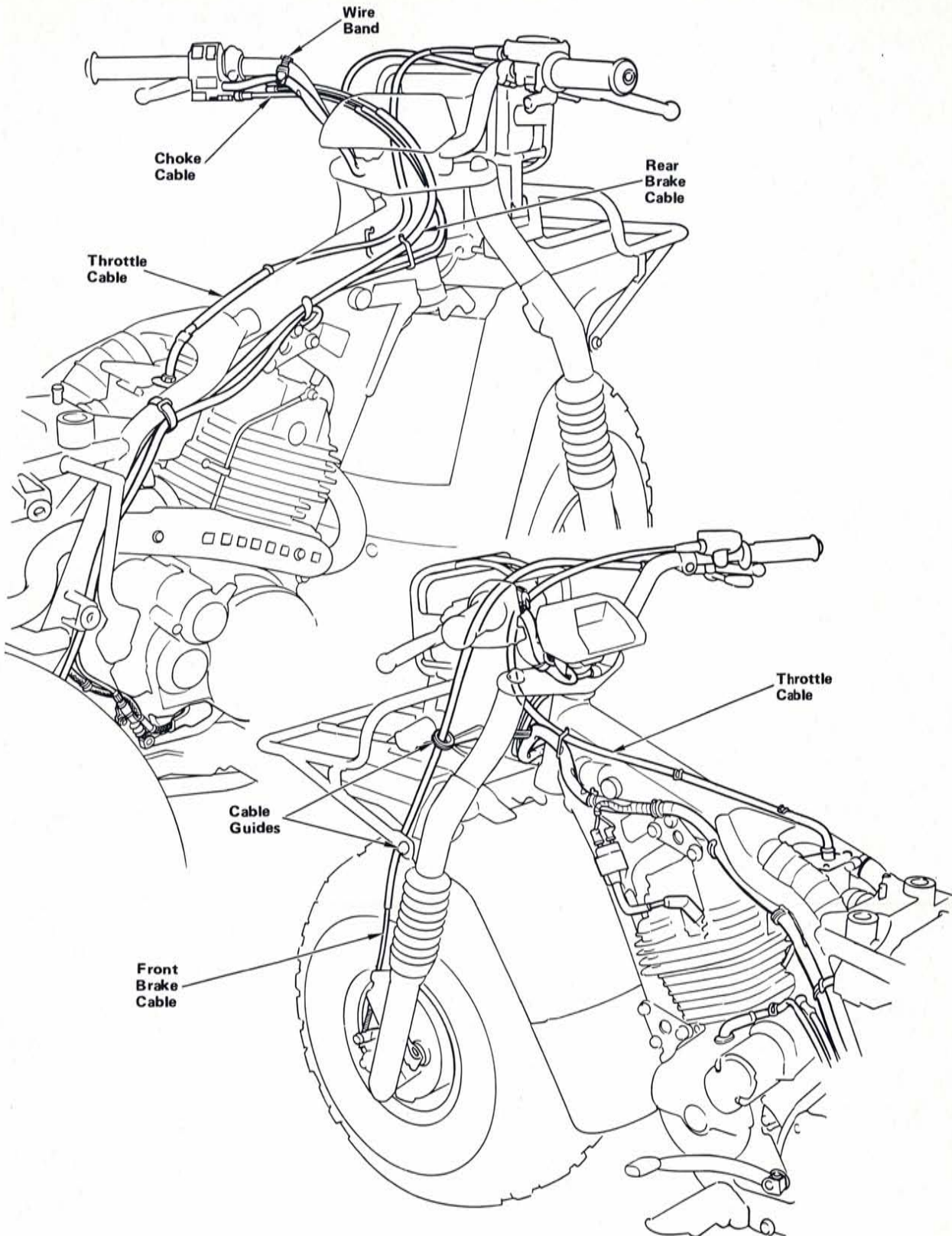

STEP 89—Check routing of front and rear brake cables, throttle cable, engine stop switch wires, taillight wires, and headlight switch wires as shown.

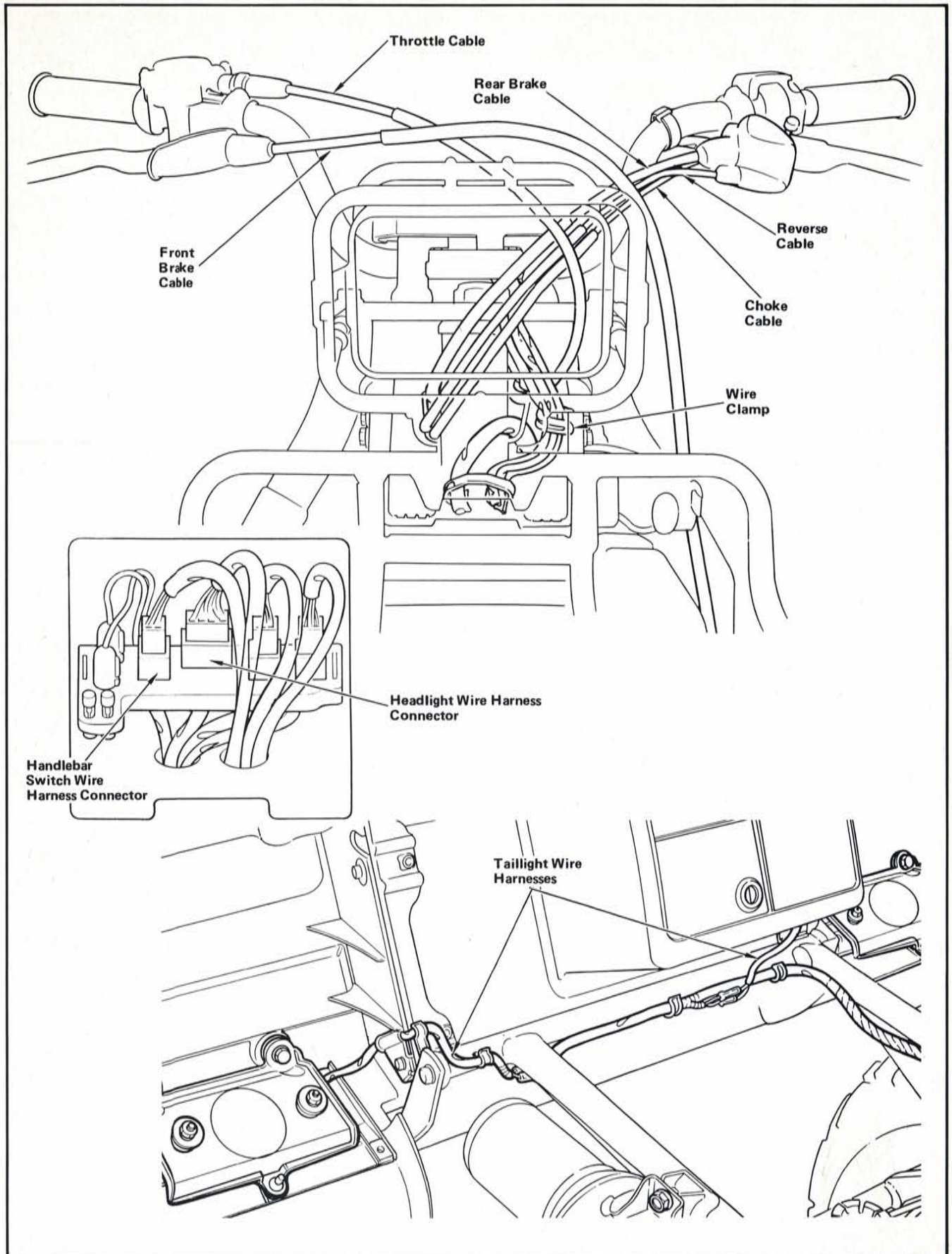

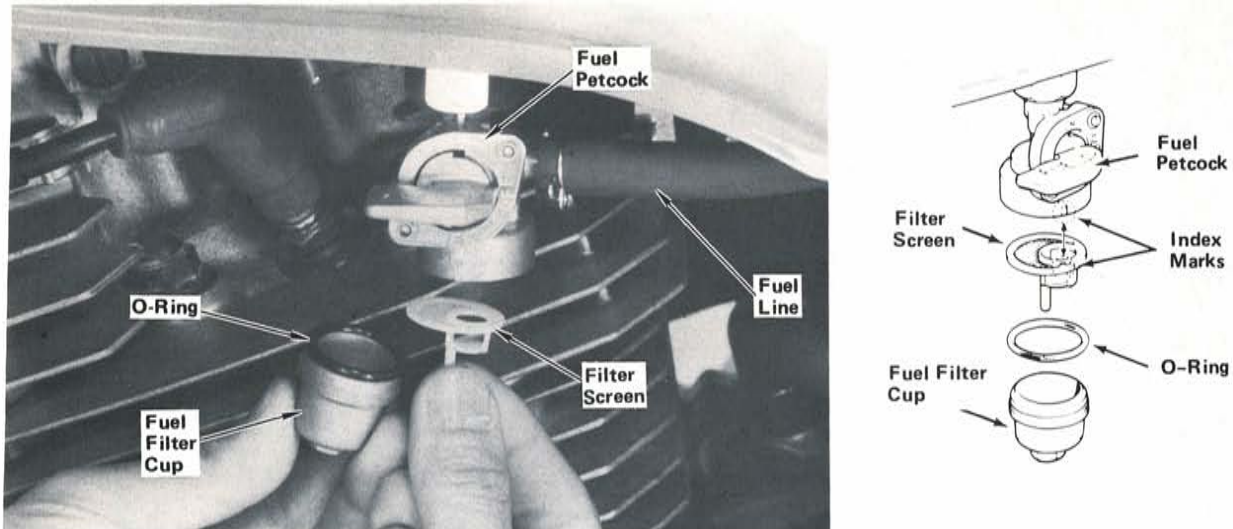

STEP 90—Turn fuel petcock to OFF. Remove fuel filter cup and wash cup and filter screen in clean non-flammable or high flash point solvent. Drain, flush and inspect fuel tank. Reinstall filter screen and “O” ring, aligning index marks on filter screen and fuel petcock body. Install filter cup and tighten to a torque of 0.4 kg-m (3 lb-ft). Drain residual fuel from carburetor.

WARNING Fuel must be drained into a proper container. Gasoline is flammable and is explosive under certain conditions. Do not smoke or allow flames or sparks near the equipment while draining fuel.

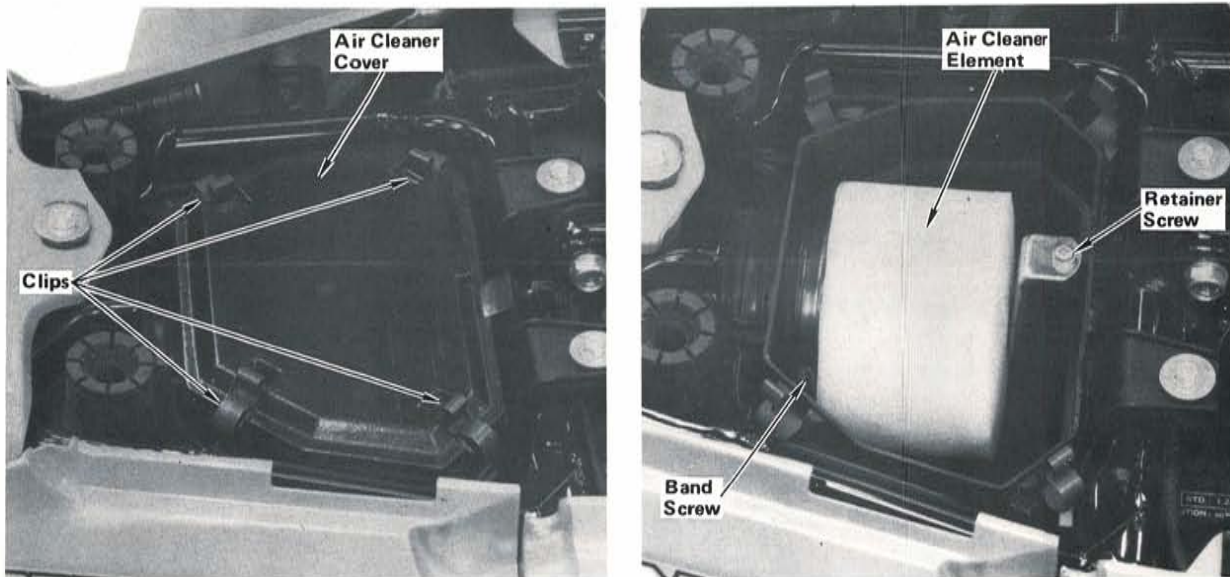

STEP 91—Release four clips attaching air cleaner cover and remove cover. Loosen band screw and remove retainer screw. Remove air cleaner element. Check condition of element. If necessary, clean and oil element as described in owner’s manual or shop manual. Reinstall element. Tighten retainer screw and band screw securely. Reinstall cover. Make sure clips are secure.

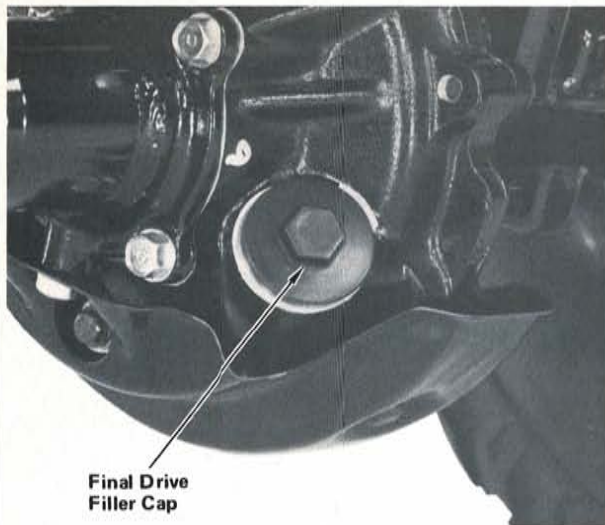

STEP 92—Remove oil filler cap from final drive gear case. Check that oil level is even with lower edge of oil filler hole. If necessary, add recommended oil. Reinstall and tighten oil filler cap.

Recommended oil:
Hypoid Gear Oil SAE 80

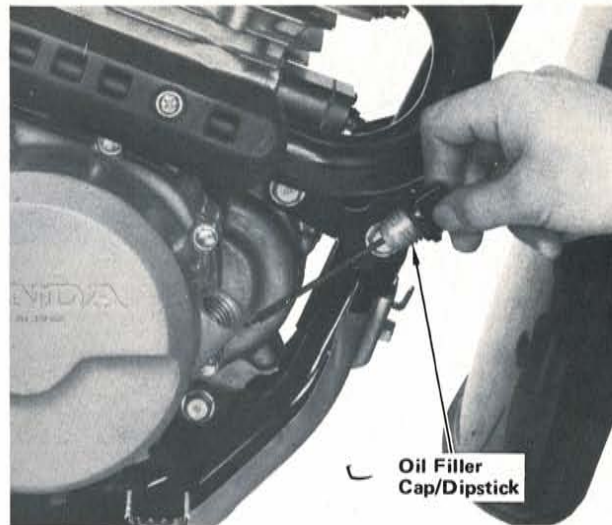

STEP 93—Remove oil filler cap/dipstick and fill crankcase with recommended oil as described in owner's manual. Reinstall and tighten oil filler cap/dipstick.

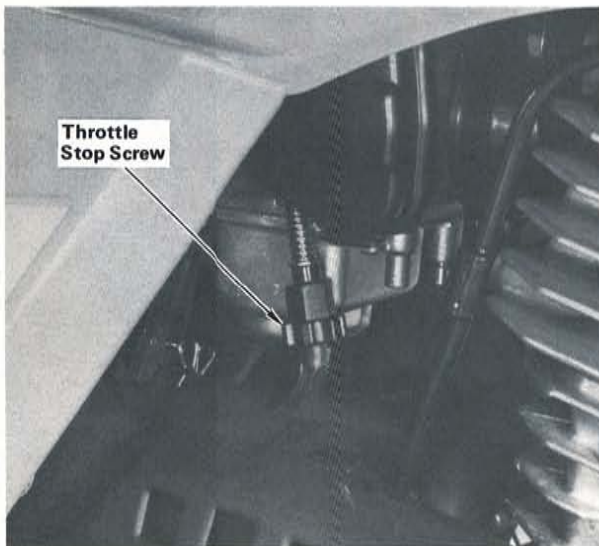

STEP 94—Connect a tachometer and check transmission in neutral. Start engine and allow it to warm up to operating temperature and check idle speed at $1,400 \pm 100$ rpm. If necessary, adjust idle speed using throttle stop screw. Remove tachometer.

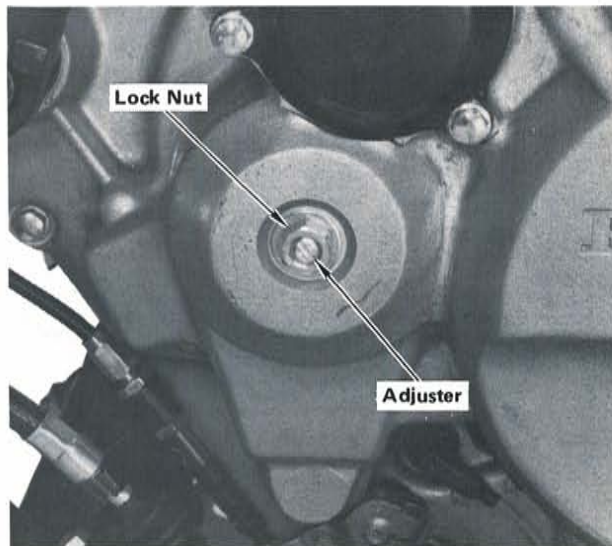

STEP 95—Check clutch operation. If adjustment is necessary, use the following procedure. Loosen lock nut and turn clutch adjuster counterclockwise until resistance is felt, then turn clutch adjuster $1/8$ — $1/4$ turn clockwise and tighten lock nut. Recheck clutch operation.

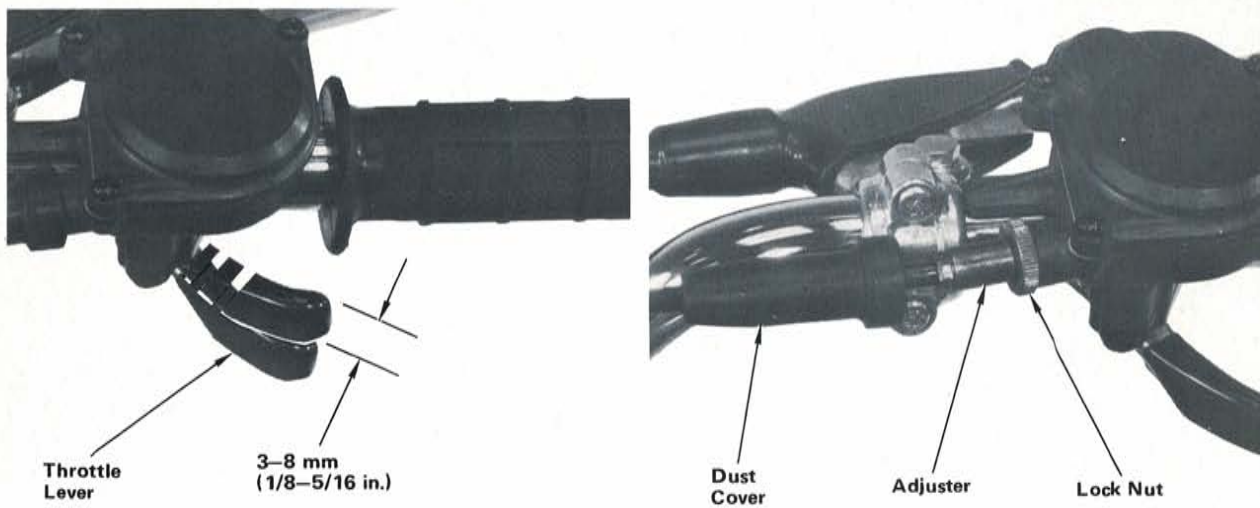

STEP 96—Check throttle cable for condition. Check that throttle lever free play is within 3–8 mm (1/8–5/16 in.) at tip of throttle lever. Check for smooth operation of throttle lever from fully closed to fully open in all steering positions and that throttle lever automatically returns from fully open to fully closed when released. If necessary to adjust free play, slide dust cover back to expose adjuster. Loosen lock nut and turn adjuster to obtain correct free play. After adjustment, tighten lock nut and reinstall dust cover.

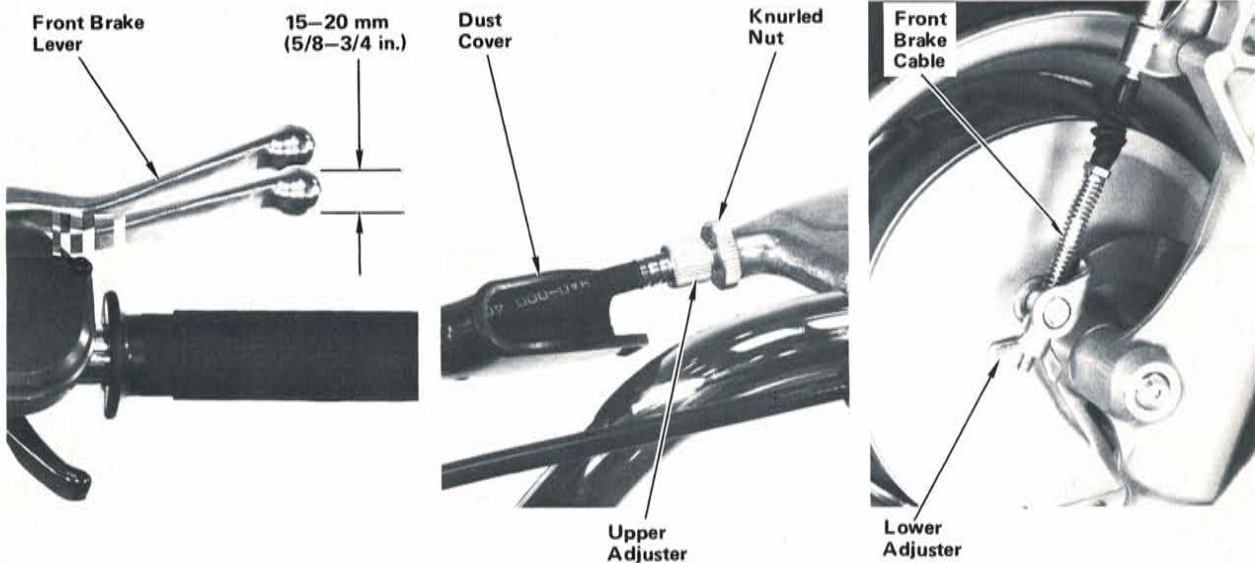

STEP 97—Raise front wheel off ground using a support block under engine. Spin front wheel by hand and measure free play of front brake hand lever before brake starts to engage. Free play, measured at tip of brake hand lever, should be between 15 and 20 mm (5/8–3/4 in.). Use lower adjuster to make large adjustments. Small adjustments are made at brake hand lever by sliding back dust cover, loosening knurled nut, and turning upper adjuster. After adjustment, tighten knurled nut and reinstall dust cover. Remove support block.

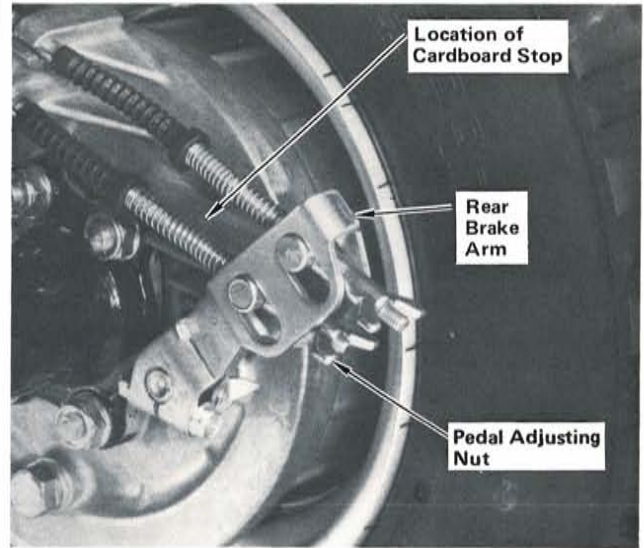
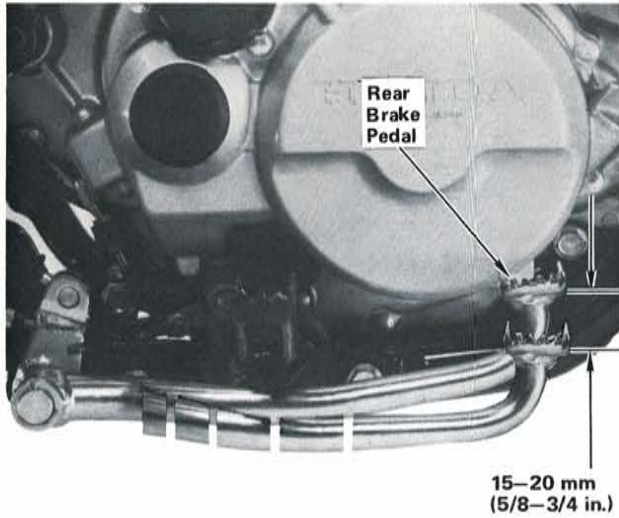

STEP 98—Raise rear wheels off ground using a support block under vehicle. Remove cardboard stop in front of rear brake arm. Rotate rear wheels by hand and measure free play before brake starts to engage. Free play, measured at tip of brake pedal, should be between 15 and 20 mm (5/8—3/4 in.). To adjust free play, turn adjusting nut. Turning adjusting nut clockwise will decrease free play.

15-20 mm
(5/8-3/4 in.)

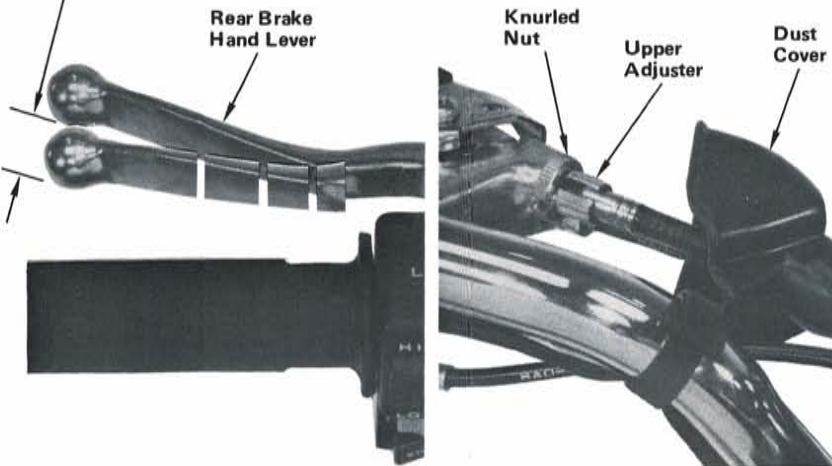

STEP 99—Spin rear wheels by hand and measure free play of rear brake hand lever before brake starts to engage. Free play, measured at tip of brake hand lever, should be between 15 and 20 mm (5/8—3/4 in.). Use lower adjuster to make large adjustments. Small adjustments are made at rear brake hand lever by sliding back dust cover, loosening knurled nut, and turning upper adjuster. After adjustment, tighten knurled nut and reinstall dust cover. Remove block under vehicle. Check parking brake operation.

Rev. 10/84 This page supersedes page 31 dated 7/84. Remove and destroy superseded page.

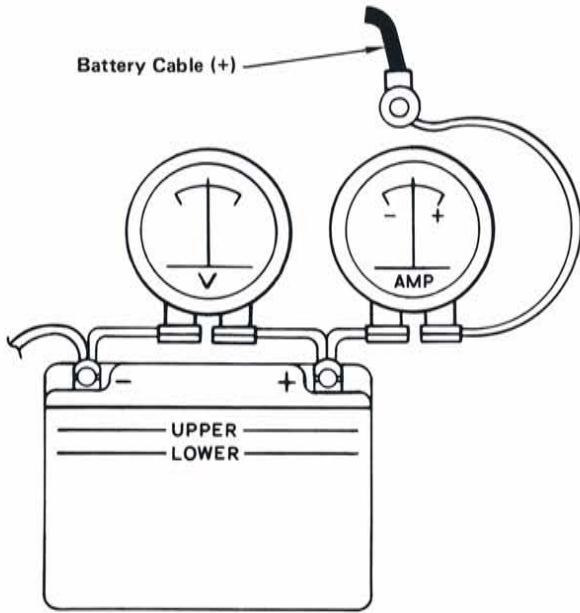

STEP 100—Check battery charging sytem (volts and amperes) at battery, as described on shop manual.



STEP 101—Install right and left side covers by inserting prongs on side covers into rubber grommets on frame.

NOTE: Be sure kick starter pedal is folded before installing right side cover.

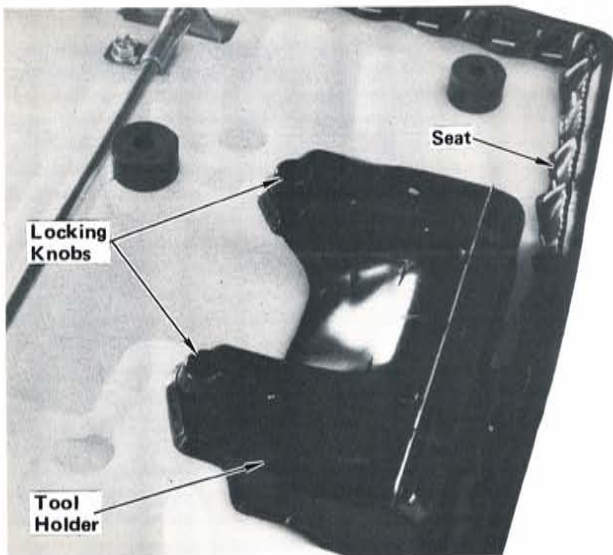

STEP 102—Place tool kit in tool holder. Install and lock tool holder under seat and lock in place with locking knobs.

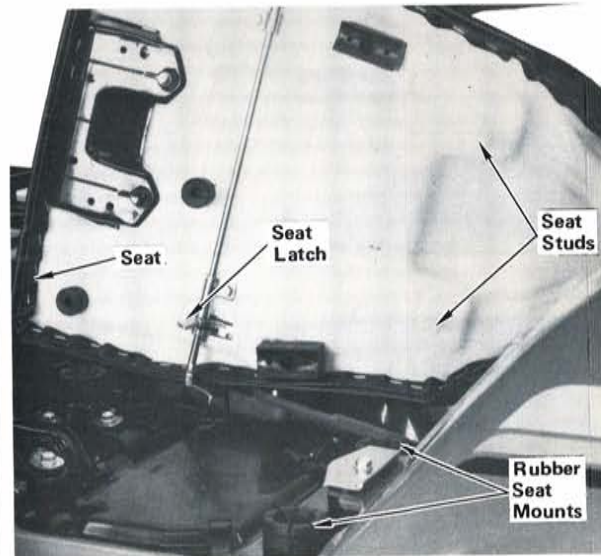

STEP 103—Install seat by inserting seat studs into holes in rubber seat mounts and engage seat latches.

NOTE: Check that seat latches are fully engaged.

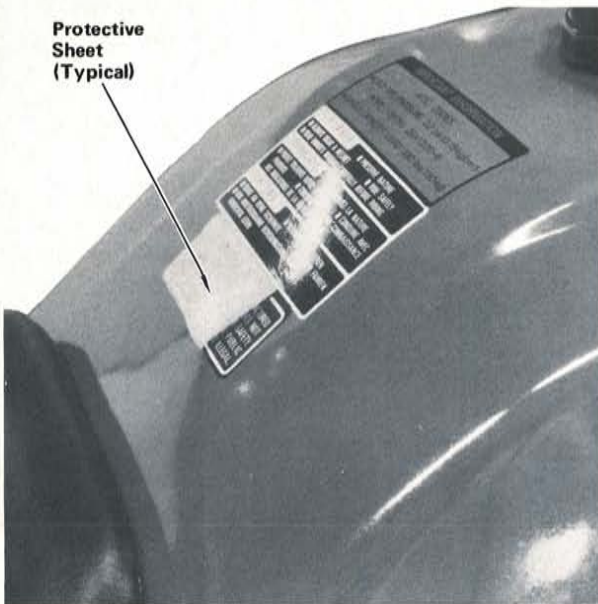

STEP 104—Remove protective sheets from labels.

CAUTION

REMOVE BATTERY AND MAINTAIN IN FULLY CHARGED CONDITION UNLESS ATC IS TO BE DELIVERED IMMEDIATELY. REFER TO SERVICE BULLETIN SL #48. DO NOT USE ELECTRIC STARTER IMMEDIATELY AFTER INSTALLATION OF A FRESHLY CHARGED BATTERY, SOME TIME IS REQUIRED FOR BATTERY TO ATTAIN FULL CAPACITY.

TORQUE TABLE

ITEM	SIZE	TORQUE
Handlebar upper holder bolts	8 mm	2.4 kg-m (18 lb-ft)
Front axle	-----	9.0 kg-m (68 lb-ft)
Axle holder nuts	6 mm	1.2 kg-m (9 lb-ft)
Front fork leg bolts	-----	5.5 kg-m (40 lb-ft)
Rear wheel nuts	10 mm	5.5 kg-m (40 lb-ft)
Skid plate bolts	8 mm	2.7 kg-m (19 lb-ft)
Gear case protector	8 mm	2.7 kg-m (19 lb-ft)
Trailer hitch	10 mm	4.0 kg-m (30 lb-ft)
Front fender bolts	6 mm	1.0 kg-m (8 lb-ft)
Front luggage carrier bolts	8 mm	2.7 kg-m (19 lb-ft)
Headlight case bolts	8 mm	2.7 kg-m (19 lb-ft)
Connector box bolts	6 mm	1.2 kg-m (9 lb-ft)
Headlight mount bolts	6 mm	1.2 kg-m (9 lb-ft)
Sub carrier clamp bolts	6 mm	1.2 kg-m (9 lb-ft)
Luggage box cover bolts	6 mm	1.2 kg-m (9 lb-ft)
Mud guard screws	-----	0.35 kg-m (3 lb-ft)
Rear fender bolts	6 mm	1.2 kg-m (9 lb-ft)
Luggage box bolts	6 mm	1.2 kg-m (9 lb-ft)
Rear fender/carrier pivot bolts	-----	2.7 kg-m (20 lb-ft)
Fuel filter cup	-----	0.4 kg-m (3 lb-ft)

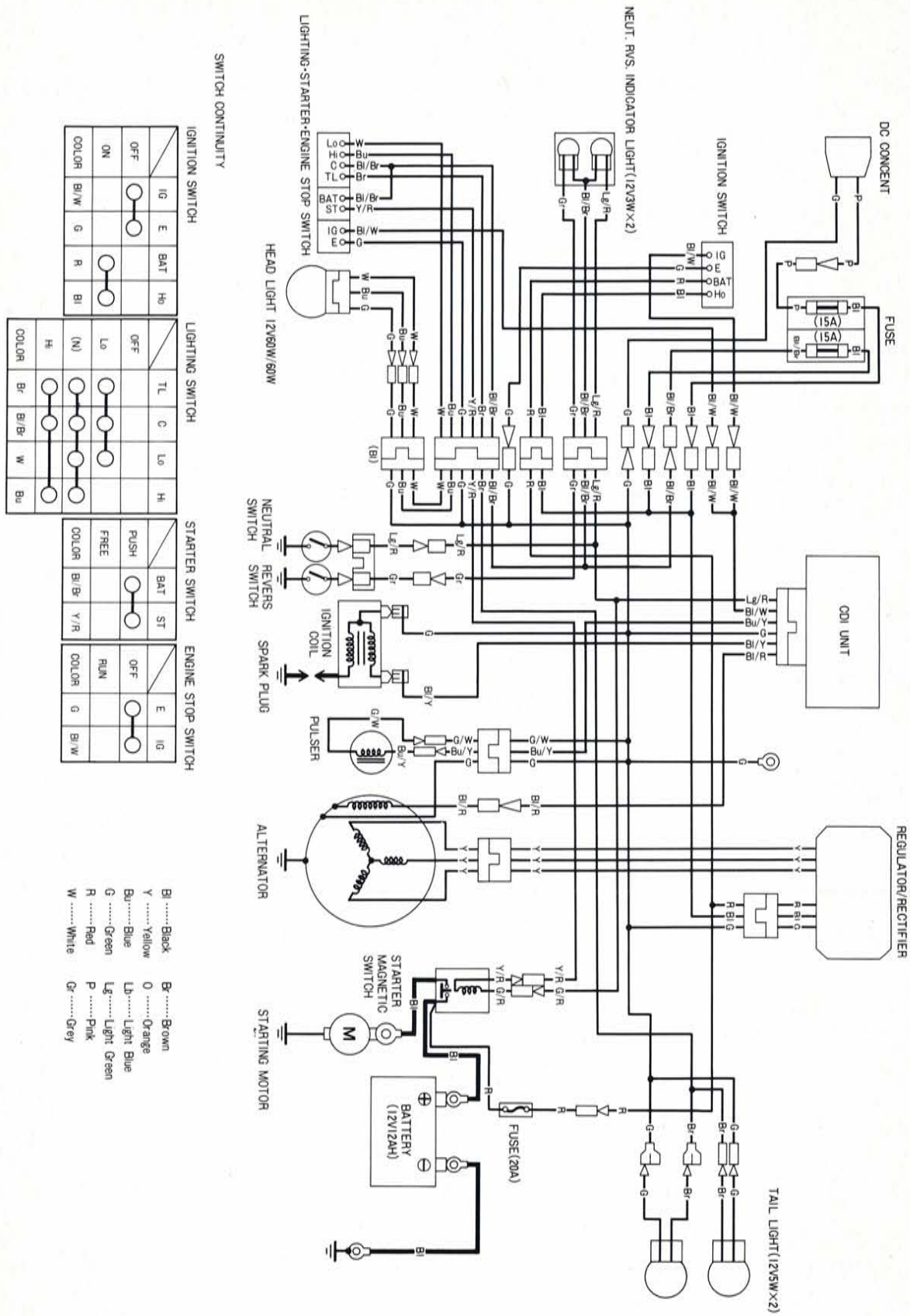

NOTE: Check all items listed on the following Pre-delivery Service Check List. Refer to owner's manual or shop manual for specifications and detailed procedures. Always test ride the unit to make sure that it is functioning properly.

PRE-DELIVERY SERVICE CHECK LIST

- | | |
|--|---|
| <input type="checkbox"/> Adjust front and rear brakes, check cable routing and check operation. | <input type="checkbox"/> Check security of all nuts, bolts, and other fasteners. |
| <input type="checkbox"/> Fill crankcase with recommended oil. | <input type="checkbox"/> Check to ensure that all applicable recall and product update campaigns are complied with. |
| <input type="checkbox"/> Drain, flush, and inspect fuel tank. Clean fuel filter. | <input type="checkbox"/> TEST RIDE: Check performance, handling, and operation. |
| <input type="checkbox"/> Drain residual fuel from carburetor. | <ul style="list-style-type: none">• Transmission, high-low-reverse gear range selector, and clutch: Ease of shifting, clutch operations, etc. |
| <input type="checkbox"/> Check air filter element. Clean and oil if necessary. | <ul style="list-style-type: none">• Acceleration: Smoothness, etc. |
| <input type="checkbox"/> Fill fuel tank, turn on petcock and check for leaks. | <ul style="list-style-type: none">• Cruising: Smoothness, etc. |
| <input type="checkbox"/> Adjust idle speed. | <ul style="list-style-type: none">• Handling: Stability and cornering. |
| <input type="checkbox"/> Check throttle lever free play, cable routing, and operation in all steering positions. | <ul style="list-style-type: none">• Brakes: Smoothness and stopping power. |
| <input type="checkbox"/> Fill final drive case with recommended oil. | <ul style="list-style-type: none">• Idling: Smoothness, throttle response, and return to idle. |
| <input type="checkbox"/> Check tire pressure. | <ul style="list-style-type: none">• Recheck idle speed after 10 minutes of stop and go operation. |
| <input type="checkbox"/> Inspect electrical components for proper operation and adjustment. | <ul style="list-style-type: none">• Parking brake operation. |
| <ul style="list-style-type: none">• Headlight switch. | <ul style="list-style-type: none">• Upon completion of test ride, check for fuel and oil leaks. |
| <ul style="list-style-type: none">• Headlight: Adjust high beam aim. | |
| <ul style="list-style-type: none">• Neutral and reverse indicator lights. | |
| <ul style="list-style-type: none">• Taillights. | |
| <ul style="list-style-type: none">• Starter. | |
| <ul style="list-style-type: none">• Engine stop switch. | |
| <ul style="list-style-type: none">• Battery charging system. | |

LOOSE PARTS

The following is a list of items contained in the parts package carton and loose parts in the crate:

PART NAME	QTY	H/C	PART NUMBER
Battery	1	-----	-----
Battery liquid container	1	-----	-----
DC outlet	1	1821719	31650-HA0-000
Headlight sub harness A	1	1821750	32125-HA0-010
Headlight wire	1	1821768	32127-HA0-000
Wire band B1	2	0468819	32161-404-000
Headlight	1	1821842	33100-HA0-003
Collar, turn signal	6	1804079	33646-GB2-7210-M1
Taillight	2	1821859	33700-HA0-003
Wire guide, right turn signal	1	1821875	33717-HA0-000
Wire guide, left turn signal	1	1821883	33718-HA0-000
Taillight bracket	2	-----	-----
Cable guide, inner	2	0293324	45466-329-000
Brake cable upper clamp	1	1822766	45467-HA0-000
Brake cable lower clamp	1	1822774	45468-HA0-000
Gear case guard	1	1822956	50355-HA0-030
Skid plate	1	1822964	50360-HA0-020
Drain strap rubber	1	1822980	50362-HA0-000
Trailer hitch	1	-----	-----
Handle cover cap	1	1823392	53206-HA0-020
Handle cover mounting collar	2	1823426	53209-HA0-010
Front fender	1	-----	-----
Front fender mounting collar	8	0763946	61104-444-000
Headlight case	1	-----	61301-HA0-003
Nut, special,, 6 x 7 mm	6	-----	61304-358-003
Bracket, connector box	1	1823509	61305-HA0-020
Connector cover	1	1823517	61306-HA0-010
Grommet, sub wire	1	1823558	61319-HA0-000
Headlight case bracket	1	-----	-----
Washer, luggage box cover	4	0299370	64348-086-000
Washer, rear fender	4	0299370	64348-086-000
Washer, luggage box	4	0299370	64348-086-000
Mud guard, right rear	1	1823707	80111-HA0-003
Mud guard, left rear	1	1823715	80112-HA0-003
Protector, rear fender, side	1	1823723	80113-HA0-003
Protector, rear fender, side	1	1823731	80114-HA0-003
Clip A, side protector	6	1837616	80115-HA0-003
Clip B, side protector	2	1837624	80116-HA0-003
Right rear fender	1	-----	-----
Left rear fender	1	-----	-----
Luggage box cover	1	-----	-----

LOOSE PARTS (Continued)

PART NAME	QTY	H/C	PART NUMBER
Luggage box	1	1823772	80210-HA0-003
Front luggage carrier (prior to F/N 101944)	1	-----	-----
Front luggage carrier (F/N 101944 and subs)	1	-----	81100-HA0-010
Nutplate/retainer	1	-----	81101-HA0-000
Rear luggage carrier	1	-----	-----
Carrier comp	1	1823814	81306-HA0-010
Stopper lever pin	1	1834407	81307-HA0-000
Sub carrier spacer	2	1823822	81308-HA0-000
Sub carrier bracket	2	1823830	81309-HA0-010
Sub carrier rubber	1	1223122	81310-958-680
Rear carrier grip	2	1823848	81311-HA0-020
Stopper lever	1	1823855	81312-HA0-020
Sub carrier spring	1	1823863	81313-HA0-020
Tool holder	1	1823871	83500-HA0-000
Tool set	1	1824093	89010-HA0-010
Carrier hinge bolt	2	1824309	90102-HA0-000
Screw, rear mud guard	6	1647874	90103-VM4-000
Screw, side protector	2	1647874	90103-VM4-000
Bolt, flange, 8 x 10 mm, skid plate	3	1741081	90116-965-000
Bolt, flange, 10 x 35 mm, front fork	4	1299189	90118-958-000
Battery terminal bolt	1	-----	-----
Side protector nut	2	1834720	90302-HA0-000
Nut, 10 mm, rear wheel	8	1439249	90304-GE8-003
Washer, plain, 6 mm, handlebar cover	2	1824523	90434-SA0-000
Washer, 6 x 10 mm	4	-----	90505-HA0-000
Washer, 6 x 10 mm	4	-----	90505-HA0-000
Washer, 6 x 10 mm	4	-----	90505-HA0-000
Washer, 6 x 20 mm, rear fender	4	0191494	90512-300-000
Wire clip, front carrier	1	1366590	91406-ME5-000
Screw, pan head, 5 x 12 mm, connector case	2	0173567	93500-05012-0A
Screw, pan head, 6 x 40 mm, handlebar cover	2	1509181	93500-06040-0A
Screw/washer, 5 x 22 mm, DC outlet	2	1301126	93894-05022-00
Nut, flange, 4 mm, taillight	4	0665182	94050-04080
Washer, plain, 6 mm, fender	4	0629824	94103-06800
Washer, plain, 10 mm, rear wheel	8	0914648	94103-10000
Ring, E, 4 mm, carrier	2	1834878	94540-04010
Bolt, flange, 6 x 10 mm, connector case	2	0350488	95700-06010-00
Bolt, flange, 6 x 12 mm, luggage box cover	4	0252254	95700-06012-08
Bolt, flange, 6 x 12 mm, luggage box	4	0252254	95700-06012-08
Bolt, flange, 6 x 12 mm, rear fender	8	0252254	95700-06012-08
Bolt, flange, 6 x 14 mm, front fender	4	0671198	95700-06014-00
Bolt, flange, 6 x 16 mm, carrier	2	0496653	95700-06016-0S
Bolt, flange 6 x 20 mm, rear fender	4	0340331	95700-06020-08
Bolt, flange, 6 x 22 mm, rear fender	4	0483925	95700-06022-00
Bolt, flange, 6 x 28 mm, headlight bracket	6	0483933	95700-06028-00

LOOSE PARTS (Continued)

PART NAME	QTY	H/C	PART NUMBER
Bolt, flange, 8 x 14 mm, engine guard/skid plate	3	0687863	95700-08014-00
Bolt, flange, 8 x 14 mm, rear right carrier	2	0687863	95700-08014-00
Bolt, flange, 8 x 18 mm, front carrier	2	1096791	95700-08018-00
Bolt, flange, 10 x 16 mm, trailer hitch	4	0562694	95700-10016-08
Owner's manual	1	1837756	-----
Rear wheel, left	1	-----	42700-HA0-000
Rear wheel, right	1	-----	42720-HA0-000
Nut, brake adjust	1	0710921	43459-434-000
Front axle collar	1	1822659	44312-HA0-000
Front axle	1	1822642	44301-HA0-010
Front wheel	1	-----	44600-HA0-000
Front brake	1	-----	45000-HA0-030
Front fork, right	1	1823095	51400-HA0-003
Front fork, left	1	1823160	51500-HA0-003
Bolt, flange, 8 x 36 mm, upper holder	2	1282201	90111-402-700
Brake return spring	1	0271056	95014-7310
Brake arm joint B	1	0257758	95015-3200
Valve cap, front and rear wheels	3	-----	-----

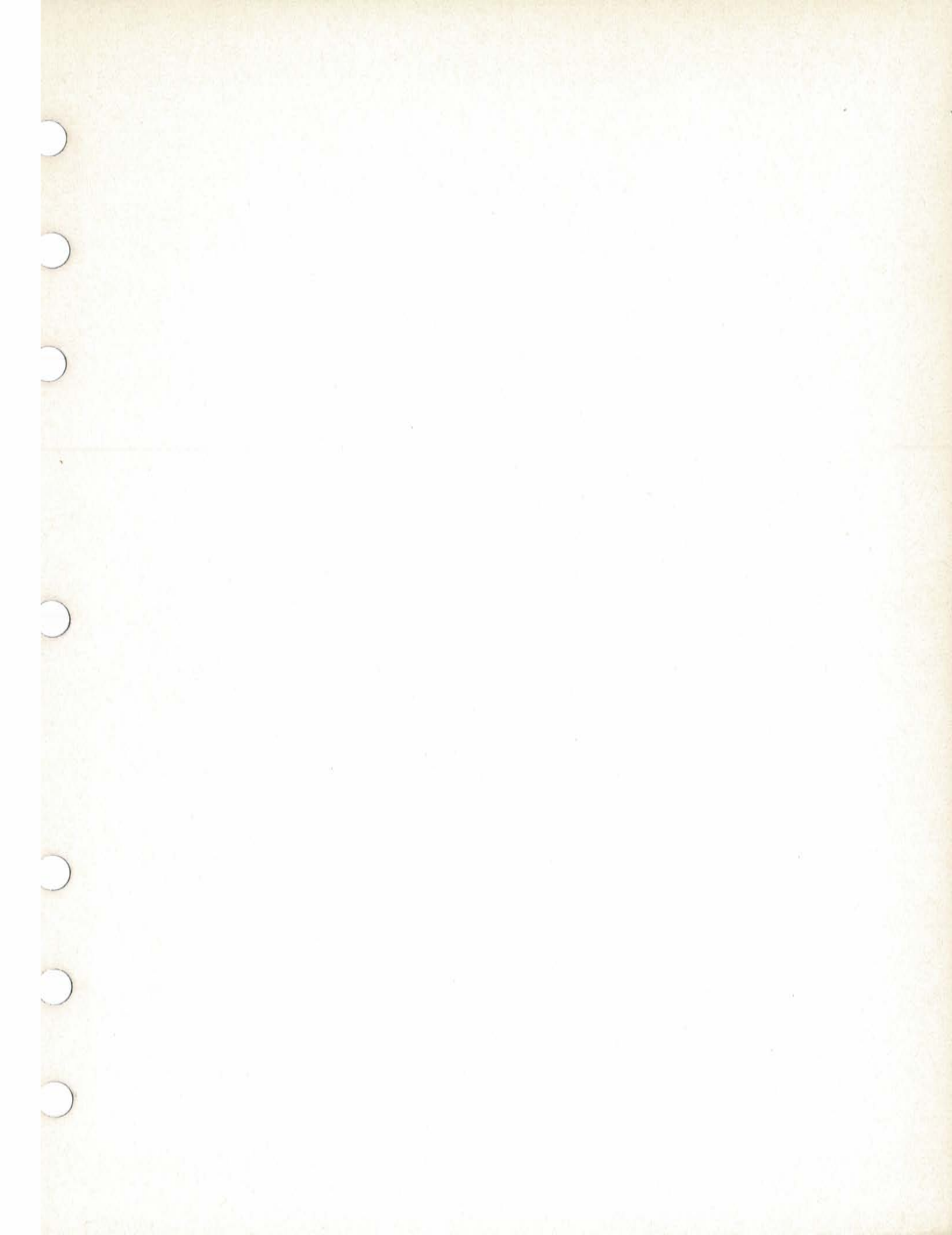

READ THIS READ THIS READ THIS

READ THIS

READ THIS

READ THIS

READ THIS READ THIS READ THIS

HONDA

Modifications which you have made, or should make in the future, to any Honda product, shall be deemed by our company to have been performed at your sole risk and responsibility, and without our company's or the manufacturer's approval or consent, implied or expressed. We further disclaim any and all liability, obligation, or responsibility for any defects of modified parts or of the modified product, and for any claims, demands, or causes of action for damage to property or for personal injuries resulting from the modification of said Honda product.