

 **HONDA**

1982

Owner's Manual



ATC185S

**HONDA ATC185S
OWNER'S MANUAL**

1982



All information in this publication is based on the latest product information available at the time of approval for printing. HONDA MOTOR CO., LTD. reserves the right to make changes at any time without notice and without incurring any obligation.

No part of this publication may be reproduced without written permission.

//////////////////////PREFACE.//////////////////////

This booklet is your guide to the basic operation and proper maintenance of your new Honda ATC185S. Please take the time to read it carefully. Details necessary for riding the Honda ATC are given to acquaint the new owner with special riding techniques to be learned. When service is required, remember that your Honda dealer knows your vehicle best. If you have the required mechanical "know-how" and tools, your dealer can supply you with an official Honda Shop Manual to help you perform many maintenance and repair tasks.

Thank you for selecting a Honda. We wish you continued riding pleasure in the miles ahead.

CONTENTS

	Page		Page
ATC SAFETY	1	Clutch	41
DESCRIPTION	2	Brakes	42
Parts Location	2	Throttle Cable	45
Serial Numbers	4	Drive Chain	46
Parts Function	5	Cam Chain	47
Fuel	9	Spark Arrester	48
Engine Oil	11	STORAGE	49
Tires	13	TRANSPORTING	50
OPERATION	15	OPTIONAL PARTS	53
Pre-ride Inspection	15	SPECIFICATIONS	55
Starting the Engine	16	WIRING DIAGRAM	56
Break-in	19		
Riding	20		
Parking	28		
MAINTENANCE	29		
Maintenance Schedule	29		
Tool Kit	31		
Engine Oil	32		
Fuel Filter	33		
Carburetor	34		
High Altitude	35		
Spark Plug	37		
Air Cleaner	38		
Valves	39		

WARNING

- * *ATC riding requires special efforts on your part to ensure your safety. Know these requirements before you ride.*

SAFE RIDING RULES

- * Always make a pre-ride inspection (page 15) before you start the engine. You may prevent an accident or equipment damage.
- * Always obey local off-road riding laws and regulations.
- * Obtain permission to ride on private property. Avoid posted areas and obey "no trespassing" signs.
- * Know the terrain on which you are riding. If you are not familiar with the terrain, ride cautiously. Hidden rocks, holes or ravines could spell disaster.
- * Your ability to operate safely is largely dependent upon your proper judgement in operating the machine.
- * Do not use the flag pole bracket as a trailer hitch.

PROTECTIVE APPAREL

- * Most cycle accident fatalities are due to head injuries; **ALWAYS** wear a helmet. You should also wear a face shield or goggles, boots, gloves and protective clothing.
- * The exhaust system becomes very hot during operation and it remains hot after operation. Never touch any part of the hot exhaust system. Wear clothing that fully covers your legs.

MODIFICATIONS

- * Modification of the ATC, or removal of original equipment may render the vehicle unsafe or illegal.
- * Spark arresters and mufflers are required in most areas. Don't modify your exhaust system. Remember that excessive noise bothers everyone and creates a bad image for motorcycling.

DESCRIPTION

PARTS LOCATION

- (1) Fuel tank cap
- (2) Front brake lever
- (3) Throttle lever
- (4) Headlight switch
- (5) Ignition switch
- (6) Oil filler cap
- (7) Foot peg
- (8) Rear brake pedal

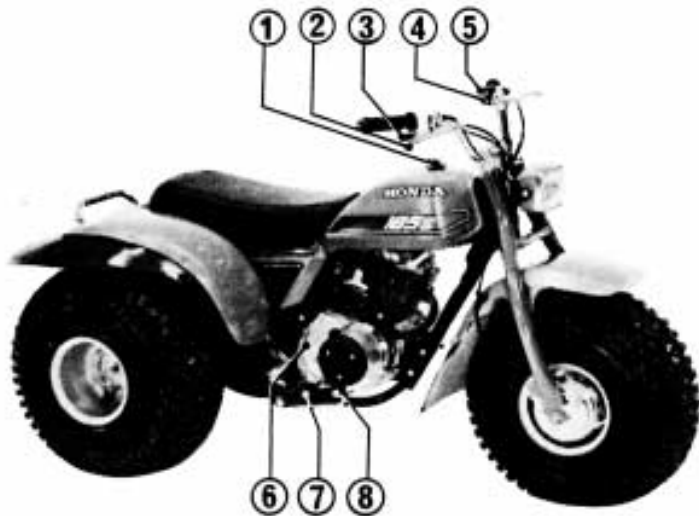

- (9) Fuel valve
- (10) Rear brake lever/parking brake
- (11) Choke lever
- (12) Recoil starter
- (13) Neutral indicator
- (14) Gearshift pedal

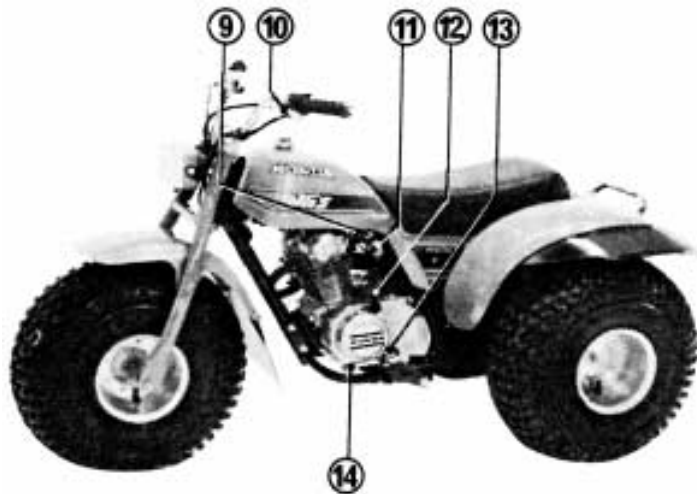

SERIAL NUMBERS

The frame and engine serial numbers are required by your dealer when ordering replacement parts. Record the numbers here for your reference.

FRAME NO. _____

ENGINE NO. _____

The frame serial number (1) is stamped on the left of the steering head. The engine serial number (2) is stamped on the crankcase just above the left foot peg.



(1) Frame serial number



(2) Engine serial number

PARTS FUNCTION

Ignition Switch

The three position ignition switch (1) is next to the left handlebar grip. At RUN, the engine will operate. In either OFF position the engine will not operate.

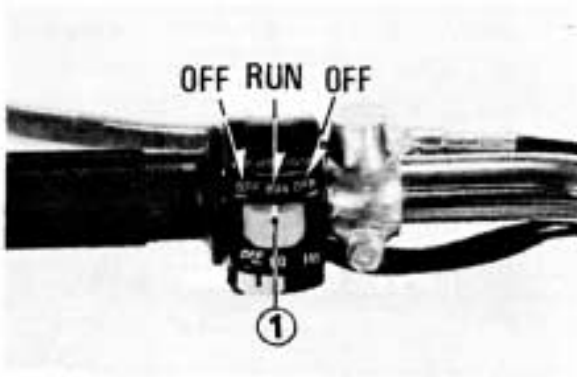

(1) Ignition switch

Headlight Switch

The headlight switch (1) is below the ignition switch. Its operating positions are as follows:

Position	Function
OFF	Headlight is off.
LO	Headlight is on low beam.
HI	Headlight is on high beam.

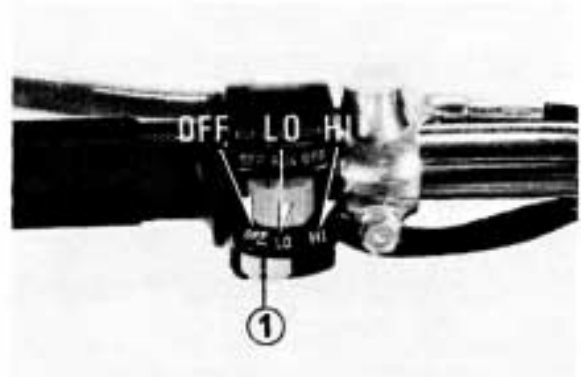

(1) Headlight switch

Throttle Lever

The throttle lever (1) is next to the right handlebar grip and is operated by the rider's thumb. Pressing the lever forward opens the throttle. When the lever is released, spring tension closes the throttle automatically.

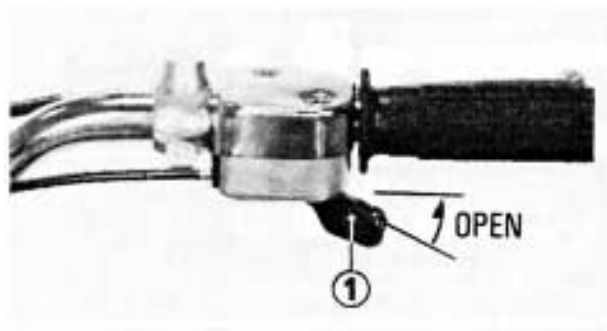

(1) Throttle lever

Brake Lever/Parking Brake

The rear brake lever (1) and the brake pedal both operate the rear wheel brake. Either one can be used to stop the ATC. The front brake lever is at the right handlebar grip. The rear brake lever has the added feature of a lock (2) which allows the lever to be used as a parking brake.

Pull the brake lever back and lock it with the lock. Always apply the parking brake when parking on a hill or when leaving the engine running.

NOTE:

- * Use of the parking brake in freezing weather may cause the brakes to freeze in the locked position.

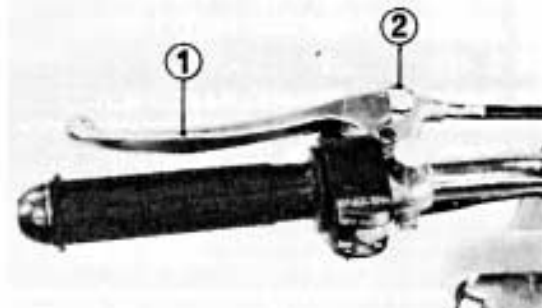

(1) Rear brake lever

(2) Parking brake lock

Gearshift Pedal

The gearshift pedal (1) is near the left foot peg. One full stroke of the pedal will shift the transmission. The pedal automatically returns to the horizontal position when released. Each stroke of the pedal engages the next gear in sequence.

Depress the pedal to shift to a higher gear and raise the pedal to shift to a lower gear.

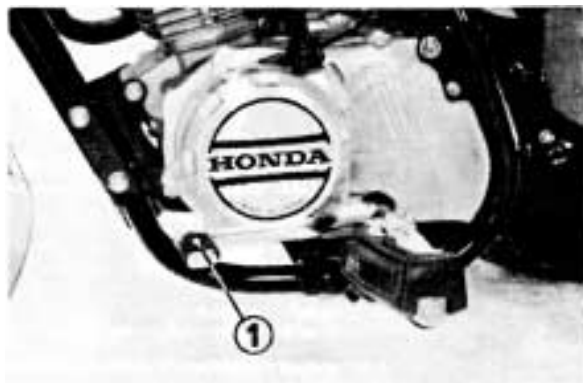

(1) Gearshift pedal

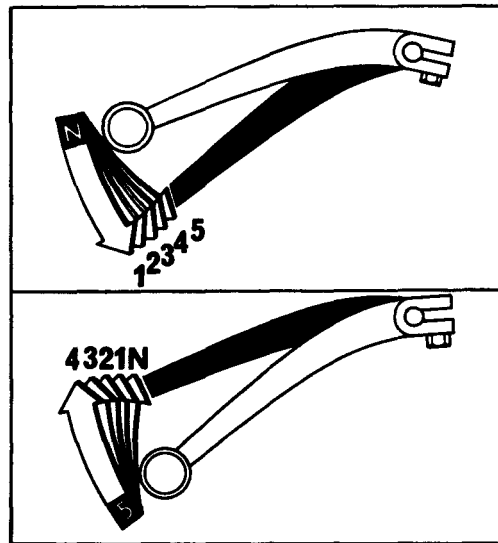

Shifting sequence

Neutral Indicator

The neutral indicator (1) is on the left crankcase cover, just behind the recoil starter. This feature enables the rider to verify that the transmission is in neutral before starting the engine.

The indicator rotates as the gears are changed. When the indicator aligns with the N mark on the crankcase, the transmission is in neutral.



(1) Neutral indicator

Choke Lever

The choke lever (1) is on the left side of the carburetor.

Raising the choke lever will close the choke valve. When the lever is raised, the carburetor will deliver a rich fuel mixture for starting the engine when cold. Lower the lever to open the choke valve as the engine attains normal operating temperature.

To restart a warm engine it is not necessary to use the choke.

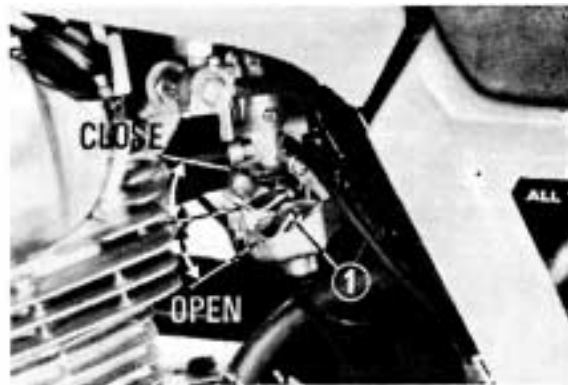

(1) Choke lever

FUEL

Fuel Valve

The three way fuel valve (1) is on the left side of the carburetor.

OFF

At OFF , fuel cannot flow from the tank to the carburetor. Turn the valve off whenever the ATC is not in use.

ON

At ON , fuel will flow from the main fuel supply to the carburetor.

RES

At RES , fuel will flow from the reserve fuel supply to the carburetor. Use the reserve fuel only when the main supply is gone. Refill the tank as soon as possible after switching to RES . The reserve fuel supply is 1.6ℓ (0.42 US gal).

NOTE:

- * Do not operate the machine with the fuel valve in the RES position after refueling. You may run out of fuel, with no reserve.

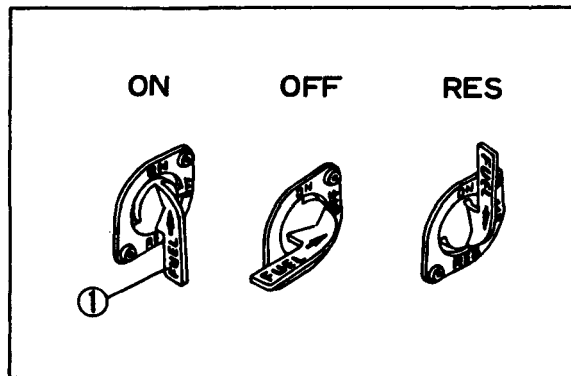

(1) Fuel valve

Fuel Tank

Fuel tank capacity is 8.8ℓ (2.3 US gal) including 1.6ℓ (0.42 US gal) in the reserve supply. Remove the fuel tank cap (2) by twisting counterclockwise.

Any automotive gasoline with a pump octane number ($\frac{R+M}{2}$) of 86 or higher, or research octane number of 91 or higher may be used.

If “knocking” or “pinging” occurs, try a different brand of gasoline or a higher octane grade.

The fuel tank cap (2) has a lever (1) with ON and OFF positions to open or close the tank vent. The lever should be turned to ON to allow fuel to flow when running the engine.

Turning the lever to OFF will prevent fuel from flowing out the vent hole when transporting the ATC.

WARNING

- * *Gasoline is extremely flammable and is explosive under certain conditions. Refuel in a well ventilated area with the engine stopped. Do not smoke or allow open flames or sparks in the area where the vehicle is refueled or where gasoline is stored.*

- * *Do not overfill the tank (there should be no fuel in the filler neck). After refueling, make sure the filler cap is closed securely.*
- * *Avoid repeated or prolonged contact with skin or breathing of vapor. KEEP OUT OF REACH OF CHILDREN.*

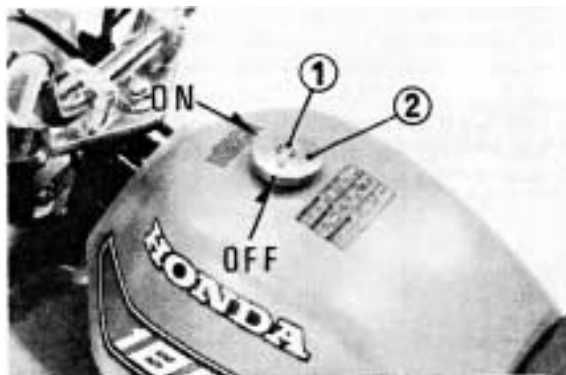

(1) Vent lever

(2) Fuel filler cap

ENGINE OIL

Engine Oil Level Check

Check engine oil level each day before operating the ATC.

The oil filler cap (1) is on the right crankcase cover and contains a dipstick for measuring the oil level. The oil level must be maintained between the upper (2) and lower (3) level marks on the dipstick.

1. With the machine on level ground, remove the oil filler cap/dipstick and wipe it clean.
2. Reinsert the dipstick without screwing it in and check the oil level.
3. Add the specified oil up to the upper level mark, if required.
4. Replace the filler cap/dipstick.

CAUTION:

- * *Running the engine with insufficient oil can cause serious engine damage.*

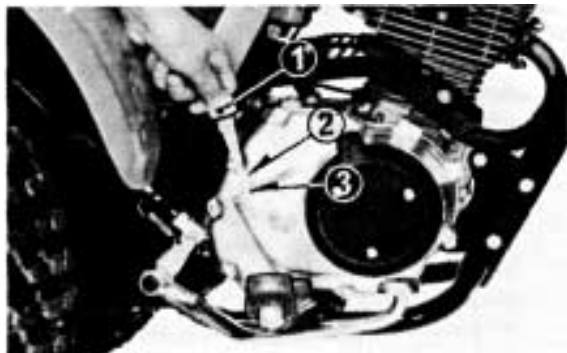

- (1) Oil filler cap/dipstick (3) Lower level mark
(2) Upper level mark

Engine Oil Recommendation

USE HONDA 4-STROKE OIL OR AN EQUIVALENT.

Use only high detergent, premium quality motor oil certified to meet or exceed US automobile manufacturer's requirements for Service Classification SE or SF.

Motor oils intended for Service SE or SF will show this designation on the container. The use of special oil additives is unnecessary and will only increase operating expenses.

CAUTION:

* *Engine oil is a major factor affecting the performance and service life of the engine. Non-detergent, vegetable, or castor based racing oils, are not recommended.*

Recommended oil viscosity:
SAE 10W-40

Other viscosities shown in the chart below may be used when the average temperature in your riding area is within the indicated range.

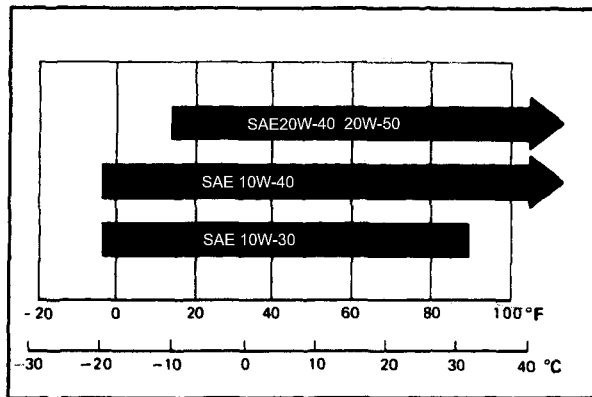

TIRES

The ATC185S is equipped with 22x11.0-8 low pressure tubeless tires to promote comfortable riding. Although the tires are designed specifically for vigorous off-road use, they are not immune to punctures. Always select your riding area with care.

CAUTION:

* *Driving on paved surfaces will cause excessive tire wear.*

For normal use, the tires should be inflated to a recommended pressure of 2.2 psi (15 kpa, 0.15 kg/cm²). A manually operated tire pump should be used rather than the high pressure systems found in service stations. This will minimize the possibility of tire damage from overinflation.

NOTE:

* Tire pressure should be checked when the tires are "cold", before you ride.

If no air pressure gauge is available to accurately measure 2.2 psi (15 kpa, 0.15 kg/cm²), this value can be estimated by measuring the circumference of the tires with a measuring tape. When inflated to 2.2 psi (15 kpa, 0.15 kg/cm²), the maximum tire circumference measured over the tread ribs will be approximately 1,743 mm (68.6 in.). The relationship

between tire pressure and actual circumference varies slightly with factors of wear and stretching that occur through use.

Recommended Pressure: 2.2 psi (15 kpg, 0.15 kg/cm²)

Standard Tire Circumference: 1,743 mm (68.6 in.)

Min. Pressure: 1.7 psi (12 kpa, 0.12 kg/cm²)



 **WARNING**

- * *Be sure to inflate both rear tires equally. If the ATC185S is operated with unequal tire pressures, the resultant difference in tire circumference will cause the ATC185S to run toward one side and will adversely affect handling.*

CAUTION:

- * *Maintain proper tire pressure. Underinflated tires may adversely affect maneuverability and cause wheel damage when riding over bumpy terrain. Overinflated tires may rub on the fenders and hamper movement of the ATC.*

If you have a flat tire, use the plug method to make temporary repairs. The plug method is the same as that for conventional tubeless tires. A plug type repair kit, which is available at most auto part stores or service stations, provides a plug, an installation tool, tire cement, and an instruction sheet. Follow the instructions provided in the repair kit to make a temporary repair until the tire can be permanently repaired by the cold patch method. Any tire which cannot be repaired by the plug method should be replaced.

Whenever the ATC is to be operated far from service facilities or available transportation, we recommend that the rider carry a tire pump and a suitable repair kit with him.

Emergency Puncture Repairs

If you have a flat tire, and a plug type repair kit is not available, use one of the following methods to make temporary repairs: Stuff a narrow strip of cloth kneaded with chewing gum into the hole or plug the hole with a nail or screw.

PRE-RIDE INSPECTION

WARNING

** If the Pre-ride Inspection is not performed, serious damage or an accident may result.*

Inspect your ATC185S every day before you start the engine. The items listed here will only take a few minutes, and in the long run they can save time, expense, and possibly your life.

1. Engine oil level – add engine oil if required (page 11). Check for leaks.
2. Fuel level – fill fuel tank when necessary (page 10). Check for leaks.
3. Brakes – check operation; Adjust free play if necessary (page 42).
4. Tires – check condition and pressure (page 13).
5. Drive chain – check condition and slack (page 46). Adjust and lubricate if necessary.
6. Throttle – check for smooth opening and closing in all steering positions (page 6).
7. Headlight switch – check for proper function (page 5).

8. Ignition switch – check for proper function (page 5).
9. Nuts, Bolts, Fasteners – check wheels to see that axle nuts are tightened and secured by cotter pins. Check security of all other nuts, bolts and fasteners.

Correct any discrepancy before you ride. Contact your authorized Honda dealer for assistance if you cannot correct the problem.

STARTING THE ENGINE

WARNING

- * *Never run the engine in a closed area. The exhaust contains poisonous carbon monoxide gas.*
- * *Do not try to start the engine with the transmission in gear. You may injure yourself or damage the vehicle.*

Preparation

1. Select a level surface and set the parking brake before starting the engine.
2. Turn the fuel vent lever (1) and fuel valve (2) ON.
3. Move the ignition switch (3) to RUN.

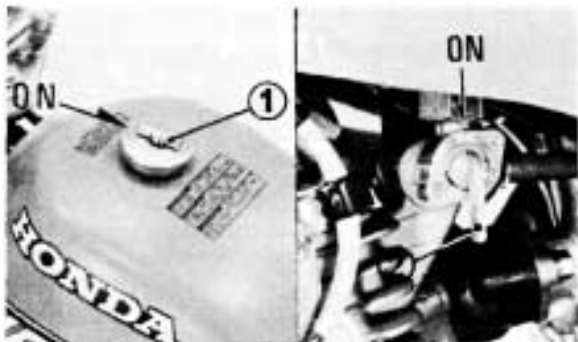

(1) Vent lever

(2) Fuel valve

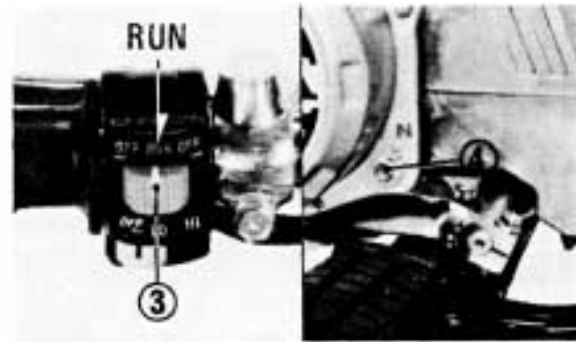

(3) Ignition switch

(4) Neutral indicator

Starting Procedure

To restart a warm engine, follow the procedure for High Air Temperature.

Normal Air Temperature

10°–35°C (50°–95°F)

1. Raise the choke lever (6) completely to Fully Closed (A).
2. Open the throttle (5) slightly.
3. Pull the recoil starter (7) briskly.

NOTE:

- * Since the engine decompression system is interlocked with the recoil starter a quick, rigorous pull on the starter rope will be the most effective way for starting.

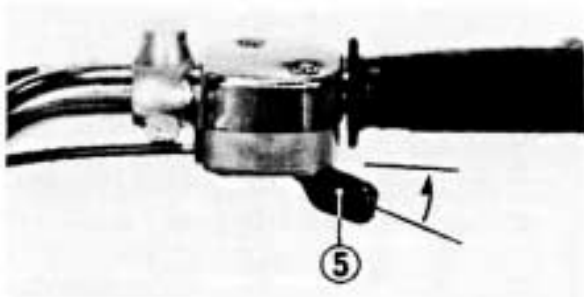

(5) Throttle lever

4. Immediately after the engine starts, push the choke lever down to the detent position (B).
5. About a half minute after the engine starts, push the choke lever down all the way to Fully Open (C).
6. If idling is unstable, open the throttle slightly.

High Air Temperature

35°C (95°F) or above

1. Do not use the choke.
2. Open the throttle slightly.
3. Start the engine (See step 3 under Normal Air Temperature).



(6) Choke lever (B) Detent position
(A) Fully closed (C) Fully open

Low Air Temperature

10°C (50°F) or below

1. Follow steps 1–3 under Normal Air Temperature.
2. If idling is unstable, push the choke lever down to the detent position (B).
3. Warm up the engine by opening and closing the throttle slightly.
4. Continue warming up the engine until it will idle smoothly with the choke lever pushed down all the way to Fully Open (C).



(7) Recoil starter rope

CAUTION:

- * *Extended use of the choke may impair piston and cylinder wall lubrication.*
- * *Do not race the engine during the warm up period. Racing a cold engine wastes fuel and increases engine wear.*

Flooded Engine

If the engine does not start after several attempts, it may have become flooded with excess fuel. To clear the engine, turn the ignition switch off, push the choke lever down completely, hold the throttle fully open, and pull the recoil starter rope several times.

When the engine is cleared, turn the ignition switch on and repeat the normal starting procedure, but do not use the choke.

BREAK-IN

During the first few days of riding, operate your new ATC185S so that the engine neither pulls laboriously nor approaches maximum rpm in any gear. Avoid full throttle operation, and select your gears to spare the engine undue stress. Careful break-in procedure during initial operation will measurably extend the service life of the engine.

RIDING

Review ATC Safety (page 1) before you ride.

WARNING

- * *Avoid "wheelies" and jumping as they may cause loss of control.*
- * *Ride with your feet on the foot pegs at all times. If your feet are removed from the pegs to touch the ground while the ATC is moving, they may come in contact with the rear wheels.*

Under normal riding conditions it is not necessary or desirable to touch the ground for balance.

For your initial riding practice, select a safe area free of obstacles and with an even surface. Avoid paved surfaces as they make learning to maneuver more difficult, and will also significantly shorten tire life.

1. After the engine has been warmed up, release the parking brake. The machine is ready for riding.
2. While the engine is idling, depress the gearshift pedal to shift into low (1st) gear.
3. Increase engine speed by opening the throttle.
4. When the speed increases, close the throttle and shift to 2nd gear by depressing the gearshift pedal.

CAUTION:

- * *Do not shift gears without closing the throttle. The engine and drive train could be damaged by overspeed and shock.*

5. This sequence is repeated to progressively shift to 3rd, 4th and top (5th) gear.

CAUTION:

- * *Do not tow the vehicle or coast for long distances while the engine is off. The transmission will not be properly lubricated and damage may result.*

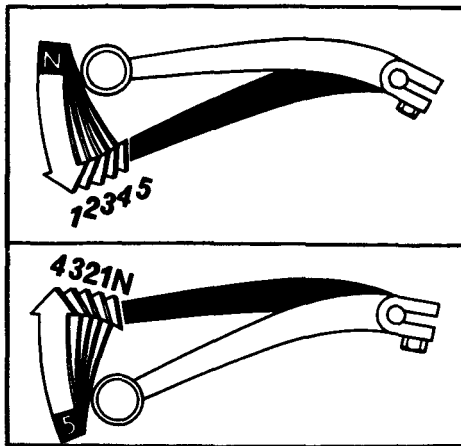

Shifting sequence

Turning Maneuvers

For better traction in off-road use, the ATC has been fitted with a rear axle which drives both rear wheels equally at all times.

When negotiating a turn, the wheel on the outside of the turn must travel a wider radius, and thus a greater distance, than the inside wheel. As the rear axle does not permit a differing rate of wheel rotation, it is not enough to merely steer the ATC into a turn. The new rider must learn to shift his weight and control the throttle to allow the rear tires to negotiate the turn. This is the primary technique to be mastered in riding the Honda ATC.

Practice turning the ATC at slow, constant speeds. Defer higher speeds until you are confident of your proficiency.

Steer in the direction of the turn, and lean your body to the inside of the turn, while supporting your weight on the outer foot peg. Use the throttle to maintain power throughout the turn.

This technique allows the ATC to lean slightly toward the outside, altering the balance of traction between the rear wheels sufficiently to allow them to negotiate the turn.

Once this technique is learned, turning maneuvers can be performed within a relatively small area.

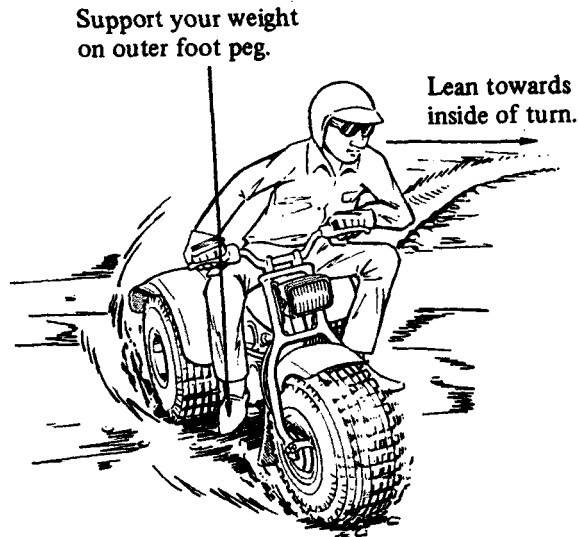

Incorrect turning techniques may cause the front wheel to slide straight ahead when steered without affecting the ATC's direction of travel. If this should occur, close the throttle and come to a stop. Then continue practicing the technique outlined on the preceding page.

If the front wheel tends to skid in mud or snow, you may be able to improve control under these conditions by leaning forward, transferring additional weight to the front wheel.

If the rear wheels inadvertently skid sideways, correct your slide by steering in the direction of the skid if you have room to perform this maneuver safely. Avoid braking or accelerating until you have directional control.

To avoid skids while traveling on slippery terrain, the rider must exercise a high degree of caution. Controlled skids and spins, when performed safely, add to the sport the rider can enjoy. However, as skidding maneuvers are inherently more hazardous than those performed under full traction, we must caution the rider to first master the basic techniques of handling before practicing any skidding maneuver.

Surface composition is, of course, a major factor affecting skidding capability. It is obviously easier to slide on packed snow than in deep sand. Surfaces with extremely low or extremely high coefficients of friction must not be used for skidding maneuvers. It is dangerous to skid on ice, because you may lose all directional control, and it is dangerous to skid on pavement, because you may regain traction suddenly and unexpectedly, which can cause you to lose your balance and overturn.

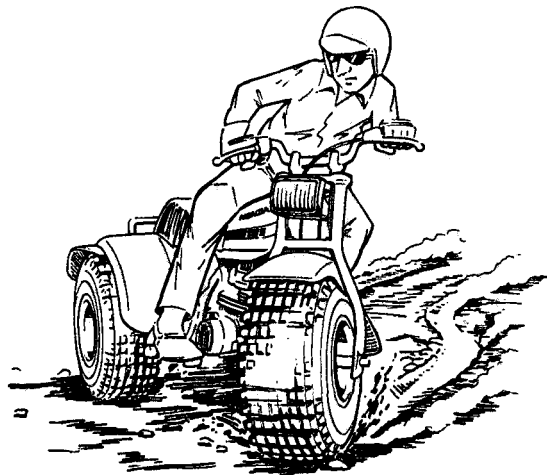

Climbing Hills

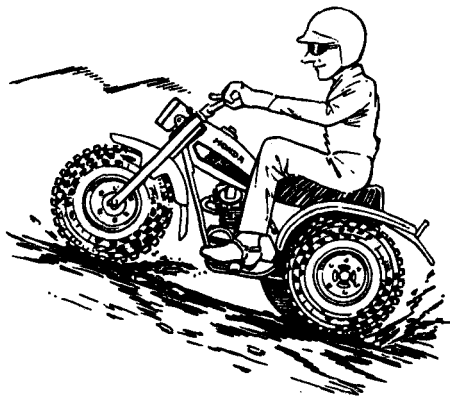

Practice climbing on evenly surfaced slopes of less than 20° . The ATC's capability in climbing hills or traversing any specific terrain is dependent upon rider skill. As you gain experience in handling the ATC, and learn the hazards to be encountered and your own limitations, you may then proceed to ride more challenging terrain. However, you must first be able to discern and avoid any hill or hazard that would cause the ATC to overturn.

The riding technique for hill climbing involves transferring your weight toward the front wheel to keep it in contact with the ground. This may be done by leaning forward, or for greater weight transference, by standing on the foot pegs and leaning forward.

Take a running start, in the appropriate gear and speed for the ascent, and climb at a steady rate of speed.

WARNING

- * *Do not apply power suddenly by opening the throttle or changing gears while ascending a hill or the front wheel may rise from the ground. If the front wheel lifts, rider control will be lessened and the ATC may overturn backward.*

If you should find that you have incorrectly estimated climbing capability and lack the power or traction to continue the ascent, then if space permits, turn the ATC around while you still have the forward speed to do so and descend. Avoid stalling part way up a hill, as maneuvering will then become more difficult.

WARNING

- * *Before attempting a turn on a hillside, the rider should first master turning technique on level ground.*

If you do lose all forward speed, and can neither continue uphill nor maneuver the ATC under its own power, dismount and physically turn the machine around. If it cannot be turned and must be backed down, first shift the transmission into neutral and use only the front brake. However, we strongly recommend that the rider turn the ATC around rather than back it downhill.

WARNING

- * *To avoid overturning, the rider must exercise a high degree of caution when dismounting or moving the ATC on a hillside.*

- * *Applying the rear brake or engaging the transmission, while rolling backward downhill can easily cause the ATC to overturn and fall on the rider.*



Descending Hills

It is usually advisable to descend hills with the ATC pointed directly downhill, avoiding angles that would cause the vehicle to lean sharply to one side. As you approach the point of descent, stop and survey the terrain below. Never ride headlong past your limit of visibility. When you have picked a safe path of descent, shift the transmission into low gear and descend slowly with the throttle closed. Sit back on the seat, with arms extended and braced on the handlebars.

When descending sand dunes, we recommend that the rider apply the brakes intermittently to further reduce forward speed.

Braking effectiveness is, of course, reduced while descending any incline with a loose surface.

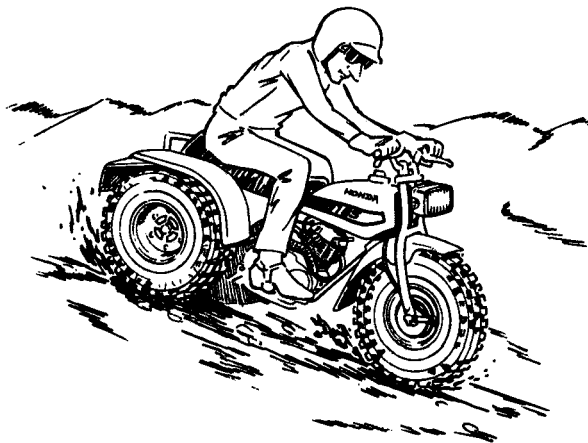

Traversing Slopes

When riding across a slope, at right angles to the incline of the hill, lean your body in the uphill direction to maintain balance and stability. On a loose surface such as sand, it may become necessary to steer slightly uphill in order to maintain your course of travel.

WARNING

- * *Balance is more precarious while the ATC is tilted to one side. Avoid traversing slopes where there is slippery or difficult terrain.*



Riding Through Water

WARNING

- * *Do not ford any stream with fast flowing water. The tires may float, making it difficult to maintain control.*
- * *Do not ride the vehicle through water for prolonged periods.*

The Honda ATC can ford water to a depth of approximately 11 inches, although the rider must be careful to avoid getting the spark plug or air cleaner wet.

When crossing streams, choose a course where both banks have gradual inclines. Proceed at a slow, steady speed, and take care to avoid submerged obstacles and slippery rocks.

After riding through water, the brakes may be less effective than normal. Test the brakes after traveling through any water, and if necessary, apply the brakes repeatedly until the heat of friction has dried them, and the brakes regain their normal effectiveness.



High Altitude Riding

When operating this vehicle at high altitudes the air-fuel mixture becomes overly rich. Above 6,500 feet (2,000 m) driveability and performance may be reduced and fuel consumption increased. The carburetor can be modified to compensate for this high altitude richness. However, the carburetor must be returned to standard factory specifications when lower altitude riding is desired. (See pages 35~36).

CAUTION:

* *Sustained operation at altitudes below 5,000 feet (1,500 m) with high altitude carburetor modifications may cause engine overheating and damage.*

PARKING

1. Stop the vehicle, shift the transmission into neutral, turn the fuel valve, fuel cap lever, and ignition switch OFF.
2. Pull the parking brake lever and lock it. (See page 6.)

MAINTENANCE

MAINTENANCE SCHEDULE

The maintenance intervals shown in the following schedule are based upon average riding conditions. Machines subjected to severe use, or ridden in unusually dusty areas, require more frequent servicing. Items marked * should be serviced by an authorized Honda dealer, unless the owner has the proper tools and is mechanically proficient. Other maintenance items are simple to perform and may be serviced by the owner.

Perform the Pre-ride Inspection (Page 15) at each scheduled maintenance period.

I: Inspect and Clean, Adjust, Lubricate or Replace, if necessary C: Clean R: Replace A: Adjust		INITIAL SERVICE PERIOD (First week of operation)	REGULAR SERVICE PERIOD (Every 30 operating days)	Refer to page	
	ENGINE OIL	NOTE (1), (2)	R	R	32
*	ENGINE OIL FILTER SCREEN		C	C	32
	AIR CLEANER ELEMENT	NOTE (2)		I	38
	SPARK PLUG			I	37
*	VALVE CLEARANCE		I	I	39
*	CAM CHAIN TENSIONER		A	A	47
*	CARBURETOR		I	I	34

NOTE: (1) Replace every 30 operating days or every 3 months, whichever comes first.
(2) Service more frequently when riding in dusty areas.

I: Inspect and Clean, Adjust, Lubricate or Replace, if necessary C: Clean R: Replace A: Adjust		INITIAL SERVICE PERIOD (First week of operation)	REGULAR SERVICE PERIOD (Every 30 operating days)	Refer to page
	FUEL LINE	I: (EVERY YEAR)		33
*	FUEL STRAINER	C: (EVERY YEAR)		33
	THROTTLE OPERATION	I	I	45
	DRIVE CHAIN	I	I	46
*	BRAKE SHOES	I: (EVERY YEAR)		42
	BRAKE CONTROL LINKAGE	I	I	42
*	CLUTCH	A	A	41
*	SPARK ARRESTER		C	48
	ALL NUTS, BOLTS, FASTENERS	I	I	—
	LIGHTING EQUIPMENT	I	I	—
	TIRES	I	I	13
*	STEERING HEAD BEARING	A: (EVERY YEAR)		—

WARNING

- * *Always turn the engine off before performing any maintenance operations unless otherwise stated.*
- * *To maintain the safety and reliability of your HONDA ATC do not modify it and use only new genuine HONDA parts or their equivalent when servicing or repairing.*
The use of replacement parts which are not of equivalent quality may impair the operation of your ATC.

TOOL KIT

The tool kit (1) is stored under the seat. Remove the rear fender by sliding the lever (2) to remove the tool kit. The tools provided are sufficient to perform routine maintenance and simple repairs. Any extensive work requiring additional tools should be performed by an authorized Honda motorcycle dealer.

Listed below are the items included in the tool kit:

- 10x12mm open end wrench
- 17x14mm open end wrench
- Spark plug + 19mm socket wrench
- Pliers ● Screwdriver blade ● Screwdriver handle
- 24mm socket wrench ● T-handle
- Tool bag

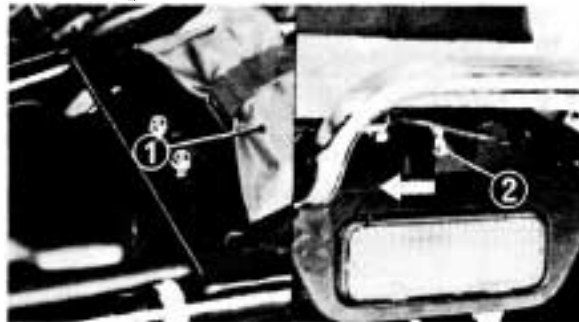

(1) Tool kit

(2) Lever

ENGINE OIL

Engine oil should be changed in accordance with the maintenance schedule. Use motor oils of the grade and viscosity recommended on Page 12.

When changing oil, drain the used oil from the crankcase while the engine is still warm. This will ensure complete and rapid draining.

1. Remove the oil filler cap from the right crankcase cover.
2. Place an oil drain pan under the crankcase and remove the oil drain plug (1) with a 24mm socket wrench.

NOTE:

* The oil filter screen (2) and spring (3) will come out when the drain plug is removed.

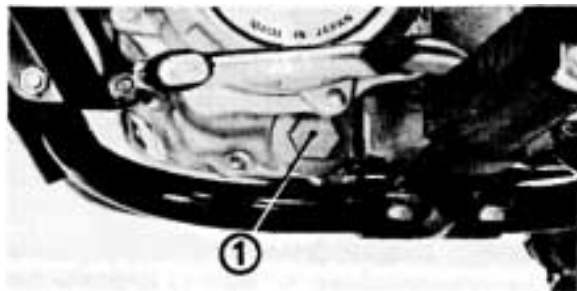

(1) Drain plug

3. After the oil stops draining pull the recoil starter several times to drain any oil which may be left in the engine.

(Make sure the ignition switch is at OFF.)

4. Clean the oil filter screen.
5. Check that the oil filter screen, sealing rubber and drain plug O-ring are in good condition and install the drain plug.
6. Fill the crankcase with approximately 1.3ℓ (1.4 US qt) of the recommended grade of motor oil.
- 7 Make sure that the oil level is between the upper and lower marks on the dipstick. Add more oil if necessary.

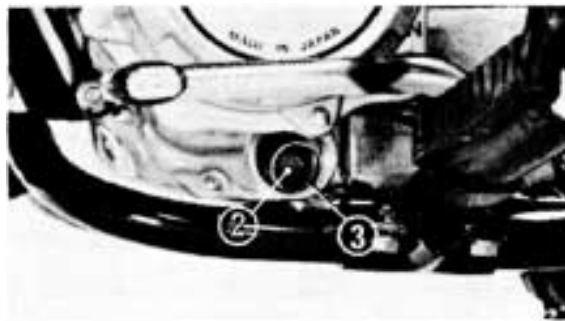

(2) Oil filter screen (3) Spring

FUEL FILTER

The fuel filter is incorporated in the fuel valve. Accumulation of dirt in the filter will restrict the flow of fuel and therefore, the fuel filter should be serviced periodically.

1. Drain the fuel from the fuel tank. Disconnect the fuel line.

WARNING

** Gasoline is extremely flammable and is explosive under certain conditions. Perform this operation in a well ventilated area. Do not smoke or allow flames or sparks in the area.*

2. Remove the fuel valve (1) by loosening the mounting nut and remove the fuel filter (2). Wash it in clean non-flammable or high flash point solvent.

WARNING

** Never use gasoline or low flash point solvents for cleaning the fuel filter. A fire or explosion could result.*

3. Reinstall the fuel filter and fuel valve in the reverse order of removal and turn the fuel valve ON. Check for leaks.
4. Check the fuel line (3) for deterioration, damage or leakage. Replace if necessary.



(1) Fuel valve
(2) Fuel filter

(3) Fuel line

CARBURETOR

NOTE:

- * Do not attempt to compensate for faults in other systems by carburetor adjustment. See your authorized Honda dealer for regularly scheduled carburetor adjustments.
- * The engine must be warm for accurate idle adjustment. Ten minutes of stop-and-go riding is sufficient.

1. Warm up the engine.
2. Adjust idle speed with the throttle stop screw (1)
IDLE SPEED: 1,400 \pm 100 rpm
3. Turn the pilot screw (2) clockwise until you hear the engine miss or decrease in speed, then counter-clockwise until the engine again misses or decreases in speed. Center the pilot screw exactly between these two extreme positions.

Usually the correct setting (between extremes of rich and lean) will be found to be 2 turns open from a fully closed position.

If idle speed changes after adjusting fuel mixture, readjust the throttle stop screw.



(1) Throttle stop screw (2) Pilot screw

HIGH ALTITUDE

When operating this vehicle at high altitude the air-fuel mixture becomes overly rich.

Above 6,500 feet (2,000 m) driveability and performance may be reduced and fuel consumption increased.

A high altitude jet is available for carburetor modification to compensate for this high altitude richness. Although installation and adjustment procedures are offered here, unless you are mechanically proficient and have the necessary tools we strongly urge that this carburetor modification be performed by your authorized Honda dealer.

CAUTION:

- * Sustained operation at lower altitudes below 5,000 feet (1,500 m) with the high altitude jet installed may cause overheating and damage.

Altitude	Main jet	Pilot screw	Jet needle
Below 6,500 feet	No. 100	Factory preset	2nd notch
Above 5,000 feet	No. 92	1/4 turn clockwise	1st notch

Installation: Above 5,000 ft (1,500 m)

1. Turn the fuel valve OFF.
2. Place the carburetor drain tube in a suitable container. Turn the carburetor drain screw counterclockwise and drain the carburetor.
3. Unscrew the carburetor cap, pull out the throttle valve, and remove the carburetor.

WARNING

- * Gasoline is extremely flammable and is explosive under certain conditions. Perform this operation in a well ventilated area. Do not smoke or allow flames or sparks in the area.
4. Remove the float chamber.
 5. Remove the standard main jet (No. 100) and



(1) Main jet

install the high altitude main jet (No. 92) (1). Reinstall the float chamber.

6. Remove the jet needle (2) from throttle valve (3). Change the position of the E-clip (4) from the 2nd notch to the 1st notch.

Reinstall the jet needle into the throttle valve.

7. Slide the throttle valve into the carburetor and tighten the cap. Install the carburetor. Make sure the drain screw is turned fully clockwise and turn the fuel valve ON.
8. Start the engine. Adjust the idle speed and pilot screw (page 34).

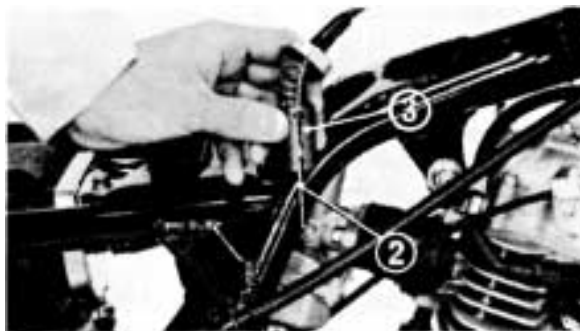

(2) Jet needle

(3) Throttle valve

NOTE:

- * Adjust the idle speed and pilot screw at high altitude to ensure proper high altitude operation.

Removal: Below 6,500 ft (2,000 m)

1. Follow installation steps 1-4.
2. Reinstall the original No. 100 main jet.
3. Change the jet needle clip back to the 2nd notch.
4. Reinstall the carburetor. Adjust the idle speed and pilot screw (page 34).

NOTE:

- * Adjust the idle speed and pilot screw at low altitude to ensure proper low altitude operation.

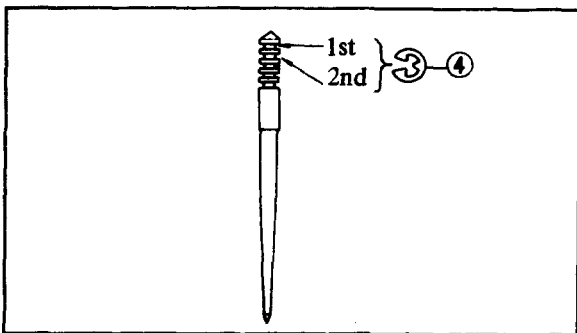

(4) E-clip

SPARK PLUG

Standard spark plug

NGK DR8ES-L or ND X24ESR-U

CAUTION:

* *The use of spark plugs of incorrect size or heat range can cause serious engine damage.*

1. Disconnect the spark plug cap.
2. Clean any dirt from around the spark plug base.
3. Remove the plug with the wrench provided in the tool kit.
4. Visually inspect the spark plug electrodes for wear. The center electrode should have square edges and the side electrode should not be eroded. If the electrodes and insulator tip appear unusually fouled or burned, we suggest that you contact an authorized Honda dealer. Discard the spark plug if there is apparent wear or if the insulator is cracked or chipped.
5. Make sure that the spark plug gap is 0.6–0.7 mm (0.024–0.028 in) using a feeler gauge. If adjustment is necessary, bend the side electrode (1) carefully.

6. With the plug washer attached, thread the spark plug in by hand to prevent **crossthreading**.
7. Tighten a new spark plug $\frac{1}{2}$ turn with a spark plug wrench to compress the washer. If you are reusing a plug, it should only take $\frac{1}{8}$ – $\frac{1}{4}$ turn after the plug seats.

CAUTION:

* *The spark plug must be securely tightened. An improperly tightened plug can become very hot and possibly damage the engine.*

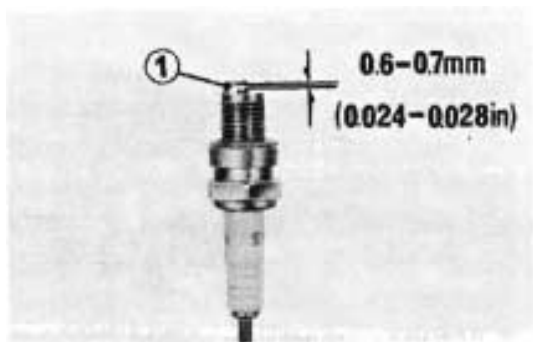

(1) Side electrode

AIR CLEANER

The air cleaner element accumulates dust and must be cleaned periodically. If the ATC185S is ridden in unusually dusty areas, the element must be cleaned at more frequent intervals than specified in the MAINTENANCE SCHEDULE.

1. Remove the rear fender by sliding the lever (1).
2. Remove the three bolts (2) attaching the air cleaner case and remove the air cleaner tube upper (3) and lower (4) clamp.
3. Remove the air cleaner assembly from the frame.
4. Remove the filter element, wash it in non-flammable or high flash point solvent. Allow it to dry thoroughly.

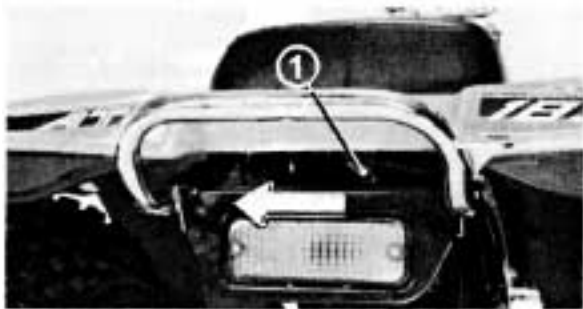

(1) Lever

5. Soak the filter element in clean gear oil (SAE 80–SAE 90) until saturated, then squeeze out the excess oil.
6. Reassemble by reversing the disassembly sequence.

WARNING

- * *Never use gasoline or low flash point solvents for cleaning the air cleaner element. A fire or explosion could result.*

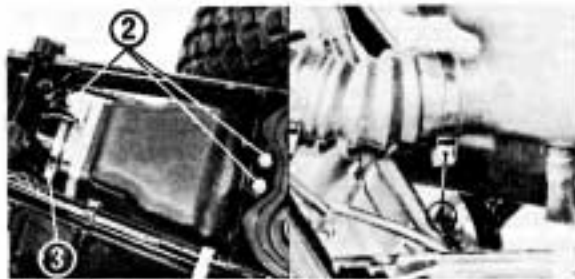

(2) Attaching bolts (3) Tube clamp (Upper)
(4) Tube clamp (Lower)

VALVES

Valve clearance should be maintained at 0.05 mm (0.002 in). Excessive clearance will cause noise. Insufficient clearance will cause loss of power and could cause valve damage.

NOTE:

* Check and adjust valve clearance while the engine is cold. The clearance may increase as the temperature rises.

1. Remove the timing mark cover and valve adjusting caps.
2. Rotate the generator rotor counterclockwise using the recoil starter until the T mark (1) on the generator rotor lines up with the timing index mark (2) on the left crankcase. In this position, the piston may either be on the compression or the exhaust stroke. The adjustment must be made when the piston is on top of the compression stroke when both the intake and exhaust valves are closed. This can be determined by moving the rocker arms by hand. If they are free, it is an indication that the valves are closed and that the piston is on the compression stroke. If they are tight and the valves are open, rotate the generator rotor 360° (one complete revolution) and realign the T mark to the timing index mark.

3. Check the clearance of both valves by inserting a 0.05 mm (0.002 in.) gauge between the adjusting screw and valve stem.

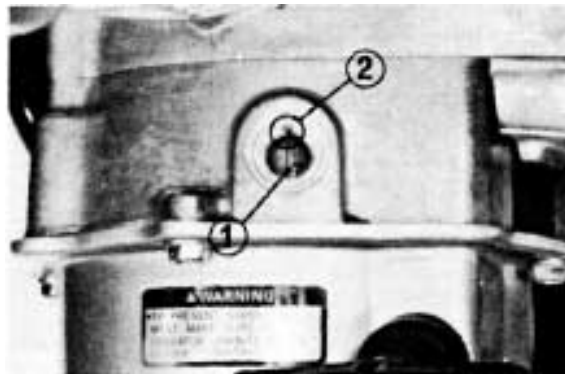

(1) T mark

(2) Index mark

4. If adjustment is necessary, loosen the adjusting screw lock nut (3) and turn the screw (4) so that there is a slight resistance when the gauge is inserted.
5. After adjustment, tighten the lock nut while holding the adjusting screw to prevent it from turning.
6. Recheck the clearance to make sure that it has not changed.
7. Reinstall the timing mark cover and valve adjusting caps.

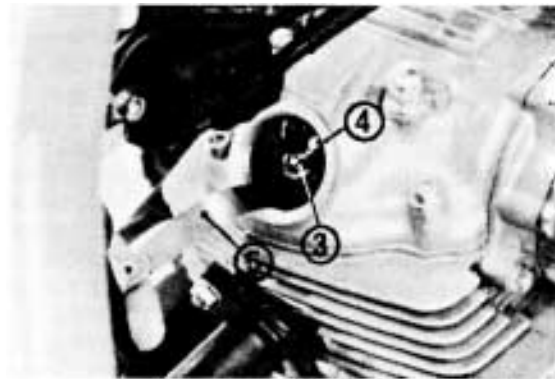

- (3) Lock nut (5) Feeler gauge
(4) Adjusting screw

CLUTCH

1. Make sure the ignition switch is OFF.
2. Loosen the lock nut (1), and turn the clutch adjuster (2) counterclockwise until you feel resistance. Then turn 1/4 turn clockwise, and tighten the lock nut to hold the adjuster in this position.
3. After adjustment, start the engine and test ride the ATC185S to be certain that the clutch is operating properly.

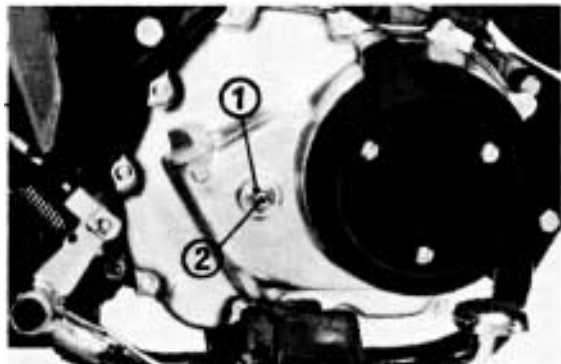

(1) Lock nut (2) Clutch adjuster

BRAKES

Front Brake Lever

Measure the distance the brake lever moves before the brake starts to take hold.

Free play, measured at the tip of the front brake lever (1), should be within 15–20 mm (5/8–3/4 in.).

If adjustment is necessary, turn the adjusting nut.

NOTE:

- * Make sure the cut-out on the adjusting nut (2) is seated on the brake arm pin (6).

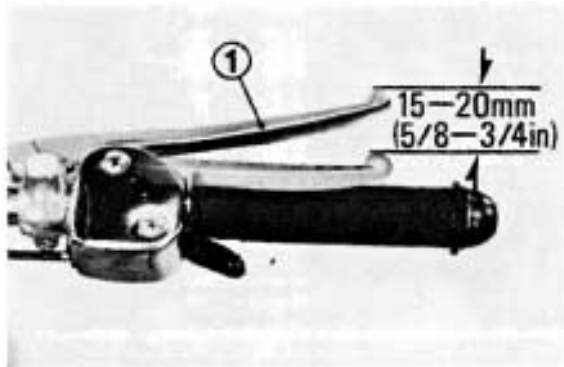

(1) Front brake lever

Other Checks:

Check the brake cable for kinks or signs of wear that could cause sticking or failure. Lubricate the brake cable with a commercially available cable lubricant to prevent premature wear and corrosion.

Make sure the brake arm, spring, and fasteners are in good condition.

Wear Indicator:

When the brake is applied, an arrow (3), attached to the brake arm (4), moves toward a reference mark (5) on the brake panel.

If the arrow aligns with the reference mark on full application of the brake, the brake shoes must be replaced.

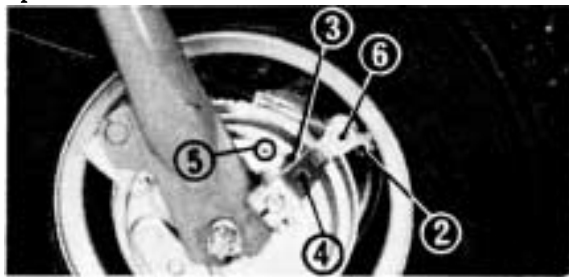

(2) Front brake adjusting nut (3) Arrow
(4) Brake arm (5) Reference mark
(6) Brake arm pin

Rear Brake Pedal

Measure the distance the rear brake pedal moves before the brake starts to take hold.

Free play, measured at the end of the pedal (1), should be 15–20 mm (5/8–3/4 in.).

Adjust by turning the adjusting nut (2) located on the brake operating rod at the rear of the frame.

NOTE:

* Make sure the cut-out on the adjusting nut is seated on the brake arm pin.

Other Checks:

Check the brake cable for kinks or signs of wear that could cause sticking or failure. Lubricate the brake cable with a commercially available cable lubricant to prevent premature wear and corrosion.

Make sure the brake arm, spring, and fasteners are in good condition.

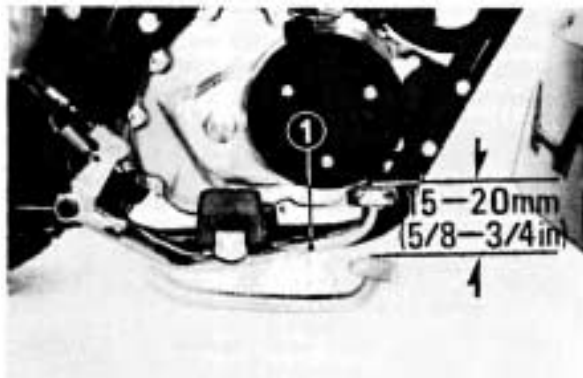

(1) Rear brake pedal

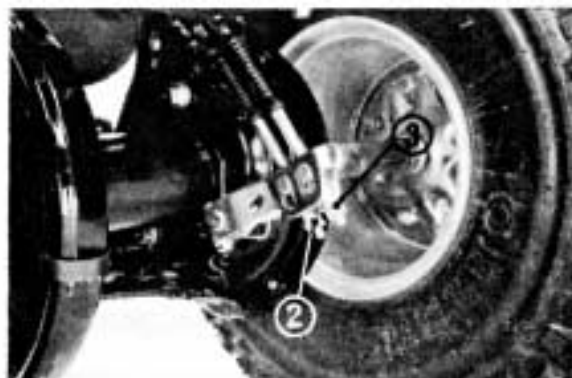

(2) Brake pedal adjusting nut
(3) Brake lever adjusting nut

Rear Brake Lever/Parking Brake

Measure the distance the rear brake lever moves before the brake starts to take hold.

Free play, measured at the tip of the brake lever (4), should be within 15–20 mm (5/8–3/4 in.). Adjusting nut (3) is located on the brake operating rod at the rear of the frame.

Other Checks:

Check the brake cable for kinks or signs of wear that could cause sticking or failure. Lubricate the brake cable with a commercially available cable lubricant to

prevent wear and corrosion. Make sure the brake arm, spring, and fasteners are in good condition.

Wear Indicator:

When the brake is applied, an arrow (5), attached to the brake arm (6), moves toward a reference mark (7) on the brake panel.

If the arrow aligns with the reference mark on full application of the brake, the brake shoes must be replaced.

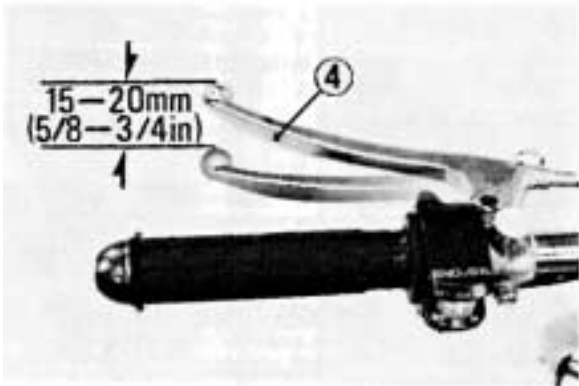

(4) Rear brake lever

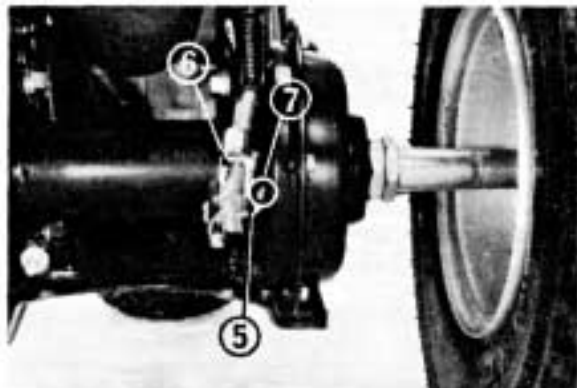

(5) Arrow

(6) Brake arm

(7) Reference mark

THROTTLE CABLE

Inspect throttle cable condition and operation. The cable must not bind or impair smooth operation of the throttle lever in any steering position. Replace the cable if it has become worn or kinked. Lubricate the cable with a commercially available cable lubricant to prevent premature wear and corrosion. Free play, measured at the tip of the throttle lever (1), should be maintained at 5–10 mm (3/16–3/8 in.).

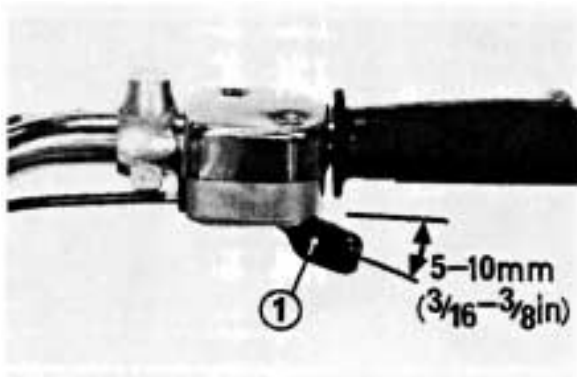

(1) Throttle lever

The cable adjuster (3) is located on top of the carburetor. Slide the rubber sleeve (2) back to expose the throttle cable adjuster (3). Turn the adjuster to obtain the correct free play. Reinstall the sleeve after adjustment.



- (2) Rubber sleeve (3) Cable adjuster
(A) Increase free play
(B) Decrease free play

DRIVE CHAIN

The drive chain (1) will wear with use and requires periodic adjustment in accordance with the maintenance schedule.

Shut the engine off. Remove the inspection cap (2). Chain slack should be checked by measuring the amount of chain slack through the inspection hole. The amount of slack should be 10–20 mm (3/8–3/4 in.). To adjust slack, loosen the rear wheel hub fixing bolts (3). Turn the adjusting nut (4) to decrease or increase chain slack. Retighten the rear wheel hub fixing bolts and reinstall the cap.

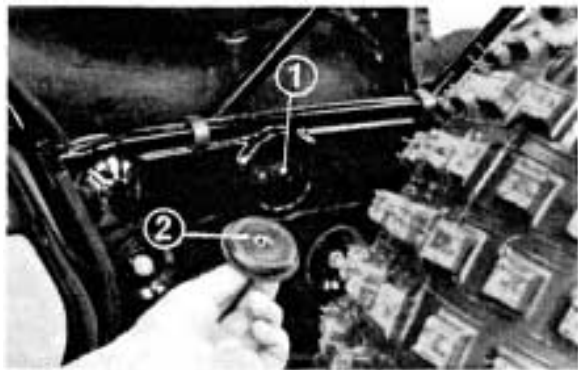

(1) Drive chain

(2) Inspection cap

Lubrication:

The drive chain can be lubricated through the inspection hole.

This hole is capped to prevent dirt from entering the chain case. Be sure to reinstall the cap after lubrication.

Commercially prepared drive chain lubricants should be used in preference to motor oil for lubricating the drive chain.

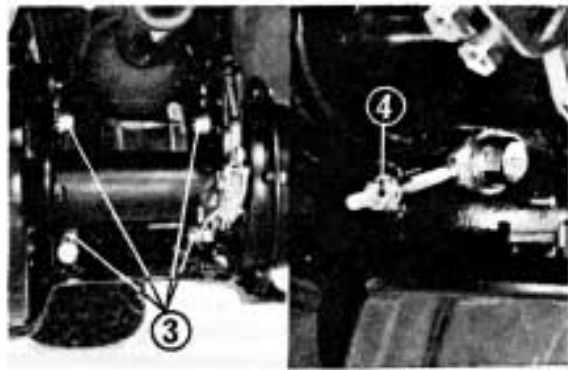

(3) Fixing bolts

(4) Adjusting nut

CAM CHAIN

1. Start the engine and let it idle.
2. Remove the rubber cap (1) and loosen the tensioner adjusting bolt (2).

When it is loosened, the cam chain tensioner will automatically position itself to provide the correct cam chain tension.

3. Retighten the tensioner adjusting bolt and install the rubber cap.

NOTE:

- * Do not attempt to loosen the 6mm bolt while adjusting.



(1) Rubber cap

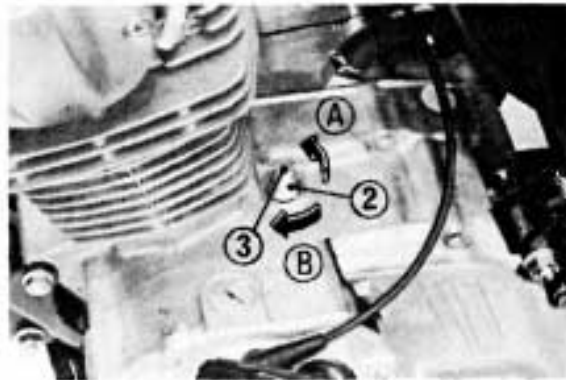

(2) Tensioner adjusting bolt (3) 6mm bolt
(A) Loosen while adjusting
(B) Tighten

SPARK ARRESTER

The exhaust system must be periodically purged of accumulated carbon.

WARNING

- * *The exhaust system becomes VERY HOT even after short periods of engine operation.*
- * *To avoid fire hazards, DO NOT perform this maintenance in the vicinity of flammable materials.*

1. Remove the spark arrester bolts (1) and slide the arrester (2) out.
2. Clean the arrester of accumulated carbon.
3. Start the engine, and purge accumulated carbon from the system by momentarily revving up the engine several times.
4. Stop the engine and allow the exhaust pipe to cool.
5. Reinstall the spark arrester with the bolts.



(1) Spark arrester bolts (2) Spark arrester

STORAGE

Preparing the machine for storage:

1. Completely clean all parts of the machine. If the machine has been exposed to sea air or salt water, wash it down with fresh water and wipe dry.
2. Drain the fuel tank and the carburetor.

WARNING

- * *Gasoline is flammable and is explosive under certain conditions. Do not smoke or allow flames or sparks near the equipment while draining fuel.*

Place the carburetor drain tube (1) in a suitable container.

Open the fuel drain by turning the drain screw (2) counterclockwise.

Turn the fuel valve to RES and the fuel tank cap lever to ON .

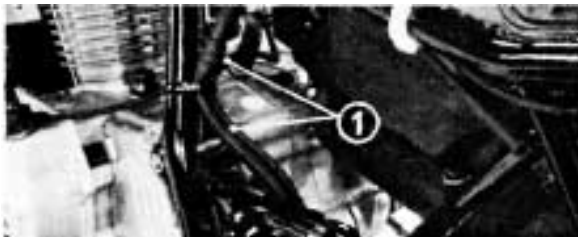

(1) Carburetor drain tube

3. Change the engine oil. (See page 32.)
4. Position the piston at the top of the compression stroke by pulling the starter rope until compression is felt.
5. Inflate the tires to the normal pressure and place the ATC on blocks to raise the tires off the ground.
6. Cover the machine and store in a place which is free of humidity and dust.

NOTE:

- * Be sure to close the fuel drain before refueling when the ATC is taken out of storage.

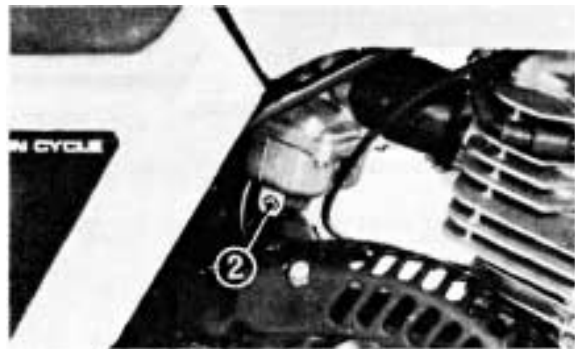

(2) Carburetor drain screw

TRANSPORTING

1. Place the carburetor drain tube in a suitable container.
2. Turn the fuel cap lever and fuel valve OFF.
3. Turn the drain screw counterclockwise to drain the gasoline from the carburetor.

* If wheel removal is required when transporting, follow the procedures on following pages.

WARNING

** Never incline the machine with the front wheel up, or rest it on its side without draining the fuel. Fuel vapor or spilled fuel may ignite.*

4. After draining, turn the drain screw clockwise.

NOTE:

- * Be sure the fuel drain is closed (screw turned clockwise) before refueling the ATC.
- * It is unnecessary to drain the engine oil from the crankcase, as no appreciable oil leakage will occur when the ATC is rested on its side.

Front Wheel Removal

1. Place a support block under the engine to raise the front wheel off the ground.
2. Remove the front brake adjusting nut (1) and disconnect the front brake cable.
3. Remove the cotter pins (2) securing both front axle nuts. Remove the axle nuts (3).
4. Remove the axle collars (4) and front wheel.
5. Remove the wheel spacer on the left side of the wheel.
6. Remove the front brake panel (5) and withdraw the front axle (6) from the right side.

NOTE:

- * Cover the wheel hub as soon as the axle has been removed to prevent entry of dirt.

Installation Note:

- Reinstall the front wheel by reversing the disassembly sequence.

CAUTION:

- * *When the front axle is reinstalled, be careful that the grease seal is not cut or damaged.*
- * *Always replace used cotter pins with new ones. To reduce the hazard of snagging the ends of the cotter pins, while the ATC is operated, we recommend that the projecting ends of the front axle cotter pins be cut close to the axle nuts.*

WARNING

- * *Be certain that the axle nuts are tightened and secured by cotter pins. If they are not, the wheels may come loose during operation.*



(1) Adjusting nut
(2) Cotter pin

(3) Axle nut

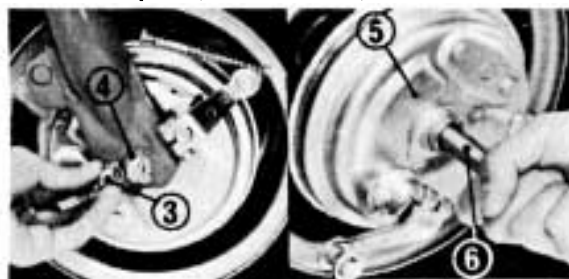

(4) Axle collar
(5) Brake panel

(6) Front axle

Rear Wheel Removal

1. Place a support block under the vehicle and raise the rear wheel off the ground.
2. Loosen the wheel nuts (1) with the 12 mm socket wrench.
3. Remove the wheel.

Installation Note:

- Reinstall the rear wheels by reversing the disassembly sequence.
- Tighten the wheel nuts in a cross-pattern.

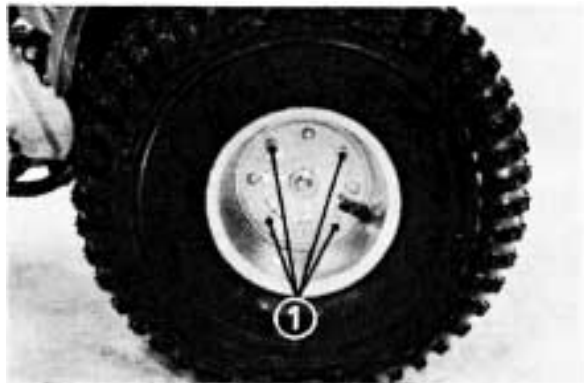

(1) Wheel nuts



OPTIONAL PARTS

Front Carrier

Max. load 10 kg (22 lbs.)



Rear Carrier

Max. load 30 kg (66 lbs.)

Trailer Hitch

Max. drawbar

pull

90 kg (200 lbs.)

Weight on

hitch point

9 kg (20 lbs.)

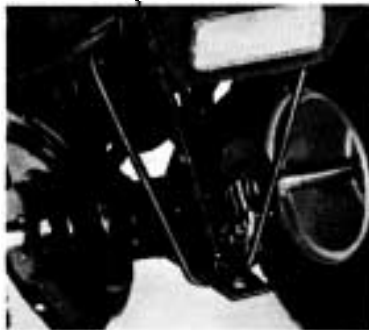

Air pressure gauge

CAUTION

- * *Load cargo on the rear carrier as far forward as possible. Do not allow cargo to extend beyond the end of the rear carrier.*
- * *When towing a trailer, care should be taken to maintain balance and stability. Place cargo on the trailer so that it will not cause the front wheel to lift off the ground during travel.*
- * *To prevent an accident, use extreme care when adding or riding with accessories and cargo. Addition of accessories and cargo can reduce the ATC's stability, performance and safe operating speed. Accessories are designed for work applications and should be removed for recreational riding.*

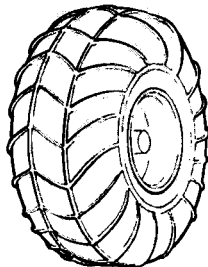

Chevron pattern tire
For soft, sandy or
swampy terrain

DC Power Kit

(Battery, regulator/rectifier, wire harness and holders)

For brighter headlight when the engine is idle and for accessories

For installation and removal of these accessories see the accessory instruction booklet.

Wire Harness



Battery and Holder
12V 5AH (12N5-4B)

Regulator/Rectifier
12V 20A



Wire Harness

SPECIFICATIONS

DIMENSIONS

Overall length	1,720 mm (67.7 in)
Overall width	1,000 mm (39.4 in)
Overall height	965 mm (38.0 in)
Wheel base	1,118 mm (44.0 in)

WEIGHT

Dry weight	125.5 kg (276.5 lbs)
------------------	----------------------

CAPACITIES

Engine oil	1.3 liter (1.4 US qt)
	(at draining)
Fuel tank	8.8 liter (2.3 US gal)
Fuel reserve capacity	1.6 liter (0.42 US gal)
Passenger capacity	Operator only

ENGINE

Bore and stroke	63 x 57.8 mm
	(2.48 x 2.28 in)
Compression ratio	8.0 : 1
Displacement	180.2 cc (11.0 cu-in)
Spark plug gap	0.6–0.7 mm
	(0.024–0.028 in)
Valve clearance	0.05 mm (0.002 in)

CHASSIS AND SUSPENSION

Caster angle	70°20'
Trail length	20mm (0.8 in)
Tire size, front and rear	22 x 11.0–8 ATV tire

POWER TRANSMISSION

Primary reduction	3.333
Final reduction	3.727
Gear ratio, 1st	2.769
2nd	1.722
3rd	1.273
4th	1.000
5th	0.815

WIRING DIAGRAM

IGNITION SWITCH CONTINUITY

	IG	E
OFF	○	○
ON		
COLOR	Bk	G

DC POWER KIT (OPTIONAL)

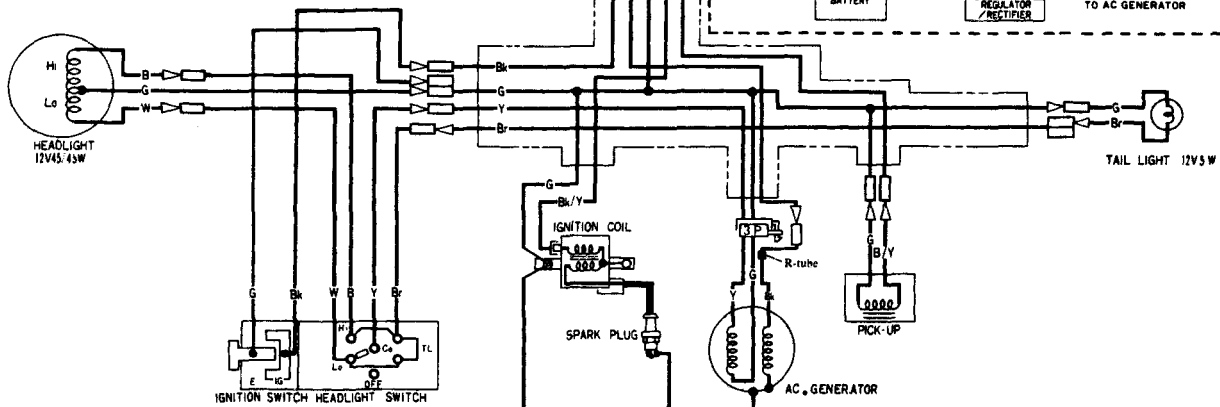
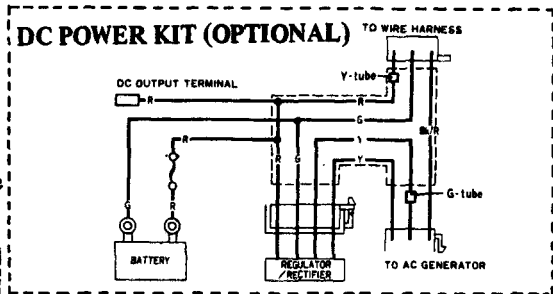

HEADLIGHT SWITCH CONTINUITY

	HL - L	Co	TL	HL - H
OFF				
Lo	○	○	○	
Hl		○	○	○
COLOR	W	Y	Br	B

- Bk ... Black
- W ... White
- LG ... Light Green
- R ... Red
- G ... Green
- Y ... Yellow
- B ... Blue
- Gr ... Grey
- LB ... Light Blue
- O ... Orange
- P ... Pink

3195802
PRINTED IN USA