

Official

HONDA

SHOP MANUAL

ATC70

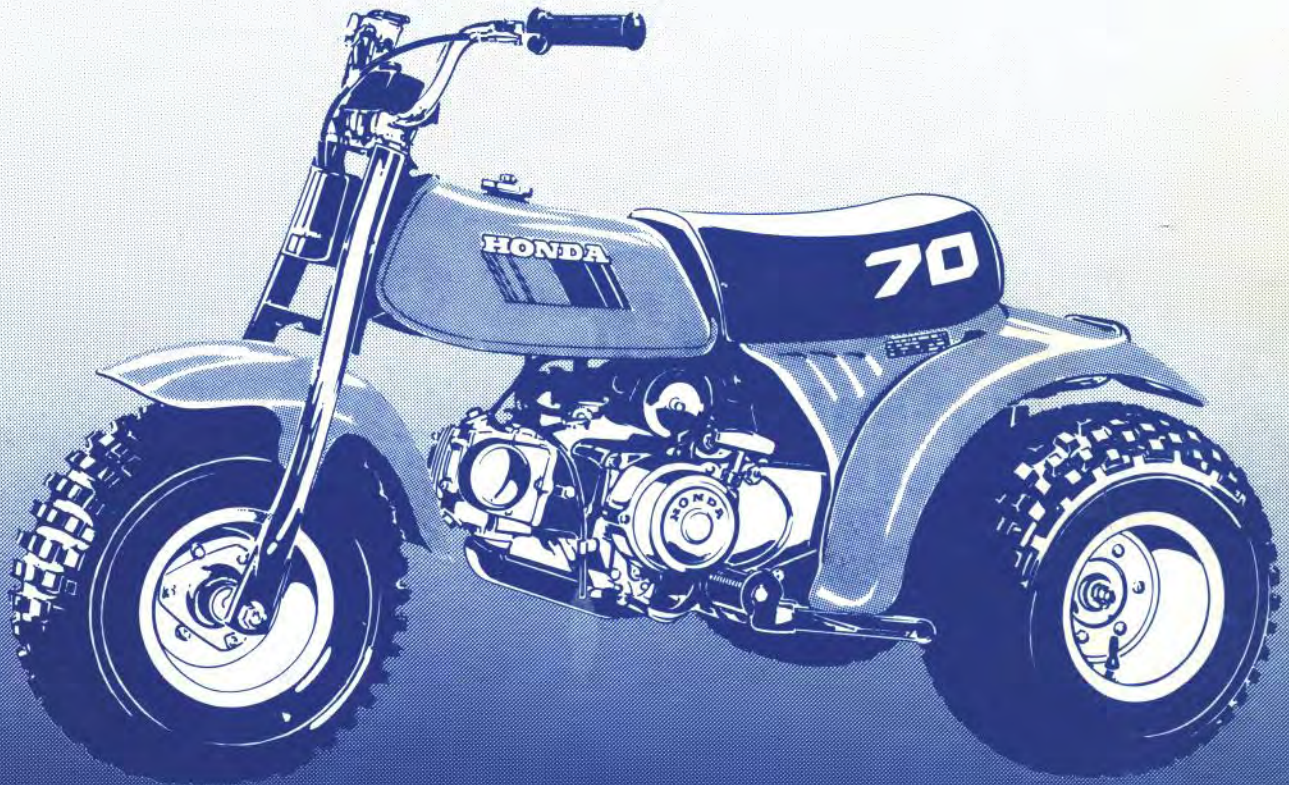

'85

IMPORTANT SAFETY NOTICE



WARNING *Indicates a strong possibility of severe personal injury or loss of life if instructions are not followed.*

CAUTION: *Indicates a possibility of personal injury or equipment damage if instructions are not followed.*

NOTE: Gives helpful information.

Detailed descriptions of standard workshop procedures, safety principles and service operations are not included. It is important to note that this manual contains some warnings and cautions against some specific service methods which could cause **PERSONAL INJURY** to service personnel or could damage a vehicle or render it unsafe. Please understand that those warnings could not cover and conceivable ways in which service, whether or not recommended by Honda, might be done or of the possible hazardous consequences of each conceivable way, nor could Honda investigate all such ways. Anyone using service procedures or tools, whether or not recommended by Honda *must safety himself thoroughly* that neither personal safety nor vehicle safety will be jeopardized by the service methods or tools selected.



HOW TO USE THIS MANUAL

Sections 1 through 3 apply to the whole ATC, while sections 4 through 13 describe parts of the ATC, grouped according to location.

Find the section you want on this page, then turn to the table of contents on page 1 of that section.

Most sections start with an assembly or system illustration and all the required specifications, torque values, general instructions, tools and troubleshooting for the section. The subsequent pages give detailed procedures.

If you don't know the source of the trouble, see section 14, TROUBLESHOOTING.

All information, illustrations, directions and specifications incl

All information, illustrations, directions and specifications included in this publication are based on the latest product information available at the time of approval for printing. Honda Motor Co., Ltd. reserves the right to make changes a any time without notice and without incurring any obligation whatever. No part of this publication may be reproduced without written permission.

HONDA MOTOR CO., LTD.
SERVICE PUBLICATIONS OFFICE

CONTENTS

	GENERAL INFORMATION	1
	LUBRICATION	2
	MAINTENANCE	3
ENGINE	FUEL SYSTEM	4
	ENGINE REMOVAL/INSTALLATION	5
	CYLINDER HEAD/VALVES	6
	CYLINDER/PISTON	7
	CLUTCH	8
	RECOIL STARTER/ALTERNATOR/ CAM CHAIN TENSIONER	9
	TRANSMISSION/CRANKSHAFT	10
CHASSIS	FRONT WHEEL/SPRING	11
	REAR WHEEL/BRAKE/DRIVE MECHANISM	12
	ELECTRICAL	13
	TRUBLESHOOTING	14

1

2

3

4

5

6

7



GENERAL SAFETY	1-1
SERVICE RULES	1-1
MODEL IDENTIFICATION	1-2
SPECIFICATIONS	1-3
TORQUE VALUES	1-5
TOOLS	1-6
CABLE & HARNESS ROUTING	1-7
NOISE EMISSION CONTROL SYSTEM	1-10

GENERAL SAFETY

WARNING

If the engine must be running to do some work, make sure the area is well-ventilated. Never run the engine in a closed area. The exhaust contains poisonous carbon monoxide gas.

WARNING

Gasoline is extremely flammable and is explosive under certain conditions. Do not smoke or allow flames or sparks in your work area.

SERVICE RULES

1. Use genuine HONDA or HONDA-recommended parts and lubricants or their equivalent. Parts that don't meet HONDA's design specifications may damage the ATC.
2. Use the special tools designed for this product to avoid damage and incorrect assembly.
3. Use only metric tools when servicing this ATC. Metric bolts, nuts, and screws are not interchangeable with English fasteners.
4. Install new gaskets, O-rings, cotter pins, and lock plates when reassembling.
5. When tightening bolts or nuts, begin with the larger-diameter or inner bolt first. Then tighten to the specified torque diagonally in 2-3 steps, unless a particular sequence is specified.
6. Clean parts in non-flammable or high flash point solvent upon disassembly.
7. Lubricate any sliding surfaces before reassembly.
8. After reassembly, check all parts for proper installation and operation.



GENERAL INFORMATION

MODEL IDENTIFICATION

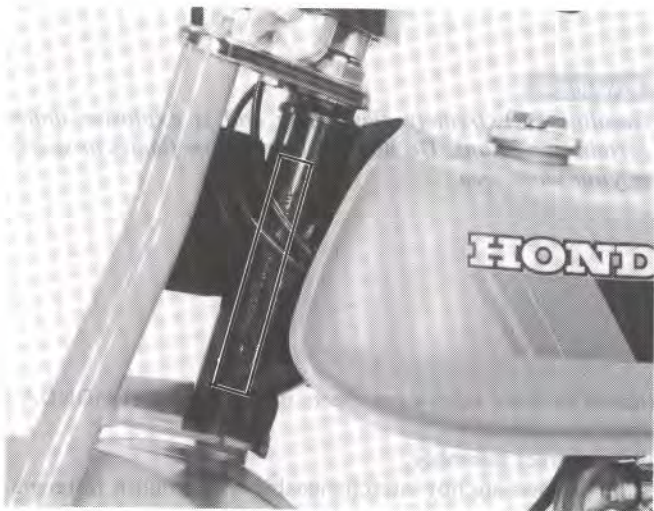

The frame serial number is stamped on the steering head left side.

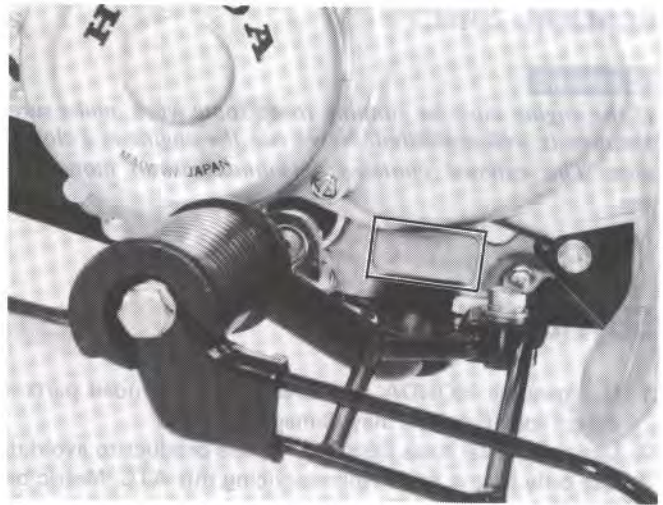

The engine serial number is stamped on the crankcase lower left side.

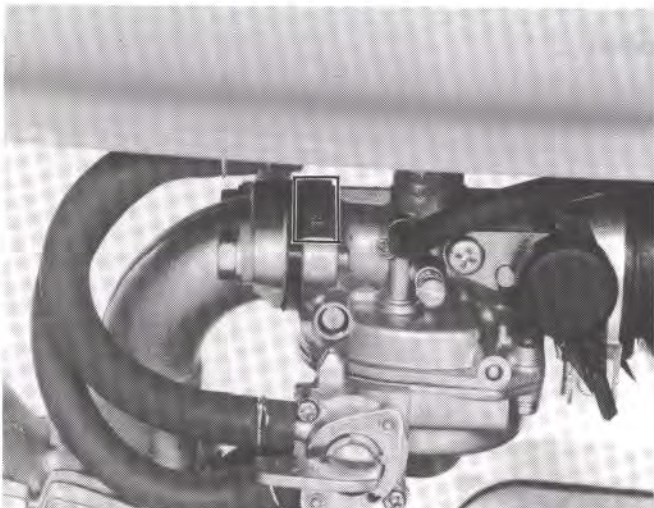

The carburetor identification number is stamped on the carburetor body left side.



SPECIFICATIONS

Item		Specifications
DIMENSIONS	Overall length	1,300 mm (51.2 in)
	Overall width	800 mm (31.5 in)
	Overall height	800 mm (31.5 in)
	Wheelbase	895 mm (33.2 in)
	Rear tread	610 mm (24.1 in)
	Seat height	570 mm (22.4 in)
	Foot peg height	180 mm (7.1 in)
	Ground clearance	85 mm (3.3 in)
	Dry weight	77 kg (169.8 lb)
	FRAME	Type
Rim size		6.5 spw x 7DT
		6.5 spw x 7DT
Front tire size/pressure		16 x 8.0-7/2.2 psi (0.15 kg/cm ² , 15 kPa)
Rear tire size/pressure		16 x 8.0-7/2.2 psi (0.15 kg/cm ² , 15 kPa)
Rear brake		Internal expanding shoe
Fuel capacity		4.3 liters (1.1 US gal, 0.96 Imp gal)
Fuel reserve capacity		0.8 liters (0.2 US gal, 0.17 Imp gal)
Caster angle		20°
Trail length		32 mm (1.26 in)
ENGINE	Type	Gasoline, air-cooled 4-stroke
	Cylinder arrangement	Single cylinder, 80° inclined from vertical
	Bore x stroke	47.0 x 41.4 mm (1.850 x 1.630 in)
	Displacement	72 cc (4.4 cu in)
	Compression ratio	7.5 : 1
	Valve train	Overhead camshaft chain driven
	Maximum horse power	3.6 BHP/6,500 rpm
	Maximum torque	0.42 kg-m/5,000 rpm (3.04 ft-lb/5,500 rpm)
	Oil capacity	0.7 liters (0.4 US qt, 0.62 Imp qt) at draining
	Cylinder compression	12.0 kg/cm ² (170.64 psi)
	Lubrication system	Forced pressure and wet sump
	Intake valve	OPENS CLOSSES
	Exhaust valve	OPENS CLOSSES
	Valve clearance (Cold)	Intake Exhaust
	Idle speed	1,500 rpm
CARBURETOR	Type/Identification mark	Piston valve/PB-38A
	Main jet No.	# 58
	Slow jet No.	# 38
	Pilot screw opening	1-3/4 turns out
	Float level	10.7 mm (0.42 in)



GENERAL INFORMATION

Item		Specifications	
DRAIN TRAIN	Clutch	Wet multi-plate centrifugal type	
	Transmission	4-speed constant-mesh, semi automatic	
	Primary reduction	4.058	
	Gear ratio I	3.273	
	Gear ratio II	1.938	
	Gear ratio III	1.350	
	Gear ratio IV	1.043	
Final reduction	2.769, drive sprocket 13T, driven sprocket 36T		
ELECTRICAL	Ignition system	Flywheel magnet	
	Starting system	Recoil starter	
	Alternator	AC generator	
	Spark plug	ND	NGK
		U22FSR-L	CR7HS
		U20FSR-L	CR6HS
		U24FSR-L	CR8HS
	Spark plug gap	0.6-0.7 mm (0.024-0.028 in)	
	Point gap	0.3-0.4 mm (0.012-0.016 in)	

**TORQUE VALUES****ENGINE**

Item	Q'ty	Thread-dia. (mm)	TORQUE: N·m (kg·m, ft·lb)
Valve inspection cap	2	—	10–14 (1.0–1.4, 7–10)
Cylinder head nut	4	6	9–12 (0.9–1.2, 6.5–8.7)
Camshaft sprocket bolt	2	5	5–9 (0.5–0.9, 3.6–6.5)
Cam chain guide roller bolt	1	6	7–13 (0.7–1.3, 5.1–9.4)
Clutch lock nut	1	14	38–45 (3.8–4.5, 27.5–32.5)
Flywheel nut	1	10	30–38 (3.0–3.8, 21.7–27.5)
Shift drum bolt	1	6	9–15 (0.9–1.5, 6.5–10.8)

FRAME

Item	Q'ty	Thread dia. (mm)	TORQUE: N·m (kg·m, ft·lb)
Handlebar upper holder bolt	4	8	19–25 (1.9–2.5, 14–18)
Steering stem nut	1	22	50–70 (5.0–7.0, 36–51)
Bearing adjustment nut	1	22	25–35 (2.5–3.5, 18–25)
final	1	22	6–7 (0.6–0.7, 4–5)
Fork bridge bolt	2	10	40–48 (4.0–4.8, 29–35)
Handlebar lower holder nut	2	10	40–48 (4.0–4.8, 29–35)
Front wheel hub nut	3	8	19–25 (1.9–2.5, 14–18)
Front axle nut	1	14	60–80 (6.0–8.0, 43–58)
Drive chain tensioner nut	2	10	25–33 (2.5–3.3, 18–24)
Rear axle nut	2	14	60–80 (6.0–8.0, 43–58)
Rear wheel hub nut	6	8	19–25 (1.9–2.5, 14–18)
Brake cam holder bolt	2	6	7–12 (0.7–1.2, 5–9)
Brake anchor pin bolt	2	6	7–12 (0.7–1.2, 5–9)
Gearshift pedal bolt	1	6	7–12 (0.7–1.2, 5–9)
Rear fender bolt	2	8	15–21 (1.5–2.1, 11–15)
Seat bolt	2	6	6–9 (0.6–0.9, 4–7)
Rear fender bracket bolt	4	6	6–9 (0.6–0.9, 4–7)
Foot peg guard bolt A	2	8	19–25 (1.9–2.5, 14–18)
Foot peg guard bolt B	2	10	40–48 (4.0–4.8, 29–35)
Foot peg bolt	4	8	19–25 (1.9–2.5, 14–18)
Engine hanger bolt	2	8	19–25 (1.9–2.5, 14–18)

Torque specifications listed above are for the most important tightening points. If a torque specification is not listed, use the standards given below.

STANDARD TORQUE VALUES

Item	TORQUE N·m (kg·m, ft·lb)	Item	TORQUE N·m (kg·m, ft·lb)
5 mm bolt, nut	4.5–6 (0.45–0.6, 3.3–4.3)	5 mm screw	3.5–5 (0.35–0.5, 2.5–3.6)
6 mm bolt, nut	8–12 (0.8–1.2, 5.8–8.7)	6 mm screw and 6 mm bolt with 8 mm head	7–11 (0.7–1.1, 5–8)
8 mm bolt, nut	18–25 (1.8–2.5, 13–18)	6 mm flange bolt, nut	10–14 (1.0–1.4, 7.2–10)
10 mm bolt, nut	30–40 (3.0–4.0, 22–29)	8 mm flange bolt, nut	24–30 (2.4–3.0, 17–22)
12 mm bolt, nut	50–60 (5.0–6.0, 36–43)	10 mm flange bolt, nut	30–40 (3.0–4.0, 22–29)

**GENERAL INFORMATION****TOOLS****SPECIAL**

TOOL NAME	TOOL NUMBER	ALTERNATIVE TOOL	REF. PAGE
Valve adjusting wrench, 8 x 9 mm	07908-GE20200	Equivalent commercially available in U.S.A. M9360-277-91774 (U.S.A. only)	3-7
Ball race remover	07944-1150001		11-13
Steering stem driver	07946-GC40000		11-14
Valve guide reamer	07984-0980000		3-7
Universal bead remover	GN-AH-958-BB1	U.S.A. only	11-8

COMMON

TOOL NAME	TOOL NUMBER	ALTERNATIVE TOOL	REF. PAGE
Float level gauge	07401-0010000		4-8
Valve adjusting wrench B	07708-0030400	089201-200-000 (U.S.A. only) 07916-3710000 or Equivalent commercially available in U.S.A.	3-7
Lock nut wrench, 20 x 24 mm	07716-0020100		8-4, 8-10
Lock nut wrench, 26 x 30 mm	07716-0020203	Equivalent commercially available in U.S.A.	11-13, 11-15
Lock nut wrench, 30 x 32 mm	07716-0020400		11-12, 11-16
Extension bar	07716-0020500		
Universal holder	07725-0030000		8-4, 8-10, 9-8
Flywheel puller	07733-0010000	07933-0010000	9-8
Attachment 32 x 35 mm	07746-0010100		11-7
Pilot 15 mm	07746-0040300		11-7
Attachment 37 x 40 mm	07746-0010200		10-8, 11-14
Pilot 17 mm	07746-0040400		10-8
Attachment 52 x 55 mm	07746-0010400		12-10
Pilot 30 mm	07746-0040700		12-10
Driver	07749-0010000		
Bearing remover shaft	07746-0050100	Equivalent commercially available in U.S.A.	11-7
Bearing remover head 15 mm	07746-0050400		11-7
Valve spring compressor	07757-0010000	07957-3290001	6-6, 6-13
Valve guide remover 5.5 mm	07742-0010100	07942-3290100	6-8, 6-9
Driver inner	07746-0020100		10-5
Attachment 17 mm	07746-0020300		10-5
Attachment 20 mm	07746-0020400		10-5

VALVE SEAT CUTTERS

TOOL NAME	TOOL NUMBER	ALTERNATIVE TOOL	REF. PAGE
Valve seat cutter 24 mm (45 IN)	07780-0010600	Not available in U.S.A.	6-11
Valve seat cutter 22 mm (45 EX)	07780-0010701	Equivalent commercially available in U.S.A.	6-11
Valve seat cutter 25 mm (32 IN)	07780-0012000		6-11
Valve seat cutter 22 mm (32 EX)	07780-0012601		6-11
Valve seat cutter 22 mm (60 IN/EX)	07780-0014202		6-11
Valve seat cutter holder	07780-0010101		6-11



CABLE & HARNESS ROUTING

Note the following when routing cables and wire harnesses:

- A loose wire, harness or cable can be a safety hazard. After clamping, check each wire to be sure it is secure.
- Do not squeeze wires against the weld or end of its clamp when a weld-on clamp is used.
- Secure wires and wire harnesses to the frame with their respective wire bands at the designated locations. Tighten the bands so that only the insulated surfaces contact the wires or wire harnesses.
- Route harnesses so they are not pulled taut or have excessive slack.
- Protect wires and harnesses with electrical tape or tubes if they are in contact with a sharp edge or corner. Clean the attaching surface thoroughly before applying tape.
- Do not use a wire or harness with a broken insulator. Repair by wrapping them with protective tape or replace them.
- Route wire harnesses to avoid sharp edges or corners.
- Avoid the projected ends of bolts and screws.
- Keep wire harnesses away from the exhaust pipes and other parts that get hot.
- Be sure grommets are seated in their grooves properly.
- After clamping, check each harness to be certain that it does not interfere with any moving or sliding parts.
- Wire harnesses routed along the handlebars should not be pulled taut, have excessive slack, be pinched, or interfere with adjacent or surrounding parts in all steering positions.
- After routing, check that the wire harnesses are not twisted or kinked.

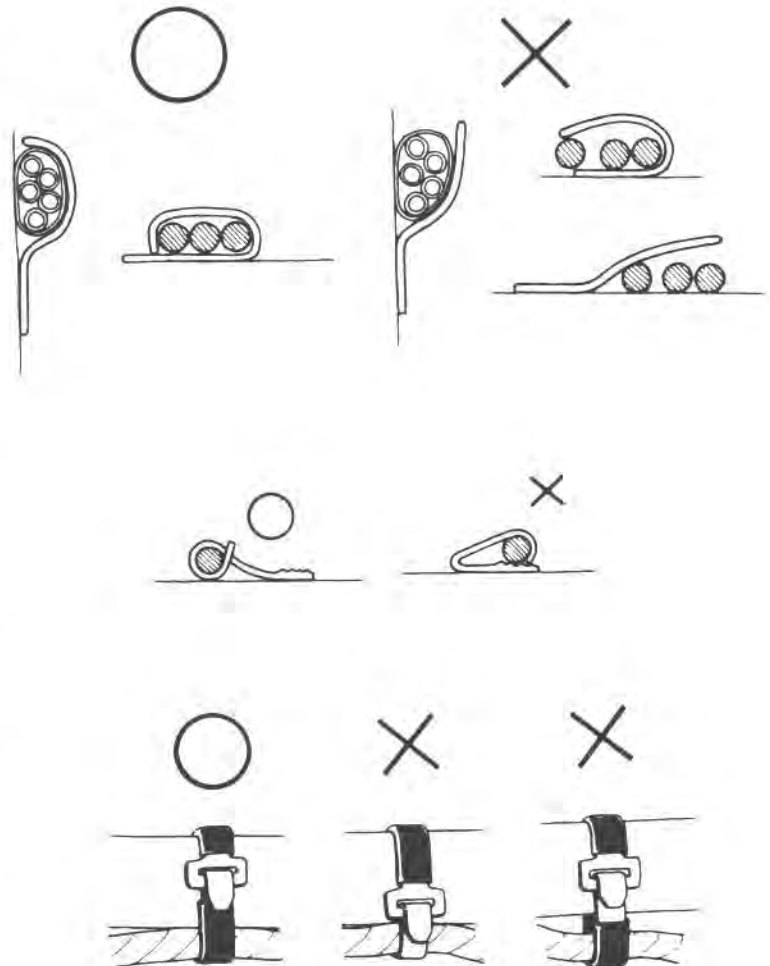

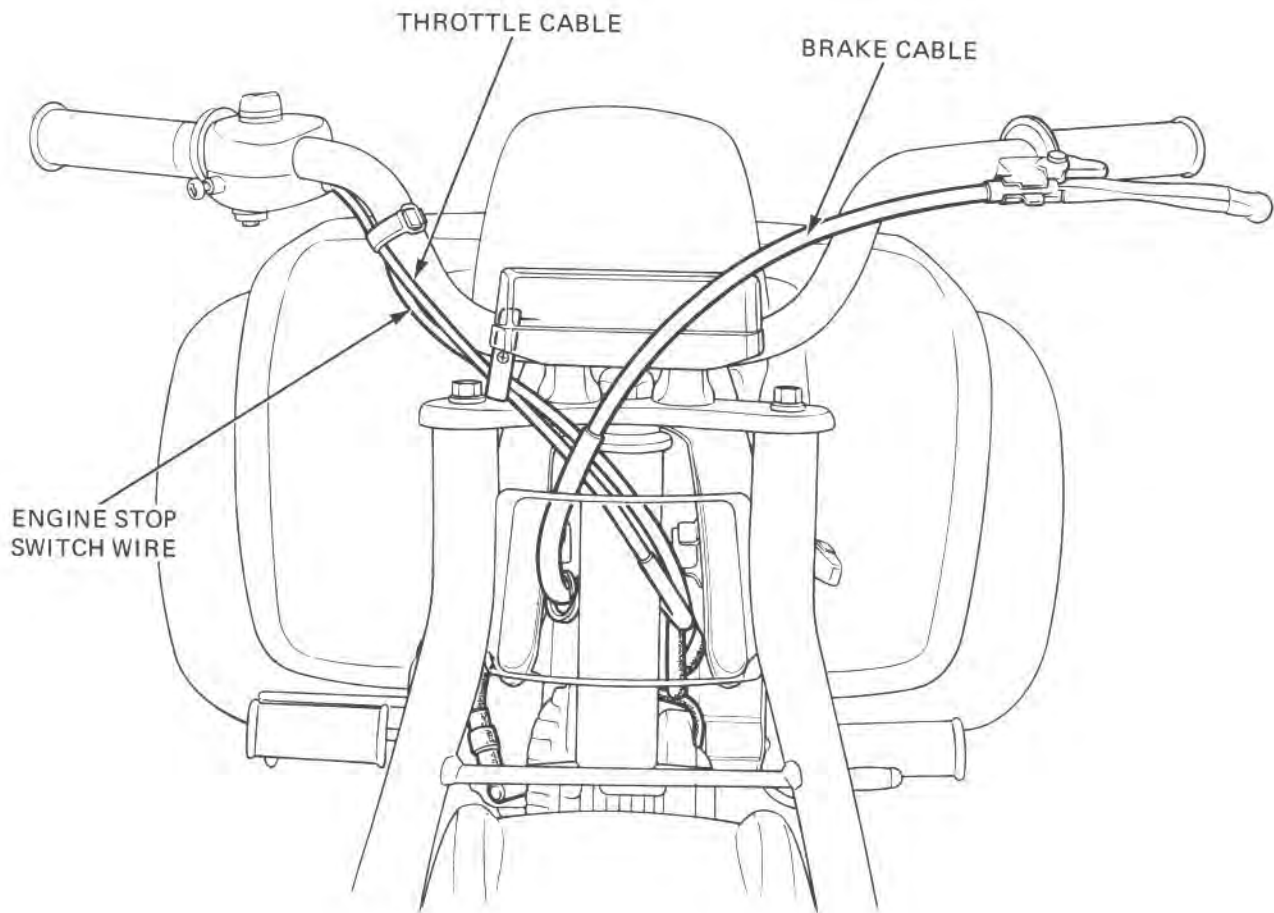

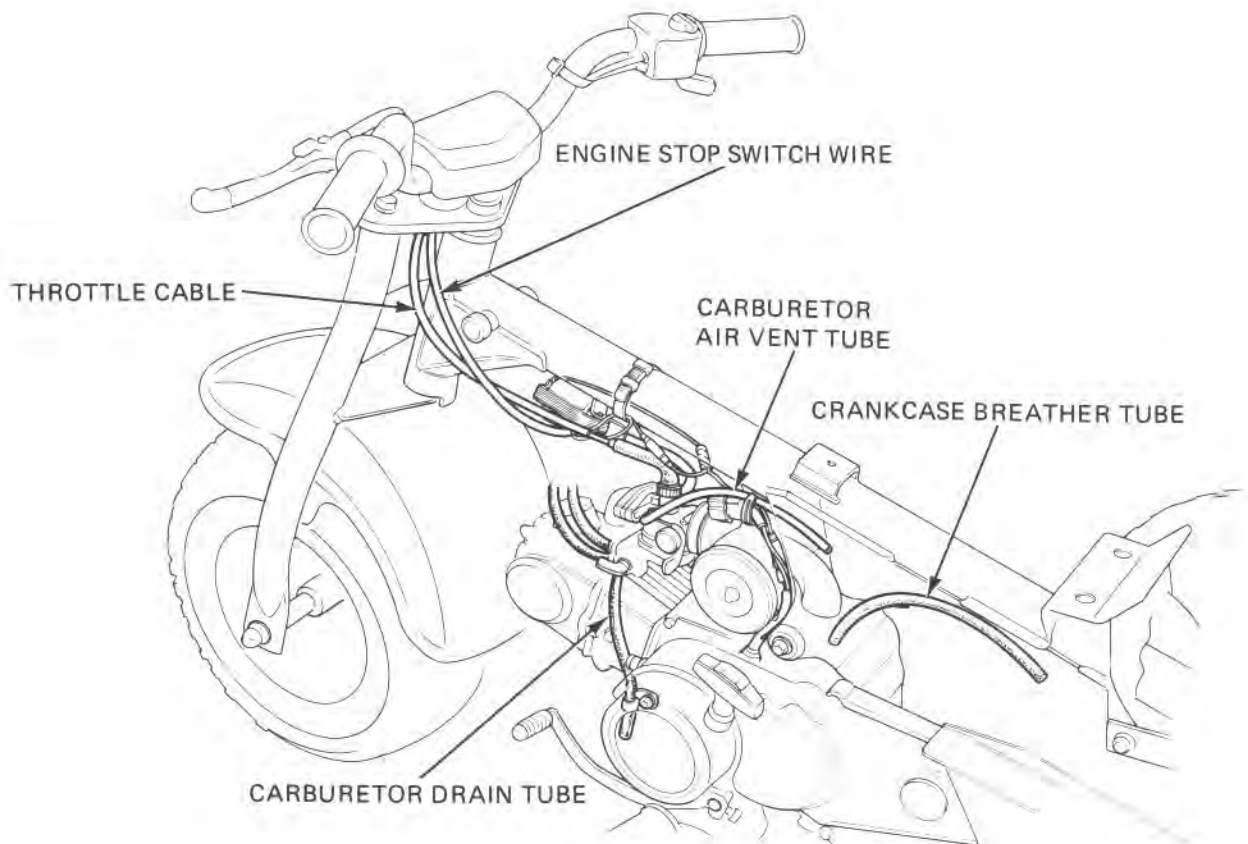
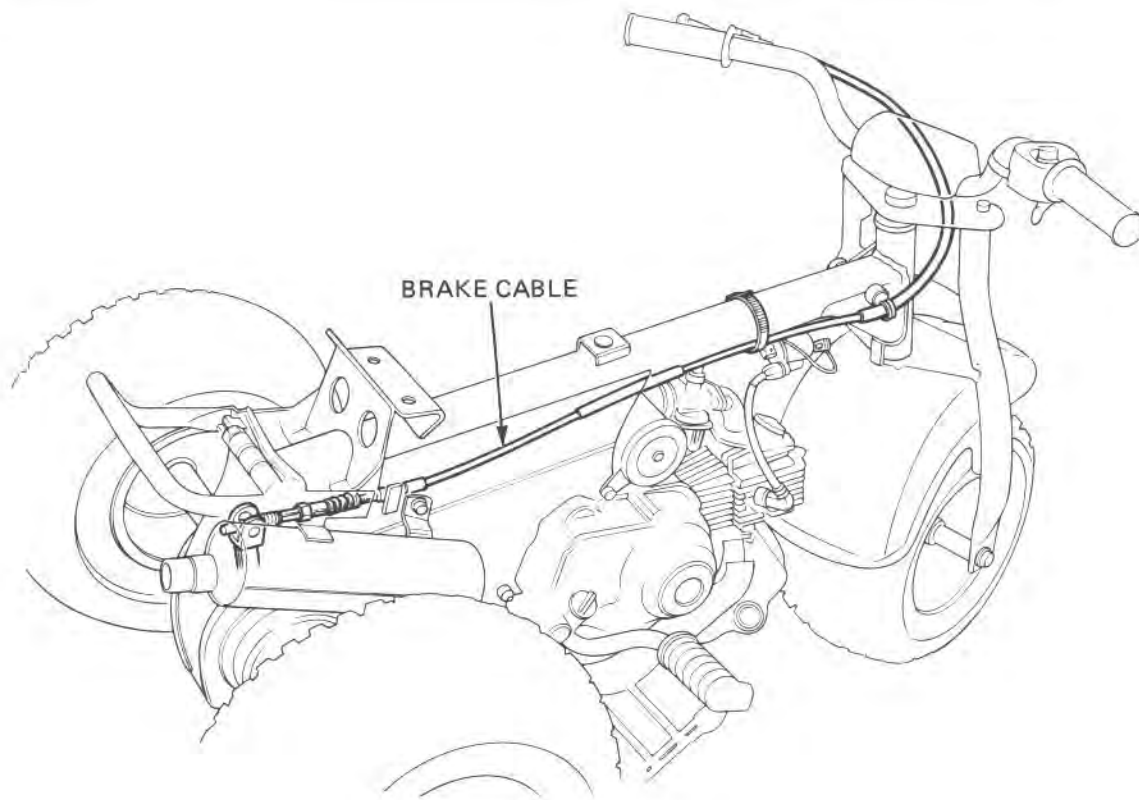



NOISE EMISSION CONTROL SYSTEM

- The U.S. Environmental Protection Agency requires manufacturers to certify that vehicles build after January 1, 1983 will comply with applicable noise emission standards for one year or 1,865 miles (3,000 km) after the time of sale to the ultimate purchaser, when operated and maintained according to the instructions provided. Compliance with the terms of the Distributor's Warranty for the Honda Vehicle Noise Emission Control System is necessary in order to keep the noise emission control system in effect.
- **TAMPERING WITH THE NOISE CONTROL SYSTEM IS PROHIBITED:** Federal law prohibits the following acts or the causing thereof: (1) The removal or rendering inoperative by any person, other than for purposes of maintenance, repair, or replacement, of any device or element of design incorporated into any new vehicle for the purpose of noise control prior to its sale or delivery to the ultimate purchaser or while it is in use; or (2) The use of the vehicle after such device or element of design has been removed or rendered inoperative by any person. **AMONG THOSE ACTS PRESUMED TO CONSTITUTE TAMPERING ARE THE ACTS LISTED BELOW:**
 1. Removal of, or puncturing the muffler, bafflers, header pipes or any other component which conducts exhaust gases.
 2. Removal of, or puncturing of any part of the intake system.
 3. Lack of proper maintenance.
 4. Replacing any moving parts of the vehicle, or parts of the exhaust or intake system, with parts other than those specified by the manufacturer.



HONDA
ATC70

MEMO





ENGINE LUBRICATION SYSTEM

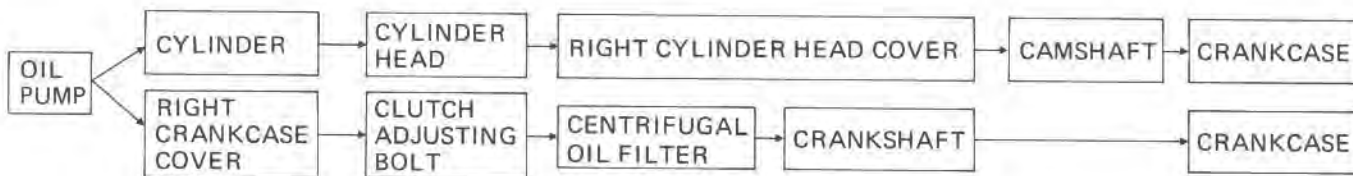
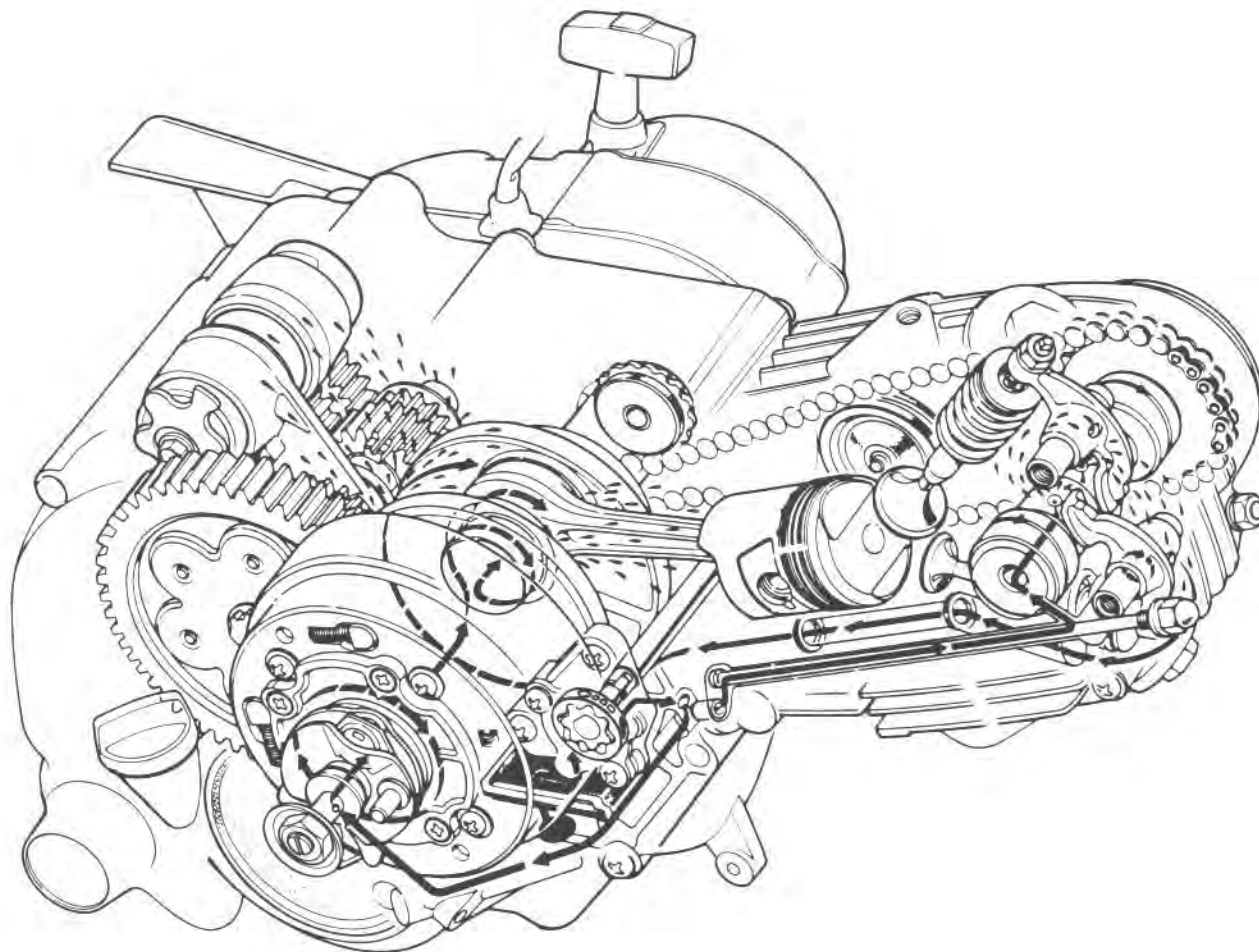



SERVICE INFORMATION	2-1
TROUBLESHOOTING	2-1
ENGINE OIL LEVEL	2-2
ENGINE OIL CHANGE	2-2
OIL FILTER ROTOR AND SCREEN	2-2
OIL PUMP	2-3
LUBRICATION POINTS	2-7

SERVICE INFORMATION

GENERAL

Oil filter screen and oil pump inspection and maintenance can be made without removing the engine.

SPECIFICATIONS

		STANDARD	SERVICE LIMIT
Engine oil capacity		Approximately 0.7 liter (0.74 US qt, 0.62 Imp. qt) at oil change 0.8 liter (0.85 US qt, 0.7 Imp. qt) at engine assembly	
Recommended oil		Honda 4 stroke oil SAE 10W-40 or equivalent API service classification: SE or SF Other viscosities may be used when the average temperature in your riding area is within the indicated range. Recommended oil viscosities <div style="text-align: center;"> <p>The chart shows temperature ranges for five oil grades: SAE 20W-50 (approx. 0 to 100°F), SAE 20W-40 (approx. 0 to 90°F), SAE 10W-40 (approx. -10 to 100°F), SAE 10W-30 (approx. -10 to 80°F), and SAE 5W (approx. -20 to 30°F).</p> </div>	
Oil pump	Tip clearance Body clearance End clearance	0.15 mm (0.006 in) 0.10–0.15 mm (0.004–0.006 in) 0.02–0.07 mm (0.001–0.003 in)	0.25 mm (0.010 in) 0.20 mm (0.008 in) 0.12 mm (0.005 in)

TROUBLESHOOTING

Oil level too low

- External oil leaks
- Worn valve guide or seal
- Worn piston rings

Oil contamination

- Oil not changed often enough
- Head gasket faulty
- Worn piston rings



LUBRICATION

ENGINE OIL LEVEL

Place the ATC on level ground.
Start the engine and let it idle for 2–3 minutes.
Stop the engine.
Check the oil with the oil cap/dipstick.
Do not screw in the cap when making this check.

If the level is below the lower level mark on the dipstick, fill to the upper level mark with the recommended oil (Page 2-1).

ENGINE OIL CHANGE

NOTE:

Drain the oil with the engine warm.

Remove the oil cap/dipstick and drain plug, and drain the oil.

With the engine switch "OFF", pull the recoil starter several times to completely drain any residual oil.

Install the drain plug.

NOTE:

Check the condition of the sealing washer. If it is damaged, replace it with a new one.

Clean the oil filter rotor.
Fill the crankcase with the recommended grade of oil (Page 2-1).

ENGINE OIL CAPACITY:

0.7 lit (0.74 US qt, 0.62 Imp qt) after draining

Install the oil filler cap.
Start the engine and let it idle for 2–3 minutes.
Stop the engine.

With the ATC on level ground, make sure that the oil level is at the upper level mark and that there are no leaks.

OIL FILTER ROTOR AND SCREEN

NOTE:

Clean the oil filter rotor before adding oil.

Remove the right crankcase (Page 8-2).

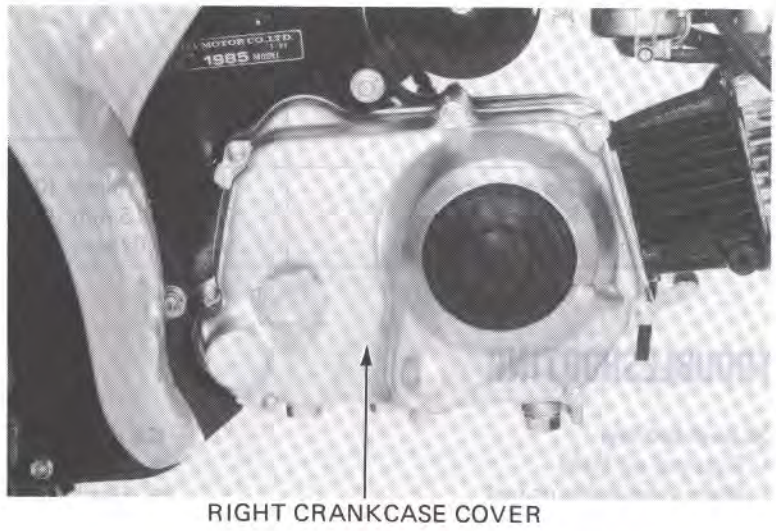
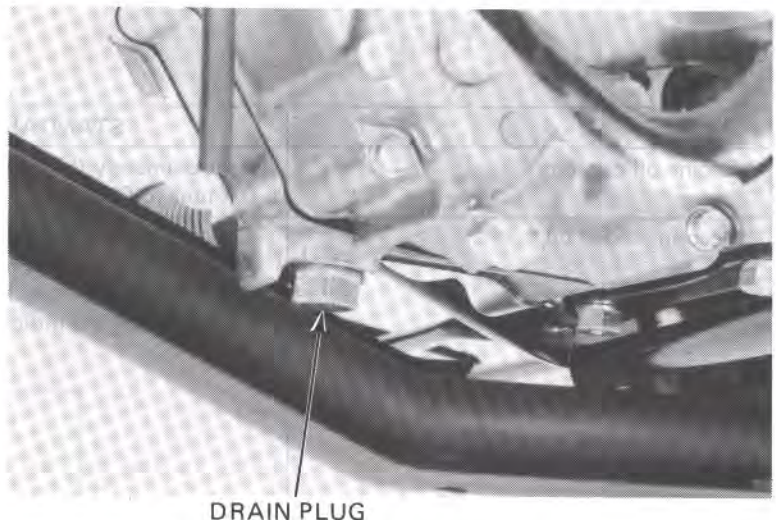
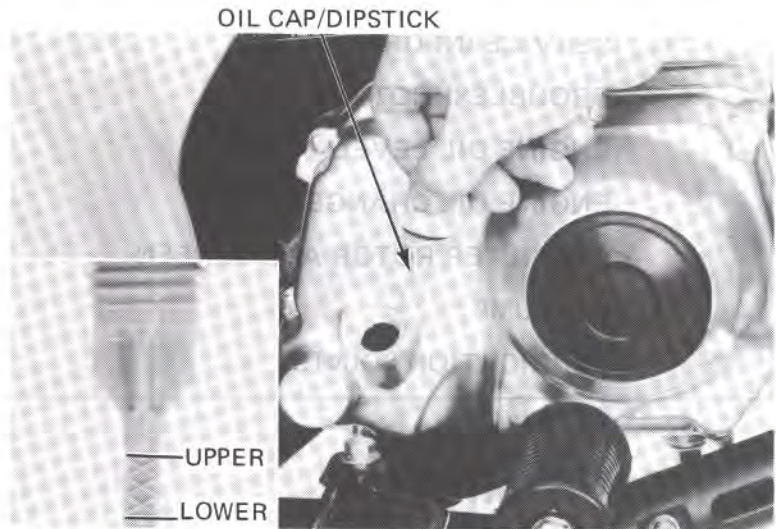



Remove the clutch lever, cam and outer cover (Page 8-3).

Clean the clutch outer cover and the inside of the clutch outer using clean lint-free cloth.

NOTE:

- Do not allow dust and dirt to enter the crankshaft oil passage.
- Do not use compressed air.

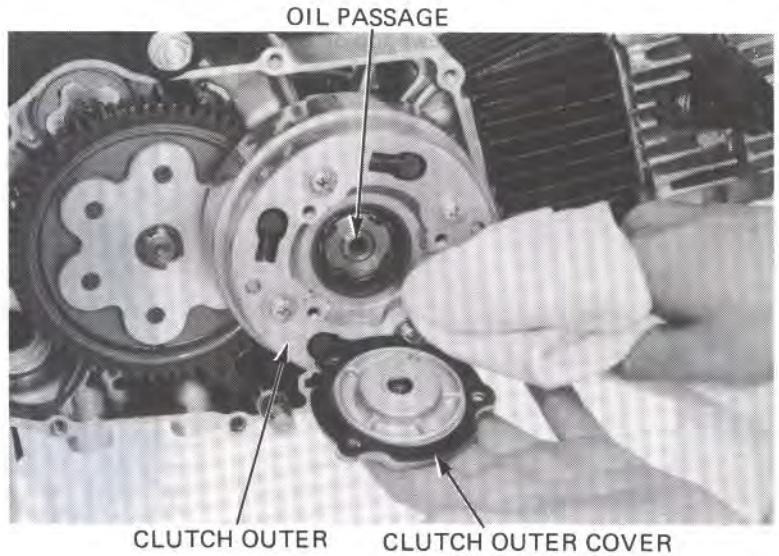

Remove the oil filter screen from the crankcase.
Clean the filter screen.

Install the clutch outer cover, cam and lever and right crankcase covers (Page 8-10).

Fill the engine with recommended grade of oil (Page 2-1).

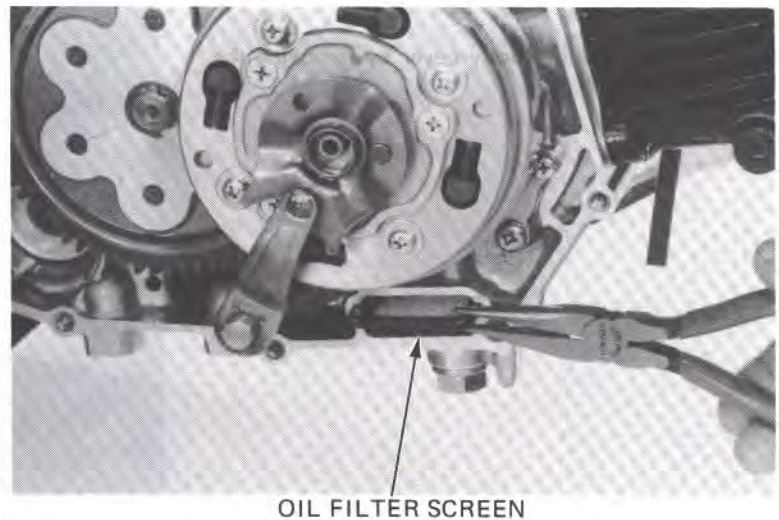

OIL PUMP

REMOVAL

NOTE:

- The oil pump can be removed with the engine mounted in the frame.

Remove the oil drain plug and drain the oil from the engine (Page 2-2).

Remove the right crankcase cover (Page 8-2).

Remove the clutch assembly (Page 8-3).

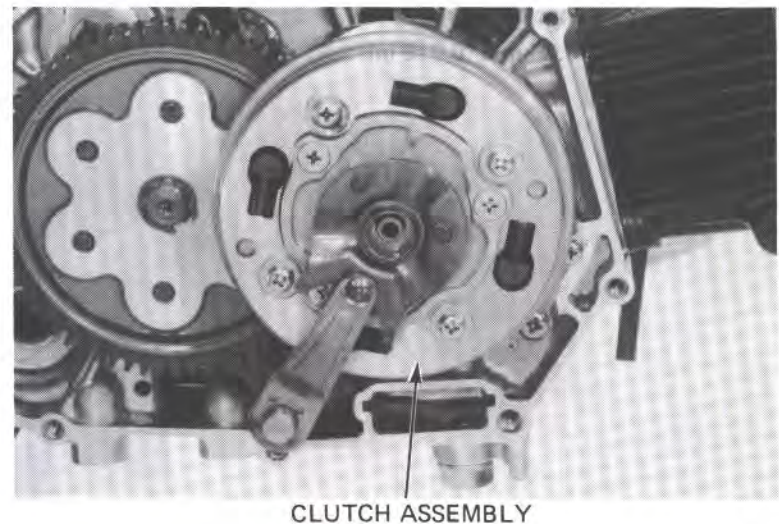



LUBRICATION

Remove the three oil pump screws and oil pump.

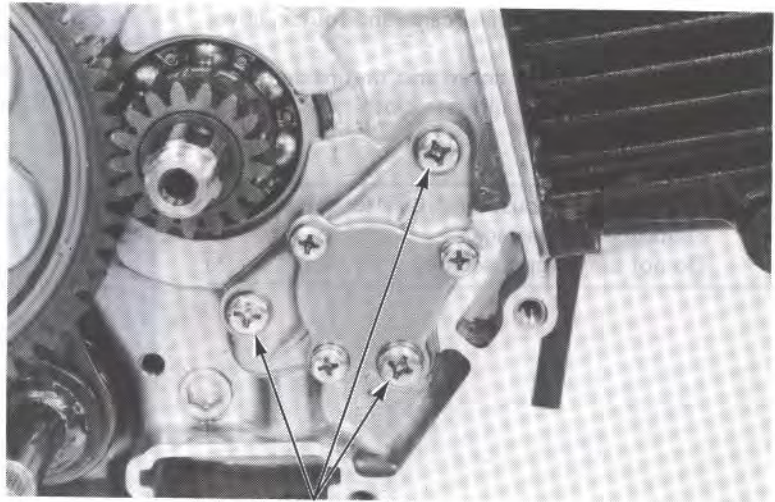

OIL PUMP SCREWS

INSPECTION

Remove the oil pump body cover by removing the three screws.

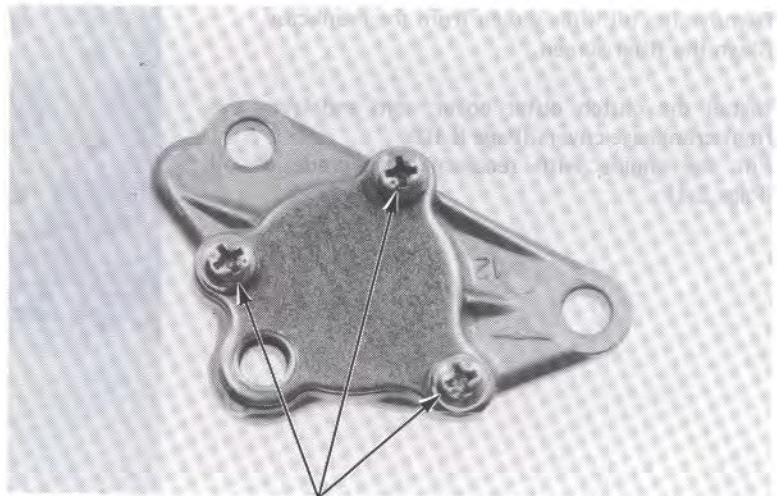

SCREWS

Measure the rotor tip clearance.

SERVICE LIMIT: 0.25 mm (0.010 in)

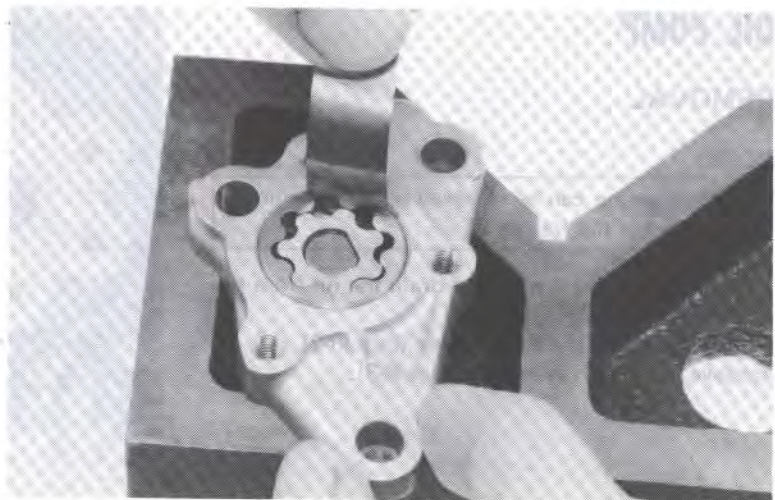



Measure the pump body clearance.

SERVICE LIMIT: 0.20 mm (0.008 in)

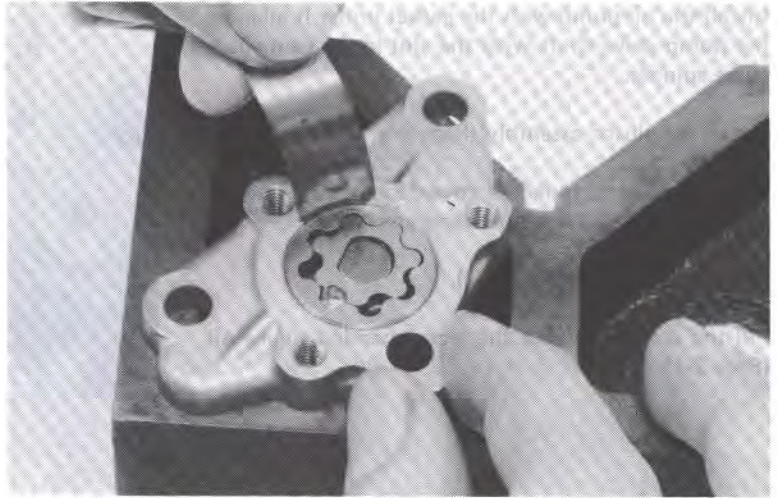

Place the oil pump cover gasket.
Measure the rotor end clearance.

SERVICE LIMIT: 0.12 mm (0.005 in)

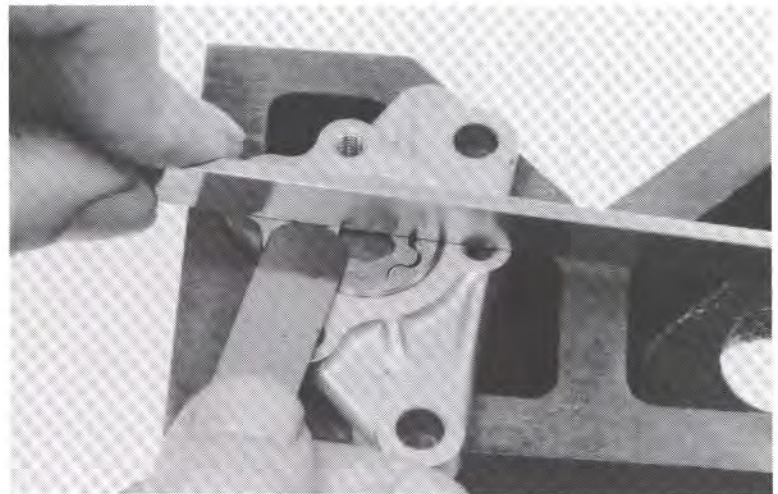

DISASSEMBLY

Remove the drive shaft.

Remove the inner and outer rotors.

ASSEMBLY

Install the outer and inner rotors.
Insert the drive shaft and align the flat on the shaft with the flat in the inner rotor. The flats should face each other.

Install the pump body cover gasket and cover.

NOTE:

Make sure that the pump rotates freely without binding.

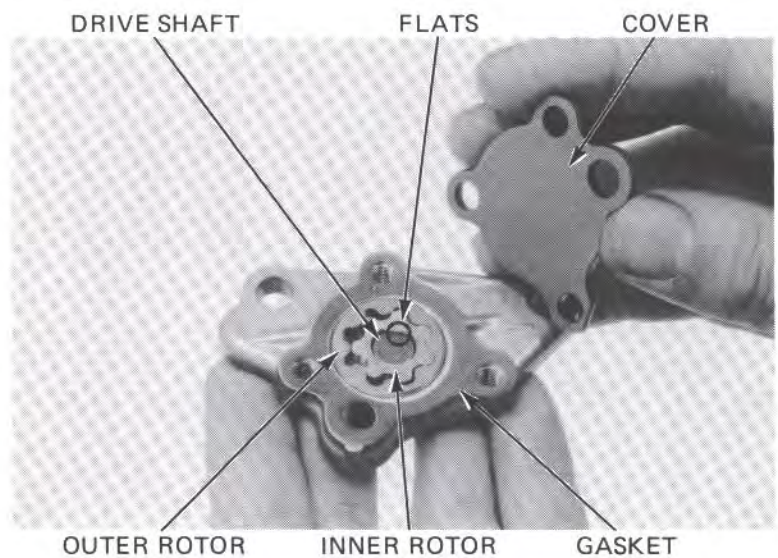



LUBRICATION

INSTALLATION

Install the oil pump with the gasket under it aligning the pump drive shaft with the slot in the cam chain guide spindle.

Install the clutch assembly (Page 8-9).

Install the right crankcase cover, kick starter pedal, muffler and foot pegs/side stand assembly.

Adjust the clutch (Page 3-12).

Fill the crankcase with the recommended engine oil (Page 2-1).

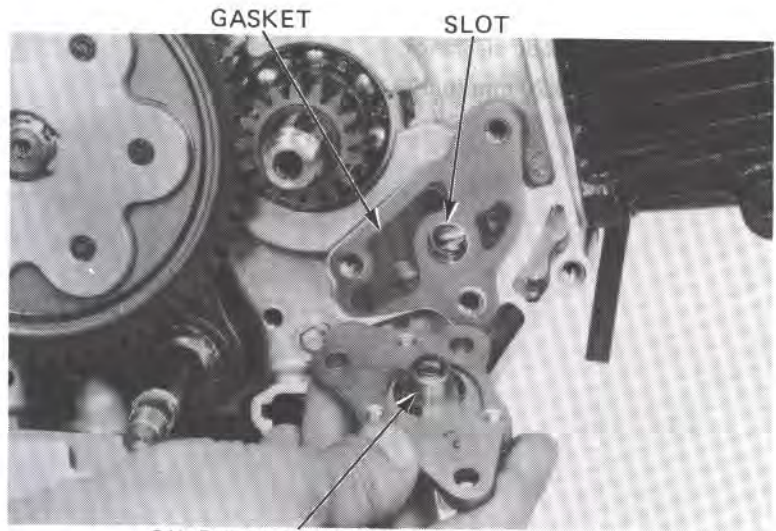

OIL PUMP DRIVE SHAFT



LUBRICATION POINTS

Use general purpose grease when not specified here.

Apply oil or grease to the other sliding surfaces not shown here.

CONTROL CABLE LUBRICATION

Periodically disconnect the throttle, and front brake cables at their upper ends. Thoroughly lubricate the cables and their pivot points with a commercially available cable lubricant.

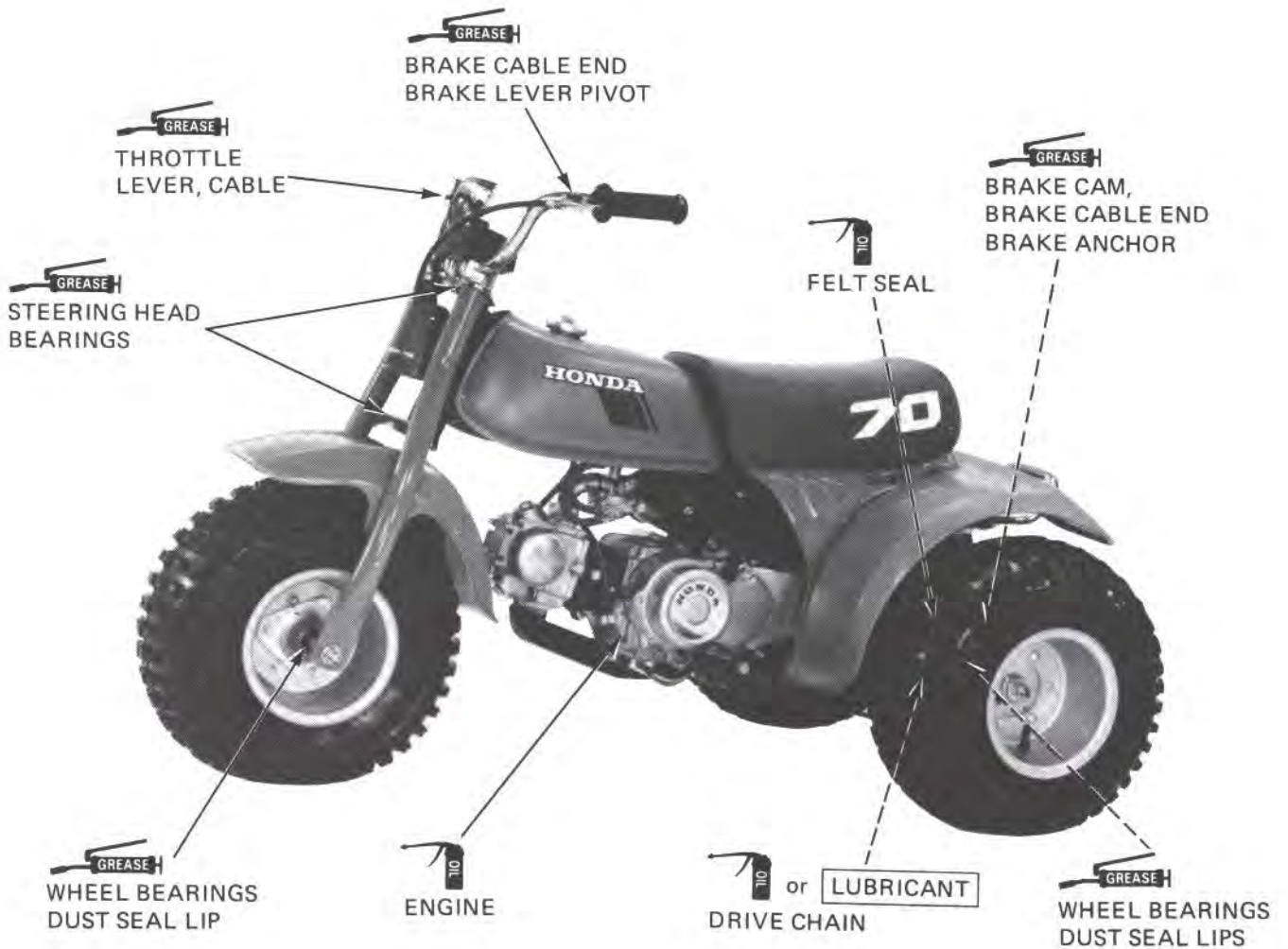



HONDA
ATC70

MEMO





SERVICE INFORMATION	3-1	THROTTLE OPERATION	3-9
MAINTENANCE SCHEDULE	3-3	CYLINDER COMPRESSION	3-10
CONTACT POINTS AND IGNITION TIMING	3-4	DRIVE CHAIN	3-10
AIR CLEANER	3-5	BRAKE SHOES	3-11
SPARK PLUG	3-6	BRAKE SYSTEM	3-12
VALVE CLEARANCE	3-7	CLUTCH	3-12
CARBURETOR IDLE SPEED	3-8	SPARK ARRESTER CLEANING	3-13
FUEL LINES	3-8	NUTS, BOLTS, FASTENERS	3-13
FUEL FILTER	3-8	TIRES	3-13
		STEERING HEAD BEARINGS	3-14

SERVICE INFORMATION

SPECIFICATIONS

Ignition timing:	
Initial	25° ± 2° BTDC at idle
Contact point gap	0.3–0.4 mm (0.012–0.016 in)
Spark plug:	
Spark plug gap	0.6–0.7 mm (0.024–0.028 in)
Recommended spark plugs	CR7HS (NGK) U22FSR-L (ND)
Valve clearance (cold):	
Intake/Exhaust	0.05 mm (0.002 in)
Throttle lever free play:	5–10 mm (3/16–3/8 in)
Idle speed:	1,500 ± 100 rpm
Cylinder compression:	
Standard	1,200 ± 150 kPa (12.0 ± 1.5 kg/cm ² , 170.64 ± 21.33 psi)
Service limit	900 kPa (9.0 kg/cm ² , 127.98 psi)
Brake lever free play	15–20 mm (5/8–3/4 in)
Drive chain free play	10–20 mm (3/8–3/4 in)
Drive chain length (72 pins):	
Standard	901.7 mm (35.5 in)
Service limit	919.7 mm (36.2 in)
Front/rear rim size	6.5 x 7.0
Front/rear tire size	16 x 8.0–7
Front/rear tire pressure	2.2 psi (0.15 kg/cm ² , 15 kPa)
Front/rear tire circumference:	
Standard	1,290 mm (50.7 in)



MAINTENANCE

TORQUE VALUES

Spark plug	12–19 N·m (1.2–1.9 kg·m, 9–14 ft·lb)
Valve inspection cap	10–14 N·m (1.0–1.4 kg·m, 7–10 ft·lb)
Drive chain adjuster nut	25–35 N·m (2.5–3.5 kg·m, 18–25 ft·lb)
Clutch adjuster lock nut	8–12 N·m (0.8–1.2 kg·m, 6–9 ft·lb)
Valve adjuster lock nut	7–10 N·m (0.7–1.0 kg·m, 5–7 ft·lb)

TOOLS

Common

Valve Adjuster B	07708–0030400 or 089201–200–000 (U.S.A. only)
Valve Adjuster Wrench, 8 x 9 mm	07908–GE00200 or equivalent commercially available in U.S.A.



MAINTENANCE SCHEDULE

The maintenance intervals shown in the following schedule are based upon average riding conditions. ATC's subjected to severe use, or ridden in unusually wet or dusty areas, require more frequent servicing. Items marked * should be serviced by an authorized Honda dealer, unless the owner has the proper tools and is mechanically proficient. Other maintenance items are simple to perform and may be serviced by the owner.

Perform the Pre-ride Inspection in the Owner's Manual at each scheduled maintenance period.

- I: Inspect and Clean, Adjust, Lubricate or Replace, if necessary.
- C: Clean
- R: Replace
- A: Adjust
- L: Lubricate

ITEM	INITIAL SERVICE PERIOD (First week of operation)	REGULAR SERVICE PERIOD (Every 30 operating days)	Ref. Page
ENGINE OIL (NOTE 1, 2)	R	R	2-2
* OIL FILTER SCREEN		C	2-2
* CONTACT POINT AND IGNITION TIMING	I	I	3-4
AIR CLEANER ELEMENT (NOTE 2)		I	3-5
SPARK PLUG	I	I	3-6
* VALVE CLEARANCE	I	I	3-7
* CARBURETOR	I	I	3-8
FUEL LINES	I (EVERY YEAR)		3-8
* FUEL FILTER	C (EVERY YEAR)		3-8
THROTTLE OPERATION	I	I	3-9
DRIVE CHAIN (NOTE 2)		I, L	3-10
* BRAKE SHOES (NOTE 3)	I (EVERY YEAR)		3-11
BRAKE SYSTEM	I	I	3-12
* CLUTCH	A	A	3-12
* SPARK ARRESTER		C	3-13
ALL NUTS, BOLTS, FASTENERS	I	I	3-13
TIRES	I	I	3-13
* STEERING HEAD BEARINGS	A (EVERY YEAR)		3-14

- NOTES: 1. Replace every 30 operating days or every 3 months, whichever occurs first.
 2. Service more frequently when riding in areas of dust, sand or snow.
 3. Service more frequently after riding in very wet or muddy condition.



CONTACT POINTS AND IGNITION TIMING

CONTACT POINT INSPECTION

Remove the recoil starter (Page 9-2).
Remove the starter driven pulley (Page 9-7).

Inspect the contact point surface.
If the contact surface are level but grayish in color or slightly pitted, file them lightly.

If the point have noticeable transfer of metal from one surface to the other, have evidence of heavy arcing, or are worn at an angle, the point set should be replaced.

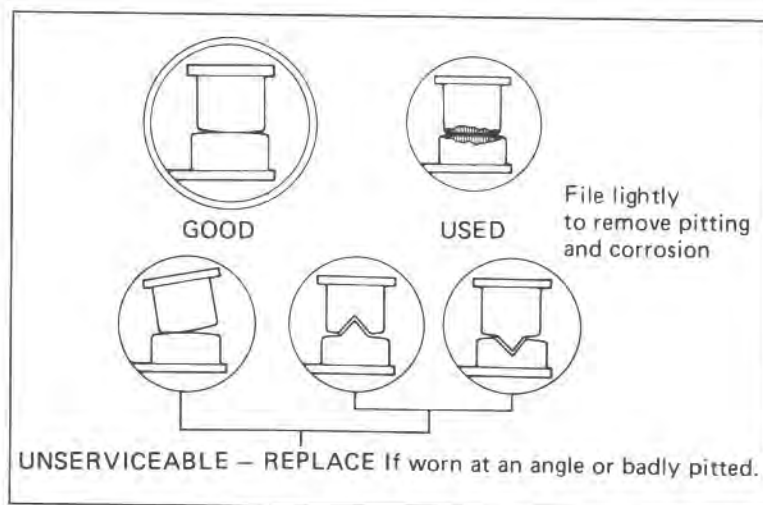

Turn the flywheel counterclockwise to obtain maximum point gap and measure the point gap with the filler gauge.

POINT GAP: 0.3–0.4 mm (0.012–0.016 in)

If the contact point gap is incorrect, loosen the locking screw and adjust the point gap.
Clean the contact point surface with an electrical contact cleaner to remove any oil film or dart.

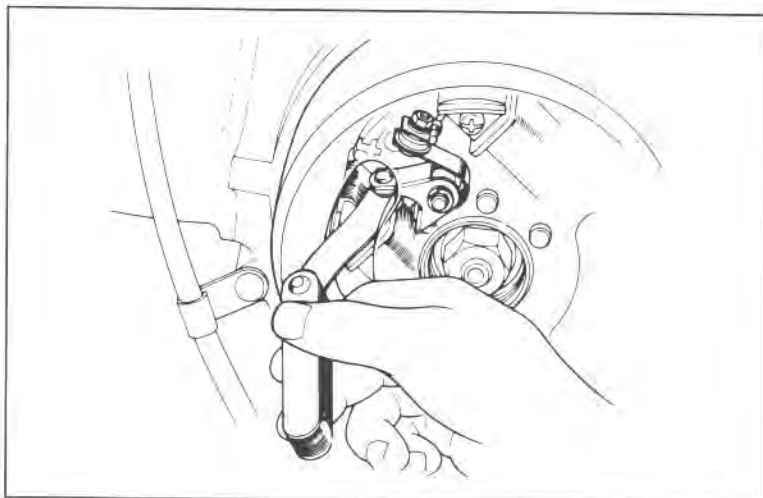

IGNITION TIMING INSPECTION

Disconnect the alternator wire connector.
Connect the continuity light between the battery positive terminal and alternator wire (Black).
Connect the battery negative cable to the frame ground.

Slowly rotate the flywheel counterclockwise.
As the "F" mark on the flywheel aligns with the index mark on the crankcase, the point should be open and the light becomes dim.

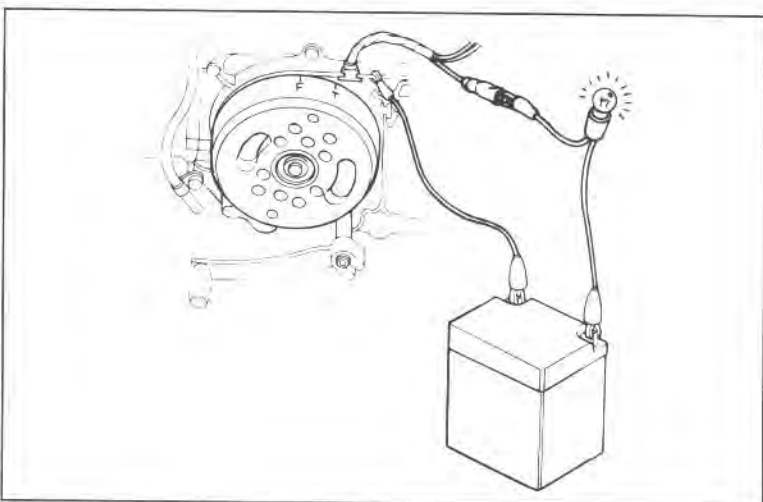



If the ignition timing is incorrect, loosen the contact point locking screw and adjust contact point gap.
 Increasing point gap: Advance ignition timing
 Decreasing point gap: Retard ignition timing

Tighten the locking screw.

NOTE:

- Replace the contact point if the specified point gap can not be maintained to obtain the correct ignition timing.
- Use stroboscopic timing light to determine accurate ignition timing.

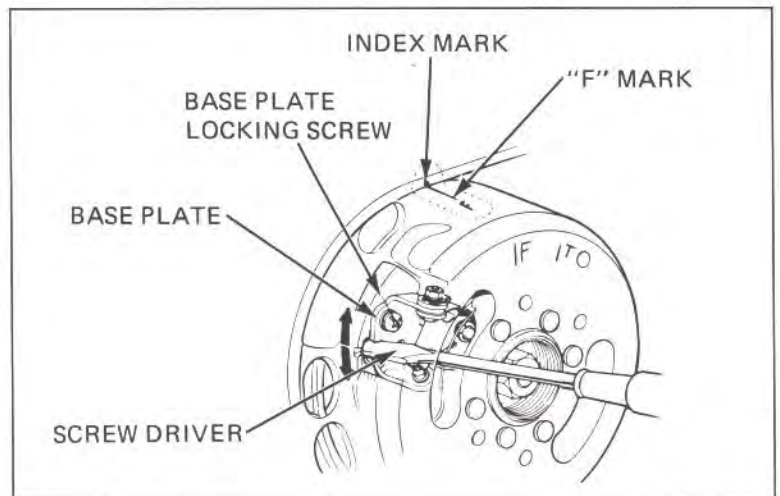

AIR CLEANER

Remove the case cover cap nut and remove the cover and gasket.

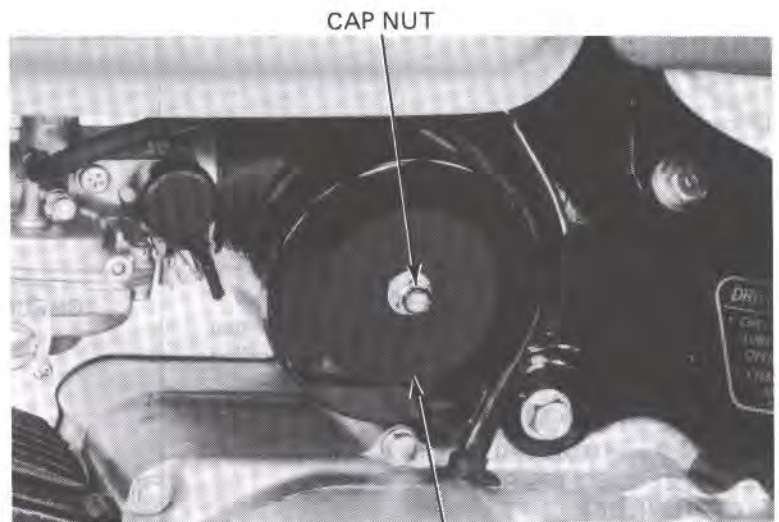

Separate the set plate and inner pipe from the element.
 Pull the element from the air cleaner case.

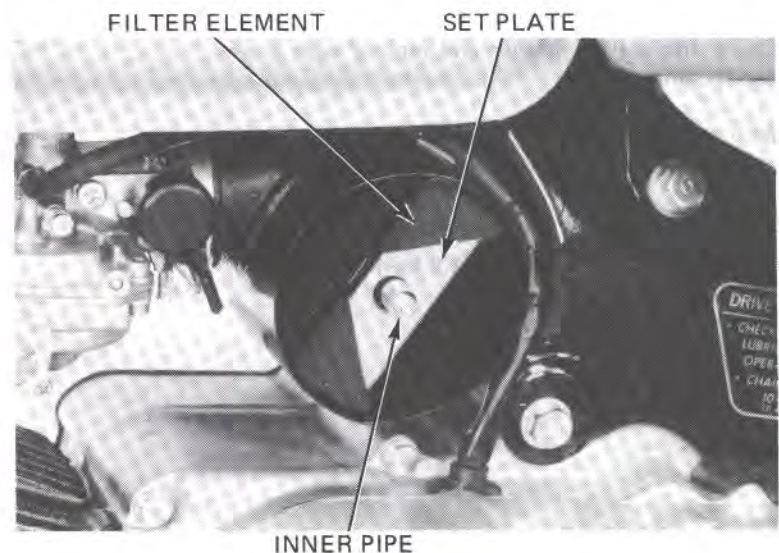



MAINTENANCE

Wash the element in non-flammable or high flash point solvent, squeeze out the solvent thoroughly, and allow to dry.

Soak the element in gear oil (SAE #80-#90) and squeeze out the excess.

Install the element in the air cleaner case with the set plate and inner pipe.

Install the gasket, cover and capnut.

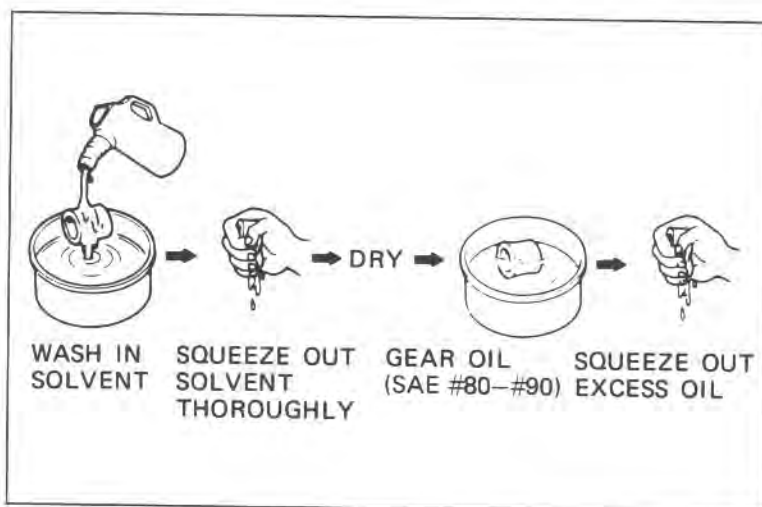

SPARK PLUG

Disconnect the spark plug cap and remove the spark plug.

Visually inspect the spark plug electrodes for wear. The center electrode should have square edges and the side electrode should have a constant thickness. Discard the spark plug if there is apparent wear or if the insulator is cracked or chipped. Measure the gap with a feeler gauge and adjust by carefully bending the side electrode.

SPARK PLUG GAP:

0.6-0.7 mm (0.024-0.028 in)

RECOMMENDED SPARK PLUG:

CR7HS (NGK)

U22FSR-L (ND)

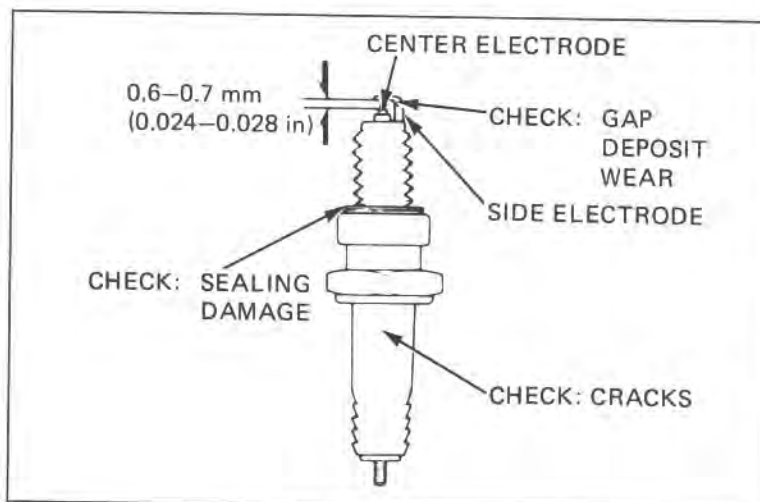

Check the sealing washer and replace with a new one if damaged.

With the sealing washer attached, thread the spark plug in by hand to prevent cross-threading.

Tighten the spark plug to the specified torque.

TORQUE: 12-19 N·m (1.2-1.9 kg-m, 9-14 ft-lb)

Connect the spark plug cap.



VALVE CLEARANCE

NOTE:

Inspect and adjust valve clearance while the engine is cold (below 35°C, 95°F).

Remove the recoil starter (Page 9-2).
Remove the valve inspection caps.

Turn the flywheel counterclockwise and align the "T" mark with the index mark.
Make sure the piston is T.D.C. on the compression stroke.

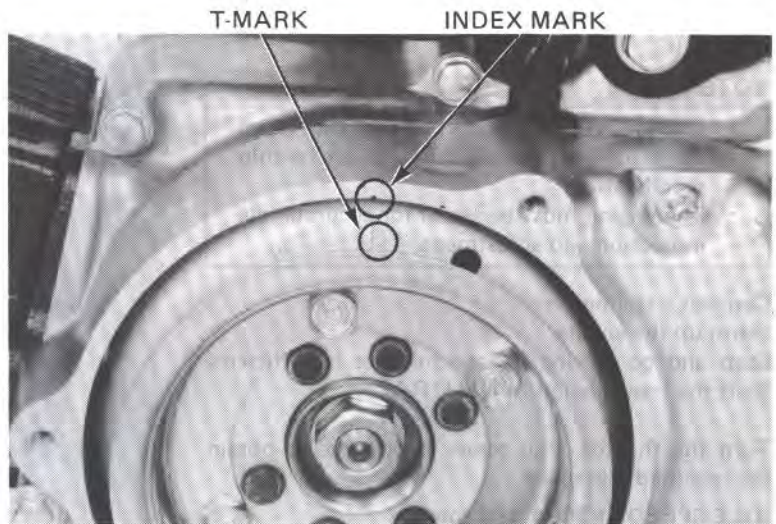

Check the valve clearances by inserting a feeler gauge between the adjusting screw and valve stem.

VALVE CLEARANCES

INTAKE/EXHAUST: 0.05 mm (0.002 in)

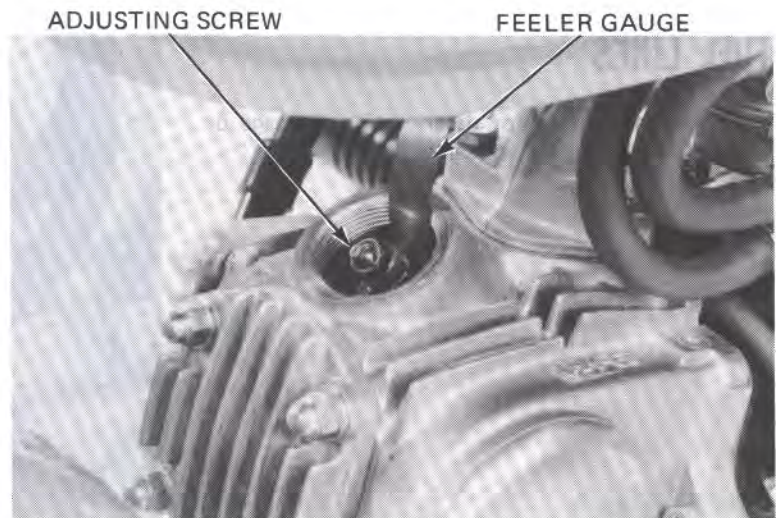

Adjust by loosening the lock nut and turning the adjusting screw until there is a slight drag on the feeler gauge.

Hold the adjusting screw and tighten the lock nut.
TORQUE: 7–10 N·m (0.7–1.0 kg-m, 5–7 ft-lb)

Recheck the valve clearance.

Install the recoil starter and valve inspection caps and tighten the caps.

TORQUE: 10–14 N·m (1.0–1.4 kg-m, 7–10 ft-lb)

VALVE ADJUSTING WRENCH, 8 x 9 mm
07908-GE00200 or equivalent commercially available in U.S.A.

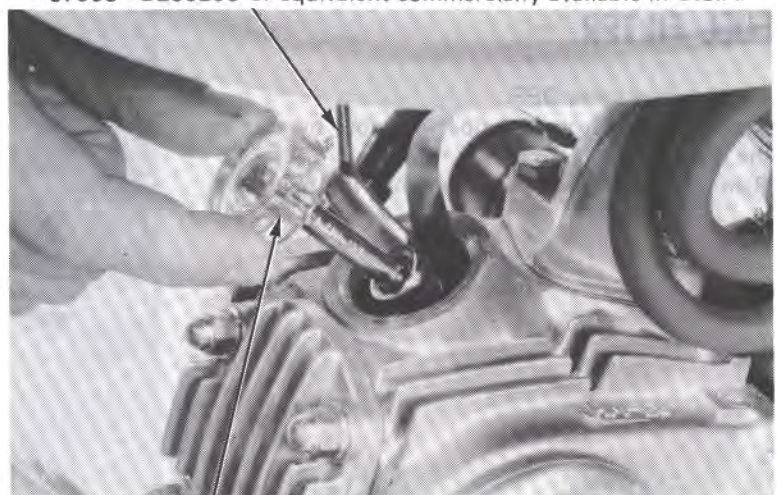

VALVE ADJUSTER B
07708-0030400 or 089201-200-000 (U.S.A. only)



MAINTENANCE

CARBURETOR IDLE SPEED

NOTE:

- Inspect and adjust carburetor idle speed all other engine adjustments are within specification.
- The engine must be warm for accurate idle inspection and adjustment.

Connect a tachometer.
Warm up the engine.
Stop and go driving for ten minutes is sufficient.
Shift the transmission to NEUTRAL.

Turn the throttle stop screw as required to obtain the specified idle speed.

IDLE SPEED: 1,500 ± 100 rpm

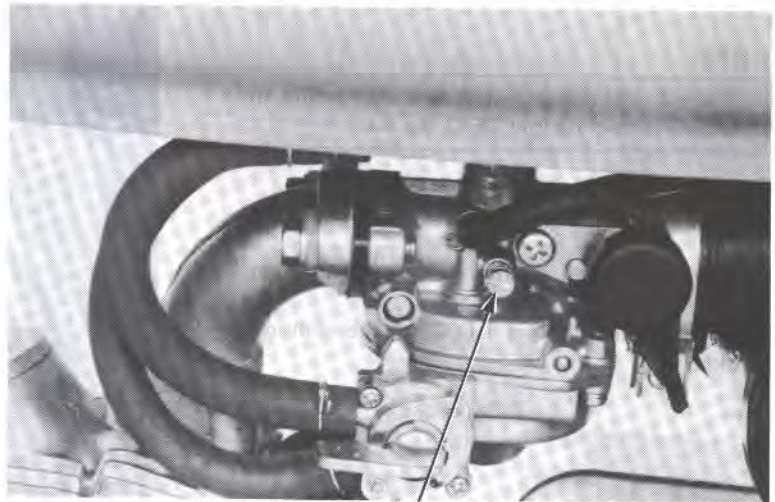

THROTTLE STOP SCREW

FUEL LINES

Check the fuel lines for deterioration, damage or leakage and replace if necessary.

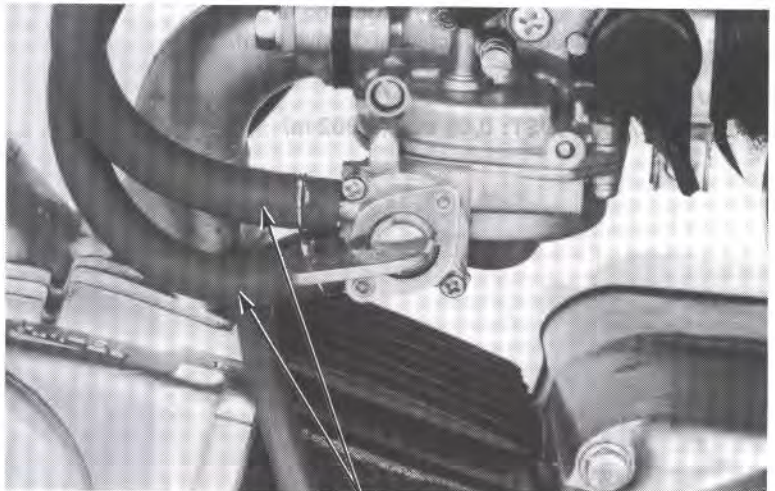

FUEL LINES

FUEL FILTER

Turn the fuel valve OFF.
Drain the fuel from the float chamber by turning the drain screw.
Remove the two screws and remove the fuel valve.

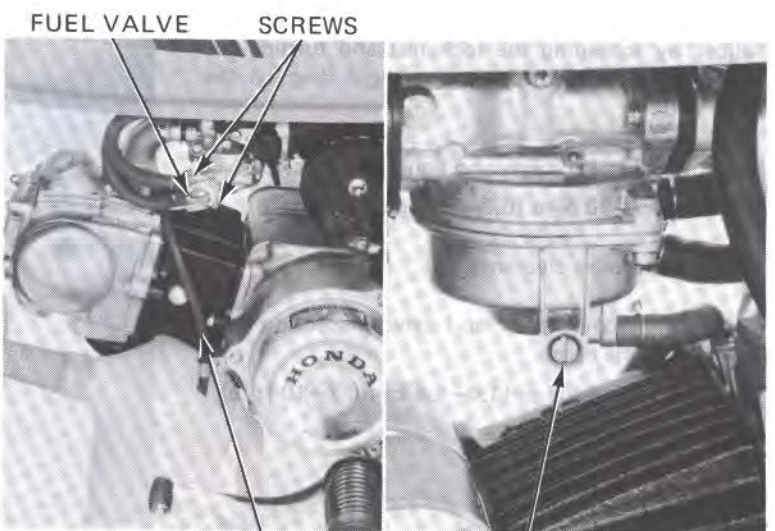

FUEL VALVE SCREWS

DRAIN HOSE

DRAIN SCREW



Remove the O-ring and filter screen.

WARNING

Gasoline is flammable and is explosive under certain conditions. Do not smoke or allow flames or sparks near the equipment while draining fuel.

Wash the filter screen in clean non-flammable or high flash point solvent.

Reinstall the filter screen and new O-ring into the carburetor.

Reinstall the fuel valve making sure the O-ring is in place.

After installing, turn the fuel valve ON and check that there are no fuel leaks.

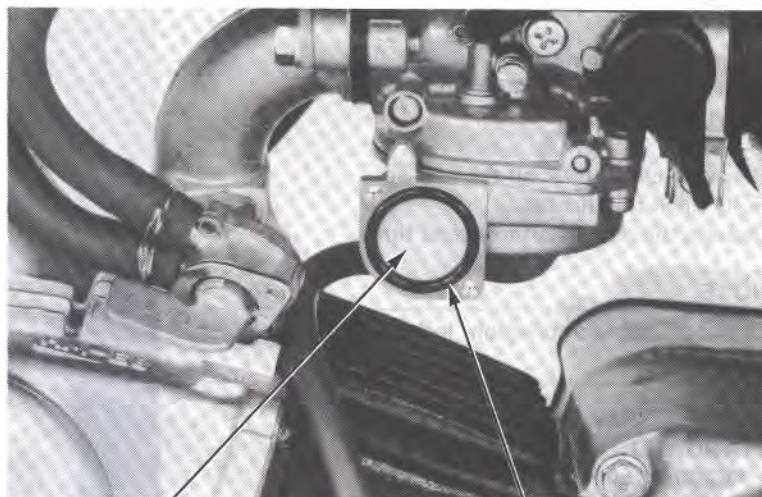

FILTER SCREEN

O-RING

THROTTLE OPERATION

Check for smooth throttle lever full opening and automatic full closing in all steering positions.

Make sure there is no deterioration, damage or kinking in the throttle cable.

Replace any damaged parts.

Disconnect the throttle cable at the upper end (Page 11-3).

Thoroughly lubricate the cable and pivot point with a commercially available cable lubricant to prevent premature wear.

Install the throttle cable in the reverse order of removal.

Make sure the throttle lever free play is 5–10 mm (3/16–3/8 in) at the tip of the throttle lever.

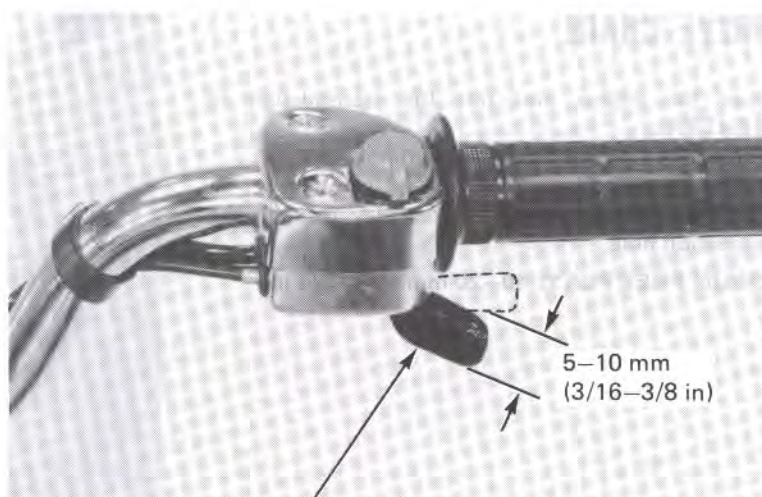

THROTTLE LEVER

5–10 mm
(3/16–3/8 in)

ADJUSTMENT

Slide the rubber cap of the adjuster on the carburetor top.

Adjust the throttle lever free play by turning the adjuster on the carburetor.

Install the adjuster rubber cap securely.

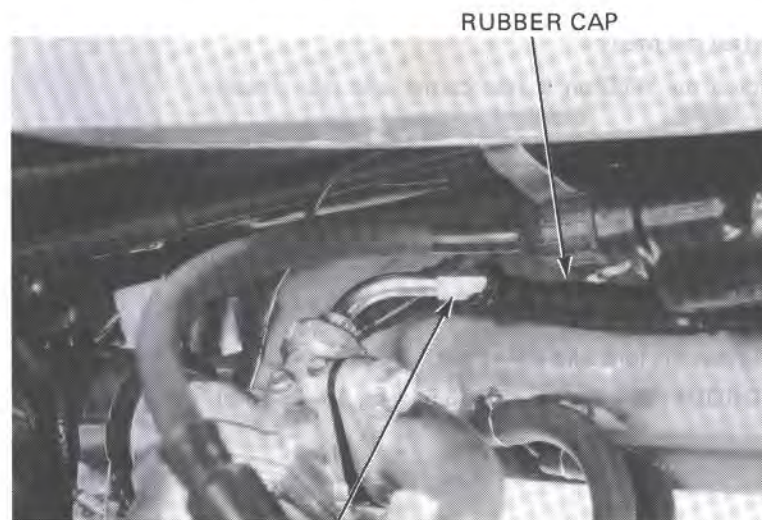

ADJUSTER

RUBBER CAP



MAINTENANCE

CYLINDER COMPRESSION

Warm up the engine.
Stop the engine and remove the spark plug.
Insert a compression gauge.

Raise the choke lever all the way up.
Fully open the throttle.
Operate the recoil starter several times.

NOTE:

Watch for compression leaks at the gauge connection.

COMPRESSION:

STANDARD:

1,200 ± 150 kPa
(12.0 ± 1.5 kg/cm², 170.64 ± 21.33 psi)

SERVICE LIMIT:

900 kPa (9.0 kg/cm², 127.98 psi)



COMPRESSION GAUGE

DRIVE CHAIN

Stop the engine and put the transmission in NEUTRAL.
Remove the drive chain inspection hole cap.

Check the amount of chain free play through the inspection hole.

CHAIN FREE PLAY: 10–20 mm (3/8–3/4 in)

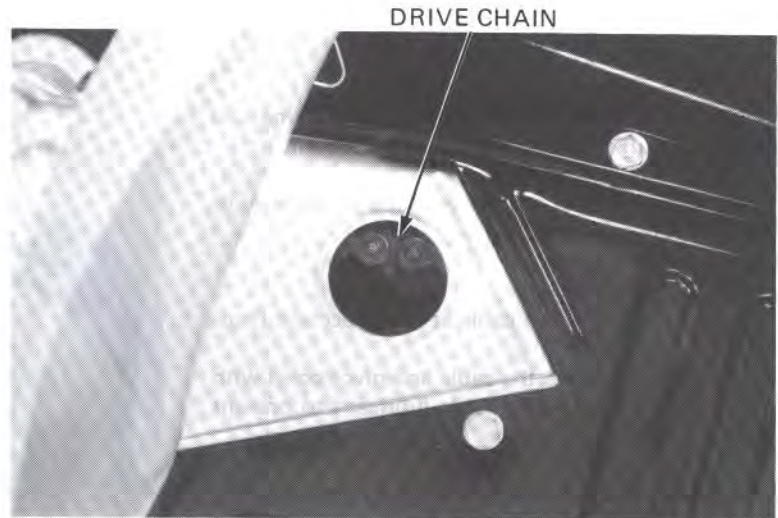

DRIVE CHAIN

ADJUSTMENT

Stand the ATC on its rear carrier and rear wheels.

CAUTION:

To prevent fuel spillage, if the fuel tank is more than half full, either drain some fuel or remove the tank (Page 4-3).

Loosen the lock nut and adjust nut and adjust the drive chain free play.

Tighten the lock and adjust nut.

TORQUE: 25–35 N·m (2.5–3.5 kg·m, 18–25 ft·lb)

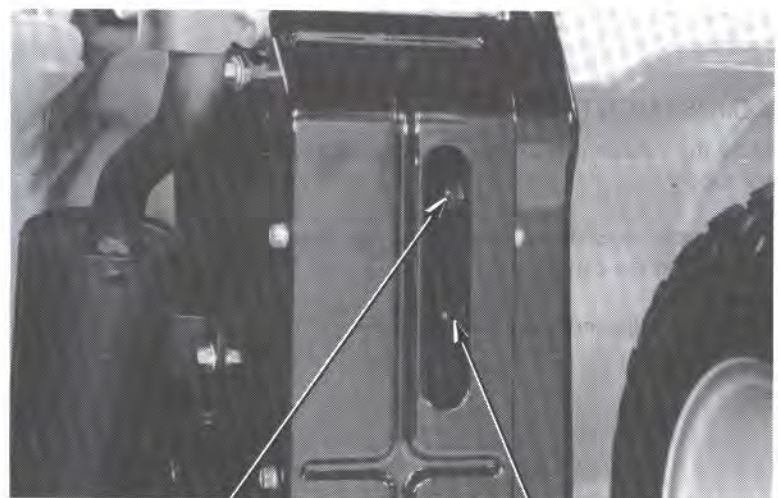

LOCK NUT

ADJUST NUT



Remove the rubber cap from the top of the drive chain cover and lubricate the drive chain with a commercially chain lubricants.

After lubricating the drive chain be sure to install the rubber cap.

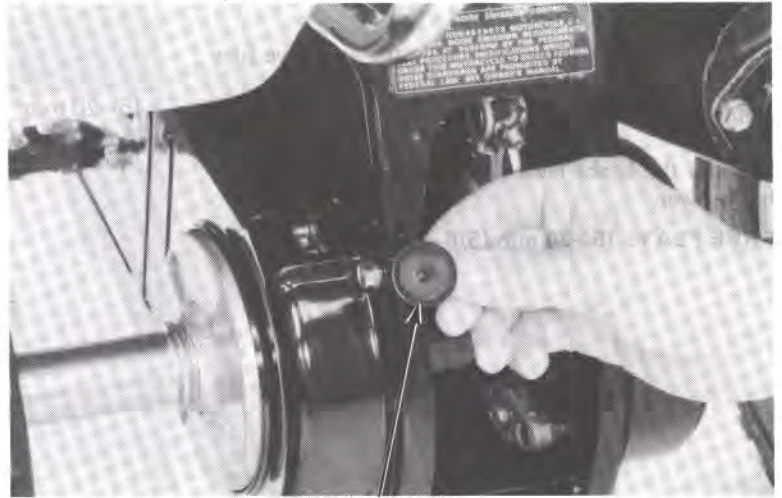

RUBBER CAP

Remove the drive chain cover by removing the four bolts and inspect the driven sprocket teeth for excessive wear or damage. Replace if necessary.

NOTE:

Never install a new drive chain on worn sprockets or a worn chain on new sprockets. Both chain and sprockets must be in good condition, or the new replacement chain or sprockets will wear rapidly.

To remove the drive chain, remove the drive chain cover and left crankcase cover (Page 9-7).

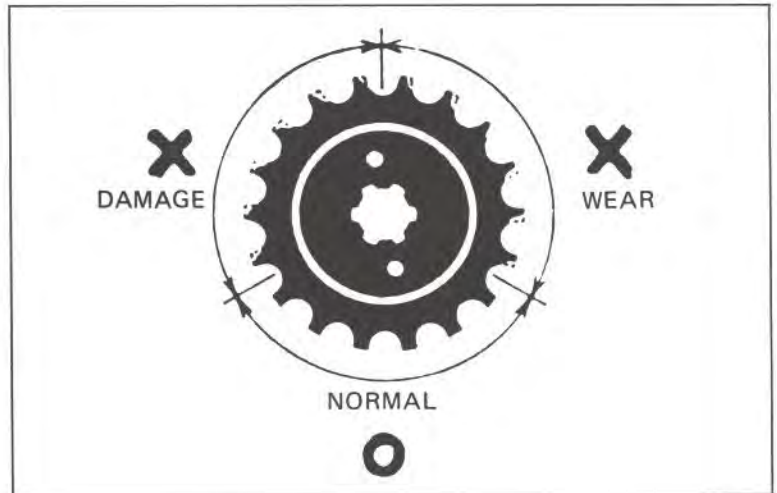

BRAKE SHOES

Replace the brake shoes if the indicator plate aligns with the brake panel index mark when the brake lever is applied.

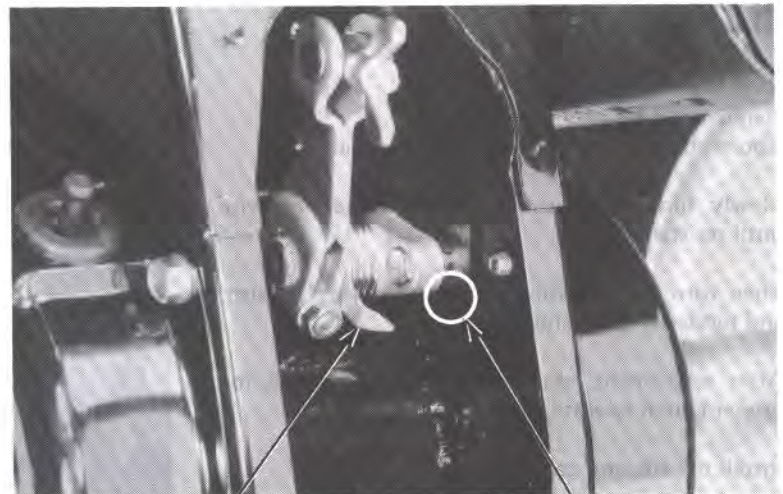

INDICATOR PLATE

INDEX MARK



BRAKE SYSTEM

Check the brake lever and cable for excessive play or other damage.
Replace or repair as necessary.

Measure the brake lever free play at the end of the brake lever.

FREE PLAY: 15–20 mm (5/8–3/4 in)

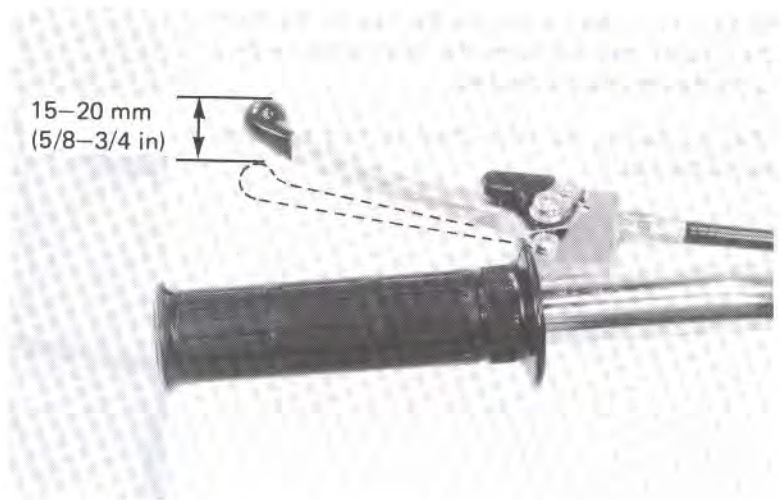

Adjust the brake lever free play by turning the adjuster nut.

NOTE:

Make sure the cut-out of the adjuster is seated on the brake arm pin.

CABLE LUBRICATION

Loosen the brake adjuster and disconnect the brake cable at the lever.

Lubricate the cable and their pivot point with a commercially available cable lubricant.

Install the brake cable in the reverse order of removal and recheck the brake lever free play.

ADJUSTER NUT

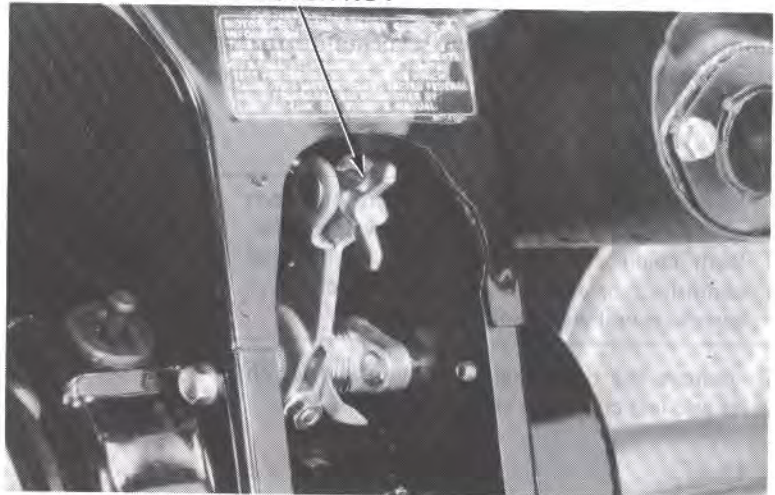

CLUTCH

Stop the engine.
Remove the adjuster cap.
Loosen the clutch adjusting screw lock nut.

Slowly turn the adjusting screw counterclockwise until resistance is felt.

Then turn the adjusting screw clockwise 1/8 turn, and tighten the lock nut.

After adjustment, start the engine and check for proper clutch operation.

Install the adjuster cap.

ADJUSTING SCREW

LOCK NUT

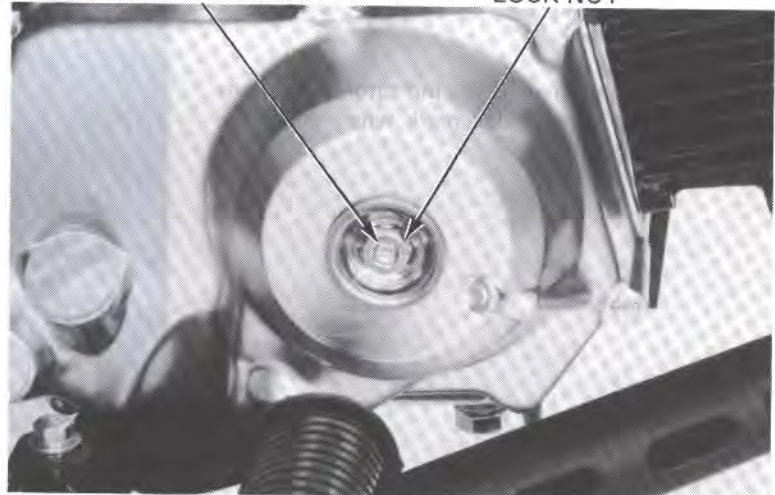



SPARK ARRESTER CLEANING

WARNING

- Do not remove and install the spark arrester while the exhaust pipe is hot.
- Perform this operation in a wellventilated area, free from fire hazard.
- Use adequate eye protection.

Remove the spark arrester bolt and pull out the spark arrester.

Remove any accumulated carbon from the spark arrester.

Start the engine and remove accumulated carbon from the exhaust system by momentarily revving up the engine several times.

Stop the engine and reinstall the spark arrester.

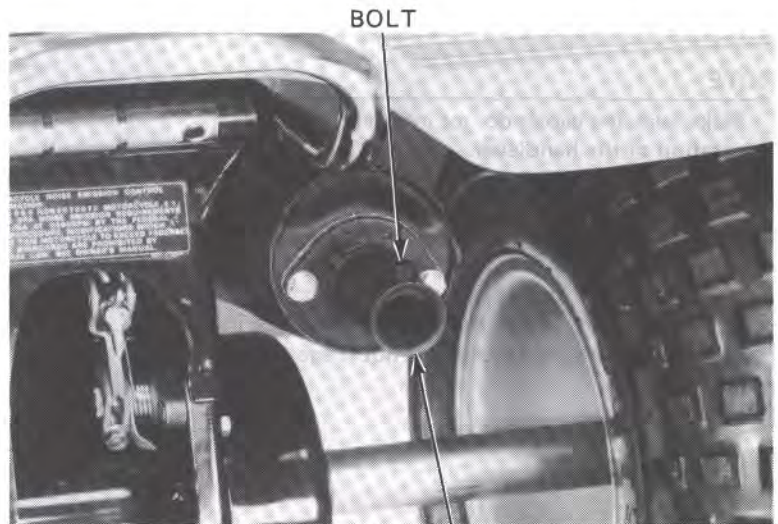

BOLT

SPARK ARRESTER

NUTS, BOLTS, FASTENERS

Tighten bolts, nuts and fasteners at regular intervals shown in the Maintenance Schedule (Page 3-3).

Check that all chassis nuts and bolts are tightened to their correct torque values (Page 1-5). Check that all cotter pins and safety clips are in place.



SPARK ARRESTER

TIRES

Check the tire for cuts, imbedded nails, or other sharp objects.

NOTE:

Tire pressure should be checked when the tires are COLD.

Check the tire pressure.

TIRE PRESSURES:

Recommended pressure:

2.2 psi (0.15 kg/cm², 15 kPa)

Minimum pressure:

1.7 psi (0.12 kg/cm², 12 kPa)

Maximum pressure:

2.6 psi (0.18 kg/cm², 18 kPa)

Raise up the rear wheel and check the tire circumference.

STANDARD TIRE CIRCUMFERENCE:

1,290 mm (50.7 in)

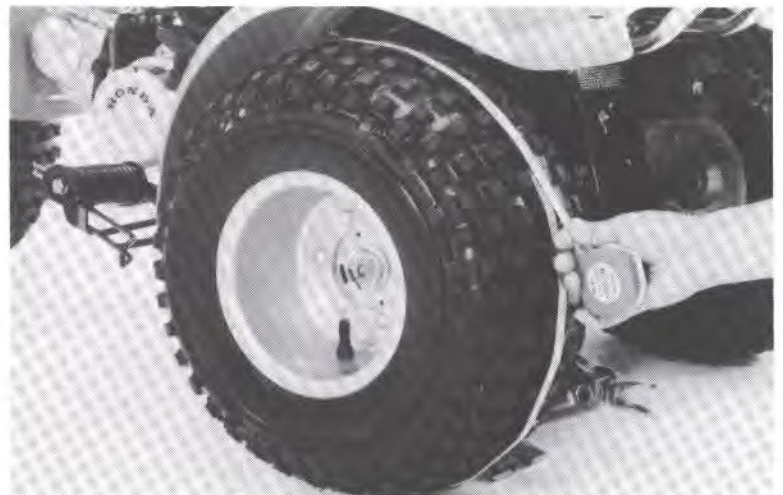



STEERING HEAD BEARINGS

NOTE:

Make sure the cables do not interfere with the rotation of the handlebar.

Raise the front wheel off the ground and make sure that the handlebar rotates freely.

If the handlebar moves unevenly, binds or has vertical movement, adjust the steering head bearing by turning the bearing adjustment nut (Page 11-15).

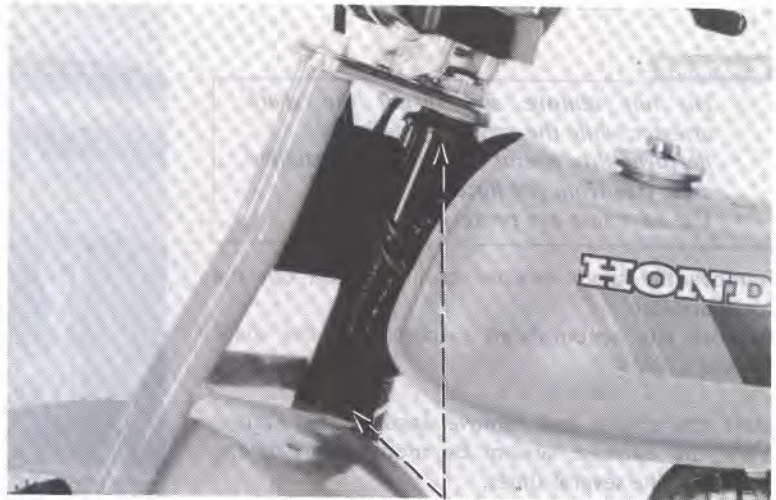

HEAD BEARINGS



HONDA
ATC70

MEMO

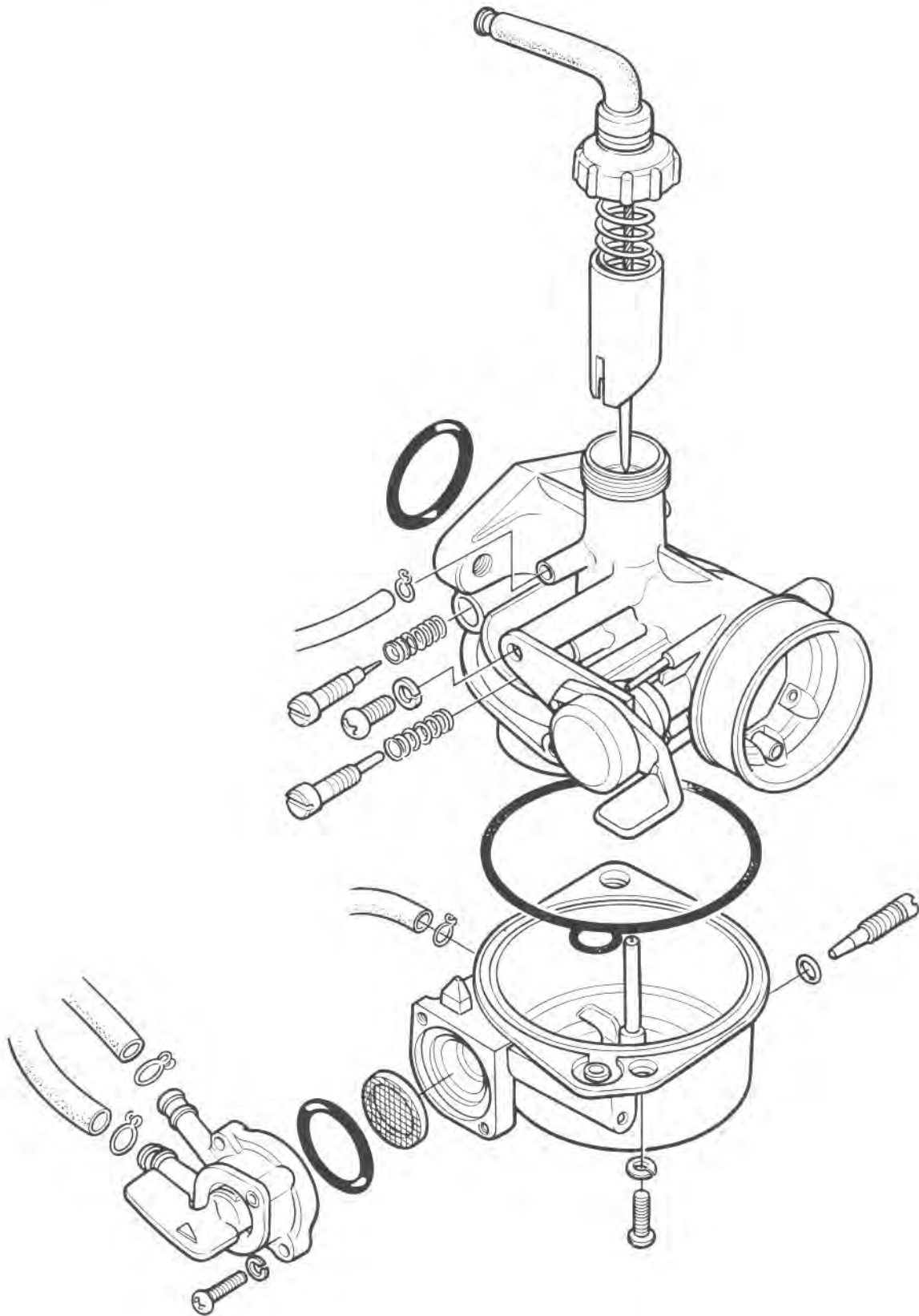



SERVICE INFORMATION	4-1
TROUBLESHOOTING	4-2
FUEL TANK	4-3
AIR CLEANER CASE	4-3
CARBURETOR REMOVAL	4-4
CARBURETOR INSTALLATION	4-8
PILOT SCREW ADJUSTMENT	4-9

SERVICE INFORMATION

GENERAL

WARNING

Use caution when working with gasoline. Always work in a well ventilated area away from sparks or flames.

- When disassembling fuel system parts, note the locations of the O-rings. Replace them during reassembly.

SPECIFICATIONS

< Fuel tank >

Fuel tank capacity	43 lits (1.1 US gal, 0.96 Imp gal)
Fuel reserve capacity	0.8 lits (0.2 US gal, 0.17 Imp gal)

< Carburetor >

Identification mark	PB38A
Main jet	# 58
Slow jet	# 38
Jet needle setting	4th groove from the top
Pilot screw opening	1-3/4 turns out
Float level	10.7 mm (0.42 in)
Idle speed	1,500 ± 100 rpm

TORQUE VALUE

Intake pipe attaching bolt 6-9 N·m (0.6-0.9 kg-m, 4.5-4.7 ft-lb)

TOOL

Common
Float Level Gauge 07401-0010000



TROUBLESHOOTING

Engine cranks but won't start.

- No fuel in tank
- No fuel to cylinder
- Too much fuel getting to cylinder
- No spark at plug (ignition malfunction)
- Air cleaner clogged

Engine idles roughly, stalls, or runs poorly

- Idle speed incorrect
- Ignition malfunction
- Rich mixture
- Lean mixture
- Air cleaner dirty
- Insulator leaks

Lean mixture

- Carburetor fuel jet clogged
- Fuel cap vent blocked
- Fuel filter clogged
- Fuel line kinked or restricted
- Float valve faulty
- Float level too low

Rich mixture:

- Carburetor choke stuck closed
- Float valve faulty
- Float level too high
- Carburetor air jet clogged
- Air cleaner dirty



FUEL TANK

REMOVAL

Remove the seat/fender by removing the four bolts shown.

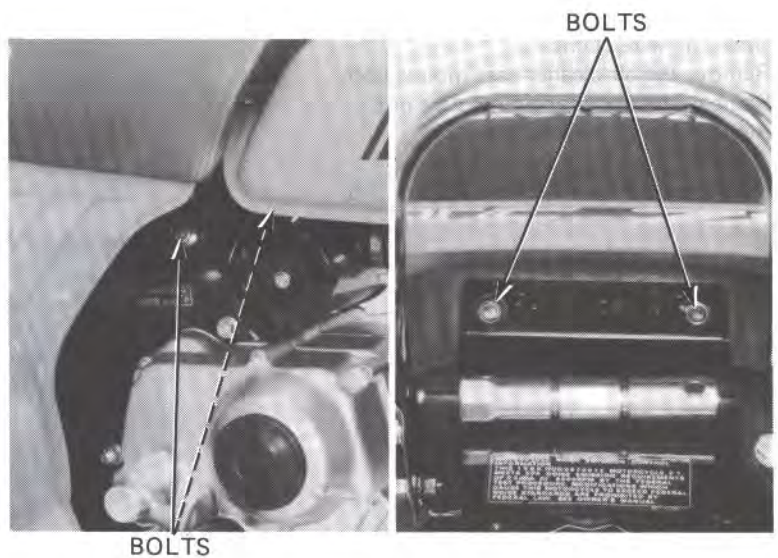

Turn the fuel valve OFF.
Remove the fuel valve (Page 3-8).
Remove the fuel tank mount bolt and fuel tank.

WARNING

*Keep gasoline away from flames or sparks.
Wipe up spilled gasoline at once.*

Using a drain pan, check for fuel flow out of the fuel valve. If flow is restricted, clean the fuel strainer (Page 3-9).

INSTALLATION

Install the fuel tank. Install the fuel valve onto its body.
Install the seat.

NOTE:

- Be sure the front fuel tank brackets are on the rubber cushions.
- After assembly, check fuel leaks.

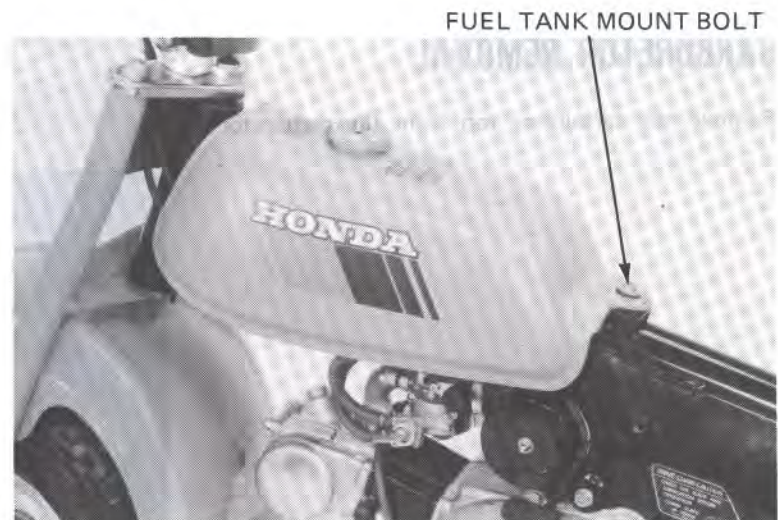

AIR CLEANER CASE

Remove the intake pipe mount bolts.
Loosen the air cleaner connecting tube band.
Disconnect the air vent tube from carburetor.
Remove the carburetor.

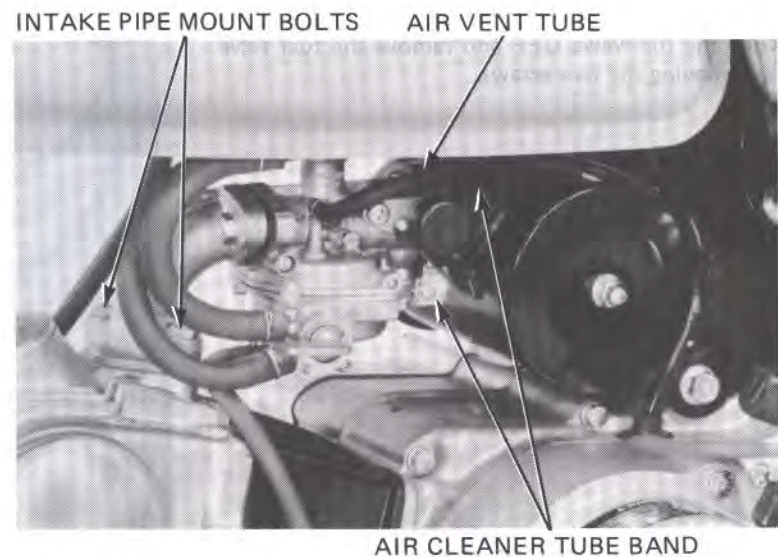



FUEL SYSTEM

Open the wire clamp.
Remove the air cleaner case mount bolt.
Remove the upper engine mount nut.
Remove the air cleaner case.

For air cleaner service, refer to page 3-5.

AIR CLEANER CASE
MOUNT BOLT



WIRE CLAMP



ENGINE UPPER
MOUNT NUT

CARBURETOR REMOVAL

Remove the carburetor top from the carburetor.

CARBURETOR TOP

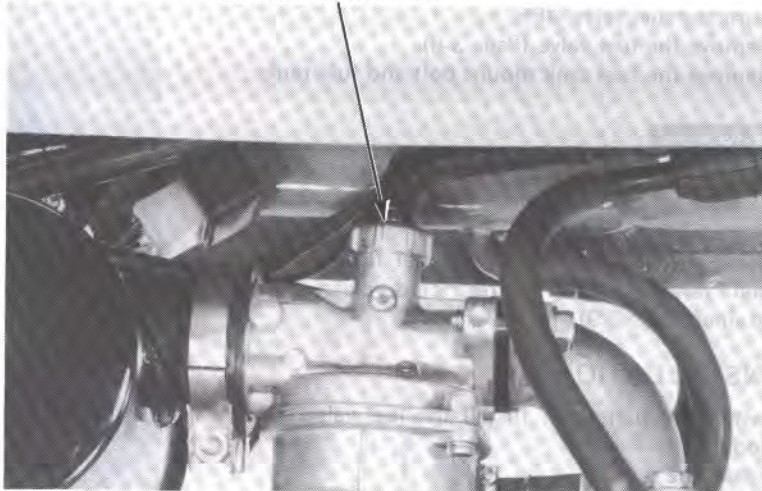

Turn the fuel valve OFF and remove the fuel valve
by removing the two screws.

FUEL VALVE

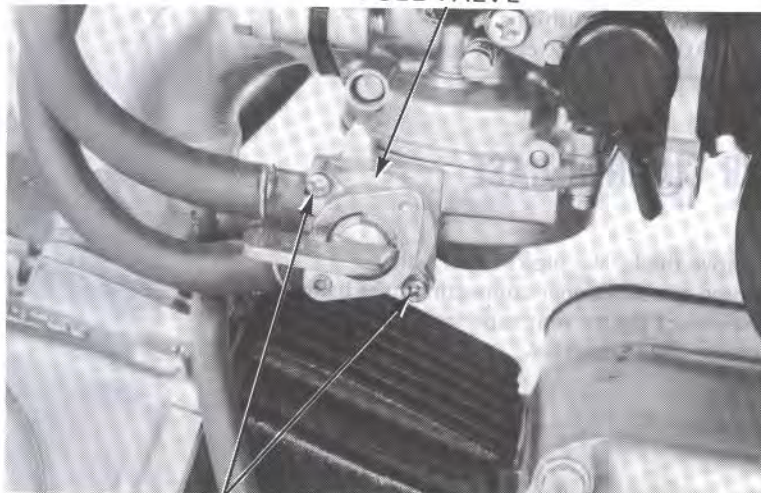

SCREWS



Disconnect the air vent tube and drain tube from the carburetor.

Loosen the air cleaner tube band.

Remove the following:

- Intake pipe attaching bolts to the carburetor.
- Intake pipe mount bolts.
- Intake pipe and insulator.
- Carburetor.

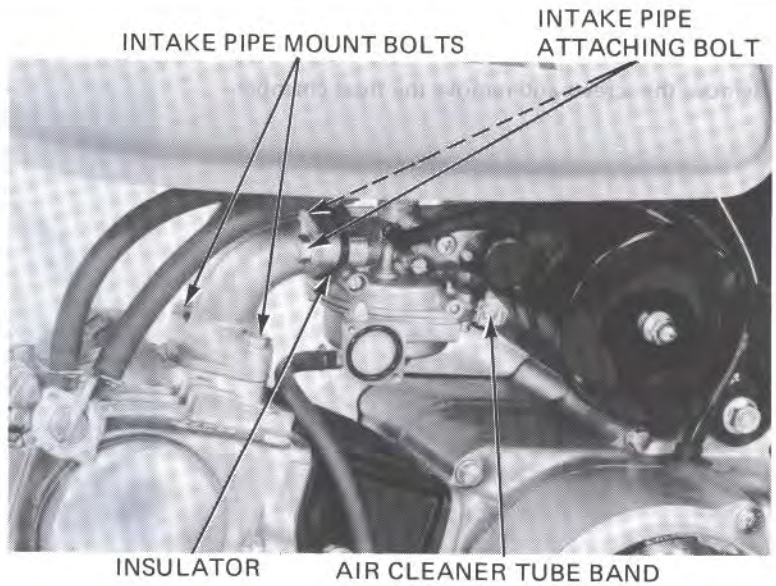

THROTTLE VALVE DISASSEMBLY

Remove the throttle cable from the throttle valve while depressing the throttle valve spring.

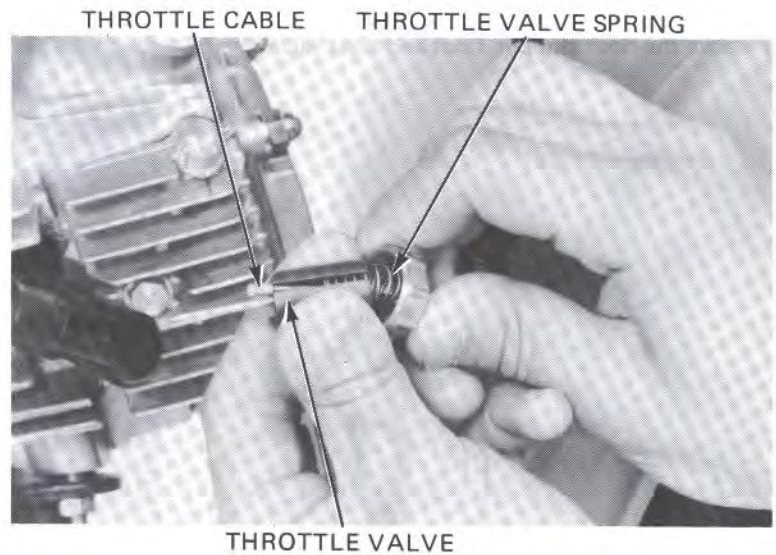

Remove the needle clip retainer.
Remove the jet needle and needle clip.

Inspect the throttle valve and jet needle surface for dirt, scratches or wear.

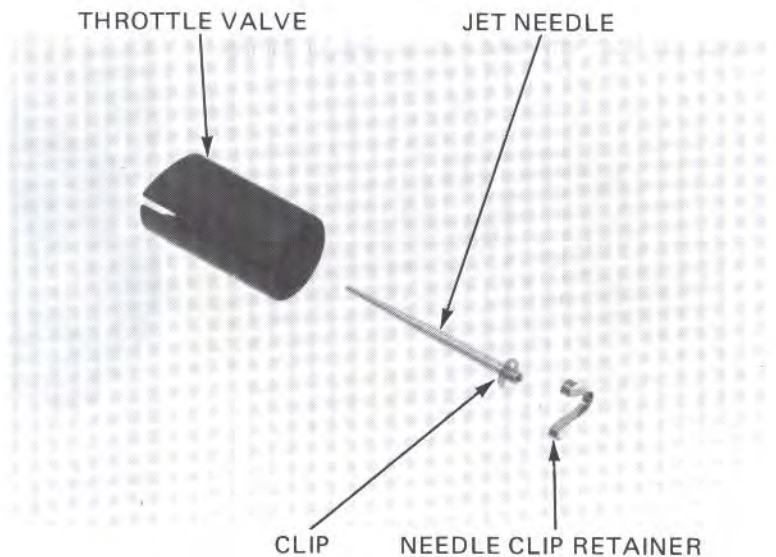



FUEL SYSTEM

FLOAT CHAMBER DISASSEMBLY

Remove the screws and remove the float chamber.

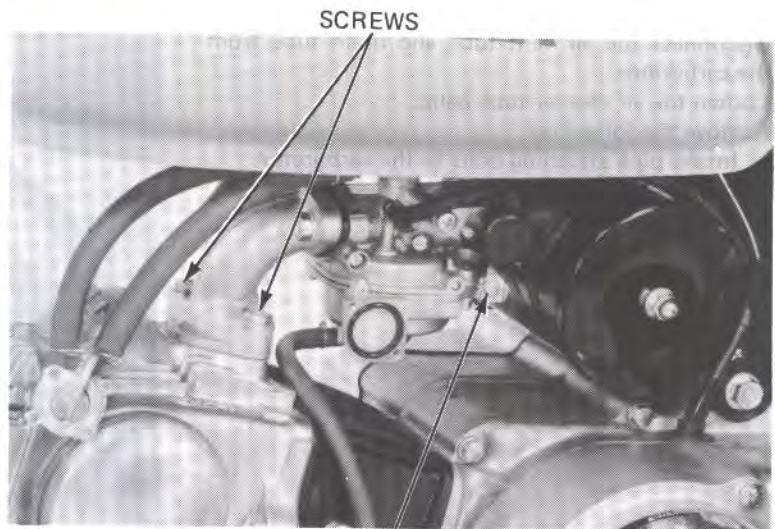

FLOAT CHAMBER

Remove the float arm pin, float and float valve.

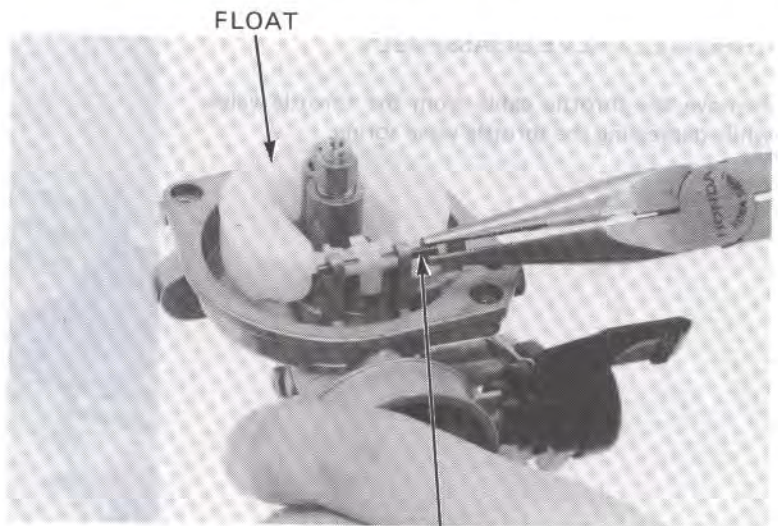

Inspect the float valve and seat for wear or damage.

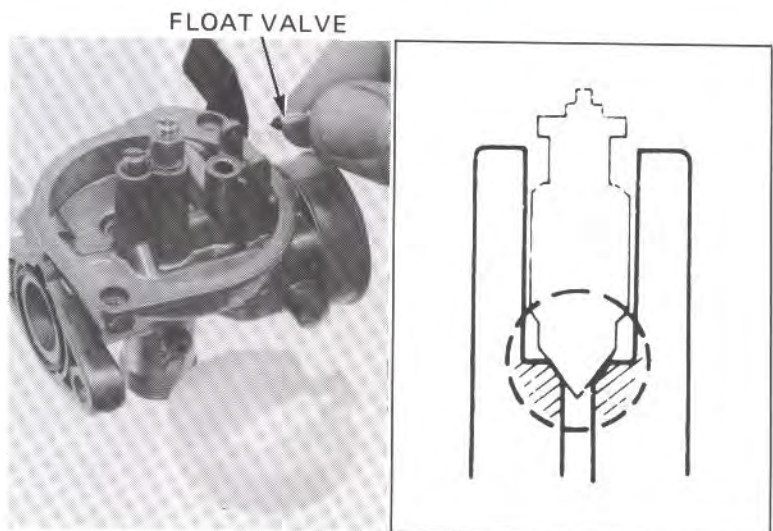



Remove the slow jet.
Remove the main jet, needle jet holder and needle jet.

Before removing the pilot screw, record the number of turns until the screw seats lightly.

CAUTION:

Damage to the pilot screw seat will occur if the pilot screw is tightened against the seat.

Then remove the screw.

Inspect the pilot screw, needle jet, needle jet holder and main jet.
Check each parts for wear or damage.

Clean the passages and jets with compressed air.

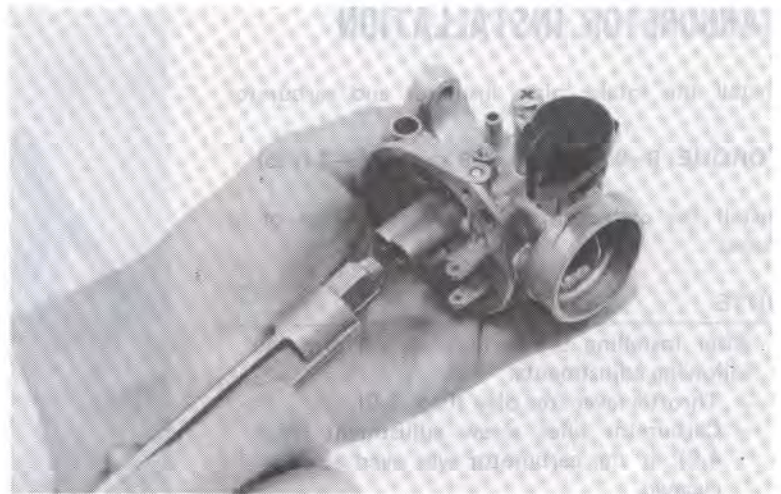
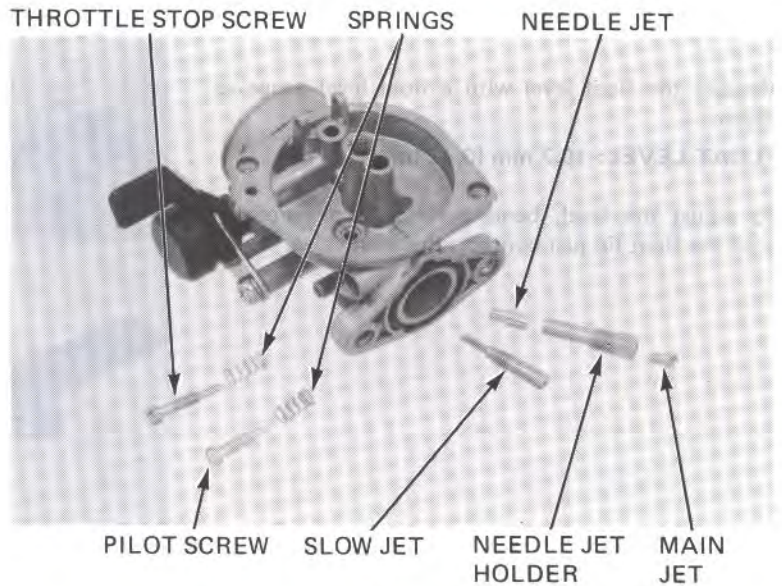

CARBURETOR ASSEMBLY

Clean all parts high flash point solvent and blow dry with compressed air.

Carburetor assembly is essentially the reverse order of disassembly.

NOTE:

- Use new O-rings whenever the carburetor is reassembled.
- Handle all jets and needles with care. They can easily be scored or damaged.
- Set the pilot screw at the position recorded during disassembly.

After assembly, turn on the fuel valve and check for leaks.

Adjust idle speed (Page 3-8) and throttle grip free play (Page 3-9).

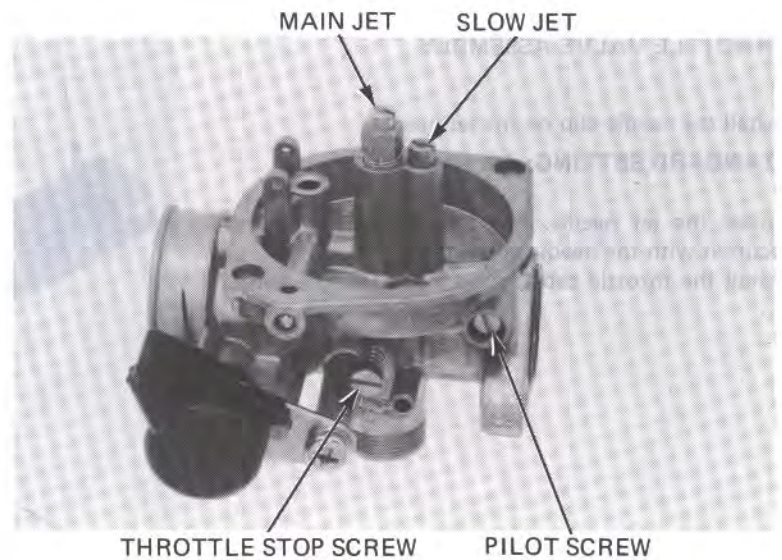



FUEL SYSTEM

FLOAT LEVEL ADJUSTMENT

Measure the float level with a float level gauge as shown.

FLOAT LEVEL: 10.7 mm (0.42 in)

To adjust the level, bend the float arm carefully until the float tip just contacts the float valve.

FLOAT LEVEL GAUGE
07401-0010000

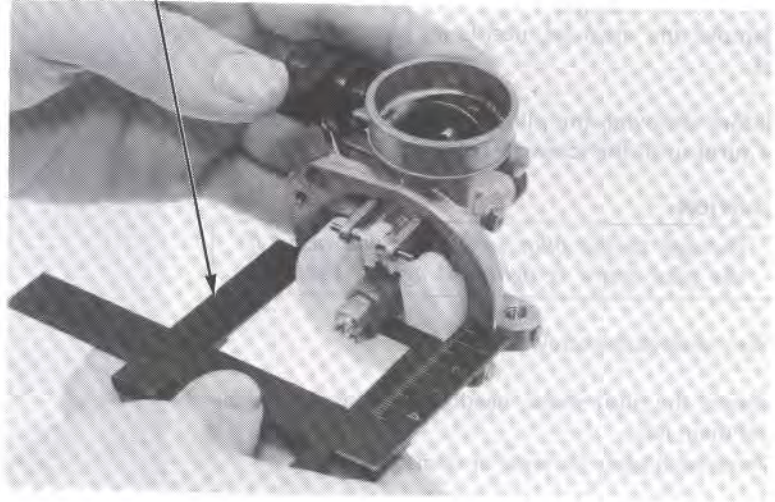

CARBURETOR INSTALLATION

Install the intake pipe, insulator and carburetor.

TORQUE: 6-9 N-m (0.6-0.9 kg-m, 4.5-7 ft-lb)

Install the carburetor in the reverse order of removal.

NOTE:

After installing the carburetor, perform the following adjustments:

- Throttle lever free play (Page 3-9).
- Carburetor pilot screw adjustment (Page 4-9), if the carburetor was overhauled or cleaned.

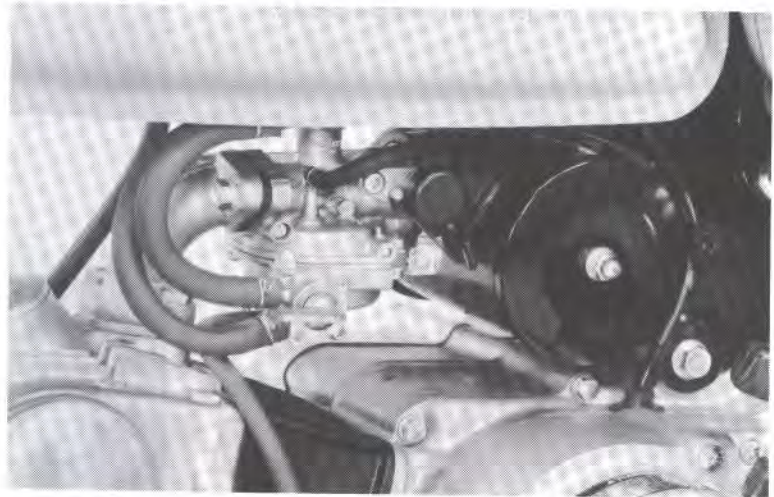

THROTTLE VALVE ASSEMBLY

Install the needle clip on the jet needle.

STANDARD SETTING: 4th groove

Install the jet needle into the throttle valve and secure it with the needle clip retainer.

Install the throttle cable, spring, and throttle valve.

THROTTLE VALVE JET NEEDLE

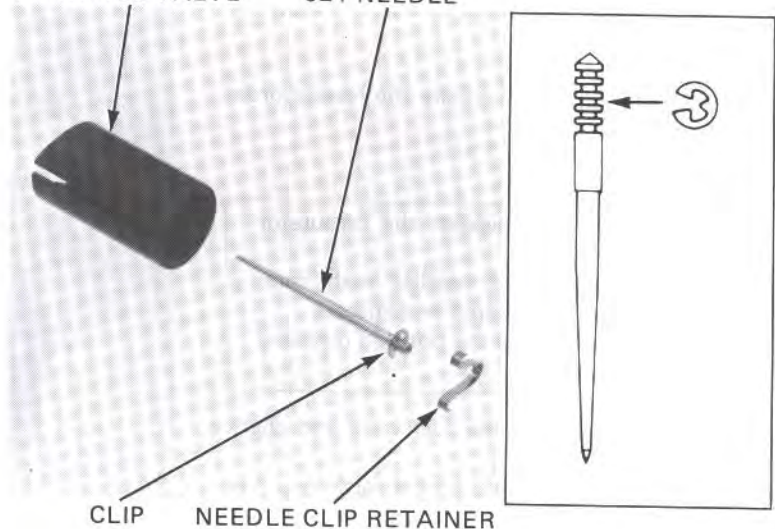



Align the throttle valve groove with the throttle stop screw and install the carburetor top onto the carburetor. Adjust throttle lever free play (Page 3-9).

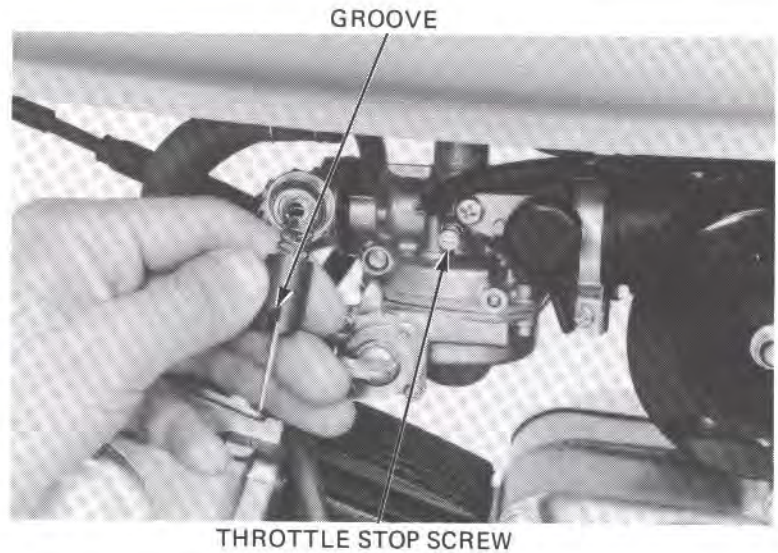

PILOT SCREW ADJUSTMENT

NOTE:

The pilot screw is factory pre-set. Adjustment is not necessary unless the carburetor is overhauled or cleaned.

CAUTION:

Damage to the pilot screw seat will occur if the pilot screw is tightened against the seat.

Turn the pilot screw clockwise until it seats lightly and back it out 1-3/4 turns.

This is an initial setting prior to the final pilot screw adjustment.

Warm the engine up to operating temperature.

Stop the engine and connect a tachometer.

Start the engine and adjust the idle speed with the throttle stop screw.

IDLE SPEED: 1,500 ± 100 rpm

Turn the pilot screw in slowly until the engine stops, and then back it out 1 turn. Start the engine and readjust the idle speed with the throttle stop screw, if necessary.

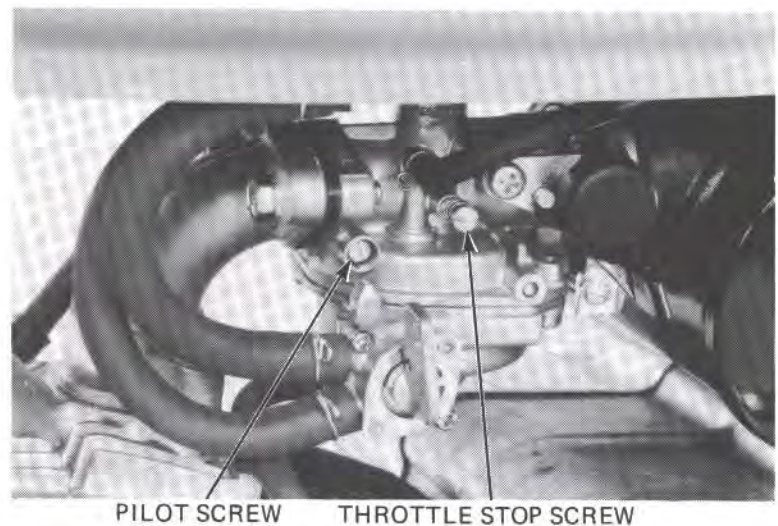

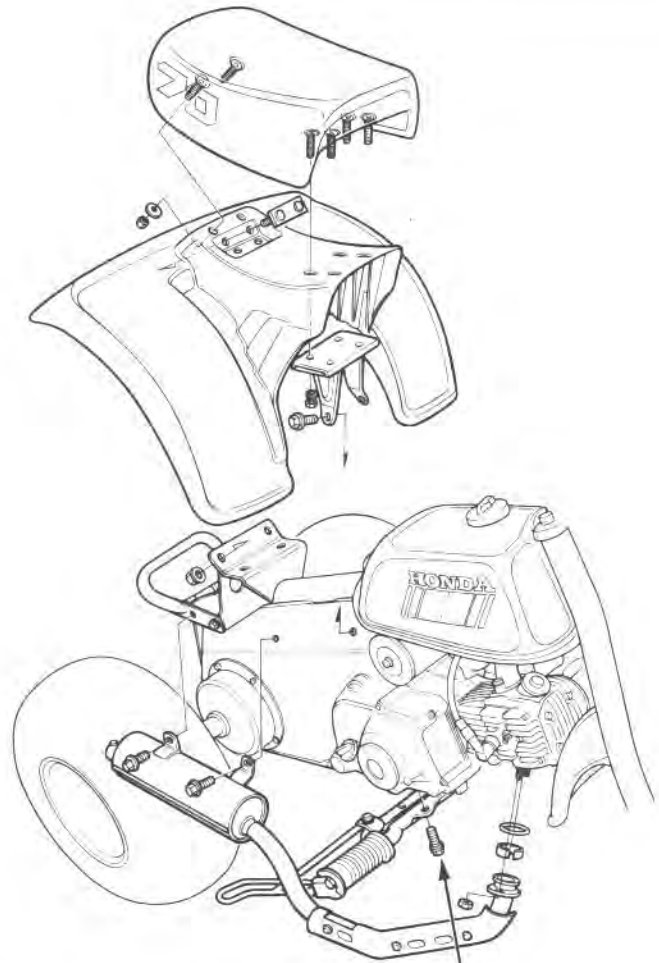

19–25 N·m
(1.9–2.5 kg·m, 14–18 ft·lb)

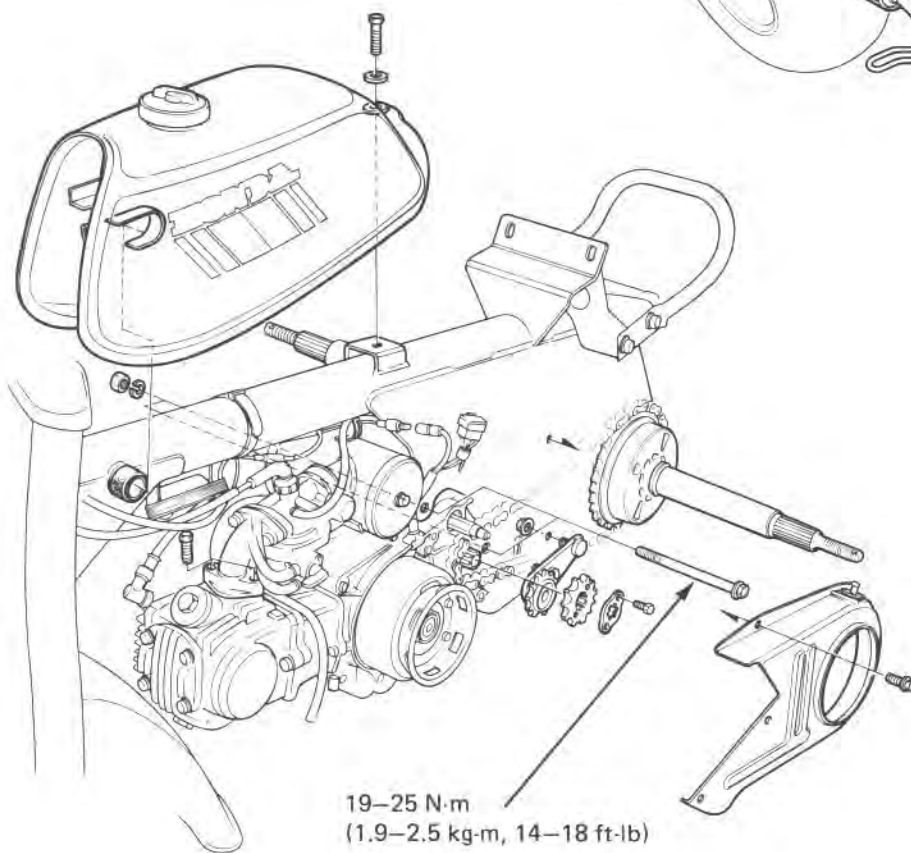

19–25 N·m
(1.9–2.5 kg·m, 14–18 ft·lb)



ENGINE REMOVAL/INSTALLATION

ENGINE REMOVAL

Remove the drive chain cover (Page 12-7).
Remove the recoil starter (Page 9-2).
Remove the left crankcase cover (Page 8-2).

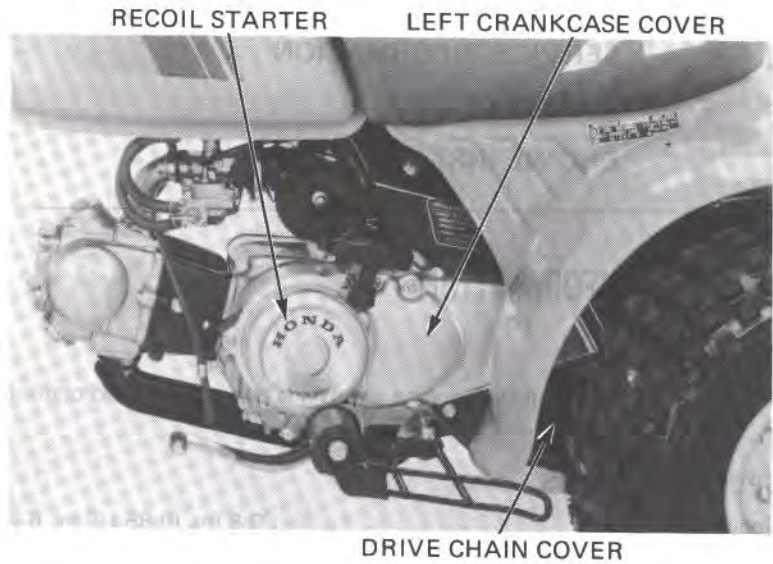

Remove the spark plug cap from the spark plug.
Remove the exhaust pipe (Page 12-11).
Remove the foot peg (Page 12-12).

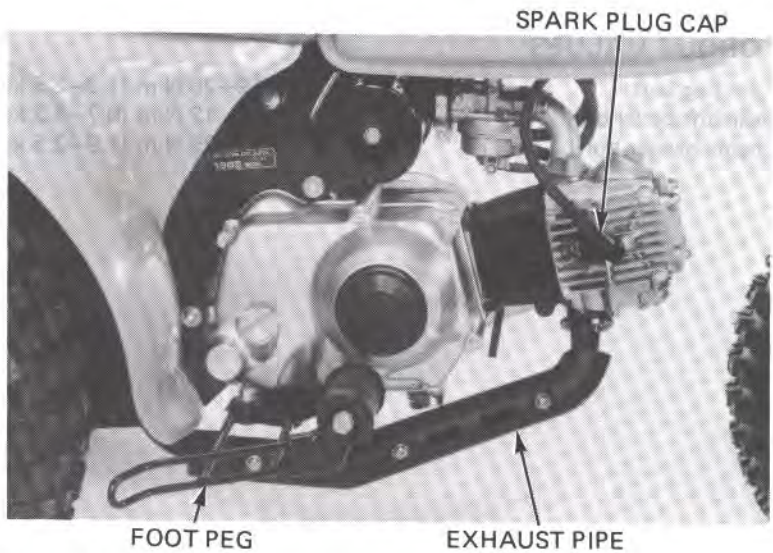

Remove the drive chain (Page 12-7).
Remove the intake pipe mount bolts.
Open the wire clamp and disconnect the wires.

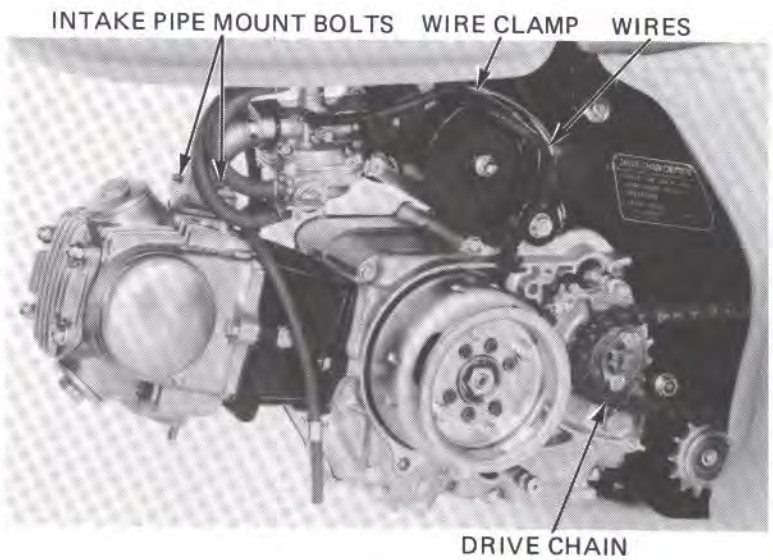



Place the floor jack or other adjustable support under the engine.

Remove the upper and lower engine hanger nuts.
Remove the engine hanger bolts from the left side.

Carefully lower the engine and remove it.

ENGINE UPPER HANGER BOLT/NUT

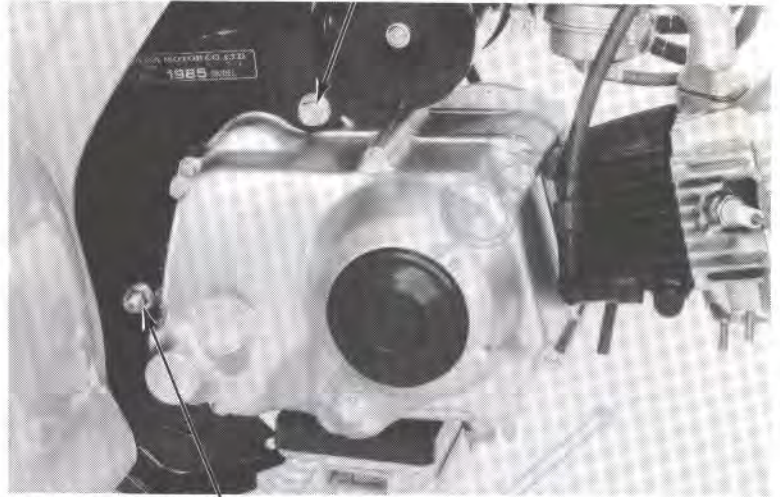

ENGINE LOWER HANGER BOLTS

ENGINE INSTALLATION

Engine installation is essentially the reverse order of removal.

Use a floor jack or other adjustable support to carefully maneuver the engine into place.

Tighten the engine upper and lower hanger bolts.

TORQUE: 19–25 N·m (1.9–2.5 kg-m, 14–18 ft-lb)

Install the foot peg and tighten four bolts.

TORQUE: 19–25 N·m (1.9–2.5 kg-m, 14–18 ft-lb)

Install the gearshift pedal and tighten the bolt.

TORQUE: 7–12 N·m (0.7–1.2 kg-m, 5–9 ft-lb)

Install the intake pipe with new gasket and two bolts and tighten the bolts.

NOTE:

- Route the wires and cables properly (Page 1-8).
- Fill the crankcase to the proper level with the recommended oil (Page 2-1).
- Adjust the throttle lever free play (Page 3-9) and clutch (Page 3-12).



ENGINE HANGER BOLT/NUT

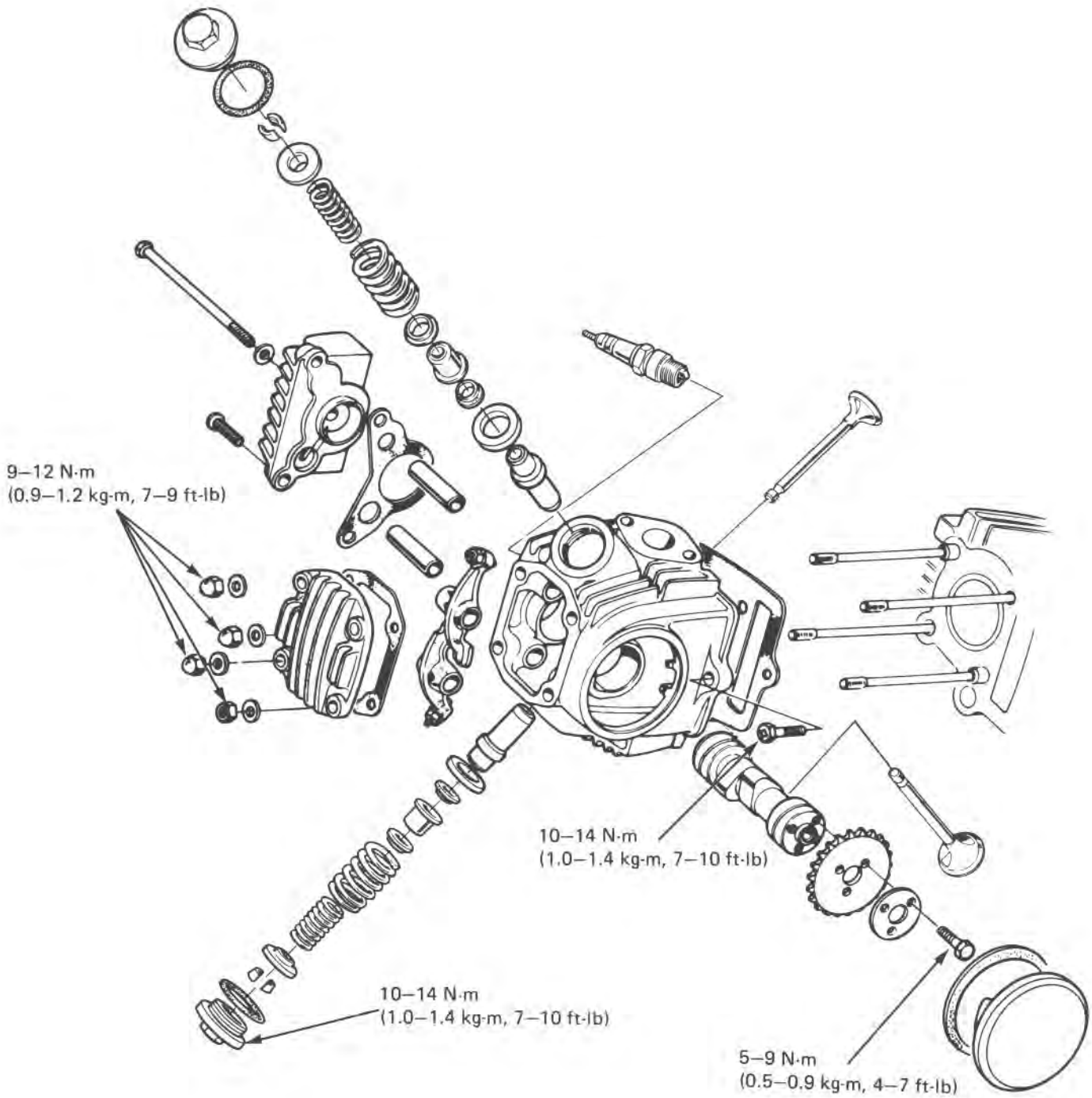



SERVICE INFORMATION	6-1	VALVE GUIDE REPLACEMENT	6-9
TROUBLESHOOTING	6-2	VALVE SEAT INSPECTION/REFACING	6-10
CYLINDER HEAD REMOVAL	6-3	CYLINDER HEAD ASSEMBLY	6-12
CYLINDER HEAD DISASSEMBLY	6-5	CYLINDER HEAD INSTALLATION	6-14

SERVICE INFORMATION

GENERAL

- This section covers maintenance and inspection of the cylinder head, valves, camshaft and rocker arms. These services can be done with the engine installed.
- Camshaft and rocker arm lubricating oil is fed through oil passages. Be sure the passages are not clogged.
- During assembly, apply molybdenum disulfide grease to the camshaft bearings to provide initial lubrication.
- Be sure to use new O-ring and dowel pins when installing the cylinder head.

TOOLS

Special

Valve Guide Reamer 07984-0980000

Common

Valve Guide Remover, 5.5 mm 07742-0010100 or 07942-3290100

Valve Spring Compressor 07757-0010000 or 07957-3290001

TORQUE VALUES

Cylinder head nut	9-12 N·m (0.9-1.2 kg-m, 7-9 ft-lb)
Cam chain sprocket	5-9 N·m (0.5-0.9 kg-m, 4-7 ft-lb)
Valve inspection cap	10-14 N·m (1.0-1.4 kg-m, 7-10 ft-lb)

SPECIFICATIONS

			STANDARD	SERVICE LIMIT
Compression pressure			1,200 ± 150 kPa (12.0 ± 1.5 kg/cm ² , 170.64 ± 21.33 psi)	900 kPa (9.0 kg/cm ² , 127.98 psi)
Camshaft	Cam lobe height	IN	26.07 mm (1.026 in)	25.69 mm (1.011 in)
		EX.	26.07 mm (1.026 in)	25.69 mm (1.011 in)
	Oil clearance		0.010-0.025 mm (0.0004-0.0010 in)	0.05 mm (0.002 in)
	Side clearance		0.004-0.036 mm (0.0002-0.0014 in)	0.10 mm (0.004 in)
Rocker arm shaft O.D.			9.978-9.989 mm (0.3928-0.3933 in)	9.91 mm (0.004 in)
Rocker arm I.D.			10.000-10.015 mm (0.3937-0.3943 in)	10.10 mm (0.398 in)
Valve spring	Free length	Inner	25.1 mm (0.99 in)	23.9 mm (0.94 in)
		Outer	28.1 mm (1.11 in)	26.9 mm (1.06 in)
	Preload/length	Inner	2.45-2.75 kg/22.7 mm (5.401-6.063 lbs/0.89 in)	2.3 kg/22.7 mm (5.07 lbs/0.89 in)
		Outer	6.65-7.75 kg/24.9 mm (14.661-17.086 lbs/0.98 in)	6.3 kg/24.9 mm (13.89 lbs/0.98 in)
Valve guide/ valve	Valve stem O.D.	IN.	5.455-5.465 mm (0.2148-0.2152 in)	5.40 mm (0.213 in)
		EX.	5.435-5.445 mm (0.2140-0.2144 in)	5.40 mm (0.213 in)
	Valve guide I.D.	IN.	5.475-5.485 mm (0.2156-0.2159 in)	5.50 mm (0.217 in)
		EX.	5.475-5.485 mm (0.2156-0.2159 in)	5.50 mm (0.217 in)
	Stem-to-guide clearance	IN.	0.010-0.030 mm (0.0004-0.0012 in)	0.08 mm (0.003 in)
		EX.	0.030-0.050 mm (0.0012-0.0020 in)	0.10 mm (0.004 in)
Valve seat width			1.0 mm (0.04 in)	1.6 mm (0.06 in)
Cylinder head warpage			—	0.05 mm (0.002 in)



TROUBLESHOOTING

Performance problems related to the cylinder head can usually be diagnosed by a compression test, or noise problems which can be traced with a sounding rod or stethoscope.

Low Compression

- Valves
 - Incorrect valve adjustment
 - Burned or bent valves
 - Incorrect valve timing
 - Broken valve spring
- Cylinder head
 - Leaking or damaged head gasket
 - Warped or cracked cylinder head
- Cylinder and piston (Refer to Section 7)

High Compression

- Excessive carbon build-up on piston head or combustion chamber

Excessive Noise

- Incorrect valve adjustment
- Sticking valve or broken valve spring
- Damaged or worn camshaft
- Loose or worn cam chain
- Worn or damaged cam chain tensioner
- Worn cam sprocket teeth



CYLINDER HEAD REMOVAL

Remove the recoil starter (Page 9-2).
Turn the flywheel counterclockwise and align the T mark with the index mark.
Remove the cam chain tensioner sealing bolt (Page 9-9).

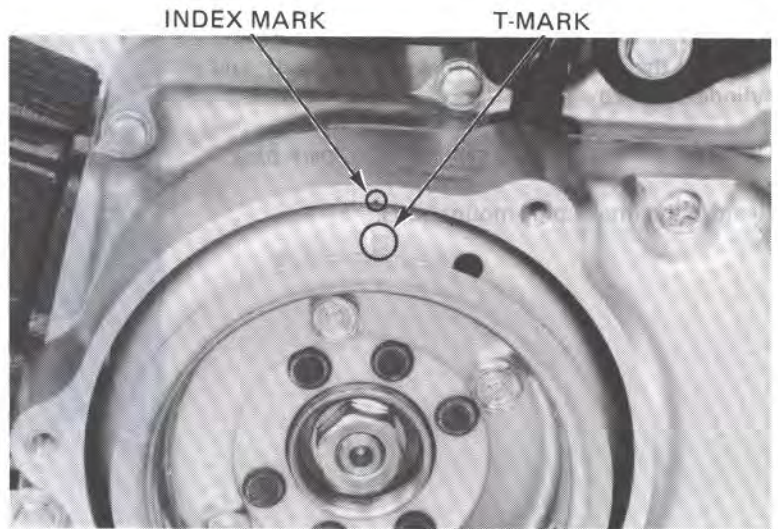

Remove the front fender.
Remove the cam sprocket cover bolt and cover from the left side of the cylinder head.

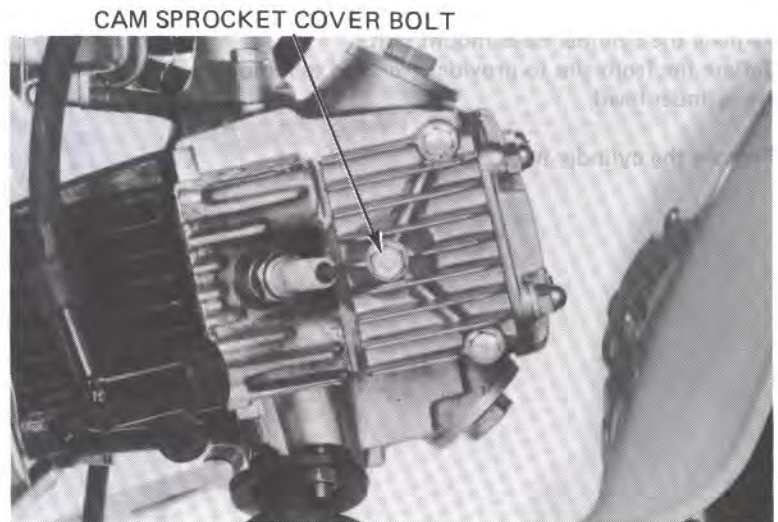

Hold the flywheel and remove the three attaching bolts and the cam sprocket.

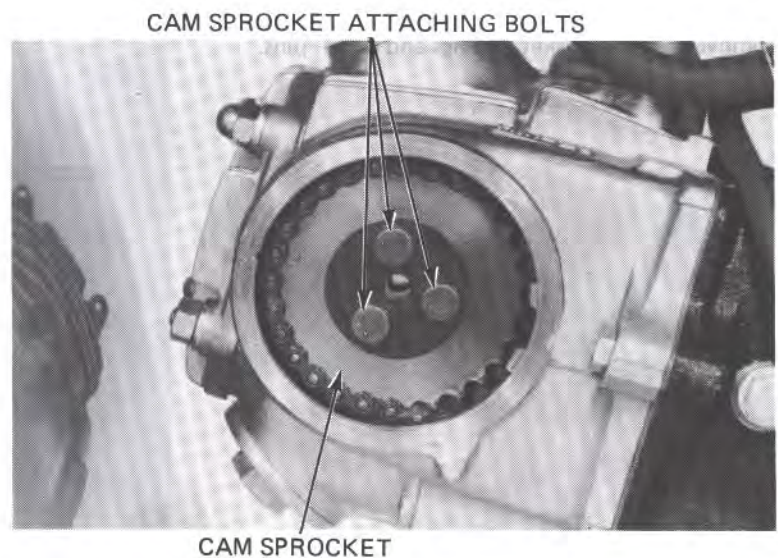



CYLINDER HEAD/VALVE

Remove the exhaust pipe (Page 12-11).
Remove the four cylinder head cover nuts and cylinder head cover.

Disconnect the spark plug cap from the spark plug.

Remove the intake pipe mount bolts.

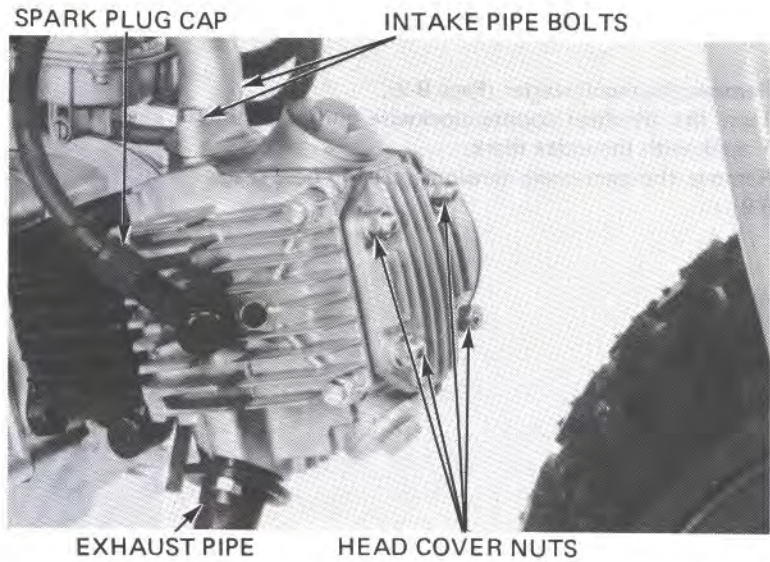

Remove the cylinder head mount bolt.
Deflate the front tire to provide clearance to remove the cylinder head.

Remove the cylinder head.

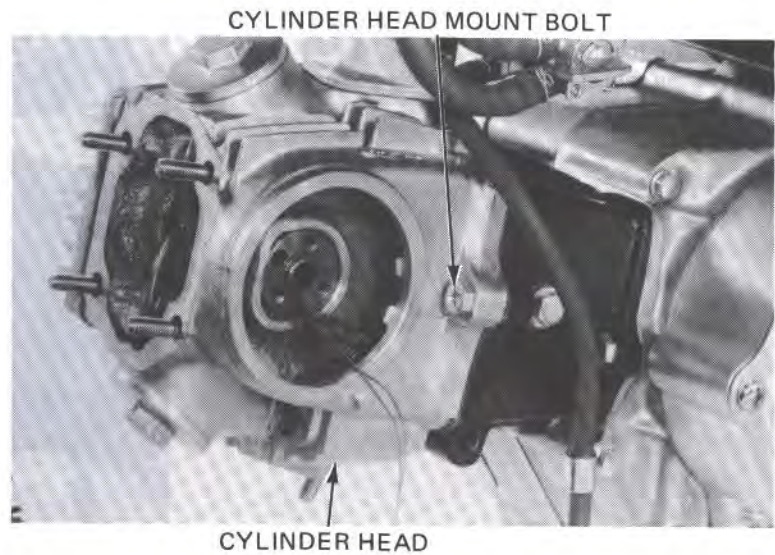

Remove the head gasket, O-rings and dowel pins.

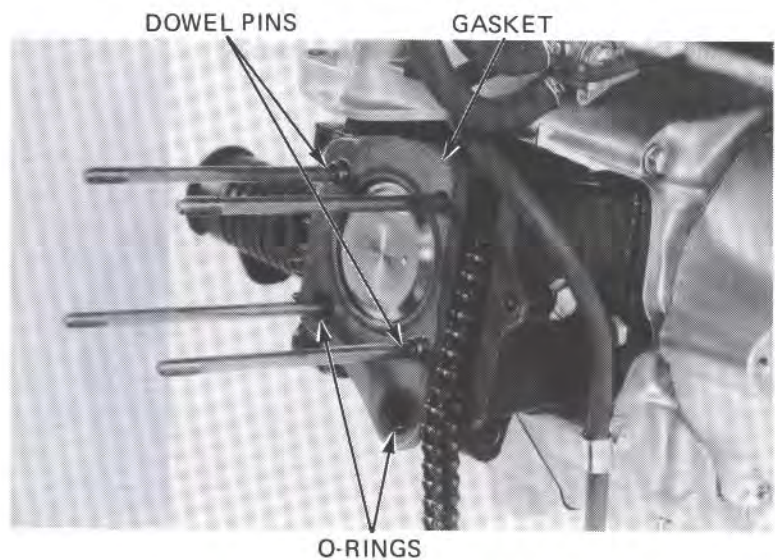



CYLINDER HEAD DISASSEMBLY

Remove the cylinder head side cover and gasket.

Remove the valve inspection caps and O-rings.



Screw an 8 mm bolt into the rocker arm shafts and pull the shafts out of the cylinder head.

Remove the rocker arms.

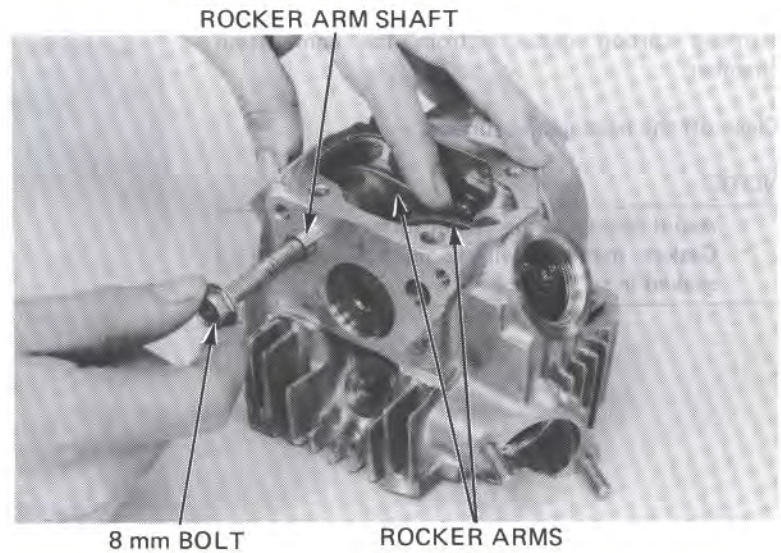

Remove the camshaft aligning the cam lobes with the cylinder head cutouts.

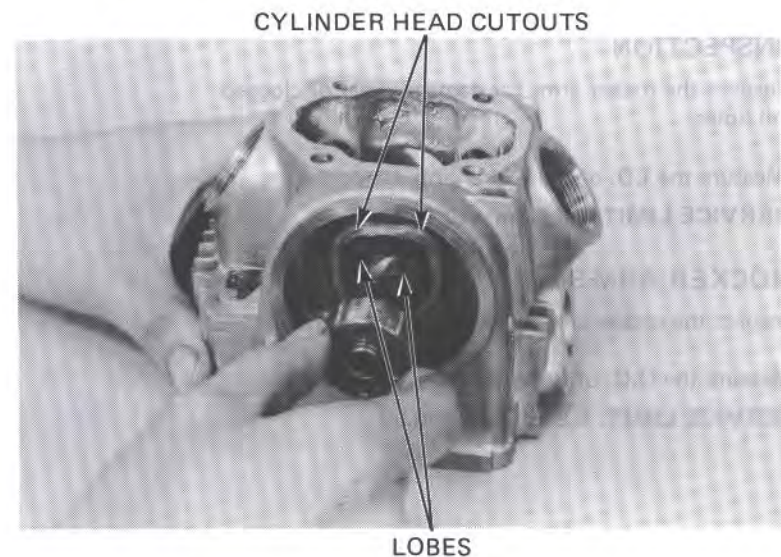



CYLINDER HEAD/VALVE

Remove the valve spring cotters, retainers, springs and valves.

CAUTION:

To prevent loss of tension, do not compress the valve springs more than necessary to remove the cotters.

Remove valve spring seats, stem seal caps and stem seals.

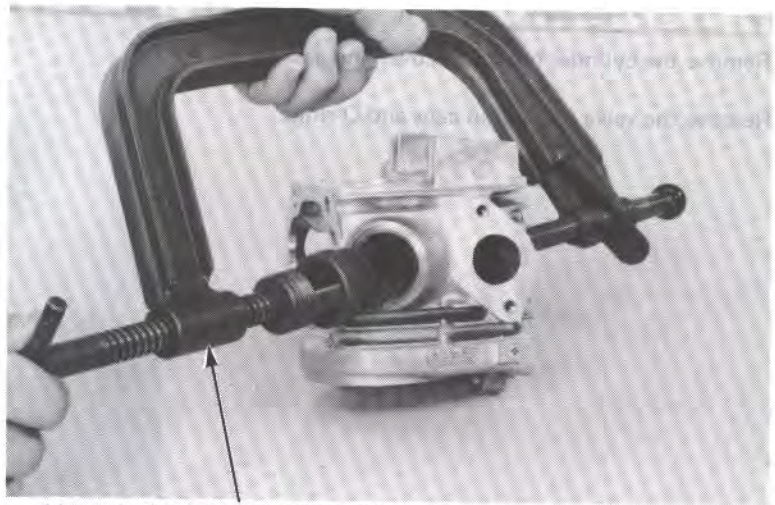

VALVE SPRING COMPRESSOR
07757-0010000 or 07957-3290001

Remove carbon deposits from the combustion chamber.

Clean off the head gasket surface.

NOTE:

- Avoid damaging the gasket surface.
- Gasket material will come off easier if soaked in solvent.

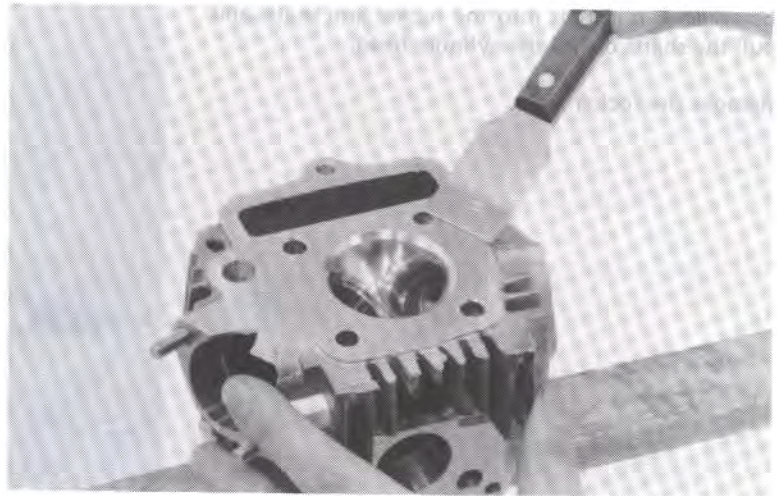

INSPECTION

Inspect the rocker arms for damage, wear or clogged oil holes.

Measure the I.D. of the rocker arm.

SERVICE LIMIT: 10.10 mm (0.398 in)

ROCKER ARM SHAFT INSPECTION

Inspect the rocker arm shaft for wear or damage.

Measure the O.D. of the rocker arm shaft.

SERVICE LIMIT: 9.91 mm (0.390 in)

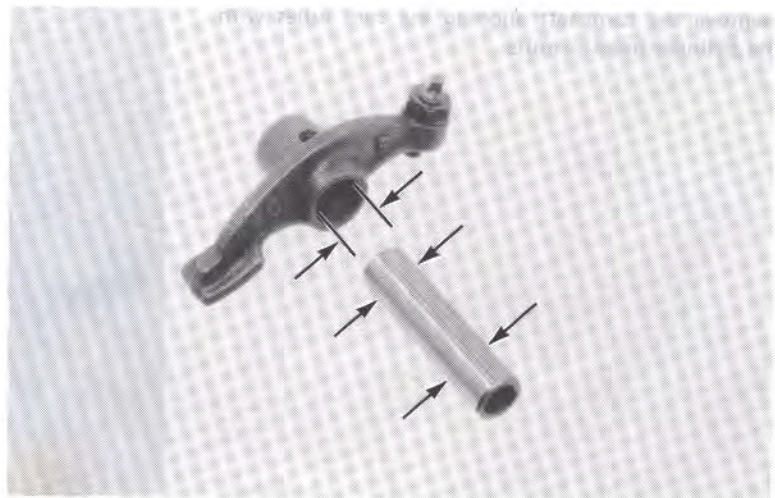



Using a micrometer, measure the cam lobes.
Check for wear or damage.

SERVICE LIMIT: 25.69 mm (1.011 in)

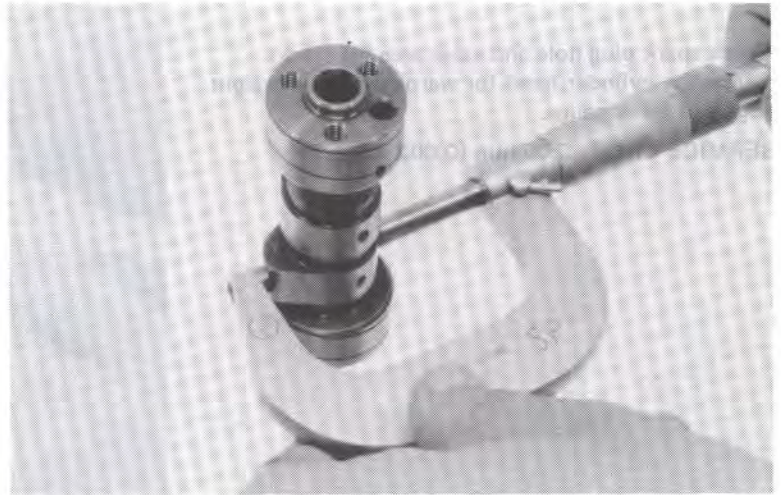

Measure and record the camshaft journal O.D.
Measure and record the camshaft bearing I.D. in the
cylinder head.
Determine the camshaft bearing oil clearance.

SERVICE LIMIT: 0.05 mm (0.002 in)

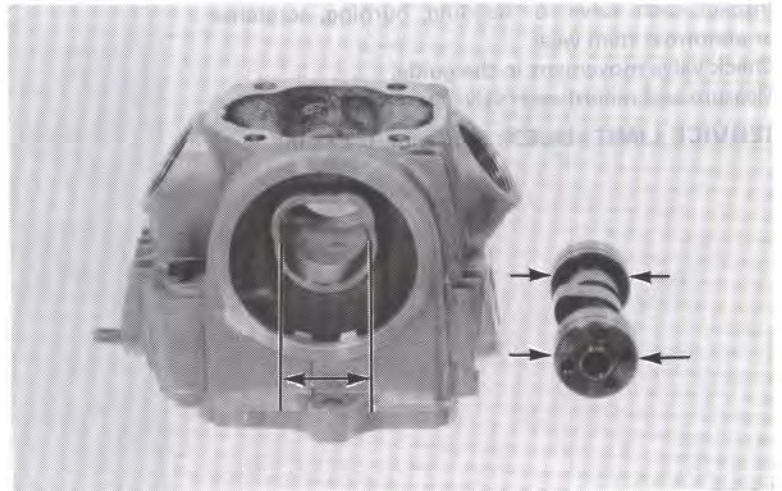

Measure the length of the inner and outer valve
springs.

SERVICE LIMIT:

Inner: 23.9 mm (0.94 in)

Outer: 26.9 mm (1.06 in)

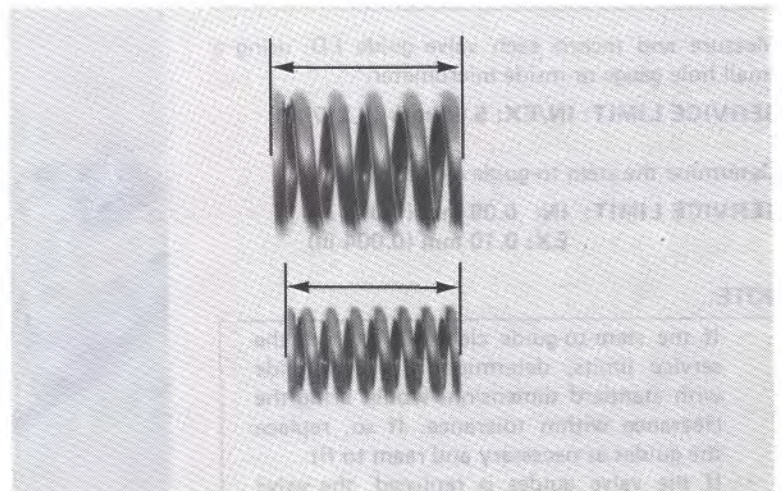



CYLINDER HEAD/VALVE

Check spark plug hole and valve area for cracks.
Check the cylinder head for warpage with a straight edge and feeler gauge.

SERVICE LIMIT: 0.05 mm (0.002 in)

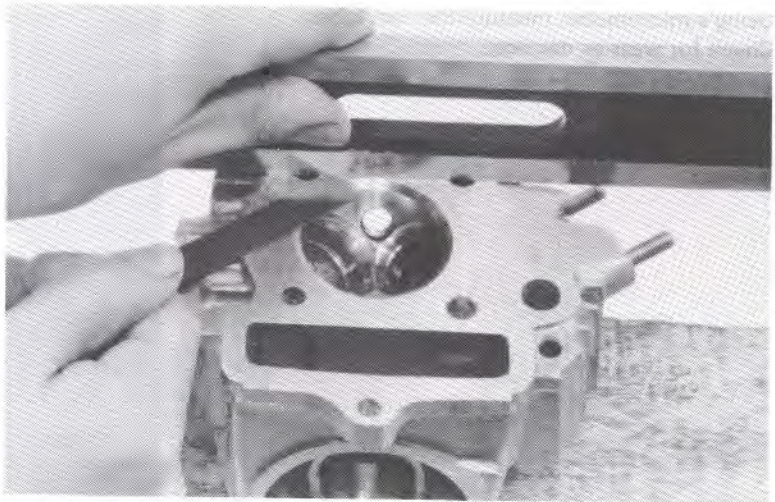

Inspect each valve for bending, burning, scratches or abnormal stem wear.

Check valve movement in the guide.

Measure and record each valve stem O.D.

SERVICE LIMIT: IN/EX: 5.40 mm (0.213 in)

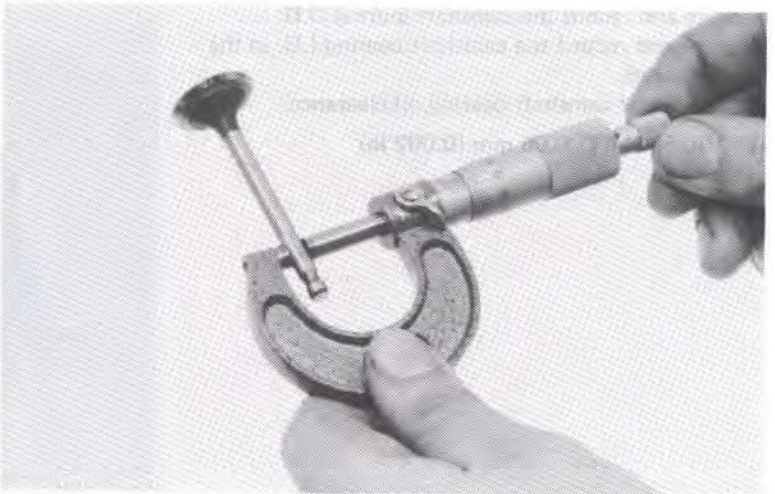

NOTE:

Ream the guide to remove any carbon build-up before checking the valve guide I.D.

VALVE GUIDE REAMER
07984-0980000

Measure and record each valve guide I.D. using a small hole gauge or inside micrometer.

SERVICE LIMIT: IN/EX: 5.50 mm (0.217 in)

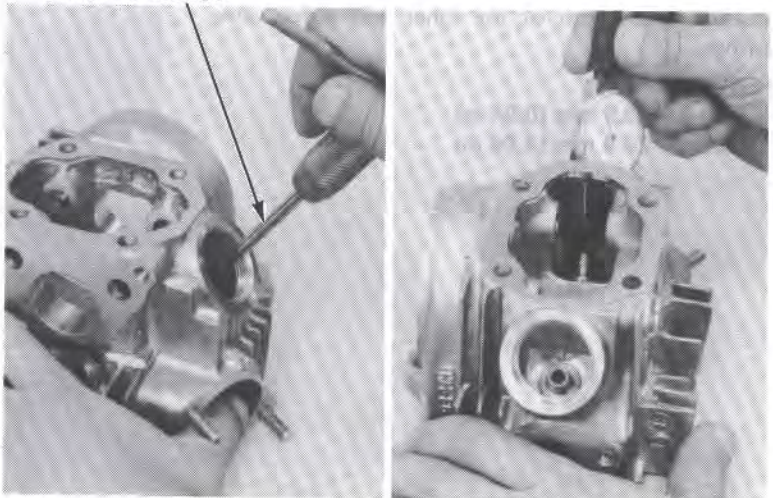

Determine the stem-to-guide clearance.

SERVICE LIMIT: IN: 0.08 mm (0.003 in)
EX: 0.10 mm (0.004 in)

NOTE:

- If the stem-to-guide clearance exceeds the service limits, determine if a new guide with standard dimensions would bring the clearance within tolerance. If so, replace the guides as necessary and ream to fit.
- If the valve guides is replaced, the valve seat must be refaced.



VALVE GUIDE REPLACEMENT

Support the cylinder head and drive the guide out from the port side.

NOTE:

When driving out the valve guide, do not damage the head.

VALVE GUIDE REMOVEER
07742-0010100 or 07942-3290100

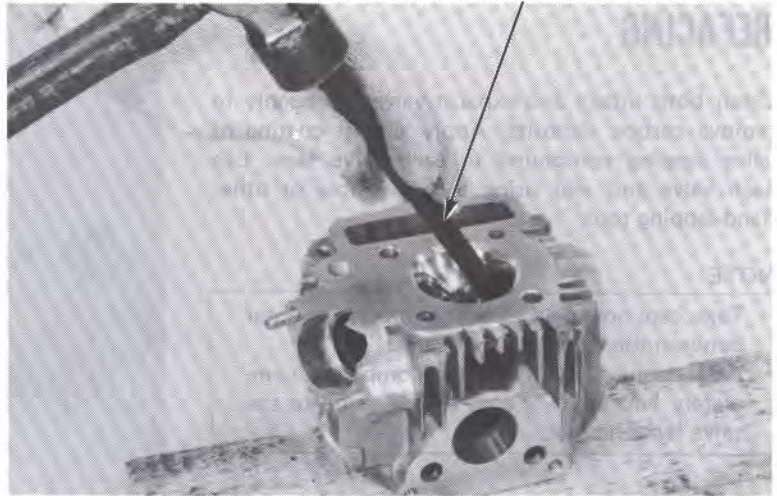

Install a new oversize valve guide from the top of the head.

VALVE GUIDE DRIVER
07742-0010100 or 07942-3290100

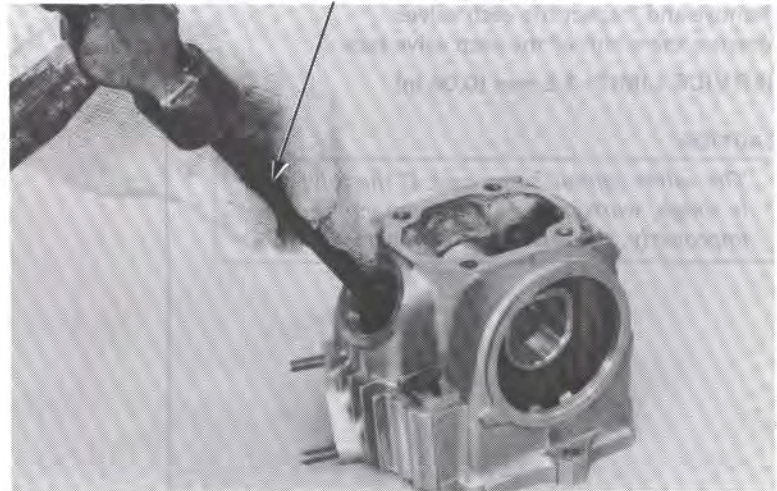

Ream the new valve guide after installation.

NOTE:

- Use cutting oil on the reamer during this operation.
- Rotate the reamer in the same direction when inserting and removing it.

Reface the valve seat (Page 6-10).
Clean the cylinder head thoroughly to remove any metal particles.

VALVE GUIDE REAMER
07984-0980000

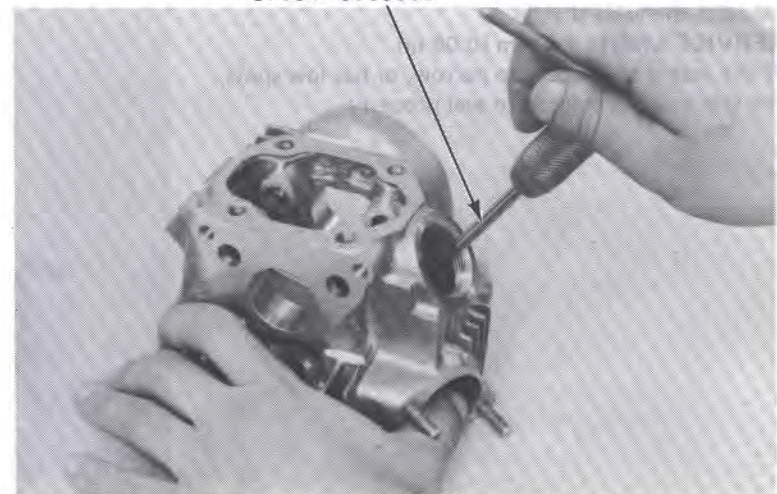



CYLINDER HEAD/VALVE

**VALVE SEAT INSPECTION/
REFACING**

Clean both intake and exhaust valve thoroughly to remove carbon deposits. Apply a light coating of valve lapping compound to each valve face. Lap each valve and seat using a rubber hose or other hand-lapping tool.

NOTE:

Take care not to allow the compound to enter between the valve stem and guide.
After lapping, wash out the compound completely and apply a coat of engine oil to the valve face and seat.

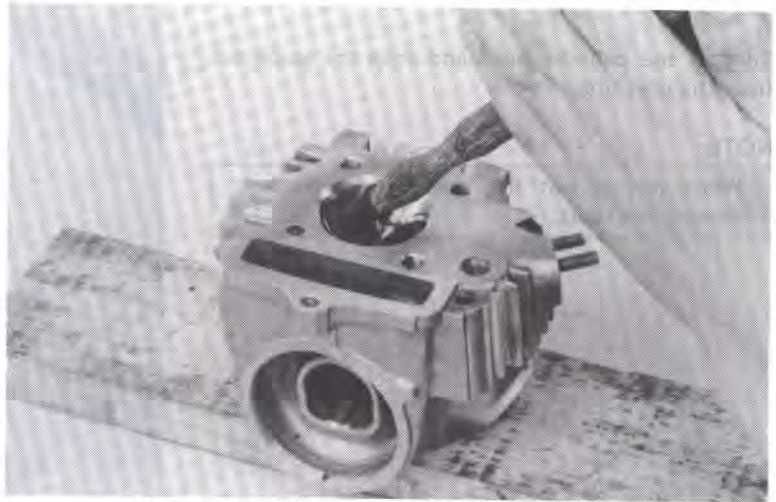

Remove and inspect the each valves.
Measure the width of the each valve face.

SERVICE LIMIT: 1.6 mm (0.06 in)

CAUTION:

The valves cannot be ground. If the valve face is rough, worn unevenly, or contacts the seat improperly, the valve must be replaced.

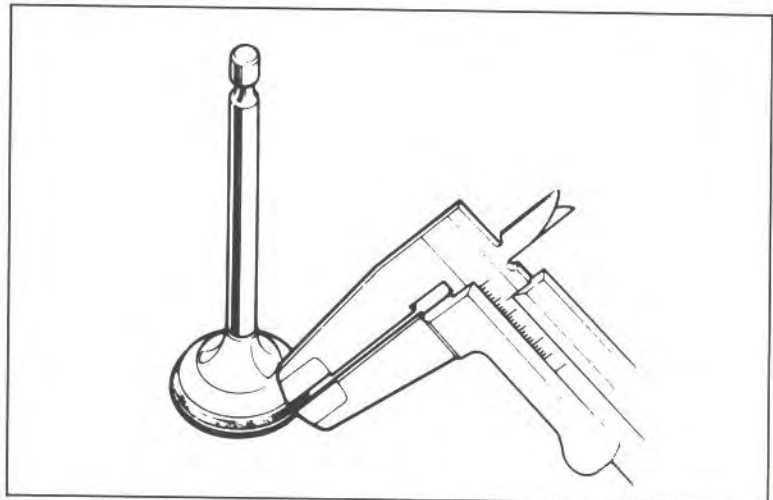

Measure the valve seat.

SERVICE LIMIT: 1.6 mm (0.06 in)

If the seat is too wide, too narrow, or has low spots, the seat must be refaced to seal properly.

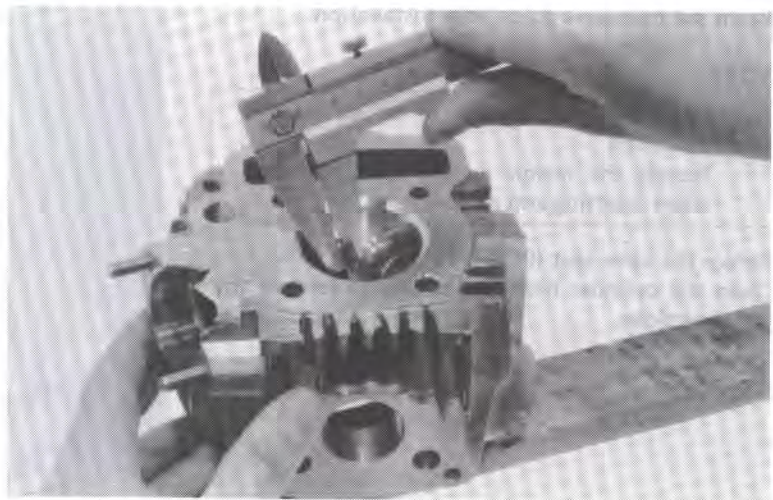



VALVE SEAT GRINDING

Use a 45 degree cutter to remove any roughness or irregularities from seat.

NOTE:

Reface the seat with a 45 degree cutter when the valve guide is replaced.

Use a 32 degree cutter to remove 1/4 of the existing valve seat material.

NOTE:

Follow the instructions supplied with the Valve Seat Refacing Equipment.

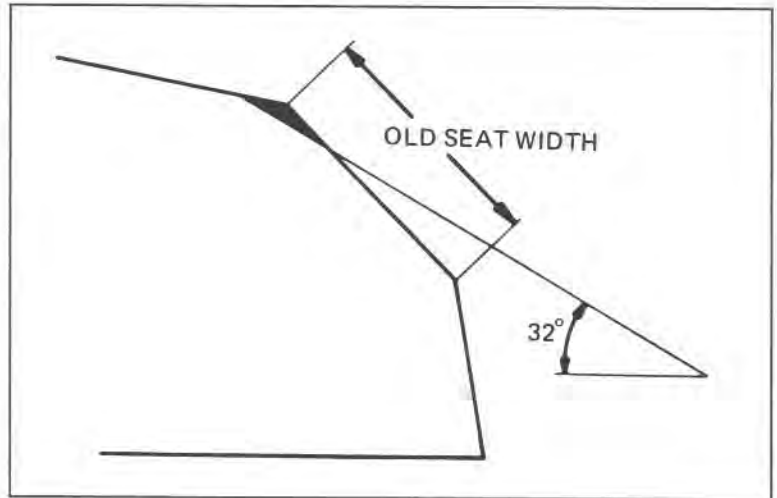

Use a 60 degree cutter to remove the lower 1/4 of the old seat. Remove the cutter and inspect the area you have just cut.

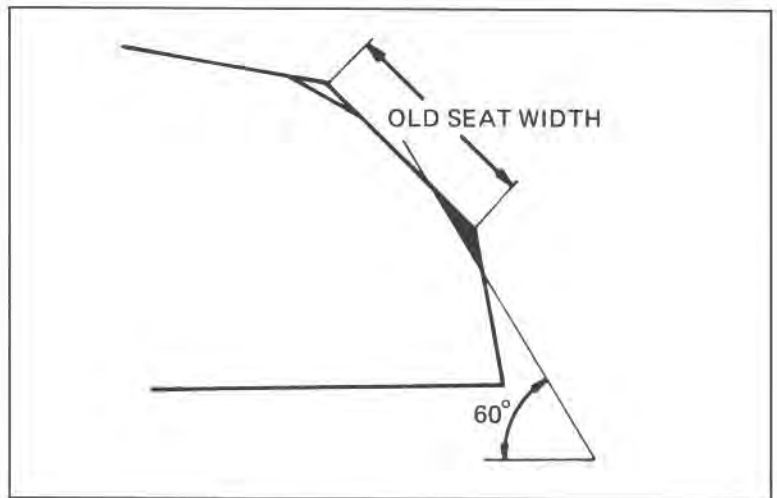

Install a 45 degree finish cutter and cut the seat to the proper width.

NOTE:

Make sure that all pitting and irregularities are removed. Refinish if necessary.

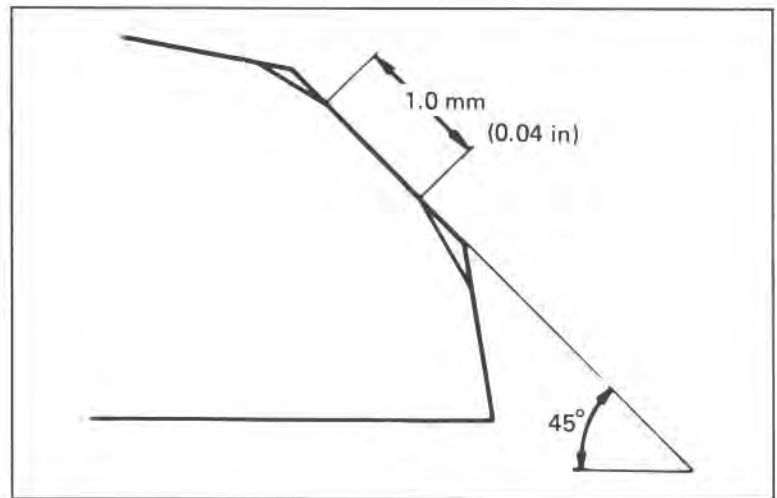



CYLINDER HEAD/VALVE

Apply a thin coating of Prussian Blue to the valve seat.

Without rotating the valve, insert the valve through the valve guide and onto the seat to make a clear pattern.

NOTE:

The location of the valve seat in relation to the valve face is very important for good sealing.

If the contact area is too high on the valve, the seat must be lowered using a 32 degree flat cutter.

If the contact area is too low on the valve, the seat must be raised using a 60 degree inner cutter.

Refinish the seat to specifications using a 45 degree seat cutter.

After cutting the seat, apply lapping compound to the valve face and lap the valve using light pressure.

NOTE:

Take care not to allow the compound to enter between the valve stem and guide.

After lapping, wash all residual compound off the cylinder head and valve.

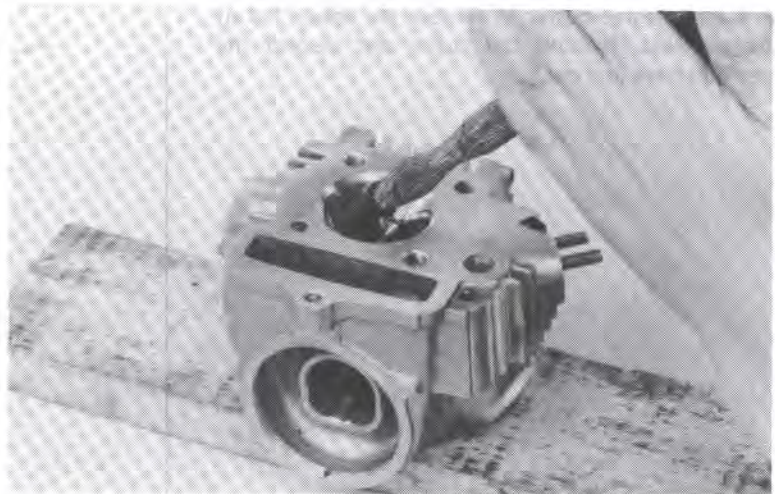
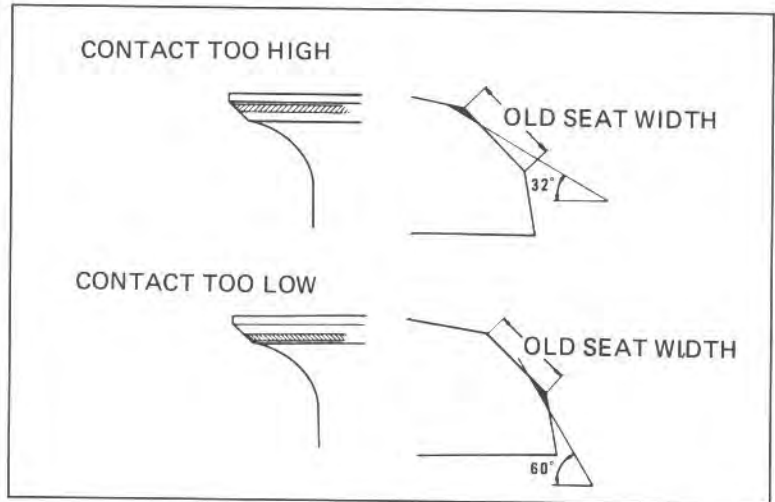

CYLINDER HEAD ASSEMBLY

Install new valve stem seals.

Lubricate each valve stem with molybdenum disulfide grease and insert the valve into the valve guide.

NOTE:

- Install the new valve stem seals when assembly.
- To avoid damage to the stem seal, turn the valve slowly when inserting.

Install the valve springs and retainers.

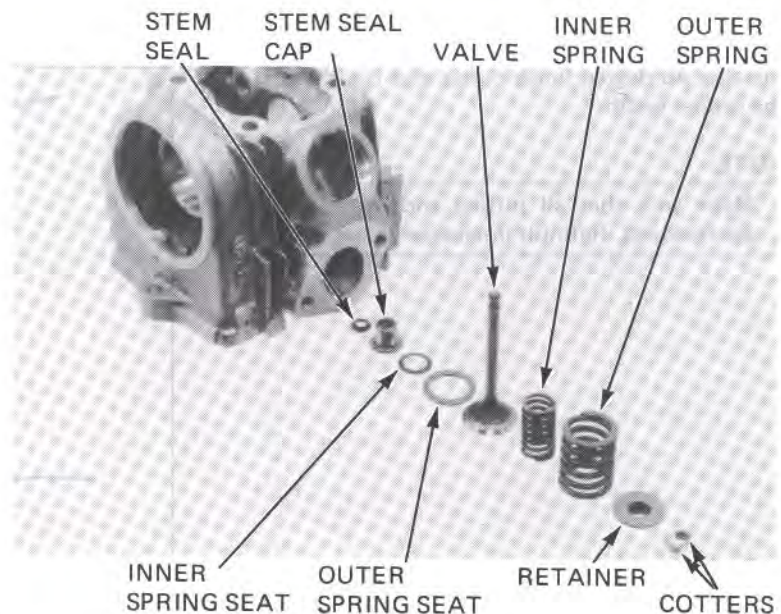



Install the valve cotters.

CAUTION:

To prevent tension loss, do not compress the valve spring more than necessary to install the valve cotters.

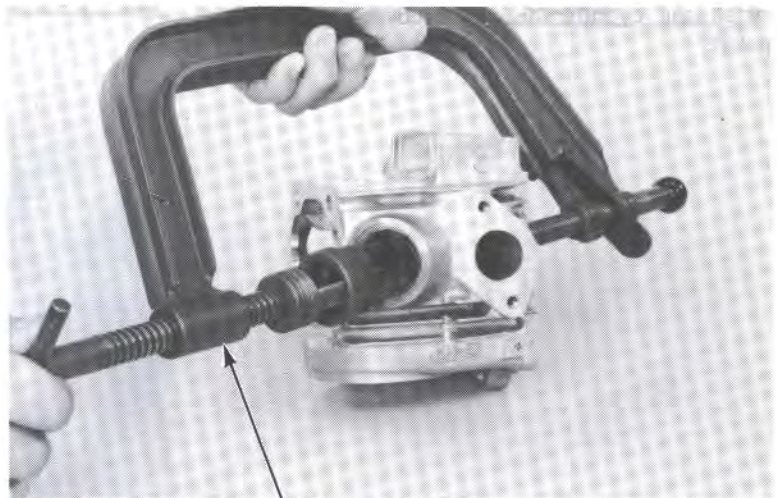

VALVE SPRING COMPRESSOR
07757-0010000 or 07957-3290001

Tap the valve stem gently with a soft hammer to firmly seat the valve cotters.

CAUTION:

Support the cylinder head above the work bench surface to prevent possible valve damage.

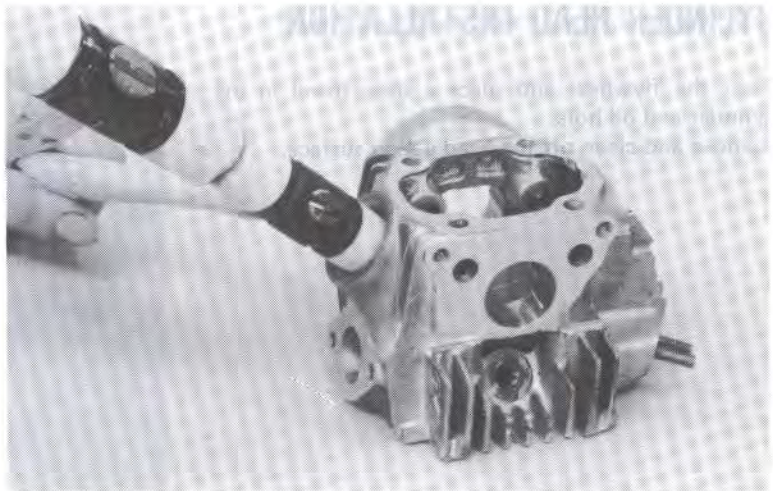

Install the camshaft with the camshaft hole facing down for easy camshaft sprocket installation.

Apply a thin coat of engine oil to the rocker arm shafts.

Install the rocker arms and shafts with the threaded ends facing out.

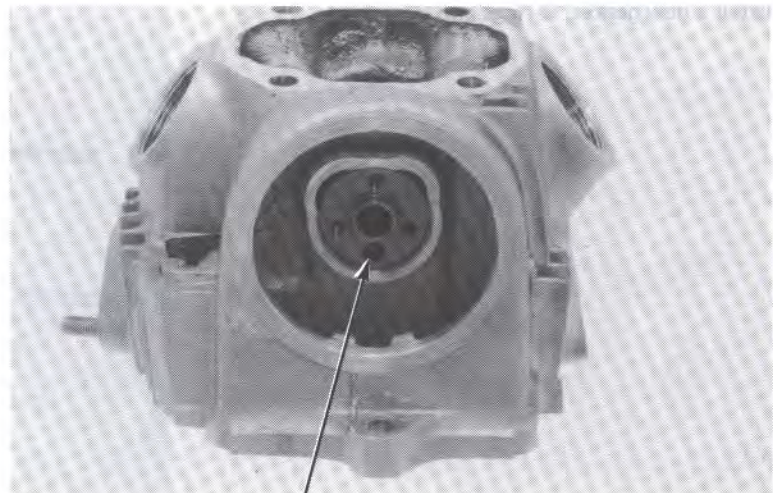

CAMSHAFT HOLE



CYLINDER HEAD/VALVE

Install the cylinder head side cover using a new gasket.

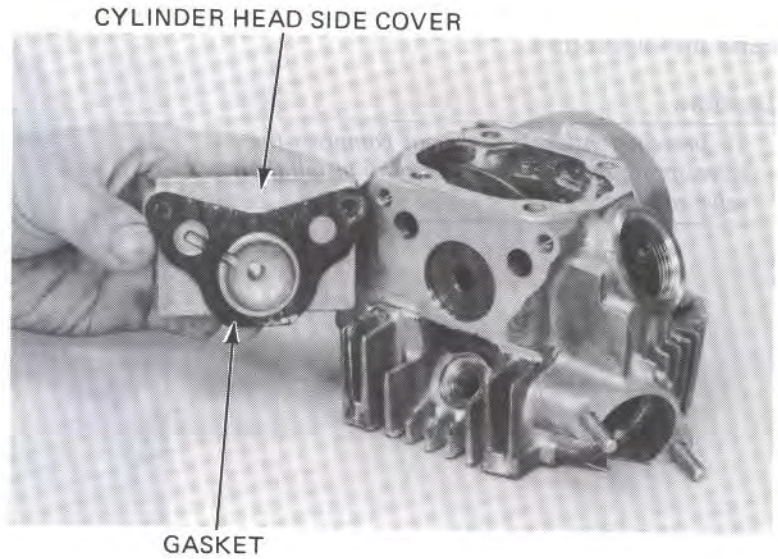

CYLINDER HEAD INSTALLATION

Turn the flywheel and place a shop towel in the cylinder and oil hole.
Remove and clean off the head gasket surface.

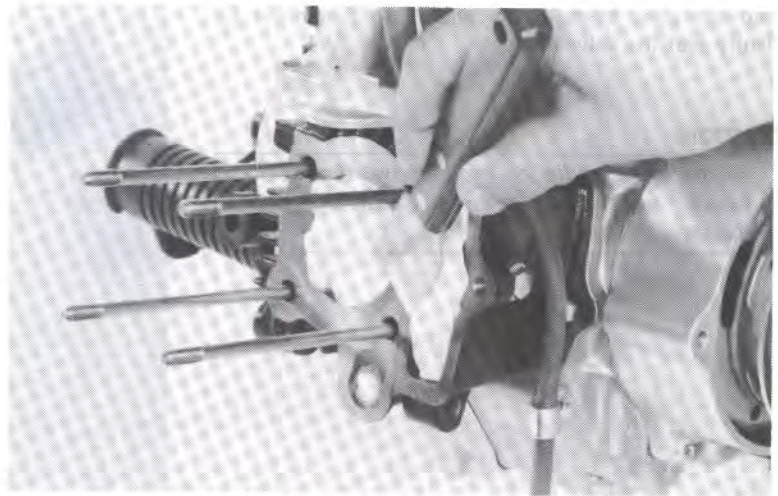

Install a new gasket, O-rings and dowel pins.

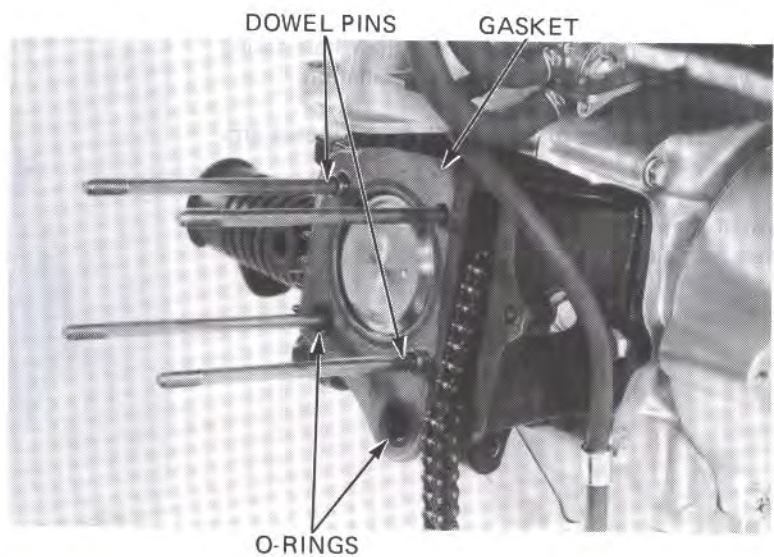



Install the cylinder head.

Tighten the cylinder head mount bolt.

TORQUE: 10–14 N·m (1.0–1.4 kg-m, 7–10 ft-lb)

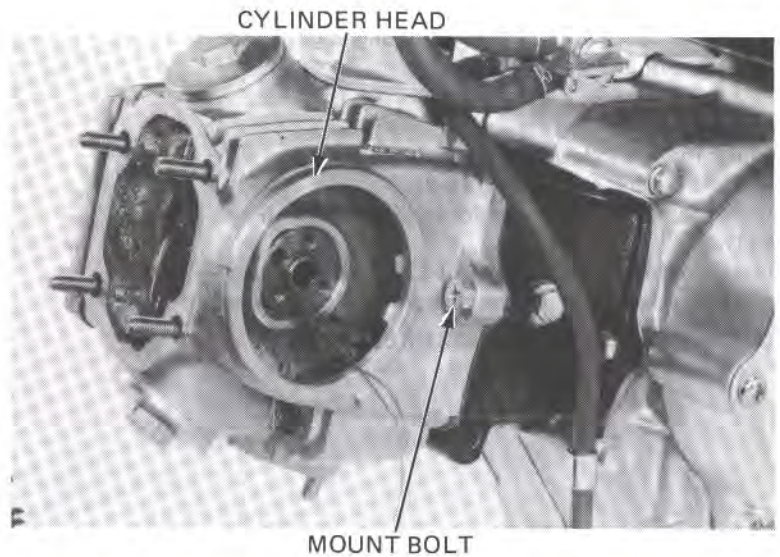

Install the cylinder head cover with the arrow facing down (exhaust pipe side).

NOTE:

Be sure to installing the sealing washers, copper washer, cap nuts and nut on the cylinder head cover as shown.

Tighten the cylinder head nuts and bolt in a criss-cross pattern in 2–3 steps.

TORQUE: 9–12 N·m (0.9–1.2 kg-m, 7–9 ft-lb)

Install the intake pipe mount bolts (Page 4-8).
Install the exhaust pipe (Page 12-11).

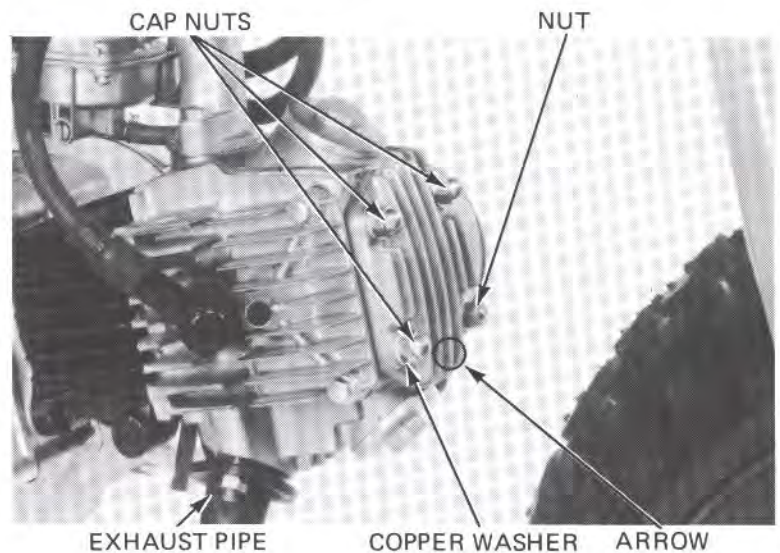

Turn the flywheel counterclockwise and align the T mark with the index mark.

Place the cam chain over the camshaft sprocket aligning the O-mark on the camshaft sprocket with the index mark on the cylinder head.

Install the camshaft sprocket.

Hold the flywheel and tighten the cam sprocket bolts.

TORQUE: 5–9 N·m (0.5–0.9 kg-m, 4–7 ft-lb)

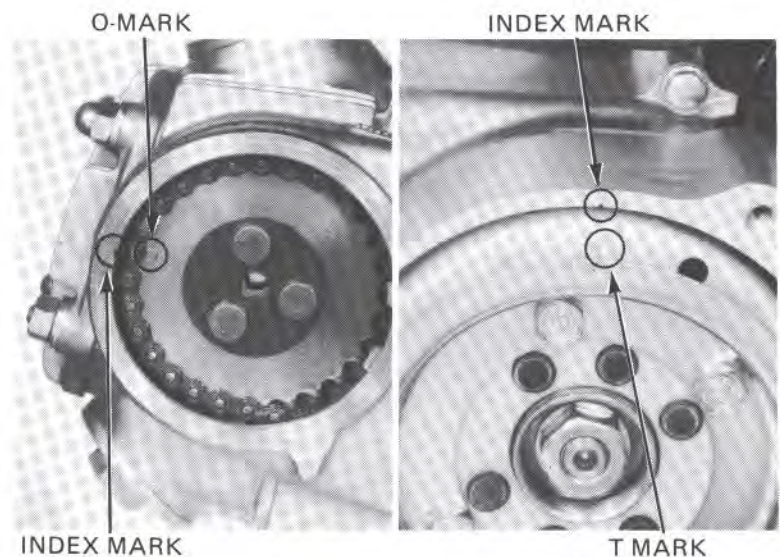



CYLINDER HEAD/VALVE

Install the camshaft sprocket cover aligning the tang with the cylinder head notch.

Install the spark plug cap.

Adjust the valve clearance (Page 3-7).

Install the recoil starter (Page 9-6).

Install the cam chain tensioner sealing bolt (Page 9-11).

Install the front fender (Page 11-12).

Inflate the front tire to the recommended pressure.

RECOMMENDED TIRE PRESSURE:

2.2 psi (15 kPa, 1.5 kg-cm²)



HONDA
ATC70

MEMO



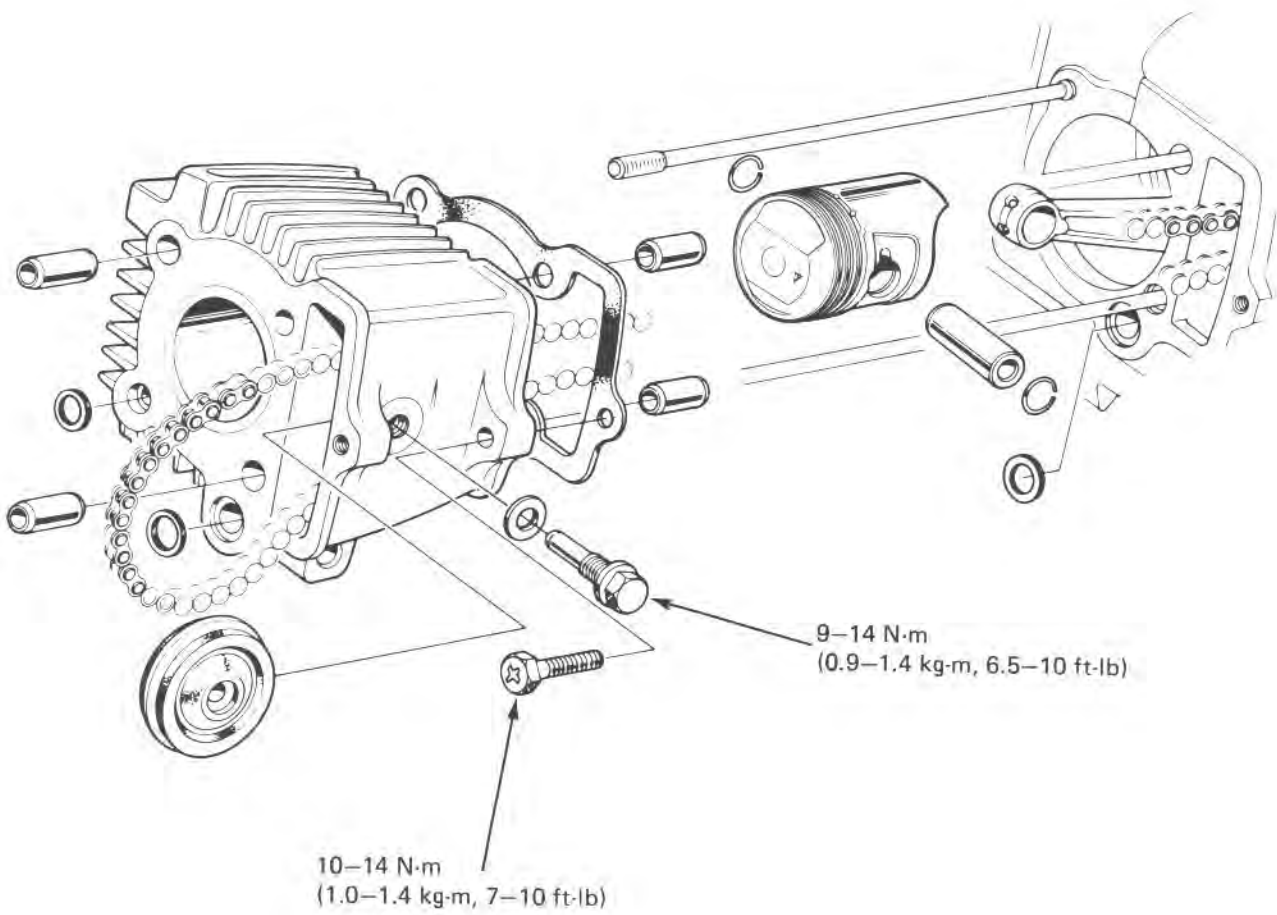



SERVICE INFORMATION	7-1	PISTON REMOVAL	7-3
TROUBLESHOOTING	7-1	PISTON INSTALLATION	7-6
CYLINDER REMOVAL	7-2	CYLINDER INSTALLATION	7-6

SERVICE INFORMATION

GENERAL

- Cylinder/piston maintenance and inspection can be performed with the engine installed.
- Camshaft and rocker arm lubricating oil is fed through cylinder oil passages. Be sure the passages are not clogged.

SPECIFICATIONS

ITEM		STANDARD	SERVICE LIMIT	
Cylinder	I.D.	47.005–47.015 mm (1.8506–1.8510 in)	47.05 mm (1.852 in)	
Piston, piston rings and piston pin	Piston ring-to-ring groove clearance	TOP	0.015–0.045 mm (0.0006–0.0018 in)	
		SECOND	0.015–0.045 mm (0.0006–0.0018 in)	
	Ring end gap	TOP	0.15–0.35 mm (0.006–0.014 in)	
		SECOND	0.15–0.35 mm (0.006–0.014 in)	
		OIL	0.15–0.40 mm (0.006–0.016 in)	
	Piston O.D.		46.98–47.00 mm (1.850–1.8504 in)	46.90 mm (1.847 in)
	Piston pin bore		13.002–13.008 mm (0.5119–0.5121 in)	13.06 mm (0.51 in)
	Connecting rod small end I.D.		13.013–13.043 mm (0.5123–0.5135 in)	13.1 mm (0.52 in)
	Piston pin O.D.		12.994–13.000 mm (0.5116–0.5118 in)	12.98 mm (0.511 in)
Piston-to-piston pin clearance		0.002–0.014 mm (0.0001–0.0006 in)	0.075 mm (0.0030 in)	
Cylinder-to-piston clearance		0.005–0.035 mm (0.0002–0.0014 in)	0.15 mm (0.006 in)	

TORQUE VALUES

- | | |
|-----------------------|---------------------------------------|
| Guide roller pin bolt | 9–14 N·m (0.9–1.4 kg-m, 6.5–10 ft-lb) |
| Cylinder mount bolt | 10–14 N·m (1.0–1.4 kg-m, 7–10 ft-lb) |

TROUBLESHOOTING

Compression low

- Worn cylinder or piston rings

Excessive smoke

- Worn cylinder or piston rings
- Improper installation of piston rings
- Scored or scratched piston or cylinder wall

Overheating

- Excessive carbon build-up on the piston or combustion chamber wall

Knocking or abnormal noise

- Worn piston and cylinder
- Excessive carbon build-up



CYLINDER/PISTON

CYLINDER REMOVAL

- Remove the cylinder head (Section 6).
- Remove the cylinder mount bolt.
- Remove the guide roller pin and guide roller.
- Remove the cylinder.

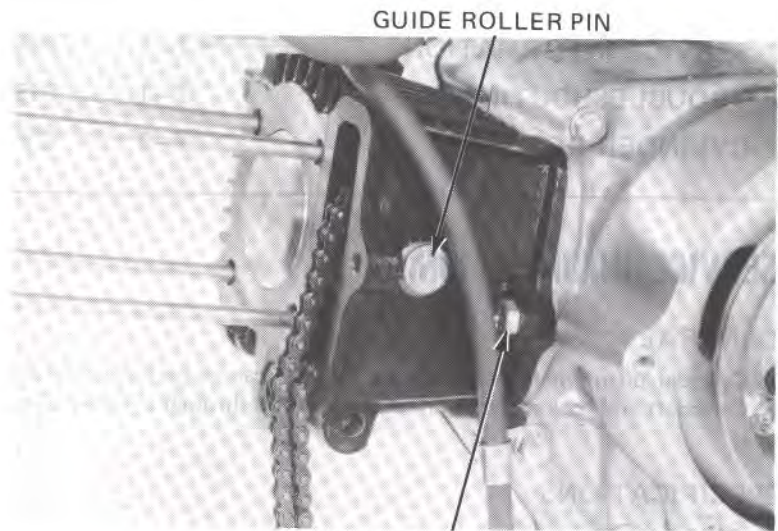

CYLINDER MOUNT BOLT

Remove the O-ring, gasket and dowel pins.

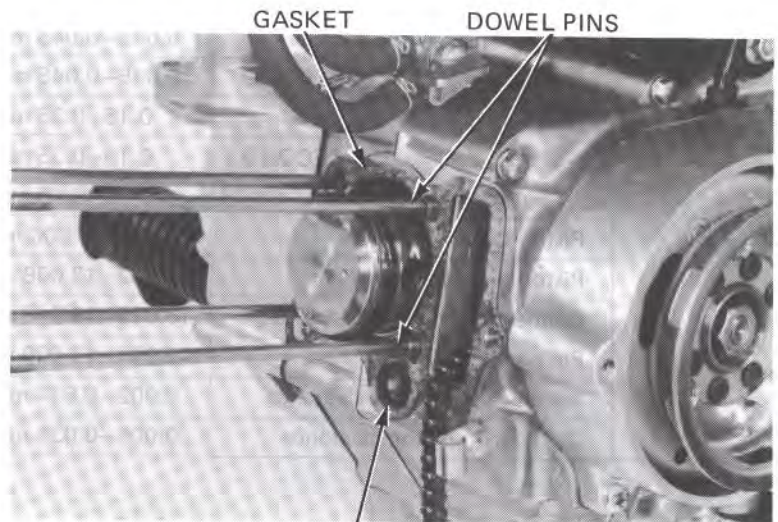

O-RING

INSPECTION

Inspect the cylinder bore for wear or damage. Measure the cylinder I.D. at three levels in X and Y axis.

SERVICE LIMIT: 47.05 mm (1.852 in)

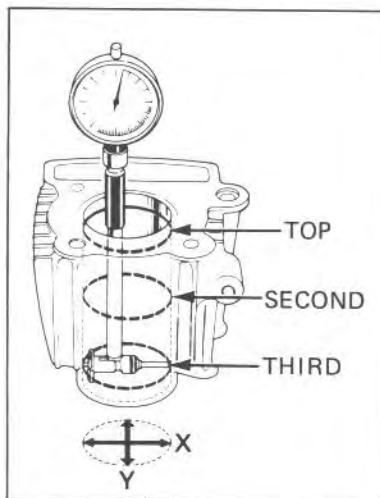



PISTON REMOVAL

Place a shop towel in crankcase to keep dirt and parts out.

Remove the piston pin clip with needle nose pliers.

Press the piston pin out.

Remove the piston.

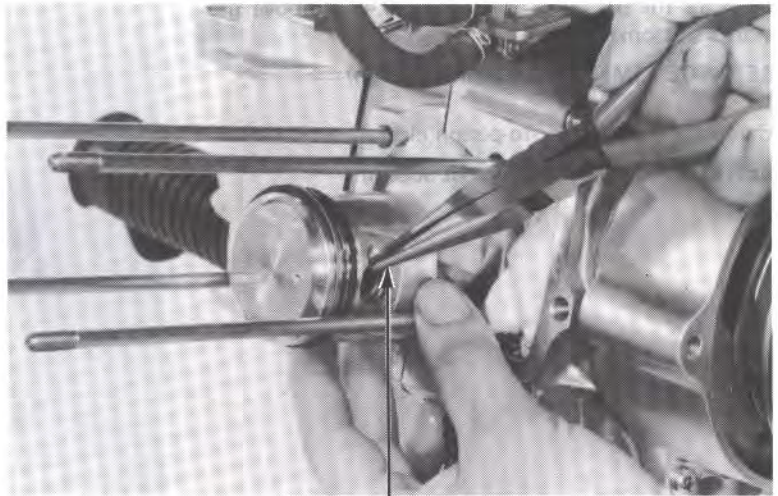

PISTON PIN CLIP

INSPECTION

Measure the piston ring-to-groove clearance.

SERVICE LIMIT. 0.12 mm (0.005 in)

Remove the piston rings.

NOTE:

Do not damage the piston rings during removal.

Inspect the piston for damage and cracks; ring grooves for wear.

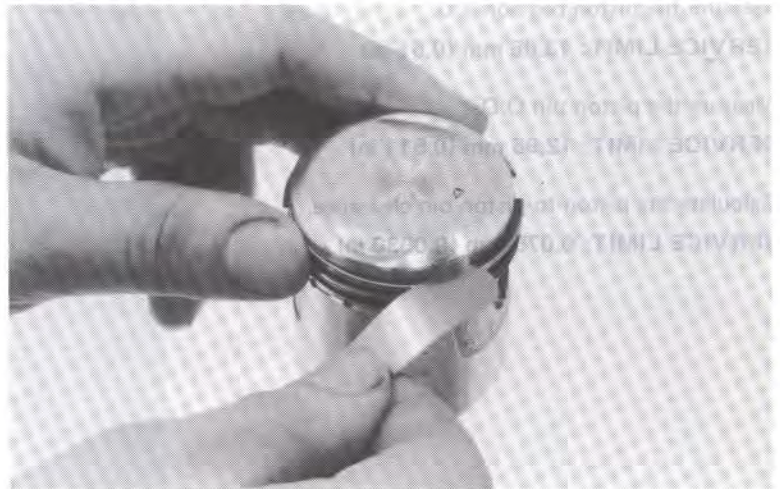

Insert each piston ring into the cylinder, and measure the end gap.

SERVICE LIMIT: TOP/SECOND: 0.5 mm (0.02 in)

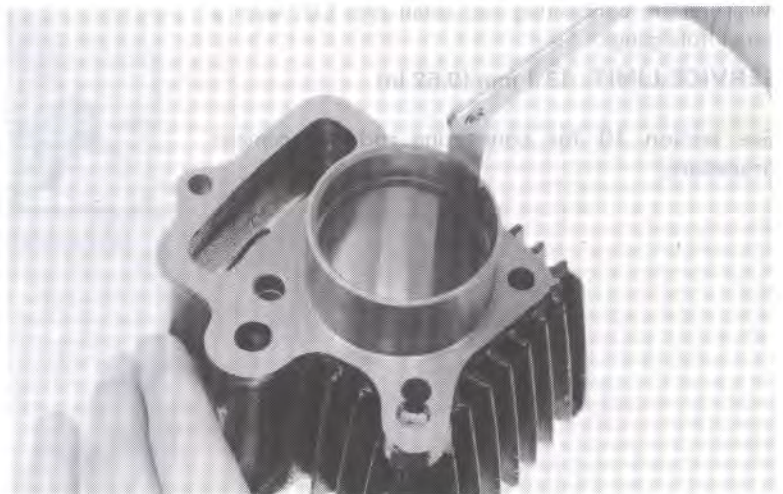



CYLINDER/PISTON

Measure the piston O.D. 10 mm (0.4 in) above the skirt's bottom.

SERVICE LIMIT: 46.90 mm (1.847 in)

Calculate the cylinder-to-piston clearance.

SERVICE LIMIT: 0.15 mm (0.006 in)

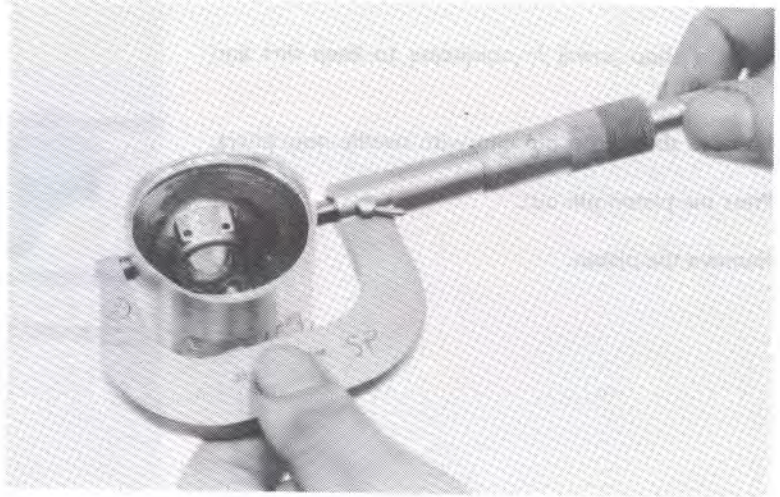

Measure the piston pin hole I.D.

SERVICE LIMIT: 13.06 mm (0.51 in)

Measure the piston pin O.D.

SERVICE LIMIT: 12.98 mm (0.511 in)

Calculate the piston-to-piston pin clearance.

SERVICE LIMIT: 0.075 mm (0.0030 in)



Measure the connecting rod small end I.D. with a small hole gauge.

SERVICE LIMIT: 13.1 mm (0.52 in)

See section 10 for connecting rod replacement procedure.

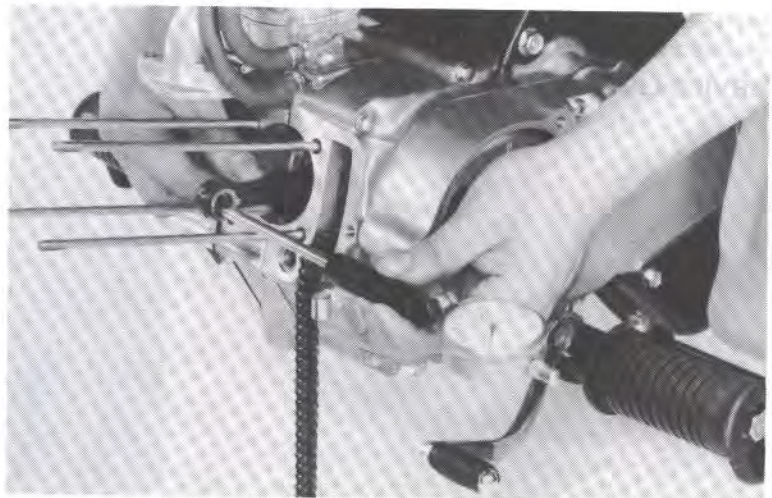



PISTON RING INSTALLATION

Install the piston rings with the markings facing up.

NOTE:

- After installation, the rings should rotate freely.
- Do not mix the top and second rings.

Space the piston ring end gaps 120 degrees apart. Do not align the gaps in the oil rings.

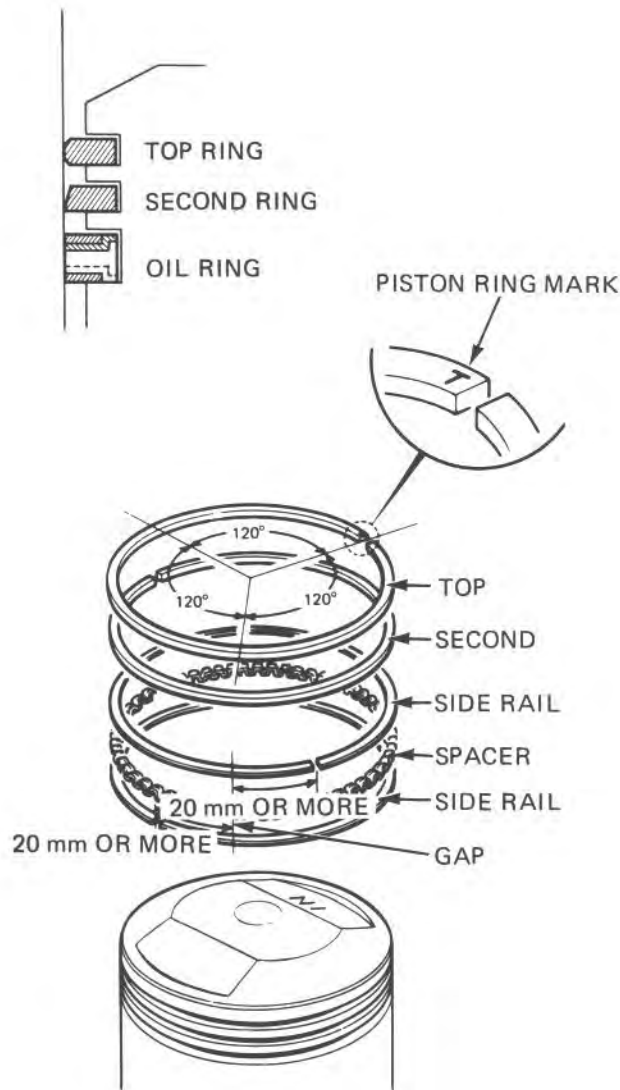
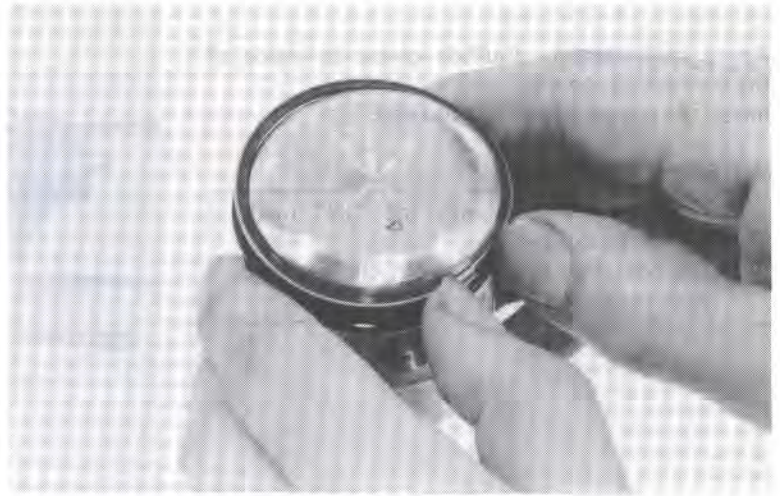



CYLINDER/PISTON

PISTON INSTALLATION

Apply molybdenum disulfide grease to inside of the connecting rod small end.
Install the piston, piston pin and clip.

NOTE:

- Install the piston with the "IN" mark facing the intake side.
- Do not align the piston pin clip end gap with the piston cutout.

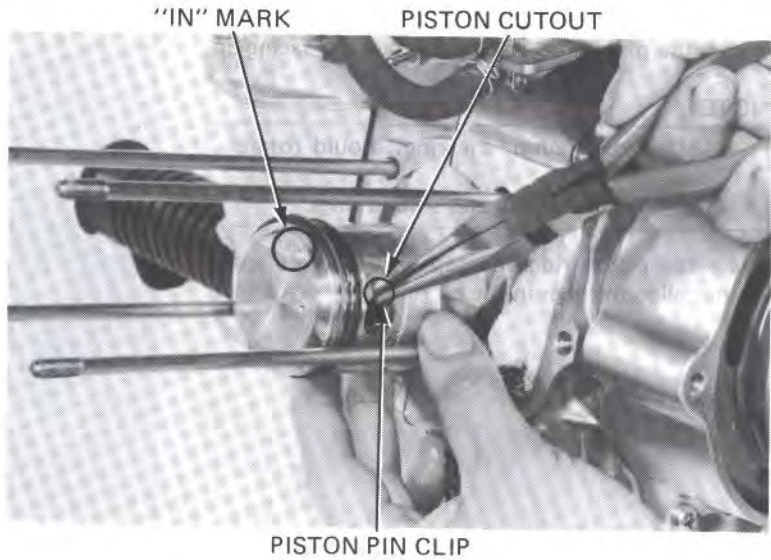

CYLINDER INSTALLATION

Install the dowel pins, O-ring and gasket.

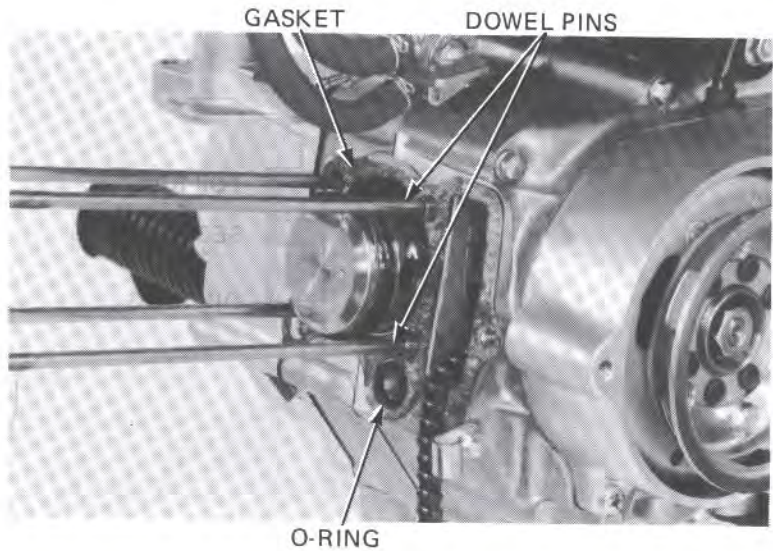

Apply a thin coat of engine oil to the piston rings and cylinder wall.
Install the cylinder, compressing the piston rings.

NOTE:

- When the cylinder is halfway over the piston, route the cam chain through the cylinder.

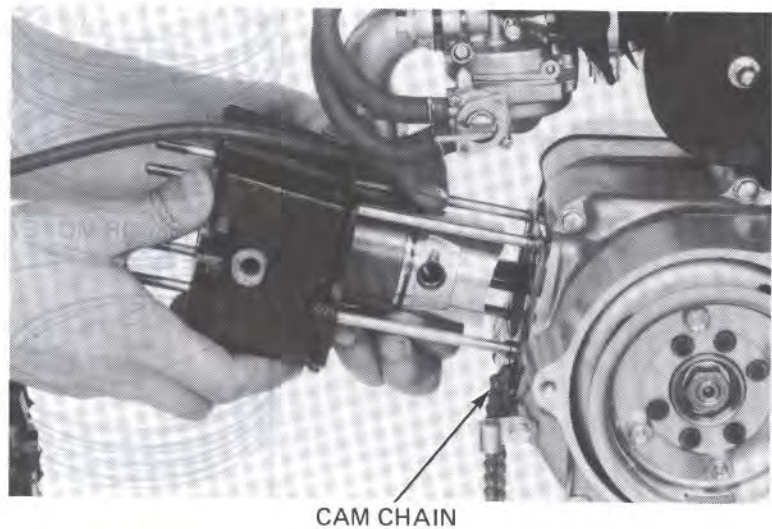



Install the cam chain guide roller and tighten the guide roller pin.

TORQUE: 9–14 N·m (0.9–1.4 kg·m, 6.5–10 ft·lb)

Loosely install the cylinder mount bolt.

Install the cylinder head (Section 6).

Tighten the cylinder mount bolt.

TORQUE: 10–14 N·m (1.0–1.4 kg·m, 7–10 ft·lb)

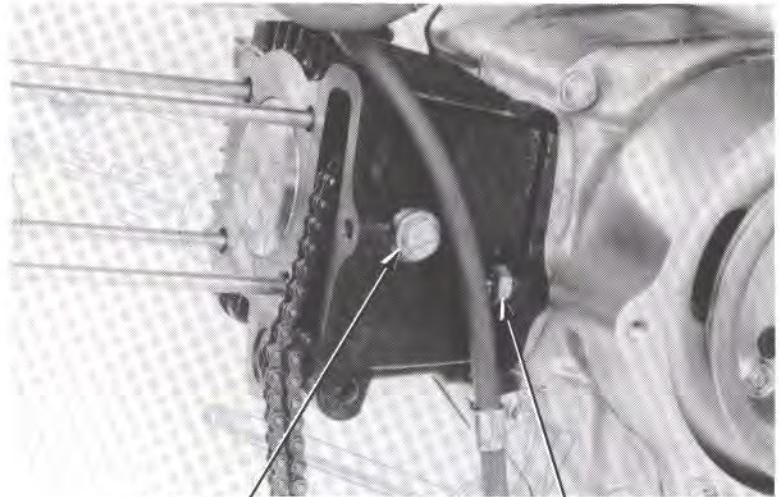

GUIDE ROLLER PIN

CYLINDER MOUNT BOLT

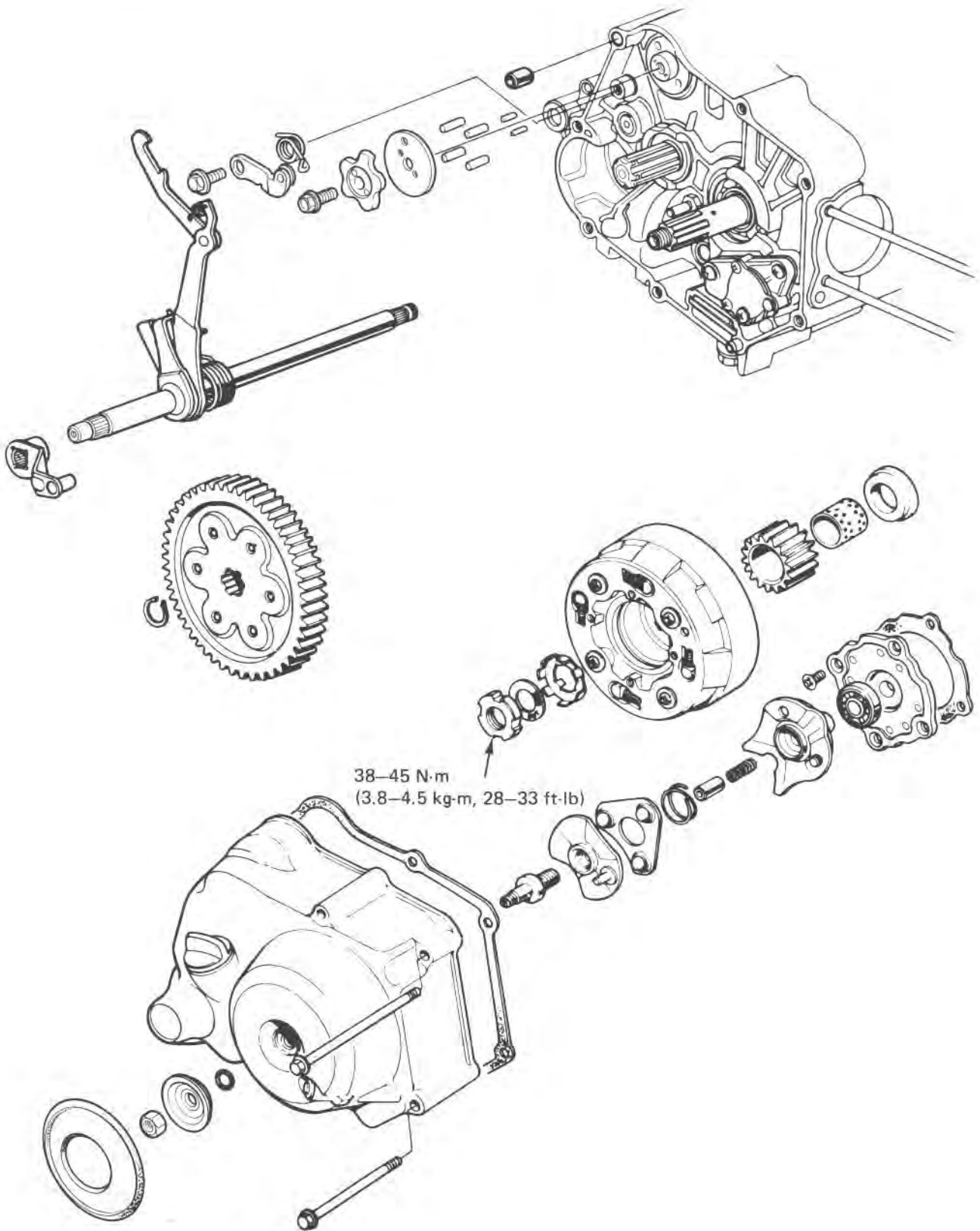



SERVICE INFORMATION	8-1	CLUTCH ASSEMBLY	8-7
TROUBLESHOOTING	8-1	CLUTCH INSTALALTION	8-9
RIGHT CRANKCASE COVER REMOVAL	8-2	RIGHT CRANKCASE COVER INSTALLATION	8-11
CLUTCH REMOVAL	8-3	GEARSHIFT LINKAGE REMOVAL	8-12
CLUTCH DISASSEMBLY	8-5	GEARSHIFT LINKAGE INSTALLATION	8-13

SERVICE INFORMATION

GENERAL

- The clutch, gearshift spindle and stopper arm can be serviced with the engine in the frame.
- If the shift forks, drum and transmission require servicing, remove the engine and separate the crankcase.

SPECIFICATIONS

ITEM		STANDARD	SERVICE LIMIT
Clutch	Spring free length	25.08 mm (0.987 in)	23.1 mm (0.91 in)
	Disc thickness	A	2.55–2.65 mm (0.100–0.104 in)
		B	3.35–3.45 mm (0.132–0.136 in)
	Plate warpage	—	0.2 mm (0.01 in)
Clutch center guide O.D.		20.930–20.950 mm (0.8240–0.8248 in)	20.90 mm (0.823 in)
Drive gear I.D.		21.000–21.021 mm (0.8268–0.8276 in)	21.05 mm (0.829 in)

TORQUE VALUE

Clutch lock nut 38–45 N·m (3.8–4.5 kg-m, 28–33 ft-lb)
 Gearshift pedal bolt 9–15 N·m (0.9–1.5 kg-m, 6.5–11 ft-lb)

TOOLS

Lock nut wrench, 20 x 24 mm 07716–0020100 or 07916–3710000 or Equivalent commercially available in U.S.A.
 Extension 07716–0020500–Equivalent commercially available in U.S.A.
 Universal holder 07725–0030000–Equivalent commercially available in U.S.A.

TROUBLESHOOTING

Clutch slips

- No free play
- Discs worn
- Springs weak

Clutch does not disengage

- Plate warpage

Clutch drags when disengaged

- Lifer mechanism damaged

Hard shifting

- Improper clutch adjustment
- Shift forks bent
- Shift shaft bent
- Shift drum stopper bent
- Shift drum cam groove bent

Transmission jumps our of gear

- Gear dogs worn
- Shift shaft bent
- Shift drum stopper broken
- Shift forks bent



RIGHT CRANKCASE COVER REMOVAL

Remove the exhaust pipe (Page 12-11).
Remove the foot pegs (Page 12-12).
Remove the intake pipe joint bolts (Page 4-6).

Place a floor jack or other adjustable support under the engine and remove the engine upper hanger bolt.

UPPER HANGER BOLT/NUT INTAKE PIPE JOINT BOLTS

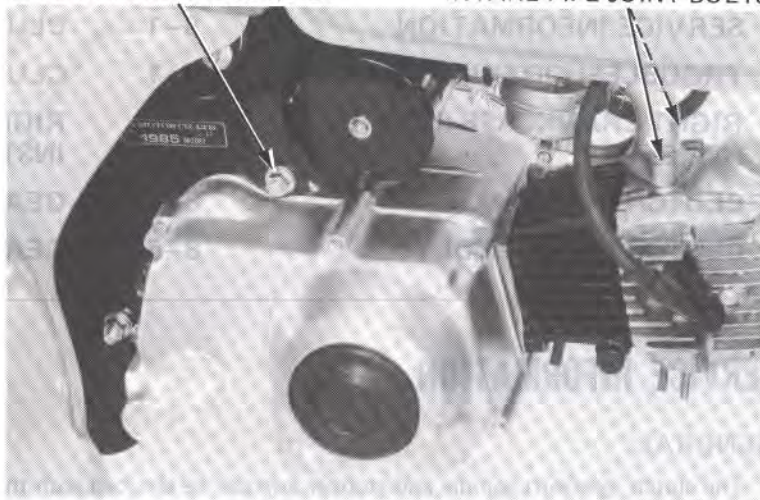

Remove the right crankcase cover bolts.
Loosen the engine lower hanger bolt and lower the floor jack, then remove the right crankcase cover.

RIGHT CRANKCASE COVER

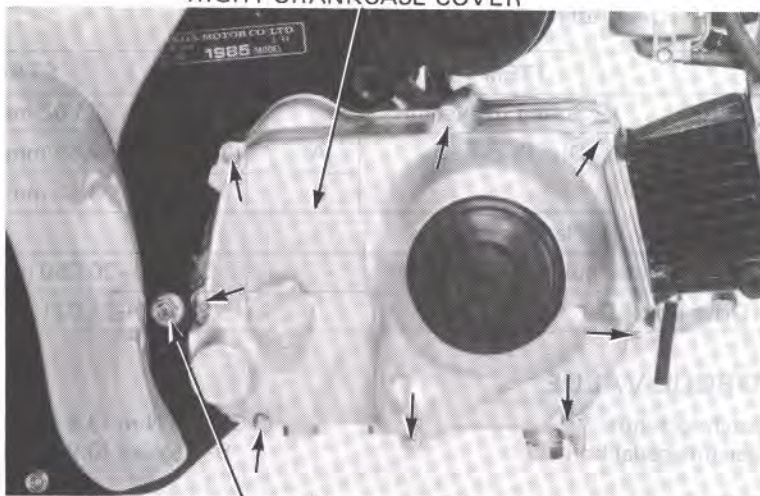

ENGINE LOWER HANGER BOLT/NUT

Remove the dowel pins and gasket.
Raise the engine and reinstall the engine upper hanger bolt.

DOWEL PINS

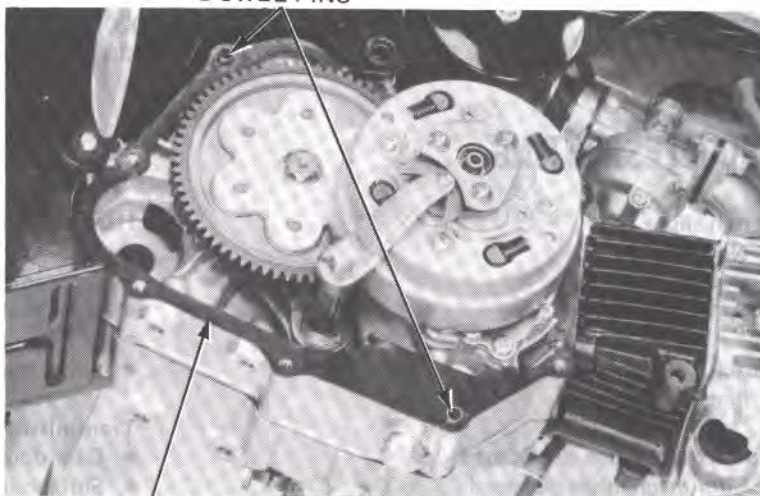

GASKET



CLUTCH LIFTER REMOVAL

Remove the rubber cover.
Hold the clutch adjusting bolt and remove the lock nut, washer and O-ring.

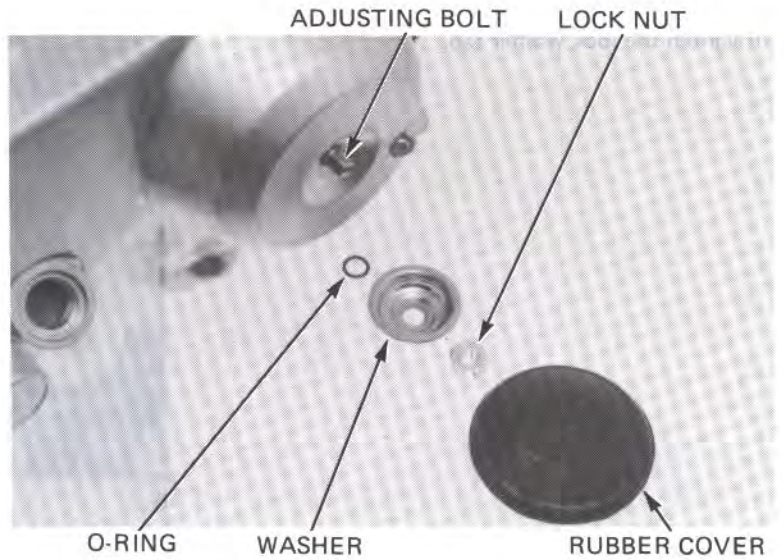

CLUTCH REMOVAL

Remove the clutch lever and clutch cam.

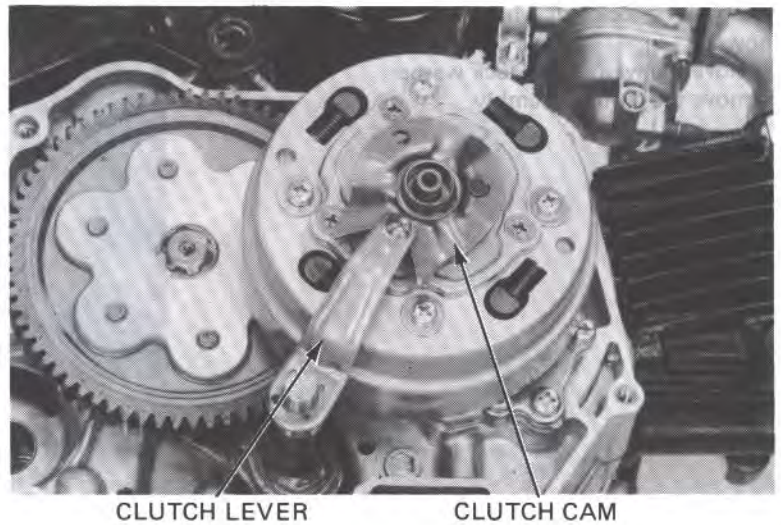

Remove the clutch outer cover by removing the three screws.





CLUTCH/GEARSHIFT LINKAGE

Straighten the lock washer tab.

LOCK WASHER TAB

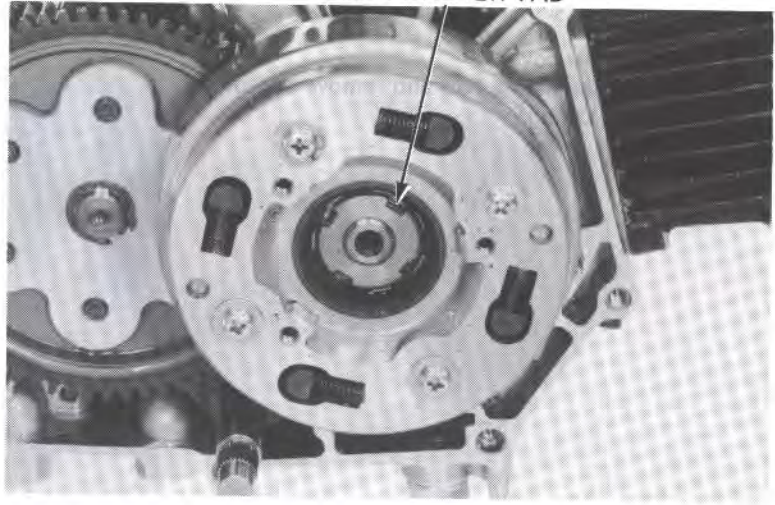

LOCK NUT WRENCH, 20 x 24 mm
07716-0020100 or 07916-3710000 or
Equivalent commercially available in U.S.A.

Remove the lock nut while holding the flywheel as shown.
Remove the washer and lock washer.
Remove the clutch assembly.

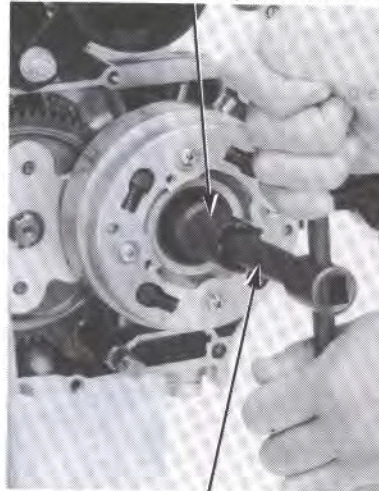

EXTENTION 07716-0020500 or
Equivalent commercially available
in U.S.A.

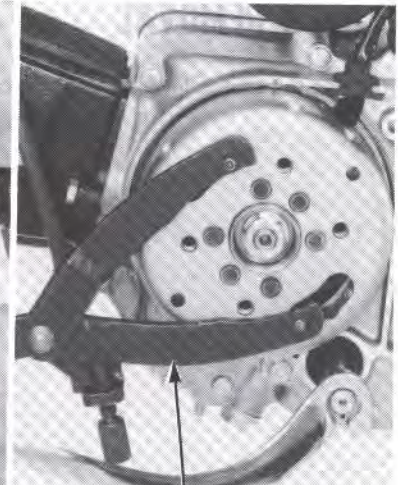

UNIVERSAL HOLDER
07725-0030000 or Equivalent
commercially available in U.S.A.

Remove the primary drive gear and clutch center guide.

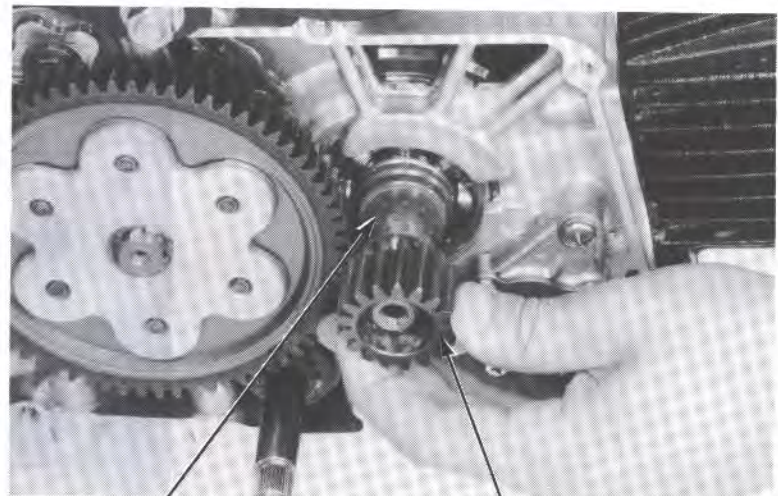

CLUTCH CENTER GUIDE PRIMARY DRIVE GEAR



Remove the snap ring and primary driven gear.

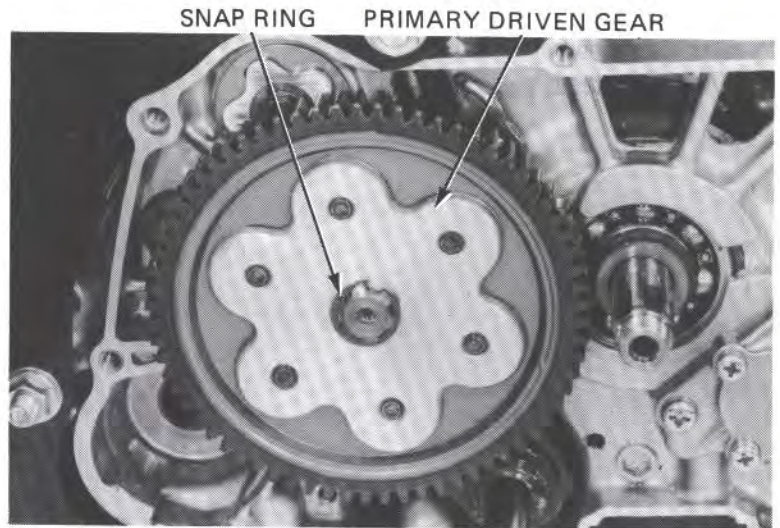

CLUTCH DISASSEMBLY

Remove the set ring using a screwdriver.
Remove the clutch plates, discs, center, drive gear outer and rollers.

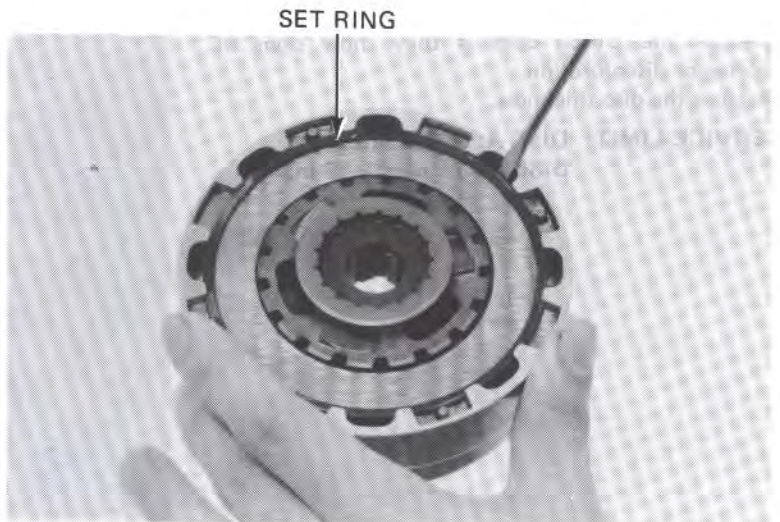

Remove the clutch damper springs.

Place a wood block under the drive plate.
Remove the screws, loosening 2-3 turns at a time while pushing down on the clutch outer.

Remove the clutch springs under the screws.

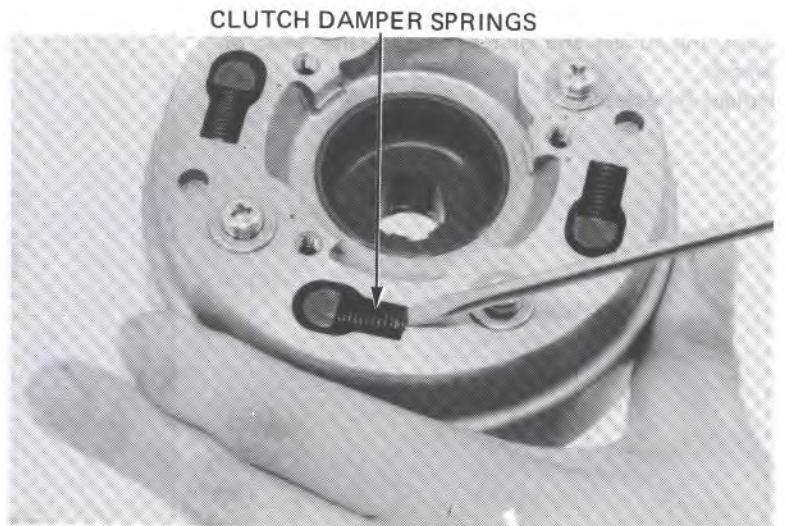



CLUTCH/GEARSHIFT LINKAGE

INSPECTION

Measure the spring free length.

SERVICE LIMIT: 23.1 mm (0.91 in)

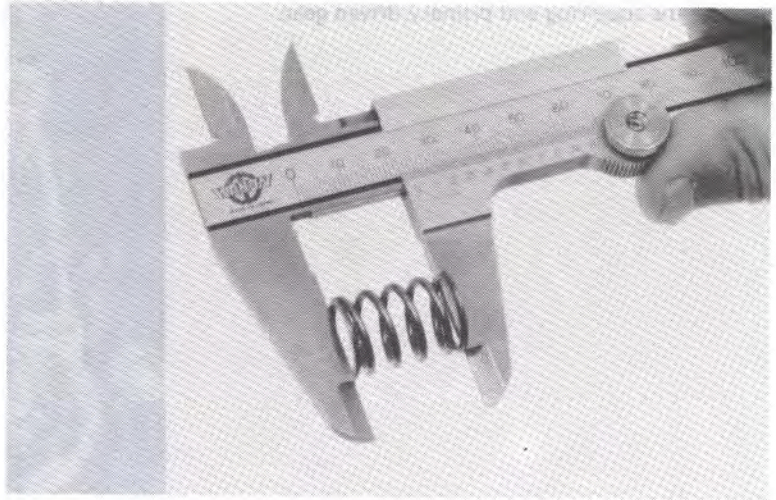

Replace the clutch discs if they show signs of scoring or discoloration.

Measure the disc thickness.

SERVICE LIMIT: DISC A: 2.3 mm (0.09 in)

DISC B: 3.0 mm (0.12 in)

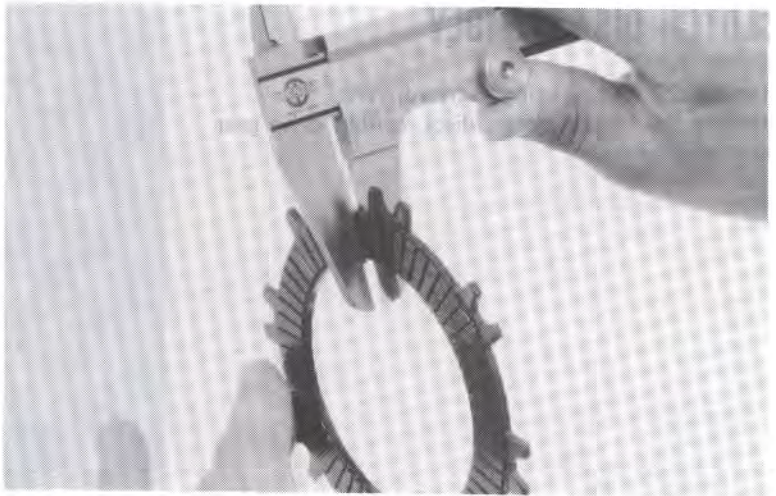

Check the rollers and plates for excessive wear or damage.

Replace if necessary.

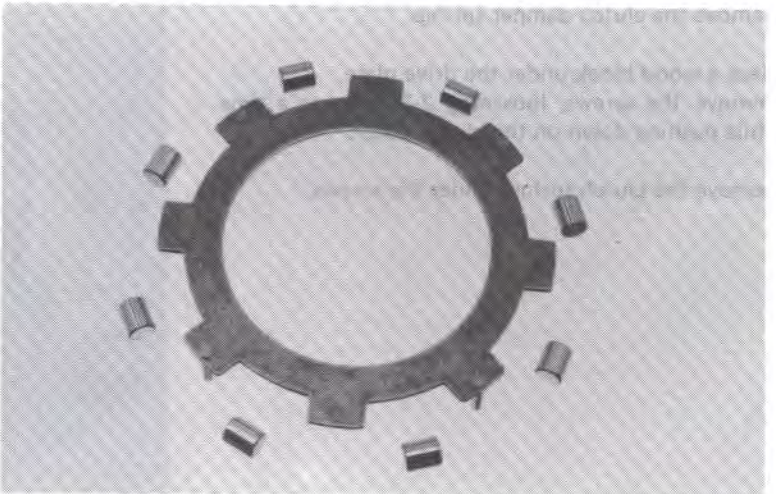



Check for plate warpage on a surface plate using a feeler gauge.

SERVICE LIMIT: 0.2 mm (0.01 in)

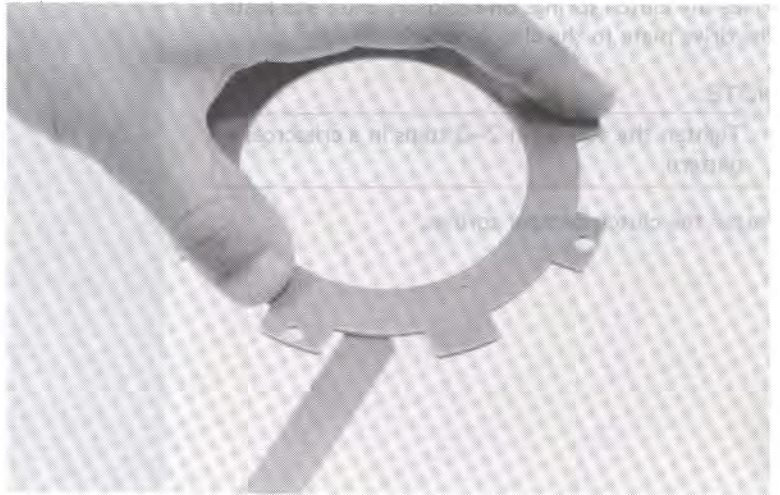

Check for wear or damage.
Measure the drive gear I.D.

SERVICE LIMIT: 21.05 mm (0.829 in)

Check for wear or damage.
Measure the clutch center guide O.D.

SERVICE LIMIT: 20.90 mm (0.823 in)

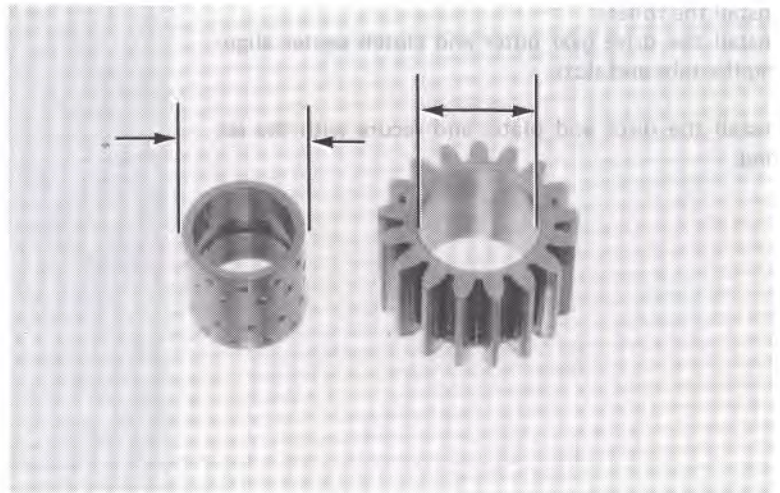

CLUTCH ASSEMBLY

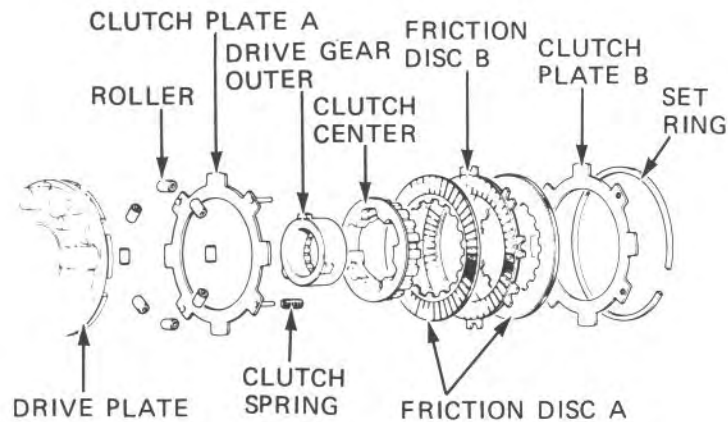



CLUTCH/GEARSHIFT LINKAGE

Place the clutch springs on the drive plate and install the drive plate to the clutch outer.

NOTE:

Tighten the screws in 2-3 steps in a crisscross pattern.

Install the clutch damper springs.

DAMPER SPRINGS

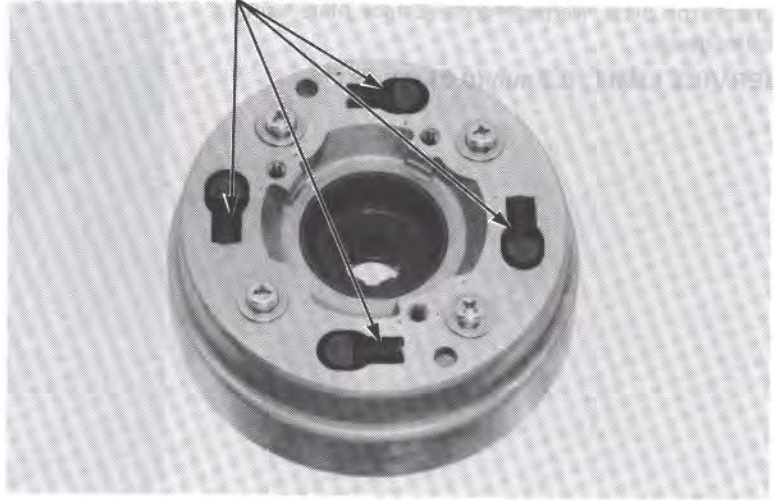

Install the rollers.
Install the drive gear outer and clutch center aligning the tabs and slots.

Install the discs and plates and secure with the set ring.

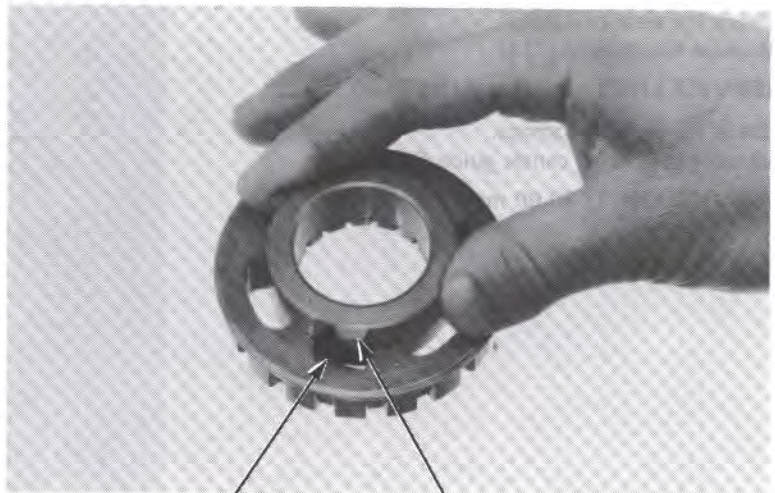

SLOT TAB

Install the primary drive gear and washer.
Make sure the one way clutch assembly is installed correctly by turning the primary drive gear.
The primary drive gear should turn counterclockwise freely and should not turn clockwise.

PRIMARY DRIVE GEAR

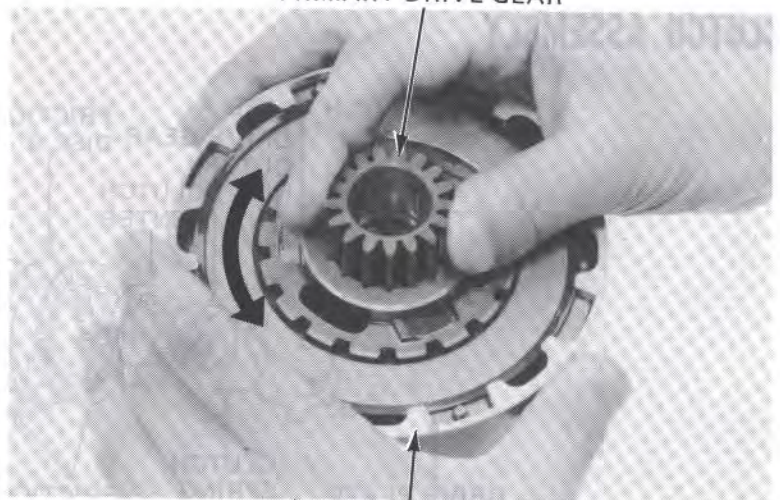

CLUTCH ASSEMBLY



CLUTCH INSTALLATION

Install the primary driven gear and secure with the snap ring.

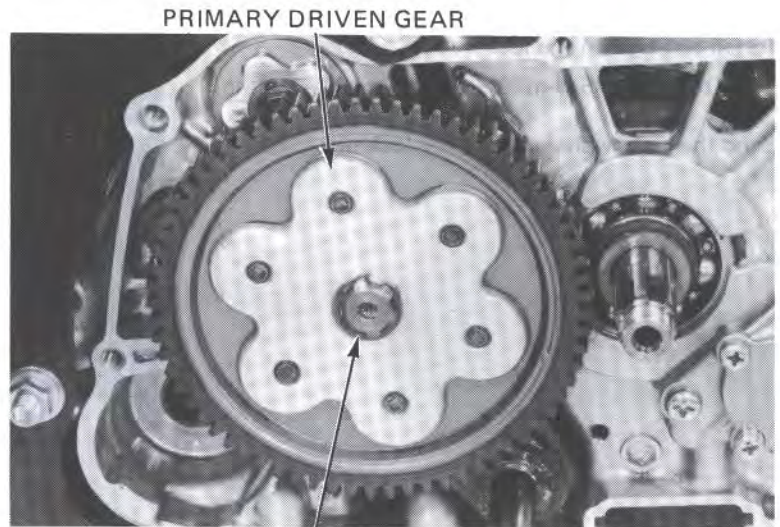

Install the clutch center guide onto the crankshaft.
Install the clutch assembly.

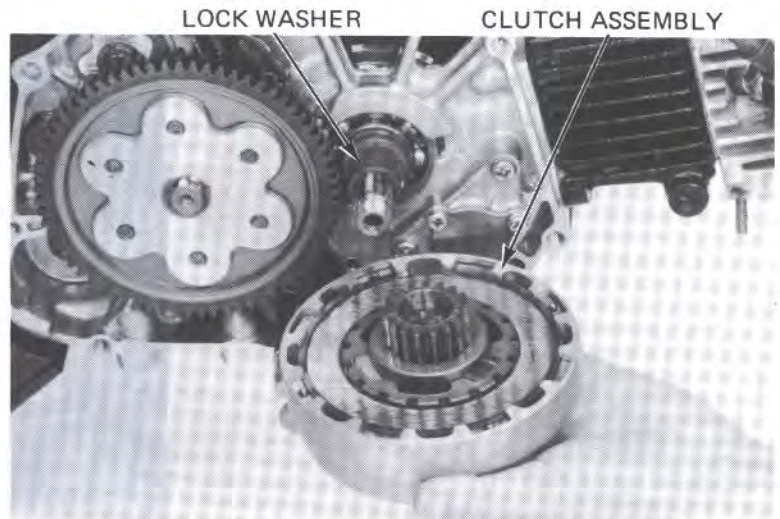

Install the lock washer and plain washer.

NOTE:

Install the plain washer with the **OUTSIDE** mark facing out.

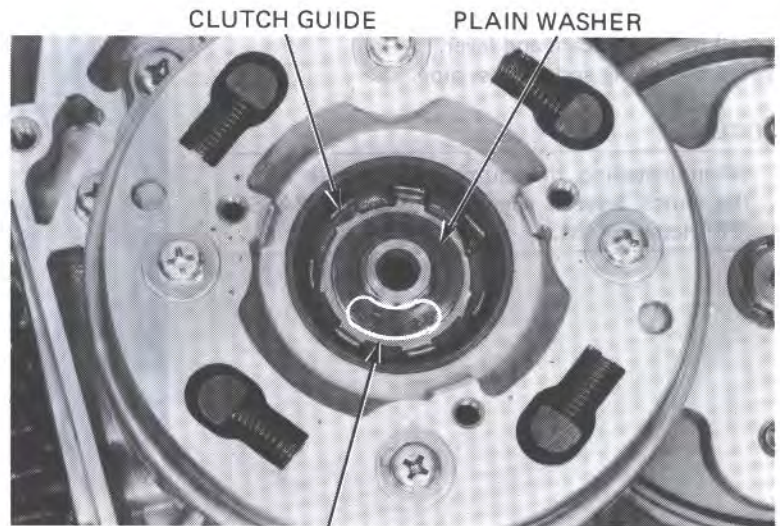

CLUTCH/GEARSHIFT LINKAGE



HONDA
ATC70

Install and tighten the lock nut.

TORQUE: 38–45 N·m (3.8–4.5 kg-m, 28–33 ft-lb)

Bend the lock washer up into the lock nut.

LOCK NUT WRENCH, 20 x 24 mm
07716-0020100 or 07916-3710000
or equivalent commercially available in U.S.A.

LOCK WASHER TAB

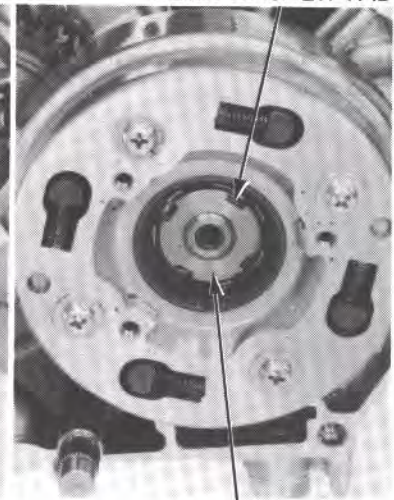
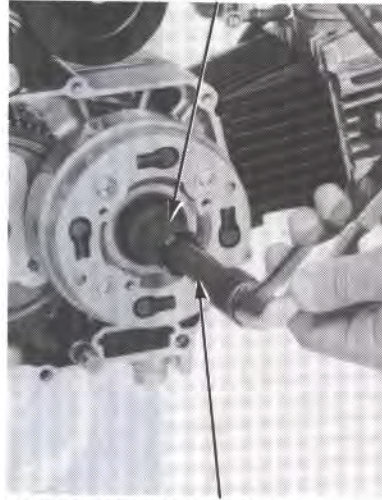

EXTENSION 07716-0020500

LOCK NUT

or equivalent commercially available in U.S.A.

Install the clutch outer cover.

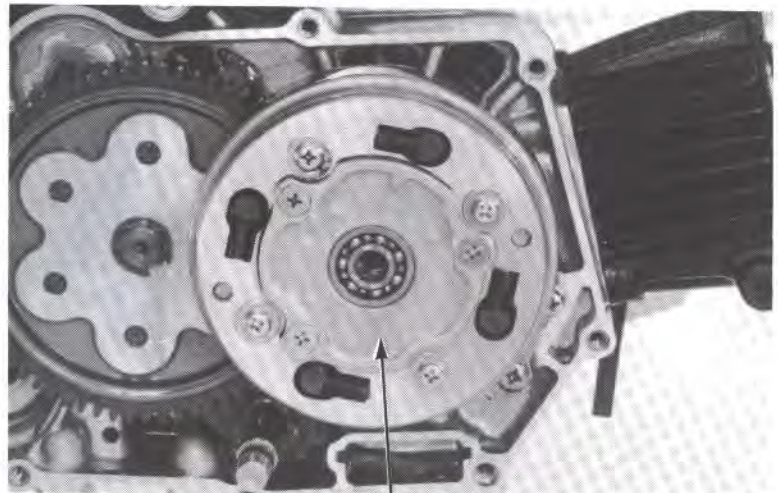

CLUTCH OUTER COVER

Install the clutch cam and lever.
Install the spring and oil pass pipe.

NOTE:

When installing the clutch lever, make sure the clutch lever is aligned with the oil PASS PIPE (crankshaft).

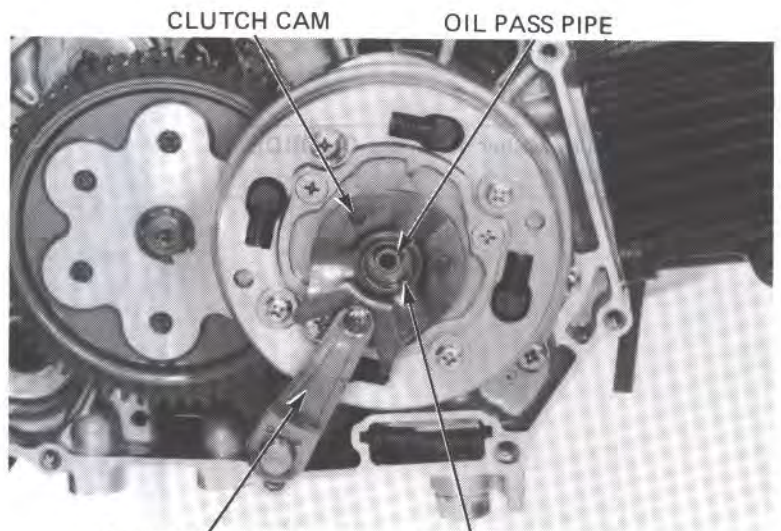

CLUTCH CAM

OIL PASS PIPE

CLUTCH LEVER

SPRING



RIGHT CRANKCASE COVER INSTALLATION

Install the clutch cam spring and ball race retainer.
Install the dowel pins and gasket.

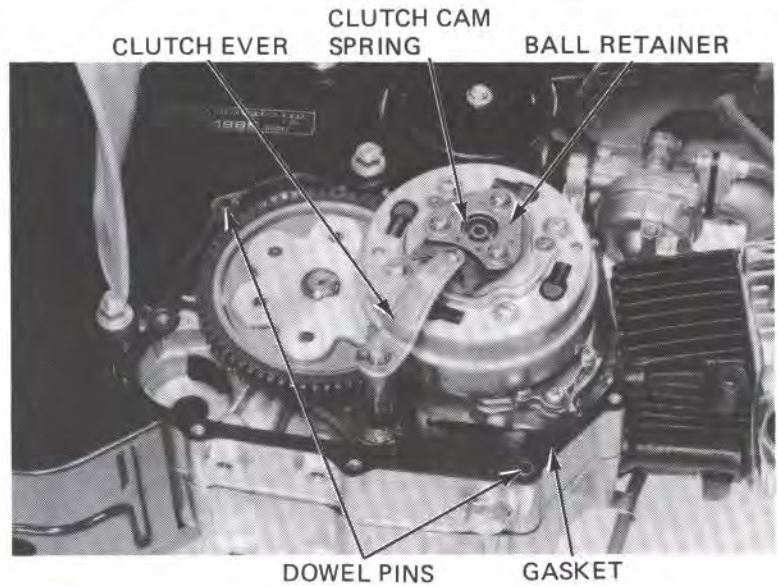

Install the clutch adjusting bolt and clutch lifter aligning the tang on the clutch lifter and groove on the right crankcase cover.

Install the O-ring washer and lock nut onto the adjusting bolt and tighten the lock nut.

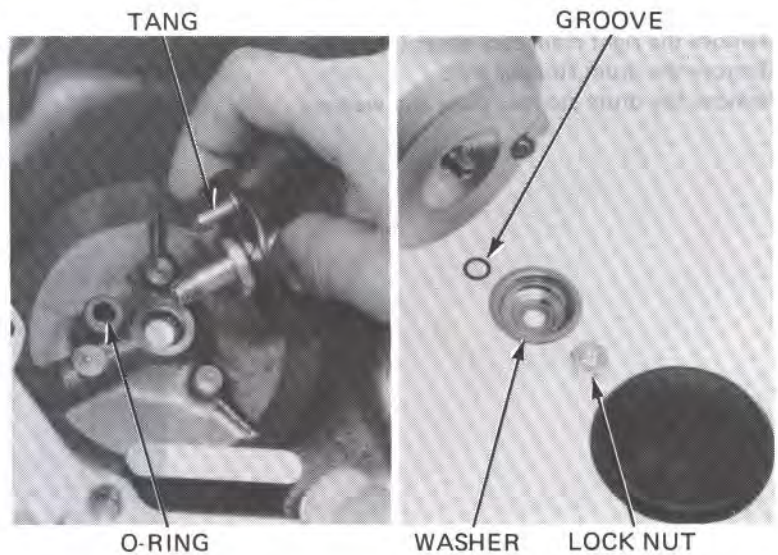

Install the right crankcase cover in the reverse order of removal.

Fill the crankcase to the proper level with the recommended oil (Page 2-2).

Adjust the clutch (Page 3-12).

Install the foot peg (Page 12-12).

Install the exhaust pipe (Page 12-11).

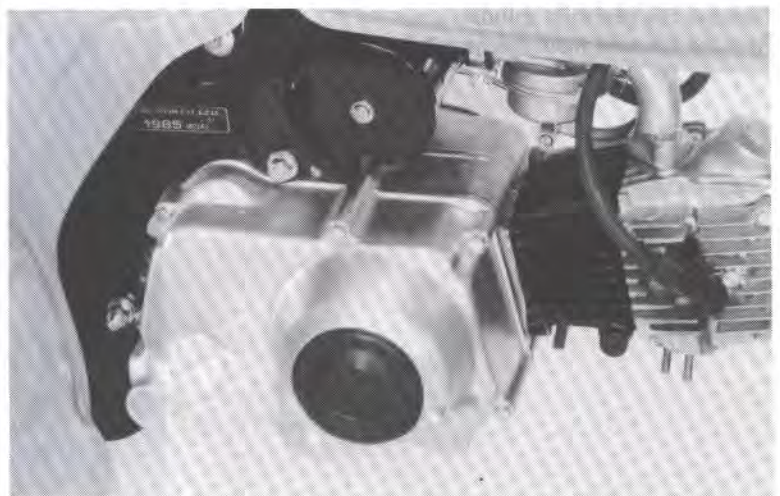



GEARSHIFT LINKAGE REMOVAL

Drain the engine oil (Page 2-2).
Remove the gearshift pedal.

GEARSHIFT PEDAL

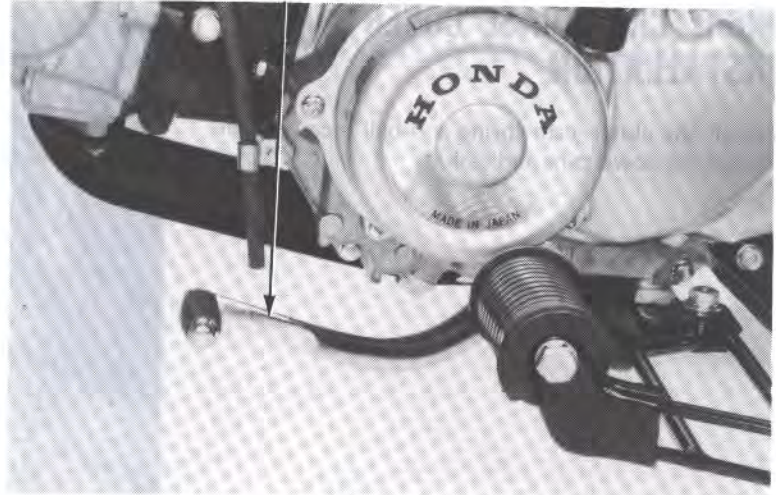

Remove the right crankcase cover (Page 8-2).
Remove the drum stopper arm.
Remove the drum stopper plate and washer.

DRUM STOPPER PLATE

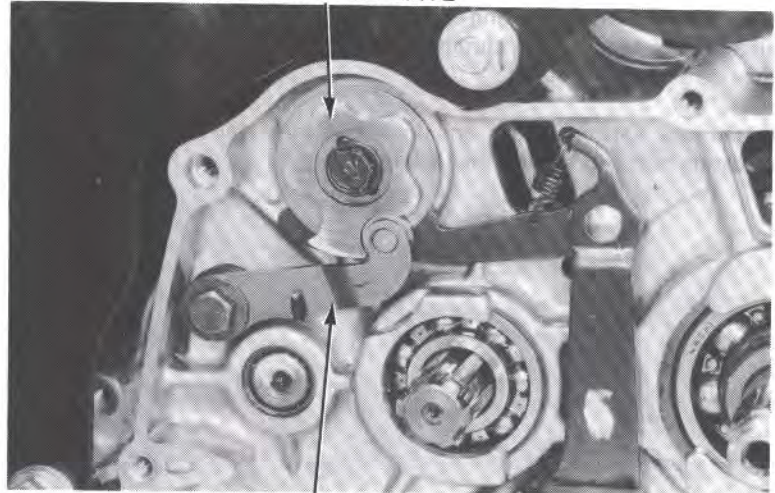

DRUM STOPPER ARM

Remove the gearshift spindle.
Remove the pins from the gearshift drum.

PINS

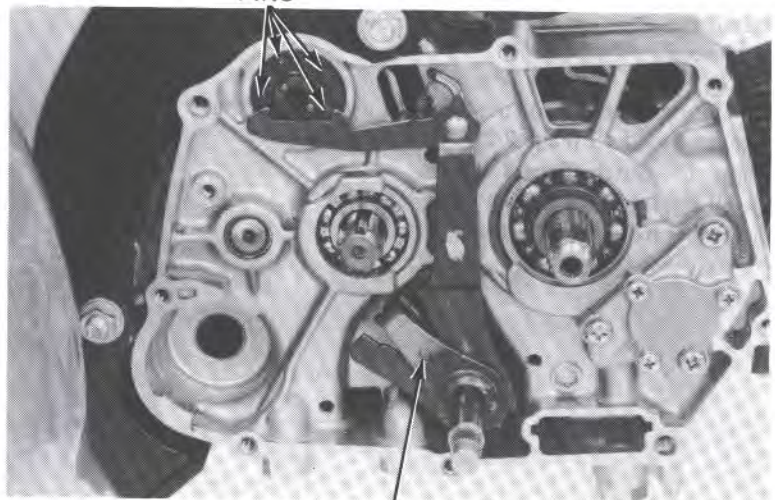

GEARSHIFT SPINDLE



Check the gearshift spindle and spring for wear or damage.

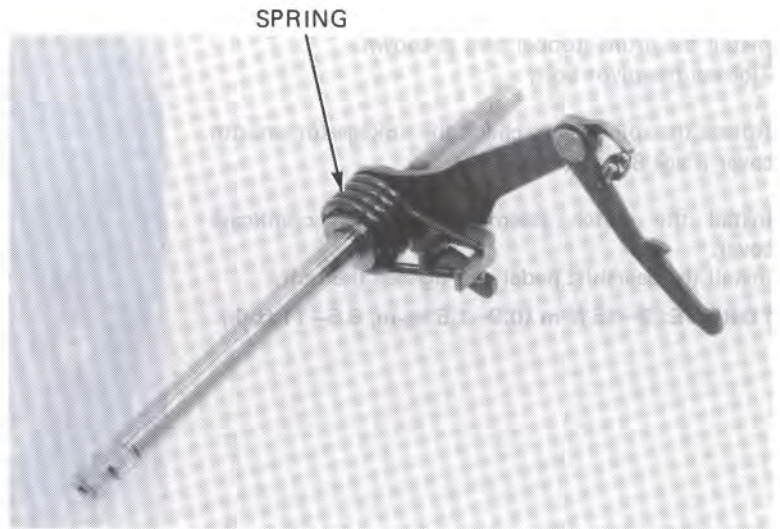

GEAR SHIFT SPINDLE

GEARSHIFT LINKAGE INSTALLATION

Install the gearshift spindle assembly.

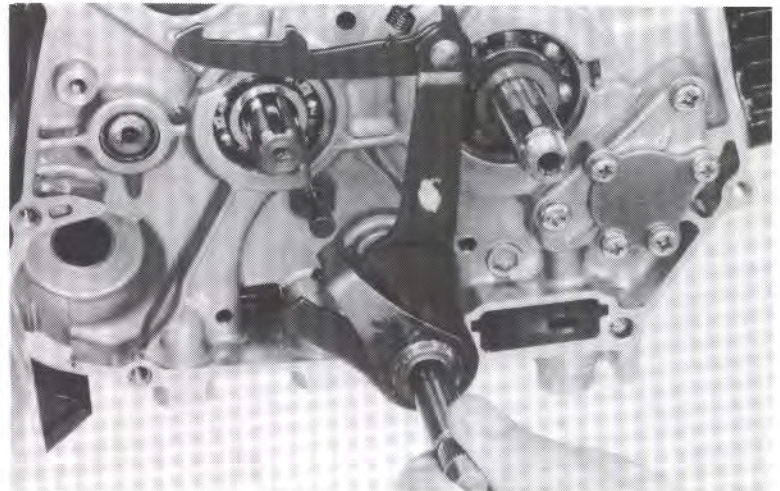

Install the pins onto the gearshift drum and install the washer and drum stopper plate as shown.

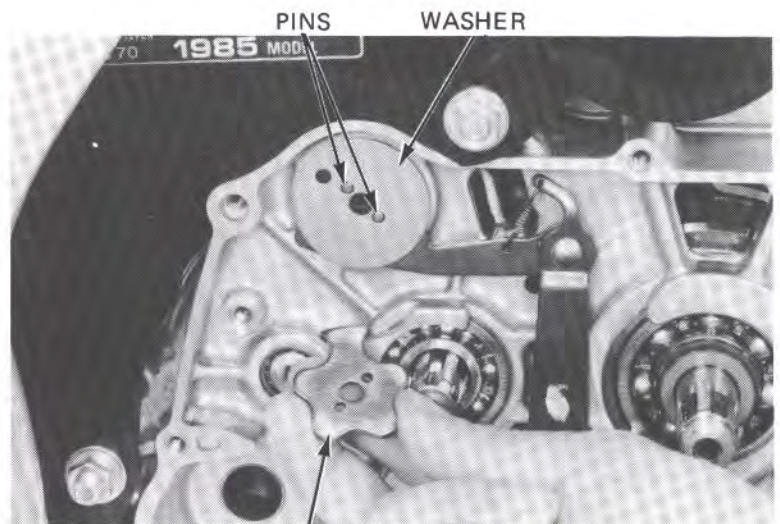

DRUM STOPPER PLATE



CLUTCH/GEARSHIFT LINKAGE

Install the drum stopper arm as shown.
Tighten the pivot bolt.

Rotate the spindle and check the linkage for smooth cover (Page 8-9 through 8-11).

Install the clutch assembly and right crankcase cover.

Install the gearshift pedal and tighten the bolt.

TORQUE: 9–15 N·m (0.9–1.5 kg·m, 6.5–11 ft·lb)

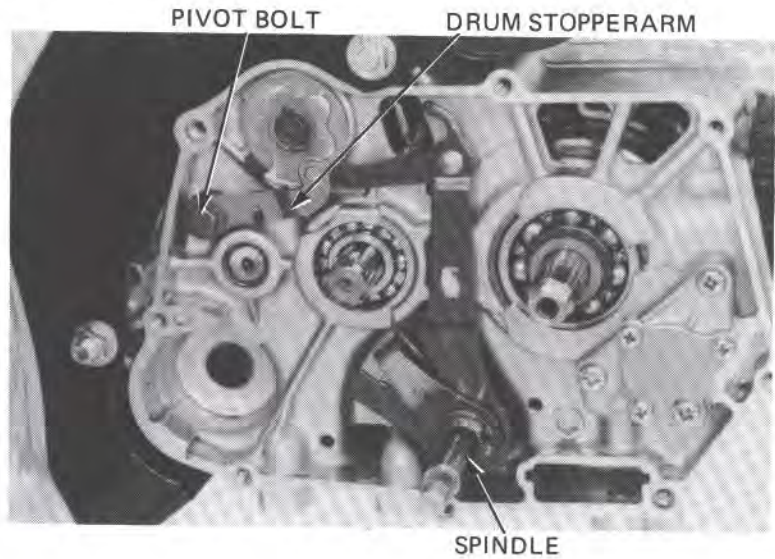



HONDA
ATC70

MEMO





RECOIL STARTER/ALTERNATOR/CAM CHAIN TENSIONER

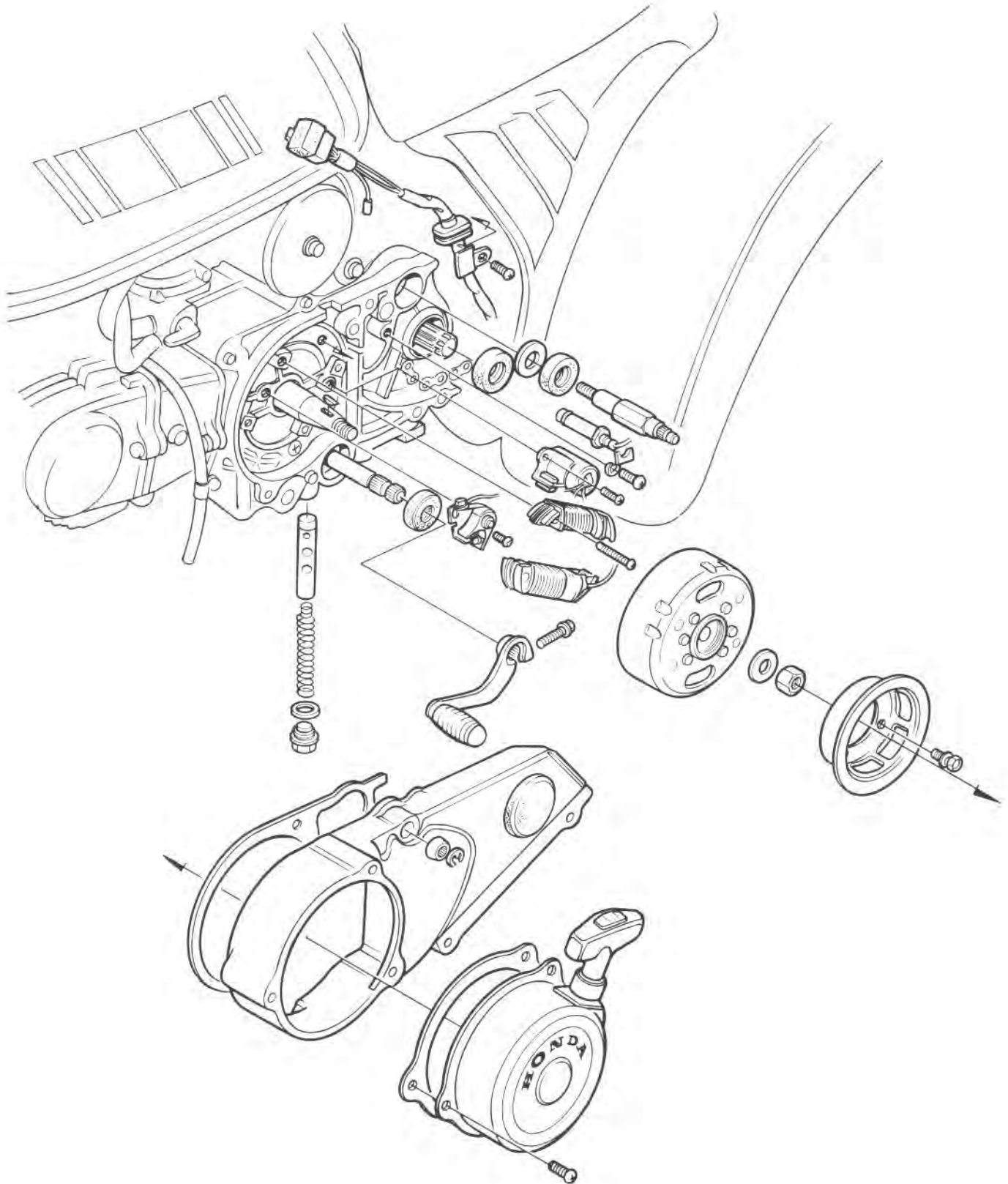



SERVICE INFORMATION	9-1
TROUBLESHOOTING	9-1
RECOIL STARTER	9-2
ALTERNATOR	9-7
CAM CHAIN TENSIONER	9-9

SERVICE INFORMATION

GENERAL

- This section covers removal and installation of the recoil starter and alternator.
- For alternator inspection and troubleshooting, refer to section 14.

SPECIFICATIONS

ITEM		STANDARD	SERVICE LIMIT
Cam chain tensioner	Spring free length	82.8 mm (3.26 in)	77 mm (3.0 in)
	Push rod O.D.	11.985–12.000 mm (0.4718–0.4724 in)	11.94 mm (0.47 in)

TORQUE VALUE

Starter driven pulley bolt	8–12 N·m (0.8–1.2 kg·m, 6–9 ft·lb)
Flywheel mount bolt	33–38 N·m (3.3–3.8 kg·m, 24–27 ft·lb)
Cam chain tensioner sealing bolt	20–25 N·m (2.0–2.5 kg·m, 15–18 ft·lb)

TOOLS

Common

Flywheel Puller	07733–0010000 or 07933–0010000
Flywheel Holder	07725–0030000 or Equivalent commercially available in U.S.A.

TROUBLESHOOTING

Engine does not turn when operating recoil starter

- Faulty starter ratchet
- Faulty starter driven pulley
- Faulty starter drive pulley

Starter rope does not recoil

- Faulty recoil spring



RECOIL STARTER/ALTERNATOR/CAM CHAIN TENSIONER

RECOIL STARTER

REMOVAL

Shift the transmission into neutral.

Remove the mount screws and recoil starter.

Remove the gasket.

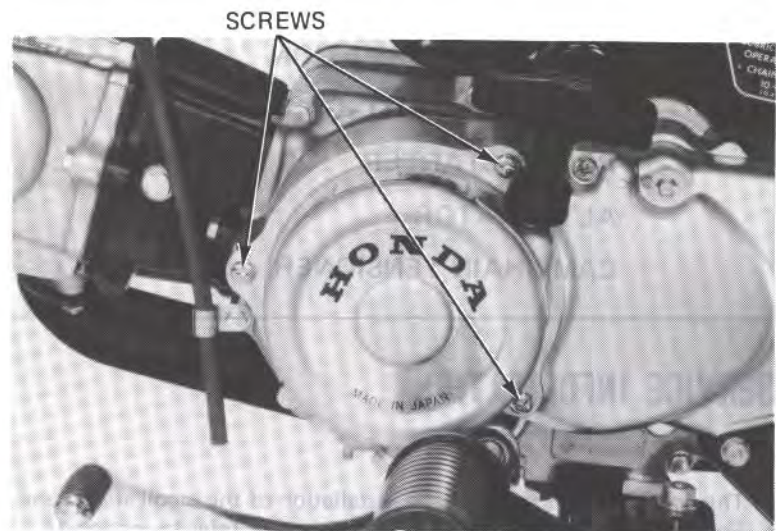

DISASSEMBLY

Remove the E-clip, washer and ratchet cover.

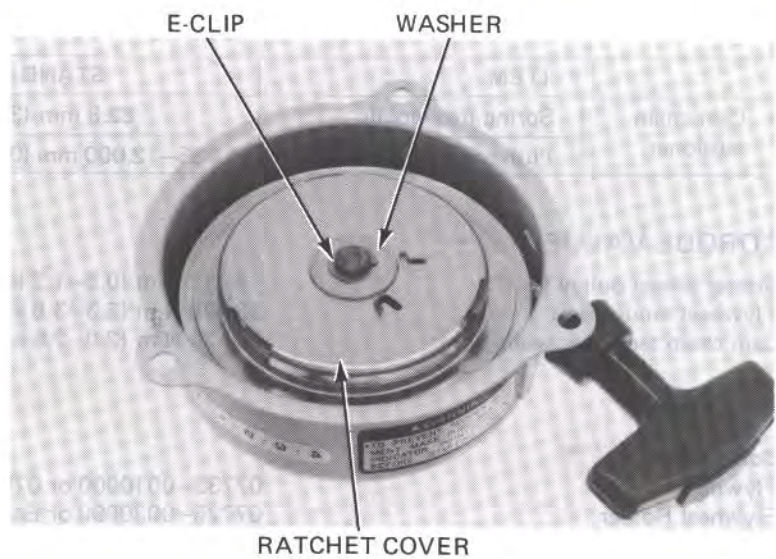

Remove the friction spring, set spring and ratchets.

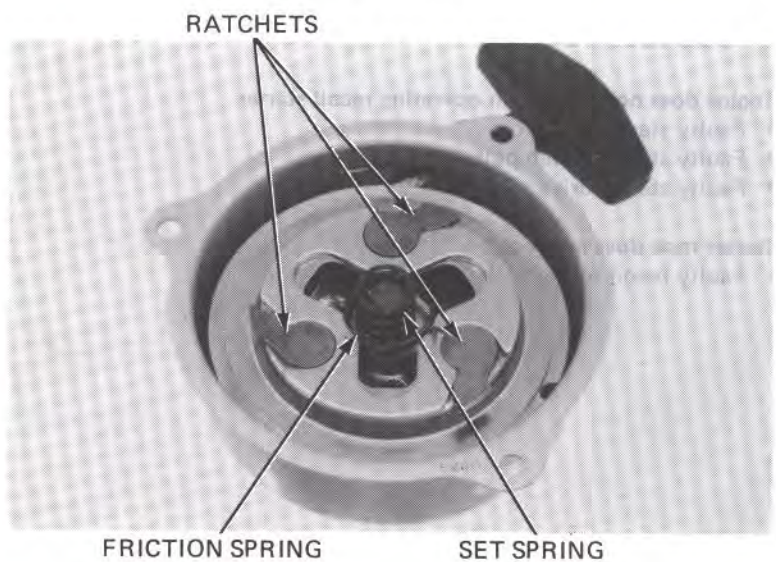



Remove the starter handle cover.

CAUTION:

Wear eye protection and use care when removing the drive pulley and starter spring. The spring can pop out of the housing if care is not used.

Untie the starter rope and remove the starter handle.

Release the starter rope slowly.
Remove the starter drive pulley.

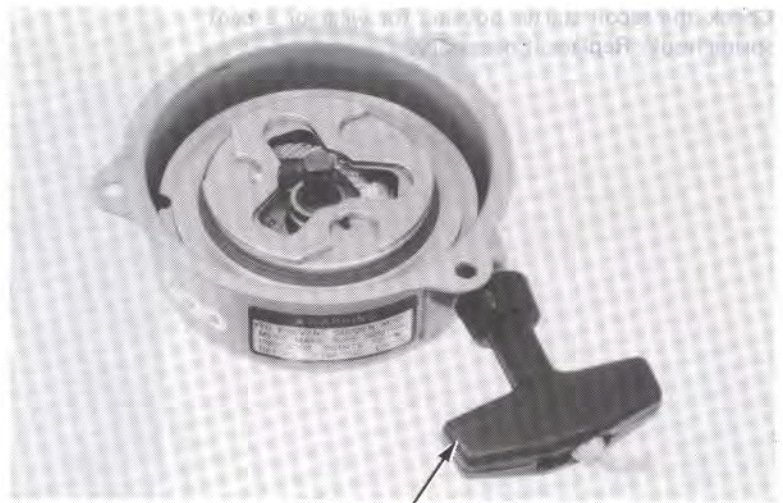

Remove the starter rope from the drive pulley.
Check the starter rope for wear or damage.

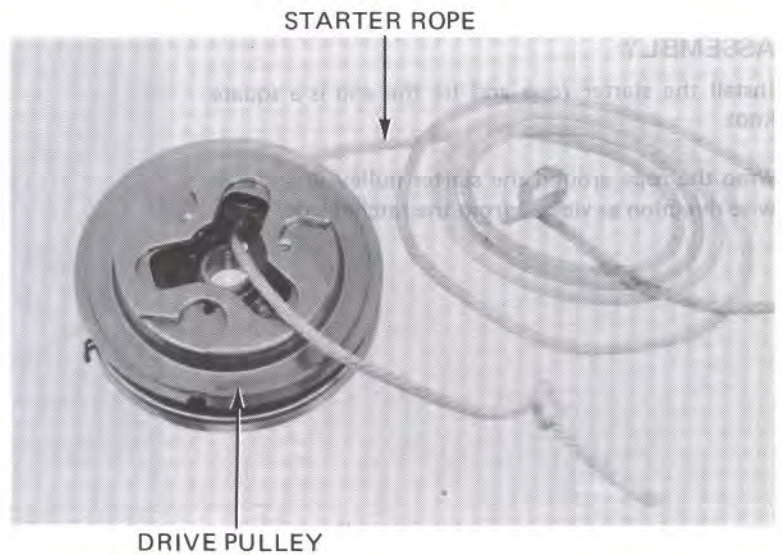

Check the recoil starter spring.
Replace the spring if it is broken.

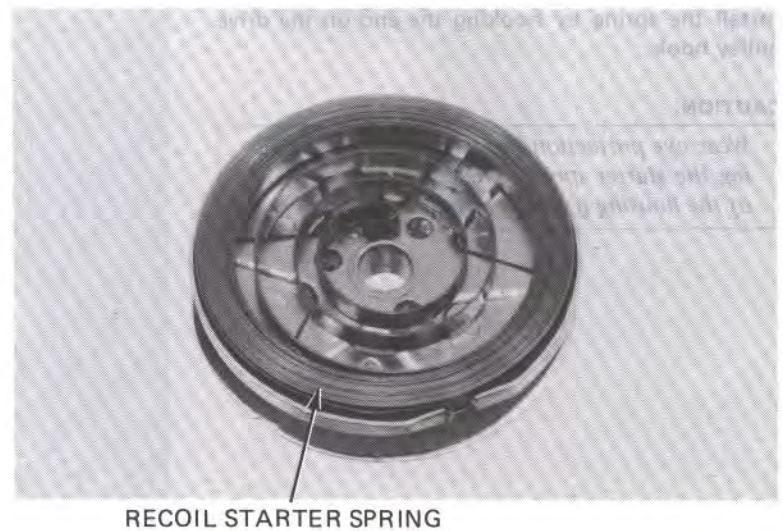



RECOIL STARTER/ALTERNATOR/CAM CHAIN TENSIONER

Check the recoil starter housing for wear or a bent spring hook. Replace if necessary.

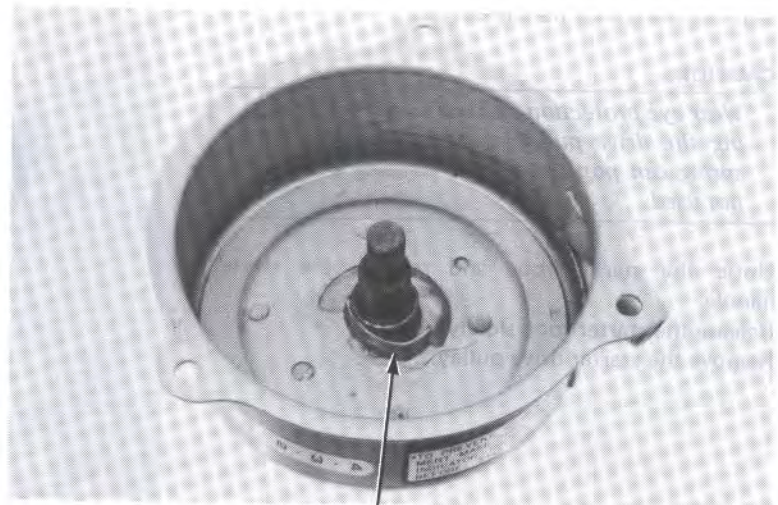

SPRING HOOK

ASSEMBLY

Install the starter rope and tie the end in a square knot.

Wrap the rope around the starter pulley in a clockwise direction as viewed from the ratchet side.

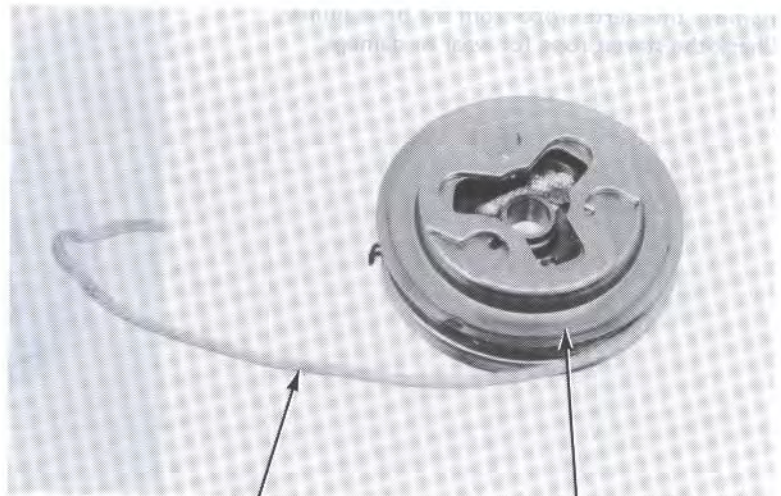

ROPE

DRIVE PULLEY

Install the spring by hooking the end on the drive pulley hook.

CAUTION:

Wear eye protection and use care when installing the starter spring. The spring can pop out of the housing if care is not used.

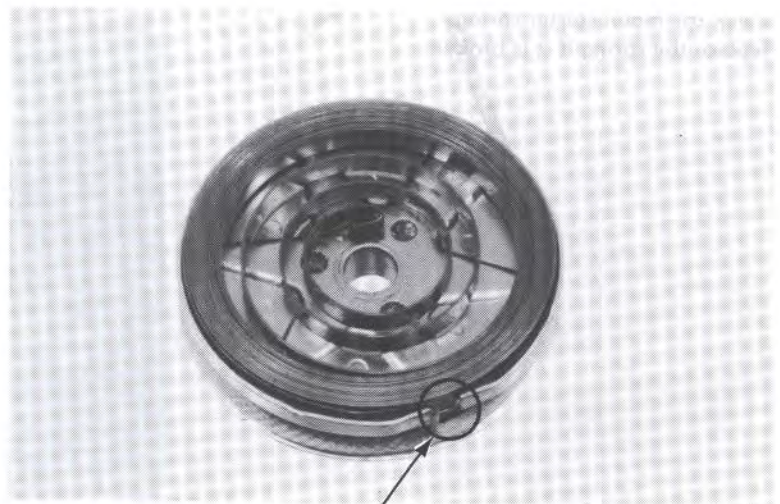

HOOK



Apply grease to the pulley shaft and install the drive pulley by hooking the end of the spring on the housing spring hook.

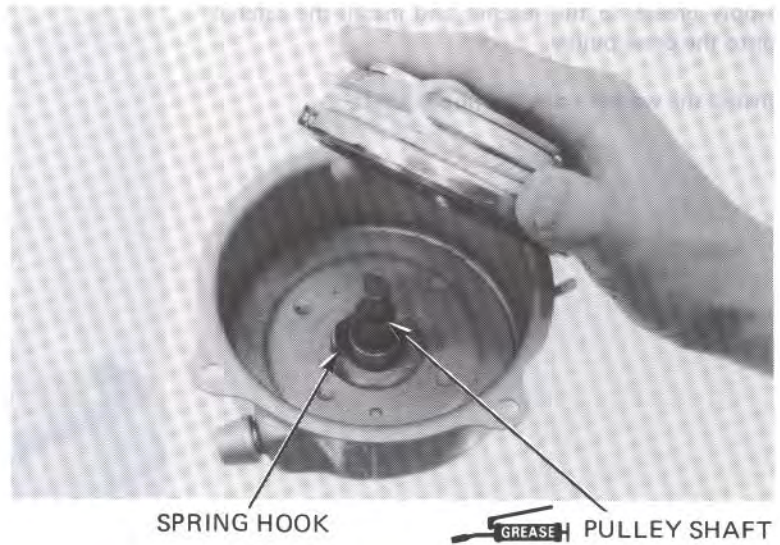

Preload the starter spring by turning the pulley 2 turns clockwise.

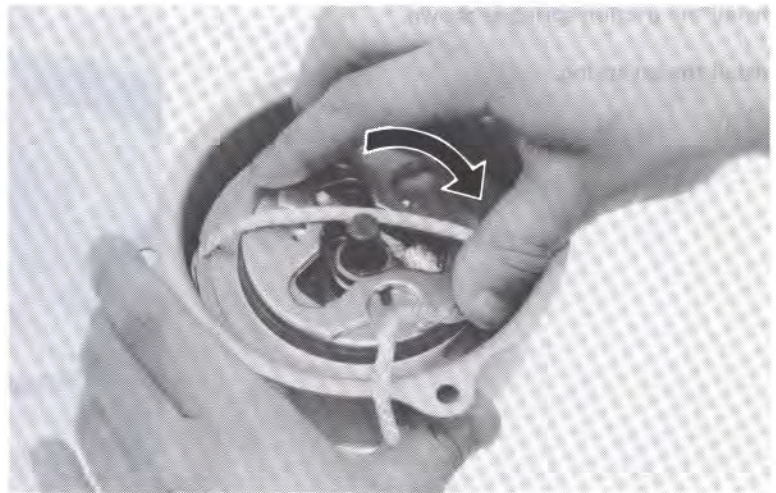

Route the rope end through the starter housing hole and install the handle.

Tie the rope end and install the handle cover.





Apply grease to the ratchet and install the ratchet onto the drive pulley.

Install the washer onto the pulley shaft.

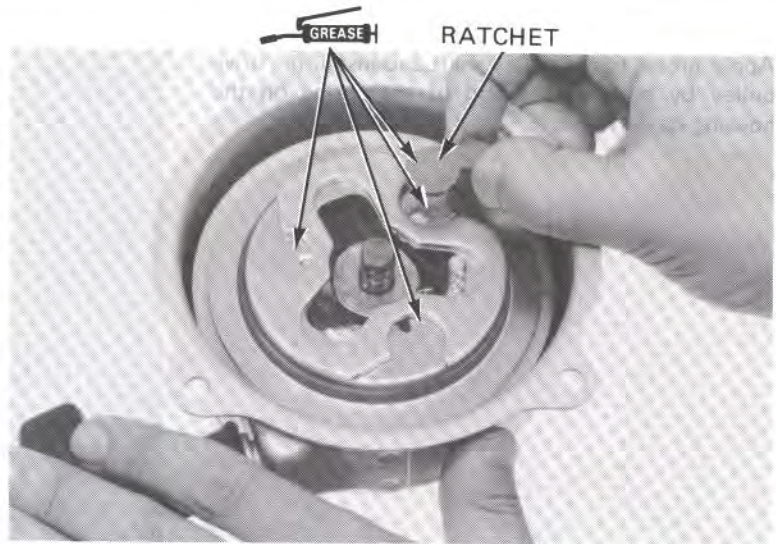

Install the friction spring as shown.

Install the set spring.

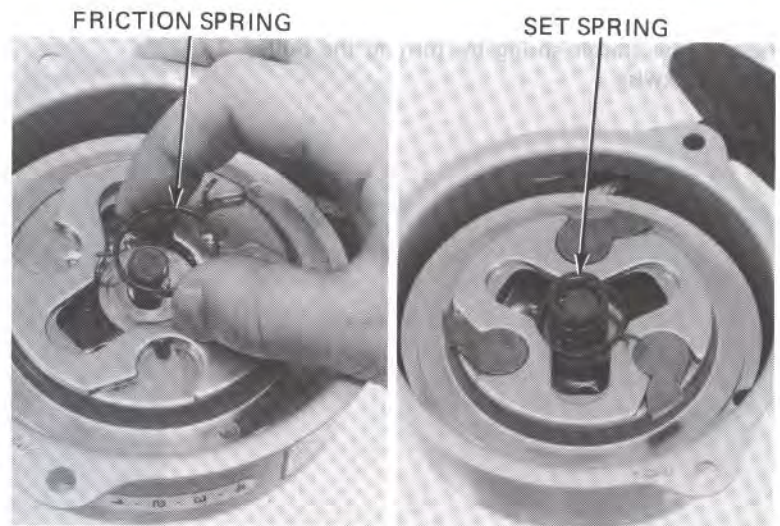

Install the ratchet cover and hook the friction spring into the ratchet cover.
Install the washer and E-clip.

Check the recoil starter operation by pulling the starter handle.

INSTALLATION

Install the starter gasket and recoil starter with the three screws.

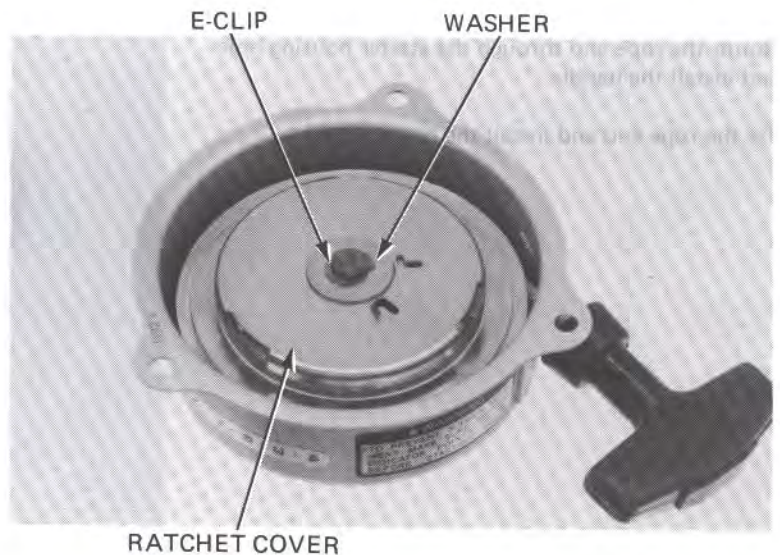



ALTERNATOR

LEFT CRANKCASE COVER REMOVAL

Remove the drive chain cover (Page 12-7).
Remove the recoil starter (Page 9-2).

Remove the neutral indicator by removing the E-clip.

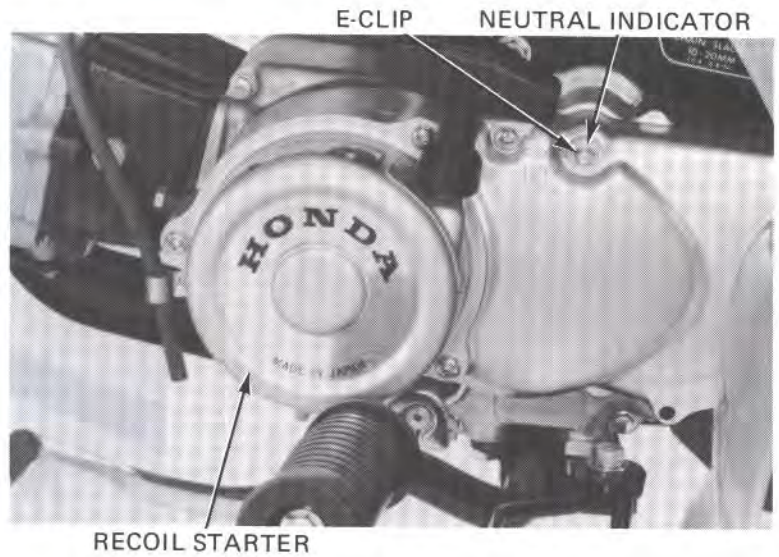

Remove the two screws and remove the left crankcase cover.

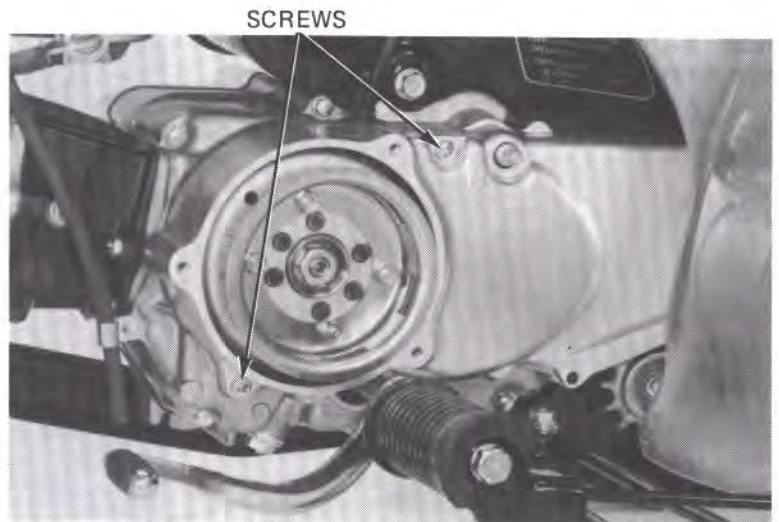

STATOR REMOVAL

Remove the exhaust pipe (Page 5-2).
Remove the foot peg (Page 12-12).

Remove the starter driven pulley by removing the four attaching bolts.

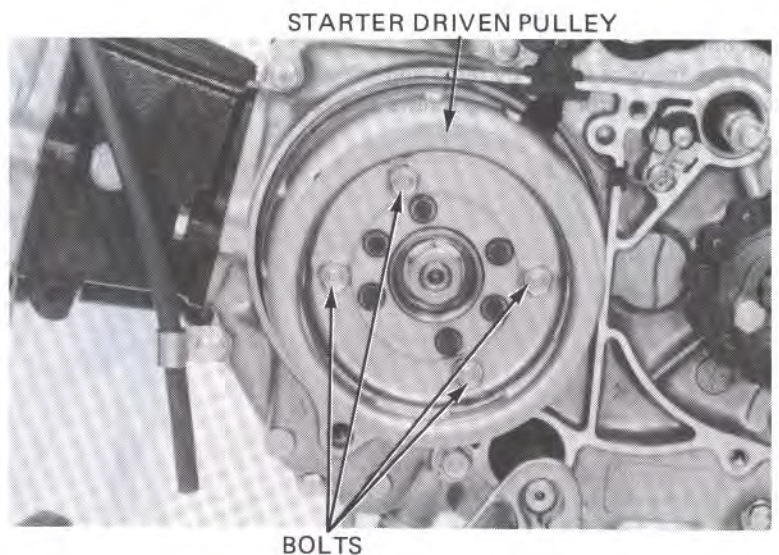



RECOIL STARTER/ALTERNATOR/CAM CHAIN TENSIONER

UNIVERSAL HOLDER 07725-0030000
or Equivalent commercially available in U.S.A.

Hold the flywheel and remove the flywheel nut.

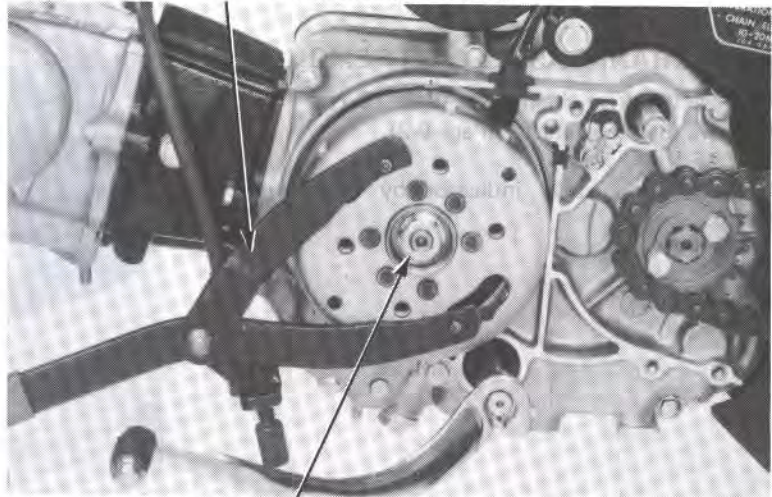

FLYWHEEL NUT

FLYWHEEL PULLER 07733-0010000
or 07933-0010000

Install the rotor puller and remove the flywheel from the crankshaft.

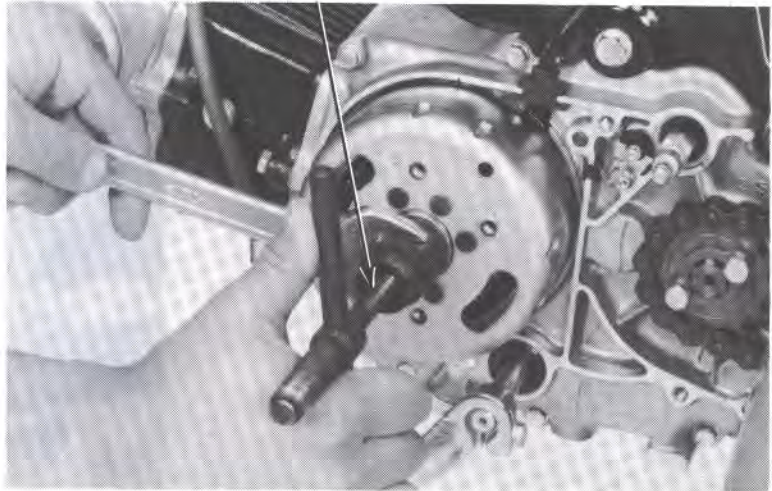

Disconnect the stator cable.
Remove the wire clamp by removing the screw.
Remove the stator attaching screws and the stator.

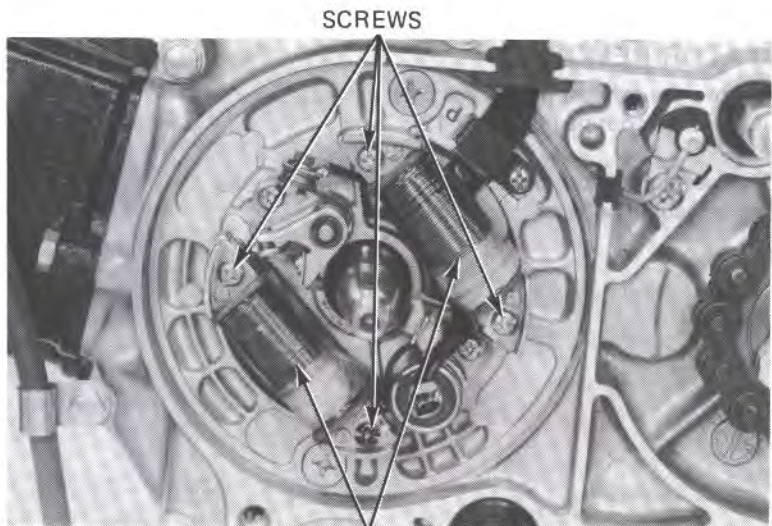

SCREWS

STATORS



STATOR INSTALLATION

Install the stator in the reverse order of removal.

Tighten the flywheel nut.

TORQUE: 33–38 N·m (3.3–3.8 kg·m, 24–27 ft·lb)

Route the stator cable correctly (Page 1-7).

LEFT CRANKCASE INSTALLATION

Install the left crankcase in the reverse order of removal.

UNIVERSAL HOLDER 07725-0030000 or
Equivalent commercially available in U.S.A.

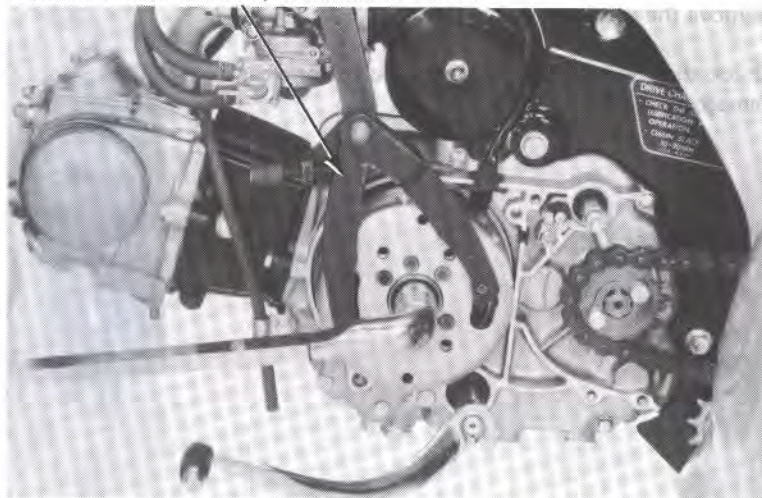

CAM CHAIN TENSIONER

REMOVAL

Remove the recoil starter and left crankcase cover.

Drain the engine oil (Page 2-2).

Remove the stator base screws and remove the stator base.

BASE SCREWS

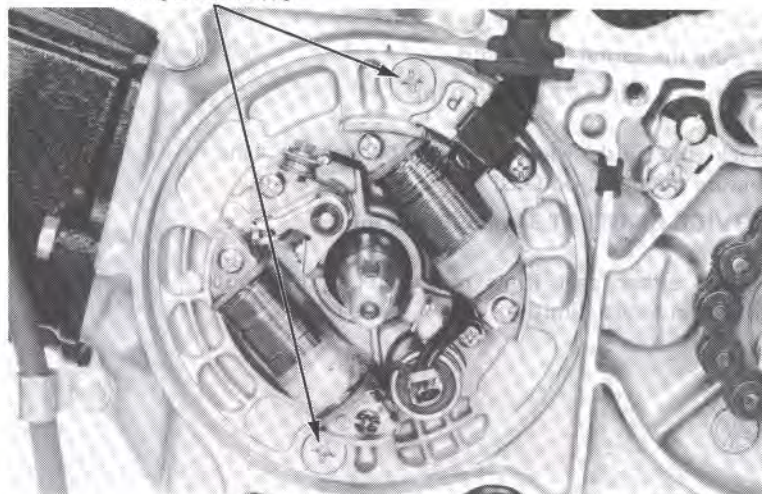

Remove the cam chain tensioner sealing bolt, spring and push rod.

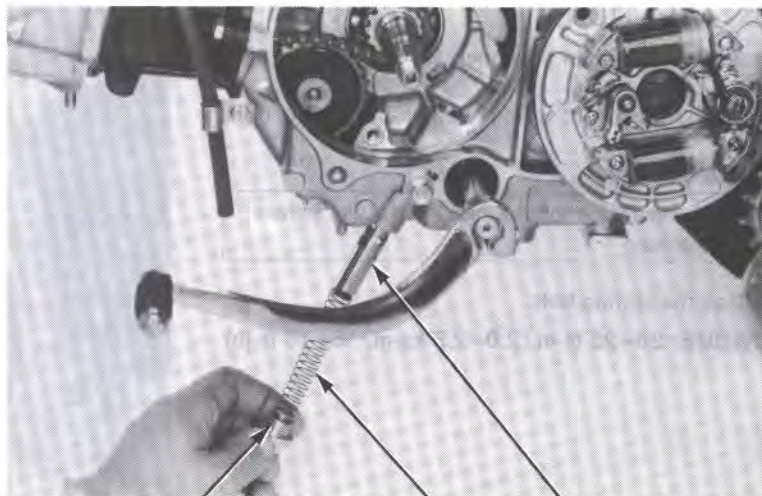

CAM CHAIN TENSIONER SPRING PUSH ROD
SEALING BOLT



RECOIL STARTER/ALTERNATOR/CAM CHAIN TENSIONER

Remove the cam chain tensioner.

Check the cam chain tensioner sprocket for wear or damage.

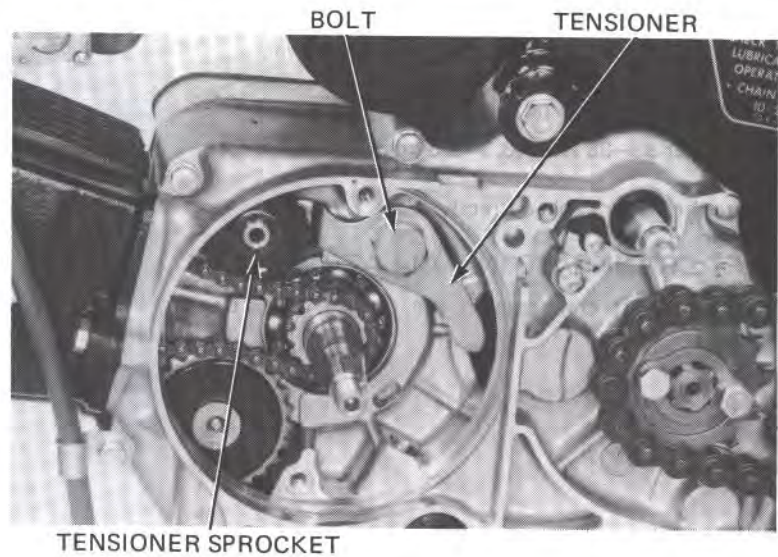

INSPECTION

Measure the spring free length.

SERVICE LIMIT: 77 mm (3.0 in)

Check the push rod for wear or damage, and measure the push rod O.D.

SERVICE LIMIT: 11.94 mm (0.470 in)

Replace either part if its measurement does not fall within service limit.

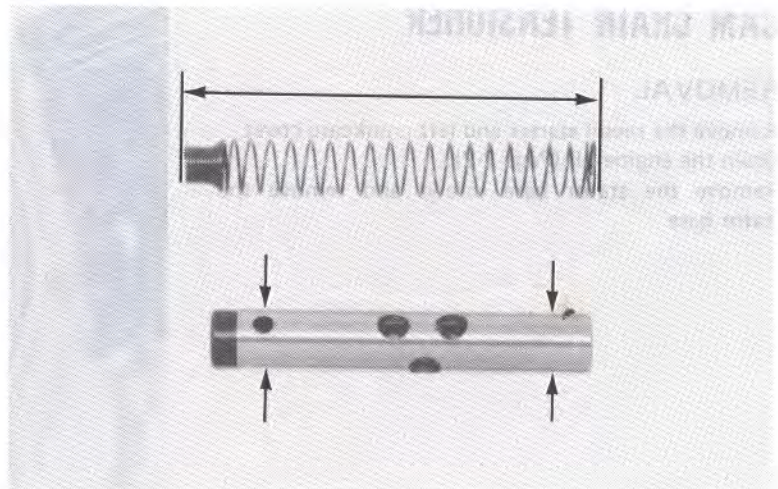

INSTALLATION

Install the cam chain tensioner.

Install the push rod, spring, washer and sealing bolt.

NOTE:

Check operation of the push rod valve before installation.

Tighten the sealing bolt.

TORQUE: 20–25 N·m (2.0–2.5 kg·m, 15–18 ft·lb)

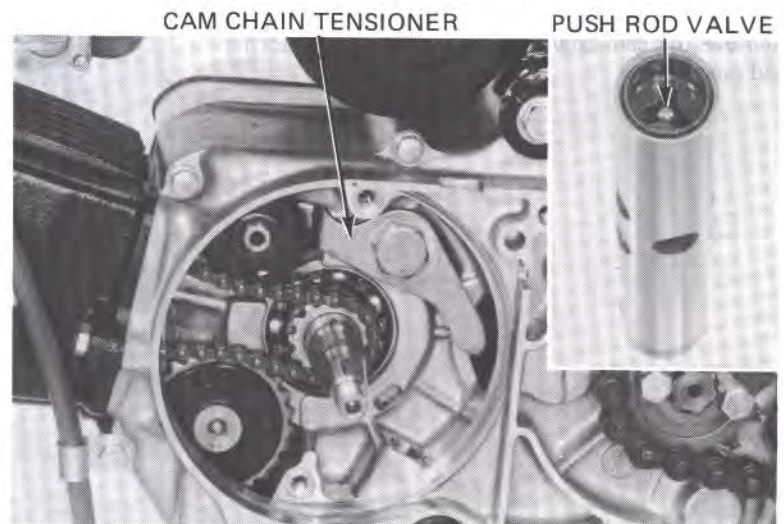



Install the O-rings on the stator base and stator base screw holes.

Install the stator base and tighten the screws.

Install the left crankcase cover and recoil starter (Pages 9-6 and 9-9).

Pour clean engine oil through the oil bolt hole until oil flows out of the hole.

Install the oil bolt.

NOTE:

- Use the proper length bolt.
- A longer bolt may interfere with the push rod.

Fill the engine with the recommended oil (Page 2-1).

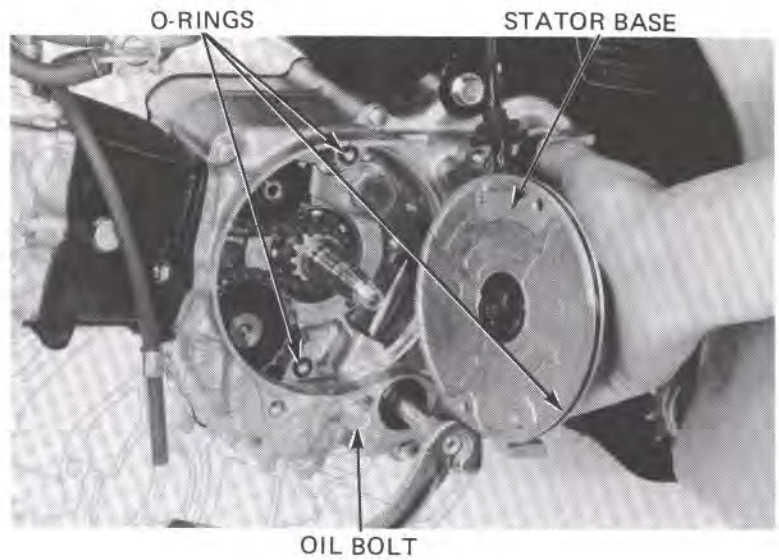



10-14 N·m
(1.0-1.4 kg·m, 7-10 ft·lb)

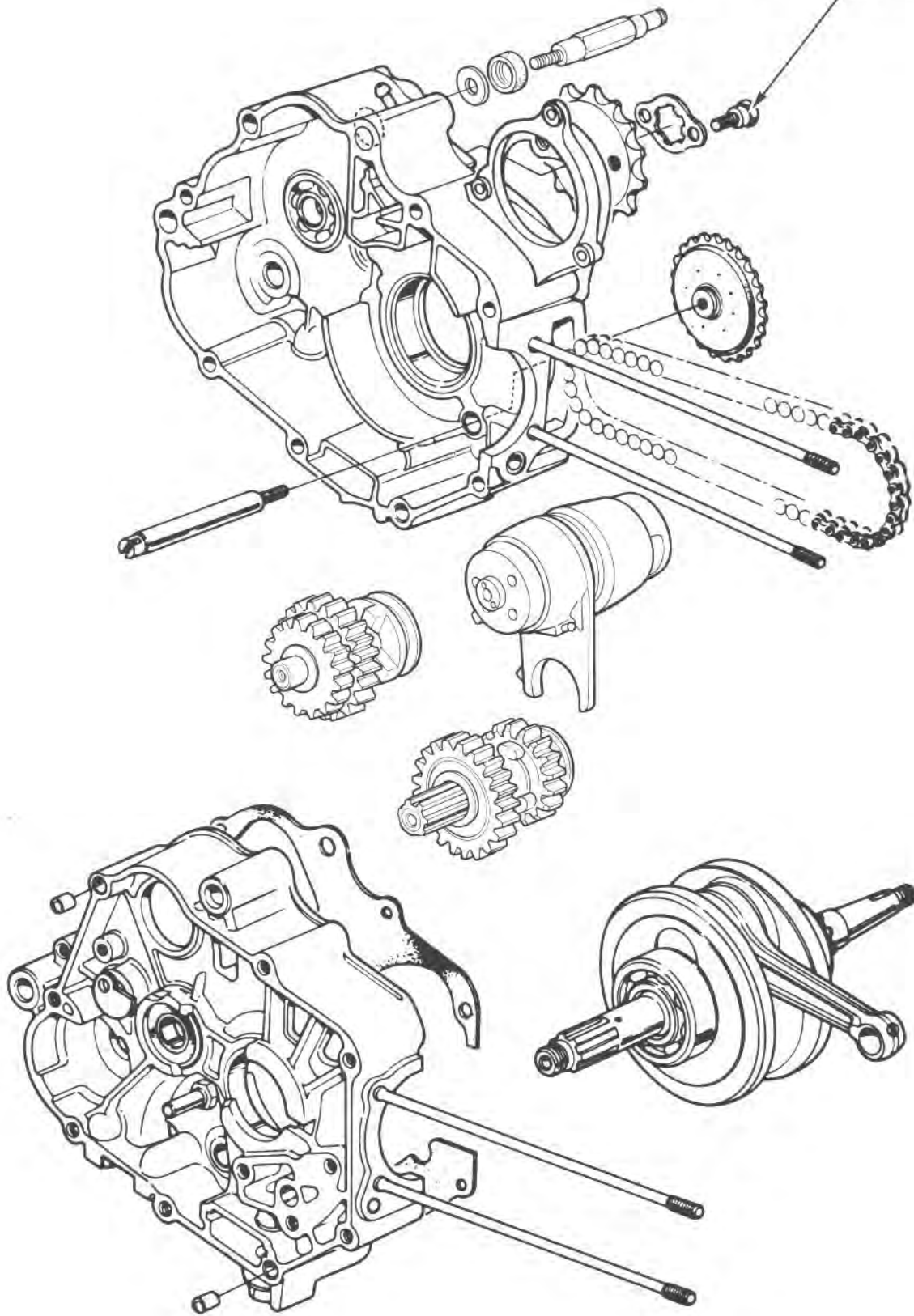



SERVICE INFORMATION	10-1	TRANSMISSION DISASSEMBLY	10-6
TROUBLESHOOTING	10-2	TRANSMISSION ASSEMBLY	10-9
CRANKCASE SEPARATION	10-3	CRANKCASE ASSEMBLY	10-10
CRANKSHAFT REMOVAL	10-4		

SERVICE INFORMATION

GENERAL

- The crankcase must be separated to service the crankshaft and transmission components.
- The following parts must be removed before separating the crankcase.
 - Cylinder head Section 6
 - Cylinder and piston Section 7
 - Clutch Section 8
 - Gearshift linkage Section 8
 - Alternator Section 9
 - Recoil starter Section 9

SPECIFICATIONS

ITEM		STANDARD	SERVICE LIMIT
Transmission	Gear I.D.	M2, M4, C3	17.016–17.043 mm (0.6699–0.6710 in)
		C1	17.006–17.018 mm (0.6695–0.6700 in)
	Mainshaft O.D.	16.983–16.994 mm (0.6686–0.6691 in)	16.95 mm (0.667 in)
	Countershaft O.D.	16.966–16.984 mm (0.6680–0.6687 in)	16.95 mm (0.667 in)
	Shift drum O.D.	33.950–33.975 mm (1.3366–1.3376 in)	33.93 mm (1.336 in)
	Shift fork I.D.	34.000–34.025 mm (1.3386–1.3396 in)	34.07 mm (1.341 in)
	Shift fork claw thickness	4.86–4.94 mm (0.191–0.195 in)	4.6 mm (0.18 in)
Crankshaft	Connecting rod big end side clearance	0.10–0.35 mm (0.004–0.014 in)	0.6 mm (0.02 in)
	Connecting rod big end radial clearance	0–0.012 mm (0–0.0005 in)	0.05 mm (0.002 in)
	Runout	—	0.10 mm (0.004 in)

TORQUE VALUE

Final drive sprocket 10–14 N·m (1.0–1.4 kg·m, 7–10 ft·lb)



TRANSMISSION/CRANKSHAFT

TOOL

Attachment 37 x 40 mm	07746-0010200
Pilot 17 mm	07746-0040400
Driver	07749-0010000
Attachment 17 mm I.D.	07746-0020300
Attachment 20 mm I.D.	07746-0020100
Driver I.D.	07746-0020400

TROUBLESHOOTING

Hard to shift

- Improper clutch adjustment
- Shift fork bent
- Shift shaft bent
- Shift drum stopper arm bent

Transmission jumps out of gear

- Gear dogs worn
- Shift shaft bent
- Shift drum stopper broken
- Shift forks bent

Excessive noise

- Excessive crankshaft bearing play
- Excessive connecting rod big end bearing play



CRANKCASE SEPARATION

Remove the following:

- The engine (Section 5).
- The cylinder head (Section 6).
- The cylinder and piston (Section 7).
- The clutch (Section 8).
- The gearshift linkage (Section 8).
- The recoil starter (Section 9).
- The left crankcase cover (Section 9).
- The flywheel (Section 9).
- the drive sprocket by removing the two bolts.

Remove the two stator base attaching screws and pull out the stator base.

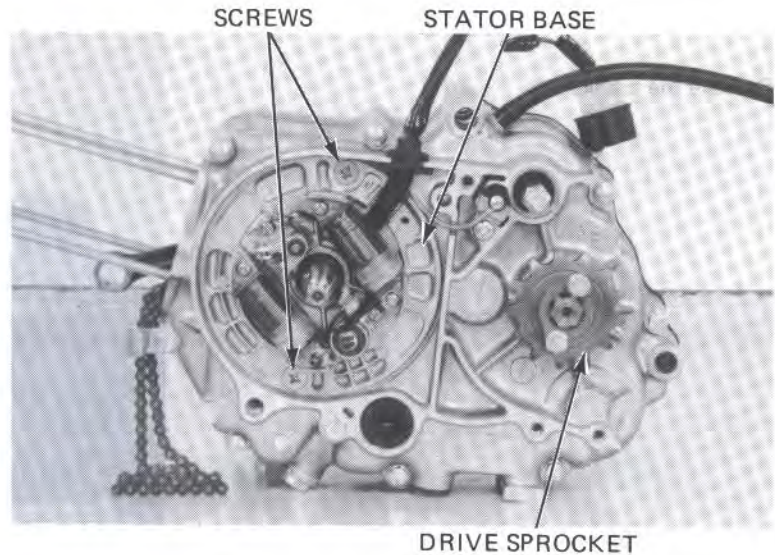

Remove the cam chain, cam chain tensioner sealing bolt, spring, push rod, and cam chain tensioner (Page 9-9).

Remove the neutral indicator shaft.

Remove the eight crankcase bolts.

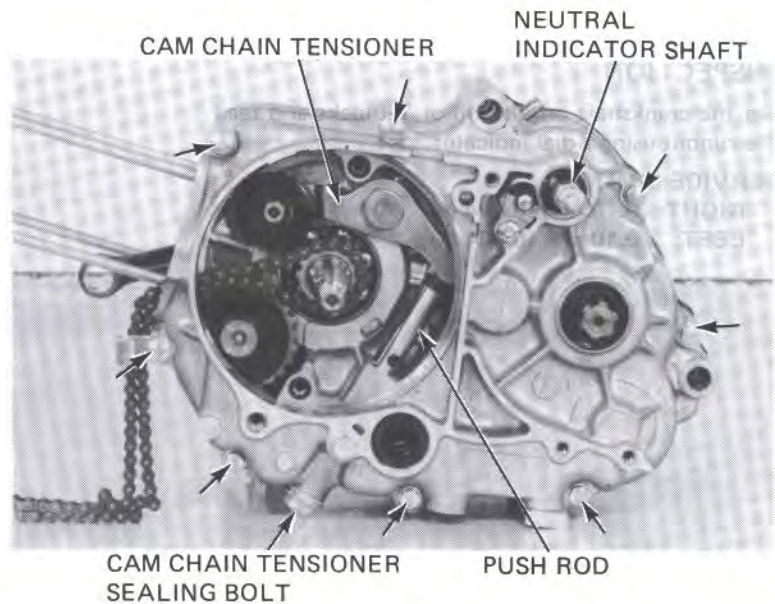

Place the engine with the right side facing up.

Separate the right crankcase from the left crankcase.

Remove the dowel pins and gasket.

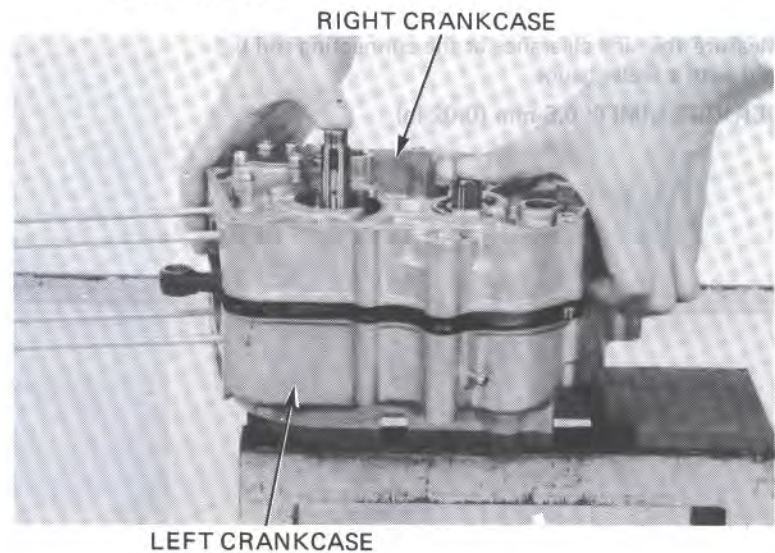



CRANKSHAFT REMOVAL

Remove the crankshaft.

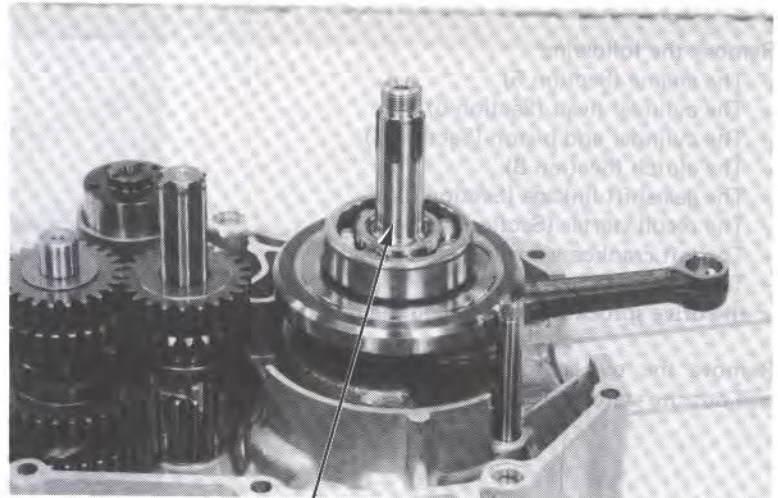

CRANKSHAFT

INSPECTION

Set the crankshaft on a stand or V-blocks and read the runout using a dial indicator.

SERVICE LIMITS:

RIGHT: 0.10 mm (0.004 in)

LEFT: 0.10 mm (0.004 in)

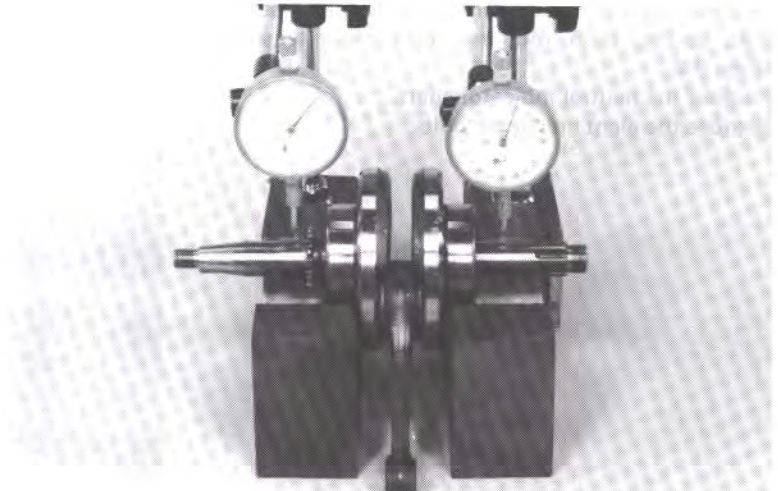

Measure the side clearance at the connecting rod big end with a feeler gauge.

SERVICE LIMIT: 0.6 mm (0.02 in)





Measure the radial clearance at the connecting rod big end, at two points in the direction indicated by the arrows.

SERVICE LIMIT: 0.05 mm (0.002 in)

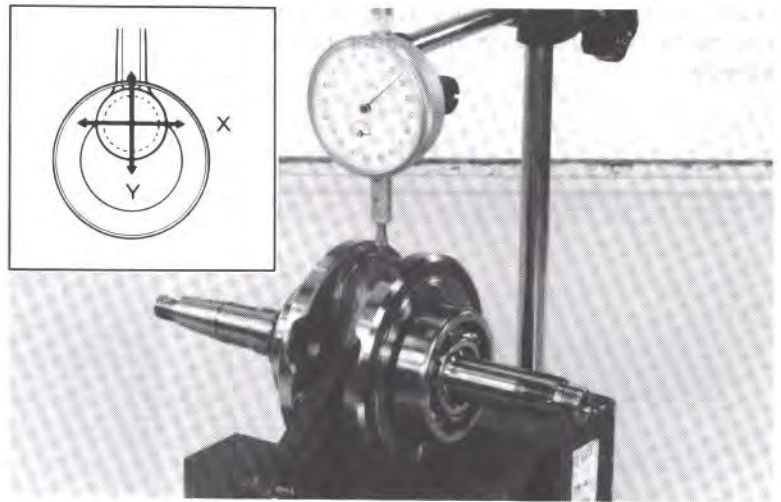

Spin the crankcase bearing by hand and check for play.

The bearing must be replaced if it is noisy or has excessive play.

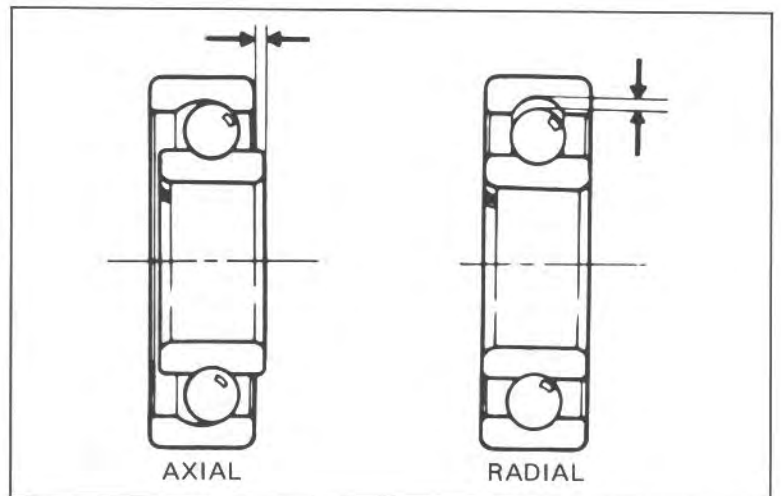

TIMING SPROCKET INSPECTION

Inspect the timing sprocket teeth for wear or damage. Replace if necessary.

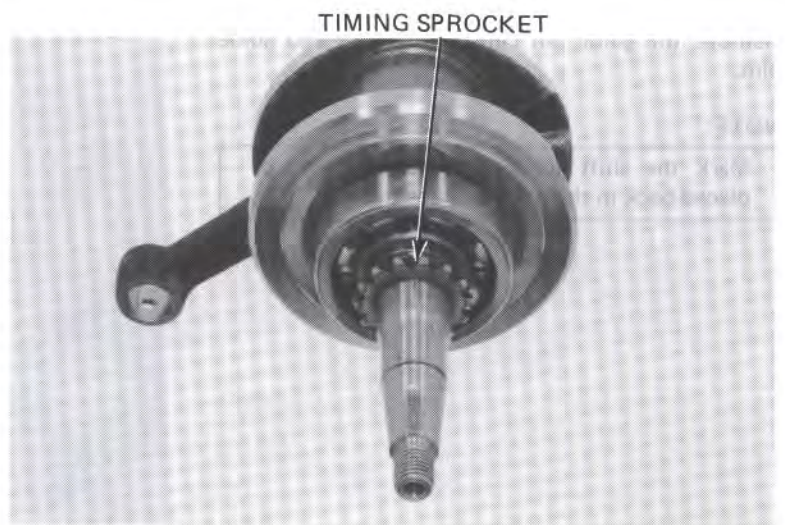



TRANSMISSION/CRANKSHAFT

Install the sprocket so that the valley between any two teeth is aligned with the center line of the keyway.

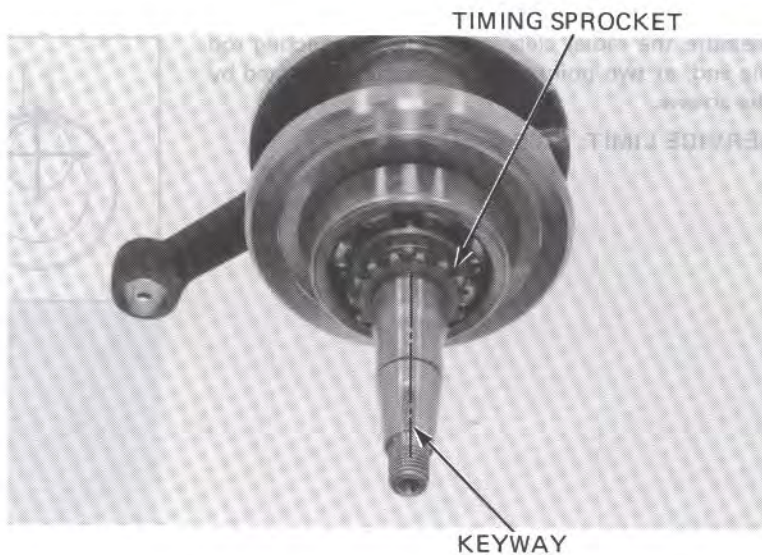

TRANSMISSION DISASSEMBLY

Remove the transmission and gearshift drum as an assembly.

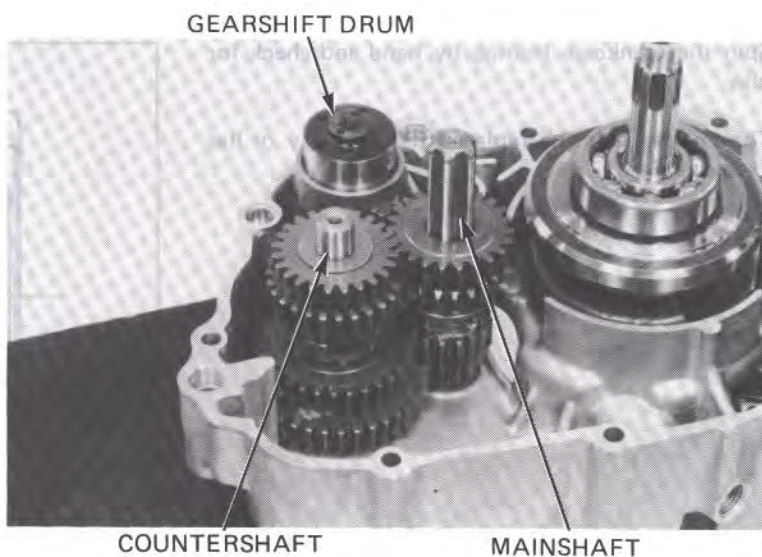

Remove the guide pin clips, shift forks and guide pins.

NOTE:

Mark the shift forks so that they can be placed back in their original positions.

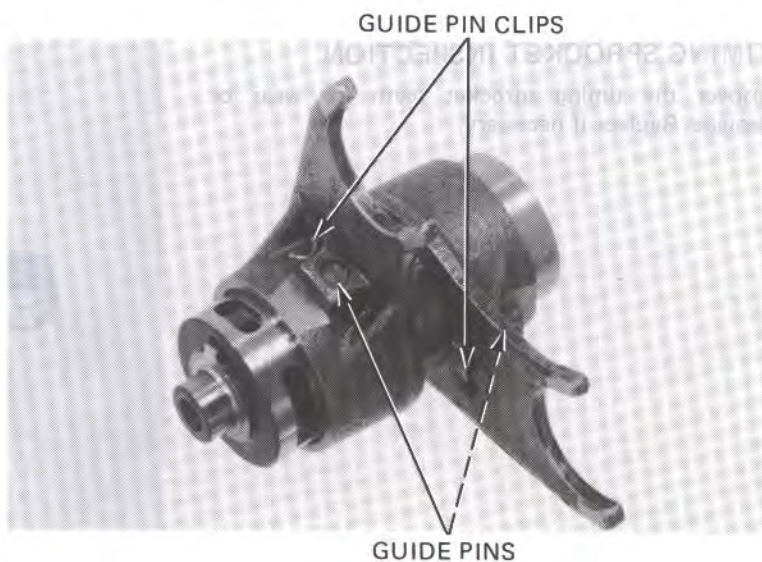



Check the shift forks for wear, bending or damage.

Measure the I.D. of the shift forks.

SERVICE LIMIT: 34.07 mm (1.341 in)

Measure the shift fork end thickness.

SERVICE LIMIT: 4.6 mm (0.18 in)

Inspect the guide pins for wear or damage.

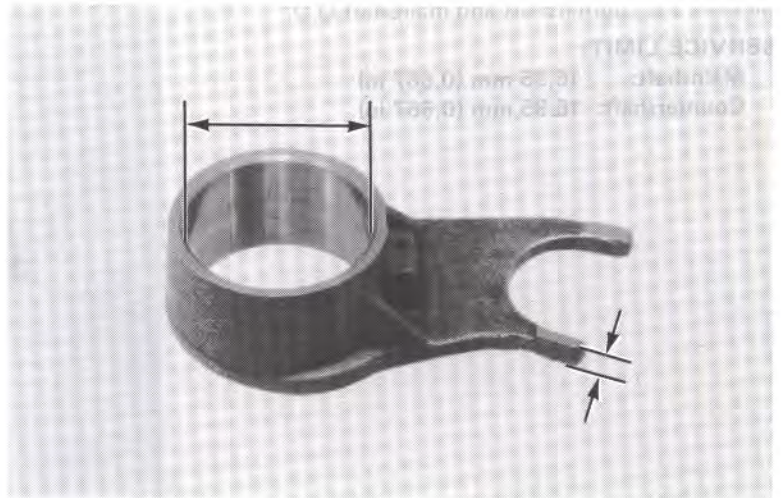

Measure the gearshift drum O.D.

SERVICE LIMIT: 33.93 mm (1.336 in)

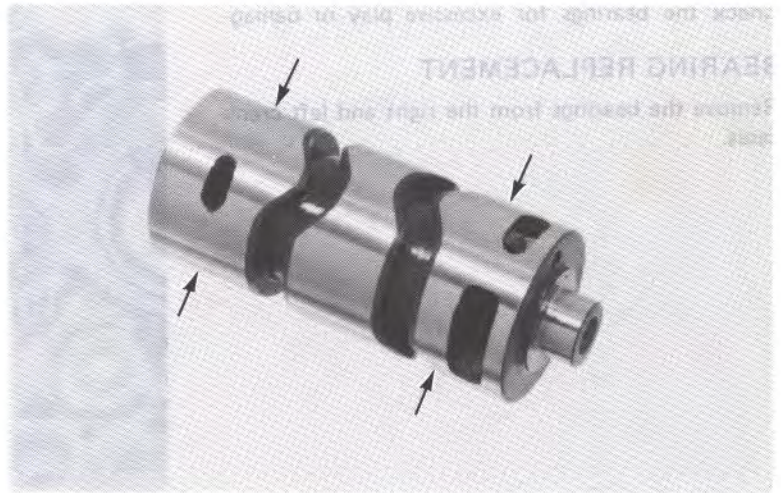

Remove the transmission gears.

Measure each gear's I.D.

SERVICE LIMITS:

C1: 17.07 mm (0.672 in)

M2, M4, C3: 17.10 mm (0.673 in)

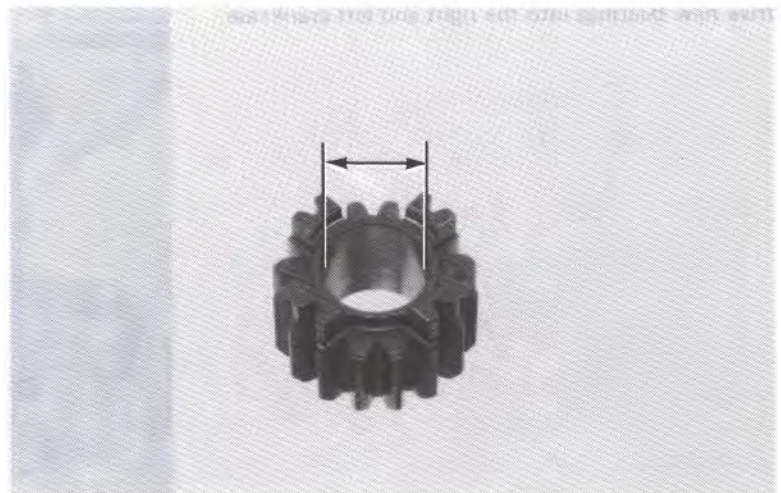



TRANSMISSION/CRANKSHAFT

Measure the countershaft and mainshaft O.D.

SERVICE LIMIT:

Mainshaft: 16.95 mm (0.667 in)

Countershaft: 16.95 mm (0.667 in)

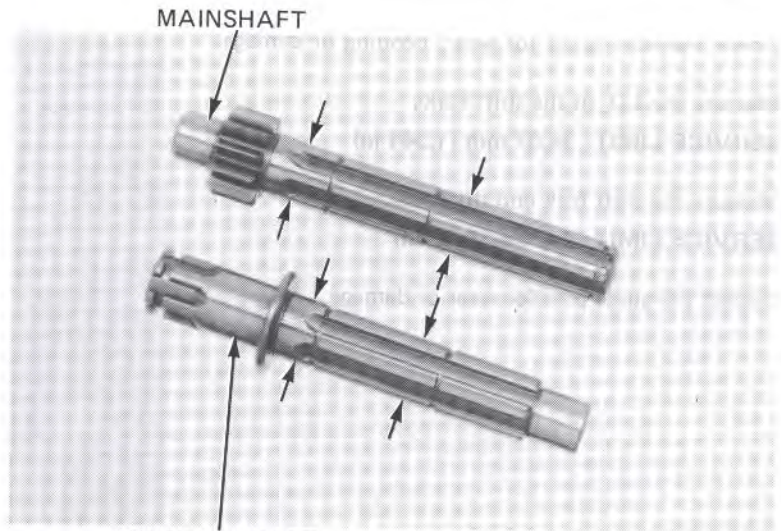

MAINSHAFT

COUNTERSHAFT
MAINSHAFT
BEARING

Check the bearings for excessive play or damage.

BEARING REPLACEMENT

Remove the bearings from the right and left crankcases.

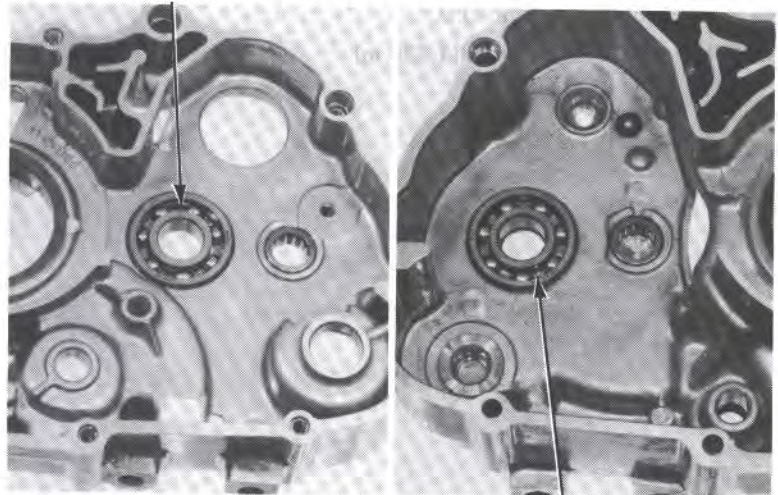

COUNTERSHAFT
BEARING

Drive new bearings into the right and left crankcase.

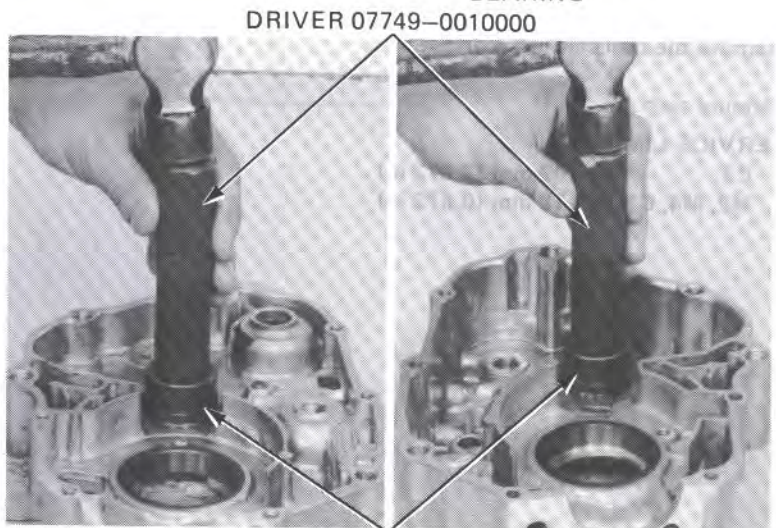

DRIVER 07749-0010000

ATTACHMENT 37 x 40 mm 07746-0010200
PILOT 17 mm 07746-0040400



TRANSMISSION ASSEMBLY

Coat all parts with clean engine oil.

Assemble the transmission shafts and gears noting the locations of the thrust washers and snap rings.

NOTE:

Make sure the snap rings are seated properly.

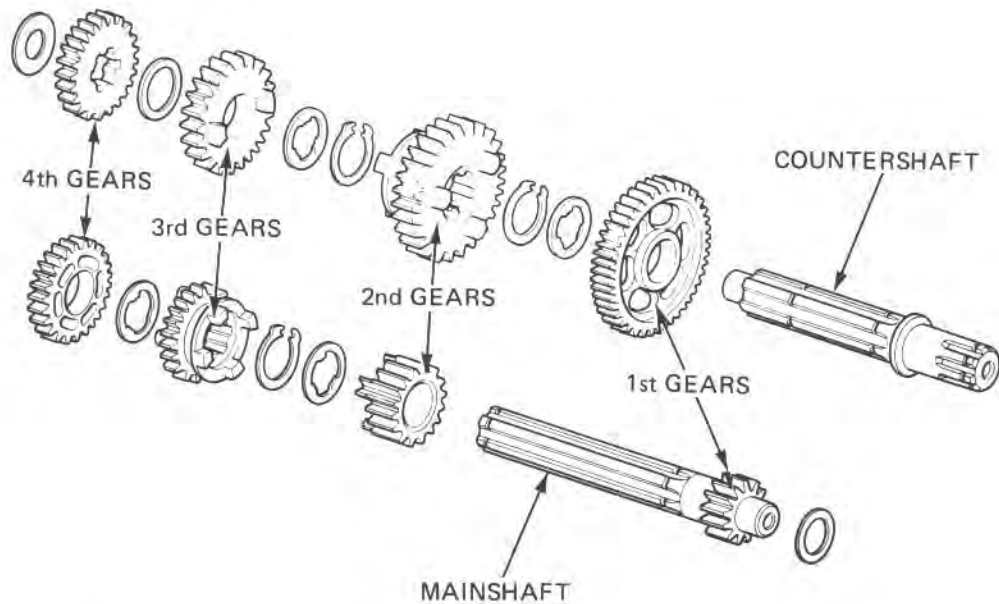

Install the shift forks in the original positions from which they were removed.

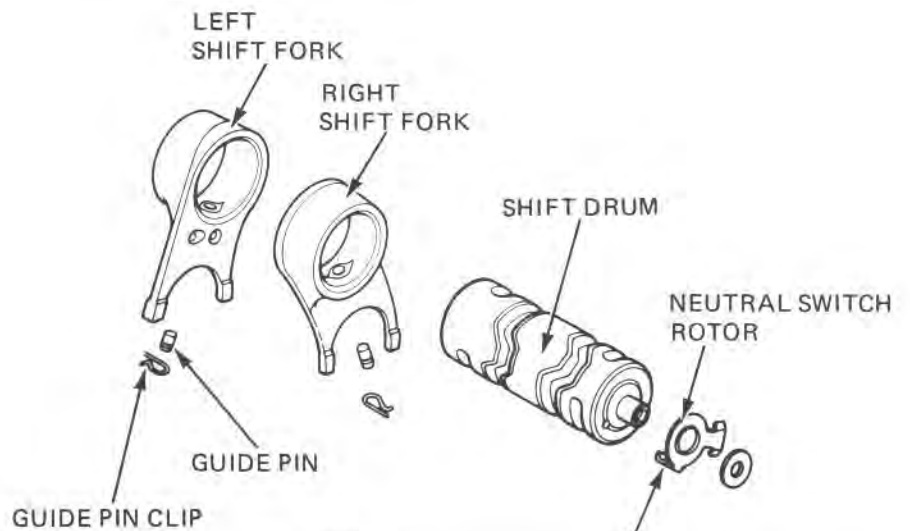

NOTE:

Bend the tab of the rotor into the drum.



OIL PUMP DRIVE SPROCKET INSPECTION

Inspect the oil pump drive sprocket for wear or damage.
Replace if necessary.

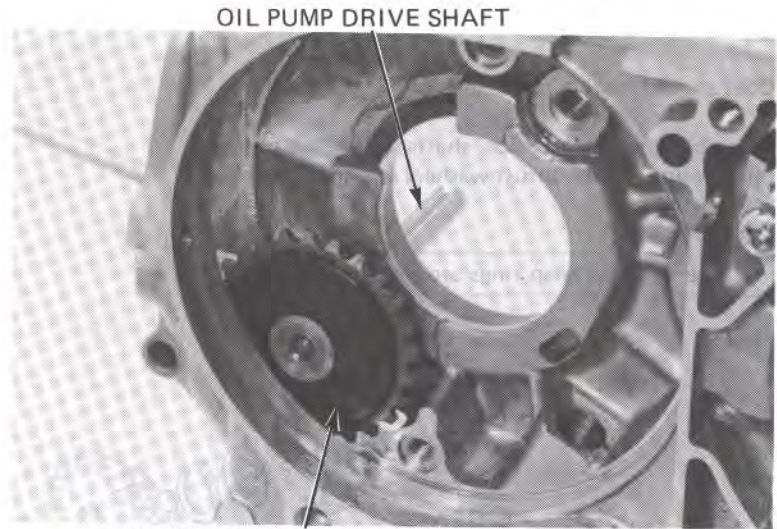

OIL PUMP DRIVE SHAFT

OIL PUMP DRIVE SPROCKET

CRANKCASE ASSEMBLY

Apply clean engine oil to the crankshaft before assemble.
Install the crankshaft.

Assemble the gearshift drum, countershaft and mainshaft.

Install the gearshift drum, countershaft and mainshaft assemblies together in the left crankcase.

Rotate the mainshaft by hand to make sure the gears rotate freely.

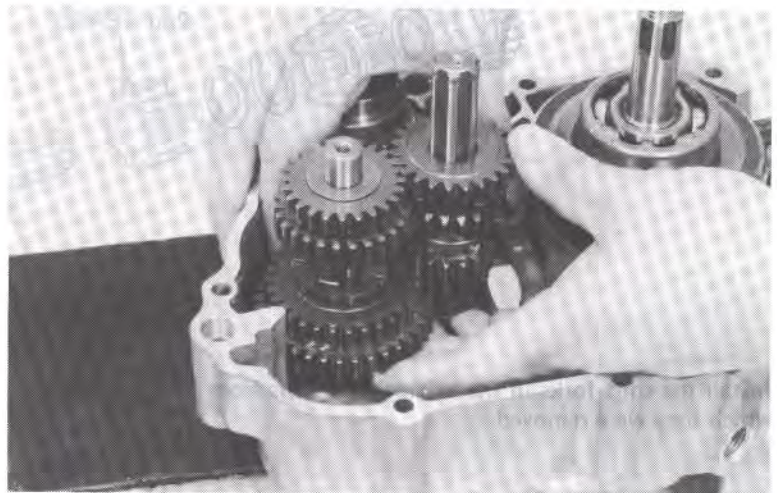

Install the dowel pins and new gasket.

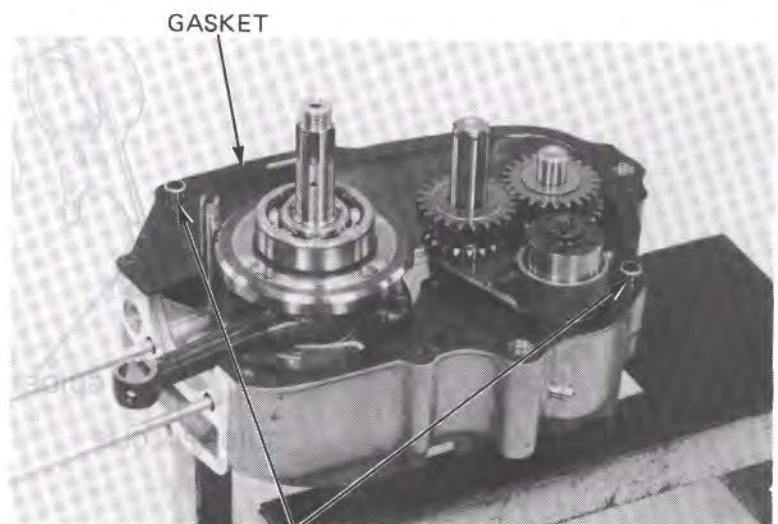

GASKET

DOWEL PINS



Assemble the right and left crankcase halves.

NOTE:

Make sure that the gasket stays in place during this operation.

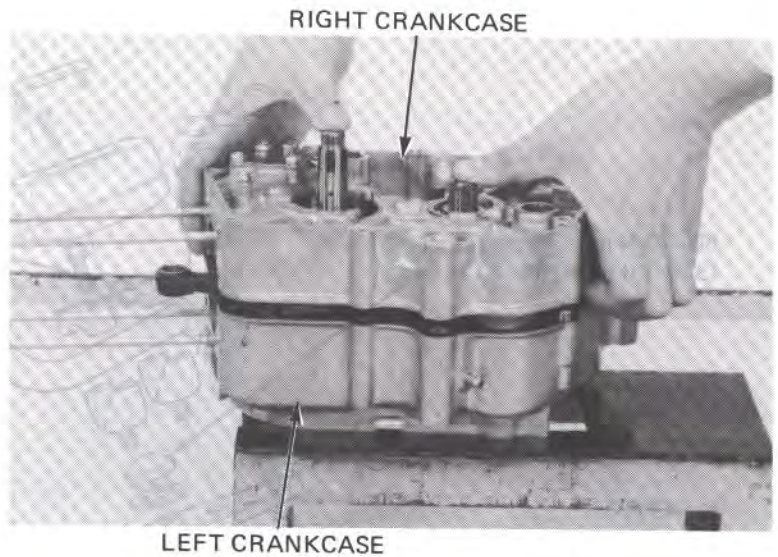

Tighten the crankcase mount bolts.
Install and tighten the neutral indicator shaft.

Install the removed parts in the reverse order of removal (Page 10-3).

TORQUE:

FINAL DRIVE SPROCKET:
10–14 N·m (1.0–1.4 kg·m, 7–10 ft·lb)

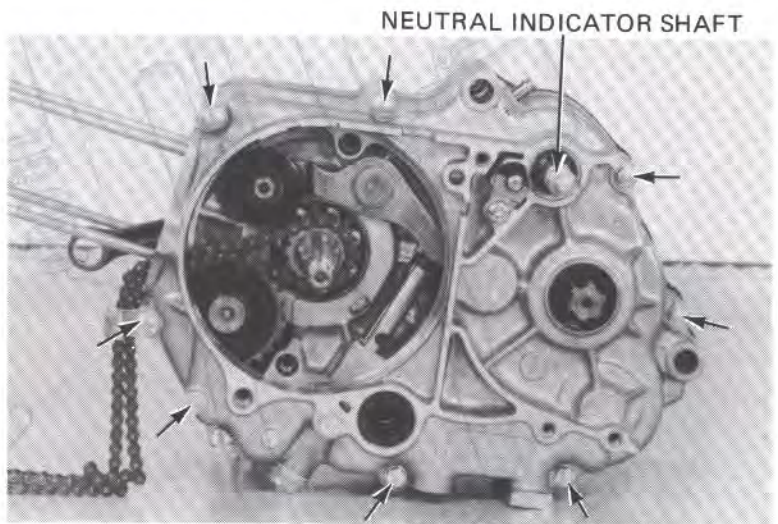



FRONT WHEEL/STEERING

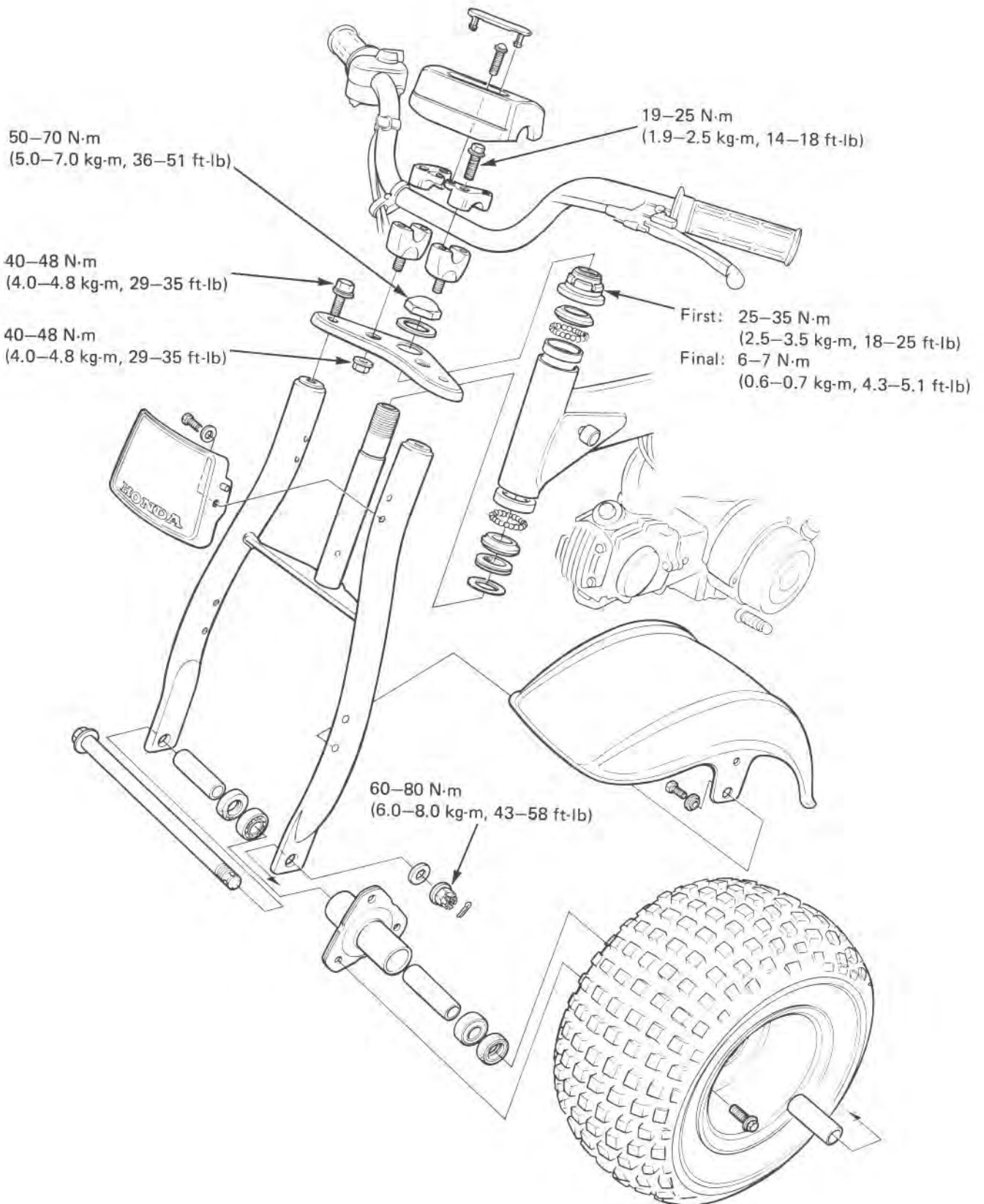



SERVICE INFORMATION	11-1
TROUBLESHOOTING	11-2
HANDLEBAR	11-3
THROTTLE LEVER	11-4
FRONT WHEEL	11-6
STEERING STEM	11-12

SERVICE INFORMATION

GENERAL

- This section covers maintenance of the front wheel and steering system.
- A jack or other support is required to support the ATC.

SPECIFICATIONS

ITEM	STANDARD	SERVICE LIMIT
Front axle runout	—	0.2 mm (0.008 in)
Front wheel rim runout	—	4.0 mm (0.16 in)

TORQUE VALUES

Handlebar upper holder bolt	19–25 N·m (1.9–2.5 kg·m, 14–18 ft·lb)
Handlebar lower holder nut	40–48 N·m (4.0–4.8 kg·m, 29–35 ft·lb)
Fork bridge bolt	40–48 N·m (4.0–4.8 kg·m, 29–35 ft·lb)
Steering stem nut	50–70 N·m (5.0–7.0 kg·m, 36–51 ft·lb)
Front axle nut	60–80 N·m (6.0–8.0 kg·m, 43–58 ft·lb)
Front wheel hub nut	19–25 N·m (1.9–2.5 kg·m, 14–18 ft·lb)
Bearing adjustment nut: First	25–35 N·m (2.5–3.5 kg·m, 18–25 ft·lb)
Final	6–7 N·m (0.6–0.7 kg·m, 4.3–5.1 ft·lb)

TOOLS

Special

Ball race remover	07944–1150001 or M9360–277–91774 (U.S.A. only)
Steering stem driver	07946–GC40000
Universal bend breaker	GN-AH-958-BB1 (U.S.A. only)

Common

Driver	07749–0010000
Attachment, 32 x 35 mm	07746–0010100
Pilot, 15 mm	07746–0040300
Attachment, 37 x 40 mm	07746–0010200
Lock nut wrench, 26 x 30 mm	07716–0020203 or equivalent commercially available in U.S.A.
Lock nut wrench, 30 x 32 mm	07716–0020400 or equivalent commercially available in U.S.A.
Extension	07716–0020500 or equivalent commercially available in U.S.A.
Bearing remover head	07746–0050400
Bearing remover shaft	07746–0050100



FRONT WHEEL/STEERING

TROUBLESHOOTING

Hard steering

- Steering stem nut too tight
- Faulty steering stem bearings
- Damaged steering stem ball race or cone race
- Insufficient tire pressure

Steers to one side or does not track straight

- Bent front forks
- Bent front axle, wheel installed incorrectly

Front wheel wobbling

- Bent rim
- Worn front wheel bearing
- Faulty tire
- Axle nut tightened properly



HANDLEBAR

REMOVAL

Loosen the brake adjuster nut.
Pull the brake cable and disconnect from the brake lever.

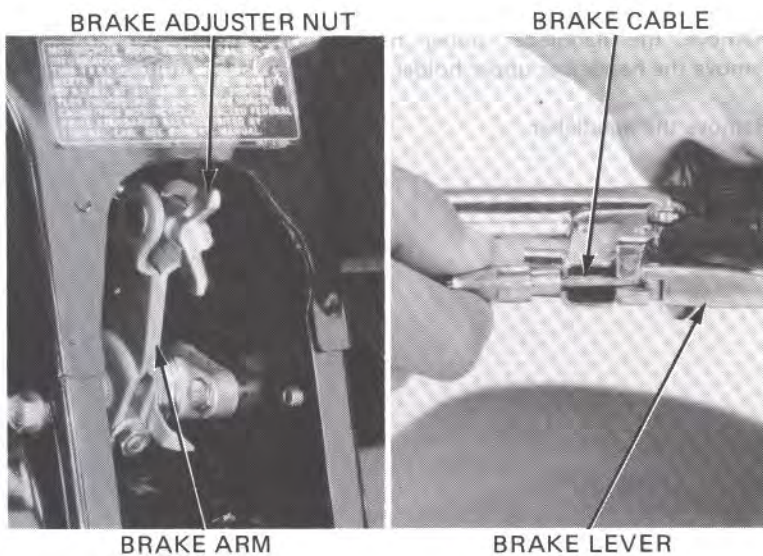

Remove the two throttle case screws and remove the throttle case from the handlebar.

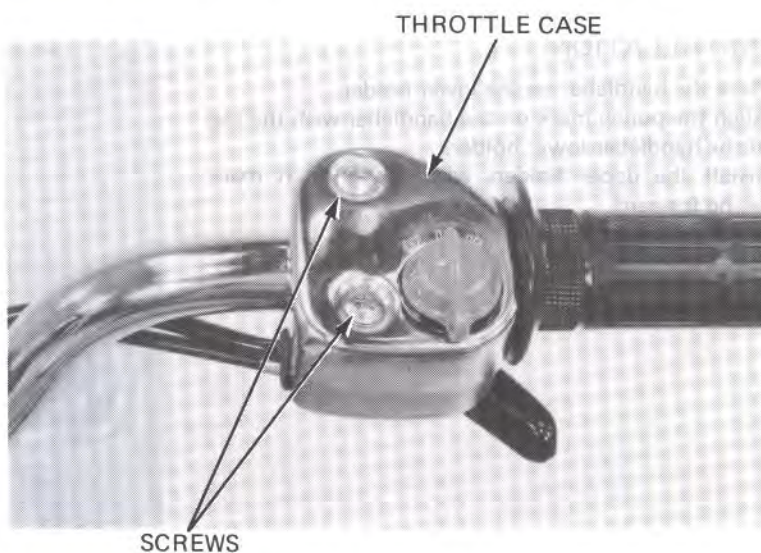

Remove the handlebar upper holder cover cap and remove the two screws, then remove the handlebar upper holder cover.





FRONT WHEEL/STEERING

Remove the handlebar upper holder bolts and remove the handlebar upper holder.

Remove the handlebar.

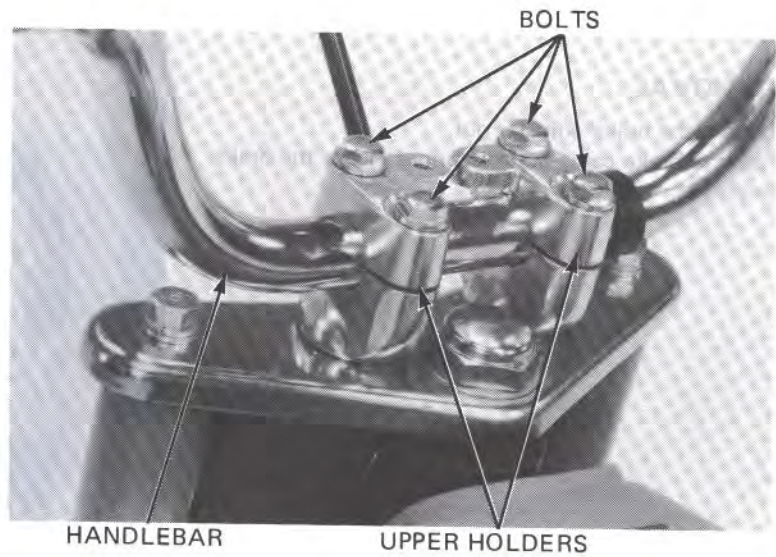

INSTALLATION

Place the handlebar on the lower holder.
Align the punch mark on the handlebar with the top of the handlebar lower holder.
Install the upper holders with the L or R mark facing forward.
Install the throttle case.
Install the brake cable.

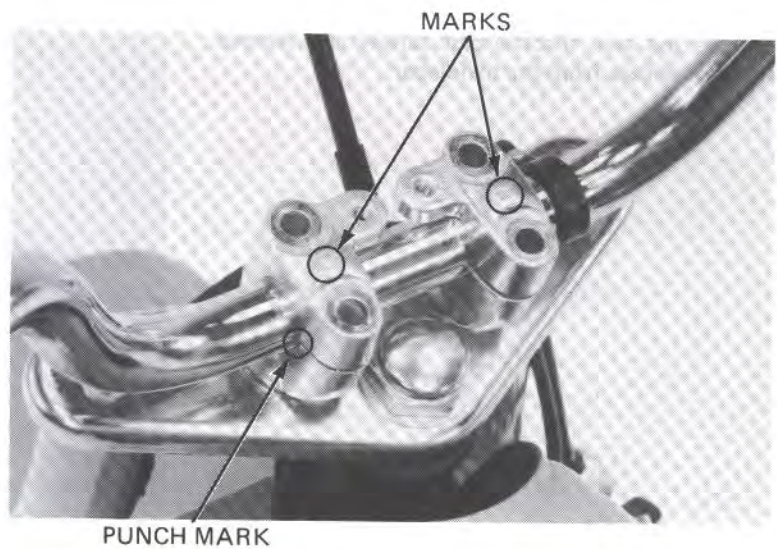

THROTTLE LEVER

DISASSEMBLY

Remove the throttle case from the handlebar (Page 11-3).
Disconnect the throttle cable from the throttle arm.

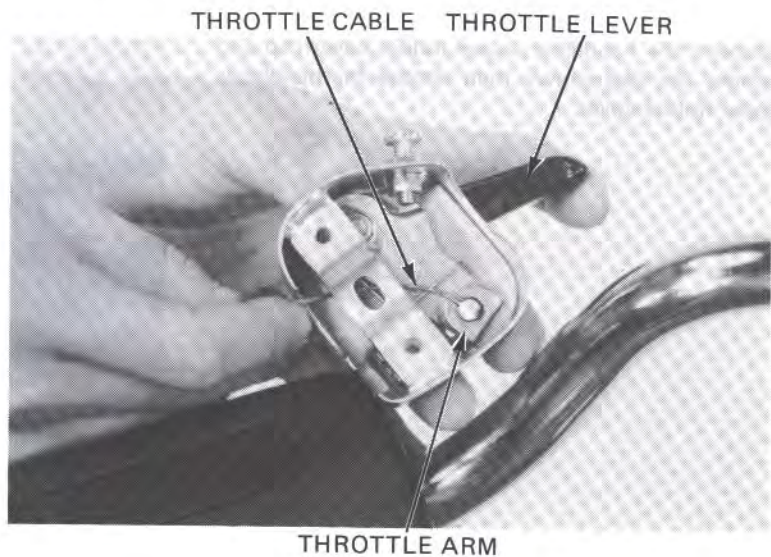



Bend down the lock washer tab and remove the bolt and lock washer.
Remove the throttle lever, arm and spring from the throttle housing.

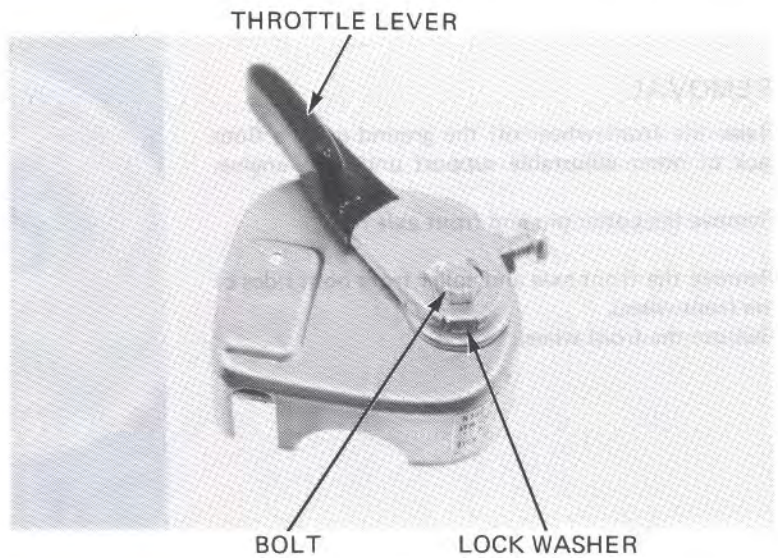

ASSEMBLY

Install the throttle arm, spring and lever into the throttle housing.

Install the throttle lever using the bolt and new lock washer.
Bend up the lock washer tab against the bolt head.

Check the lever for smooth operation.

Apply grease to the throttle cable end and connect the cable to the throttle arm.
Insert the rubber seal into the groove of the throttle case.

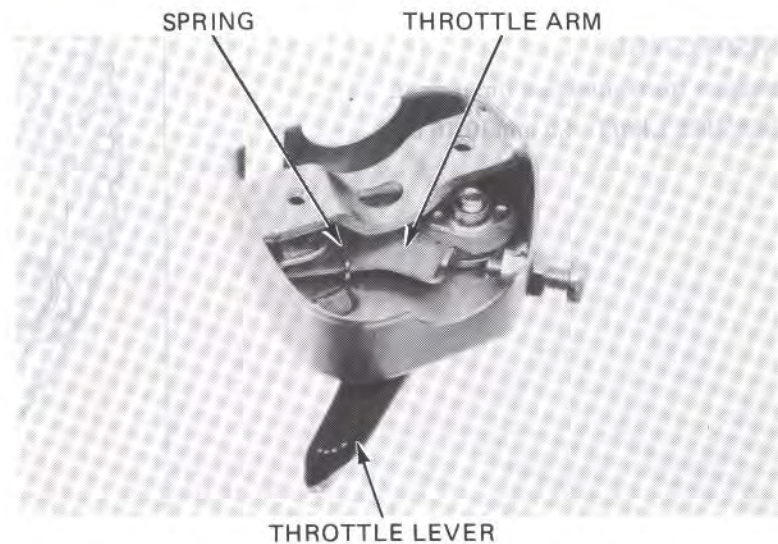

Install the throttle case aligning the slot with the lug.
Tighten the throttle case screws.
Check the throttle lever for smooth operation.

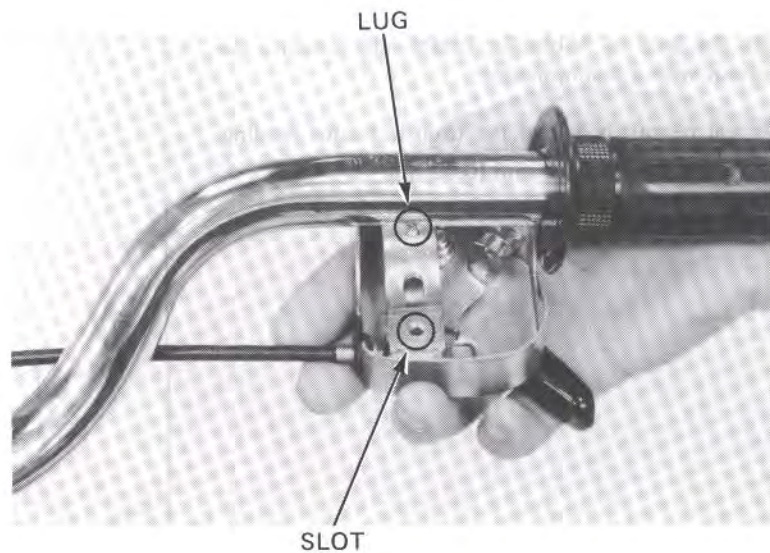



FRONT WHEEL/STEERING

FRONT WHEEL

REMOVAL

Raise the front wheel off the ground using a floor jack or other adjustable support under the engine.

Remove the cotter pin and front axle nut.

Remove the front axle and collar from both sides of the front wheel.

Remove the front wheel.

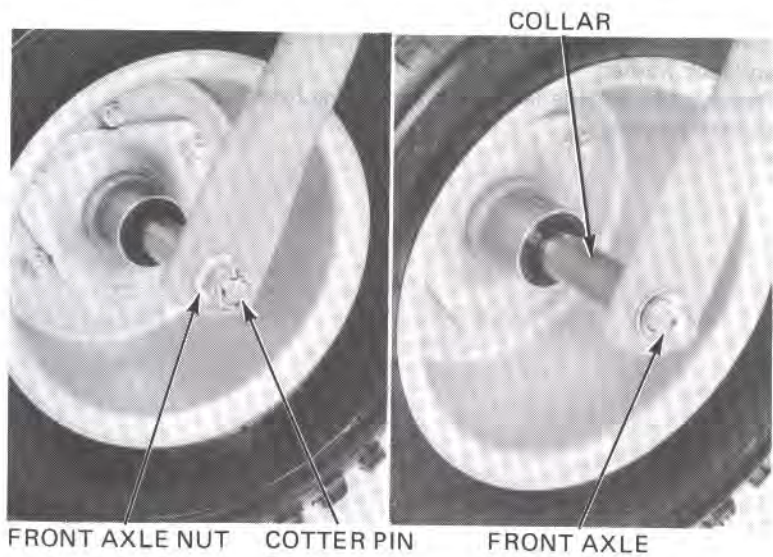

INSPECTION

Measure the front wheel rim runout.

SERVICE LIMIT: 4.0 mm (0.16 in)

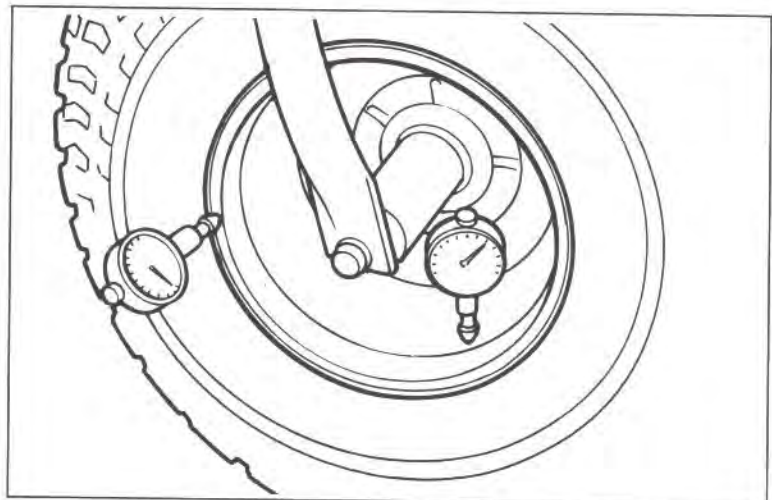

Set the axle in V-blocks, rotate and measure the runout with a dial indicator.

Actual runout is 1/2 of the total indicator reading.

SERVICE LIMIT: 0.5 mm (0.02 in)

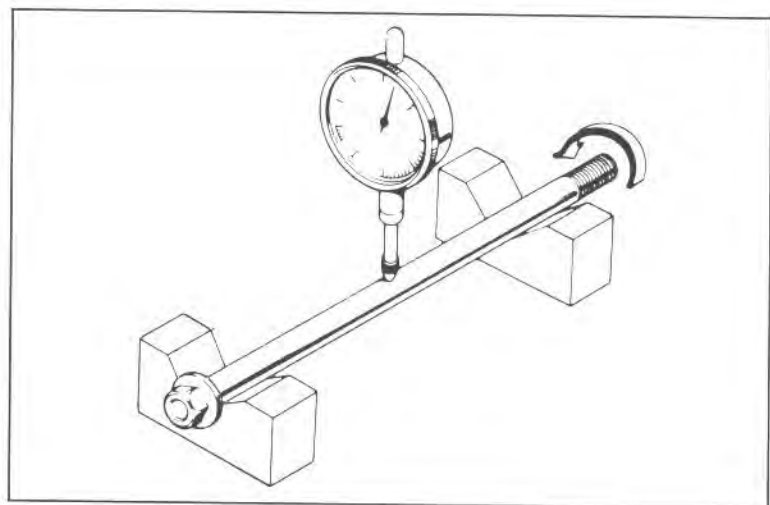



Check the wheel bearing by placing the wheel between V-blocks and spinning the wheel by hand.

Replace the bearings with new ones if they are noisy or have excessive play.

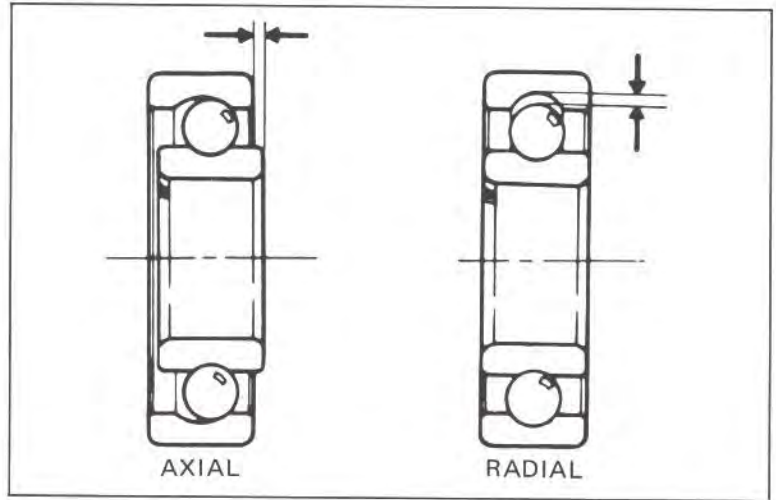

WHEEL BEARING REPLACEMENT

Install the bearing remover head into the bearing. From the opposite side install the bearing remover shaft and drive the bearing out of the wheel. Remove the distance collar and drive out other bearing.

NOTE:

If the bearings are removed, they must be replaced with new ones.

BEARING REMOVER HEAD, 15 mm 07746-0050400
or Equivalent commercially available in U.S.A.

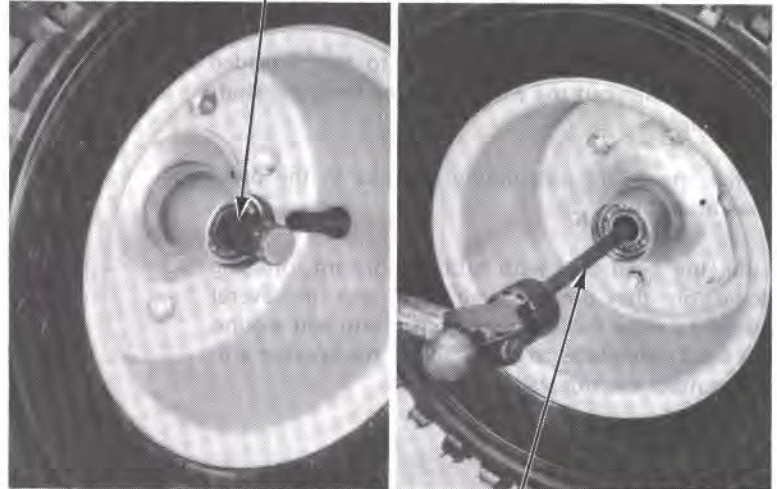

BEARING REMOVER SHAFT 07746-0050100
or Equivalent commercially available in U.S.A.
DRIVER 07749-0010000

Pack grease into the bearing cavities.

Drive in the left bearing squarely until it seats. Install the center collar and drive in the right bearing squarely until it seats.

NOTE:

Do not allow the bearings to tilt while driving them in.

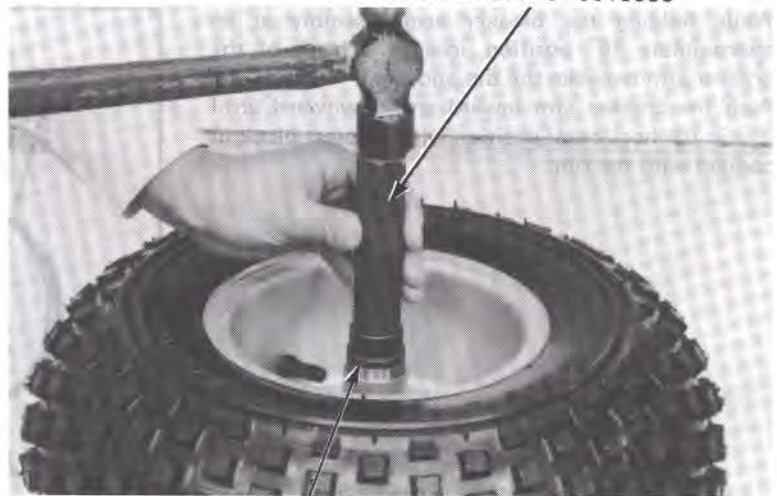

ATTACHMENT, 32 x 35 mm 07746-0010100
PILOT, 15 mm 07746-0040300



FRONT WHEEL/STEERING

TIRE REMOVAL

NOTE:

This service requires the Universal Bead Breaker (GN-AH-958-BB1) available in U.S.A. only.

Remove the core from the valve stem.

CAUTION:

- Use of the Bead Breaker tool is required for tire removal.
- Do not damage the bead seating area of the rim.

Install the blade for 7¹/₈" rims onto the breaker arm assembly.

CAUTION:

Use of an improper size blade may result in damage to the rim, tire or blade.

Place the proper size adapter onto the threaded shaft and then put the wheel over the threaded shaft and adapter.

Install the white positioning buttons in the press head assembly.

Lube the bead area with rubber lubricant, pressing down on the tire sidewall/bead area in several places, to allow the lubricant to run into and around the bead. Also lube the area where the breaker arm will contact the sidewall of the tire.

While holding the breaker arm assembly at an approximate 45° position, insert the blade of the breaker arm between the tire and rim. Push the breaker arm inward and downward until it is in the horizontal position with its press block in contact with the rim.

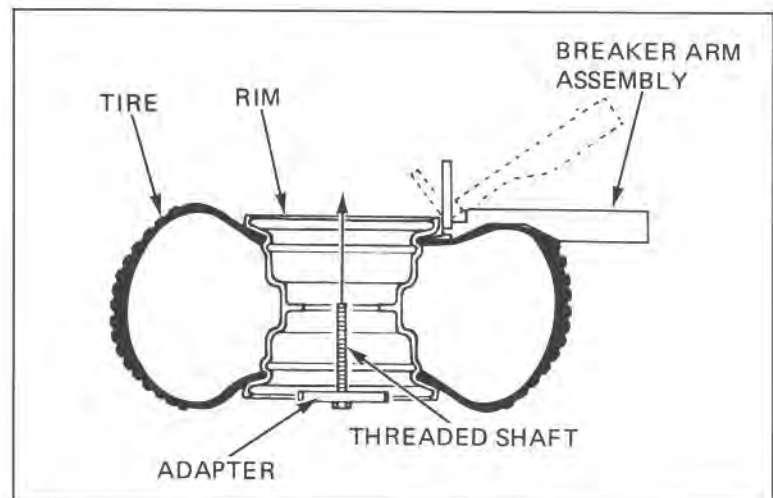
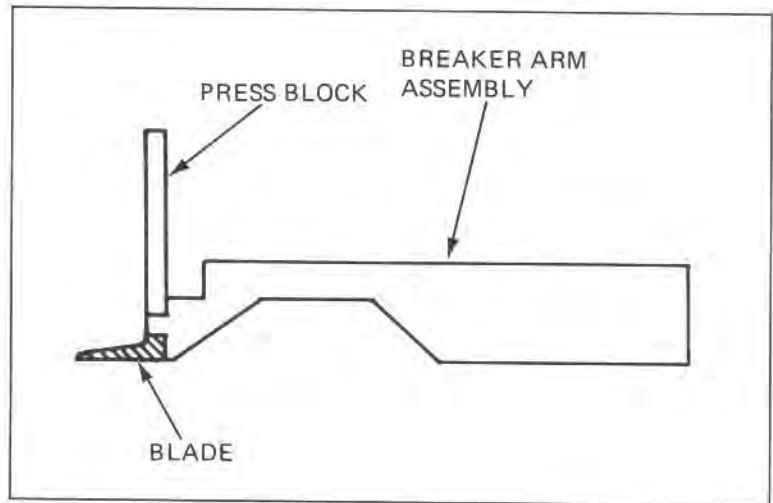



With the breaker arm in the horizontal position, place the breaker press head assembly over the breaker arm press block. Make sure the press head bolt is backed out all the way and then position the nylon buttons on the press head against the inside edge of the rim.

Insert the threaded shaft through the appropriate hole in the breaker press head assembly and then tighten the lever nut until both ends of the breaker press head assembly are in firm contact with the rim.

NOTE:

Insert bolts through the holes in the rim hub mounting tabs and the adapter to position the adapter properly.

Tighten the press head bolt until the reference mark on the press block is aligned with the top edge of the press head.

If the rest of the bead cannot be pushed down into the center of the rim by hand, loosen the press head bolt and the lever nut. Rotate the breaker arm assembly and breaker press head assembly 1/8 to 1/4 the circumference of the rim. Tighten the lever nut and then tighten the press head bolt as described. Repeat this procedure as necessary until the remainder of the bead can be pushed down into the center of the rim.

Assemble the Universal Bead Breaker on the other side of the wheel and break the bead following the same procedures.

Remove the three rim bolts and separate the rim halves from the tire.

TIRE REPAIR (WITH COLD PATCH)

Check the tire tread for puncturing objects. Chalk mark the punctured area and remove the puncturing objects.

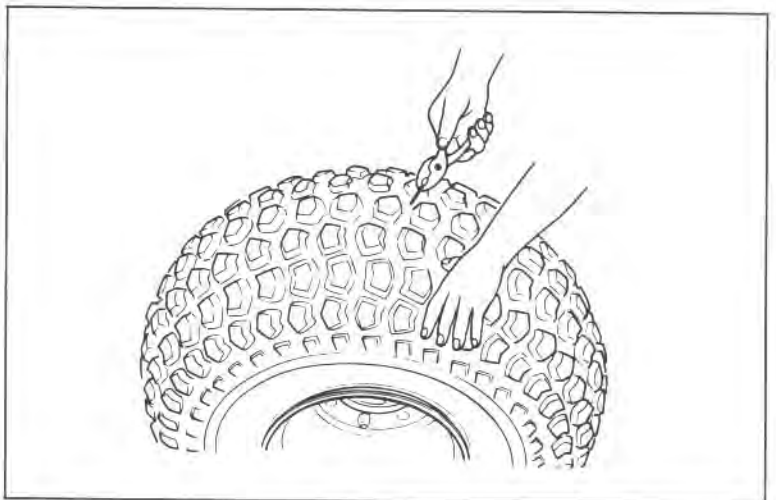
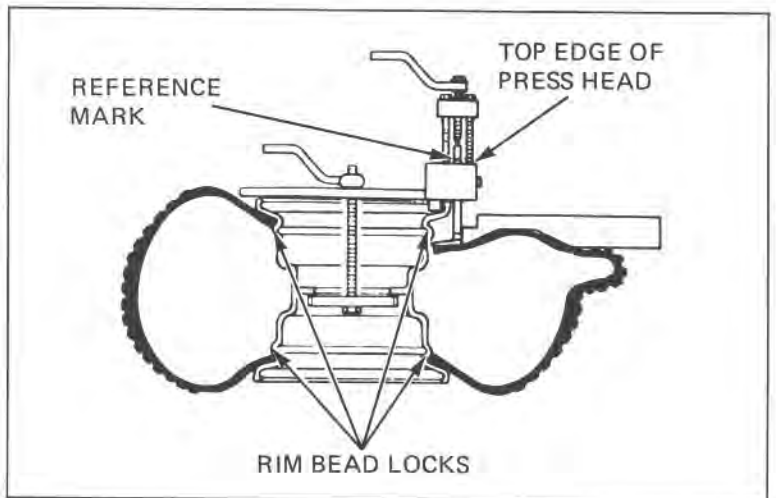
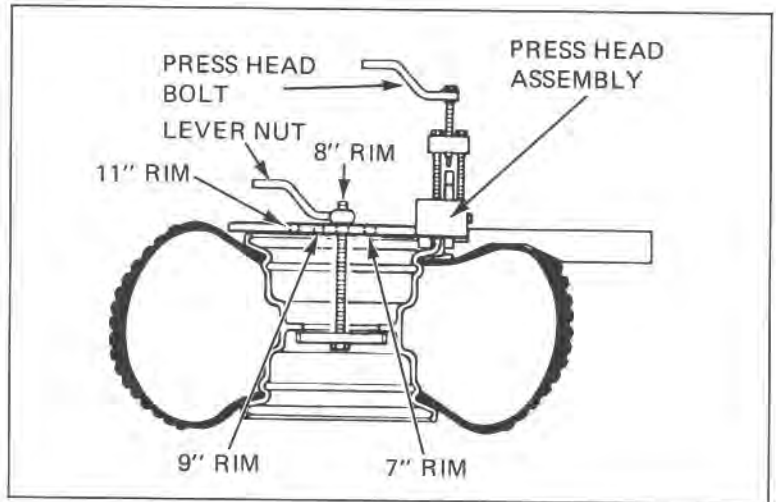



FRONT WHEEL/STEERING

Clean and roughen the punctured area inside the tire with a tire rubber cleaner or a wire brush. Clean the area with non-flammable solvent.

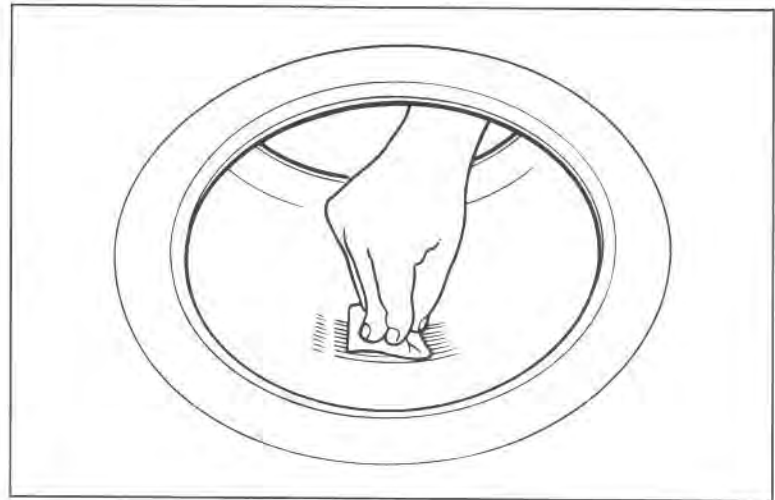

Apply rubber cement around the torn area and allow it to dry. Remove the lining from the patch and center it over the injury. Press the patch against the injury using a special roller.

NOTE:

- Allow cement to dry until tacky before applying patch.
- Do not touch cement surface with dirty or greasy hands.

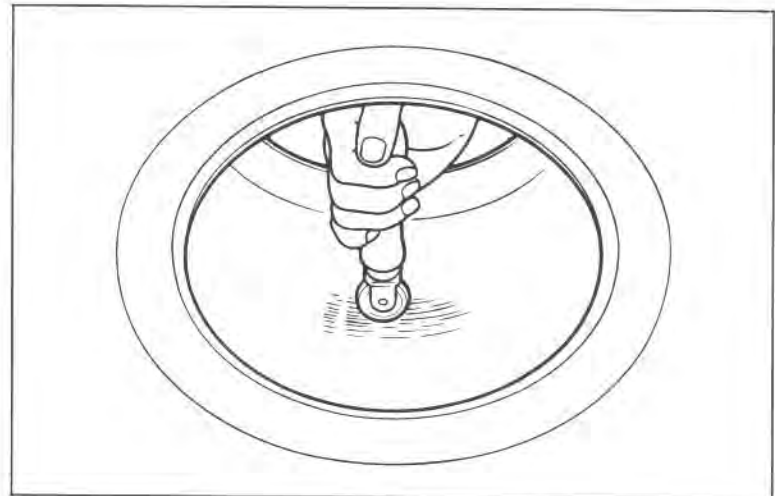

TIRE REPAIR (WITH RUBBER PLUG)

NOTE:

- This method is an emergency repair only.
- Replace the plug at the first opportunity with a cold patch.

Remove the puncturing object.
Insert a rubber plug through the eye of an inserting needle.

Apply patching cement to the plug.

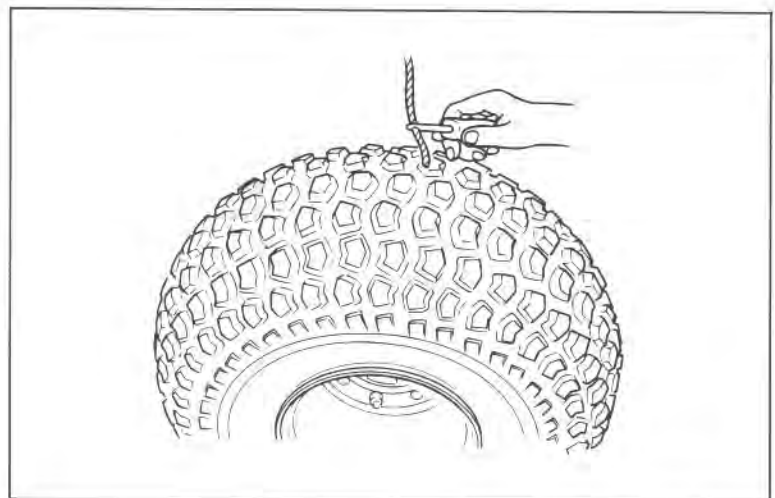



Center the needle on the plug and insert until the plug is all the way in the tire. Twist the needle several times.

Pull the needle straight out so that the plug is about 10 mm (3/8 in) above the tread surface. Trim the plug 2 mm (1/16 in) above the surface.

Repeat the above procedure if the puncture is large.

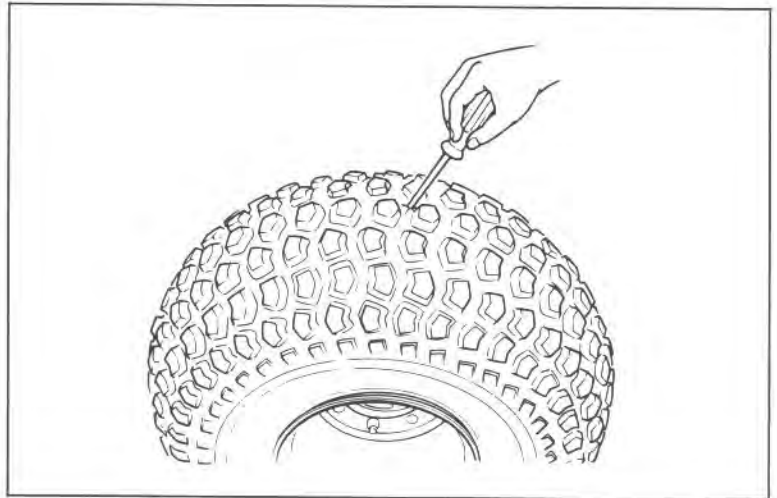

TIRE ASSEMBLY

Clean the rim bead seat, flange and O-rings grooves. Inspect the O-ring for damage, discard, broken or nicked.

Assemble the rim halves into the tire making sure the O-ring is seated in its groove.

Install and tighten the three rim bolts.

TORQUE: 19–25 N·m (1.9–2.5 kg·m, 14–18 ft·lb)

Install the valve core and inflate the tire to seat the bead.

TIRE PRESSURE:

2.2 psi (0.15 kg/cm², 15 kPa)

Min. Pressure: 1.7 psi (0.12 kg/cm², 12 kPa)

Max. Pressure: 2.5 psi (0.18 kg/cm², 18 kPa)

Measure the tire circumference.

STANDARD TIRE CIRCUMFERENCE:

1,290 mm (50.7 in)

Check for air leaks and install the valve cap.

Install the front wheel hub and tighten the hub nuts.

TORQUE: 19–25 N·m (1.9–2.5 kg·m, 14–18 ft·lb)

Install the dust seal over the wheel bearings.

INSTALLATION

Install the front wheel in the reverse order of removal.

Tighten the front axle nut.

TORQUE: 60–80 N·m (6.0–8.0 kg·m, 43–58 ft·lb)

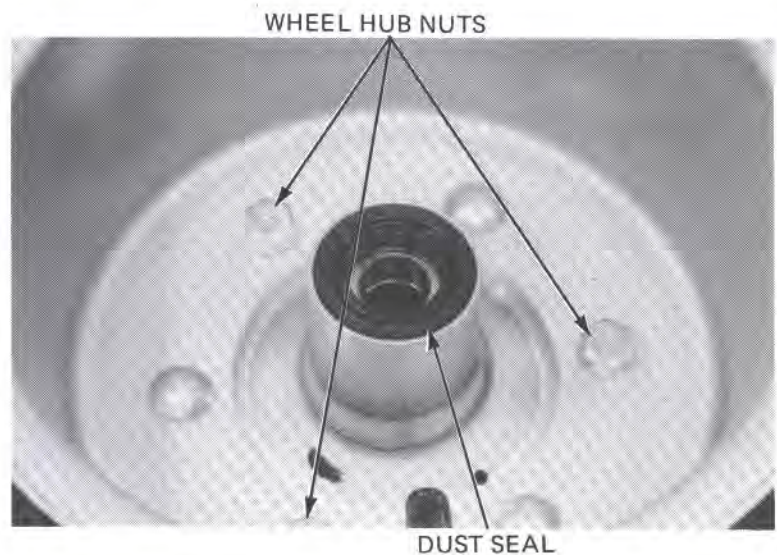
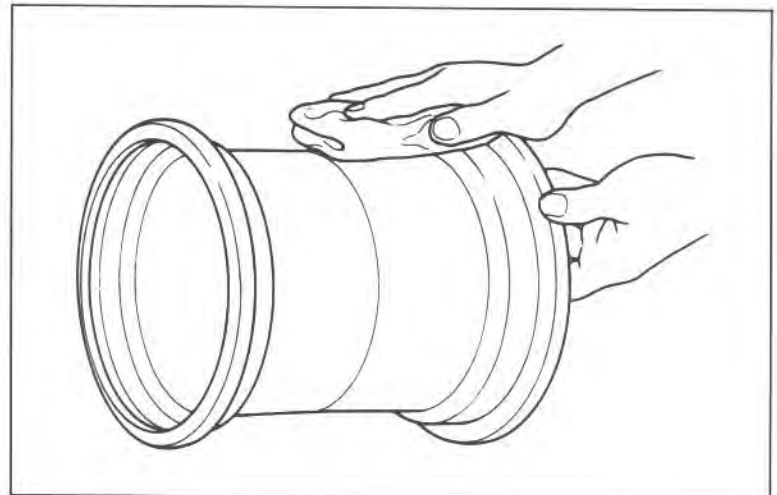



STEERING STEM

Remove the handlebar (Page 11-3).
Remove the front wheel (Page 11-6).
Remove the front fender by removing the four bolts.

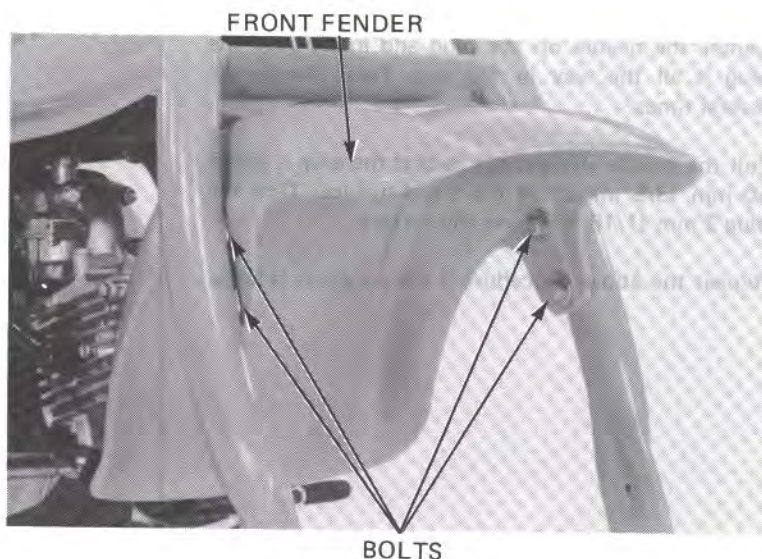

Remove the fork bridge bolts.

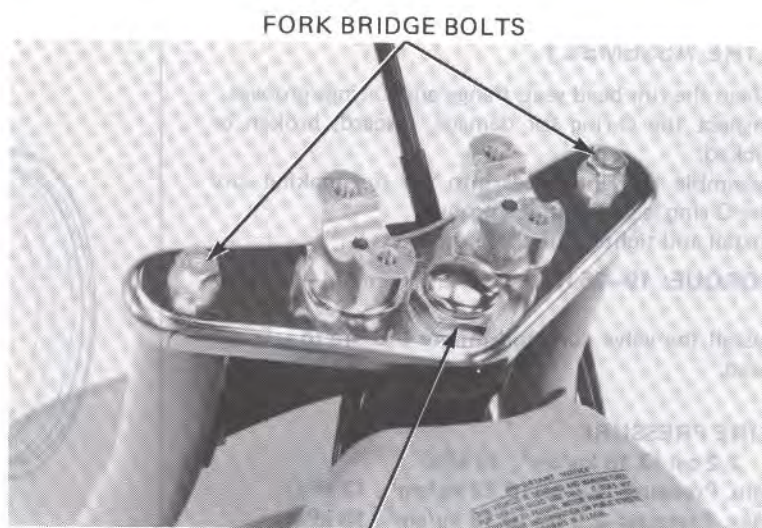

Remove the steering stem nut and the fork bridge.

STEERING STEM NUT
LOCK NUT WRENCH, 30 x 32 mm or 07716-0020400
or equivalent commercially available in U.S.A.

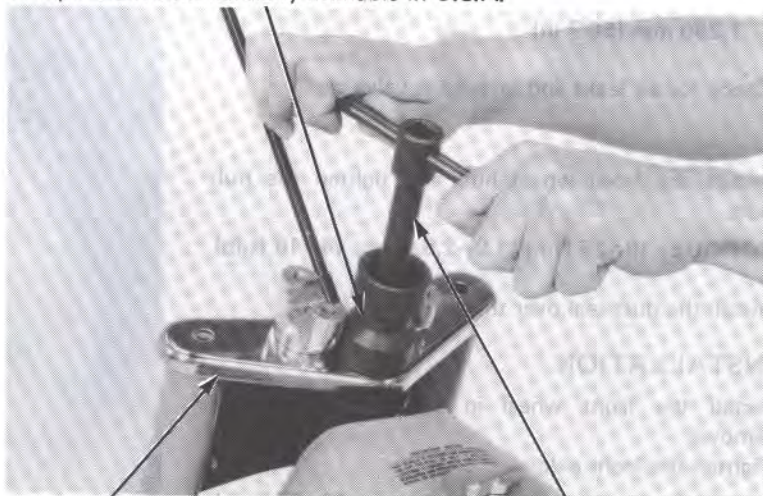



LOCK NUT WRENCH, 26 x 30 mm 07716-0020203
or equivalent commercially available in U.S.A.

Remove the steering adjustment nut.

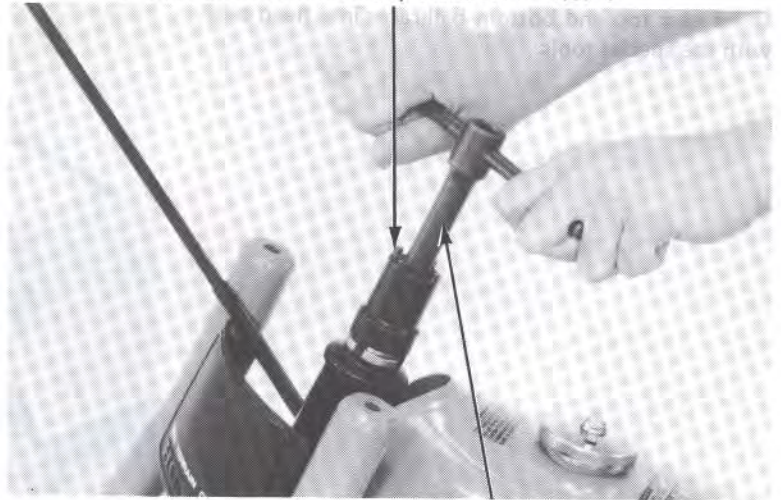

EXTENSION 07716-0020500 or
equivalent commercially available in U.S.A.

Remove the top cone race, ball bearings and front
fork bearing careful not to drop the upper bearings.

BALL BEARINGS (21) TOP CONE RACE

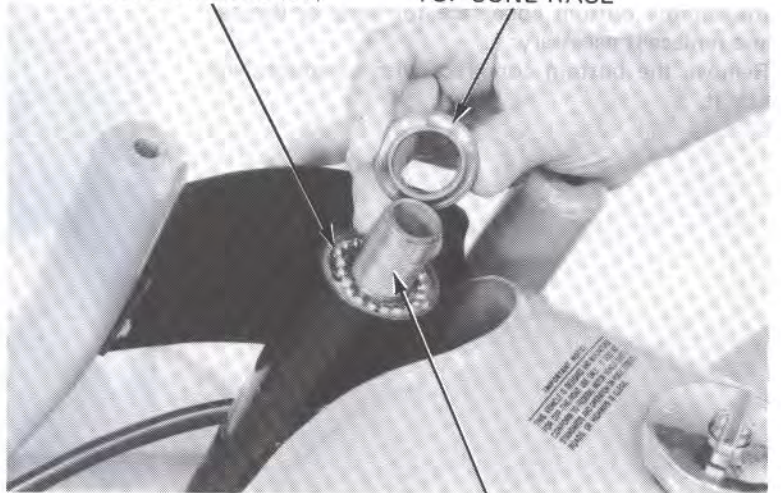

STEERING STEM

BALL RACE REMOVER 07944-1150001
or M9630-277-91774 (U.S.A. only)

BALL/CONE RACE REPLACEMENT

Check the ball races for wear or damage and remove
if necessary.

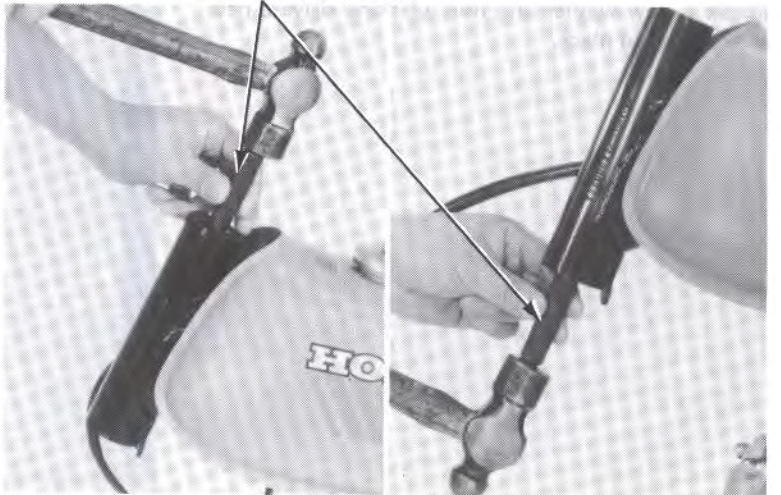



FRONT WHEEL/STEERING

Drive new top and bottom ball races into head pipe with the special tools.

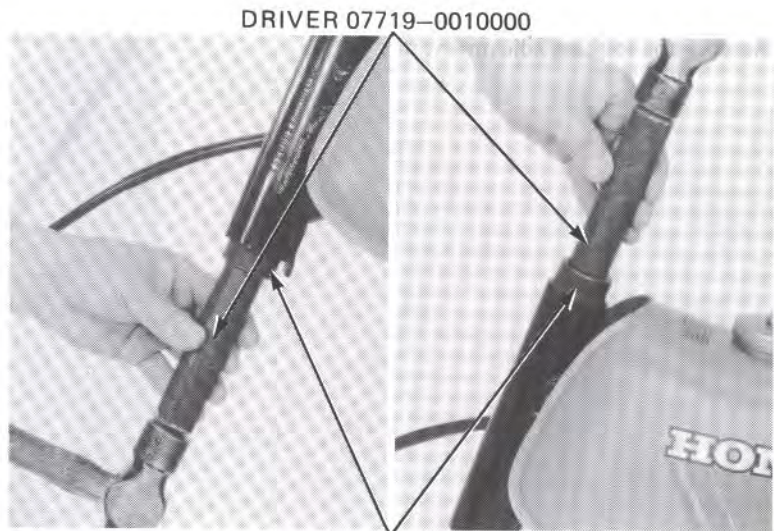

DRIVER 07719-0010000

ATTACHMENT, 37 x 40 mm
07746-0010200

Inspect the bottom cone race for wear or damage and replace if necessary.

Remove the bottom cone race with a hammer and a drift.

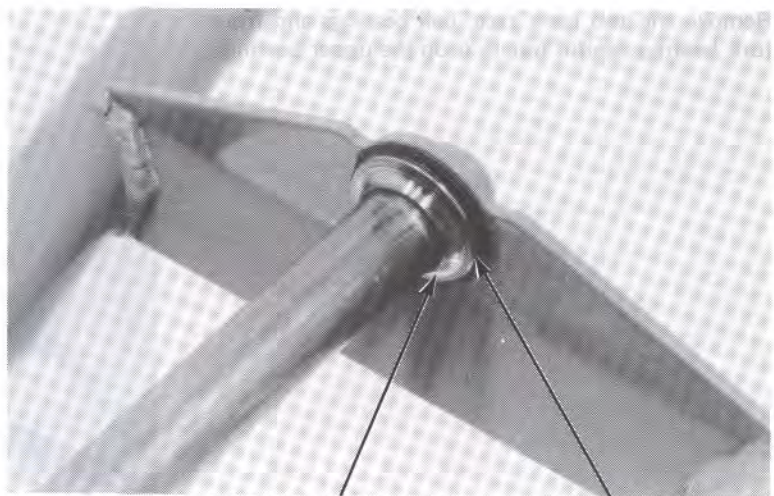

BOTTOM CORN RACE

DUST SEAL

Install a new washer and dust seal and drive a new cone race into place.

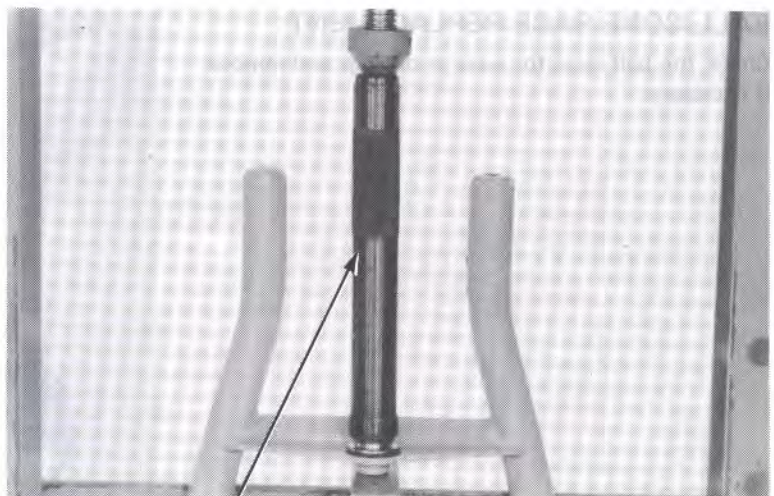

STEERING STEM DRIVER 07946-GC40000



INSTALLATION

Apply grease to the top and bottom ball races and install 21 ball bearings for both the top and bottom ball races.

Insert the steering stem into the steering head pipe and install the top cone race.



LOCK NUT WRENCH, 26 x 30 mm 07716-0020203
or equivalent commercially available in U.S.A.

Install the bearing adjustment nut and tighten it with first torque.

TORQUE: 25-35 N·m (2.5-3.5 kg·m, 18-25 ft·lb)

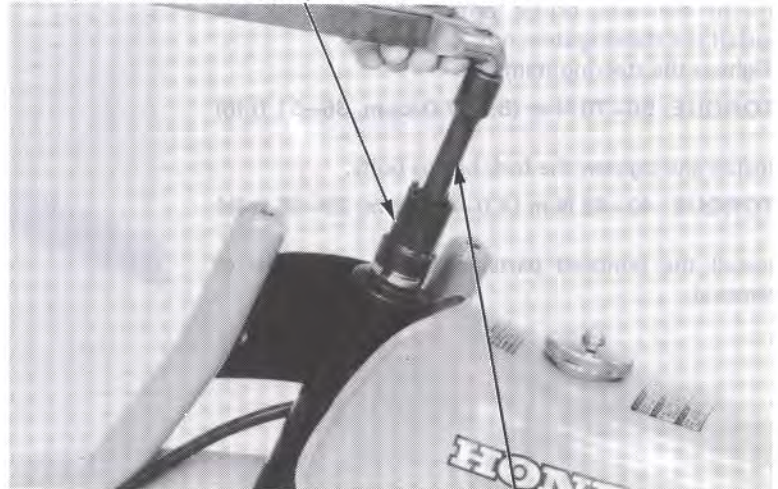

EXTENSION 07716-0020500 or
equivalent commercially available in U.S.A.

Turn the steering stem lock-to-lock 4-5 times to seat the bearings.

Completely loosen the bearing adjustment nut, then retighten the adjustment nut to final torque.

TORQUE: 6-7 N·m (0.6-0.7 kg·m, 4.3-5.1 ft·lb)

Make sure that there is no vertical movement and that the stem rotates freely.





Install the handlebar lower holders onto the fork bridge and tighten the nuts.

TORQUE: 40–48 N·m (4.0–4.8 kg·m, 29–35 ft·lb)

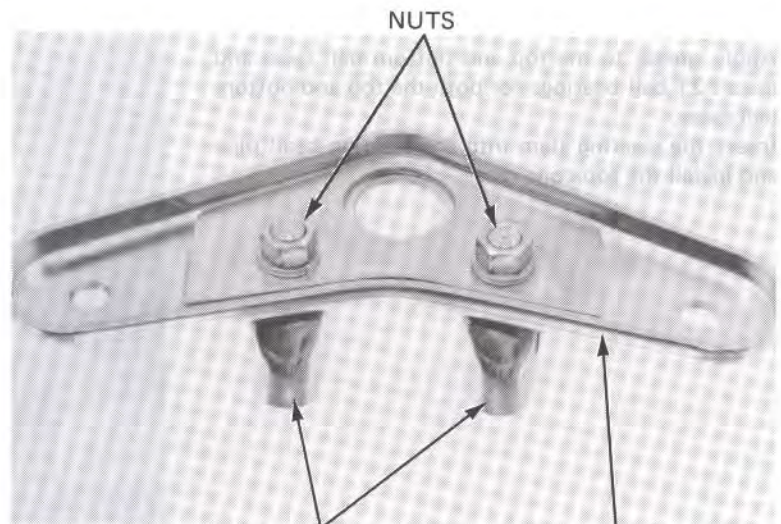

LOWER HOLDERS **FORK BRIDGE**
LOCK NUT WRENCH, 30 x 32 mm 07716-0020400
or equivalent commercially available in U.S.A.

Install the fork bridge onto the front fork and install the steering stem nut.

Tighten the steering stem nut.

TORQUE: 50–70 N·m (5.0–7.0 kg·m, 36–51 ft·lb)

Install and tighten the fork bridge bolts.

TORQUE: 40–48 N·m (4.0–4.8 kg·m, 29–35 ft·lb)

Install the removed parts in the reverse order of removal.

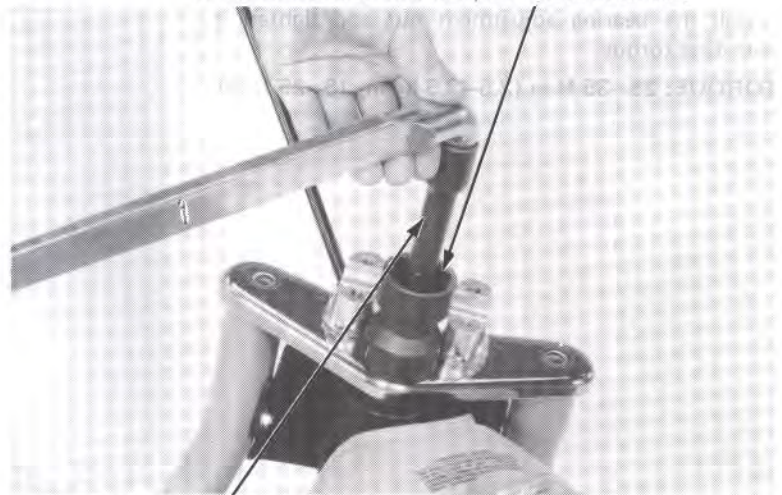

EXTENSION 07716-0020500 or
equivalent commercially available in U.S.A.



HONDA
ATC70

MEMO



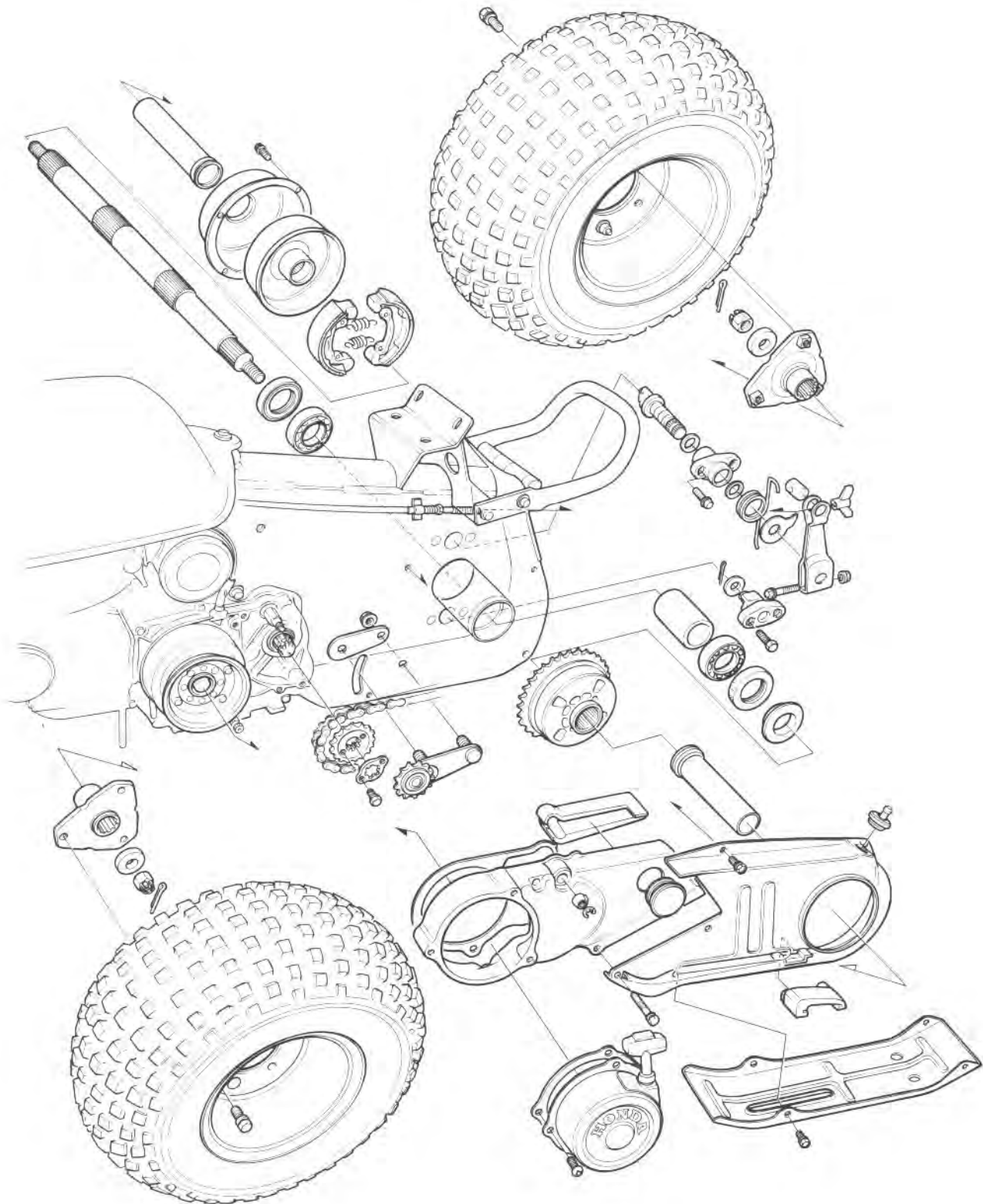



SERVICE INFORMATION	12-1	FINAL DRIVE SPROCKET	12-8
TROUBLESHOOTING	12-2	REAR AXLE	12-9
REAR WHEEL	12-3	EXHAUST PIPE	12-11
REAR BRAKE	12-3	FOOT PEG	12-12
DRIVE CHAIN	12-7		

SERVICE INFORMATION

GENERAL

- This section covers maintenance of the rear wheel and drive mechanism.
- A jack or block is required to support the ATC.
- Refer to section 11 for tire servicing.

SPECIFICATIONS

ITEM	STANDARD	SERVICE LIMIT
Rear axle runout	—	0.5 mm (0.02 in)
Rear brake drum I.D.	130 mm (5.12 in)	131 mm (5.2 in)
Rear brake lining thickness	4.0 mm (0.158 in)	2.0 mm (0.08 in)

TORQUE VALUES

Drive chain tensioner	25-33 N·m (2.5-3.3 kg-m, 18-24 ft-lb)
Rear axle	60-80 N·m (6.0-8.0 kg-m, 43-58 ft-lb)
Rear wheel	19-25 N·m (1.9-2.5 kg-m, 14-18 ft-lb)
Brake cam holder	7-12 N·m (0.7-1.2 kg-m, 5-9 ft-lb)
Brake anchor pin	7-12 N·m (0.7-1.2 kg-m, 5-9 ft-lb)
Rear fender	15-21 N·m (1.5-2.1 kg-m, 11-15 ft-lb)
Seat	6-9 N·m (0.6-0.9 kg-m, 4-7 ft-lb)
Rear fender bracket	6-9 N·m (0.6-0.9 kg-m, 4-7 ft-lb)
Foot peg guard A 8 mm	19-25 N·m (1.9-2.5 kg-m, 14-18 ft-lb)
B 10 mm	40-48 N·m (4.0-4.8 kg-m, 29-35 ft-lb)
Foot peg	19-25 N·m (1.9-2.5 kg-m, 14-18 ft-lb)

TOOLS

Common

Attachment, 52 x 55 mm	07746-0010400
Driver	07749-0010000
Pilot, 30 mm	07746-0040700



TROUBLESHOOTING

Wobble or vibration in ATC

- Bent rim
- Loose wheel bearing
- Faulty rear axle bearing holder
- Faulty tire
- Axle not tightened properly

Poor brake performance

- Improper brake adjustment
- Worn brake shoes
- Brake linings oily, greasy or dirty
- Worn brake cam
- Worn brake drum
- Brake arm serrations improperly engaged
- Brake shoes worn at cam contact area



REAR WHEEL

REMOVAL

Raise the rear wheel off the ground using a floor jack or other adjustable support under the axle.

Remove the three hub bolts and rear wheel.

REAR TIRE DISASSEMBLY/ASSEMBLY

For tire disassembly, assembly and repair, refer to pages 11-8 through 11-11.

INSTALLATION

Install the rear wheel with the tire valve facing out.

Tighten the hub bolts.

TORQUE: 19–25 N·m (1.9–2.5 kg·m, 14–18 ft·lb)

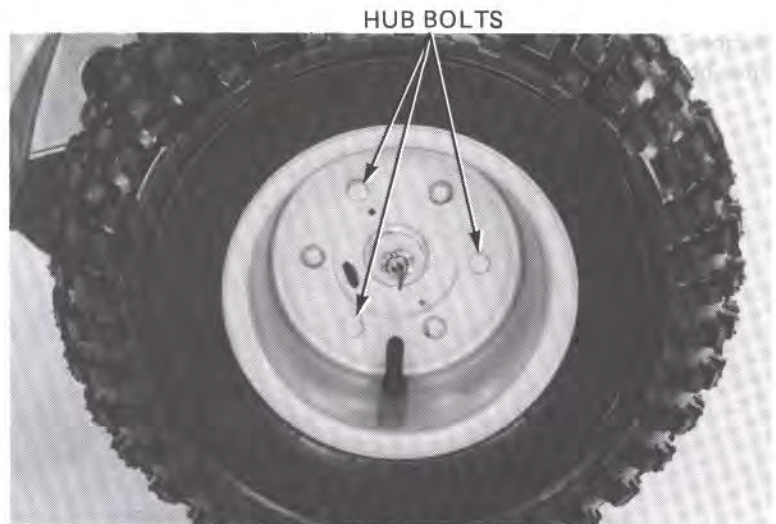

REAR BRAKE

REMOVAL

NOTE:

The brake lining can be inspected and replaced with the rear wheel installed.

Stand the ATC on its rear wheels and rear carrier.

CAUTION:

To prevent fuel spillage; if the fuel tank is more than half full, either drain some fuel or remove the fuel tank (Page 4-3).

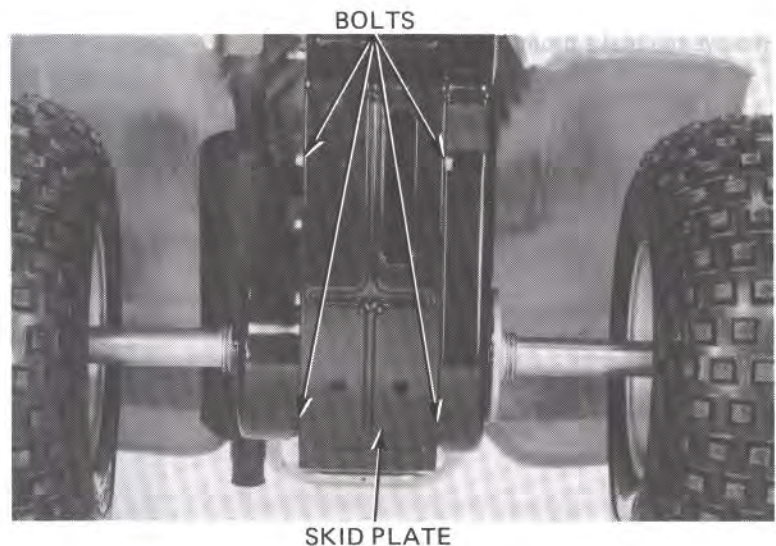

SKID PLATE

Remove the skid plate by removing the four bolts. Raise the right rear wheel using a floor jack or other adjustable support under the right axle.

Remove the cotter pin, axle nut and washer. Remove the rear wheel with the wheel hub.

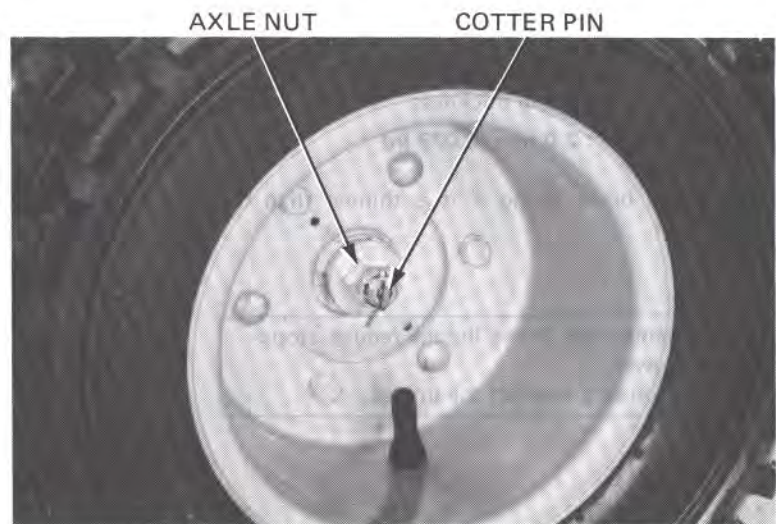



Remove the brake drum cover by removing the three bolts.

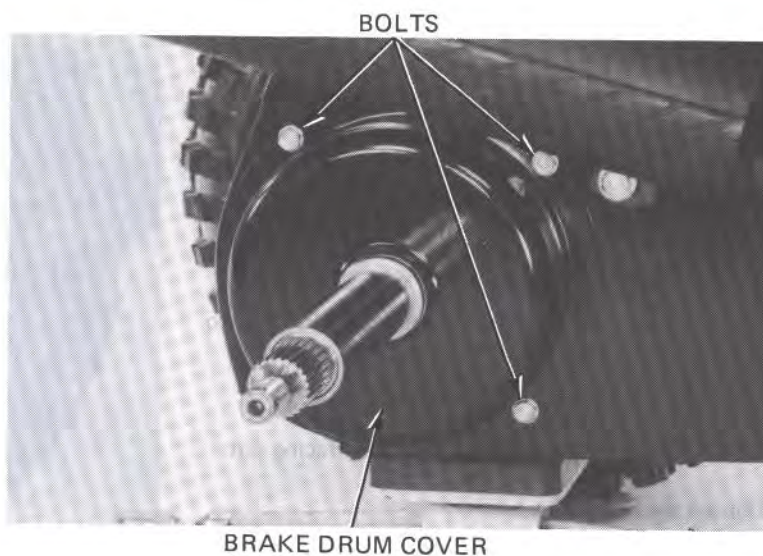

Remove the brake drum from the axle shaft.

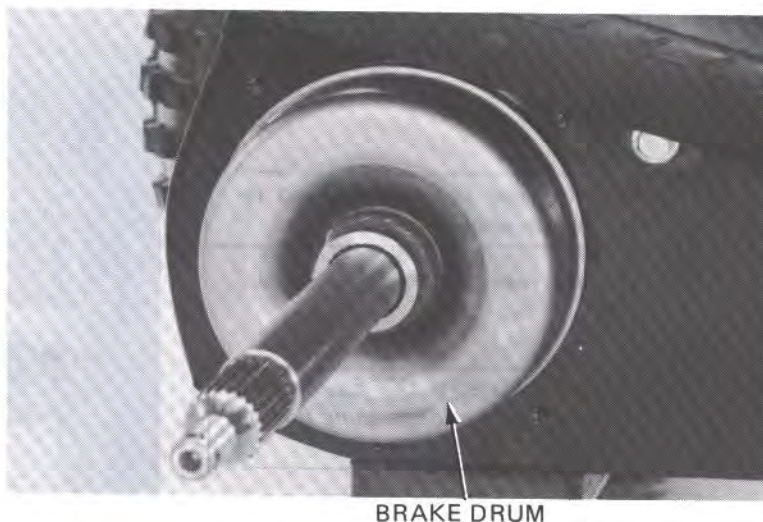

INSPECTION

Measure the brake lining thickness.

SERVICE LIMIT: 2.0 mm (0.079 in)

Replace the brake lining if it is thinner than the service limit.

NOTE:

- Contaminated brake linings reduce stopping power.
- Keep oil or grease off the linings.

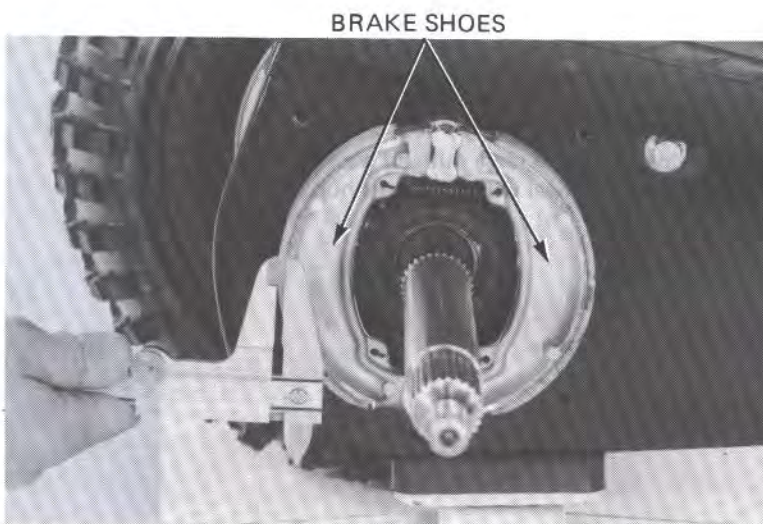



Inspect the brake drum for wear or damage.
Replace if necessary.

Measure the brake drum I.D.

SERVICE LIMIT: 131 mm (5.2 in)

Replace if necessary.

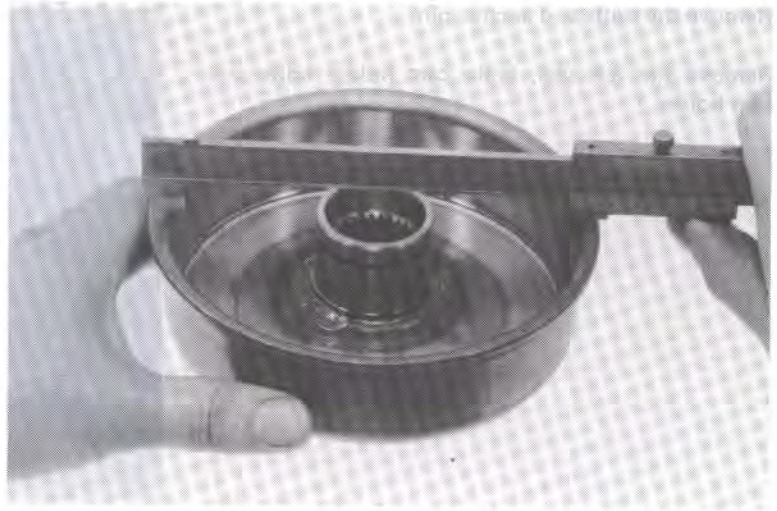

BRAKE DISASSEMBLY

Remove the cotter pin and washer.
Expand and remove the brake shoes.

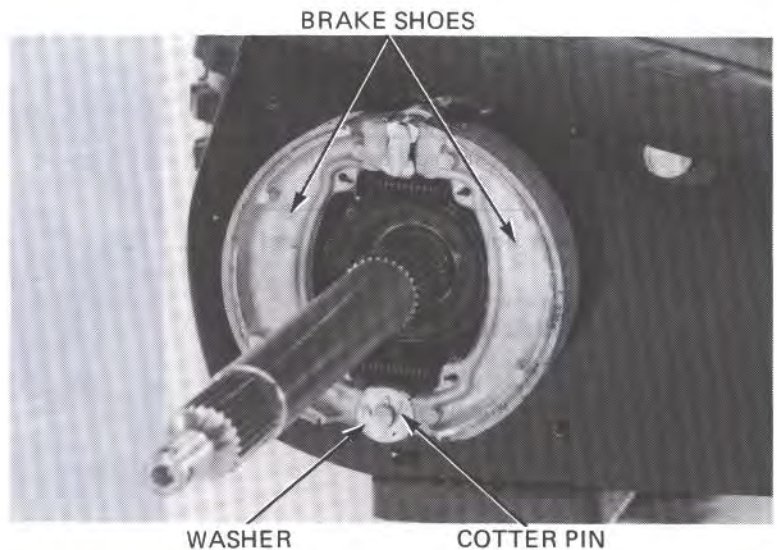

Remove the brake arm nut, bolt, brake arm, wear indicator plate, felt seal and spring.

Remove the brake cam.

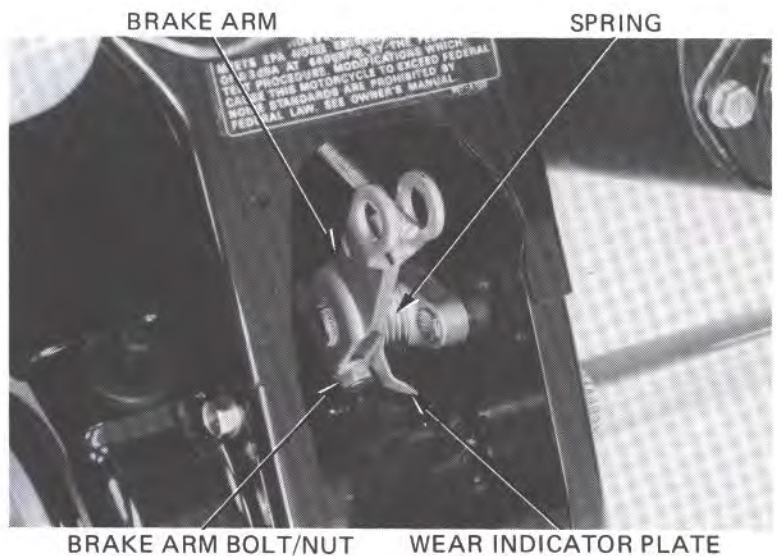



REAR WHEEL/BRAKE/DRIVE MECHANISM

Remove the bolts and anchor pin.

Remove the felt seal, brake cam holder bolts and cam holder.

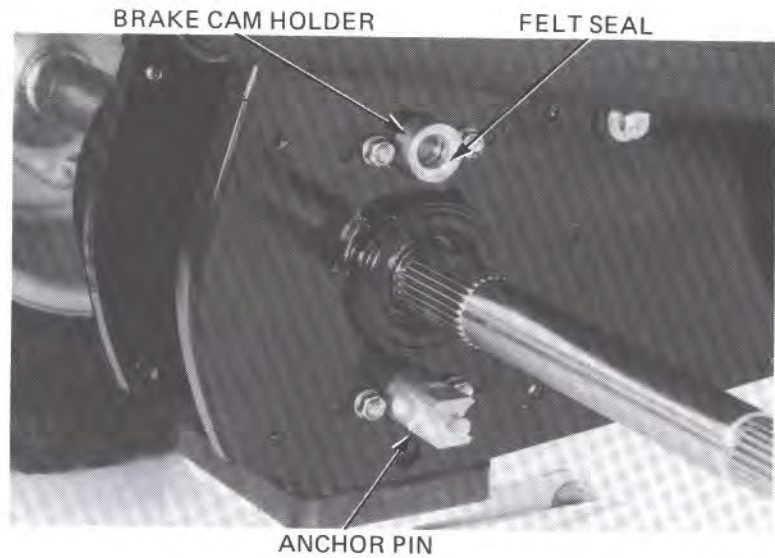

ASSEMBLY/INSTALLATION

NOTE:

Apply engine oil to the felt seal before installing.

Install the brake cam holder, anchor pin and felt seal.

Apply grease to the brake cam and install it.
Install the spring and felt seal.

Install the wear indicator plate aligning the tab on the plate with the slit on the brake cam.

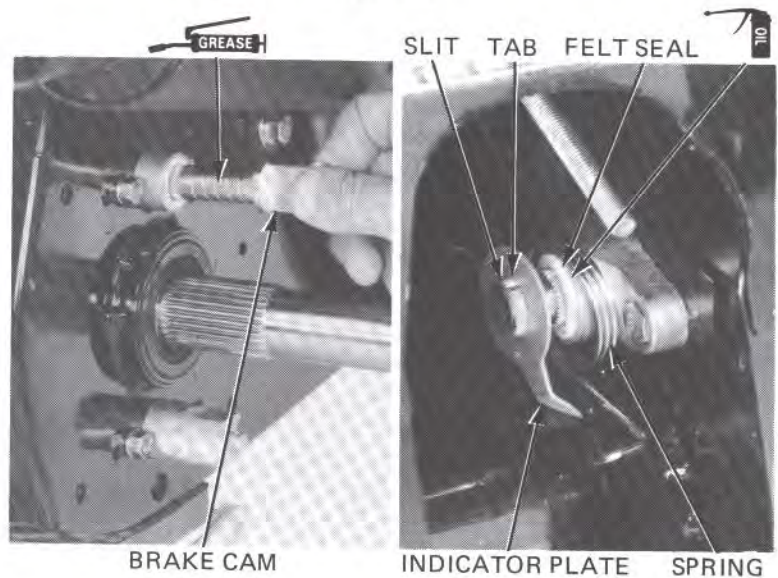

Install the brake arm over the brake arm aligning the punch mark on the brake arm with the slit on the brake cam.

Tighten the brake arm bolt.

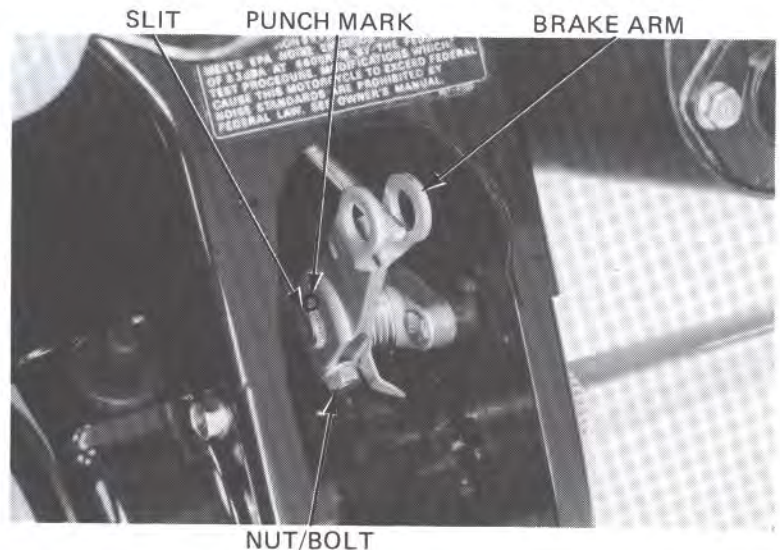



Install the brake shoes and secure with washer and cotter pin.

Install the brake drum, drum cover.

WARNING

Brake dust contains asbestos which can be harmful to your health. Do not use compressed air to clean brake parts. Use a vacuum with a sealed dust collector. Wear a protective face mask and wash your hands when finished.

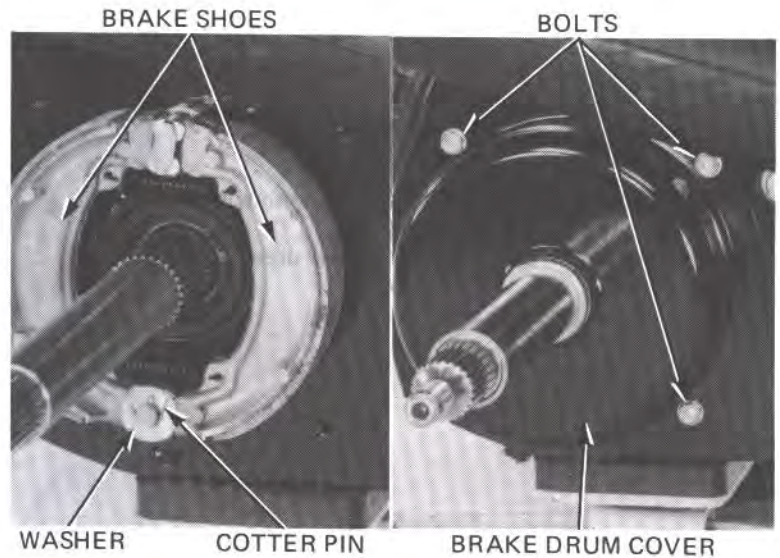

Install the rear wheel.
Install the washer over the axle shaft with the outside mark facing out.

Install the axle nut and tighten it.

TORQUE: 60–80 N·m (6.0–8.0 kg·m, 32–58 ft·lb)

Install the cotter pin into the axle shaft and bend the end of the cotter pin.

Install the skid plate.

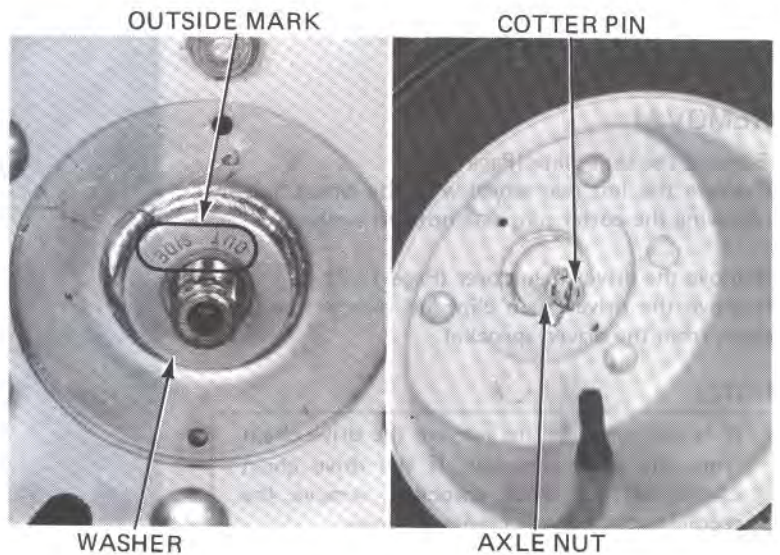

DRIVE CHAIN

REMOVAL

Remove the skid plate (Page 12-3).
Remove the drive chain cover by removing the four bolts.

Remove the recoil starter (Page 9-2).
Remove the left crankcase cover (Page 9-7).

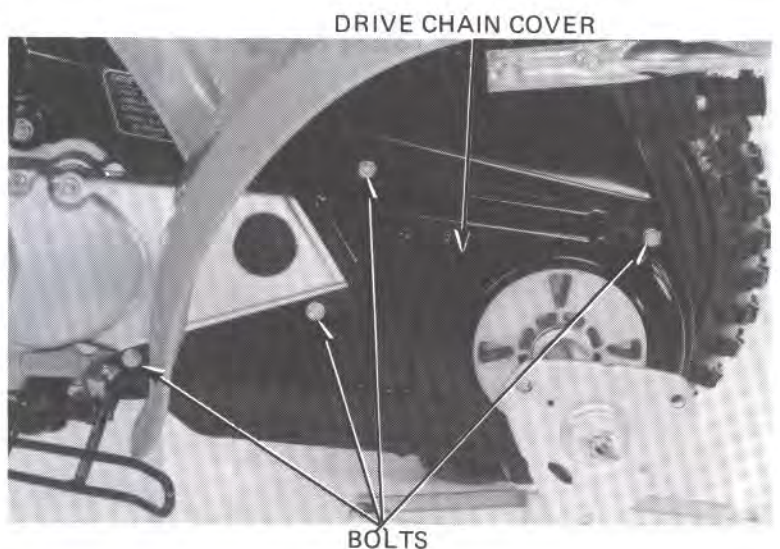



REAR WHEEL/BRAKE/DRIVE MECHANISM

Loosen the drive chain tensioner bolts (Page 3-10). Remove the drive chain clip and remove the drive chain.

INSTALLATION

Install the drive chain clip in the direction as shown.

Install the removed parts in the reverse order of removal.

Adjust the drive chain tension (Page 3-10).

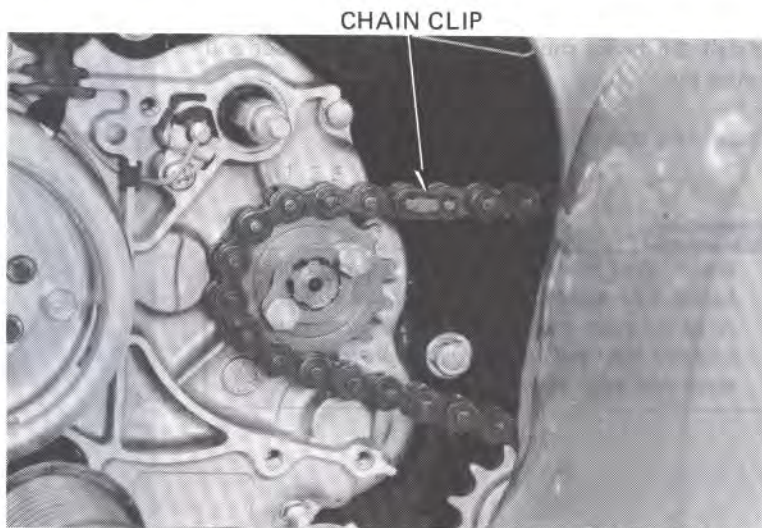

FINAL DRIVE SPROCKET

REMOVAL

Remove the skid plate (Page 12-3). Remove the left rear wheel with the wheel hub by removing the cotter pin, axle nut and washer.

Remove the drive chain cover (Page 12-7). Remove the drive chain clip and remove the drive chain from the driven sprocket.

NOTE:

It is not necessary to remove the drive chain from the drive sprocket. If the drive chain comes off the drive sprocket, remove the recoil starter and left crankcase cover.

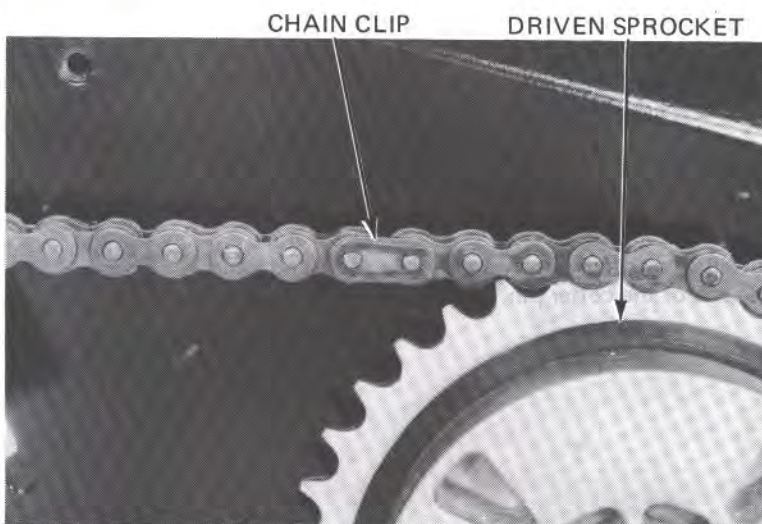

Pull the final driven sprocket housing out of the axle shaft.

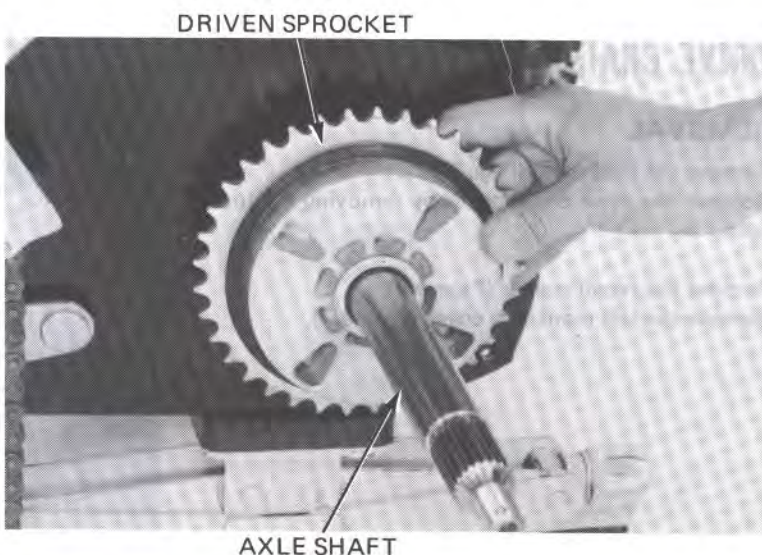



INSPECTION

Inspect the driven sprocket for wear, or damage.

Replace if necessary.

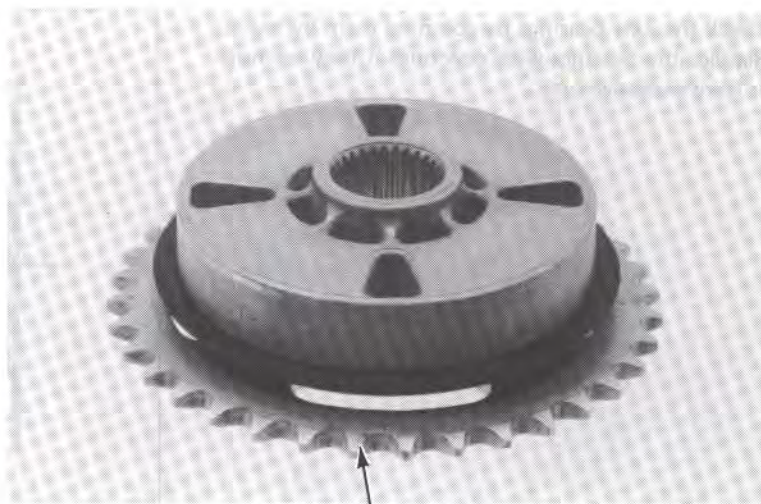

DRIVEN SPROCKET

Separate the driven sprocket from the housing and inspect the damper rubbers for damage or deteriorations.

Replace if necessary.

INSTALLATION

Install the driven sprocket in the reverse order of removal.

After installing check the drive chain tension and adjust it.

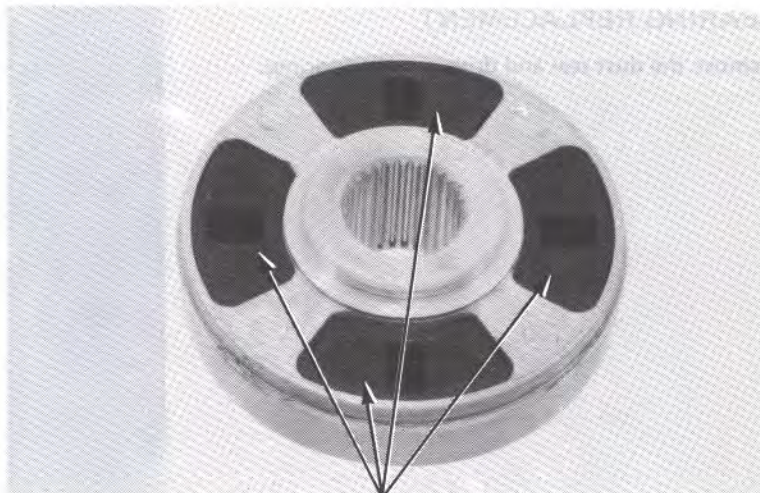

DAMPER RUBBERS

REAR AXLE

REMOVAL

NOTE:

The axle can be removed from either side.

Remove the following parts:

- rear wheels (Page 12-3).
- final driven sprocket.
- brake drum and shoes.

Raise the rear wheels off the ground.

Remove the rear axle.

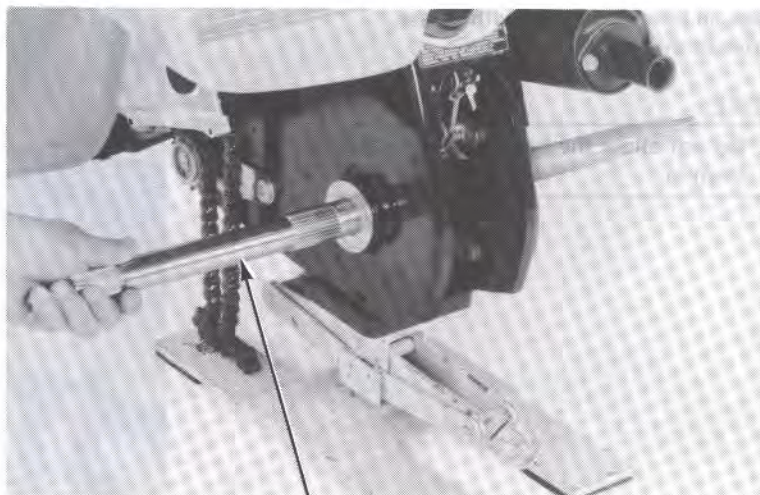

AXLE



REAR WHEEL/BRAKE/DRIVE MECHANISM

INSPECTION

Check the axle bearings by spinning them by hand.
Replace the bearings with new ones if they are noisy
or have excessive play.

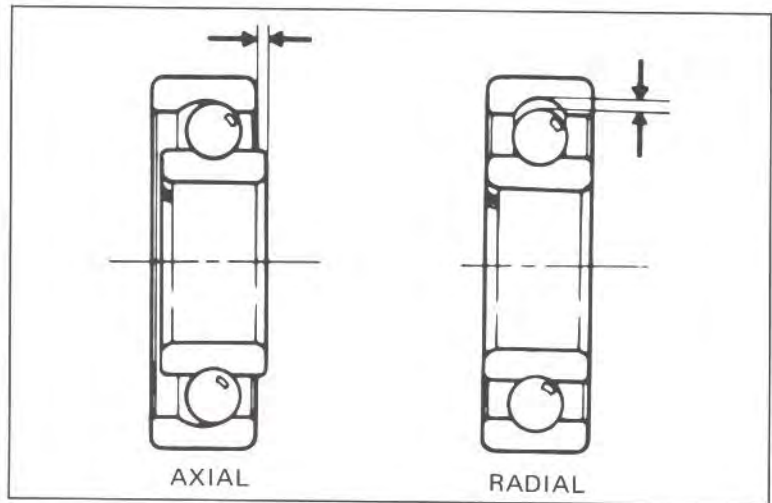

BEARING REPLACEMENT

Remove the dust seal and drive out the bearings.

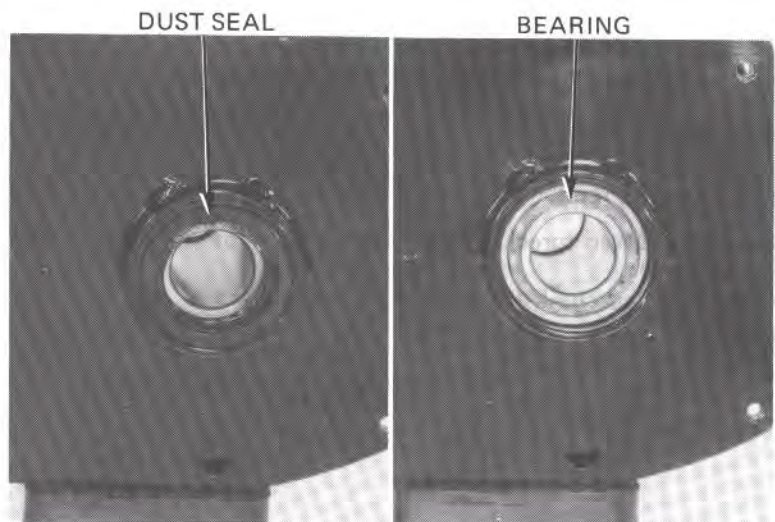

Pack all bearing cavities with grease.
Drive in the new bearings.

NOTE:

Do not allow the bearings to tilt while driving them in.

DRIVER
07719-0010000

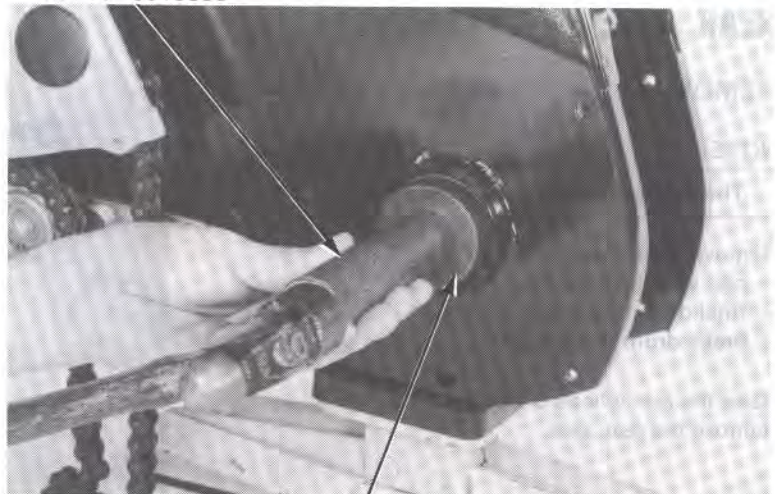

ATTACHMENT, 52 x 55 mm 07746-0010400
PILOT, 30 mm 07746-0040700



Install the dust seal over the bearing.
Install the axle and the removed parts in the reverse order of removal.

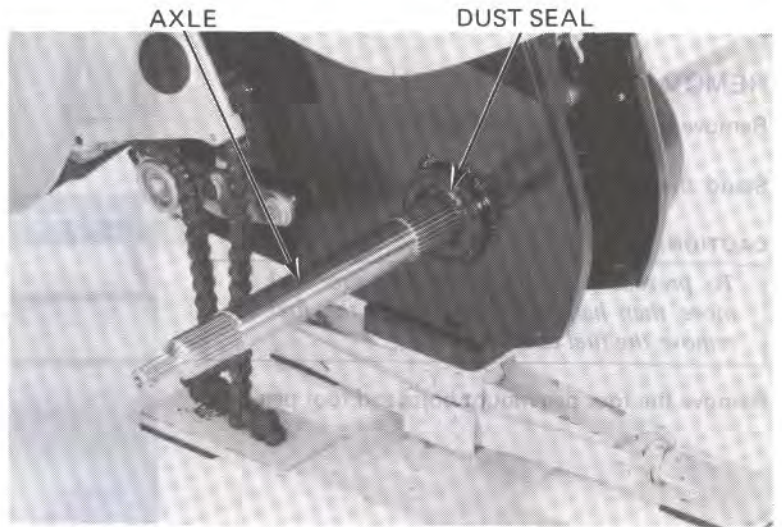

EXHAUST PIPE

REMOVAL

Remove the exhaust pipe joint nuts.

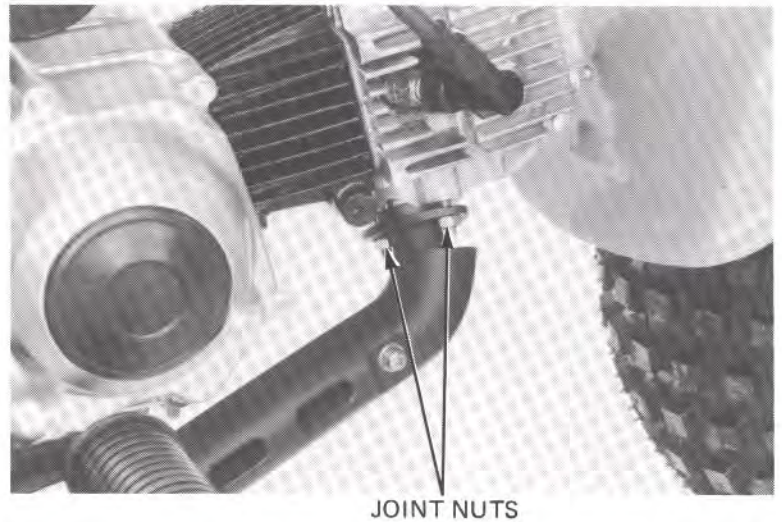

Remove the exhaust pipe mount bolts.

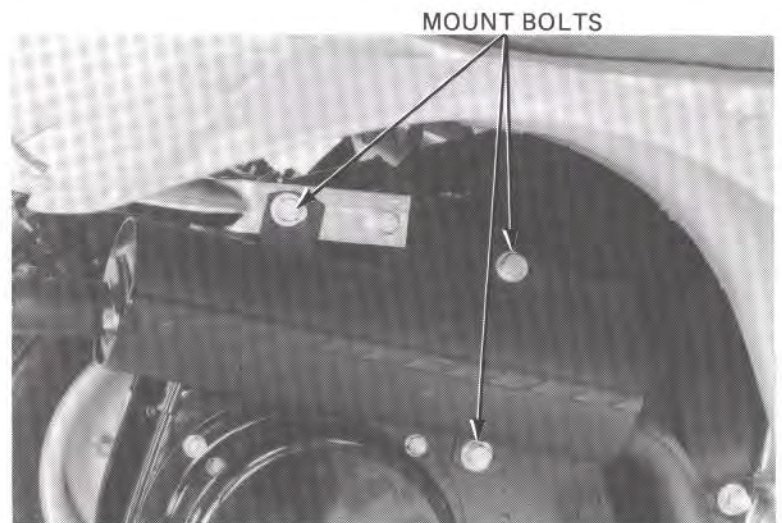



REAR WHEEL/BRAKE/DRIVE MECHANISM

FOOT PEG

REMOVAL/INSTALLATION

Remove the exhaust pipe (Page 12-11).

Stand the ATC on its rear wheels and rear carrier.

CAUTION:

To prevent fuel spillage; if the fuel tank is more than half full, either drain the fuel or remove the fuel tank (Page 4-3).

Remove the foot peg mount bolts and foot peg.

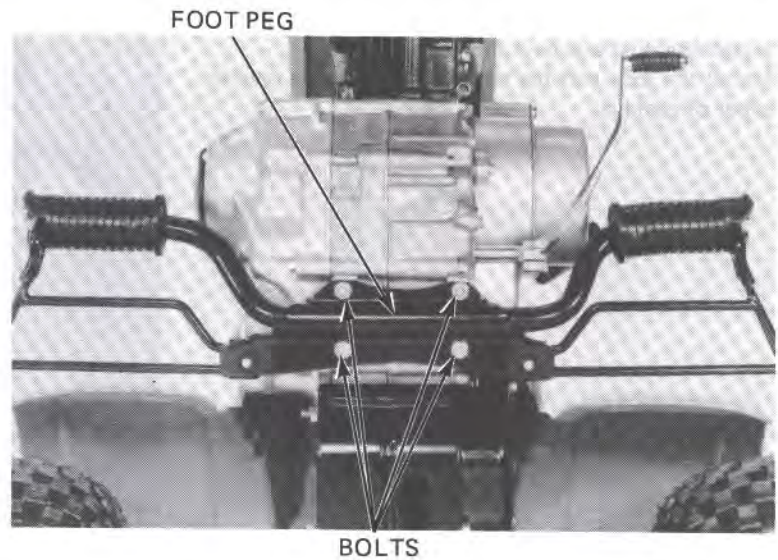



SERVICE INFORMATION	13-1
TROUBLESHOOTING	13-1
IGNITION COIL	13-2
CONTACT POINTS	13-3
ALTERNATOR	13-4
ENGINE STOP SWITCH	13-4
WIRING DIAGRAM	13-5

SERVICE INFORMATION

GENERAL

- For ignition timing, refer to page 3-4.
- For spark plug inspection, refer to page 3-6.
- For contact point inspection, refer to page 3-4.

SPECIFICATIONS

Item		Specifications
Spark plug		NGK CR7HS or ND U22FSR-L
Spark plug gap		0.6–0.7 mm (0.024–0.028 in)
Contact point gap		0.3–0.4 mm (0.012–0.016 in)
Ignition coil resistance	Primary	1.35–1.65 Ω
	Secondary	7.65–9.35 K Ω
Condenser capacity		0.22–0.26 μ F
Alternator coil resistance		2.43–2.97 Ω

TROUBLESHOOTING

Engine cranks but will not start

- Engine stop switch OFF
- No spark at plug

No spark at plug

- Engine stop switch OFF
- Points not opening
- Points burned, wet fouled or dirty
- Poorly connected, broken or shorted wire
 - Between ignition coil and contact point
 - Between ignition coil and ground
- Plug fouled
- Faulty plug wire
- Coil weak or inoperative
- Faulty condenser
- Faulty ignition coil
- Faulty alternator

Engine starts but runs poorly

- Ignition primary circuit
 - Points dirty or fouled
 - Incorrect point gap
 - Faulty ignition coil
 - Faulty condenser
 - Loose or bare wire
 - Intermittent short circuit
- Ignition secondary circuit
 - Faulty plug
 - Faulty high tension wire
- Improper ignition timing



IGNITION COIL

INSPECTION

Disconnect the ignition coil primary wire and check the resistance between the ignition coil primary terminal and ground.

RESISTANCE: 1.35–1.65 Ω

PRIMARY TERMINAL

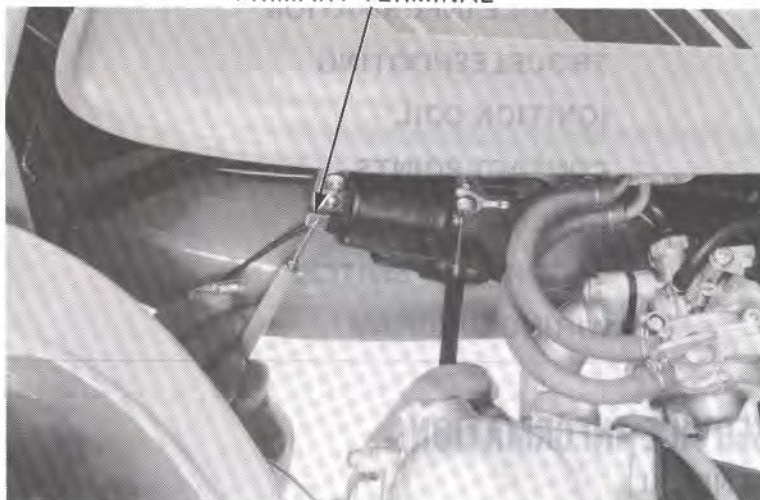

Disconnect the plug cap.

Check the resistance between the primary terminal and plug cap.

RESISTANCE: 7.65–9.35 Ω



REMOVAL

Disconnect the coil wires and remove the two screws and the ignition coil.

INSTALLATION

Install the ignition coil and connect the wires.

SCREWS

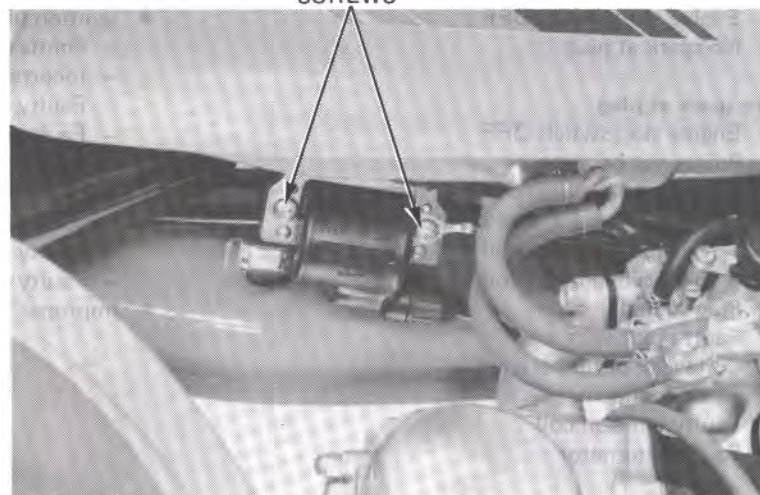



CONTACT POINTS

REMOVAL

Remove the recoil starter and flywheel (Page 9-2).
Disconnect the point wire.
Remove the contact point assembly.

For contact points inspection, see page 3-4.

NOTE:

If the oil felt is dry, apply one or two drops of clean engine oil to it.

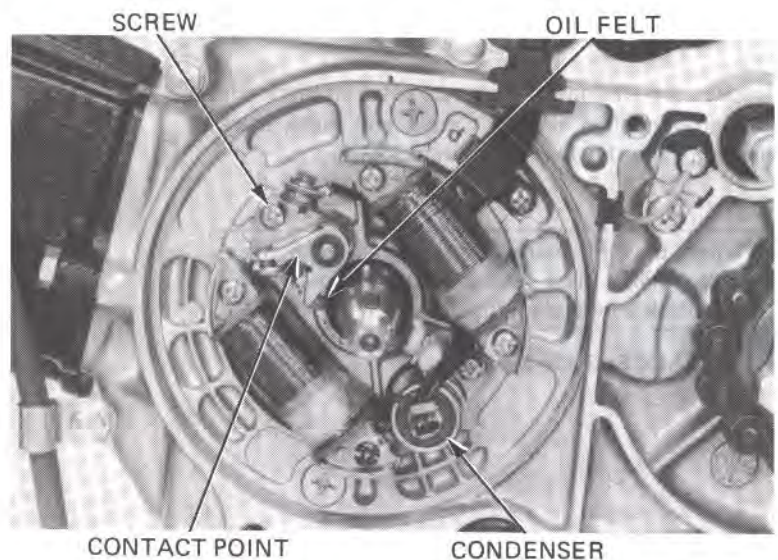

CONDENSER CAPACITY TEST

Remove the condenser from the base plate.
Discharge the condenser by grounding its terminal against its casing.

Measure the condenser capacity with a tester.

CAPACITY: 0.22–0.26 μ F

If it is out of specification, replace the condenser.

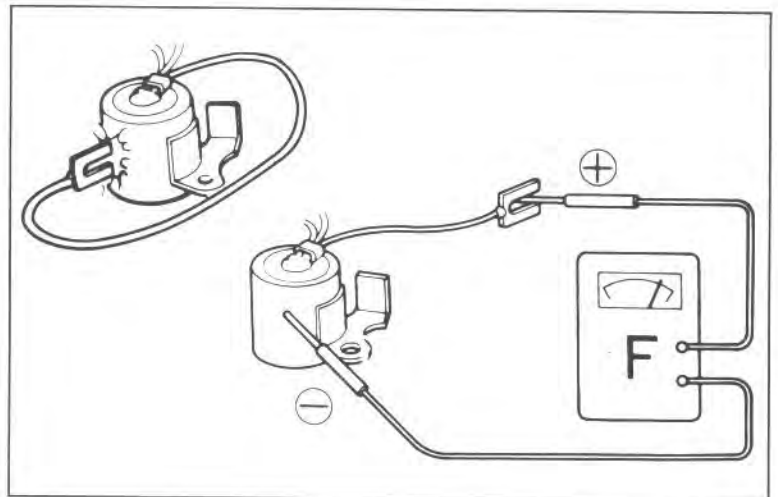

POINT REPLACEMENT

Remove the point setting screw and disconnect the wire.
Replace the contact point.

NOTE:

Do not forget to install the bakelite washers to insulate the condenser/alternator terminal from ground.

Install the contact point assembly in the reverse order of removal.

Adjust the point gap (Page 3-4).

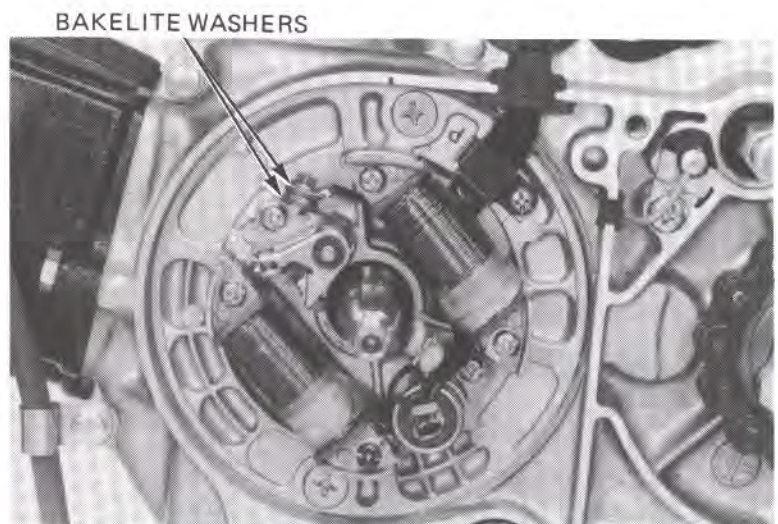



ELECTRICAL

ALTERNATOR

Inspect the alternator resistance between black wire and ground align the "F" mark and index mark, then turn the flywheel counterclockwise.

NOTE:

When the "F" mark is not aligned with the index mark, there should continuity between the black wire and ground.

RESISTANCE: 2.43–2.97 Ω

ENGINE STOP SWITCH

Check for continuity of the engine stop switch wires in each switch position.

RUN: Black to Green
OFF: No continuity

Terminal Position	IG	E
OFF	○	○
RUN		
OFF	○	○
Color	Black	Green

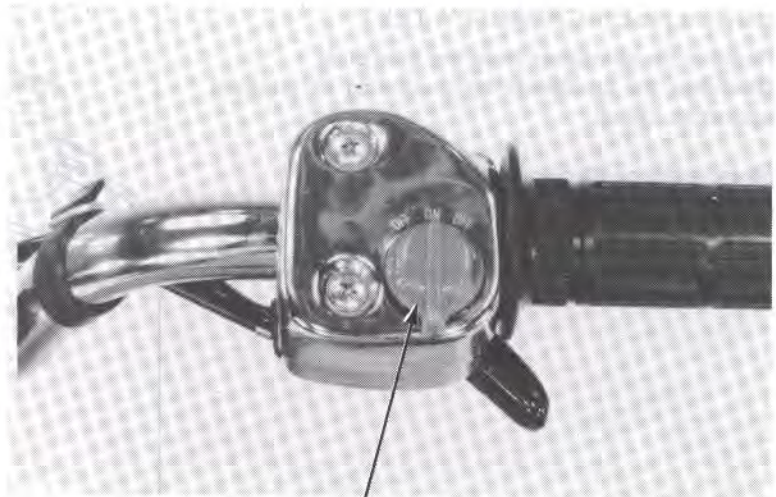

ENGINE STOP SWITCH



WIRING DIAGRAM

ENGINE STOP SWITCH

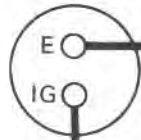

IGNITION COIL

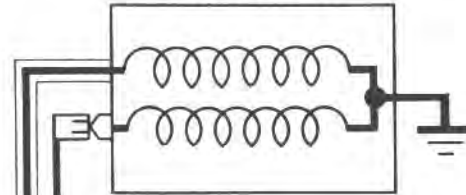

BI

G

BI

SPARK PLUG

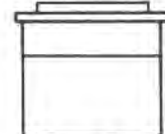

BI

G

Lg

NEUTRAL SWITCH

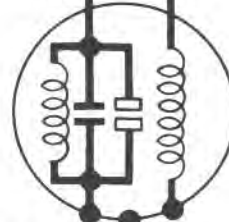

ALTERNATOR

ENGINE STOP SWITCH CONTINUITY

	IG	E
OFF		
ON		
OFF		
COLOR	BI	G

BI Black
G Green
Lg Light Green



HONDA
ATC70

MEMO





14. TROUBLESHOOTING

ENGINE WILL NOT START OR IS HARD TO START	14-2	FAULTY CLUTCH	14-6
ENGINE LACKS POWER	14-3	DIFFICULT SHIFTING	14-6
POOR PERFORMANCE AT IDLE AND LOW SPEED	14-4	ENGINE NOISE	14-6
POOR HIGH SPEC PERFORMANCE	14-5	POOR HANDLING	14-7
SMOKING EXHAUST	14-6	FAULTY BRAKE	14-7



TROUBLESHOOTING

ENGINE WILL NOT START OR IS HARD TO START

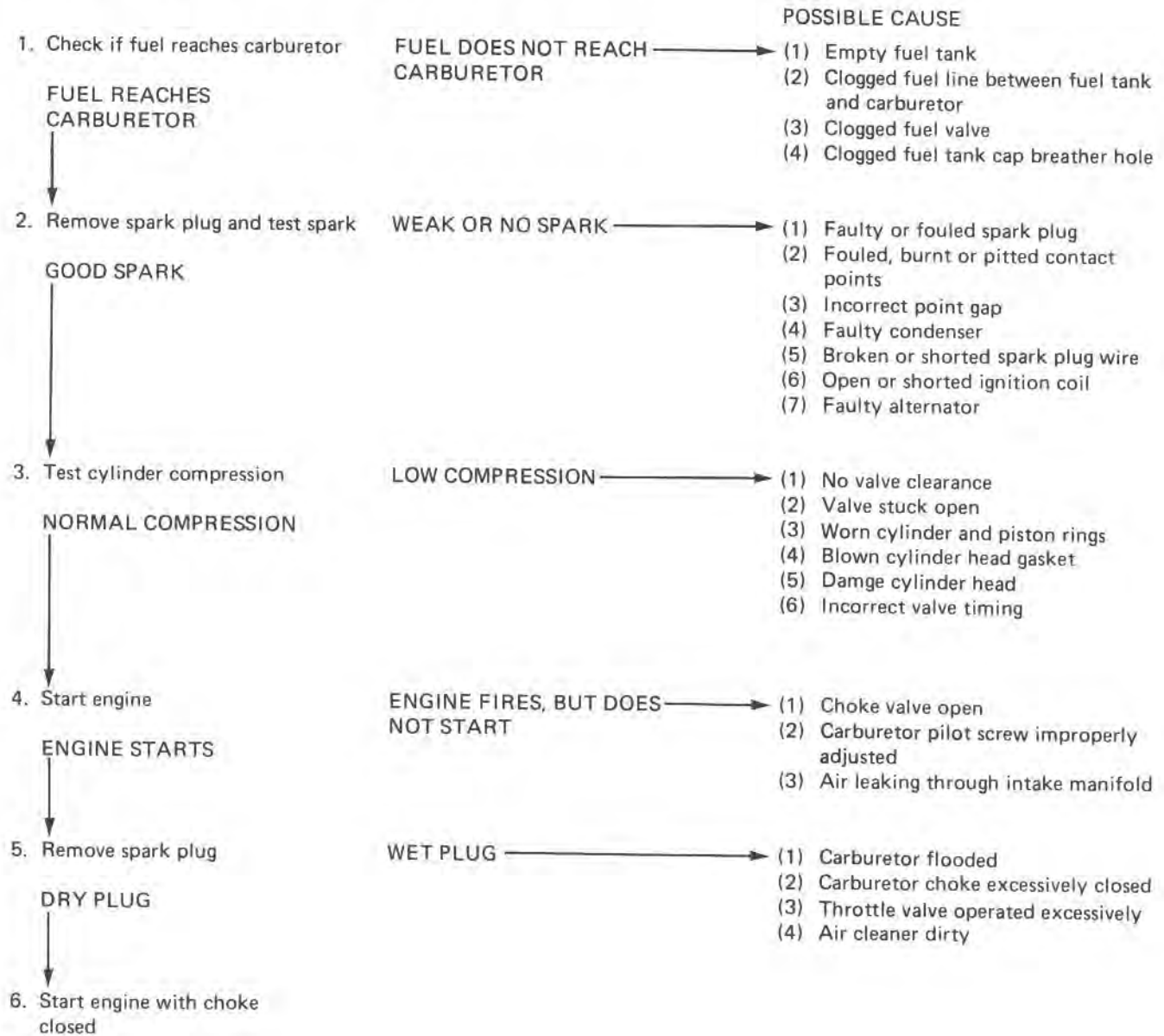



ENGINE LACKS POWER

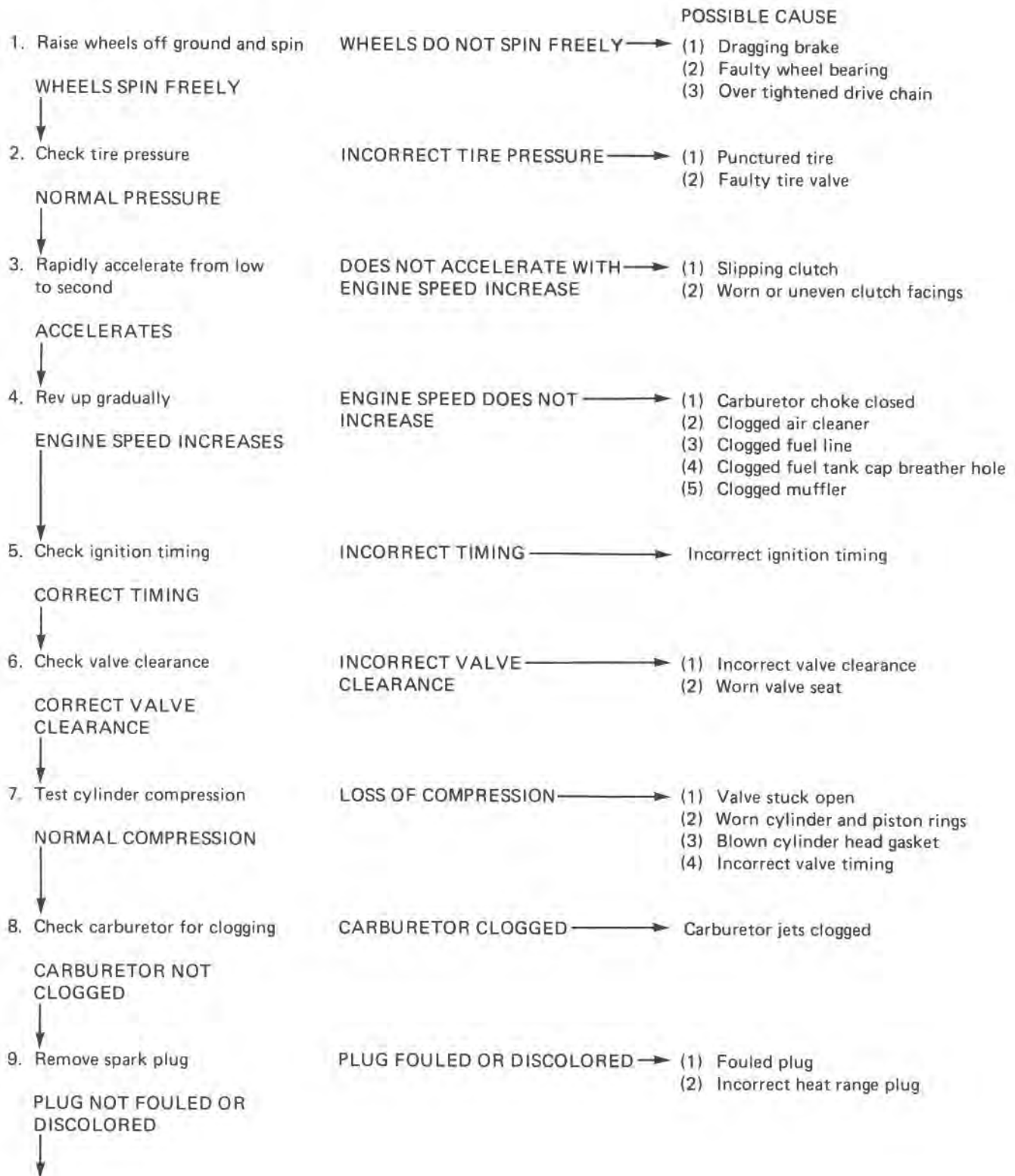



TROUBLESHOOTING

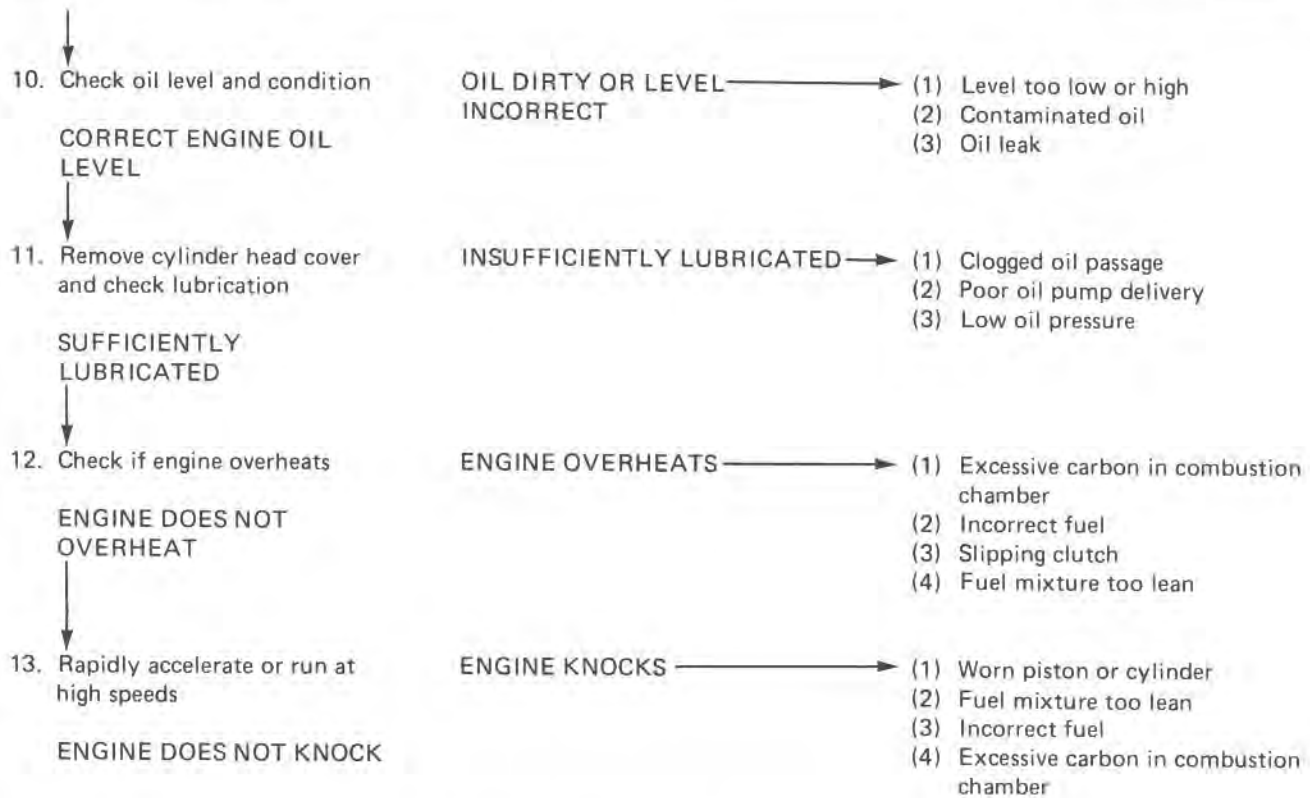

POOR PERFORMANCE AT IDLE AND LOW SPEED

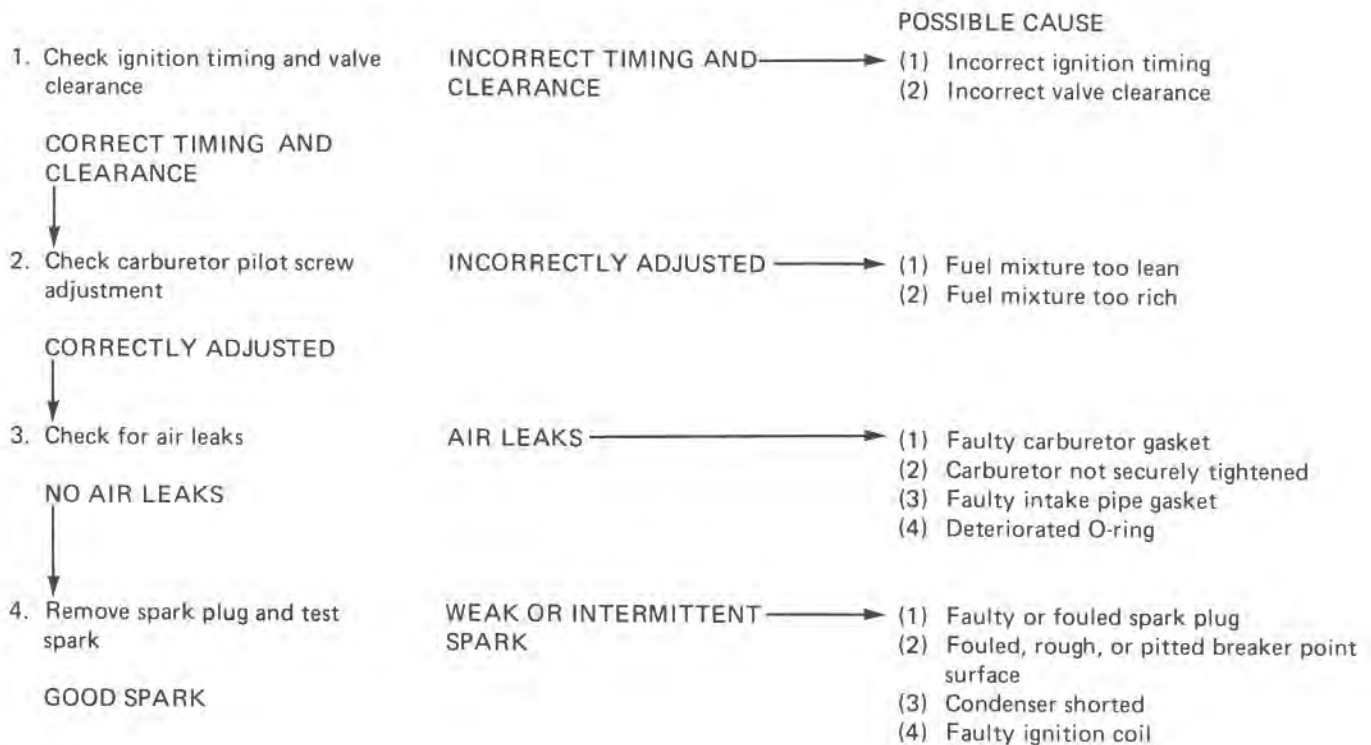



POOR HIGH SPEED PERFORMANCE

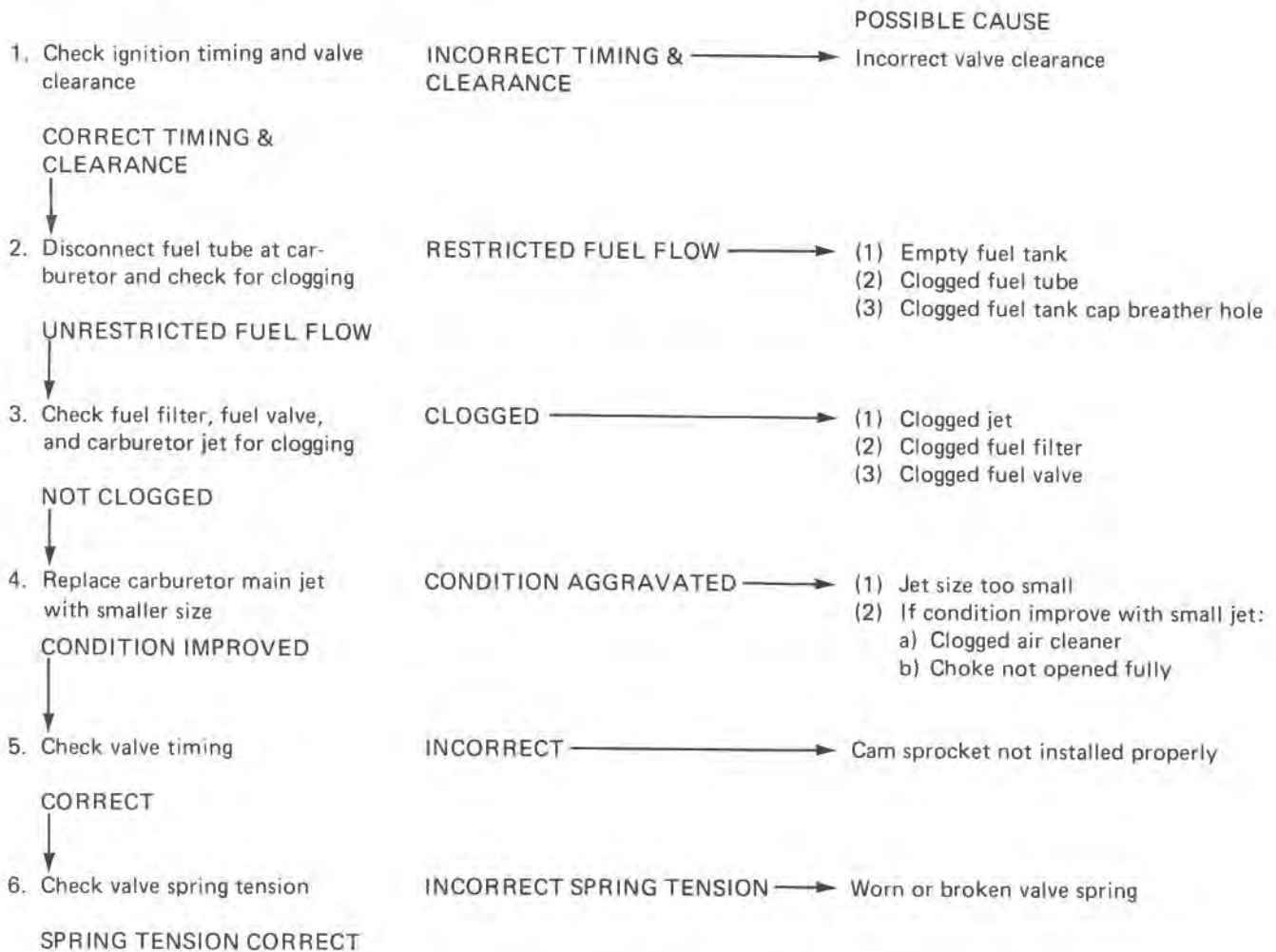

SMOKING EXHAUST

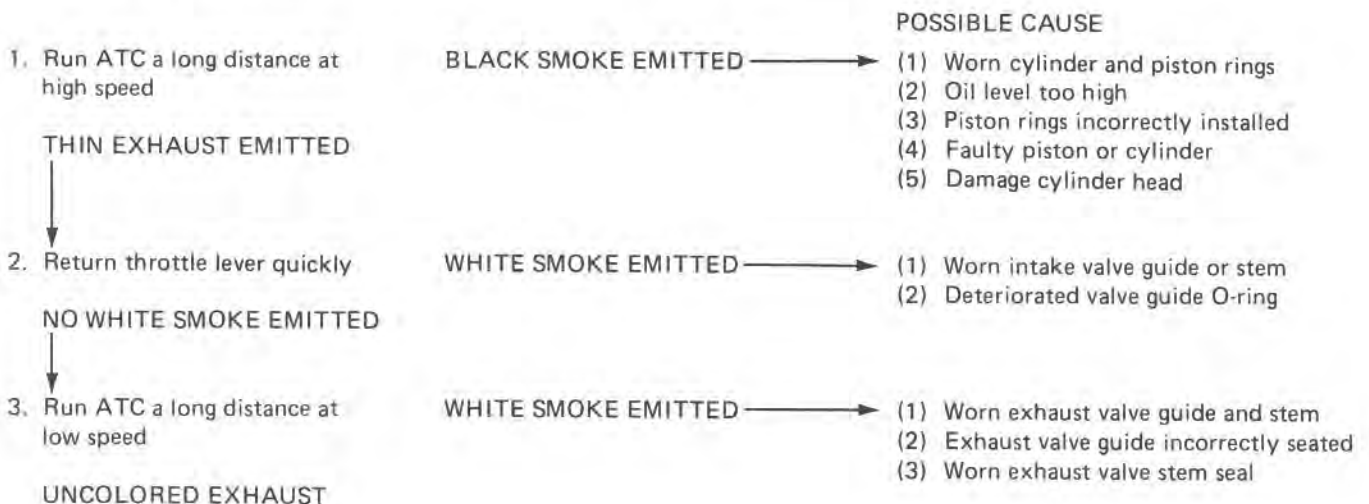



FAULTY CLUTCH

1. Properly adjusted clutch

CLUTCH SLIPPING →

POSSIBLE CAUSE

- (1) Weak clutch spring
- (2) Worn or distorted clutch plate or friction disc

DIFFICULT SHIFTING

DIFFICULT SHIFTING →

POSSIBLE CAUSE

- (1) Broken gear shift arm spring
- (2) Broken shift fork
- (3) Sluggish movement of shift drum or forks
- (4) Broken shifting gear protrusion
- (5) Shift arm pawel disconnected from shift drum

PEDAL DOES NOT RETURNED TO NEUTRAL →

- (1) Broken shift return spring
- (2) Shift shaft interferring with case or cover

GEARS JUMPING OUT OF PISTON →

- (1) Worn shifting gear or bent shift fork
- (2) Broken or weakened shift drum stopper spring

ENGINE NOISE

VALVE NOISE →

POSSIBLE CAUSE

- (1) Excessive valve clearance
- (2) Worn valve

PISTON SLAP →

- (1) Worn piston and cylinder
- (2) Excessive carbon in combustion chamber
- (3) Worn piston pin and connecting rod small end

CAM CHAIN NOISE →

- (1) Worn camshaft sprocket teeth
- (2) Stretched cam chain

CLUTCH CHATTER →

- (1) Excessive clearance between clutch plate and clutch outer
- (2) Weakened clutch damper spring

NOISY DRIVE & DRIVEN GEARS →

- (1) Worn or deteriorated driven gear damper
- (2) Worn gear teeth



POOR HANDLING

	POSSIBLE CAUSE
DIFFICULT STEERING IN BOTH DIRECTIONS →	(1) Overtightened steering head top thread nut (2) Broken steering ball bearings (3) Bent steering stem
WHEEL WOBBLING →	(1) Excessive play in wheel bearing (2) Bent wheel rim (3) Frame bent (4) Drive chain adjusters unequally adjusted
ATC PULLS TO ONE SIDE →	(1) Bent rear axle (2) Bent front fork

FAULTY BRAKE

	POSSIBLE CAUSE
ADJUSTER INEFFECTIVE →	Worn brake lining, brake shoe or brake cam
SQUEAKING →	(1) Worn brake lining (2) Foreign particles on brake lining (3) Rough brake drum shoe containing face (4) Worn brake panel bushing
BRAKE INEFFECTIVE →	(1) Faulty brake cable (2) Brake shoe partially contacted (3) Mud or water in brake (4) Oil or grease on brake lining (5) Worn brake lining



HONDA
ATC70

MEMO



ATC70 #4
SEPTEMBER 1985

SERVICE BULLETIN

AMERICAN HONDA MOTOR CO., INC. MOTORCYCLE SERVICE DEPARTMENT

1985 ATC70 DIFFICULT SHIFTING

Over a period of time, shifting gears on some of the affected units listed below may require increased effort.

Replacing the shift drum stopper arm and stopper plate with the parts listed in this bulletin will improve shifting performance.

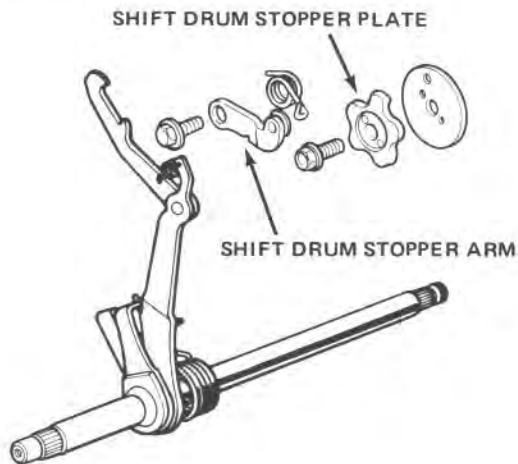

AFFECTED UNITS

1985 ATC70 - Eng. #3000001 to 3047951

PROCEDURE

1. Replace the Shift Drum Stopper Arm and Stopper Plate with the parts listed in this bulletin according to the procedures in the Shop Manual.

NOTE: Apply Honda Anaerobic Thread Lock, or an equivalent, to the threads of the Shift Drum Stopper Plate bolt before reinstalling it.

2. For future identification, make a center punch mark on the crankcase directly to the right of the engine number.

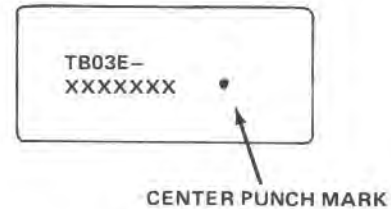

PARTS INFORMATION

Shift Drum Stopper Arm/Plate Set

H/C 2210300 P/N 24410-957-305

Set includes:

- Shift Drum Stopper Arm
H/C 0476820 P/N 24430-041-010
- Shift Drum Stopper Plate
H/C 2210318 P/N 24411-957-670

NOTE: These parts must be replaced as a set.

WARRANTY INFORMATION

The normal warranty applies. If you feel goodwill consideration is appropriate, contact your DSM for approval before starting the job.

Defect Code: 031

Failed Honda Code: 1076827

Labor Operation Number: 210125

Flat Rate Time: 0.6 hr.

Treatment Code: 1

ROUTING:

COPY 1

COPY 2

GENERAL MANAGER

SERVICE MANAGER

SALES DEPT.

MECHANICS

OFFICE FILE

SHOP MANUAL





ATC70 #1
REV. JULY, 1984

ATC70—1973 AND AFTER REQUIRED SPECIAL TOOLS

(This supersedes ATC70 #1, dated August 1983)

One **NEW** Special Tool has been added to the required list to service and maintain this model. This tool will be shipped to you automatically when it becomes available. The other tools listed below have already been introduced for this model or other models. If you do not have these tools, they can be ordered using normal procedures. You must have all the required special tools or their approved equivalents in your dealership as per Paragraph 8.4 of the Honda Sales Agreement.

ENGINE TOOLS

INSPECTION/ADJUSTMENT			
H/C	TOOL NUMBER	DESCRIPTION	APPLICABILITY
0238923	07401-0010000	Carburetor Float Level Gauge	Float level inspection.
0034512	*089201-200-000 (07908-GB4000)	Valve Adjuster	Use to adjust/hold the 3 mm square driver valve adjustment scREW. Use a commercially available off-set box end wrench for lock nut.

CYLINDER HEAD/PISTON			
H/C	TOOL NUMBER	DESCRIPTION	APPLICABILITY
0915637	07742-0010100	Valve Guide Driver	Valve guide removal. Supersedes 07942-3290100, which can still be used.
0688150	07757-0010000	Valve Spring Compressor	Valve removal/installation. Supersedes 07957-3290001 which can still be used.
0324186	07942-1180100	Valve Guide Driver	Valve guide installation.
0332049	07984-0980000	Valve Guide Reamer, 5.47 mm	Valve guide I.D. sizing.

CLUTCH			
H/C	TOOL NUMBER	DESCRIPTION	APPLICABILITY
0647578	07716-0020100	Lock Nut Wrench, 20 x 24 mm	Clutch nut removal/torquing.

ALTERNATOR			
H/C	TOOL NUMBER	DESCRIPTION	APPLICABILITY
1049154	07725-0030000	Universal Holder	Assist rotor nut removal/torquing. Replaces 07925-0010001, which can still be used.
0060756	*07933-0010000 (07733-0010000)	Rotor Puller	Rotor removal.

*This tool is substituted for the tool in parenthesis. The tool in parenthesis is listed in the shop manual but is unavailable from American Honda Motor Co., Inc.

(over)

MST 1300-7741 8407

ROUTING

Copy 1:

GENERAL MANAGER

PARTS MANAGER

TOOL CATALOG BINDER

Copy 2:

SERVICE MANAGER

SERVICE TECHNICIANS

SERVICE MANUAL BINDER

ENGINE TOOLS (CONT'D)

TRANSMISSION/CRANKSHAFT

H/C	TOOL NUMBER	DESCRIPTION	APPLICABILITY
0753491	07946-0010200	Attachment, 37 x 40 mm	Mainshaft, countershaft bearing #6203 installation. Use with 07746-0040400.
0959833	07746-0020100	Attachment, 20 mm I.D.	Crankshaft bearing installation. Use with 07746-0020400.
0959841	07746-0020400	Driver, 22 mm	Use with 07746-0020100.
0959890	07746-0040400	Pilot, 17 mm	Use with 07746-0010200 to install the mainshaft and countershaft bearings.
0933242	07749-0010000	Driver	Use with attachments and pilot.

CHASSIS TOOLS

WHEEL/BRAKE

H/C	TOOL NUMBER	DESCRIPTION	APPLICABILITY
1411941	GN-AH-958-BB1	Universal Bead Breaker	To break tire bead from rim.
0753509	07746-0010100	Attachment, 32 x 35 mm	Front wheel bearing #6202 installation.
0753483	07746-0010400	Attachment, 52 x 55 mm	Rear hub bearings installation #6006 '78 and later models and #6205 '73-'77 models.
0959882	07746-0040300	Pilot, 15 mm	Use with attachment 07746-0010100
0959916	07746-0040600	Pilot, 25 mm	Use with attachment 07746-0010400 to install '73-'77 rear hub bearings.
1021252	07746-0040700	Pilot, 30 mm	Use with attachment 07746-0010400 to install rear hub bearings '78 and later models.
0933242	07749-0010000	Driver	Use with attachments and pilots.

SUSPENSION/FRAME

H/C	TOOL NUMBER	DESCRIPTION	APPLICABILITY
0917740	M9360-277-91774	Bearing Remover	Upper and lower steering race removal. Replaces 07944-115001 which can still be used.
1174002	07716-0020203	Lock Nut Wrench, 26 x 30 mm	Steering stem adjustment removal/adjustment. Pin spanner wrench M9361-412-099788 may also be used.
0753491	07746-0010200	Attachment, 37 x 40 mm	Upper & lower steering race installation.
0933242	07749-0010000	Driver	Use with attachments.
NEW **N/A	07946-GC4000A	Attachment	Use with 07946-MB00000 or 07946-3710601 for lower steering stem race installation.
1418219	07946-MB00000	Steering Stem Driver	Use with 07946-GC4000A.

** Honda code not available at this time.

SPECIAL INFORMATION

The tool listed below is necessary to service and repair this model. However, it is not available from American Honda Motor Co., Inc. and must be purchased from other sources.

DESCRIPTION	APPLICABILITY
ATV Tire Repair Kit	See General STN #26 for ordering details.

AMERICAN HONDA MOTOR CO., INC.
SERVICE DEPARTMENT

Set-up Instructions

1985 Model ATC70



MPD 7582 8407
AMERICAN HONDA MOTOR CO., INC.
100 WEST ALONDRA BOULEVARD, GARDENA, CALIFORNIA 90247

WARNING

WARNING

WARNING

WARNING

SET-UP AND PRE-DELIVERY SERVICE MUST BE PERFORMED BY AN AUTHORIZED HONDA ALL TERRAIN VEHICLE (ATV) DEALER. Proper set-up and pre-delivery service is essential to rider safety and reliability of the vehicle. When a customer takes delivery of his brand new vehicle he expects it to be in excellent running condition. There are few things that will cause greater customer dissatisfaction than poor preparation of a new vehicle. An error or oversight made by the mechanic assembling and servicing a new unit can easily result in faulty operation, damage to the vehicle, or even injury to the rider.



NOTE: Right and left are determined from the rider's view.

Date of Issue: 7/84

© American Honda Motor Co., Inc. 1984 - All Rights Reserved

1 of 14

SET-UP INSTRUCTION REVISED PAGES

Pages Affected

1 through 14

Orig. Issue Date

7/84

Rev. Date

Original

Remove and destroy superseded pages.

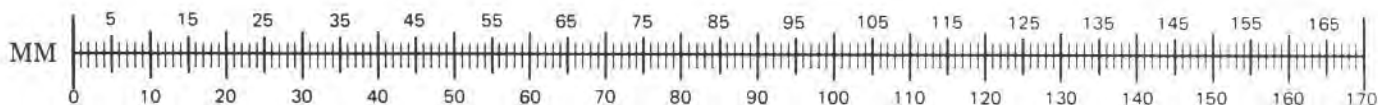

METRIC SCALE FOR DETERMINING BOLT LENGTHS/DIAMETERS

Pay special attention to warnings, cautions, and notes.

WARNING means hazards or unsafe practices which could cause severe personal injury or death.

CAUTION: means hazards or unsafe practices which could cause minor personal injury or product or property damage.

NOTE: gives helpful information.

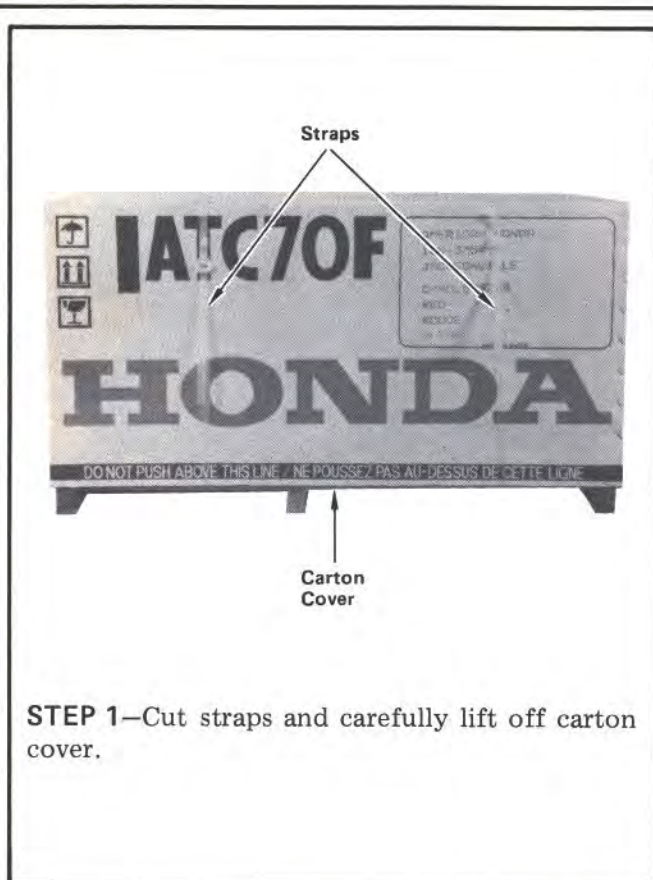

STEP 1—Cut straps and carefully lift off carton cover.

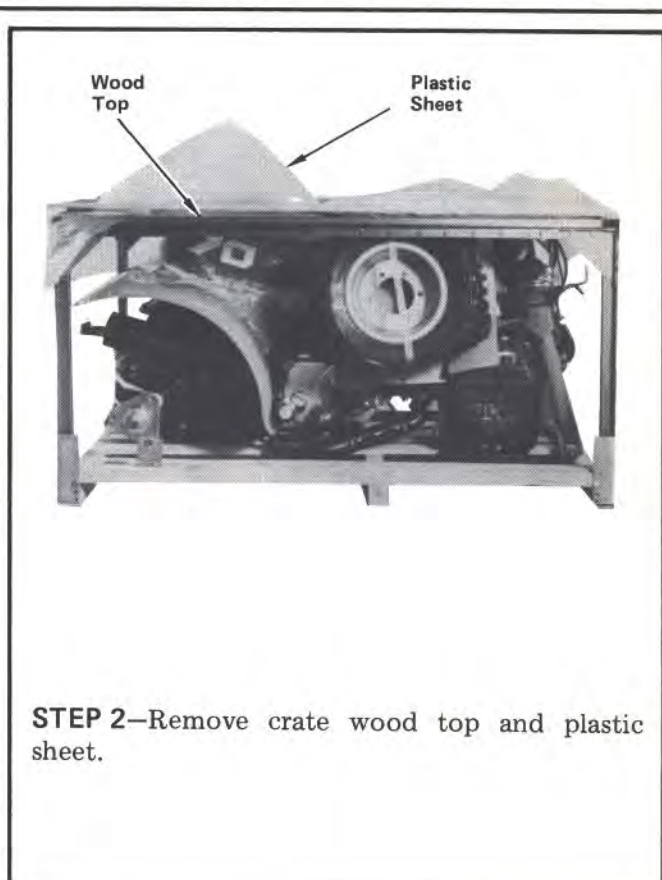

STEP 2—Remove crate wood top and plastic sheet.



STEP 3—Remove vinyl parts bag.

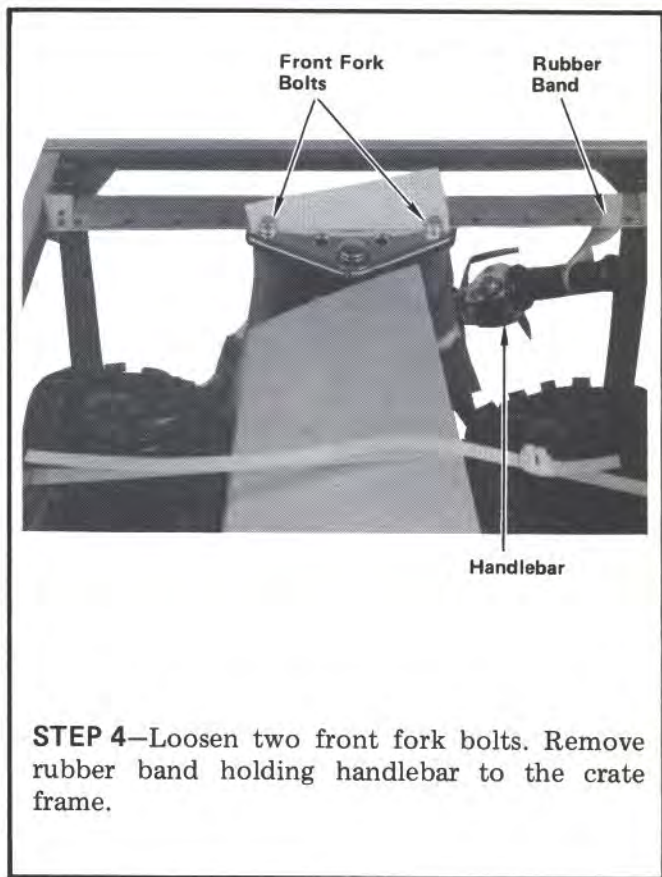

STEP 4—Loosen two front fork bolts. Remove rubber band holding handlebar to the crate frame.

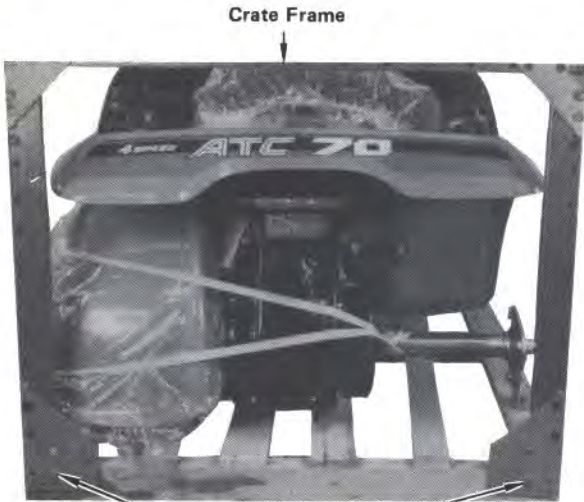

STEP 5—Remove four bolts (two on each end) attaching steel crate frame to crate base and carefully lift off frame.

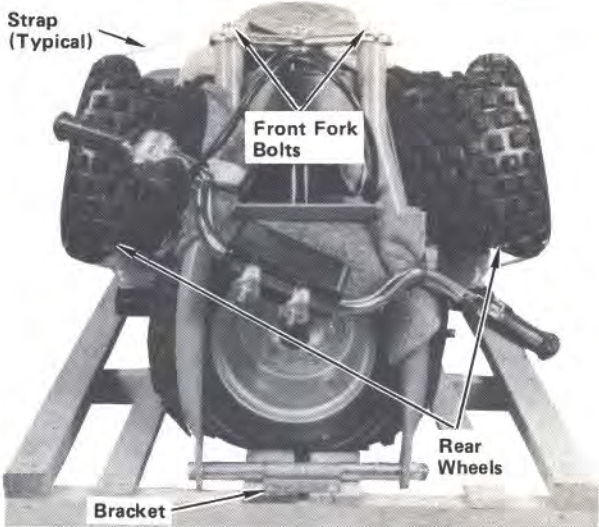

STEP 6—Cut strap holding rear wheels. Remove wheels. Retighten front fork bolts to specified torque.

Torque specification:
4.5 kg-m (32 lb-ft)

Remove bolts attaching front axle shipping bracket to crate base. Discard bolts and bracket.

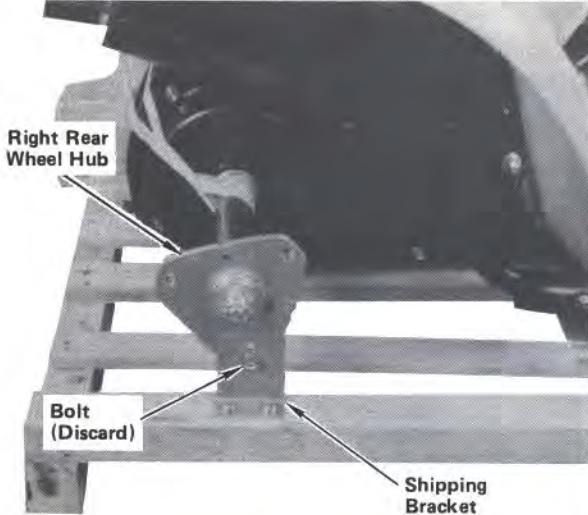

STEP 7—Remove bolt attaching right rear wheel hub to shipping bracket. Discard bolt.



STEP 8—Remove front fender from under rear fender by removing rubber band.

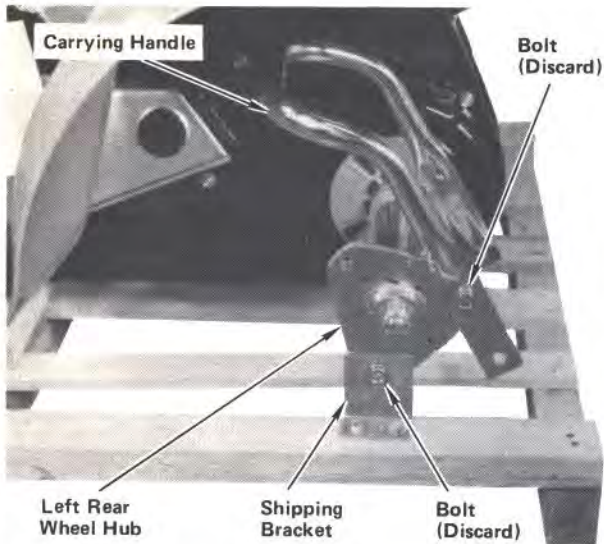

STEP 9—Remove bolt attaching carrying handle to wheel hub and remove carrying handle. Remove bolt attaching left rear wheel hub to shipping bracket. Discard bolts.

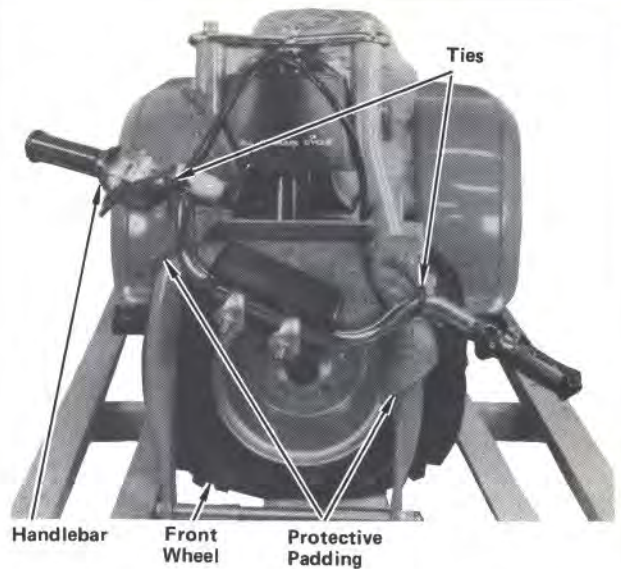

STEP 10—Remove ties holding handlebar to front fork legs. Remove protective padding from front forks. Remove front wheel from behind front forks.

NOTE: Do not let the handlebar hang from handlebar switch wires.

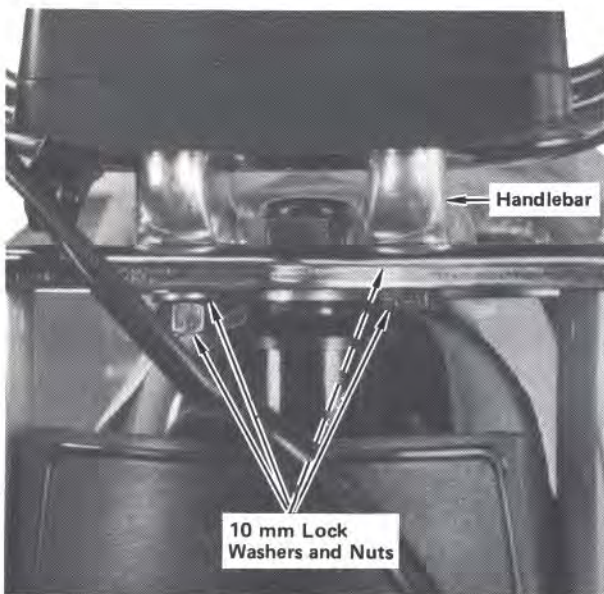

STEP 11—Install handlebar on upper fork bridge as shown using two 10 mm lock washers and nuts. Tighten nuts to specified torque.

Torque specification:
4.3 kg-m (31 lb-ft)

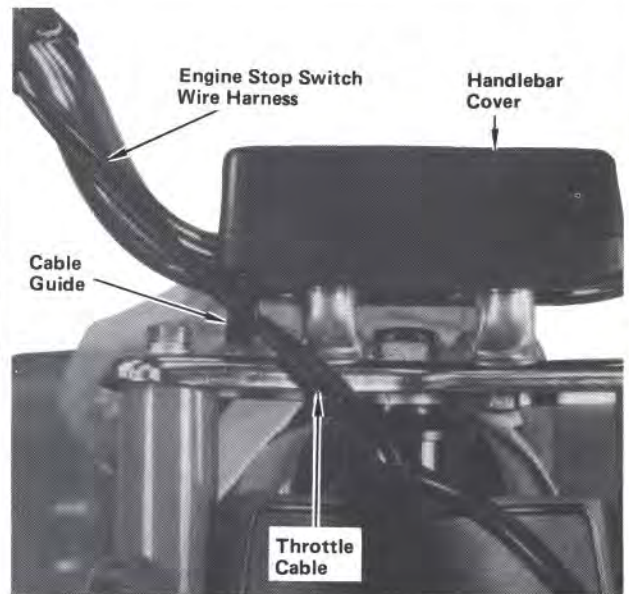

STEP 12—Route engine stop switch wire harness and throttle cable down through cable guide as shown. Tighten screw securely and push cable guide up to edge of handlebar cover.

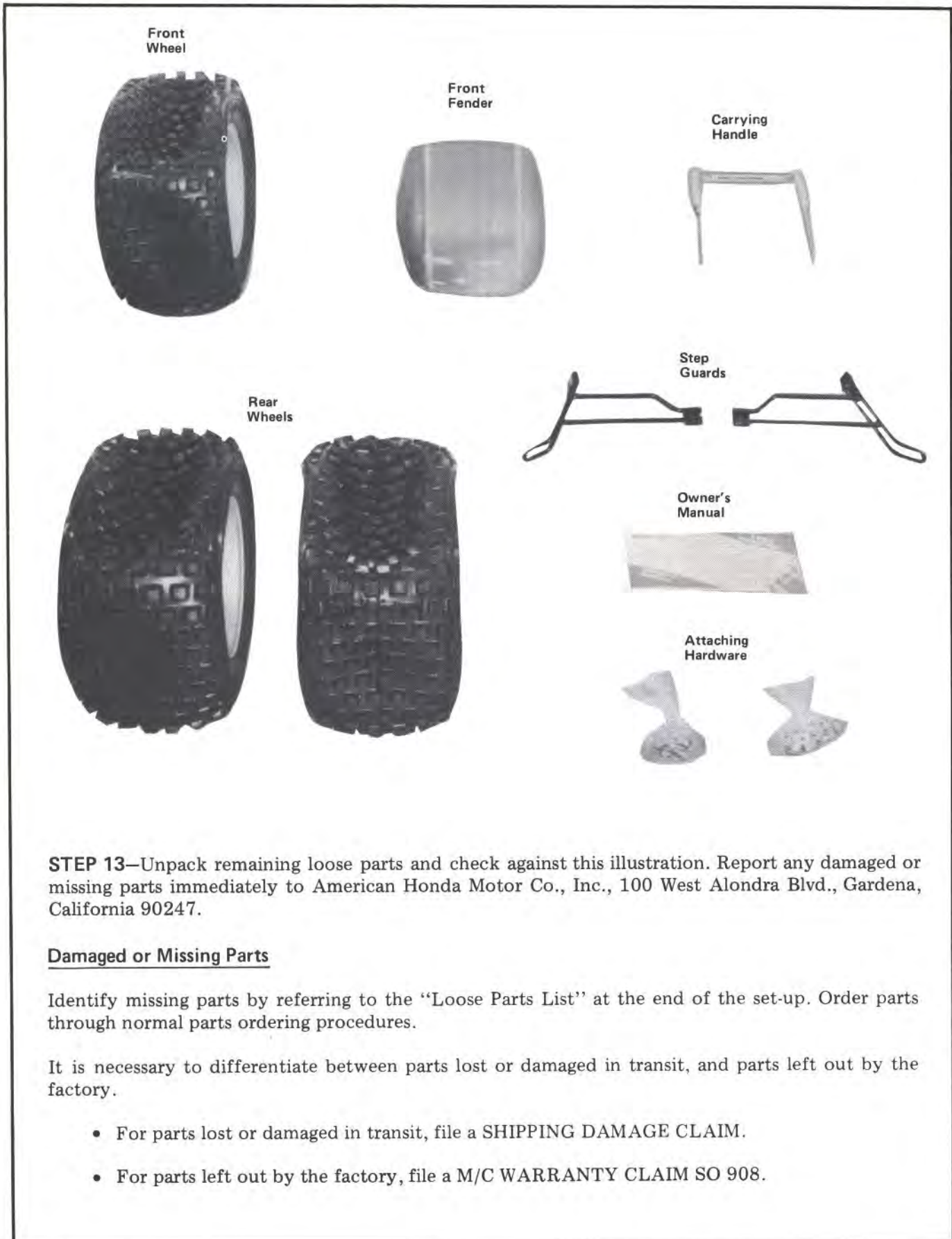

STEP 13—Unpack remaining loose parts and check against this illustration. Report any damaged or missing parts immediately to American Honda Motor Co., Inc., 100 West Alondra Blvd., Gardena, California 90247.

Damaged or Missing Parts

Identify missing parts by referring to the "Loose Parts List" at the end of the set-up. Order parts through normal parts ordering procedures.

It is necessary to differentiate between parts lost or damaged in transit, and parts left out by the factory.

- For parts lost or damaged in transit, file a SHIPPING DAMAGE CLAIM.
- For parts left out by the factory, file a M/C WARRANTY CLAIM SO 908.

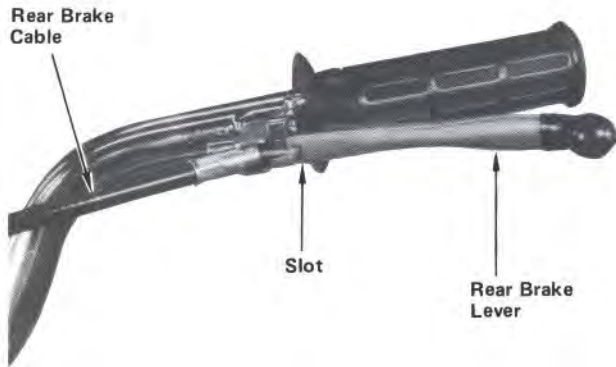

STEP 14—Route rear brake cable in front of throttle cable and insert end of rear brake cable into slot in brake lever. Pull cable back through slot in brake lever bracket.

CAUTION: Check that brake lever operates freely.

Adjust rear brake as described in Step 28.

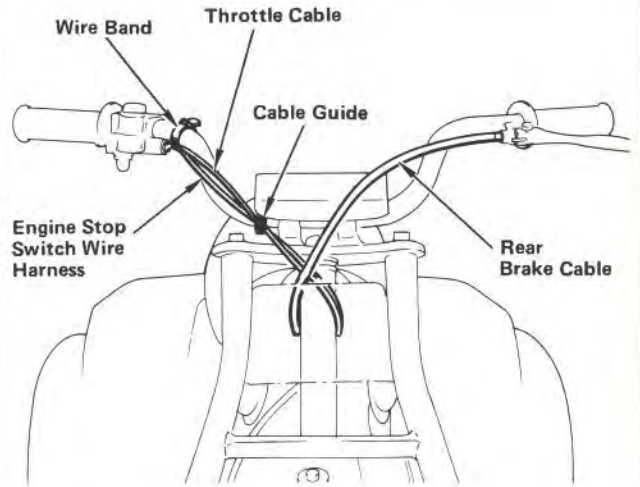

STEP 15—Check for proper routing of cables and wire harness as shown.

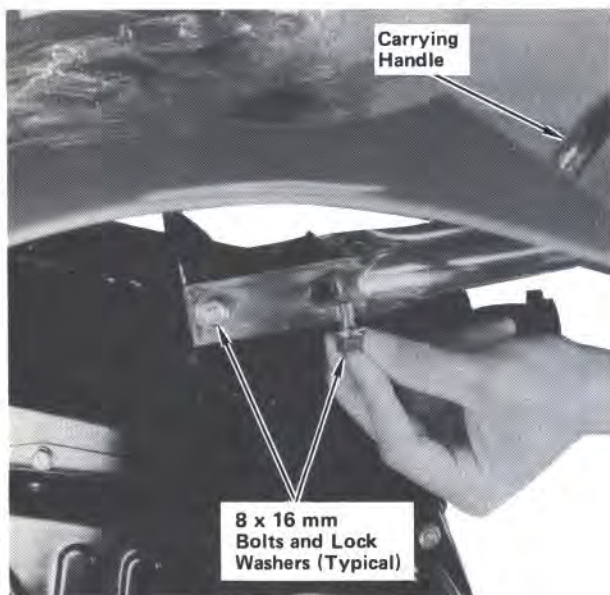

STEP 16—Install carrying handle on frame, with curved end up, using four 8 x 16 mm bolts and lock washers. Tighten bolts to specified torque.

Torque specification:
2.2 kg-m (16 lb-ft)

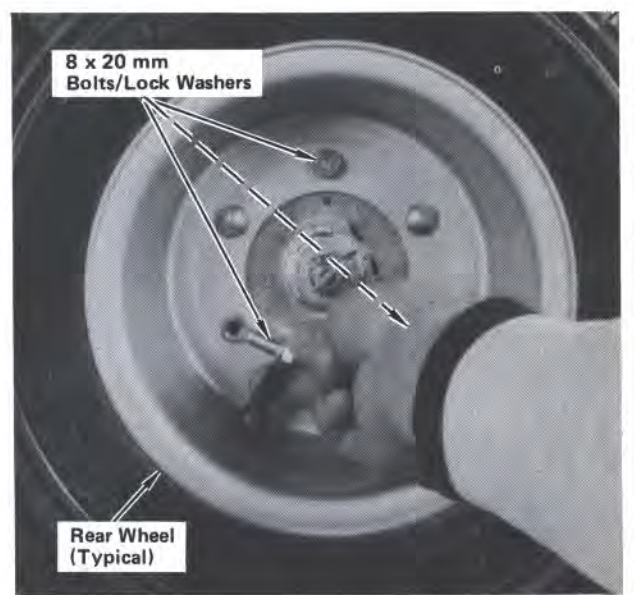

STEP 17—Inflate rear tires to 2.2 psi. Install rear wheels as shown using three 8 x 20 mm bolts/lock washers for each. Tighten bolts to specified torque.

Torque specification:
2.2 kg-m (16 lb-ft)

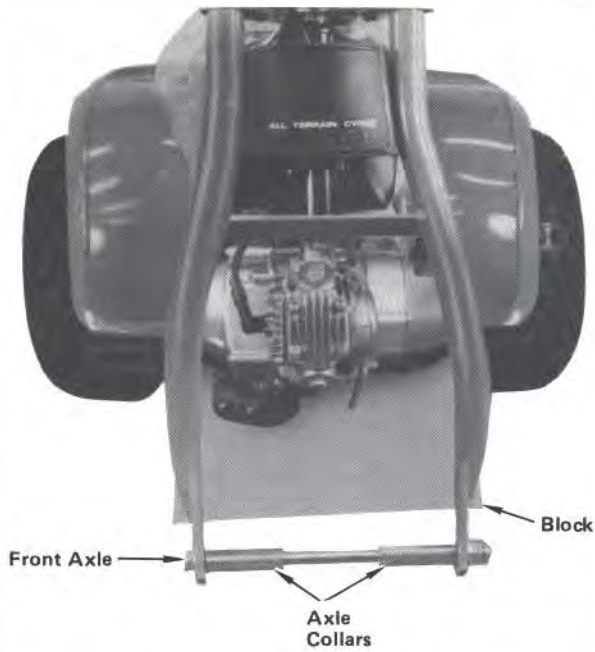

STEP 18—Remove and clean front axle and axle collars. Place a padded block under engine to raise front forks.

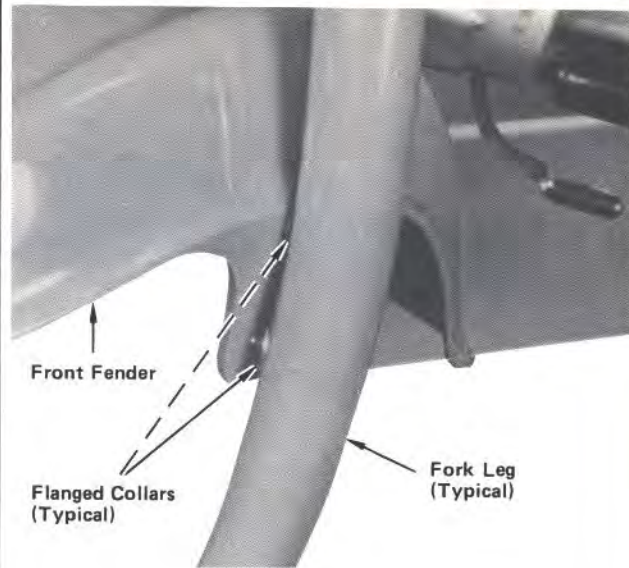

STEP 19—Position front fender between fork legs with short end forward. Position flanged collars between fork legs and front fender.

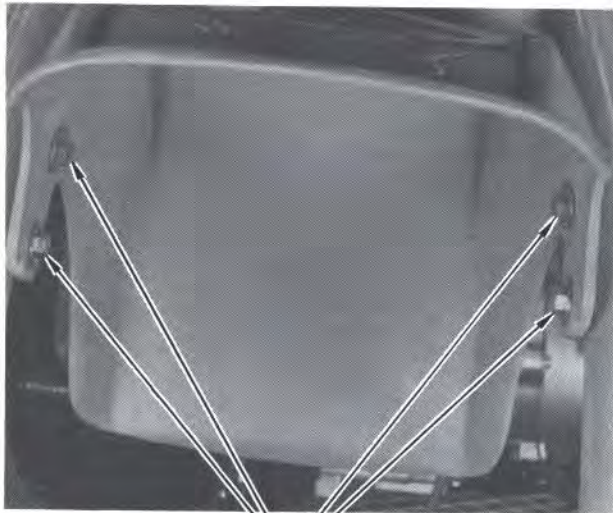

STEP 20—Install front fender using four 6 x 20 mm bolts and plain washers. Tighten bolts securely.



STEP 21—Insert an axle collar into front wheel grease seal on each side. Inflate front tire to 2.2 psi.

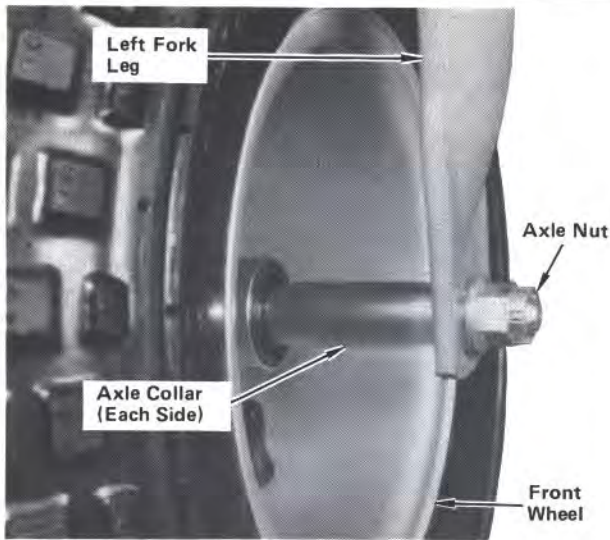

STEP 22—Position front wheel between fork legs with valve stem on left side. Insert axle from right side, through right fork leg, axle collar, wheel hub, axle collar, and left fork leg. Install axle nut and tighten nut to specified torque.

Torque specification:
7.5 kg-m (54 lb-ft)



Cotter Pin

STEP 23—Insert cotter pin through slots in nut and hole in axle. Spread cotter pin ends as shown.

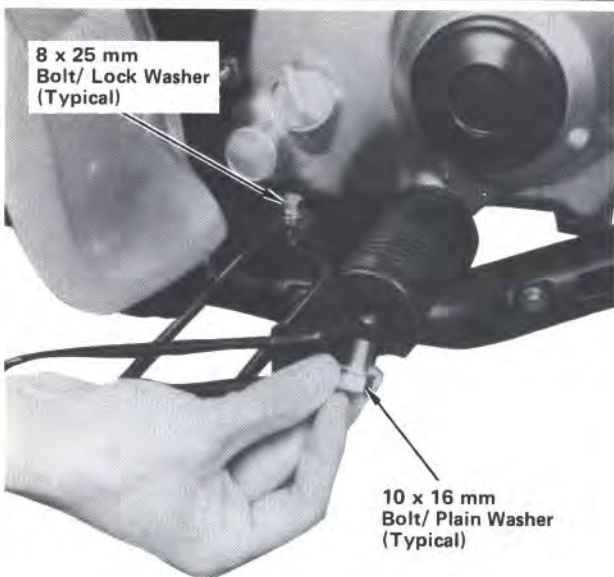

STEP 24—Install right and left step guards as shown using a 10 x 16 mm bolt/plain washer and an 8 x 25 mm bolt/lock washer for each. Tighten bolts to specified torque.

Torque specifications:
8 mm bolts: 2.2 kg-m (16 lb-ft)
10 mm bolts: 4.5 kb-m (32 lb-ft)

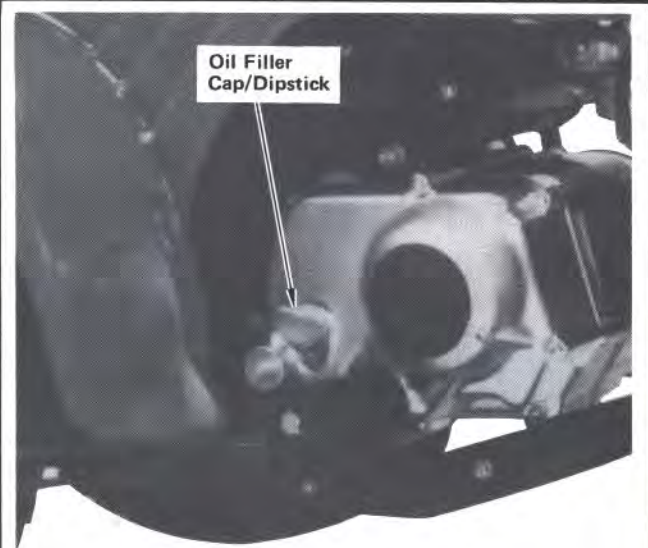

STEP 25—Remove oil filler cap/dipstick. Check engine oil level and if necessary add recommended oil as described in owner's manual or shop manual. Reinstall oil filler cap/dipstick.

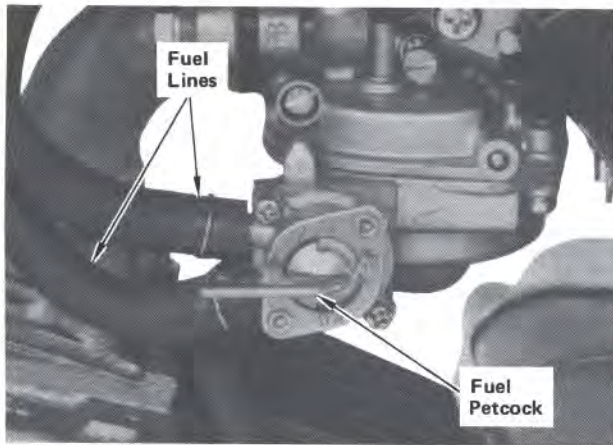

STEP 26—Inspect fuel tank. If necessary, drain and flush fuel tank by removing fuel lines. Reconnect fuel lines, fill tank, turn on fuel petcock and check for leaks. Drain residual fuel from carburetor.

WARNING Fuel must be drained into a proper container. Gasoline is flammable and explosive under certain conditions. Do not smoke or allow flames or sparks near while draining fuel.

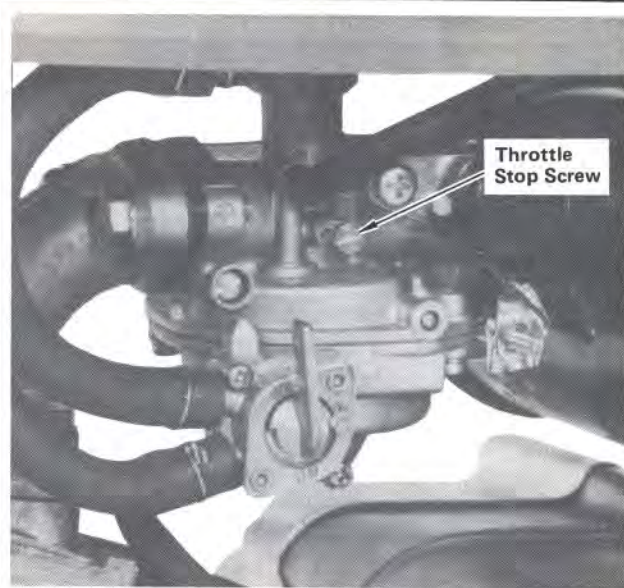

STEP 27—Adjust carburetor air screw, idle speed, and throttle free play as described in owner's manual or shop manual. Refer to owner's manual for use of speed limiter screw.

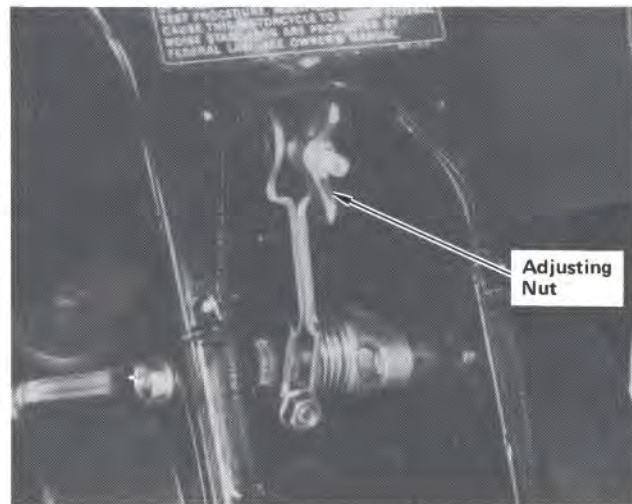
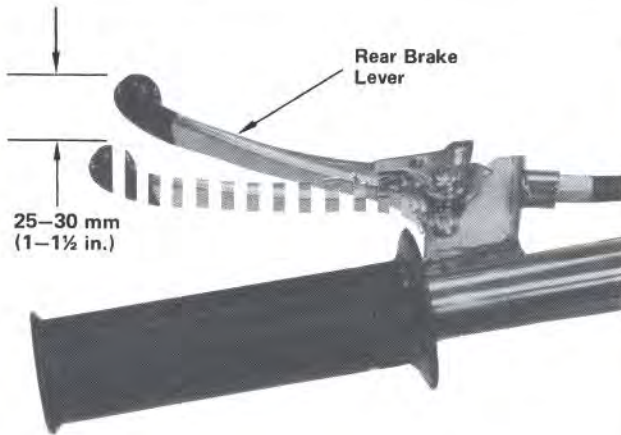

STEP 28—Place a block under ATC. Spin rear wheels by hand and measure free play of rear brake lever before brake starts to engage. Free play, measured at tip of rear brake lever, should be between 25–30 mm (1–1½ in.). Use adjusting nut on brake operating rod at rear of ATC to make adjustment. Remove block from under ATC.

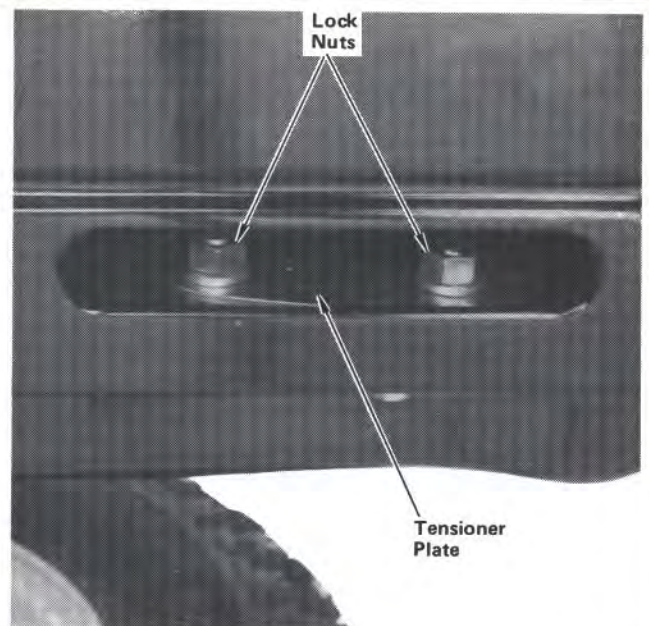
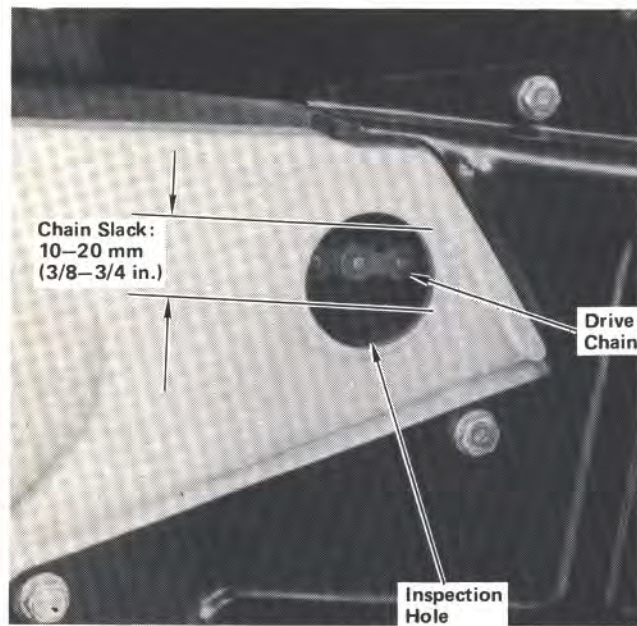

STEP 29—Remove drive chain inspection hole cover and check for a drive chain slack of 10–20 mm (3/8–3/4 in.). If necessary, adjust drive chain slack as follows. Stop engine and position vehicle to obtain access to chain tensioner plate through hole in skid plate. Loosen the two lock nuts and move tensioner plate to obtain correct chain slack. Tighten bolt lock nuts securely. Reinstall inspection hole cover.

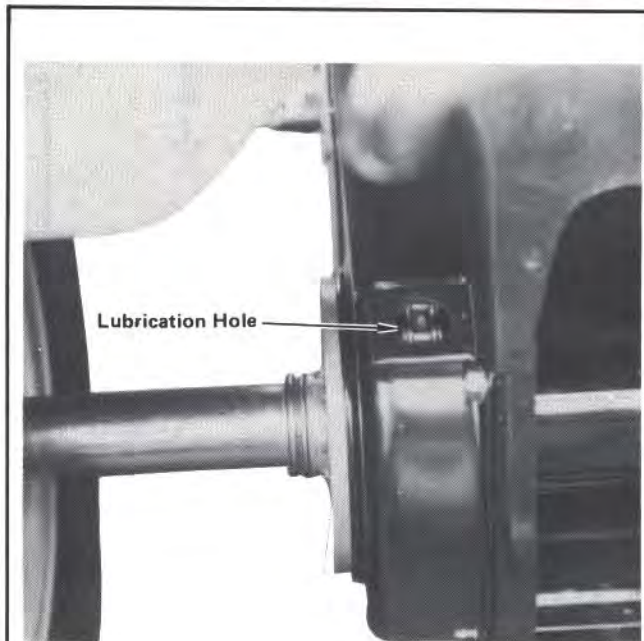

STEP 30—Remove lubrication hole cover and lubricate drive chain using a commercially prepared chain lubricant. Reinstall hole cover.

ENGINE STOP SWITCH

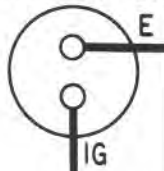

IGNITION COIL

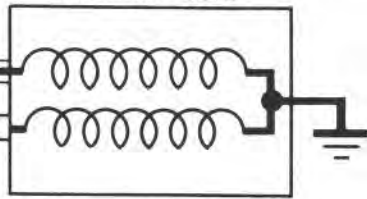

BI

G

BI

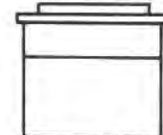

BI

G

Lg

NEUTRAL SWITCH

ENGINE STOP SWITCH CONTINUITY

	IG	E
OFF	○—○	
ON		○—○
OFF	○—○	
COLOR	BI	G

- BI Black
- G Green
- Lg Light Green

A C GENERATOR

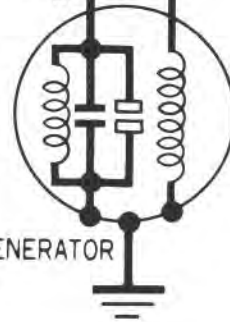

TORQUE TABLE

ITEM	SIZE	TORQUE
Front fork bolts	-----	4.5 kg-m (32 lb-ft)
Handlebar nuts	10 mm	4.3 kg-m (31 lb-ft)
Carrying handle bolts	8 x 16 mm	2.2 kg-m (16 lb-ft)
Rear wheel bolts	8 x 20 mm	2.2 kg-m (16 lb-ft)
Front axle nut	-----	7.5 kg-m (54 lb-ft)
Step guard bolts	8 x 25 mm	2.2 kg-m (16 lb-ft)
	10 x 16 mm	4.5 kg-m (32 lb-ft)

NOTE: Check all items listed on the following Pre-delivery Service Check List. Refer to owner's manual or shop manual for specifications and detailed procedures. Always test ride the unit to make sure that it is functioning properly.

PRE-DELIVERY SERVICE CHECK LIST

- | | |
|--|---|
| <ul style="list-style-type: none"> <input type="checkbox"/> Adjust rear brake, check cable routing and check operation. <input type="checkbox"/> Fill crankcase with recommended oil. <input type="checkbox"/> Inspect fuel tank, drain and flush, if necessary. <input type="checkbox"/> Drain residual fuel from carburetor. <input type="checkbox"/> Check air cleaner. Clean and oil if necessary. <input type="checkbox"/> Fill fuel tank, turn on petcock and check for leaks. <input type="checkbox"/> Adjust carburetor. <input type="checkbox"/> Check throttle lever free play, cable routing, and operation in all steering positions. <input type="checkbox"/> Adjust and lubricate drive chain, if necessary. <input type="checkbox"/> Check tire pressure. <input type="checkbox"/> Inspect electrical component for proper operation. <ul style="list-style-type: none"> • Engine stop switch. | <ul style="list-style-type: none"> <input type="checkbox"/> Check security of all nuts, bolts, and other fasteners. <input type="checkbox"/> Check to ensure that all applicable recall and product update campaigns are complied with. <input type="checkbox"/> TEST RIDE: Check performance, handling, and operation. <ul style="list-style-type: none"> • Transmission and clutch: Ease of shifting, clutch operation, etc. • Acceleration: Smoothness, etc. • Cruising: Smoothness, etc. • Handling: Stability and cornering. • Brake: Smoothness and stopping power. • Idling: Smoothness, throttle response, return to idle. • Recheck idle speed after 10 minutes of stop and go operation. • Upon completion of test ride, check for fuel and oil leaks. |
|--|---|

LOOSE PARTS

The following is a list of loose parts contained in the crate.

PART NAME	QTY	H/C	PART NUMBER
Washer, lock, 10 mm	2	0330928	94111-10800
Nut, hex head, 10 mm	2	0341370	94001-10080-0S
Step guard, right	1	0673954	50620-957-000
Step guard, left	1	0673962	50630-957-000
Bolt-washer, 10 x 16 mm	2	0674895	93492-10016-08
Bolt-washer, 8 x 25 mm	2	0674911	93493-08025-08
Front fender, R-109 passion red	1	-----	61100-957-670
Bolt, hex head, 6 x 20 mm	4	0442103	92000-06020-0H
Collar, front fender	4	1672393	90002-957-000
Washer, plain, front fender	4	0629824	94103-06800
Pin, cotter, 3 x 25 mm, front axle nut	1	0058420	94201-30250
Carrying handle	1	0674119	81200-957-000
Bolt-washer, 8 x 16 mm	4	0674903	93493-08016-08
Bolt-washer, 8 x 20 mm	6	0674887	93492-08020-00
Front wheel	1	-----	-----
Rear wheel	2	-----	-----
Owner's manual	1	1813724	31957620

READ THIS READ THIS READ THIS

READ THIS READ THIS READ THIS

HONDA

Modifications which you have made, or should make in the future, to any Honda product, shall be deemed by our company to have been performed at your sole risk and responsibility, and without our company's or the manufacturer's approval or consent, implied or expressed. We further disclaim any and all liability, obligation, or responsibility for any defects of modified parts or of the modified product, and for any claims, demands, or causes of action for damage to property or for personal injuries resulting from the modification of said Honda product.

READ THIS READ THIS READ THIS