

Official

HONDA

SHOP MANUAL

ATC200S

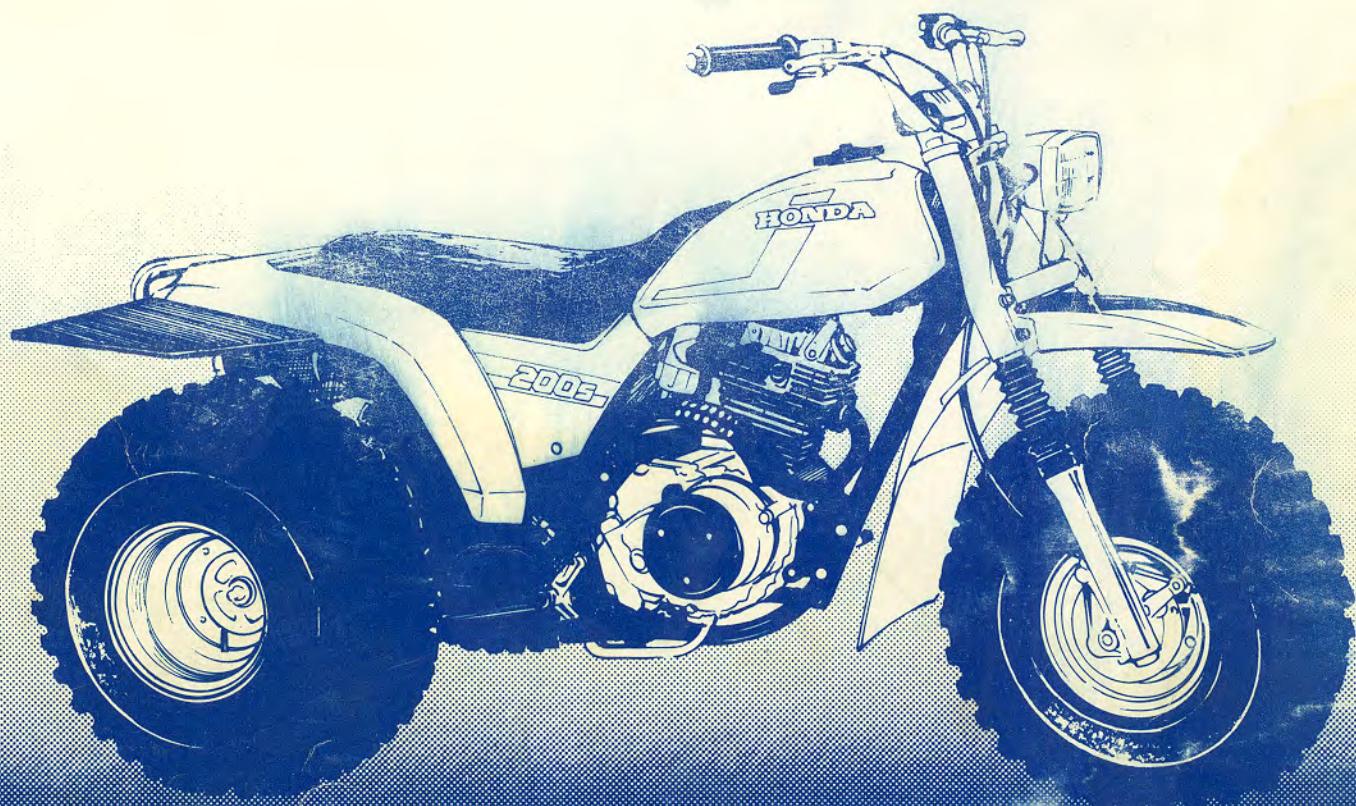

'84~'86

Thank you for your patronage.

This CD was purchased from @home backup. If it was purchased or obtained by any other means, you have illegally obtained this CD and are in violation of its copyrights.

Report copyright violations to: @home backup
Attn: Manual Backups
2902 Grasmere St.
Garland, TX 75040

Unauthorized duplication or distribution is strictly prohibited.

IMPORTANT SAFETY NOTICE



WARNING *Indicates a strong possibility of severe personal injury or loss of life if instructions are not followed.*

CAUTION: *Indicates a possibility of personal injury or equipment damage if instructions are not followed.*

NOTE: Gives helpful information.

Detailed descriptions of standard workshop procedures, safety principles and service operations are not included. It is important to note that this manual contains some warnings and cautions against some specific service methods which could cause **PERSONAL INJURY** to service personnel or could damage a vehicle or render it unsafe. Please understand that those warnings could not cover all conceivable ways in which service, whether or not recommended by Honda might be done or of the possibly hazardous consequences of each conceivable way, nor could Honda investigate all such ways. Anyone using service procedures or tools, whether or not recommended by Honda *must satisfy himself thoroughly* that neither personal safety nor vehicle safety will be jeopardized by the service methods or tools selected.

HOW TO USE THIS MANUAL

Sections 1 through 3 apply to the whole ATC, while sections 4 through 16 describe parts of the ATC, grouped according to location.

Find the section you want on this page, then turn to the table of contents on page 1 of that section.

Most sections start with an assembly or system illustration and all the required specifications, torque values, general instructions, tools and troubleshooting for the section. The subsequent pages give detailed procedures.

If you don't know the source of the trouble, see section 17, TROUBLESHOOTING.

All information, illustrations, directions and specifications included in this publication are based on the latest product information available at the time of approval for printing. Honda Motor Co., Ltd. reserves the right to make changes at any time without notice and without incurring any obligation whatever. No part of this publication may be reproduced without written permission.

HONDA MOTOR CO., LTD.
SERVICE PUBLICATIONS OFFICE

CONTENTS

| | | |
|------------|----------------------------------|----|
| | GENERAL INFORMATION | 1 |
| | LUBRICATION | 2 |
| | MAINTENANCE | 3 |
| ENGINE | FUEL SYSTEM | 4 |
| | ENGINE REMOVAL/INSTALLATION | 5 |
| | CYLINDER HEAD/VALVES | 6 |
| | CYLINDER/PISTON | 7 |
| | CLUTCH/OIL PUMP | 8 |
| | STARTER/ALTERNATOR | 9 |
| | TRANSMISSION/CRANKSHAFT | 10 |
| CHASSIS | FRONT WHEEL/BRAKE/STEERING | 11 |
| | REAR WHEEL/BRAKE/DRIVE MECHANISM | 12 |
| | REAR FENDER/EXHAUST PIPE | 13 |
| ELECTRICAL | IGNITION SYSTEM | 14 |
| | LIGHTS/SWITCHES | 15 |
| | WIRING DIAGRAM | 16 |
| | TROUBLESHOOTING | 17 |



1. GENERAL INFORMATION

| | |
|-------------------------------|------|
| GENERAL SAFETY | 1-1 |
| SERVICE RULES | 1-1 |
| MODEL IDENTIFICATION | 1-2 |
| SPECIFICATIONS | 1-3 |
| TORQUE VALUES | 1-5 |
| TOOLS | 1-7 |
| CABLE & HARNESS ROUTING | 1-8 |
| NOISE EMISSION CONTROL SYSTEM | 1-10 |

GENERAL SAFETY

WARNING

If the engine must be running to do some work, make sure the area is well-ventilated. Never run the engine in a closed area. The exhaust contains poisonous carbon monoxide gas.

WARNING

Gasoline is extremely flammable and is explosive under certain conditions. Do not smoke or allow flames or sparks in your work area.

SERVICE RULES

1. Use genuine Honda or Honda-recommended parts and lubricants or their equivalents. Parts that do not meet Honda's design specifications may damage the ATC.
2. Use the special tools designed for this product.
3. This ATC uses only metric fasteners ; use only metric tools when servicing.
4. Install new gaskets, O-rings, cotter pins, lock plates, etc. when reassembling.
5. When tightening bolts or nuts, begin with larger-diameter or inner bolts first, and tighten to the specified torque diagonally, unless a particular sequence is specified.
6. Clean parts in cleaning solvent upon disassembly. Lubricate any sliding surfaces before reassembly.
7. After reassembly, check all parts for proper installation and operation.

MODEL IDENTIFICATION

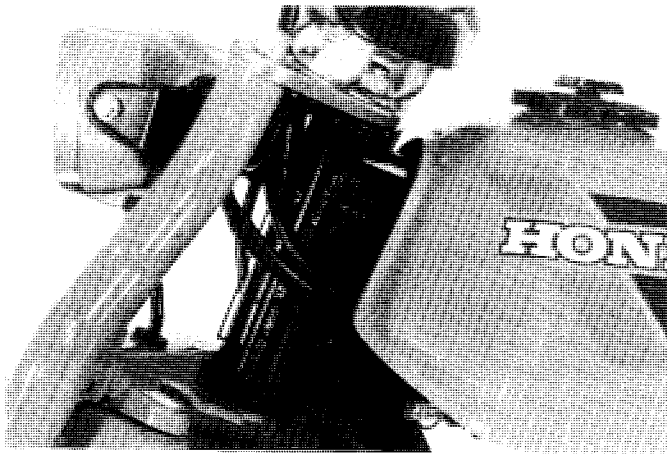

The frame serial number is stamped on the left side of the steering head.

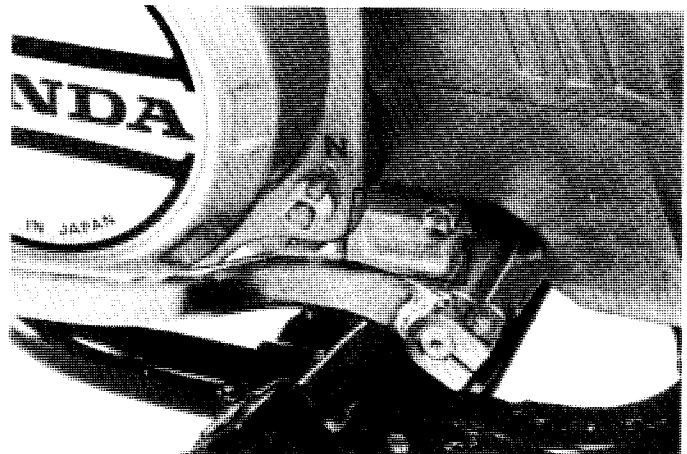

The engine serial number is stamped on the lower left side of crankcase.



The carburetor identification number is on right side of the carburetor body.

SPECIFICATIONS

| ITEM | | | |
|--------------------|-----------------------------|---|--|
| DIMENSIONS | Overall length | 1,735 mm (68.3 in) | |
| | Overall width | 1,015 mm (40.0 in) | |
| | Overall height | 980 mm (38.6 in) | |
| | Wheel base | 1,130 mm (44.5 in) | |
| | Rear tread | 760 mm (29.9 in) | |
| | Seat height | 665 mm (26.2 in) | |
| | Foot peg height | 267 mm (10.5 in) | |
| | Ground clearance | 115 mm (4.9 in) | |
| | Dry weight | 125 kg (276 lb) | |
| FRAME | Type | Semi-double cradle | |
| | Rim size | 8.25×8.0 | |
| | | Front | 8.25×8.0 |
| | | Rear | 8.25×8.0 |
| | Tires | Front: size-pressure | 22 x 11-8 — 2.2 psi (15 kPa, 0.15 kg/cm ²) |
| | | Rear: size-pressure | 22 x 11-8 — 2.2 psi (15 kPa, 0.15 kg/cm ²) |
| | Standard tire circumference | '84~'85 | 1,759 mm (69.3 in) |
| | | After '85 | 1,750 mm (68.9 in) |
| | Front brake | | Cable operated leading shoe |
| | Rear brake | | Cable operated leading shoe |
| | Fuel capacity | '84 : | 8.2 liters (2.17 US gal, 1.80 Imp gal) |
| | | After '84 : | 7.8 liters (2.06 US gal, 1.72 Imp gal) |
| | Fuel reserve capacity | | 1.6 liters (0.42 US gal, 0.35 Imp gal) |
| Caster | | 69° | |
| Trail | | 34.5 mm (1.35 in) | |
| Front oil capacity | | 90±2.5 cc (3.0±0.08 OZ) | |
| ENGINE | Type | Gasoline, air-cooled 4-stroke, OHC | |
| | Cylinder arrangement | Single cylinder inclined 15° | |
| | Bore x stroke | 65×57.8 mm (2.56×2.28 in) | |
| | Compression ratio | 7.8:1 | |
| | Displacement | 192 cc (11.7 cu in) | |
| | Valve train | Chain driven overhead camshaft | |
| | Maximum horsepower | 13.5 BHP/7,000rpm | |
| | Maximum torque | 1.5 kg-m/6,000rpm (11 ft-lb/6,000rpm) | |
| | Oil capacity | After disassembly | 1.35 liters (1.4 US qt, 1.1 Imp qt) |
| | | After draining | 0.95 liters (1.0 US qt, 0.8 Imp qt) |
| | Lubrication system | | Forced pressure and wet sump |
| | Cylinder compression | | 11.0±1.0 kg/cm ² (156±14 psi) |
| | Intake valve | Opens | 5° BTDC |
| | | Closes | 35° ABDC |
| | Exhaust valve | Opens | 35° BBDC |
| | Closes | 5° ATDC | |
| Valve clearance | Intake | 0.05 mm (0.002 in) | |
| (Cold) | Exhaust | 0.05 mm (0.002 in) | |
| CARBURETOR | Type | Piston valve | |
| | Main jet | #100 | |
| | Pilot screw opening | 2-¼ turns out | |
| | Float level | 14.0 mm (0.55 in) | |
| | Idle speed | 1,400 ± 100 rpm | |
| | Venturi diameter | 22 mm (0.9 in) | |

GENERAL INFORMATION

| ITEM | | | |
|-------------------|---|---------------------------------|----------------------------------|
| DRIVE TRAIN | Clutch | Wet multi-plate, semi-automatic | |
| | Transmission | 5-speed constant mesh | |
| | Primary reduction | 3.333 | |
| | Gear ratio | I | 2.769 |
| | | II | 1.722 |
| | | III | 1.273 |
| | | IV | 1.000 |
| V | | 0.815 | |
| Final reduction | 3.909 | | |
| Gearshift pattern | Left foot operated return system, N-1-2-3-4-5 | | |
| Drive chain | 520, 84 L | | |
| ELECTRICAL | Ignition | CDI | |
| | Ignition timing | Initial | 10° ± 2° BTDC at idle |
| | | Full advance | 30° ± 2° BTDC at 3,350rpm |
| | Alternator | Capacity | A.C. generator, 12V 50W/5,000rpm |
| | Spark plug | | X24ESR-U (ND) |
| | | | DR8ES-L (NGK) |
| | Spark plug gap | | 0.6 – 0.7 mm (0.024 – 0.028 in) |
| Headlight | | 12V 45W/45W | |
| Tailight | | 12V 5W | |

TORQUE VALUES**ENGINE**

| Item | Q'ty | Thread Size (mm) | Torque | | |
|---------------------------------|------|---------------------|---------|-----------|---------|
| | | | N·m | kg·m | ft·lb |
| Cylinder head cover cap nut | 4 | 8 | 28–30 | 2.8–3.0 | 20–22 |
| socket bolt | 4 | 6 | 8–12 | 0.8–1.2 | 6–9 |
| Clutch lock nut | 1 | 16 x 1.0 | 50–60 | 5.0–6.0 | 36–43 |
| Centrifugal clutch lock nut | 1 | 22 x 1.25 | 105–115 | 10.5–11.5 | 76–83 |
| Clutch adjuster lock nut | 1 | 8 x 1.25 | 19–25 | 1.9–2.5 | 14–18 |
| A.C. generator rotor nut | 1 | 12 x 1.25 | 65–75 | 6.5–7.5 | 47–54 |
| Valve adjuster cover | 2 | 36 x 1.5 | 10–14 | 1.0–1.4 | 7–10 |
| Oil filter cap | 1 | 36 x 1.5 | 9–15 | 0.9–1.5 | 6.5–11 |
| Spark plug | 1 | 12 x 1.25 | 12–19 | 1.2–1.9 | 9–14 |
| Cam sprocket bolt | 2 | 6 x 1.0 | 8–12 | 0.8–1.2 | 6–9 |
| Oil filter rotor cover bolt | 3 | 6 x 1.0 | 10–14 | 1.0–1.4 | 7–10 |
| Clutch lifter stopper bolt | 1 | 8 x 1.25 | 18–25 | 1.8–2.5 | 13–18 |
| Gearshift drum stopper arm bolt | 1 | 6 x 1.0 | 10–14 | 1.0–1.4 | 7–10 |
| Pulse generator screw | 2 | 5 x 0.5 | 4–7 | 0.4–0.7 | 2.9–5.0 |
| Pulse cover screw | 2 | 5 x 0.8 | 4–7 | 0.4–0.7 | 2.9–5.0 |
| Valve adjuster lock nut | 2 | 6 x 0.75 | 15–18 | 1.5–1.8 | 11–13 |
| Gearshift stopper plate bolt | 1 | 6 x 1.0 | 8–12 | 0.8–1.2 | 6–9 |
| Clutch bolt | 4 | 6 x 1.0 | 10–14 | 1.0–1.4 | 7–10 |
| Recoil starter driven pulley | 4 | 6 x 1.0 | 10–14 | 1.0–1.4 | 7–10 |
| Cam chain tensioner adjust bolt | 1 | 16 x 1.0 | 15–22 | 1.5–2.2 | 11–16 |
| Cam chain tensioner check bolt | 1 | 6 x 1.0 | 8–10 | 0.8–1.0 | 6–7 |
| Decompressor lever pivot bolt | 1 | 6 x 1.0 | 5–7 | 0.5–0.7 | 3.6–5.1 |
| Drive sprocket bolt | 3 | 6 x 1.0 | 8–12 | 0.8–1.2 | 6–9 |
| Right crankcase protector screw | 3 | Self tapping screw | 3–17 | 0.3–0.7 | 2.2–5.1 |

FRAME

| Item | Q'ty | Thread Size (mm) | Torque | | |
|-------------------------------|------|---------------------|---------|-----------|--------|
| | | | N·m | kg·m | ft·lb |
| Handlebar upper holder bolt | 4 | 8 x 1.25 | 18–30 | 1.8–3.0 | 13–22 |
| Handlebar lower holder nut | 2 | 10 x 1.25 | 40–48 | 4.0–4.8 | 29–35 |
| Fork top bridge bolt | 2 | 12 x 1.25 | 50–70 | 5.0–7.0 | 36–51 |
| Steering stem nut | 1 | 22 x 1.0 | 50–70 | 5.0–7.0 | 36–51 |
| Front axle | 1 | 14 x 1.5 | 70–110 | 7.0–11.0 | 51–80 |
| Front hub nut | 4 | 8 x 1.25 | 20–25 | 2.0–2.5 | 14–18 |
| Front brake drum bolt | 4 | 8 x 1.25 | 20–25 | 2.0–2.5 | 14–18 |
| Front axle holder nuts | 4 | 6 x 1.0 | 10–14 | 1.0–1.4 | 7–10 |
| Front/rear rim nut | 12 | 8 x 1.25 | 20–25 | 2.0–2.5 | 14–18 |
| Damper holder nut | 5 | 8 x 1.25 | 25–30 | 2.5–3.0 | 18–22 |
| Rear brake drum nut (Inner) | 1 | 32 x 1.0 | 35–45 | 3.5–4.5 | 25–33 |
| (Outer) | 1 | 32 x 1.0 | 120–140 | 12.0–14.0 | 87–101 |
| Rear hub nut (Rear wheel nut) | 8 | 8 x 1.25 | 20–25 | 2.0–2.5 | 14–18 |
| Rear axle nut | 2 | 14 x 1.5 | 60–80 | 6.0–8.0 | 44–58 |
| Bearing holder bolt | 4 | 12 x 1.25 | 50–70 | 5.0–7.0 | 36–51 |
| Front fork mounting bolt | 4 | 1 x 1.25 | 40–50 | 4.0–5.0 | 29–36 |

GENERAL INFORMATION

| Item | Q'ty | Thread Size (mm) | Torque | | |
|-------------------------|------|---------------------|--------|---------|---------|
| | | | N·m | kg-m | ft-lb |
| Front engine hanger nut | 2 | 10 x 1.25 | 40-48 | 4.0-4.8 | 29-35 |
| Front engine hanger nut | 2 | 8 x 1.25 | 23-27 | 2.3-2.7 | 17-20 |
| Rear engine hanger nut | 2 | 10 x 1.25 | 60-80 | 6.0-8.0 | 44-57 |
| Upper engine hanger nut | 1 | 8 x 1.25 | 20-25 | 2.0-2.5 | 14-18 |
| Carburetor nut | 2 | 6 x 1.0 | 6-9 | 0.6-0.9 | 4.3-6.5 |
| Gearshift pedal | 1 | 6 x 1.0 | 8-12 | 0.8-1.2 | 6-9 |
| Foot peg bolt | 8 | 8 x 1.25 | 20-25 | 2.0-2.5 | 14-18 |
| Mud guard bolt | 11 | 5 x 0.8 | 4-8 | 0.4-0.8 | 2.9-5.8 |
| Drive chain slider nut | 2 | 6 x 1.0 | 6-9 | 0.6-0.9 | 4.3-6.5 |

Torque specifications listed above are for the most important tightening points. If a torque specification is not listed, follow the standards given below.

STANDARD TORQUE VALUES

| Item | Torque Values N·m (kg-m, ft-lb) | Item | Torque Values N·m (kg-m, ft-lb) |
|--------------------|------------------------------------|---------------------------|------------------------------------|
| 5 mm bolt and nut | 4-6 (0.4-0.6, 3-4) | 5 mm screw | 3-5 (0.3-0.5, 2-4) |
| 6 mm bolt and nut | 8-12 (0.8-1.2, 6-9) | 6 mm screw | 7-11 (0.7-1.1, 5-8) |
| 8 mm bolt and nut | 18-25 (1.8-2.5, 13-18) | 6 mm flange bolt and nut | 10-14 (1.0-1.4, 7-10) |
| 10 mm bolt and nut | 30-40 (3.0-4.0, 22-29) | 8 mm flange bolt and nut | 20-30 (2.0-3.0, 14-22) |
| 12 mm bolt and nut | 50-60 (5.0-6.0, 36-43) | 10 mm flange bolt and nut | 30-40 (3.0-4.0, 22-29) |

TOOLS**SPECIAL**

| Description | Tool No. | Alternative | Ref. page |
|-----------------------------|---------------|---|-------------------------|
| Valve guide reamer, 5.47 mm | 07984—0980000 | | 6-11 |
| Flywheel holder | 07925—9580000 | Not available in U.S.A. | 8-5, 8-11, 9-9, 9-12 |
| Clutch center holder | 07923—9580000 | Not available in U.S.A. | 8-11, 8-14 |
| Lock nut wrench, 30 mm | 07907—PD10000 | Equivalent commercial available in U.S.A. | 8-6, 8-10 |
| Ball race remover | 07944—1150001 | M9360—277—91774 (U.S.A.) | 11-28 |
| Universal bead breaker | GN—AH—958—BB1 | Available in U.S.A. only | 11-12 |
| Lock nut spanner, 41 mm | 07916—9580200 | Not available in U.S.A. | 12-5, 12-8 |
| Lock nut wrench, 41 mm | 07916—9580300 | 07916—9580400 | 12-5, 12-8 |
| Hollow set wrench, 6 mm | 07917—3230000 | Equivalent commercially available in U.S.A. | 11-21 |
| Digital Multi-tester | KS—AHM—32—003 | U.S.A. only | 14-3 |

COMMON

| Description | Tool No. | Alternative | Ref. page |
|----------------------------------|---------------|---|--------------|
| Float level gauge | 07401—0010000 | | 4-11 |
| Pin spanner | 07702—0020000 | 07902—0010000, 07702—0010000 or M9361—412—099788 (Available in U.S.A.) | 11-27, 11-29 |
| Valve adjusting wrench, 10×12 mm | 07708—0030200 | 07908—MB00100 | 3-6 |
| Valve adjuster A | 07708—0030300 | | 3-6 |
| Lock nut wrench, 20×24 mm | 07716—0020100 | 07916—3710000 | 8-11, 8-14 |
| Lock nut wrench, 30×32 mm | 07716—0020400 | Commercially available in U.S.A. | 11-27, 11-30 |
| Extension bar | 07716—0020500 | Commercially available in U.S.A. | 8-6, |
| Flywheel puller | 07733—0010000 | 07933—2000000 | 9-9 |
| Valve guide remover 5.5 mm | 07742—0010100 | 07942—3290100 | 6-11 |
| Valve guide driver B | 07742—0020200 | 07942—3290200 | 6-11 |
| Attachment, 37×40 mm | 07746—0010200 | | 11-29 |
| Driver | 07749—0010000 | 07949—6110000 | 11-16, 11-29 |
| Pilot, 15 mm | 07746—0040300 | | 11-16 |
| Attachment, 42×47 mm | 07746—0010300 | | 11-16 |
| Pilot, 35 mm | 07746—0040800 | | 12-16 |
| Attachment, 62×68 mm | 07746—0010500 | | 12-10, 12-16 |
| Valve spring compressor | 07757—0010000 | 07957—3290001 | 6-9, 6-15 |
| Fork seal driver | 07747—0010100 | 07947—3550000 | 11-25 |
| Fork seal driver attachment C | 07747—0010400 | | 11-25 |

CABLE & HARNESS ROUTING

Note the following when routing cables and wire harnesses:

- A loose wire, harness or cable can be a safety hazard. After clamping, check each wire to be sure it is secure.
- Do not squeeze wires against the weld or end of its clamp when a weld-on clamp is used.
- Secure wires and wire harnesses to the frame with their respective wire bands at the designated locations. Tighten the bands so that only the insulated surfaces contact the wires or wire harnesses.
- Route harnesses so they are not pulled taut or have excessive slack.
- Protect wires and harnesses with electrical tape or tubes if they are contact a sharp edge or corner. Clean the attaching surface thoroughly before applying tape.
- Do not use a wire or harness with a broken insulator. Repair by wrapping them with protective tape or replace them.
- Route wire harnesses to avoid sharp edges or corners.
- Also avoid the projected ends of bolts and screws.
- Keep wire harnesses away from the exhaust pipes and other parts that get hot.
- Be sure grommets are seated in their grooves properly.
- After clamping, check each harness to be certain that it is not interfering with any moving or sliding parts.
- Wire harnesses routed along the handlebars should not be pulled taut, have excessive slack, be pinched, or interfere with adjacent or surrounding parts in all steering positions.
- After routing, check that the wire harnesses are not twisted or kinked.

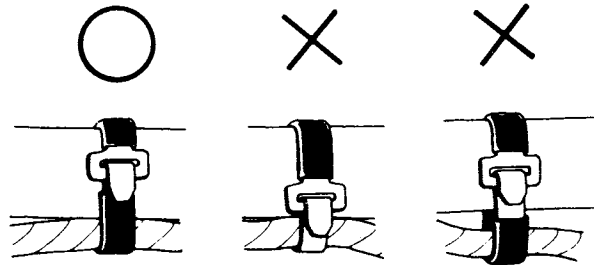
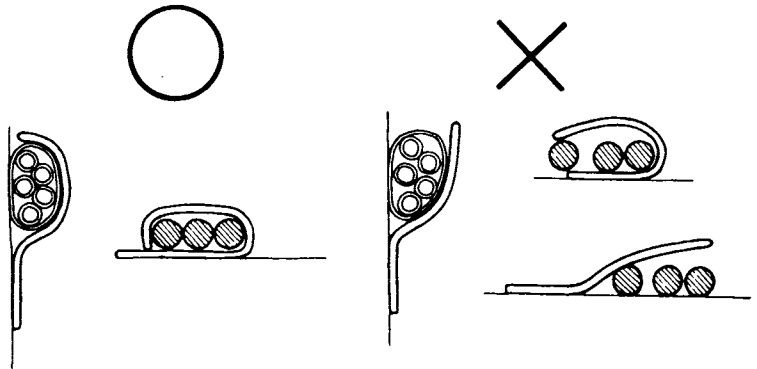

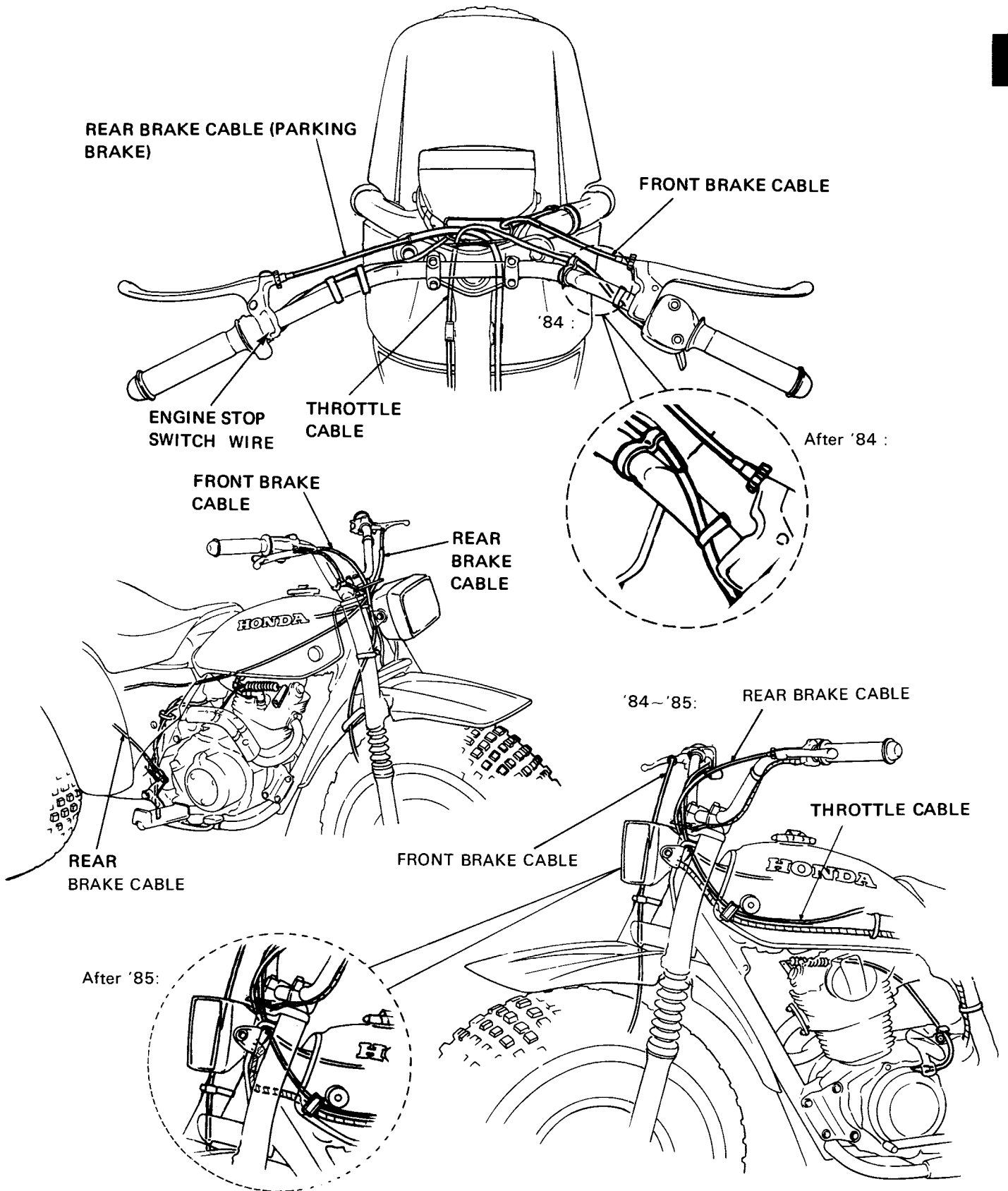

NOISE EMISSION CONTROL SYSTEM

- The U.S. Environmental Protection Agency requires manufacturers to certify that vehicles built after January 1, 1983 will comply with applicable noise emission standards for one year or 1,865 miles (3,000 km) after the time of sale to the ultimate purchaser, when operated and maintained according to the instructions provided. Compliance with the terms of the Distributor's Warranty for the Honda Vehicle Noise Emission Control System is necessary in order to keep the noise emission control system in effect.

TAMPERING WITH THE NOISE CONTROL SYSTEM IS PROHIBITED: Federal law prohibits the following acts or the causing thereof: (1) The removal or rendering inoperative by any person, other than for purposes of maintenance, repair, or replacement, of any device or element of design incorporated into any new vehicle for the purpose of noise control prior to its sale or delivery to the ultimate purchaser or while it is AMOG THOSE ACTS PRESUMED TO CONSTITUTE TAMPERING ARE THE ACTS LISTED BELOW:

1. Removal of, or puncturing the muffler, bafflers, header pipes or any other component which conducts exhaust gases.
2. Removal of, or puncturing of any part of the intake system.
3. Lack of proper maintenance.
4. Replacing any moving parts of the vehicle, or parts of the exhaust or intake system, with parts other than those specified by the manufacturer.



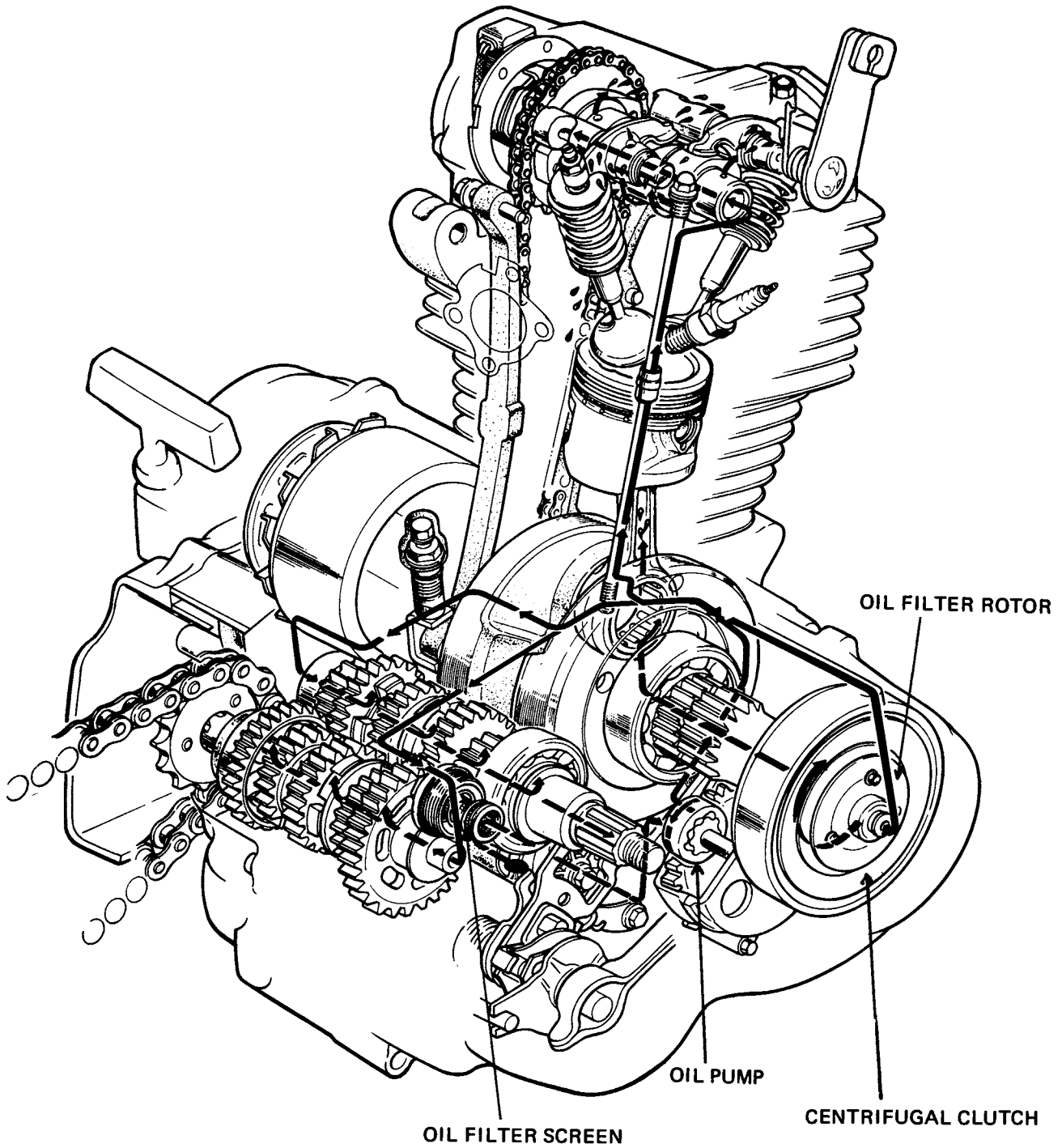

2. LUBRICATION

| | |
|--|-----|
| SERVICE INFORMATION | 2-1 |
| TROUBLESHOOTING | 2-1 |
| ENGINE OIL LEVEL CHECK | 2-2 |
| ENGINE OIL CHANGE AND OIL FILTER SCREEN CLEANING | 2-2 |
| OIL FILTER ROTOR CLEANING | 2-3 |
| LUBRICATION POINTS | 2-4 |

SERVICE INFORMATION

GENERAL

- This section describes how to inspect and replace the engine oil and clean the oil filter screen.
- Section 8 shows how to service the oil pump.

SPECIFICATIONS

Oil capacity 1.35 ℓ (1.4 US qt, 1.1 Imp qt) after disassembly
0.95 ℓ (1.0 US qt, 0.8 Imp qt) after draining

Engine oil recommendation

Use Honda 4-Stroke Oil or equivalent.
API Service Classification : SE or SF
Viscosity :
SAE 10W-40

Other viscosities shown in the chart may be used when the average temperature in your riding area is within the indicated range.

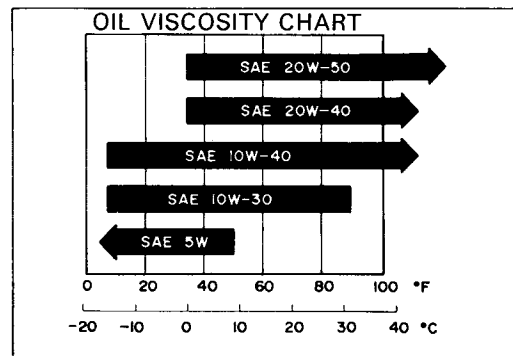

TORQUE VALUES

Oil filter screen cap 9-15 N·m (0.9-1.5 Kg·m, 6.5-10.8 ft·lb)
Oil filter rotor cover bolt 10-14 N·m (1.0-1.4 Kg·m, 7.2-10.1 ft·lb)

TROUBLESHOOTING

Oil level too low

1. Normal oil consumption
2. External oil leaks
3. Worn piston rings

Oil consumption

1. Oil not changed often enough
2. Faulty head gasket

ENGINE OIL LEVEL CHECK

Place the ATC on level ground.

Check the oil level with the oil cap/dipstick. Do not screw in the cap when making this check.

If the oil level is below the lower level mark on the dipstick, fill to the upper level mark with the recommended oil (Page 2-1).

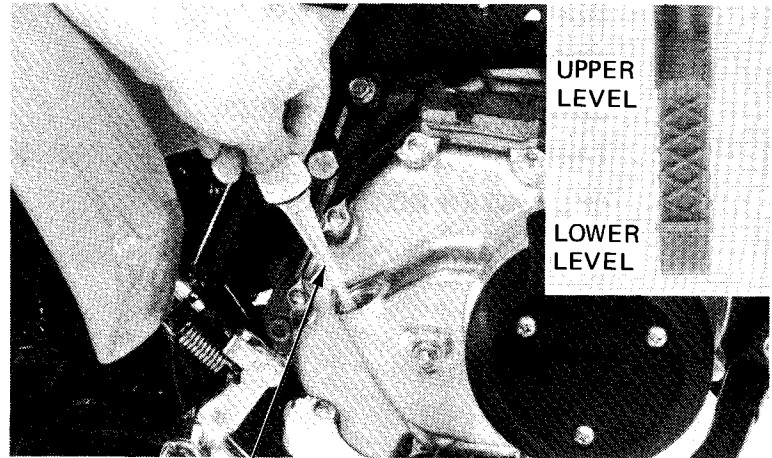

OIL CAP/DIPSTICK

ENGINE OIL CHANGE AND OIL FILTER SCREEN CLEANING

NOTE :

- Drain the oil with the engine warm.
- The oil filter screen and spring will come out when the oil filter screen cap is removed.

Remove the oil filter screen cap.

Operate the recoil starter several times to completely drain any residual oil.

Clean the oil filter screen.

Make sure that the oil filter screen, sealing rubber, screen cap and O-ring are in good condition.

Install the oil filter screen, spring and screen cap.

**TORQUE: 9–15 N-m (0.9–1.5 kg-m,
6.5–10.8 ft-lb)**

Fill the crankcase with the recommended grade oil (Page 2-1).

ENGINE OIL CAPACITY:

**0.95 liters (1.0 US qt, 0.8 Imp qt)
after draining**

Install the oil filter cap.

Start the engine and let it idle for 2–3 minutes.

Stop the engine.

With the ATC on level ground, make sure that the oil level is at the upper level mark.

Be sure there are no oil leaks.

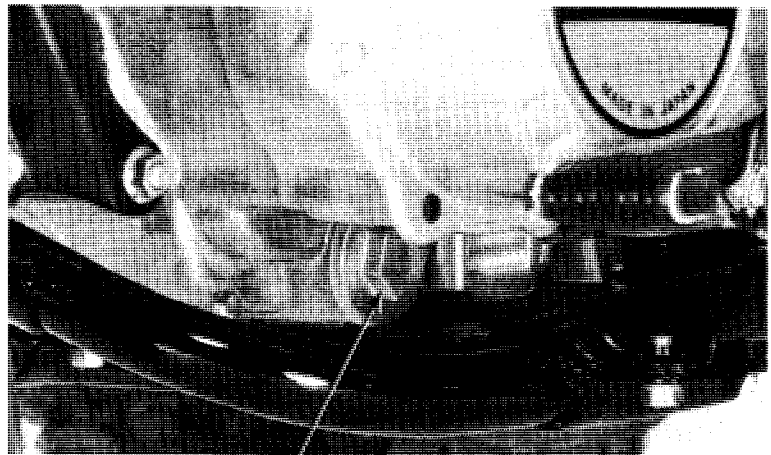

OIL FILTER SCREEN CAP

OIL FILTER SCREEN

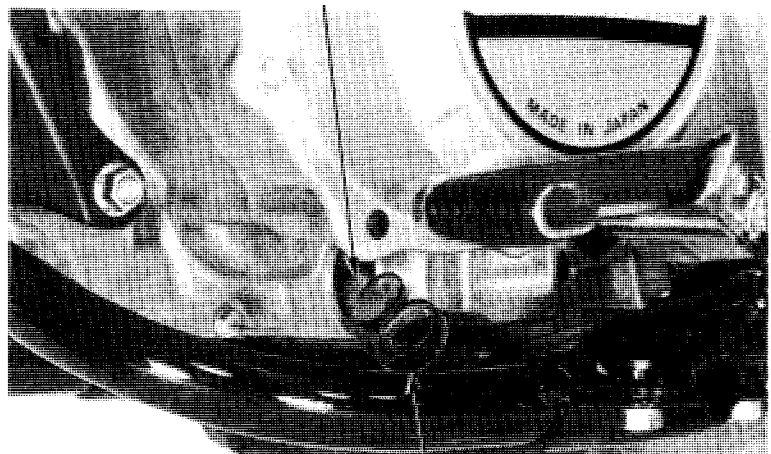

SPRING

OIL FILTER ROTOR CLEANING

NOTE

Clean the oil filter rotor before adding oil.

Remove the right crankcase cover (Page 8-3).

RIGHT CRANKCASE COVER

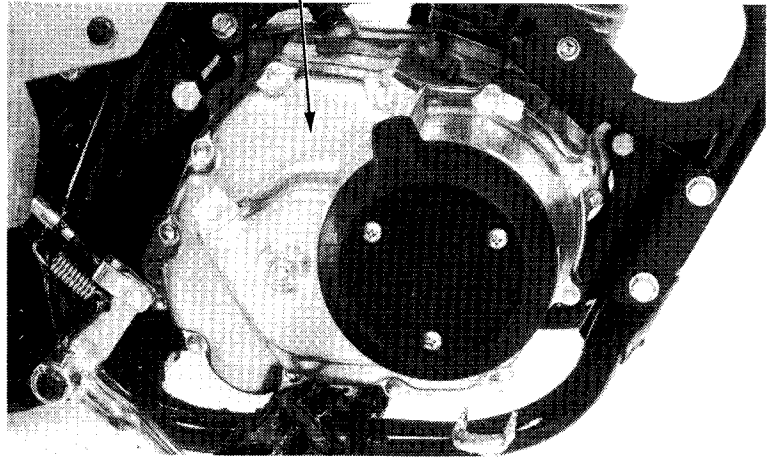

Remove the dowel pins and gasket.
Remove the oil filter rotor cover.

DOWEL PINS

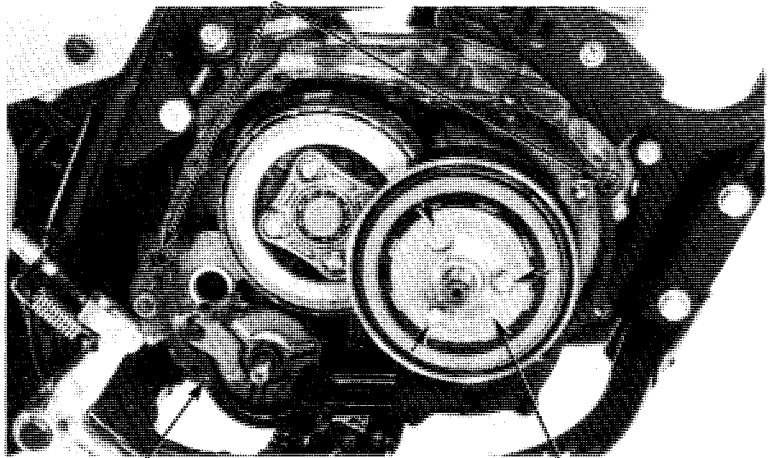

GASKET

OIL FILTER
ROTOR COVER

Remove the cover gasket.
Clean the inside of the rotor cover and rotor.
Install the oil filter rotor cover with a new gasket.

TORQUE: 10–14 N·m (1.0–1.4 kg·m,
7–10 ft·lb)

Install the dowel pins and gasket.

Install the right crankcase cover (Page 8-21).
Fill the engine with the recommended grade of oil (Page 2-1 and 2-2).

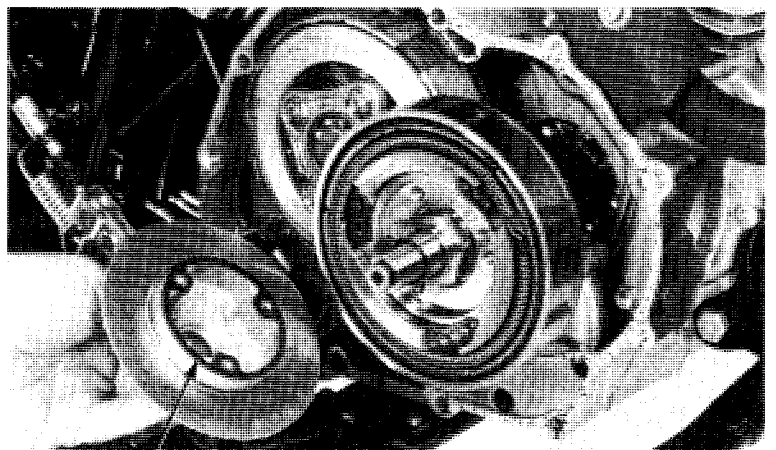

GASKET

LUBRICATION

LUBRICATION POINTS

Use general purpose grease when no other specification is given. Apply oil or grease to any 2 sliding surfaces and cables not shown here.

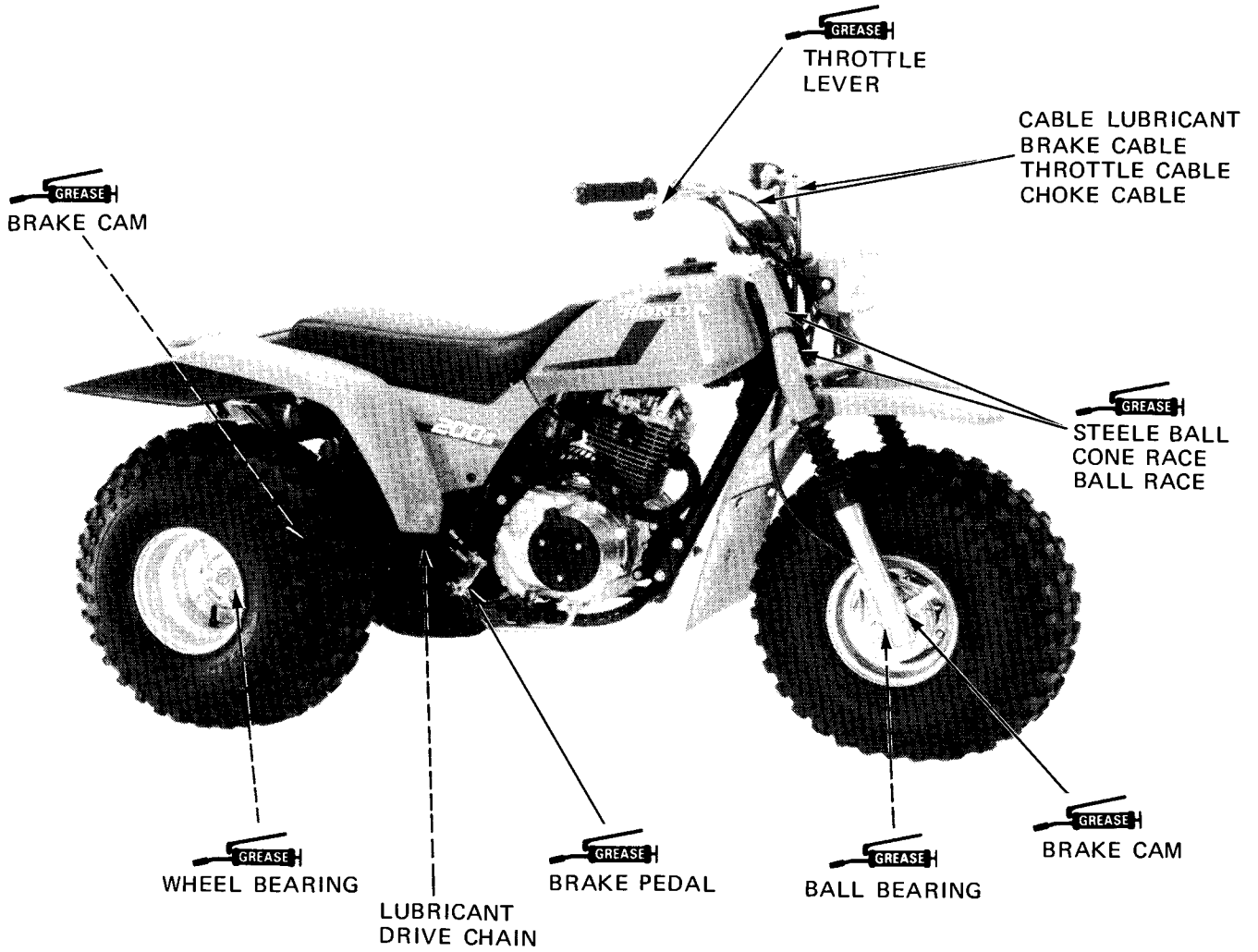

3. MAINTENANCE

| | | | |
|-----------------------|-----|-------------------------|------|
| SERVICE INFORMATION | 3-1 | <CHASSIS> | |
| MAINTENANCE SCHEDULE | 3-3 | DRIVE CHAIN | 3-10 |
| <ENGINE> | | BRAKE SHOES | 3-14 |
| AIR CLEANER | 3-4 | FRONT BRAKE | 3-14 |
| SPARK PLUG | 3-5 | REAR BRAKE | 3-15 |
| VALVE CLEARANCE | 3-6 | CLUTCH | 3-16 |
| FUEL STRAINER | 3-7 | SPARK ARRESTER CLEANING | 3-17 |
| THROTTLE OPERATION | 3-7 | NUTS, BOLTS, FASTENERS | 3-17 |
| CAM CHAIN TENSION | 3-8 | LIGHTING EQUIPMENT | 3-18 |
| CARBURETOR IDLE SPEED | 3-8 | TIRES | 3-18 |
| FUEL LINE | 3-8 | STEERING HEAD BEARINGS | 3-18 |
| IGNITION TIMING | 3-9 | | |
| CYLINDER COMPRESSION | 3-9 | | |

SERVICE INFORMATION

<ENGINE>

Ignition timing:

Initial 10° ±2° BTDC at idle
Full advance 30° ±2° BTDC at 3,350 rpm

Spark plug:

Spark plug gap 0.6–0.7 mm (0.024–0.028 in)

Recommended spark plugs:

DR8ES-L (NGK)
X24ESR-U (ND)

Valve clearance (cold)

Intake 0.05 mm (0.002 in)
Exhaust 0.05 mm (0.002 in)

Throttle lever free play

5–10 mm (3/16–3/8 in)

Idle speed

1,400 ± 100 rpm

Cylinder compression

11.0 ± 1.0 kg/cm² (156 ± 14 psi)

MAINTENANCE

<CHASSIS>

| | |
|---|--|
| Front brake lever free play | 15–20 mm (5/8–3/4 in) |
| Rear brake pedal free play | 15–20 mm (5/8–3/4 in) |
| Rear brake lever (parking brake) free play | 15–20 mm (5/8–3/4 in) |
| Drive chain free play | 10–20 mm (3/8–3/4 in) |
| Drive chain length (45 pins): | |
| Standard | 698.5 mm (27.50 in) |
| Service limit | 705.5 mm (27.78 in) |
| Front/rear rim size | 8.25 x 8.0 |
| Front/rear tire size | 22 x 11–8 |
| Front/rear tire pressure | 2.2 psi (15 kPa, 0.15 kg-cm ²) |
| Front/rear tire circumference | |
| Standard | 1,759 mm (69.3 in) |

TORQUE VALUES

| | |
|------------------------------------|---------------------------------------|
| Spark plug | 12–19 N•m (1.2–1.9 kg-m, 9–14 ft-lb) |
| Valve adjuster cover | 10–14 N•m (1.0–1.4 kg-m, 7–10 ft-lb) |
| Cam chain tensioner adjusting bolt | 15–22 N•m (1.5–2.2 kg-m, 11–16 ft-lb) |
| Rear axle bearing holder bolt | 50–70 N•m (5.0–7.0 kg-m, 36–51 ft-lb) |
| Clutch adjusting screw lock nut | 19–25 N•m (1.9–2.5 kg-m, 14–18 ft-lb) |
| Valve adjusting screw lock nut | 15–18 N•m (1.5–1.8 kg-m, 11–13 ft-lb) |

MAINTENANCE SCHEDULE

Perform the PRE-RIDE INSPECTION at each scheduled maintenance period.

I : Inspect and Clean, Adjust, Lubricate, or Replace if necessary.

C: Clean

R: Replace

A: Adjust

L: Lubricate

| | ITEM | EVERY | INITIAL SERVICE PERIOD (First week of operation) | REGULAR SERVICE PERIOD (Every 30 operating days) |
|----|---------------------------|---------------------|---|---|
| | ENGINE OIL | | R | R |
| * | ENGINE OIL FILTER SCREEN | | | C |
| * | ENGINE OIL FILTER ROTOR | | | C |
| | AIR CLEANER | NOTE (1) | | C |
| | SPARK PLUG | | | I |
| * | VALVE CLEARANCE | | I | I |
| * | CAM CHAIN TENSION | | A | A |
| * | CARBURETOR IDLE SPEED | | I | I |
| | FUEL LINE | YEAR: I | | |
| * | FUEL FILTER | YEAR: C | | |
| | THROTTLE OPERATION | | I | I |
| | DRIVE CHAIN | NOTE (1) | I,L | I,L |
| * | BRAKE SHOE WEAR | NOTE (2) YEAR: I | | |
| | BRAKE SYSTEM | | I | I |
| * | CLUTCH SYSTEM | | I | I |
| * | SPARK ARRESTER (USA ONLY) | | | C |
| * | NUT, BOLT, FASTENER | | I | I |
| | SUSPENSION | | | I |
| ** | WHEEL | | I | I |
| ** | STEERING HEAD BEARING | YEAR: I | | |

* SHOULD BE SERVICED BY AUTHORIZED HONDA DEALER, UNLESS THE OWNER HAS PROPER TOOLS AND SERVICE DATA AND IS MECHANICALLY QUALIFIED. REFER TO THE OFFICIAL HONDA SHOP MANUAL.

** IN THE INTEREST OF SAFETY, WE RECOMMEND THESE ITEMS BE SERVICED ONLY BY AN AUTHORIZED HONDA DEALER.

NOTES: (1) Service more frequently when riding in dusty areas.

(2) Service more frequently after riding in very wet or muddy conditions.

MAINTENANCE

AIR CLEANER

Remove the seat by pulling the seat lever.

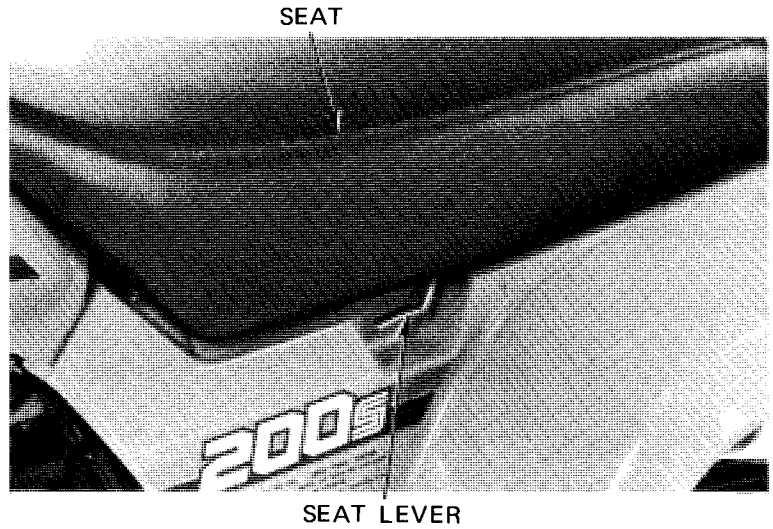

Remove the three wing bolts attaching the air cleaner case cover.
Remove the air cleaner case cover.
Remove the air cleaner element assembly from the air cleaner case.

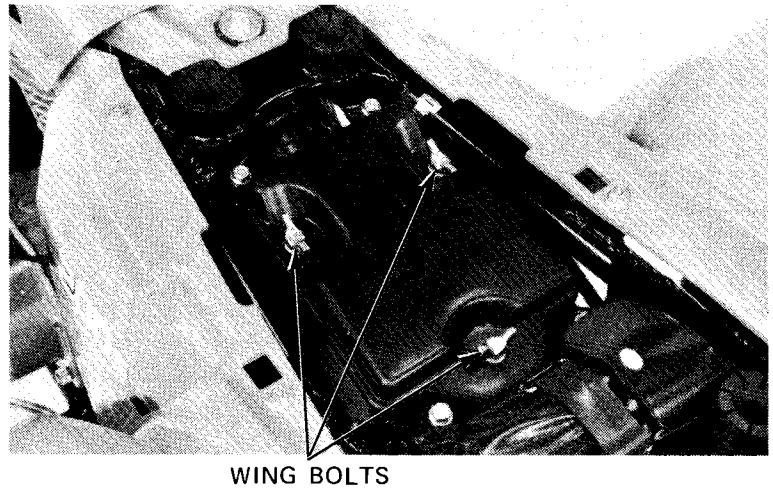

Remove the bracket from the element holder.
Remove the air cleaner element from the element holder.

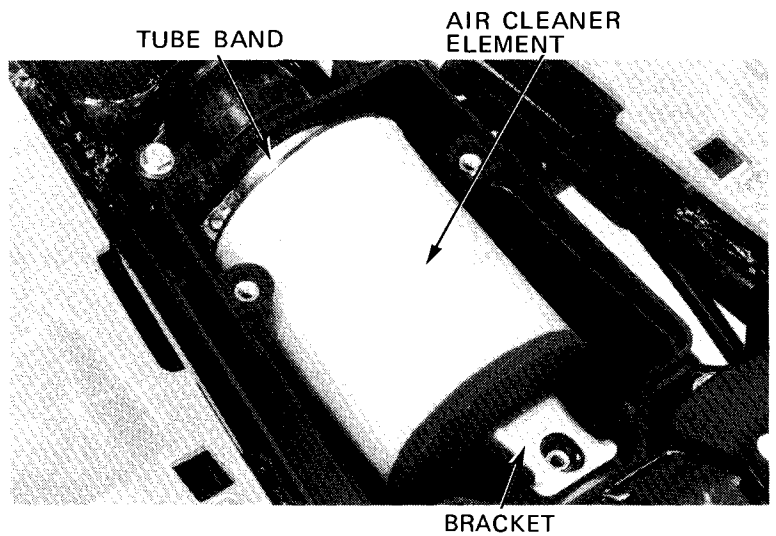

Wash the element in non-flammable or high flash point solvent, squeeze out the solvent thoroughly, and allow to dry.
 Soak the element in gear oil (SAE 80–90) and squeeze out excess.
 Place the element onto the element holder.
 Install the element assembly into the air cleaner case.
 Install the bracket onto the element holder.
 Install the element assembly into the air cleaner wing bolts.
 Install the seat.

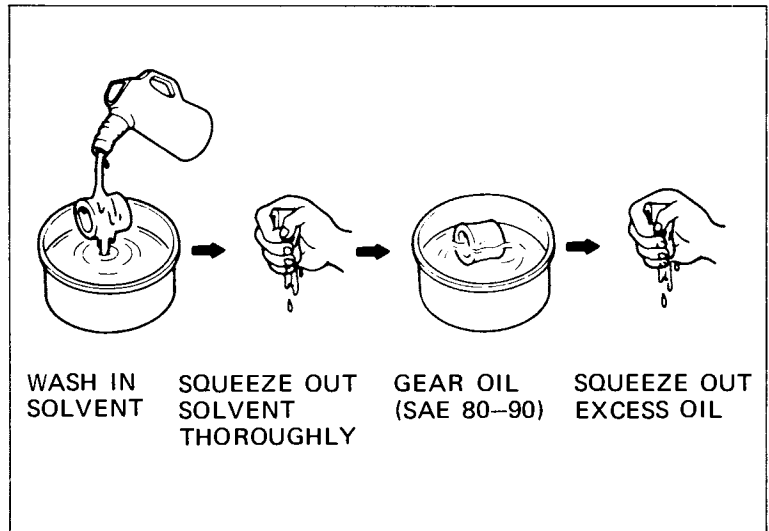

SPARK PLUG

Disconnect the spark plug cap and remove the spark plug.
 Visually inspect the spark plug electrodes for wear. The center electrode should have square edges and the side electrode should have a constant thickness. Discard the spark plug if there is apparent wear or if the insulator is cracked or chipped. Measure the gap with a wire-type feeler gauge and adjust by carefully bending the side electrode.

SPARK PLUG CAP:
 0.6–0.7 mm (0.024–0.028 in)

RECOMMENDED REPLACEMENT PLUG:
 (NGK) DR8ES-L
 (ND) X24ESR-U

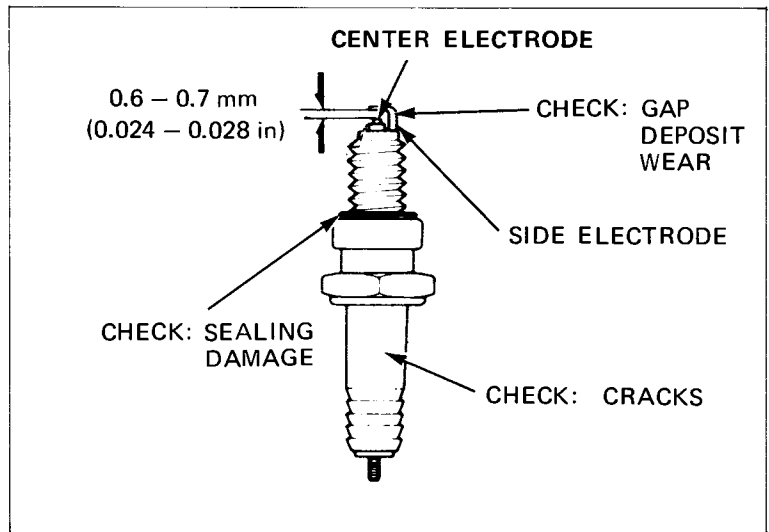

Check the sealing washer and replace with a new one if damaged.

With the sealing washer attached, thread the spark plug in by hand to prevent cross-threading.

Tighten the spark plug to the specified torque.

TORQUE: 12–19 N·m (1.2–1.9 Kg-m, 9–14 ft-lb)

Connect the spark plug cap.

MAINTENANCE

VALVE CLEARANCE

NOTE

- Inspect and adjust valve clearance while the engine is cold (below 35°C/95°F).
- Make sure the decompressor valve lifter has free play.

Disconnect the fuel tube.
Remove the seat and fuel tank.
Remove the timing mark hole cap and the valve adjuster covers.

Rotate the crankshaft by using the recoil starter and align the "T" mark on the rotor with the index mark. The piston must be at TDC of the compression stroke.

Inspect the intake and exhaust valve clearances by inserting the feeler gauge between the adjusting screw and valve stem.

VALVE CLEARANCES:

Intake: 0.05 mm (0.002 in)

Exhaust: 0.05 mm (0.002 in)

Adjust by loosening the lock nut and turning the adjusting screw until there is a slight drag on the feeler gauge.

Hold the adjusting screw and tighten the lock nut.

TORQUE: 15–18 N·m (1.5–1.8 Kg·m, 11–13 ft·lb)

Recheck the valve clearance.
Install the valve adjuster covers.

TORQUE: 10–14 N·m (1.0–1.4 kg·m, 7–10 ft·lb)

Install the timing hole cap.
Install the fuel tank and the seat.
Reconnect the fuel tube.

INDEX MARK

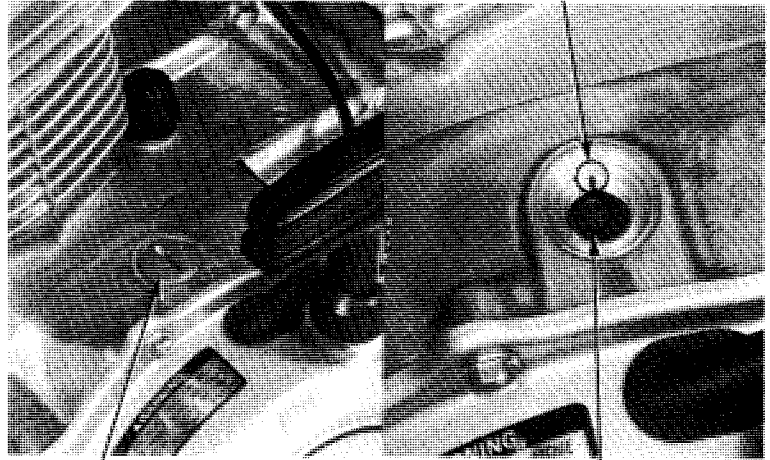

TIMING MARK HOLE CAP

"T" MARK

ADJUSTING SCREW

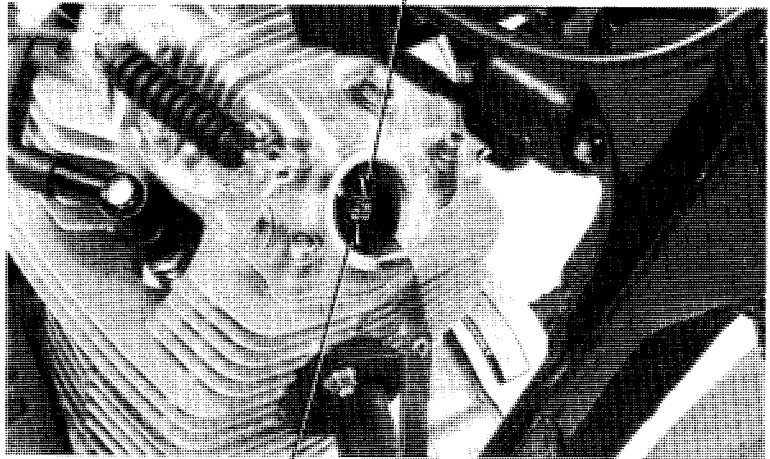

LOCK NUT

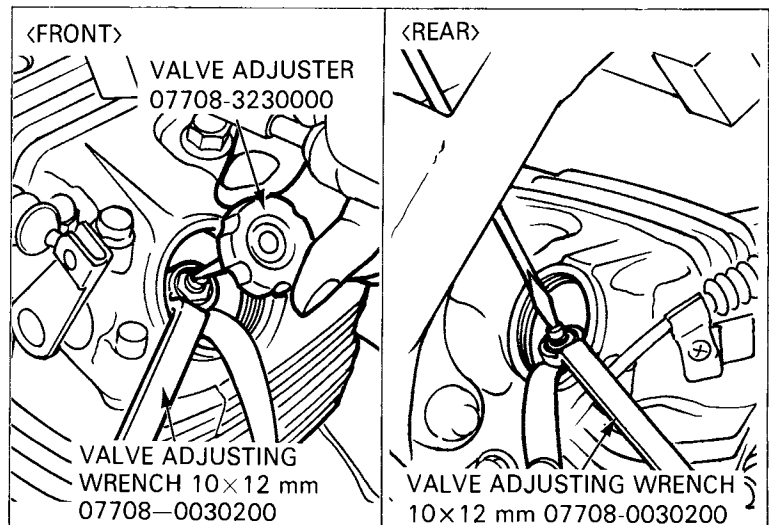

FUEL STRAINER

Disconnect the fuel tube and drain fuel from the fuel tank.

WARNING

Keep gasoline away from flames or sparks. Wipe up spilled gasoline at once.

Remove the fuel valve by loosening the valve nut.

Remove the fuel strainer and wash it in clean nonflammable or high flash point solvent.

Install the strainer and valve and attach the fuel line.

Fill the fuel tank and turn the fuel valve "ON" and check for leaks.

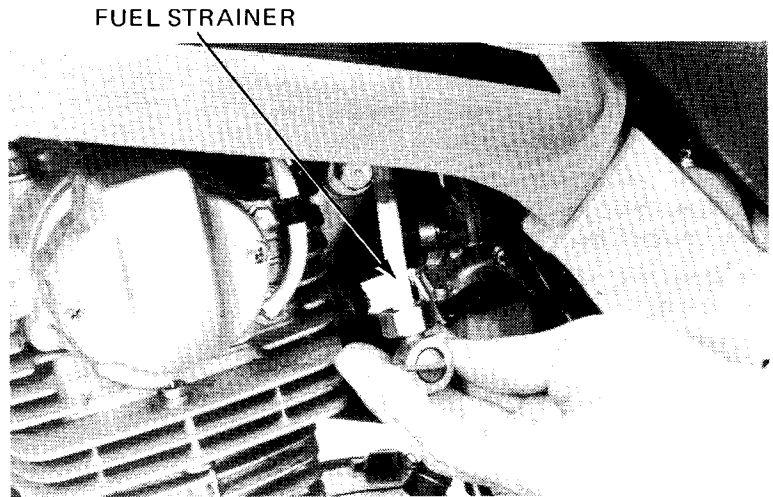

THROTTLE OPERATION

Check for smooth throttle lever full opening and automatic full closing in all steering positions.

Make sure there is no deterioration, damage or kinking in the throttle cable. Replace any damaged parts.

Disconnect the throttle cable at the upper end.

Thoroughly lubricate the cable and pivot point with a commercially available cable lubricant to prevent premature wear.

Install the throttle cable.

Make sure the throttle lever free play is 5–10 mm (3/16–1/8 in) at the tip of the throttle lever.

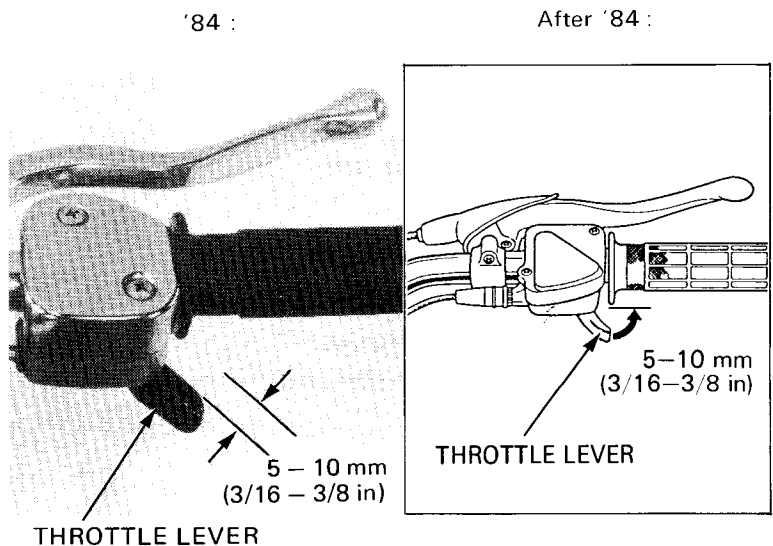

Adjust as follows:

'84 :

Remove the fuel tank.

Slide the rubber cap off the adjuster on the carburetor cap.

Adjust the throttle lever free play by turning the adjuster on the carburetor.

Install the adjuster rubber cap securely. Install the fuel tank.

After '84:

A cable adjuster is located near the throttle lever. Loosen the lock nut and turn the adjuster to obtain the correct free play. Tighten the lock nut.

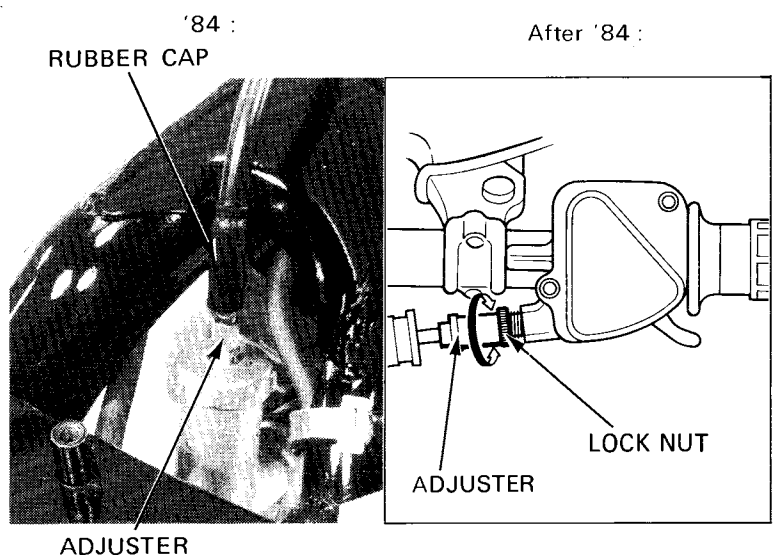

MAINTENANCE

CAM CHAIN TENSION

Start the engine and allow it to idle.
Remove the rubber cap and loosen the cam chain tensioner adjusting bolt.

When the cam chain tensioner adjusting bolt is loosened, the tensioner will automatically position itself to provide the correct tension.

Retighten the adjusting bolt and install the rubber cap.

**TORQUE: 15–22 N·m (1.5–2.2 kg·m,
11–16 ft·lb)**

NOTE :

Do not attempt to loosen the check bolt while adjusting.

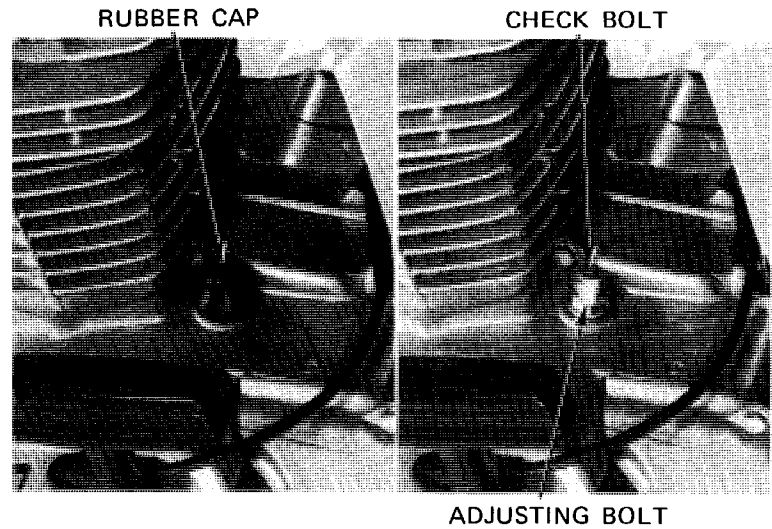

CARBURETOR IDLE SPEED

NOTE :

- Inspect and adjust the idle speed after all other maintenance items are within specifications
- The engine must be warm for accurate idle speed inspection and adjustment.

Warm up the engine for about ten minutes.

Turn the throttle stop screw as required to obtain the specified idle speed.

IDLE SPEED: 1,400±100 rpm



FUEL LINE

Replace any parts which show signs of deterioration, damage or leaks.

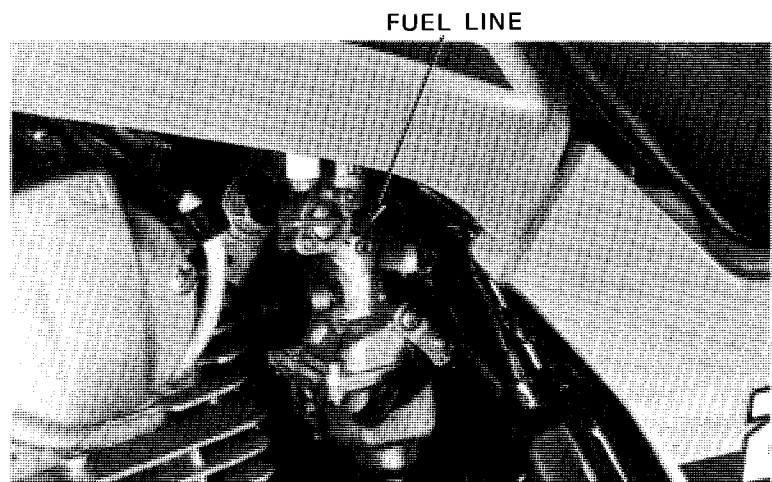

IGNITION TIMING

NOTE

The Capacitive Discharge Ignition (CDI) system is factory pre-set and does not require adjustment.

To inspect the function of the CDI components, ignition timing inspection procedures are given here.

Remove the timing hole cap.
Connect a tachometer and timing light.
Start the engine and allow it to idle.

IDLE SPEED: $1,400 \pm 100$ rpm

Inspect the ignition timing. Timing is correct, if the "F" mark on the rotor is aligned with the index mark on the left crankcase cover at idle.

INDEX MARK

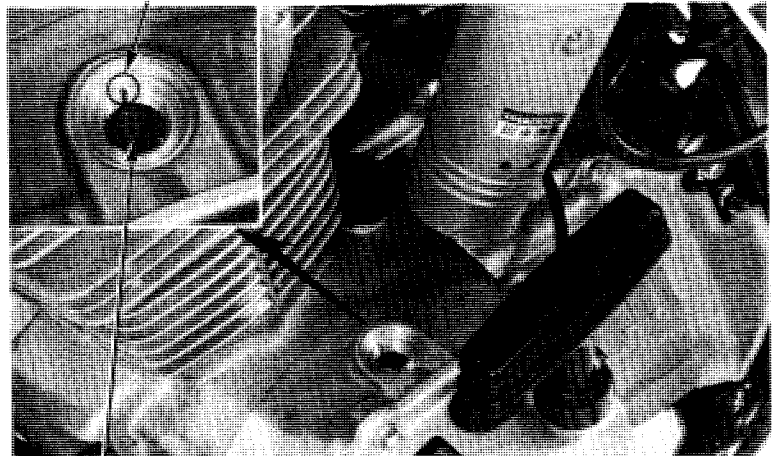

"F" MARK

CYLINDER COMPRESSION

Warm up the engine.
Stop the engine and remove the spark plug.
Insert a compression gauge.
Raise the choke lever all the way up.
Fully open the throttle.
Operate the recoil starter several times.

NOTE

Watch for compression leaking at the gauge connection.

**COMPRESSION: 11 ± 1 kg/cm²
(156 ± 14 psi)**

Low compression can be caused by:

- Improper valve adjustment
- Valve leakage
- Cylinder head gasket leaking
- Worn piston ring or cylinder

High compression can be caused by:

- Carbon deposits in combustion chamber or on piston crown



MAINTENANCE

DRIVE CHAIN

Stop the engine and shift the transmission into neutral.

Remove the drive chain inspection hole cap.

Check the amount of chain free play through the inspection hole.

**DRIVE CHAIN FREE PLAY: 10–20 mm
(3/8–3/4 in)**

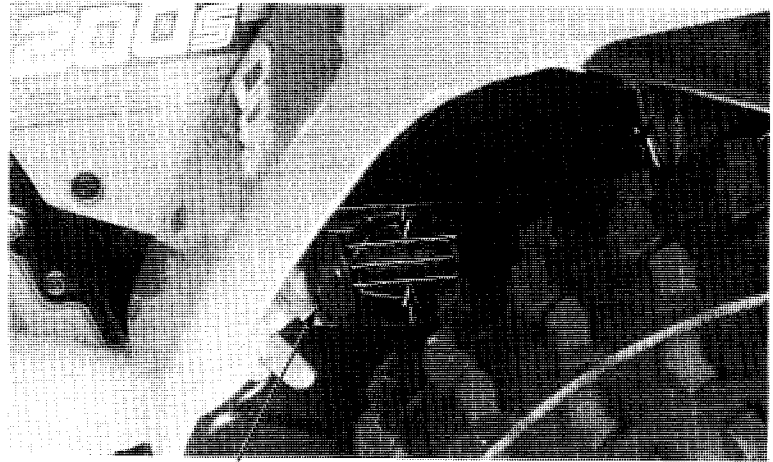

INSPECTION HOLE CAP

Adjust as follows:

Loosen the rear axle bearing holder bolts.
Turn the chain-adjuster to obtain the specified free play.

Retighten the rear axle bearing holder bolts.

Check the rear wheels for free rotation.
Adjust the rear brake (Page 3–15).

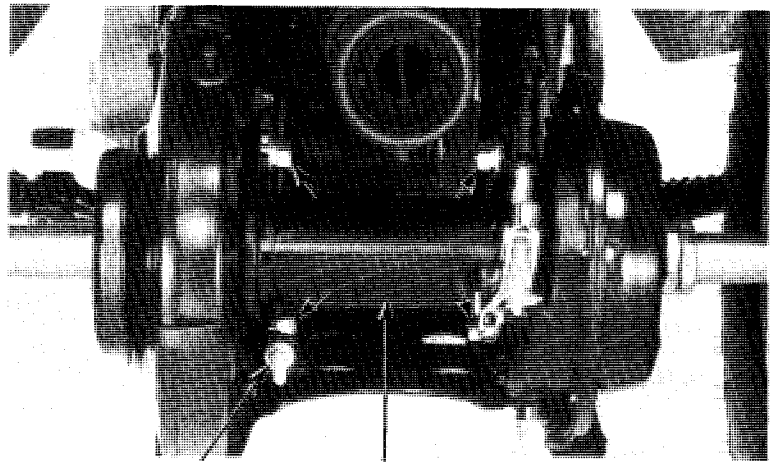

CHAIN ADJUSTER REAR WHEEL BEARING
HOLDER

LUBRICATION HOLE CAP

Remove the lubrication hole cap.

Lubricate the drive chain with SAE 80 or 90 gear oil lubricant through the lubrication hole.

Install the lubrication hole cap.

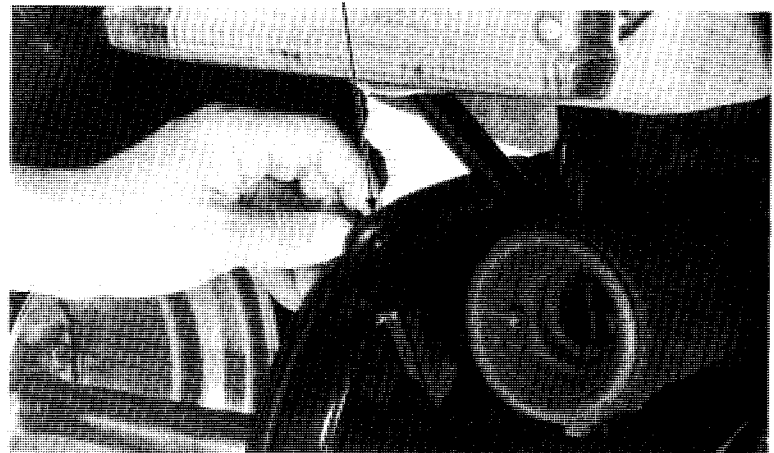

When the drive chain becomes extremely dirty, it should be removed and cleaned prior to lubrication.

Raise the rear wheels off the ground.

Remove the left axle nut cotter pin and the axle nut.

Remove the rear wheel.

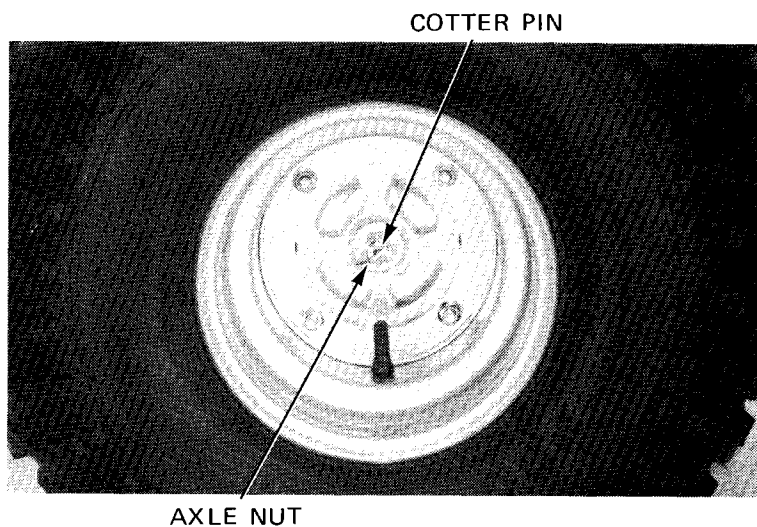

Remove the skid plate by removing the four bolts.

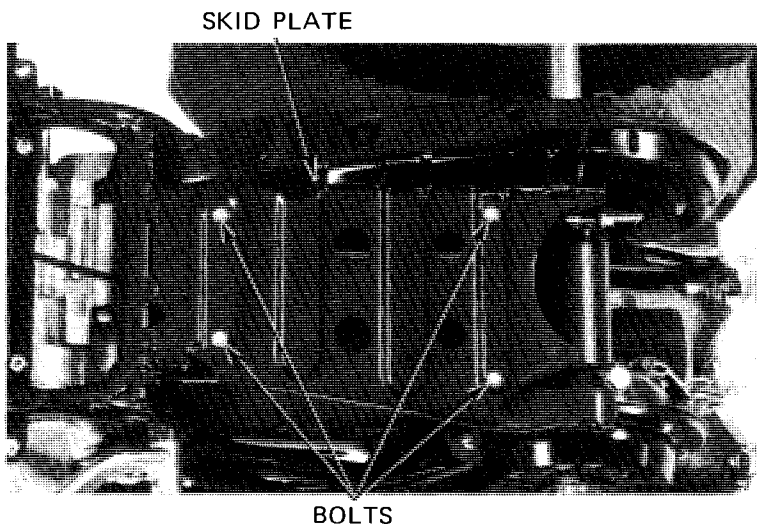

Remove the sealed cover by removing the three bolts as shown.

Pull off the chain cover clips and remove the drive chain cover by removing the two nuts.

Loosen the bearing holder bolts and drive chain adjuster (Page 3-10).

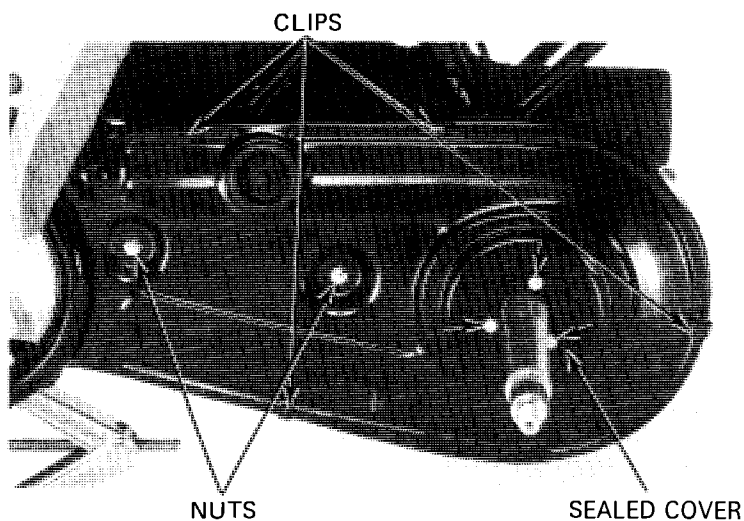

MAINTENANCE

Remove the retainer clip, master link, and drive chain.

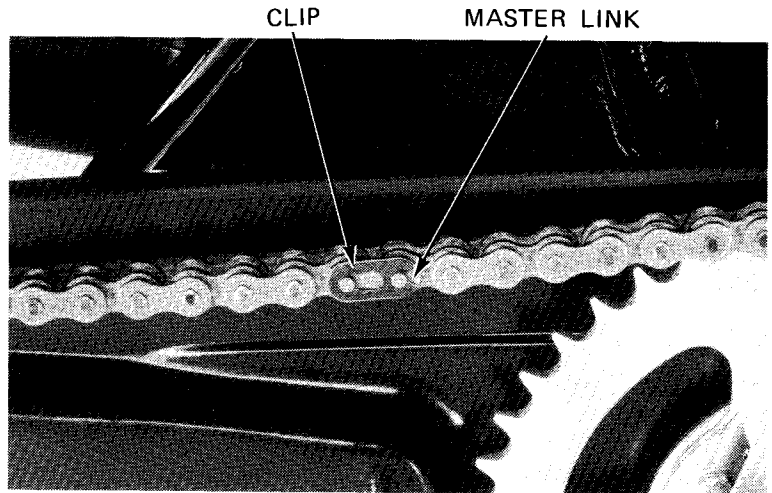

The drive chain is equipped with grease-retaining O-rings inside the chain to improve its service life. However, special precautions must be taken when adjusting, lubricating, washing and replacing the chain.

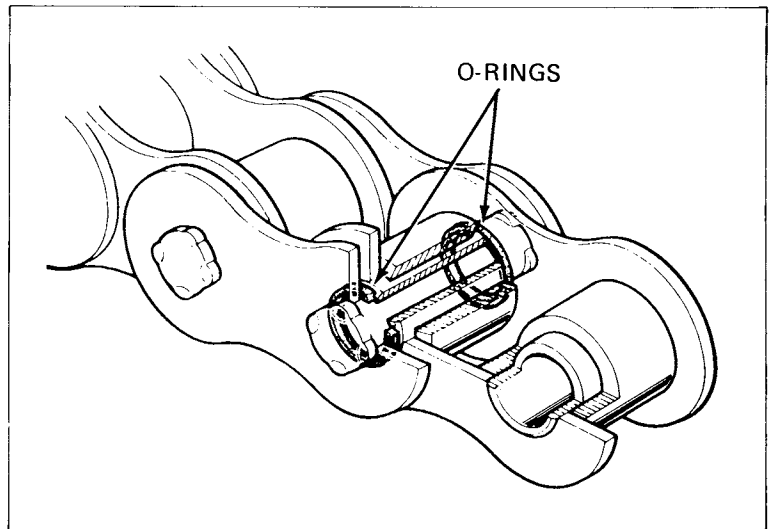

Clean the drive chain with kerosene and wipe dry.

CAUTION:

Do not use a steam cleaner, high pressure washers or solvents as these will damage the O-rings.

Lubricate the drive chain with SAE 80 or 90 gear oil.

CAUTION:

Use aerosol chain lubricants unless they are specifically for O-ring equipped chains. Other aerosol lubricants may contain solvents which could damage the O-rings.

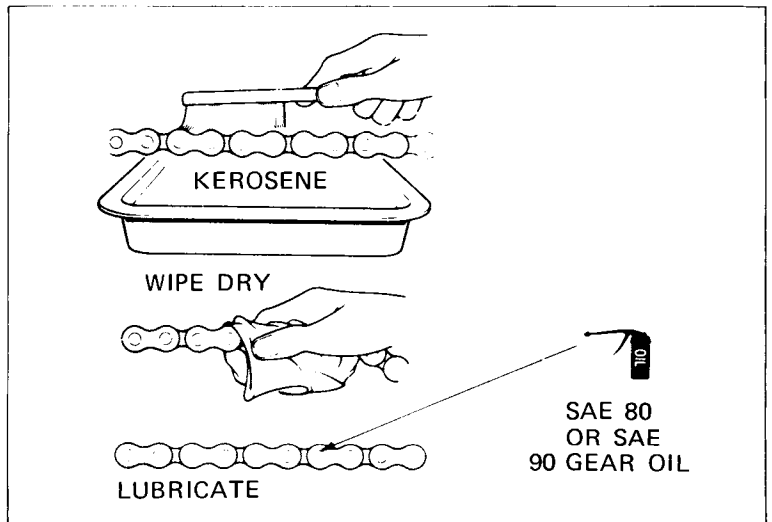

Inspect the driver chain and O-rings for possible wear or damage. Replace the chain, if it is worn excessively or damaged.

Measure the drive chain length with the chain held so that all links are straight.

45 PINS LENGTH:

STANDARD: 698.5 mm (27.50 in)

SERVICE LIMIT: 705.5 mm (27.78 in)

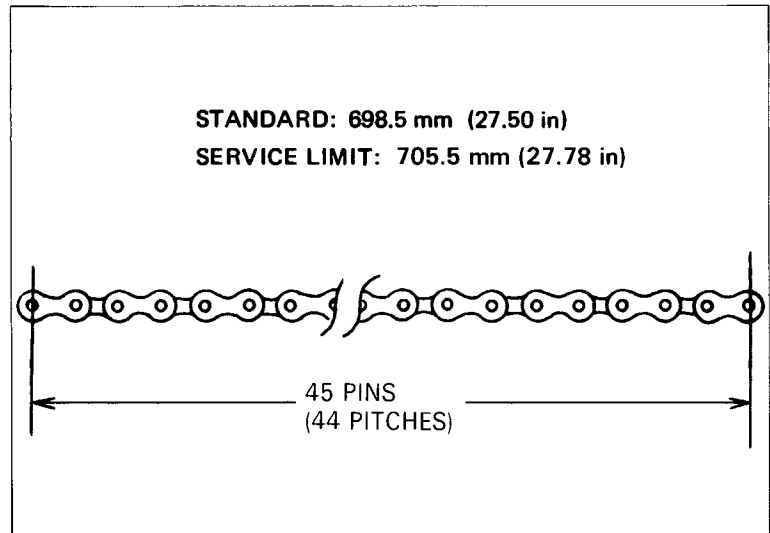

Inspect the sprocket teeth for excessive wear or damage. Replace if necessary.

NOTE

Never install a new drive chain on worn sprockets or a worn chain on new sprockets. Both chain and sprockets must be in good condition, or the new replacement chain or sprockets will wear rapidly.

To remove the drive sprocket, remove the left crankcase cover.

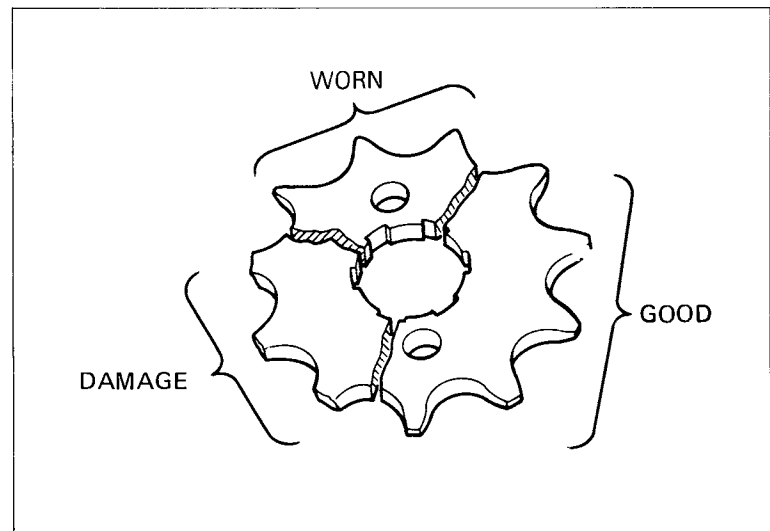

Install the drive chain in the reverse order of removal noting the chain clip direction.

CAUTION:

- Do not assemble the drive chain without the four O-rings.
- Be sure that there is no space between the master link and chain retaining clip.

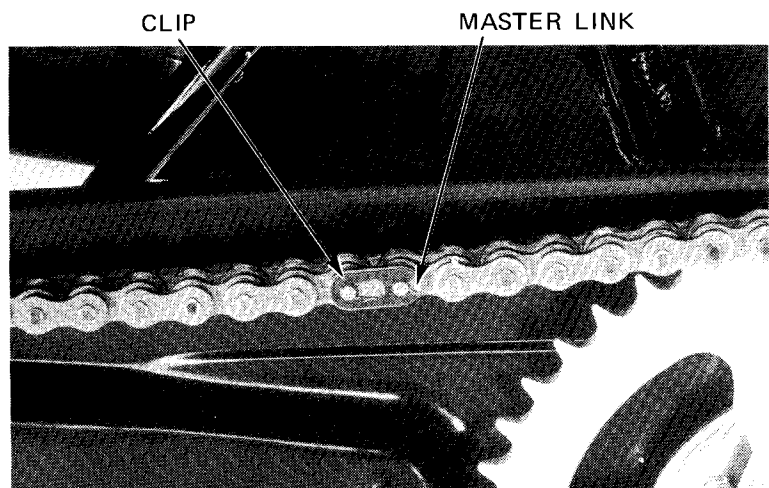

MAINTENANCE

BRAKE SHOES

Replace the brake shoes if the indicator plate aligns with the brake panel index mark when the front brake lever, rear brake lever or pedal is applied.

<Front brake>

<Rear brake>

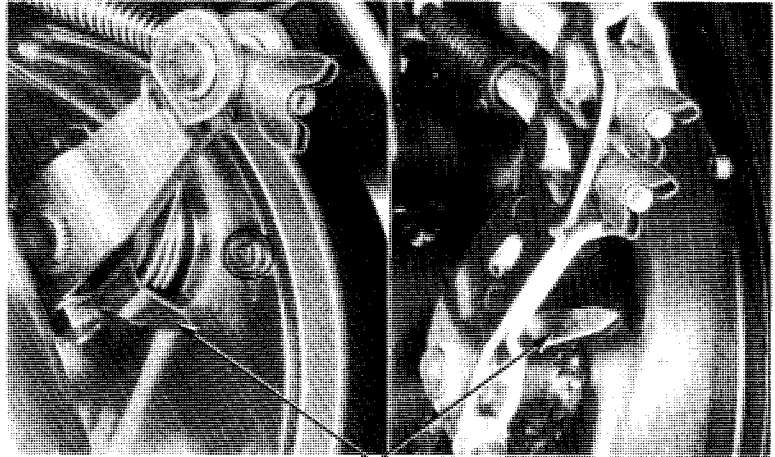

INDICATOR PLATE

FRONT BRAKE

Check the cable and brake lever for loose connections, excessive play, or other damage. Replace or repair if necessary.

Disconnect the brake cable at the upper end. Thoroughly lubricate the cable and pivot point with a commercially available cable lubricant to prevent premature wear.

Install the brake cable. Make sure brake lever free play is 15–20 mm (5/8–3/4 in) at the brake lever tip.

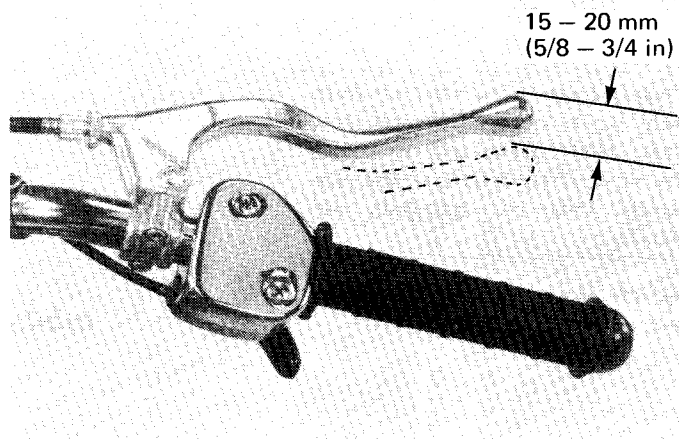

ADJUSTMENT

Major adjustments are made by turning the lower adjuster.

NOTE

Make sure the cut-out of the adjusting nut is seated on the brake arm pin.

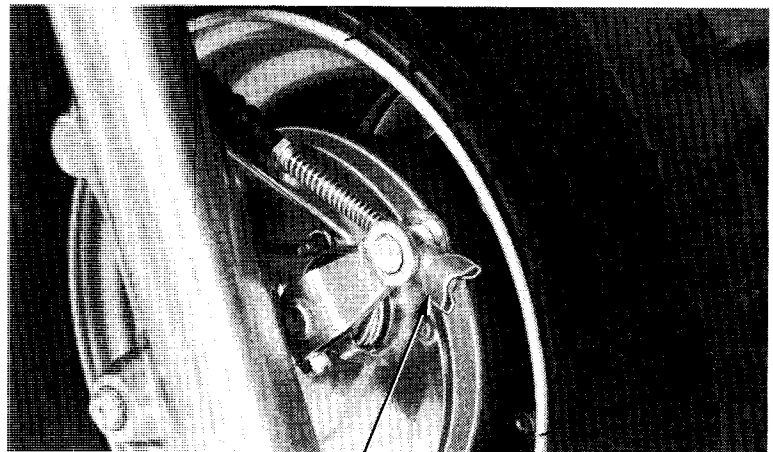

LOWER ADJUSTER

Minor adjustments are made at the upper adjuster. Loosen the lock nut and turn the adjuster.

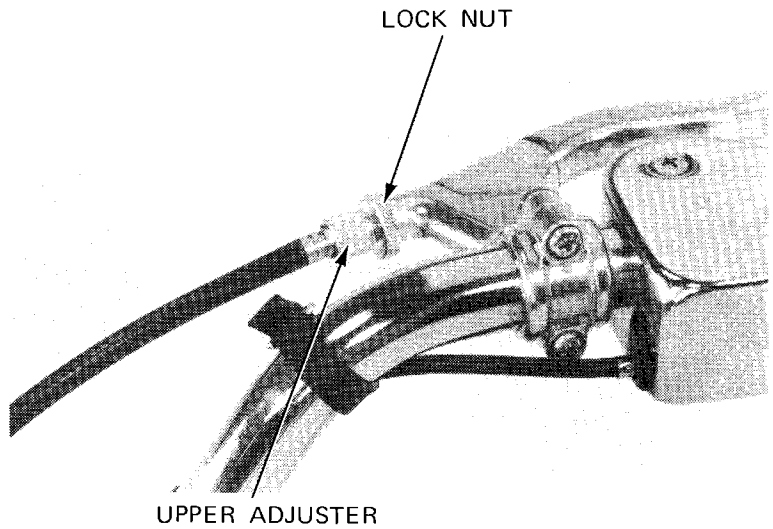

REAR BRAKE

Check the cable, brake lever and brake pedal for loose connections, excessive play, or other damage.

Replace or repair if necessary.

Disconnect the brake cables at the brake lever or pedal ends.

Thoroughly lubricate the cables and their pivot points with a commercially available cable lubricant to prevent premature wear.

Install the cables.

FREE PLAY INSPECTION

Measure the brake pedal free play at the brake pedal.

BRAKE PEDAL FREE PLAY:

15–20 mm (5/8–3/4 in)

Measure the rear brake lever (parking brake) free play at the end of the brake lever.

REAR BRAKE LEVER FREELY PLAY:

15–20 mm (5/8–3/4 in)

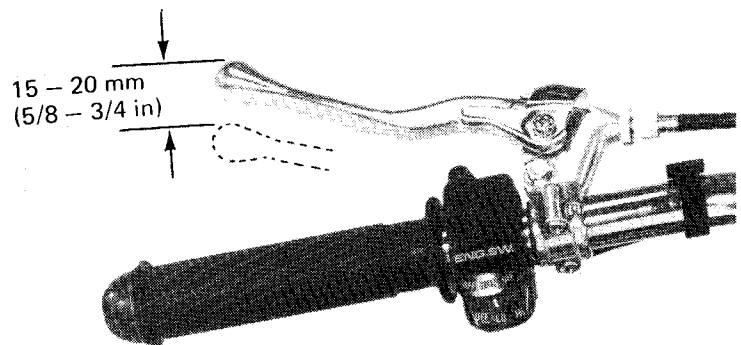
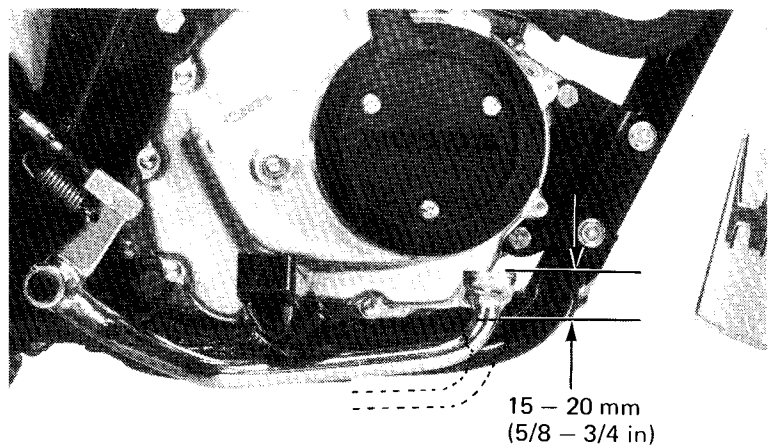

MAINTENANCE

ADJUSTMENT

Brake pedal and major brake lever adjustments are made by turning the adjusters at the lower end of the cables.

NOTE

Make sure the cut-out of each adjuster is seated on the brake arm pin.

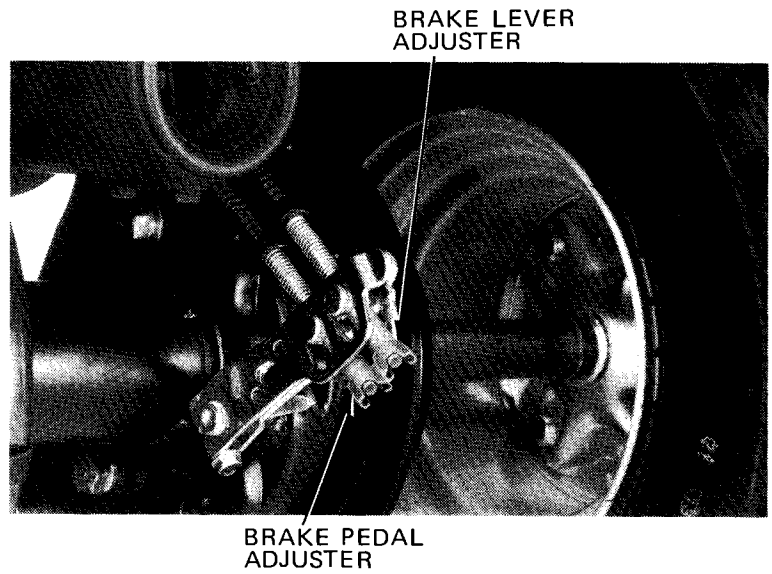

Minor brake lever adjustments are made at the upper adjuster. Loosen the lock nut and turn the adjuster.

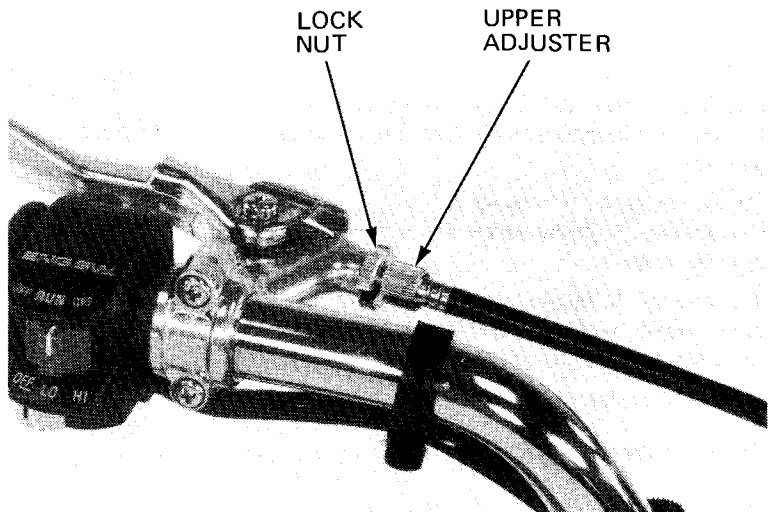

CLUTCH

Stop the engine.
Loosen the clutch adjusting screw lock nut.
Slowly turn the adjusting screw counter-clockwise until resistance is felt.
Then turn the adjusting screw clockwise 1/4 turn, and tighten the lock nut.
After adjustment, start the engine and check for proper clutch operation.

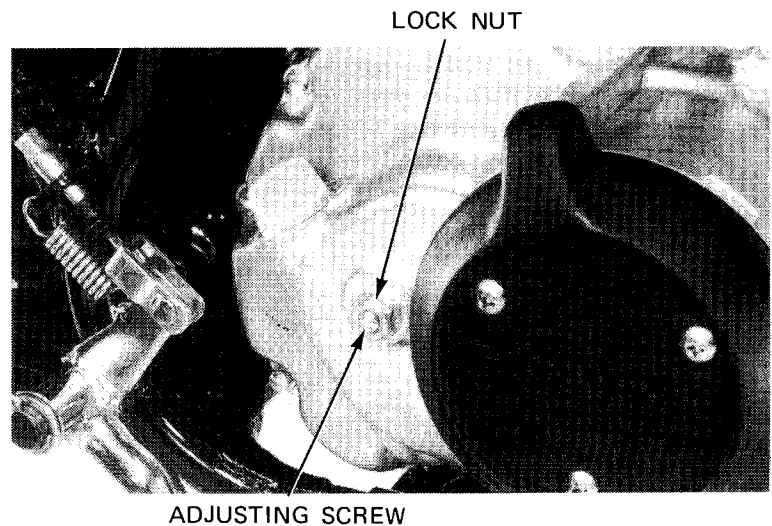

SPARK ARRESTER CLEANING

WARNING

- *Do not remove and install the spark arrester while the exhaust pipe is hot.*
- *Perform this operation in a well-ventilated area, free from fire hazard.*
- *Use adequate eye protection.*

Remove the spark arrester bolts and muffler plate.

Start the engine and purge accumulated carbon from the exhaust system by momentarily revving up the engine several times.

Stop the engine and allow the exhaust pipe to cool.

Install the muffler plate.

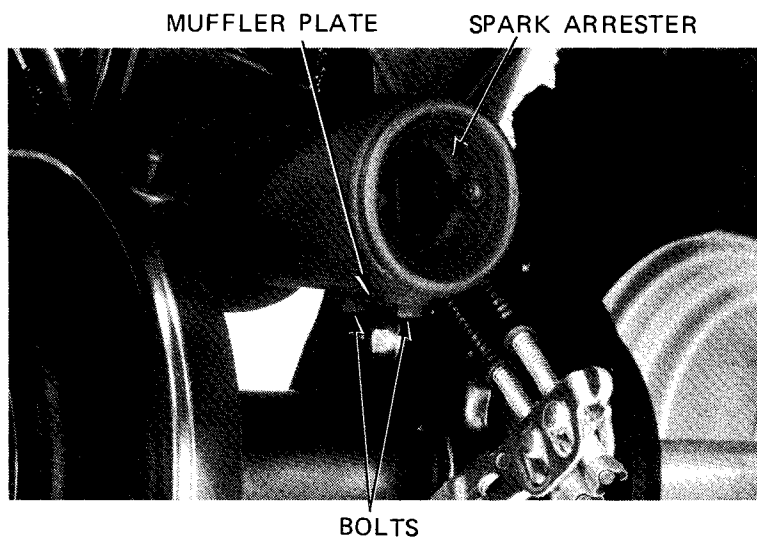

SPARK ARRESTER

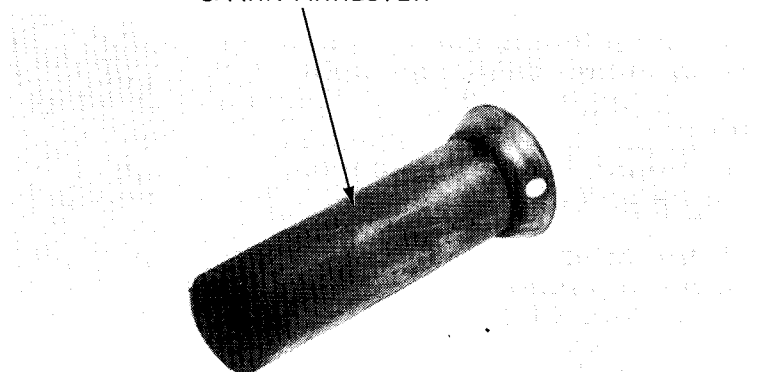

NUTS, BOLTS, FASTENERS

Tighten bolts, nuts and fasteners at the intervals shown in the maintenance Schedule (Page 3-3).

Check that all chassis nuts and bolts are tightened to their correct torque values (Page 1-4). Check that all cotter pins and safety clips are in place.

LIGHTING EQUIPMENT

Apply the parking brake lever.

Start the engine and check the headlight and taillight by operating the lighting switch.

| Position | Function |
|----------|---|
| OFF | Head lights are OFF. |
| LO | Headlight low beam and taillight should be ON. |
| HI | Headlight high beam and taillight should be ON. |

If the lights do not work properly, check the bulbs and refer to page 15-3 to test the switch if necessary.

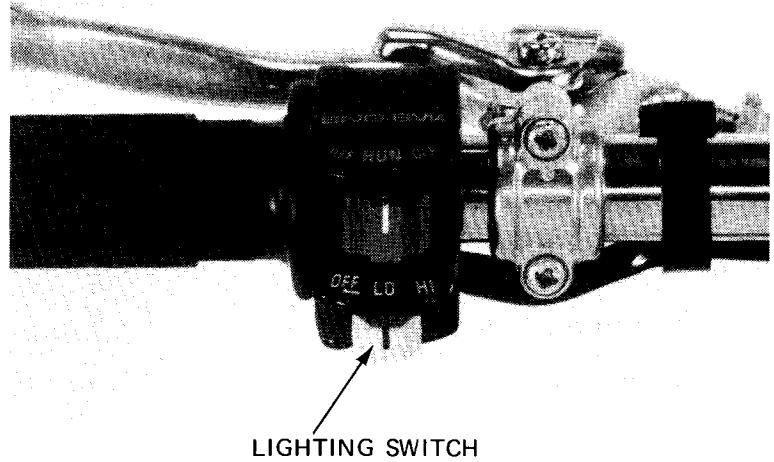

TIRES

Check the tire for cuts, imbedded nails, or other sharp objects. Check the tire pressure.

NOTE

Tire pressure should be checked when the tires are COLD.

TIRE PRESSURES:

Recommended pressure:

2.2 psi (15 kPa, 0.15 kg/cm²)

Minimum pressure:

1.8 psi (12 kPa, 0.12kg/cm²)

Maximum pressure:

2.6 psi (18 kPa, 0.18 kg/cm²)

STANDARD TIRE CIRCUMFERENCE:

'84~'85 1,759 mm (69.3 in)

After '85 1,750 mm (68.9 in)

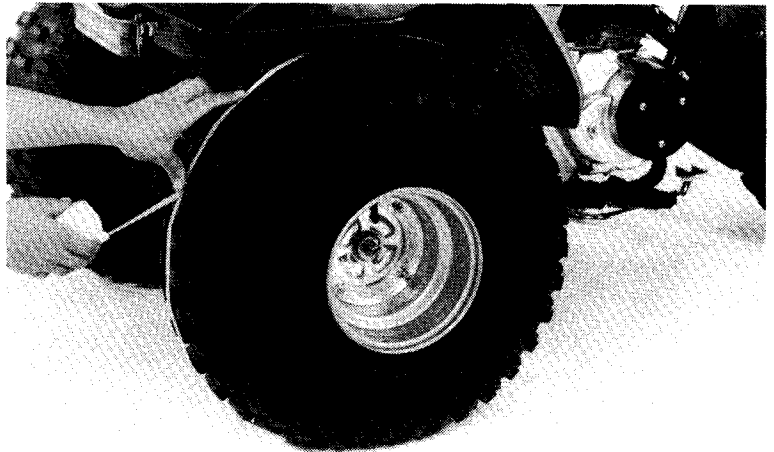

STEERING HEAD BEARINGS

NOTE

Make sure the cables do not interfere with the rotation of the handlebar.

Raise the front wheel off the ground and make sure that the handlebar rotates freely.

If the handlebar moves unevenly, binds or has vertical movement, adjust the steering head bearing by turning the steering head adjusting nut with a pin spanner (Page 11-29).

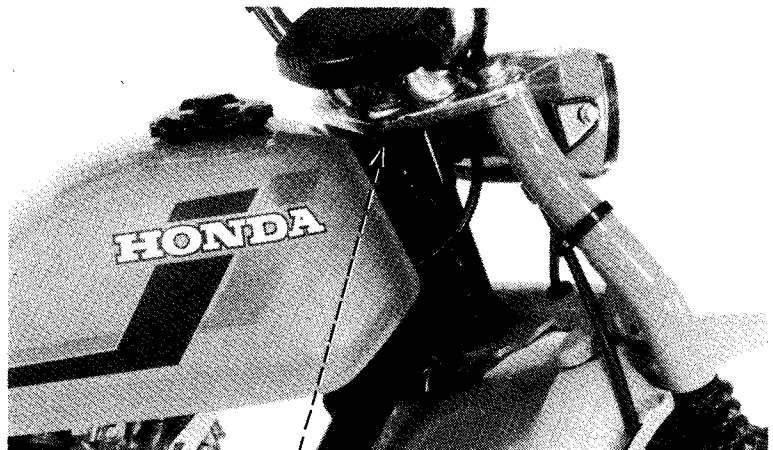

STEERING HEAD BEARINGS



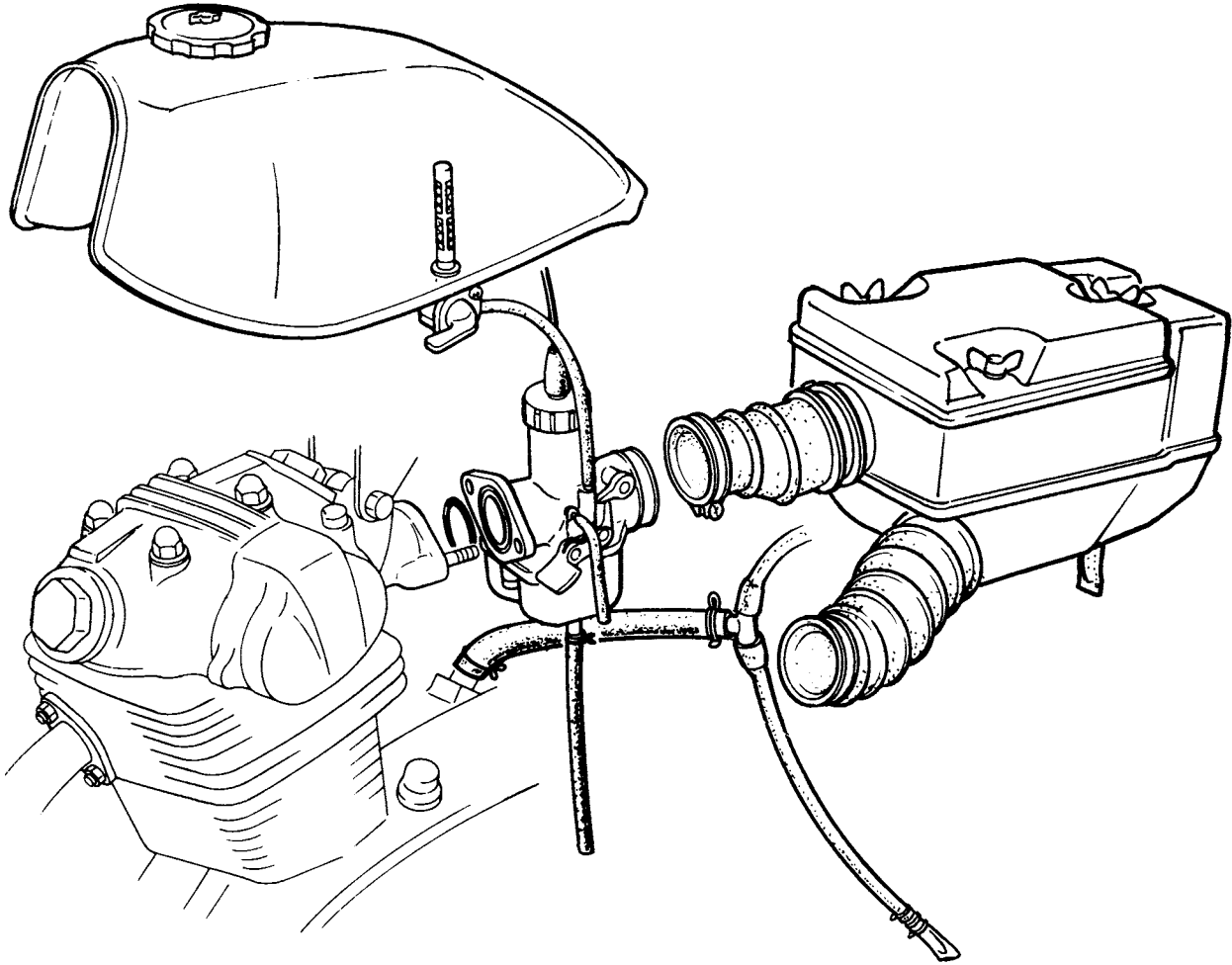

4. FUEL SYSTEM

| | |
|-----------------------------|------|
| SERVICE INFORMATION | 4-1 |
| TROUBLESHOOTING | 4-2 |
| FUEL TANK | 4-3 |
| AIR CLEANER CASE | 4-4 |
| CRANKCASE BREATHER | 4-6 |
| CARBURETOR REMOVAL | 4-7 |
| THROTTLE VALVE DISASSEMBLY | 4-8 |
| FLOAT, FLOAT VALVE AND JETS | 4-9 |
| CARBURETOR ASSEMBLY | 4-11 |
| FLOAT LEVEL MEASUREMENT | 4-11 |
| THROTTLE VALVE ASSEMBLY | 4-11 |
| CARBURETOR INSTALLATION | 4-12 |
| PILOT SCREW ADJUSTMENT | 4-12 |
| HIGH ALTITUDE ADJUSTMENT | 4-13 |

SERVICE INFORMATION

GENERAL

- Use caution when working with gasoline. Always work in a well ventilated area away from sparks or flames.
- When disassembling fuel system parts, note the locations of the O-rings. Replace them during reassembly.
- The carburetor float bowl has a drain screw that can be loosened to drain gasoline.

SPECIFICATIONS

| | | |
|-----------------------|-------------|---|
| Fuel tank capacity | '84 : | 8.2 liters (2.17 US gal, 1.80 Imp. gal) |
| | After '84 : | 7.8 liters (2.06 US gal, 1.72 Imp. gal) |
| Fuel reserve capacity | | 1.6 liters (0.42 US gal, 0.35 Imp. gal) |

Carburetor

| | '84 : | After '84 : |
|--------------------------|-----------------------|-------------|
| Identification mark | PD 85 C | PD 85 D |
| Type | Piston valve | ← |
| Venturi diameter | 22 mm (0.9 in) | ← |
| Float level | 14.0 mm (0.55 in) | ← |
| Pilot screw opening | 2-1/4 turns out | ← |
| Idle speed | 1,400 ± 100 rpm | ← |
| Main jet | # 100 | ← |
| Throttle lever free play | 5-10 mm (3/16-3/8 in) | ← |
| Jet needle clip | 3rd groove | ← |

TOOL

Common

Float level gauge: 07401-0010000

TROUBLESHOOTING

Engine cranks but won't start

1. No fuel in tank
2. No fuel to cylinder
3. Too much fuel getting to cylinder
4. No spark at plug (ignition malfunction)

Engine idles roughly, stalls, or runs poorly

1. Idle speed incorrect
2. Ignition malfunction
3. Rich mixture
4. Lean mixture
5. Air cleaner dirty
6. Insulator leaks

Lean mixture

1. Carburetor fuel jet clogged
2. Fuel cap vent blocked
3. Fuel filter clogged
4. Fuel line kinked or restricted
5. Float valve faulty
6. Float level too low

Rich mixture

1. Carburetor choke stuck closed
2. Float valve faulty
3. Float level too high
4. Carburetor air jet clogged
5. Air cleaner dirty

FUEL TANK

Remove the seat.
Turn the fuel valve OFF, and disconnect the fuel line. Remove the fuel tank.

WARNING

Keep gasoline away from flames or sparks. Wipe up spilled gasoline at once.

Use a drain pan and check that fuel flows freely out of the fuel valve. If flow is restricted, clean the fuel strainer (Page 3-7). Install the fuel tank and connect the fuel tube. Install the seat.

NOTE

- Be sure the front fuel tank brackets are on the rubber cushions.
- After assembly, make sure there are no fuel leaks.
- Do not overtighten the fuel valve lock nut.

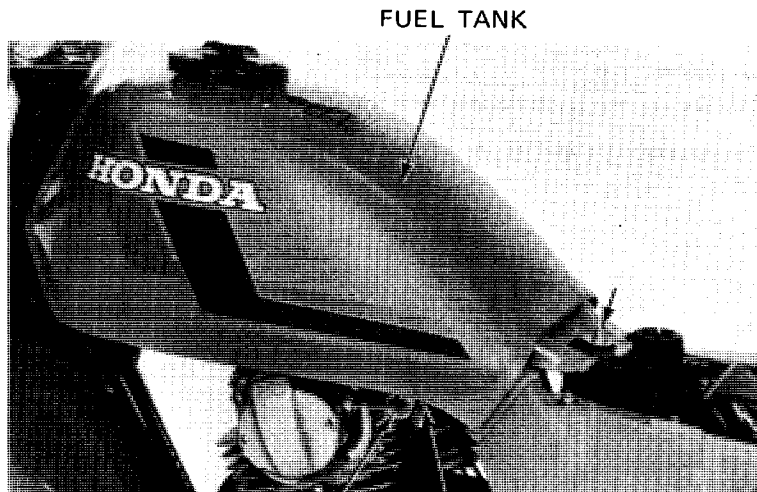

FUEL LINE FUEL VALVE

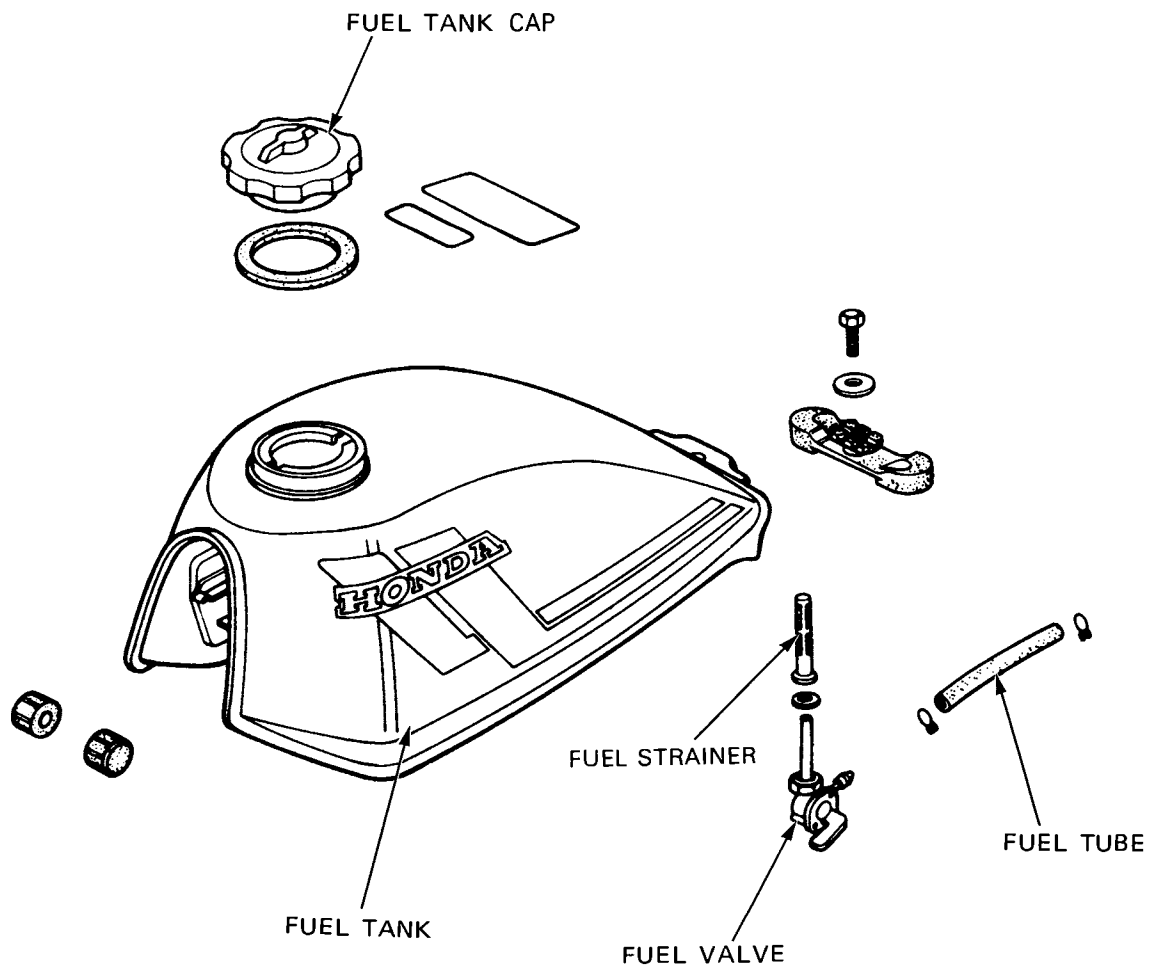

AIR CLEANER CASE

- Remove the seat.
- Remove the rear fender upper mount bolts.
- Remove the right and left side bolts.

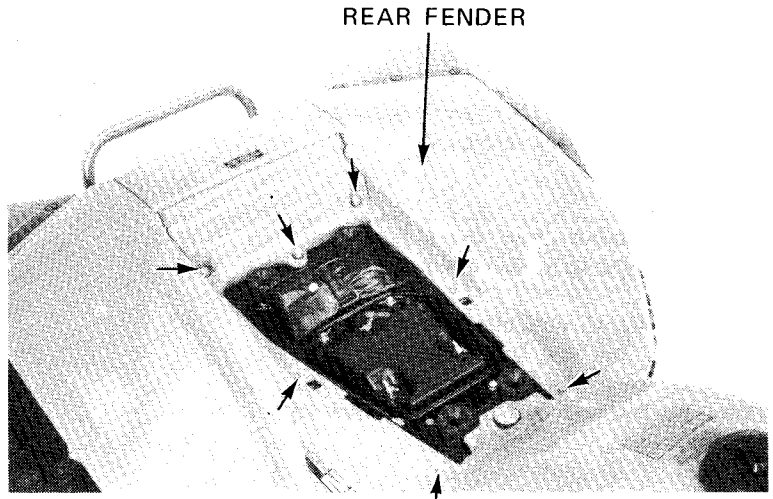

- Remove the right and left rear fender bracket mounting bolts.
- Remove the rear fender.

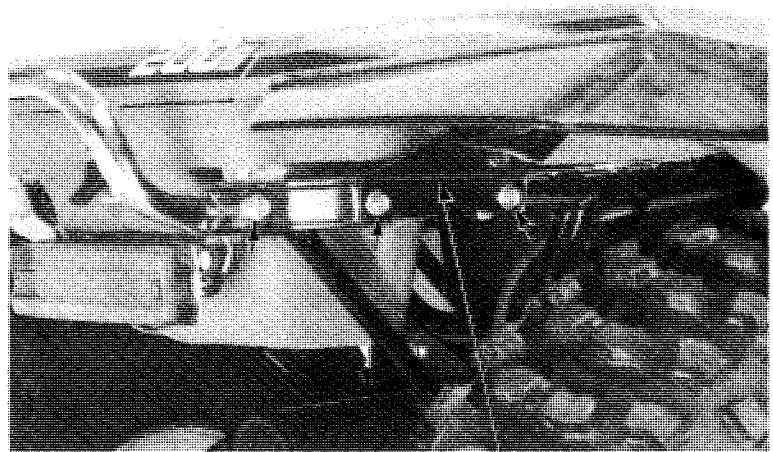

REAR FENDER
BRACKET

- Loosen the connecting tube bands.

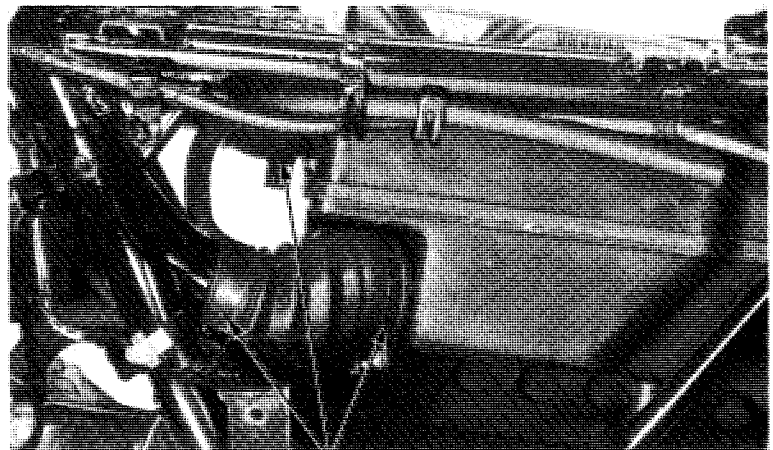

TUBE BANDS

Remove the following :

- air cleaner case bolts and case.
- air cleaner cover wing bolts and cover.
- the element assembly from air cleaner case.
- the element from element holder.

For air cleaner element service, refer to page 3-4.

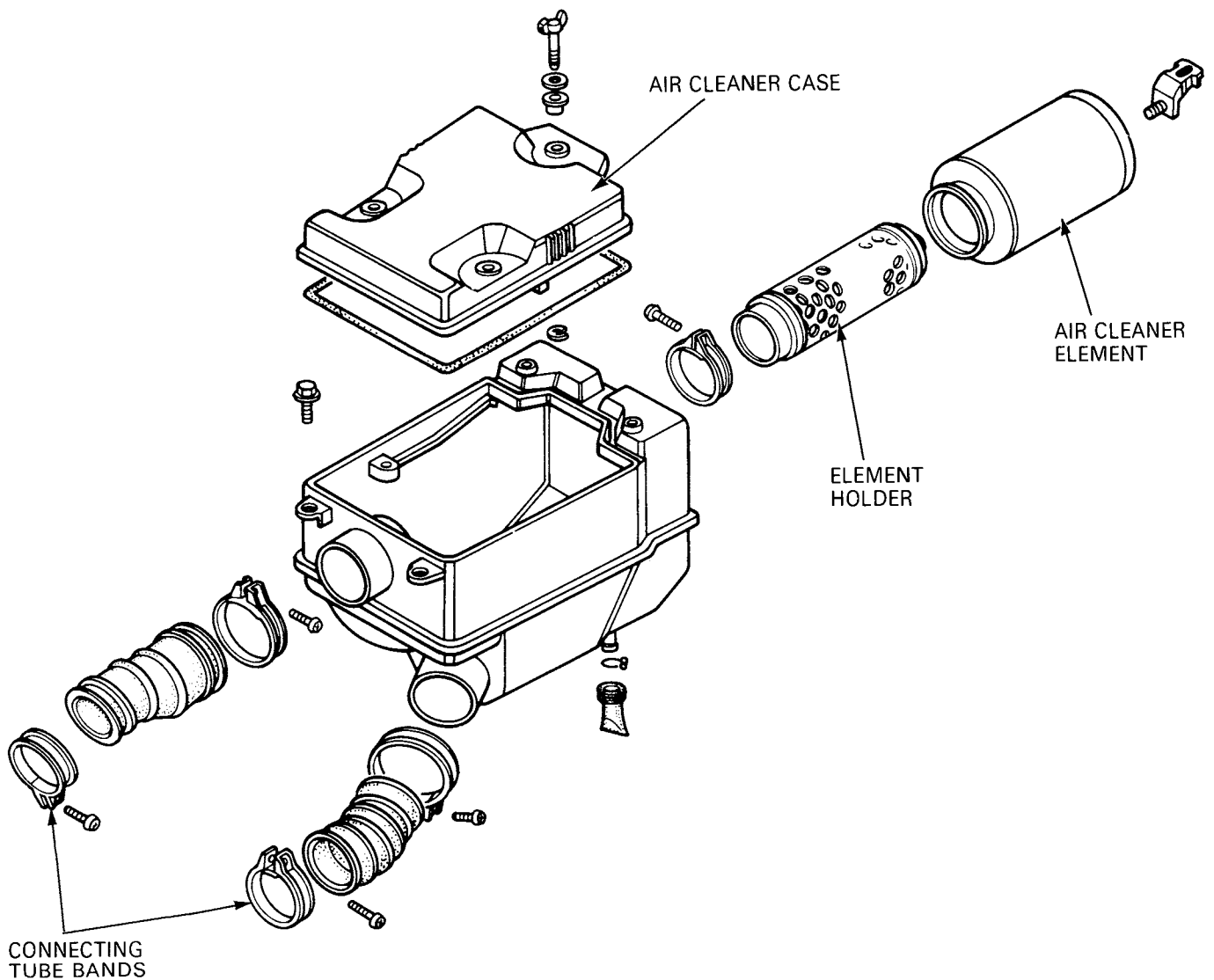
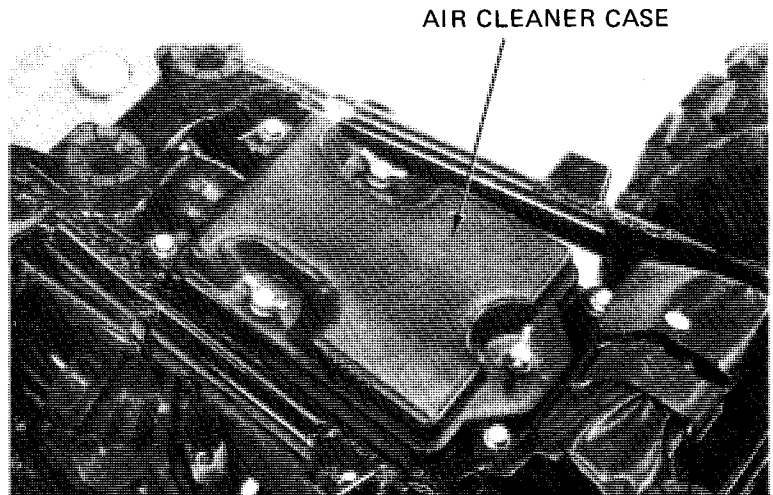

CRANKCASE BREATHER

Route the crankcase breather tube as shown.

'84~'85:

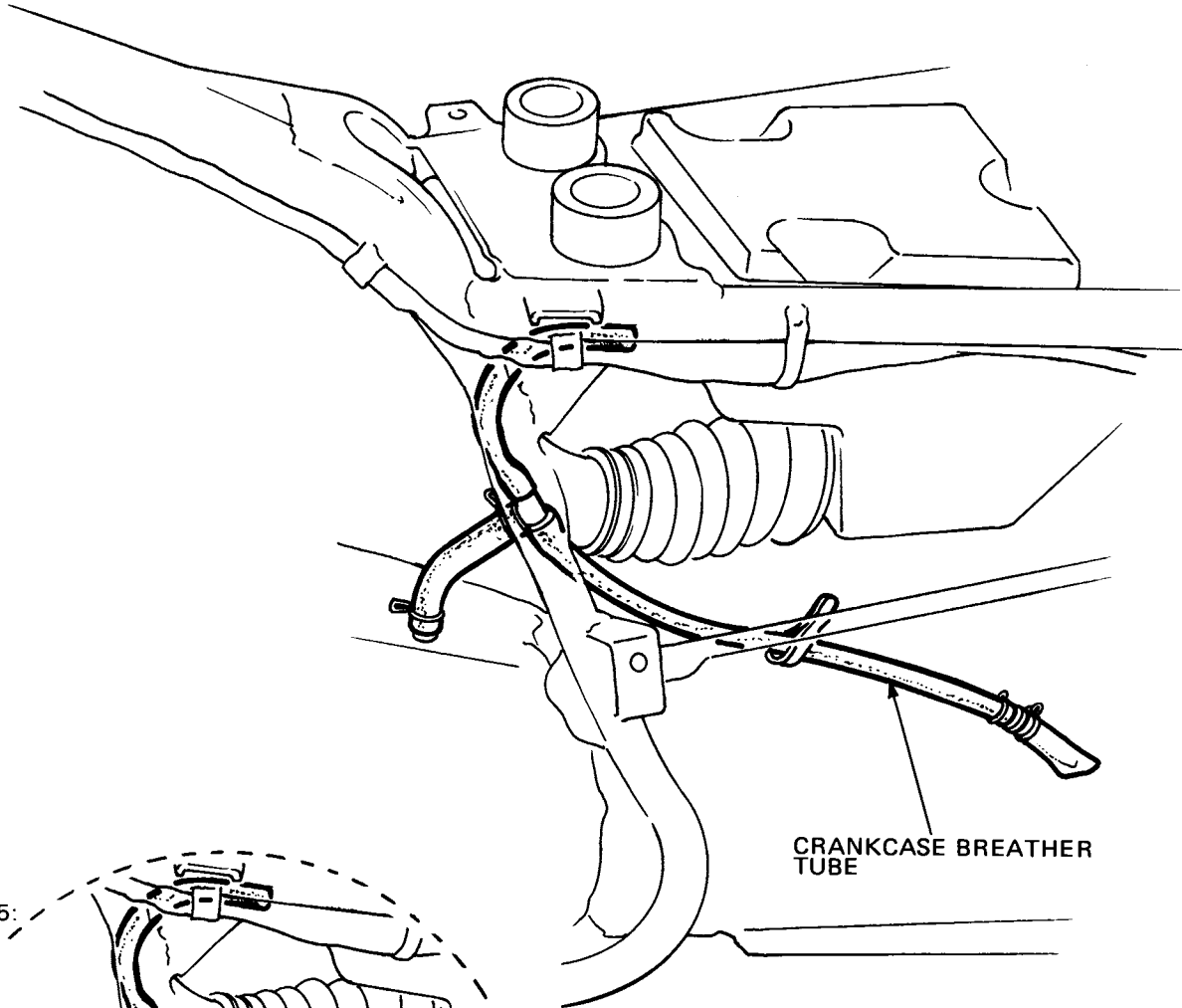

After '85:

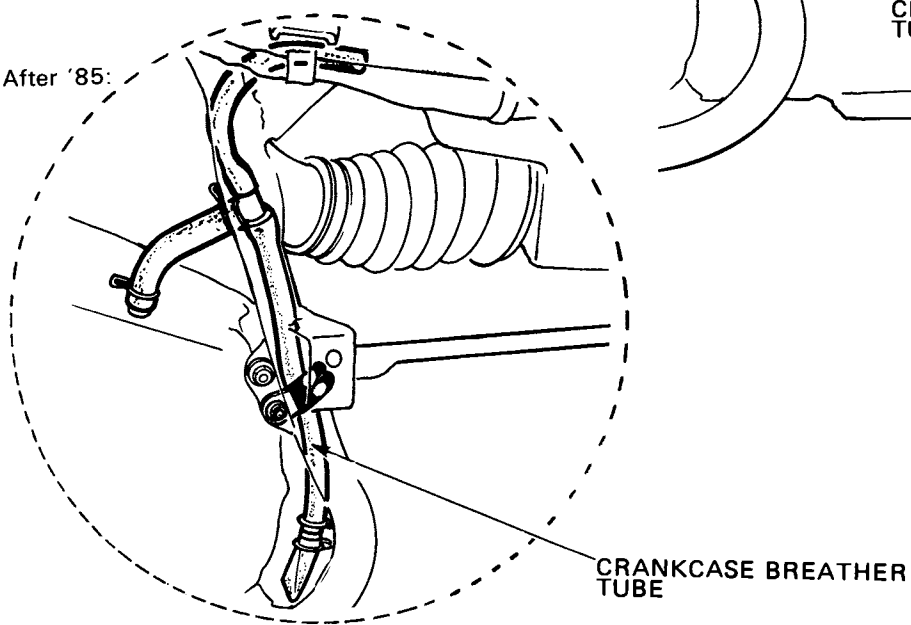

CARBURETOR REMOVAL

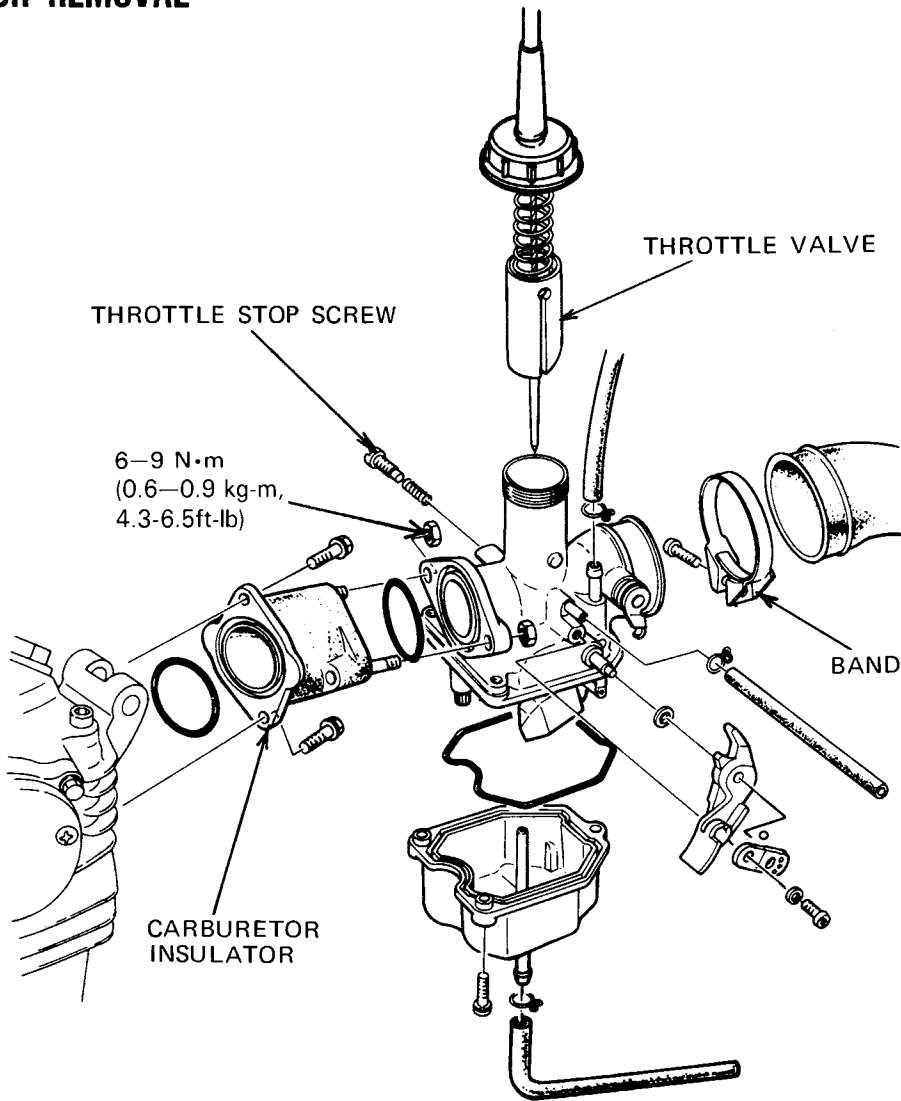

Remove the seat.
Turn the fuel valve OFF and disconnect the fuel line.

Remove the fuel tank.
Loosen the drain screw and drain the gasoline.

Unscrew the carburetor top and pull the throttle valve out.

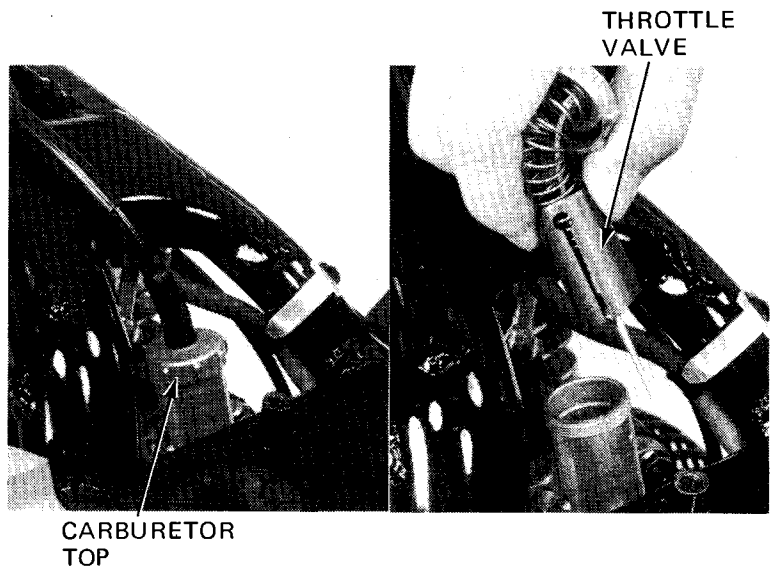

FUEL SYSTEM

Loosen the screw securing the carburetor band and remove the carburetor setting nuts.

Remove the carburetor.

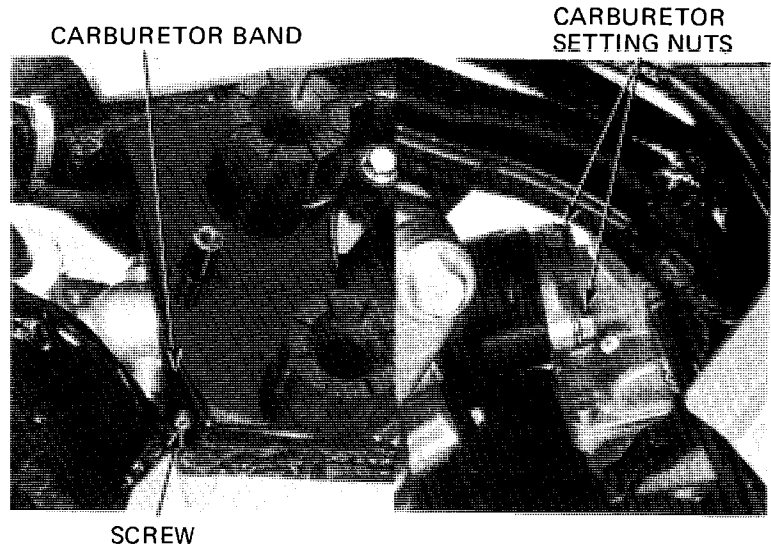

THROTTLE VALVE DISASSEMBLY

Remove the throttle cable from the throttle valve while compressing the throttle valve spring.

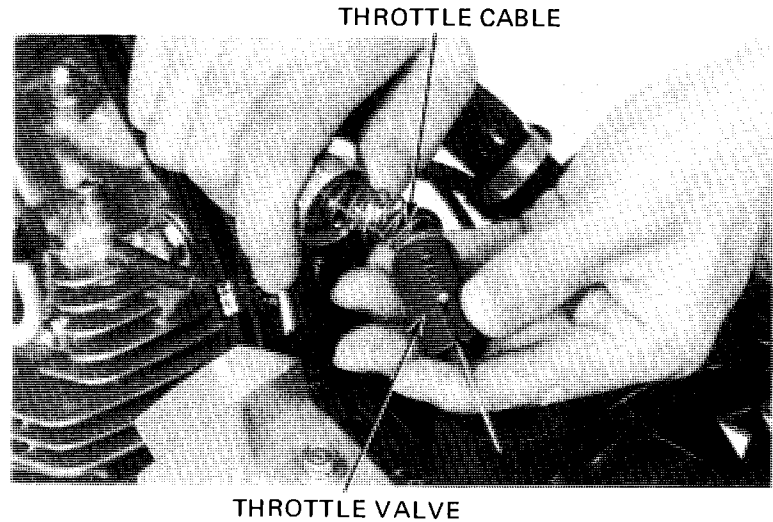

Remove the needle clip retainer jet needle and needle clip.

Inspect the throttle valve and jet needle surface for dirt, scratches or wear.

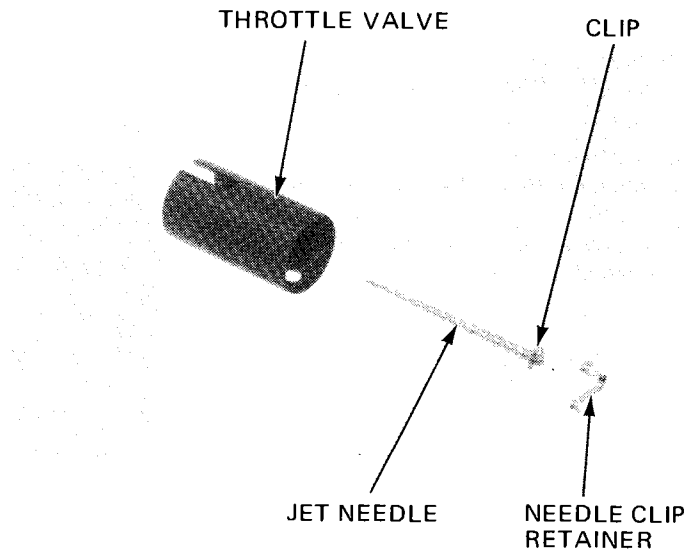

THROTTLE CABLE REPLACEMENT

After '85:

NOTE:

For after '85 models, there are two types of carburetor top and throttle cable assemblies. They are: integral and clip-on. The integral cable is manufactured so that it must be replaced with the carburetor top as an assembly.

The clip-on type cable (cable clips into the carburetor top) can be replaced separately without the top.

The replacement instructions for the clip-on type are below:

Make a U-clip as shown, using 1 mm (0.04 in) diameter wire. Be sure to cut the ends of the U-clip as shown.

Turn the carburetor top to align the holes in the top with the grooves in the cable end.

Insert the ends of the U-clip through the holes in the top and into the grooves in the cable end.

Press the clip in with a pair of pliers to expand the retaining ring and separate the cable from the top.

Check that the retaining ring is in the groove in the carburetor top. Slide the end of the new cable through the hole in the carburetor top until the retaining ring seats in the cable end.

Pull on the cable to be sure it is secured by the retaining ring.

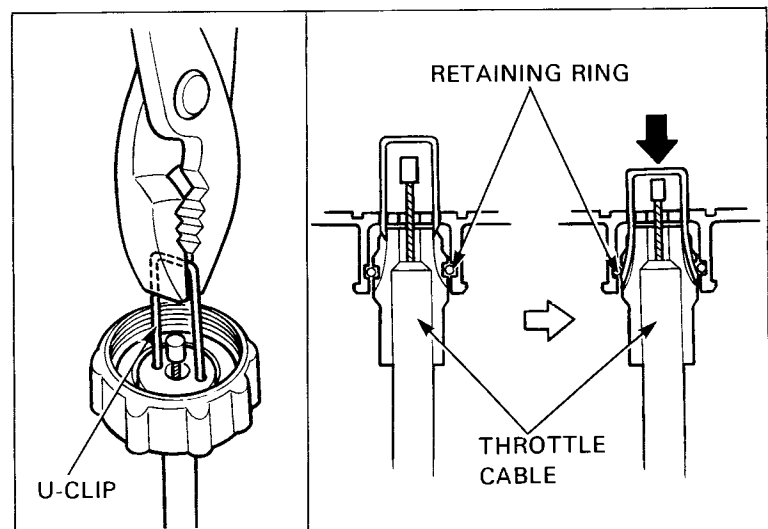
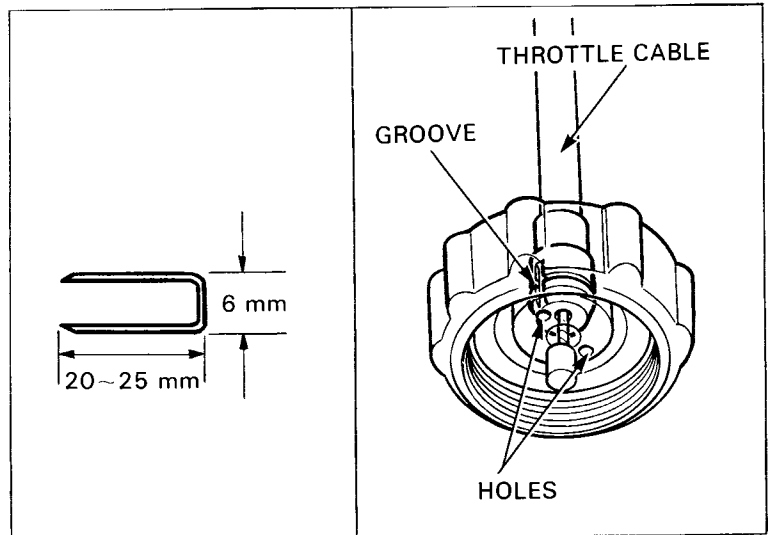

FLOAT, FLOAT VALVE AND JETS

- Remove the float chamber body.
- Remove the float arm pin with pliers.
- Remove the float and float valve.

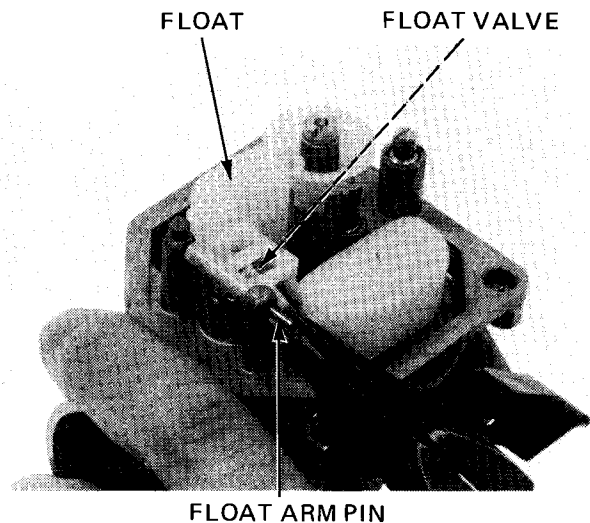

FUEL SYSTEM

Inspect the float valve and seat for wear or damage.
Replace them as a set if wear or damage can be seen.

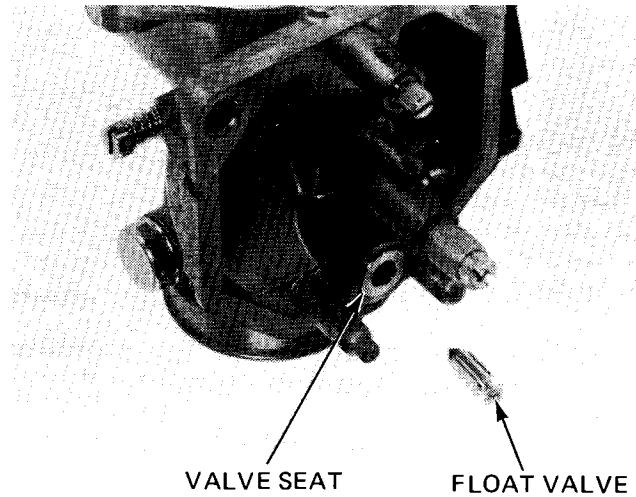

Remove the main jet, needle jet holder and needle jet.
Remove the slow jet.
Remove the throttle stop screw.
Before removing the pilot screw, record the number of turns in before the screw seats lightly. The pilot screw can then be returned to its original position, during reassembly without performing pilot screw adjustment.
Remove the pilot screw.

Inspect the pilot screw, throttle stop screw needle jet, needle jet holder and main jet.
Check each part for wear or damage.

Replace any parts that show wear or damage.

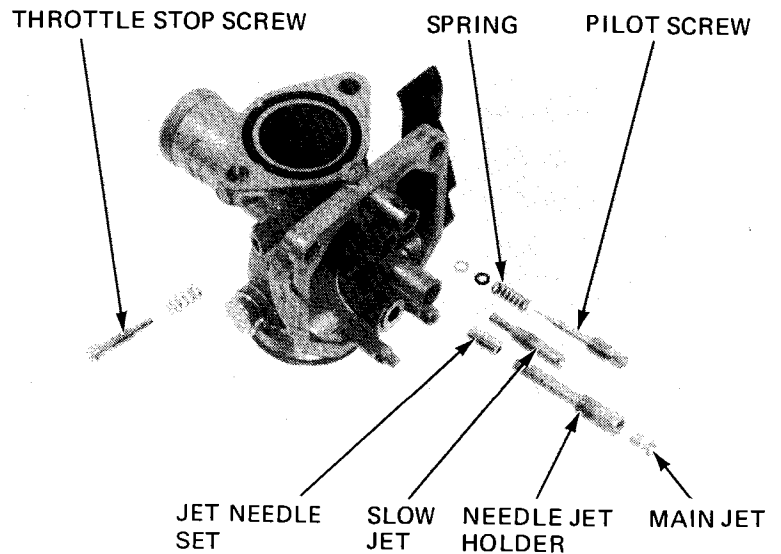

Blow open all jets and body openings with compressed air.

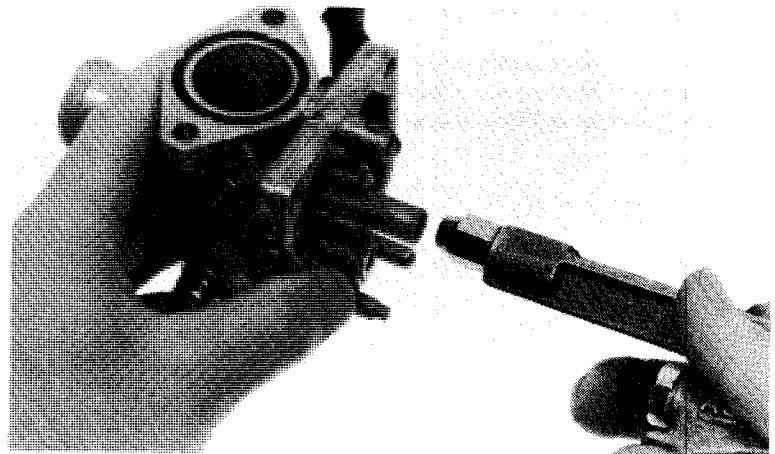

CARBURETOR ASSEMBLY

Carburetor assembly is essentially the reverse order of disassembly.

NOTE

- Use new O-rings when the carburetor is reassembled.
- Handle all jets and needles with care. They can easily be scored or scratched.
- Set the pilot screw to the position recorded during disassembly.

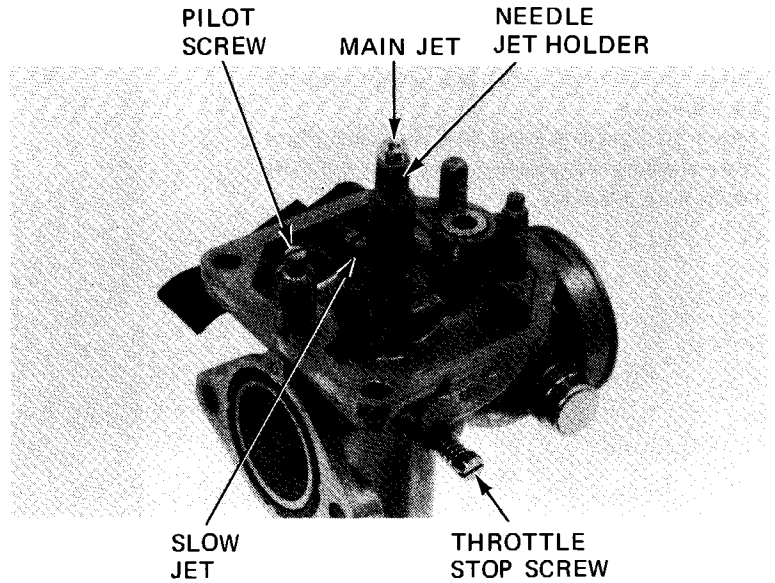

FLOAT LEVEL MEASUREMENT

Remove the float chamber body.

Measure the float level with the float tang just resting against the float valve.

FLOAT LEVEL: 14.0 mm (0.55 in)

Replace the float if the float level is not within specification. The float is not adjustable.

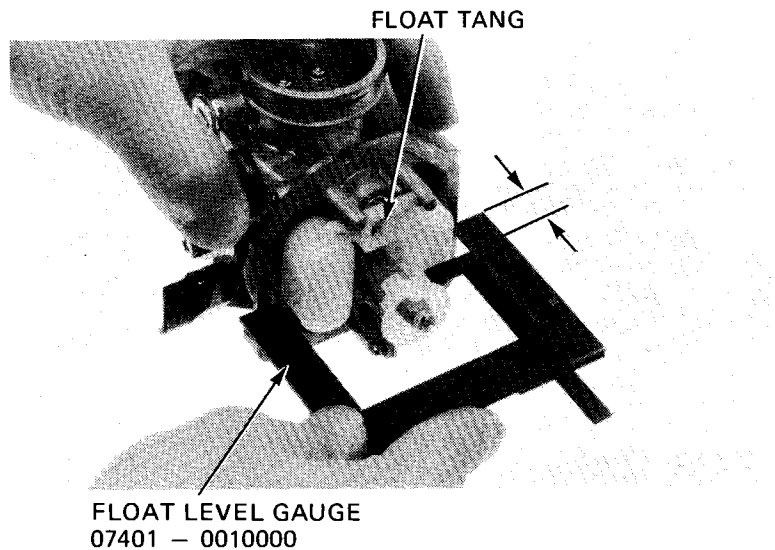

THROTTLE VALVE ASSEMBLY

Install the needle clip on the jet needle.

STANDARD SETTING: 3rd groove

Install the jet needle into the throttle valve and secure it with the needle clip retainer.

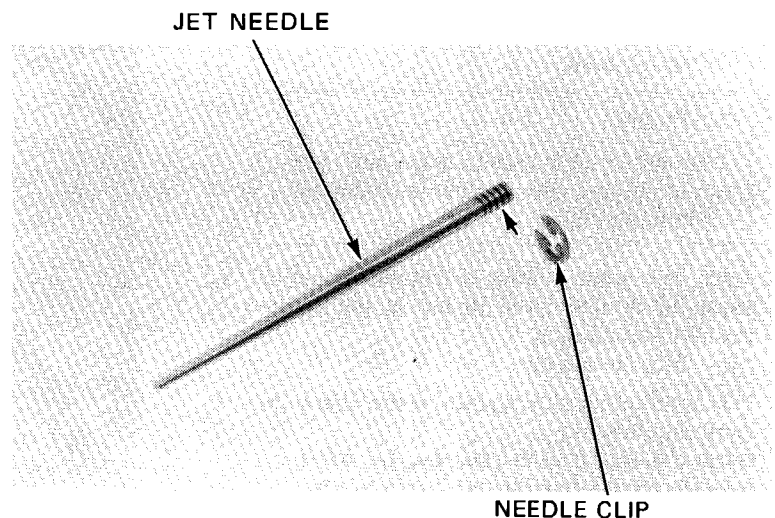

FUEL SYSTEM

Install the throttle cable and spring into the throttle valve.

Install the throttle valve into the carburetor body aligning the groove on the valve with the pin in the carburetor.

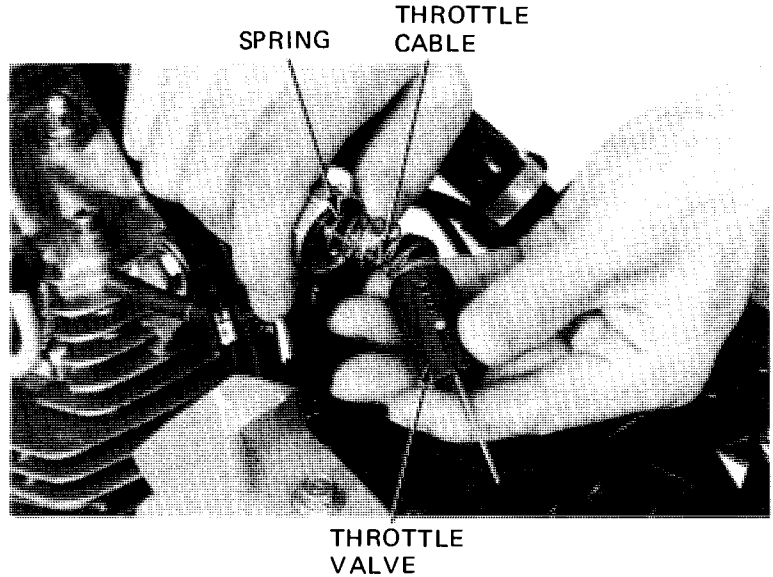

CARBURETOR INSTALLATION

Carburetor installation is essentially the reverse of removal.

NOTE

- After installing the carburetor, perform the following adjustments:
Throttle lever free play (Page 3-7).
Carburetor pilot screw adjustment (Page 4-13), if the carburetor was overhauled.

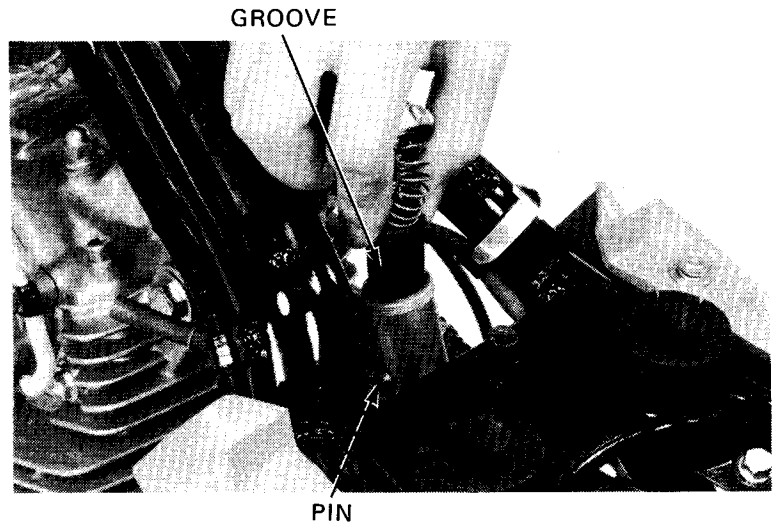

PILOT SCREW ADJUSTMENT

NOTE

The pilot screw is factory pre-set. Adjustment is not necessary unless the carburetor is overhauled or a new pilot screw installed.

CAUTION:

Damage to the pilot screw seat will occur if the pilot screw is tightened against the seat.

Turn the pilot screw clockwise until it seats lightly and back it out to the specification listed below :

2 ¼ turns out.

This is an initial setting prior to the final pilot screw adjustment.

Warm the engine up to operating temperature. Stop the engine and connect a tachometer.

Start the engine and adjust the idle speed with the throttle stop screw.

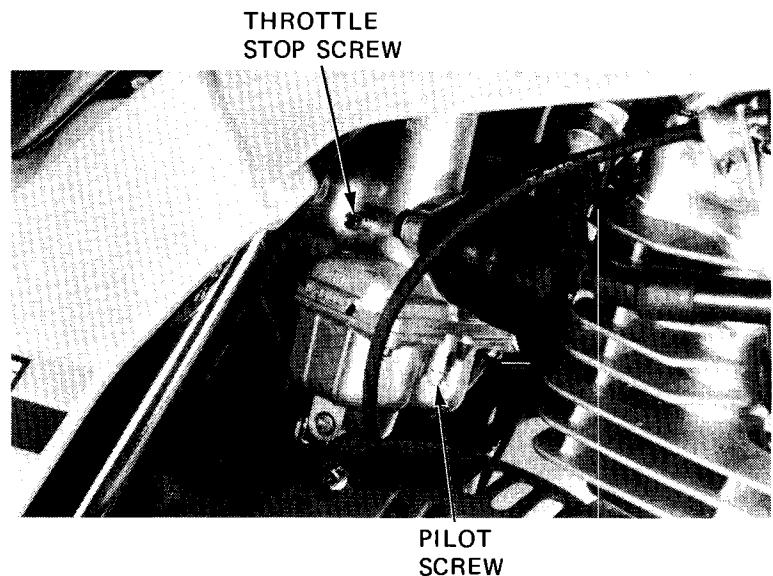

IDLE SPEED: 1,400 ± 100 rpm

Turn the pilot screw clockwise slowly until the engine stops, and then back it out 1 turn. Start the engine and readjust the idle speed with the throttle stop screw, if necessary.

HIGH ALTITUDE ADJUSTMENT

The carburetor must be adjusted for high altitude riding (above 6,000 ft/1,800 m).

STANDARD SETTING: 6,000 ft (1,800 m) max.

HIGH ALTITUDE SETTING: 5,000 ft (1,500 m) min.

High altitude carburetor adjustment is performed as follows:

Remove and disassemble the carburetor (Page 4-7 and 4-9).

Replace the standard main jet with the high altitude type (#90).

Assemble and install the carburetor.

Start the engine and adjust the idle speed at high altitude to ensure proper high altitude operation.

CAUTION:

Sustained operation below 5,000 feet (1,500 m) with the high altitude settings may cause engine overheating and engine damage. Install the #100 main jet, return the pilot screw to the factory preset position, when riding below 5,000 feet (1,500m).

SPECIFICATIONS

| | Below 6,000 ft (1,800m) | Above 5,000 ft (1,500m) |
|---------------------|----------------------------|----------------------------|
| Main jet | No. 100 | No. 90 |
| Pilot screw opening | Factory preset | 1/4 turn in |

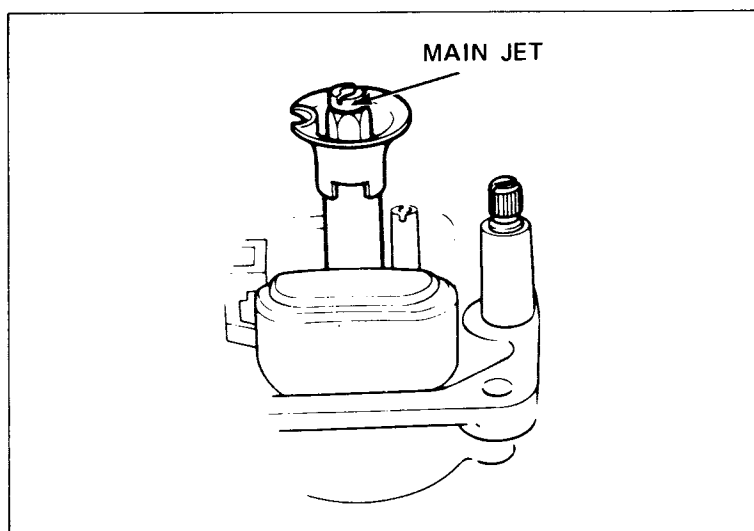

ENGINE REMOVAL/INSTALLATION

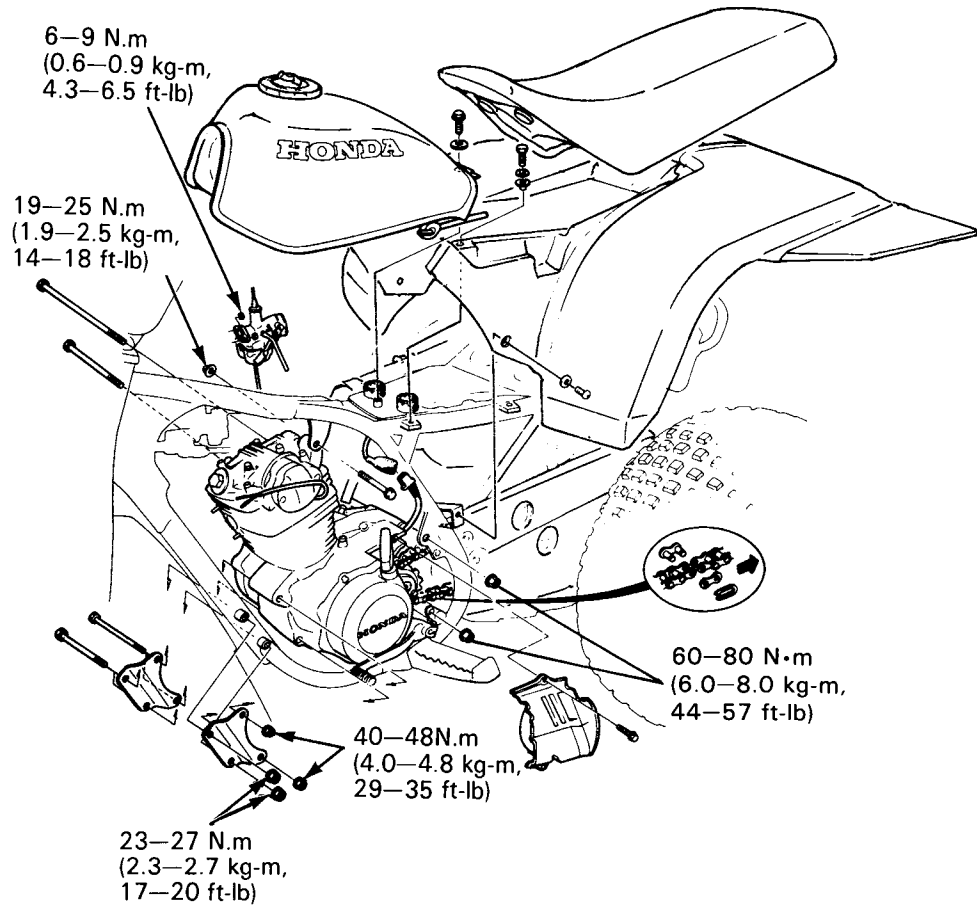
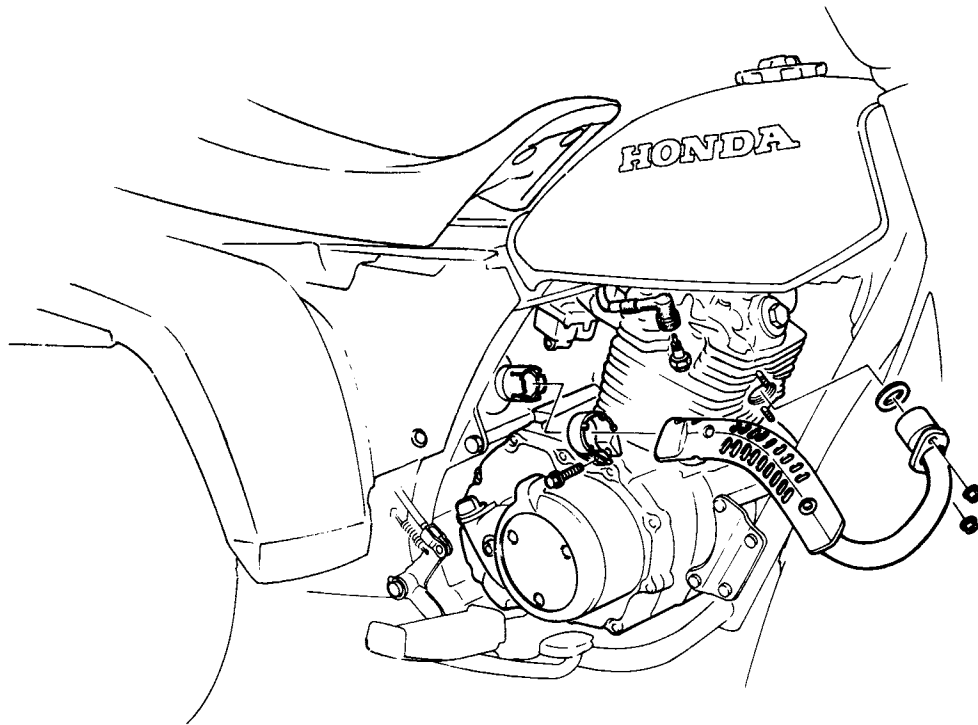

5. ENGINE REMOVAL/ INSTALLATION

| | |
|---------------------|-----|
| SERVICE INFORMATION | 5-1 |
| ENGINE REMOVAL | 5-2 |
| ENGINE INSTALLATION | 5-5 |

SERVICE INFORMATION

GENERAL

This section covers removal and installation of the engine.

Operations requiring engine removal:

- Cylinder head Section 6
- Cylinder and piston Section 7
- Crankshaft, transmission Section 10

Upon reassembly, make sure that no exhaust gas leaks past the exhaust pipe connection.

SPECIFICATIONS

| | |
|---------------------------------------|--|
| Engine dry weight (except carburetor) | 30.2 kg (66.6 lb) |
| Engine oil capacity | 1.35 lit (1.4 US qt, 1.1 Imp qt) at disassembly 0.95 lit (1.0 US qt, 0.8 Imp qt) after draining |

TORQUE VALUES

| | |
|-----------------------------------|---------------------------------------|
| Upper engine hanger nut | 19–25 N•m (1.9–2.5 kg-m, 14–18 ft-lb) |
| Front engine hanger 8 mm nut | 23–27 N•m (2.3–2.7 kg-m, 17–20 ft-lb) |
| 10 mm nut | 40–48 N•m (4.0–4.8 kg-m, 29–35 ft-lb) |
| Rear engine hanger lower 10mm nut | 60–80 N•m (6.0–8.0 kg-m, 44–57 ft-lb) |
| Upper 10 mm nut | 60–80 N•m (6.0–8.0 kg-m, 44–57 ft-lb) |
| Carburetor mounting nut | 6– 9 N•m (0.6–0.9 kg-m, 4– 7 ft-lb) |
| Rear axle bearing holder bolt | 50–70 N•m (5.0–7.0 kg-m, 36–51 ft-lb) |
| Carburetor insulator bolt | 8–12 N•m (0.8–1.2 kg-m, 6–9 ft-lb) |

ENGINE REMOVAL/INSTALLATION

ENGINE REMOVAL

Drain the oil from the engine (Page 2-2).
Remove the seat.
Turn the fuel valve OFF, disconnect the fuel tube and remove the fuel tank (Page 4-3).

Shift the transmission to neutral.

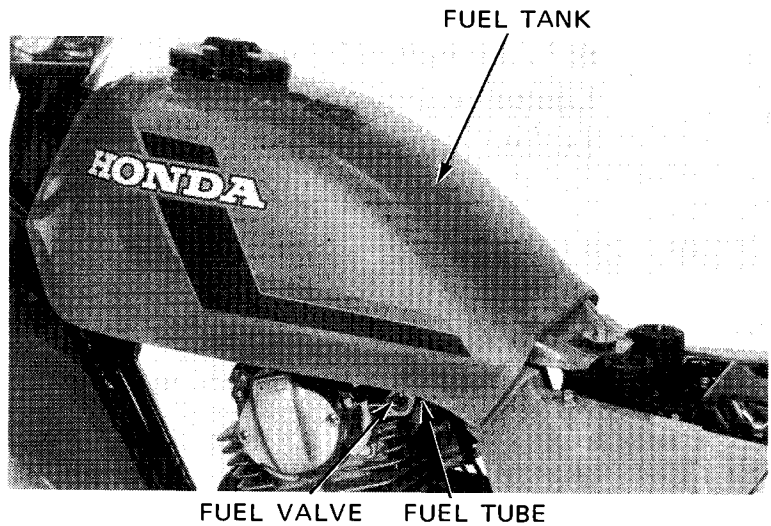

Remove the exhaust pipe.

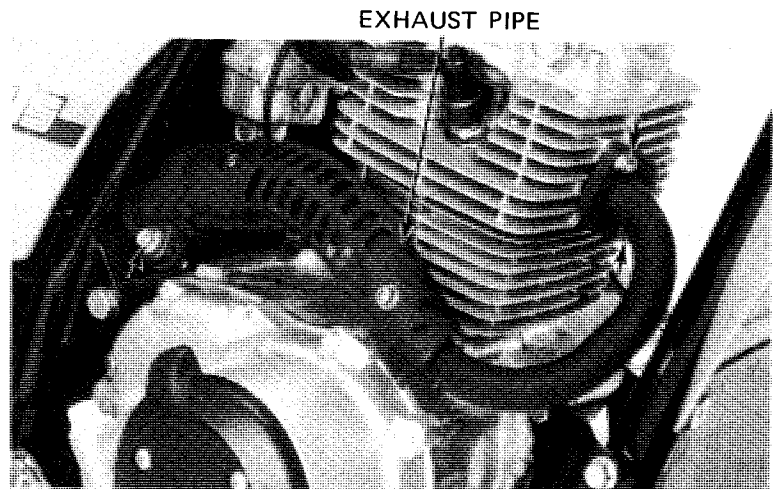

Disconnect the crankcase breather tube from the crankcase.
Disconnect the alternator coupler and pulse wires.

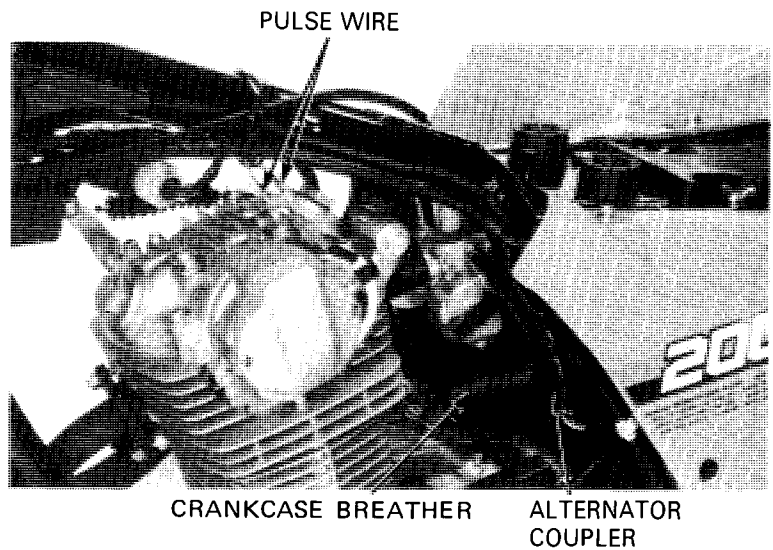

Remove the spark plug cap.
Remove the carburetor insulator bolts.

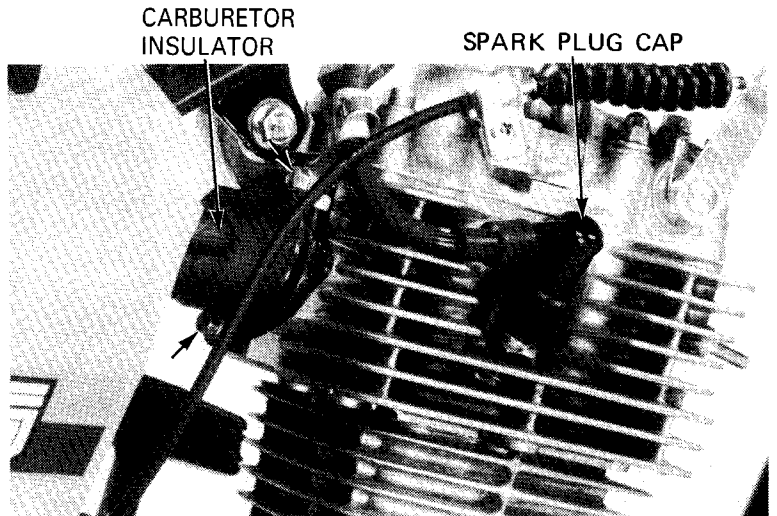

Remove the gearshift pedal.
Remove the drive sprocket cover.

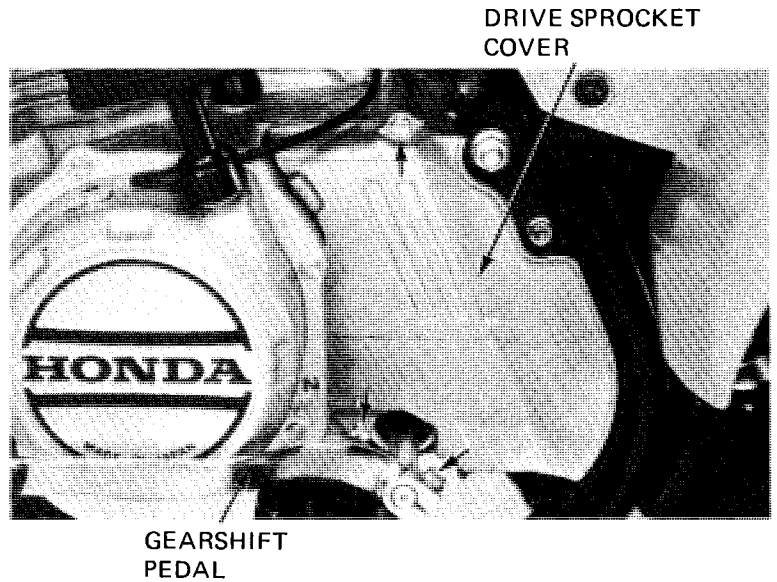

Loosen the rear wheel bearing holder attaching bolt and drive chain adjuster.
Move the rear wheel bearing holder forward.

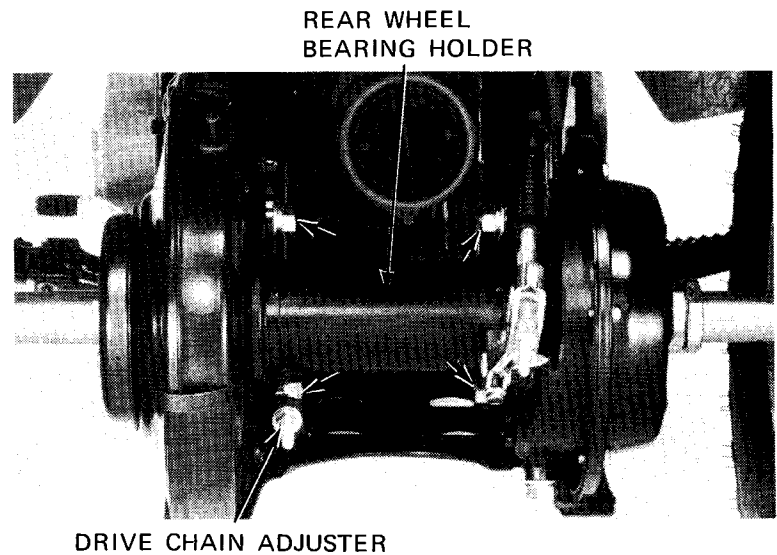

ENGINE REMOVAL/INSTALLATION

Remove the three drive sprocket mounting bolts; remove the drive sprocket retaining plate by turning it about 30° in either direction. Remove the drive sprocket with the drive chain.

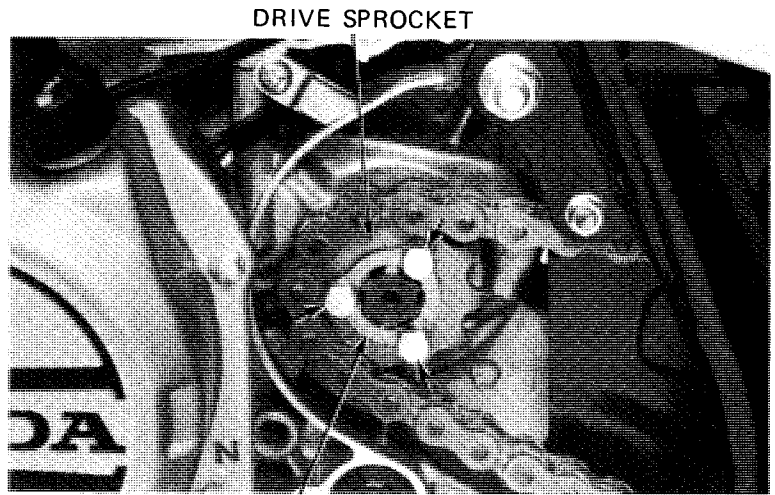

DRIVE SPROCKET

DRIVE SPROCKET
RETAINING PLATE

Remove the front engine hanger bolt and plates.

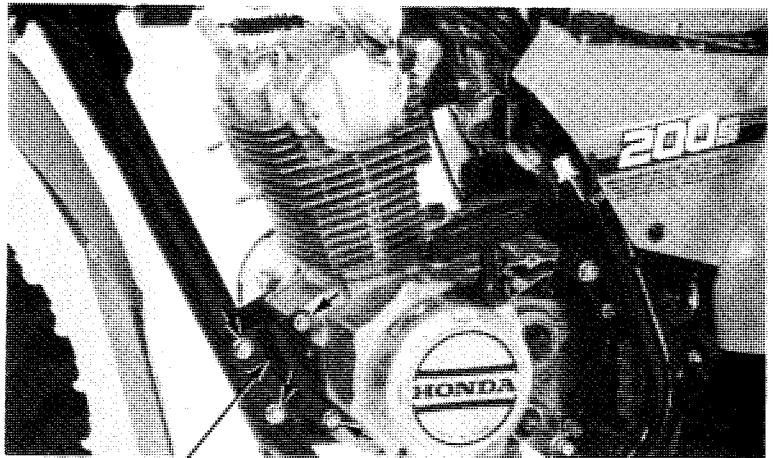

FRONT ENGINE
HANGER PLATE

Remove the upper engine hanger bolt.

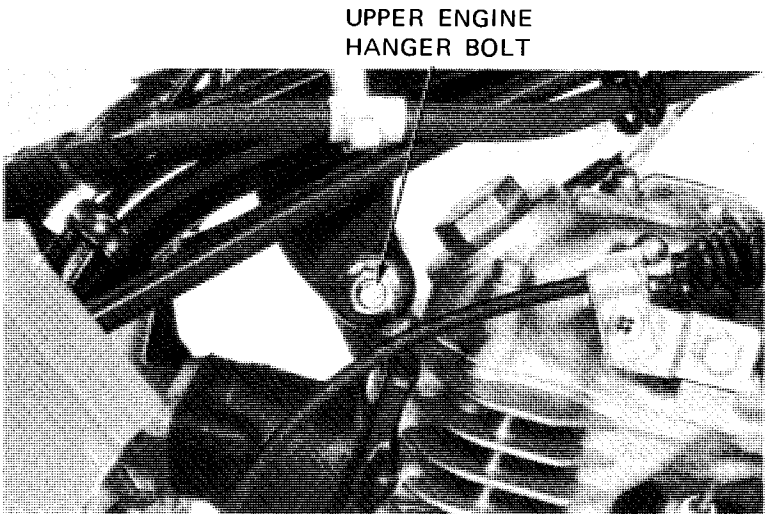

UPPER ENGINE
HANGER BOLT

ENGINE REMOVAL/INSTALLATION

Remove the rear engine hanger bolts.
Remove the engine from the left side of the frame.

REAR ENGINE
HANGER BOLTS

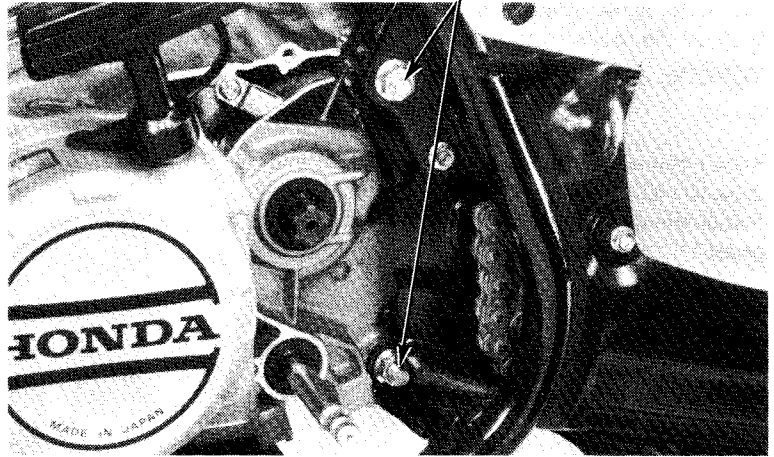

ENGINE INSTALLATION

Install the engine using the correct bolts in their proper positions.
Tighten the engine hanger bolts to the specified torque values after they are installed loosely.

8 mm BOLTS

8 mm BOLT

10 mm BOLT

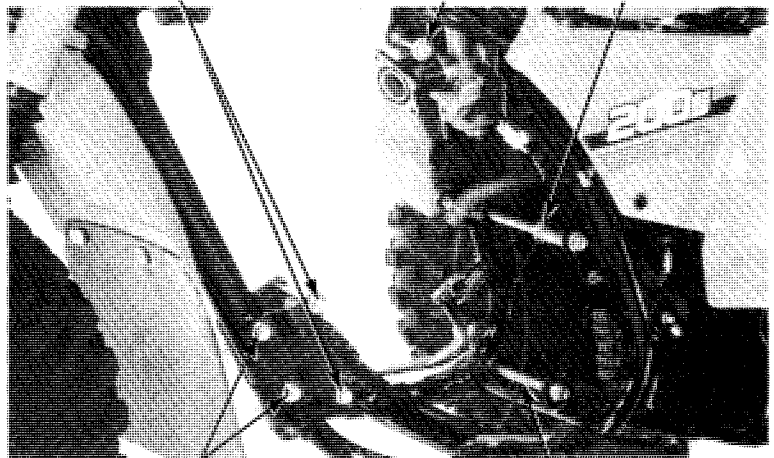

10 mm BOLTS

10 mm BOLT

23–27 N·m
(2.3–2.7 kg-m, 17–20 ft-lb)

19–25 N·m
(1.9–2.5 kg-m,
14–18 ft-lb)

60–80 N·m
(6.0–8.0 kg-m,
44–57 ft-lb)

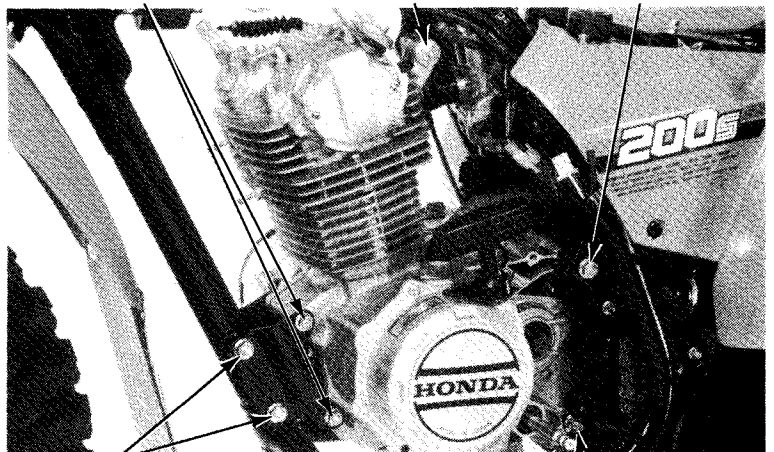

40–48 N·m
(4.0–4.8 kg-m, 29–35 ft-lb)

60–80 N·m
(6.0–8.0 kg-m, 44–57 ft-lb)

ENGINE REMOVAL/INSTALLATION

Install the carburetor insulator and tighten the bolts to the specified torque.

**TORQUE: 8–12 N·m (0.8–1.2 kg·m,
6–9 ft·lb)**

Install the drive sprocket, retaining plate and drive chain.

Install the drive sprocket cover and gear shift pedal.

Route and connect the alternator and pulse generator wires.

Connect the crankcase breather.

Connect the spark plug cap.

NOTE

After installing the engine, perform the following inspections and adjustments:

- Engine oil level (Page 2–2)
- Throttle lever free play (Page 3–7)
- Drive chain slack (Page 3–10)
- Check that exhaust gas is not leaking past the exhaust pipe connection
- Check the electrical equipment performance.

CARBURETOR INSULATOR

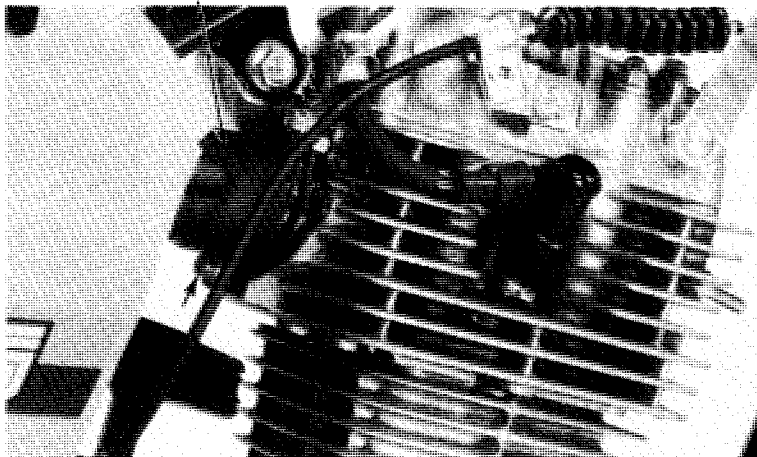



CYLINDER HEAD/VALVES

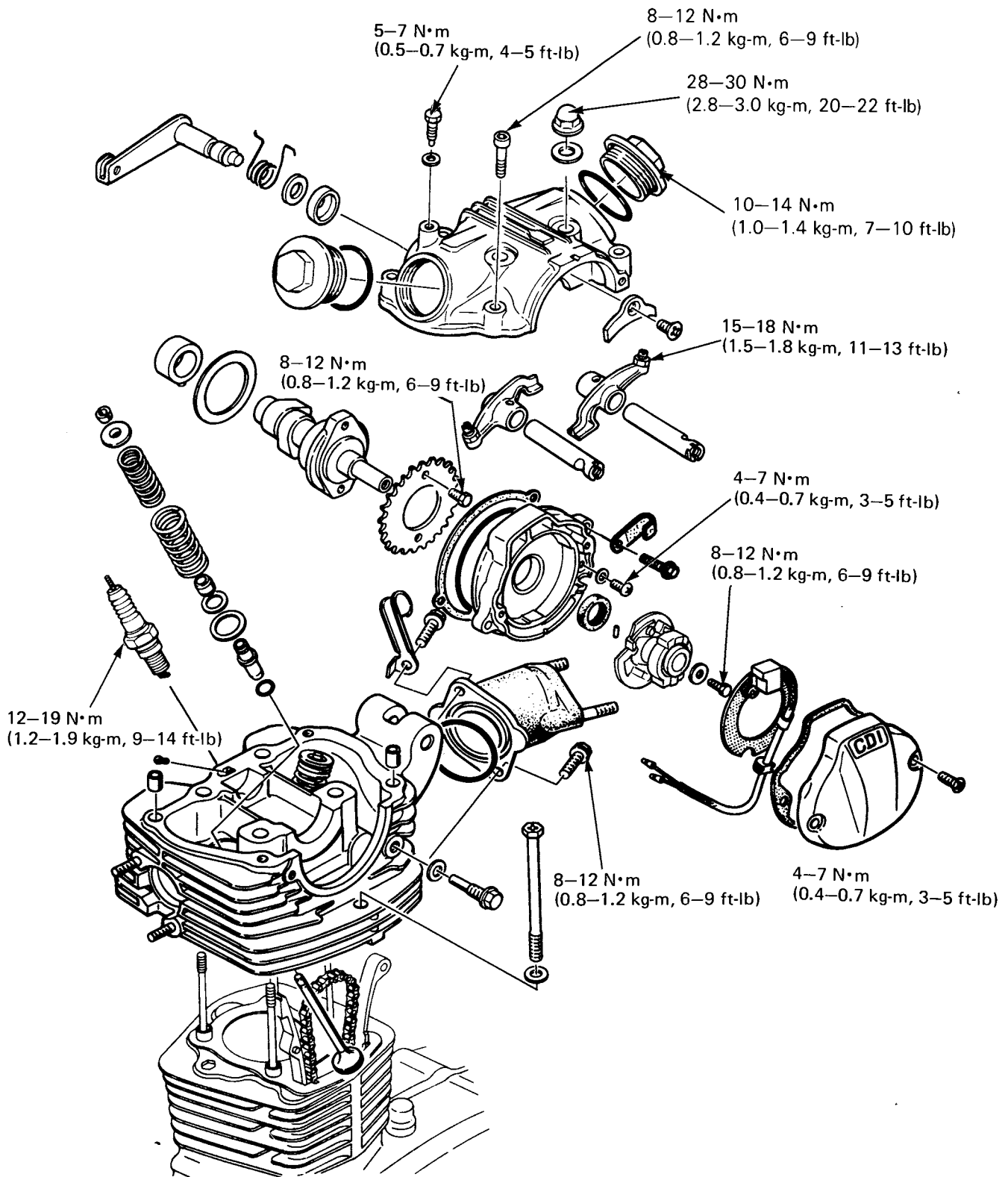

6. CYLINDER HEAD/ VALVES

| | | | |
|-----------------------------|-----|-------------------------------------|------|
| SERVICE INFORMATION | 6-1 | VALVE SEAT INSPECTION/REFACING | 6-12 |
| TROUBLE SHOOTING | 6-2 | CYLINDER HEAD ASSEMBLY | 6-14 |
| CAMSHAFT REMOVAL | 6-3 | CYLINDER HEAD INSTALLATION | 6-15 |
| CYLINDER HEAD COVER REMOVAL | 6-6 | CYLINDER HEAD COVER INSTALLATION | 6-16 |
| CYLINDER HEAD REMOVAL | 6-8 | CAMSHAFT INSTALLATION | 6-17 |
| CYLINDER HEAD DISASSEMBLY | 6-9 | | |

SERVICE INFORMATION

GENERAL

- This Section covers cylinder head, valves, camshaft and rocker arms maintenance.
- The engine must be removed from the frame to service the cylinder head and valves. (To remove the cylinder head cover or the rocker arm, engine removal is not required)
- Camshaft lubrication oil is fed to the cylinder head through an oil control orifice in the engine case. Be sure this orifice is not clogged and that the O-rings and dowel pins are in place before installing the cylinder head.
- Before assembly, apply molybdenum disulfide grease to the camshaft bearings to provide initial lubrication.
- Pour clean engine oil into the oil pockets in the cylinder head during assembly to lubricate the cam.

SPECIFICATIONS

| ITEM | | | STANDARD | | SERVICE LIMIT |
|-------------------------------|-------------------------|-------|--|-------------------------|-----------------------|
| Cylinder compression | | | 11 ± 1 kg/cm ² (156 ± 14 psi) | | |
| Camshaft | Cam lift | IN | 31.379 mm | (1.2354 in) | 31.199 mm (1.2283 in) |
| | | EX | 30.978 mm | (1.2196 in) | 30.798 mm (1.2125 in) |
| | Journal OD | R | 19.967–19.980 mm | (0.7861–0.7866 in) | 19.90 mm (0.784 in) |
| | | L | 33.957–33.970 mm | (1.3370–1.3376 in) | 33.90 mm (1.335 in) |
| Cylinder head | Bearing ID | L | 33.980–34.075 mm | (1.3378–1.3415 in) | 34.05 mm (1.341 in) |
| | Warpage | | | | 0.10 mm (0.004 in) |
| Camshaft bushing | ID | | 20.005–20.026 mm | (0.7876–0.7884 in) | 20.05 mm (0.789 in) |
| Rocker arm | ID | | 12.000–12.018 mm | (0.4724–0.4730 in) | 12.05 mm (0.474 in) |
| Rocker arm shaft | OD | | 11.977–11.995 mm | (0.4715–0.4722 in) | 11.93 mm (0.470 in) |
| Rocker arm-to-shaft clearance | | | 0.005–0.041 mm | (0.0002–0.0016 in) | 0.08 mm (0.003 in) |
| Valve spring | Free length | Inner | 39.4 mm | (1.55 in) | 35.5 mm (1.40 in) |
| | | Outer | 45.5 mm | (1.79 in) | 41.0 mm (1.61 in) |
| | Preload | Inner | 83.0 ± 0.6 kg/33.7 mm | (18.3 ± 1.3 lb/1.33 in) | |
| | | Outer | 21.0 ± 1.5 kg/38.4 mm | (46.3 ± 3.3 lb/1.51 in) | |
| Valve, valve guide | Stem OD | IN | 5.450–5.465 mm | (0.2146–0.2152 in) | 5.42 mm (0.213 in) |
| | | EX | 5.430–5.445 mm | (0.2138–0.2144 in) | 5.40 mm (0.213 in) |
| | Guide ID | IN | 5.475–5.485 mm | (0.2156–0.2159 in) | 5.50 mm (0.217 in) |
| | | EX | 5.475–5.485 mm | (0.2156–0.2159 in) | 5.50 mm (0.217 in) |
| | Stem-to-guide clearance | IN | 0.010–0.035 mm | (0.0004–0.0014 in) | 0.12 mm (0.005 in) |
| | | EX | 0.030–0.055 mm | (0.0012–0.0022 in) | 0.14 mm (0.006 in) |
| Valve face width | | | 1.7 mm (0.07 in) | 2.0 mm (0.08 in) | |
| Valve seat width | | | 1.2 mm (0.05 in) | 1.5 mm (0.06 in) | |

CYLINDER HEAD/VALVES

TORQUE VALUES

| | | |
|-------------------------|------------------|---------------------------------------|
| Cylinder head cover | 8 mm cap nut | 18–20 N•m (1.8–2.0 kg-m, 13–14 ft-lb) |
| | 6 mm socket bolt | 8–12 N•m (0.8–1.2 kg-m, 6– 9 ft-lb) |
| Cam sprocket | | 8–12 N•m (0.8–1.2 kg-m, 6– 9 ft-lb) |
| Carburetor insulator | | 8–12 N•m (0.8–1.2 kg-m, 6– 9 ft-lb) |
| Pulse rotor | | 8–12 N•m (0.8–1.2 kg-m, 6– 9 ft-lb) |
| Decompressor pivot bolt | | 5– 7 N•m (0.5–0.7 kg-m, 4– 5 ft-lb) |
| Valve adjuster cover | | 10–14 N•m (1.0–1.4 kg-m, 7–10 ft-lb) |
| Spark plug | | 12–19 N•m (1.2–1.9 kg-m, 9–14 ft-lb) |
| Pulse cover screw | | 4– 7 N•m (0.4–0.7 kg-m, 3– 5 ft-lb) |
| Pulse generator screw | | 4– 7 N•m (0.4–0.7 kg-m, 3– 5 ft-lb) |
| Valve adjuster lock nut | | 15–18 N•m (1.5–1.8 kg-m, 10–13 ft-lb) |

TOOLS

| | | |
|-----------------------------|--|--------------------------------|
| Special | | |
| Valve Guide Reamer, 5.48 mm | | 07984–0980000 |
| Common | | |
| Valve Guide Driver B | | 07742–0020200 ro 07942–3290200 |
| Valve Guide Remover, 5.5 mm | | 07742–0010100 or 07942–3290100 |
| Valve Spring Compressor | | 07757–0010000 or 07957–3290001 |

TROUBLESHOOTING

Engine top-end problems usually affect engine performance. These problems can be diagnosed by a compression test, or by tracing engine noises to the top-end with a sounding rod or stethoscope.

Low compression

1. Valves:
 - Incorrect valve adjustment.
 - Burned or bent valve.
 - Incorrect valve timing.
 - Weak valve spring.
2. Cylinder head:
 - Leaking or damaged head gasket.
 - Warped or cracked cylinder head.
3. Cylinder and piston (Section 7)
4. Faulty decompressor lever.

High compression

- Excessive carbon build-up on piston crown or on combustion chamber.

Excessive noise

1. Incorrect valve adjustment.
2. Sticking valve or broken valve spring.
3. Damaged or worn rocker arm or camshaft.
4. Worn or damaged cam chain.
5. Worn or damaged cam chain tensioner.
6. Worn cam sprocket teeth.

Poor idling

1. Compression too low.
2. Faulty decompressor lever.

Hard starting

- Faulty decompressor lever.

CAMSHAFT REMOVAL

Remove the pulse cover.

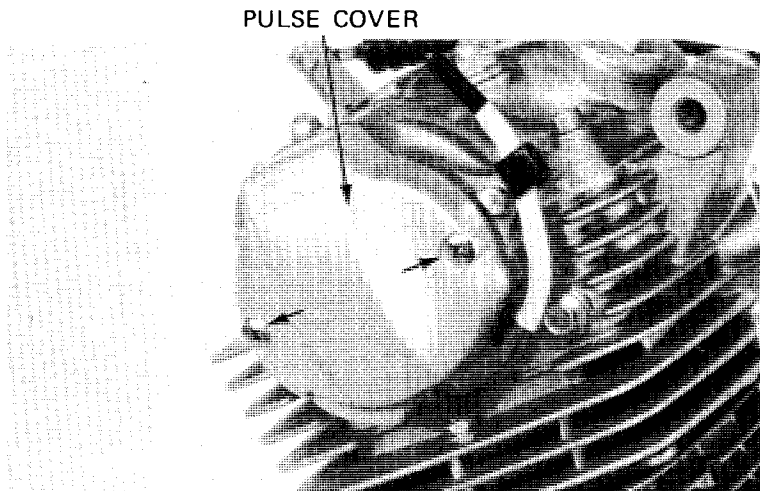

PULSE COVER

Remove the pulse generator screws, and remove pulse generator.

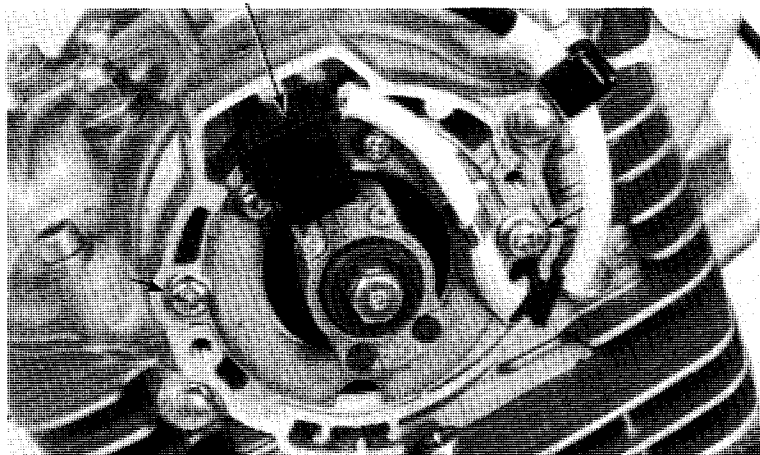

PULSE GENERATOR

Remove pulse rotor by removing the bolt and washer.
Remove the dowel pin and pulse base.

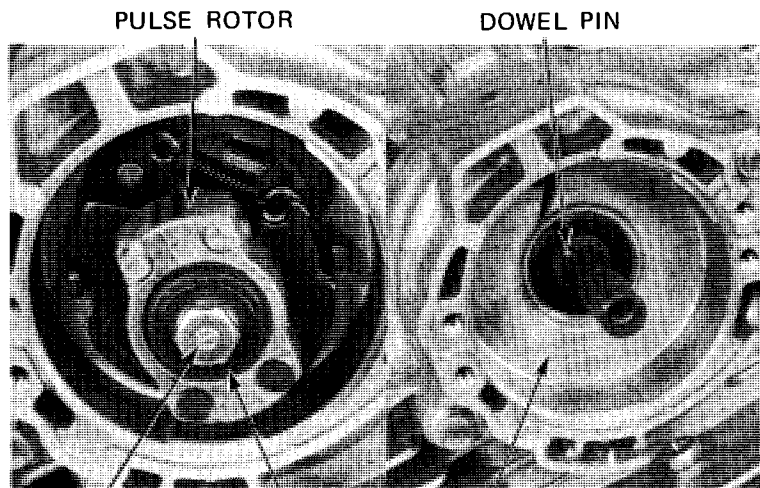

PULSE ROTOR

DOWEL PIN

BOLT

WASHER

PULSE BASE

CYLINDER HEAD/VALVES

Remove the cam chain tensioner adjusting bolt rubber cap.
Remove the check bolt and loosen the tensioner adjusting bolt.

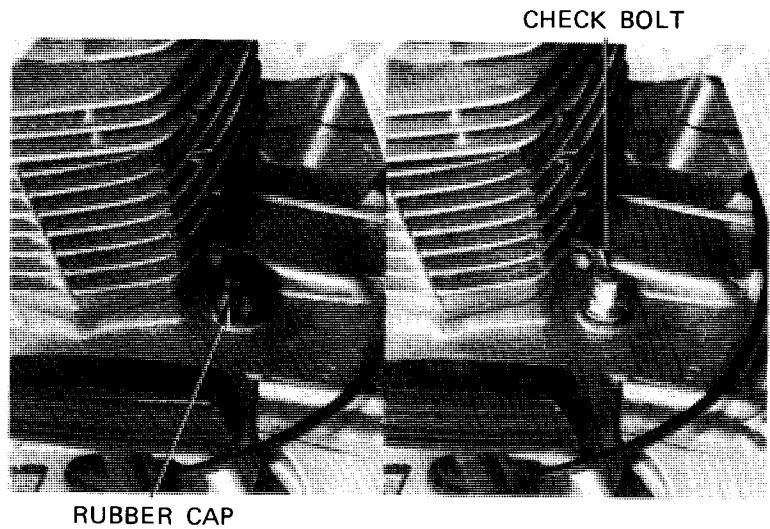

Push the tensioner down with a screwdriver as shown, while tightening the adjusting bolt.
Install the check bolt and rubber cap.

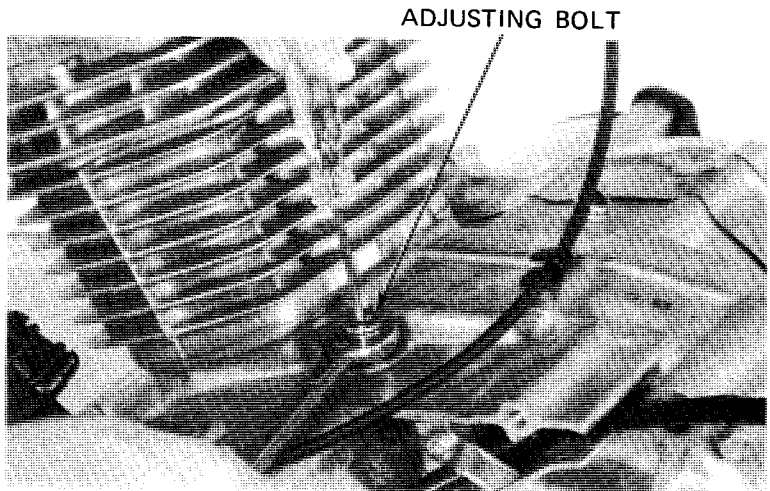

Remove the timing mark hole cap.
Turn the crankshaft with the recoil starter until the cam sprocket "O" mark and cylinder head index mark align.
Remove the cam sprocket bolts and cam sprocket.

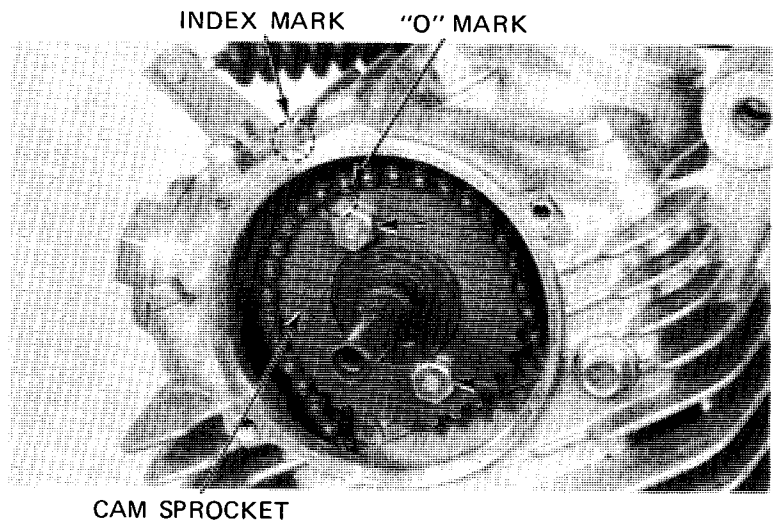

Remove the camshaft.
Suspend the cam chain with a piece of wire to prevent it from falling into the crankcase.

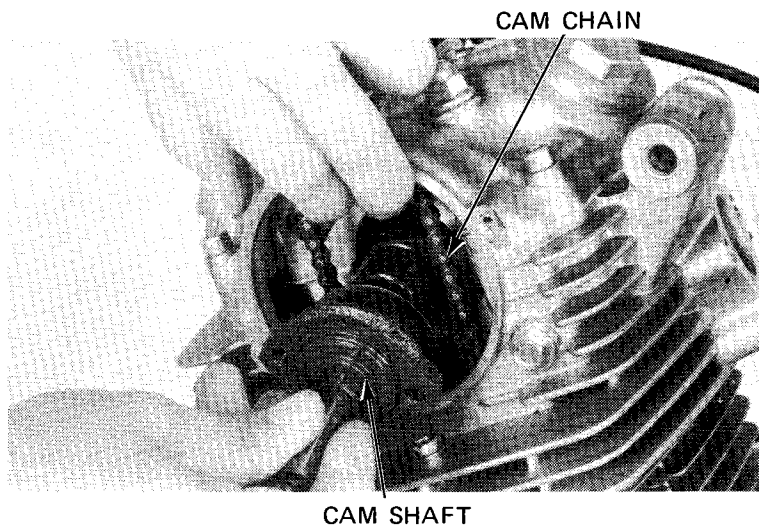

CAMSHAFT INSPECTION

Measure the camshaft O. D. with a micrometer.

- SERVICE LIMITS:**
R: 19.90 mm (0.784 in)
L: 33.90 mm (1.335 in)

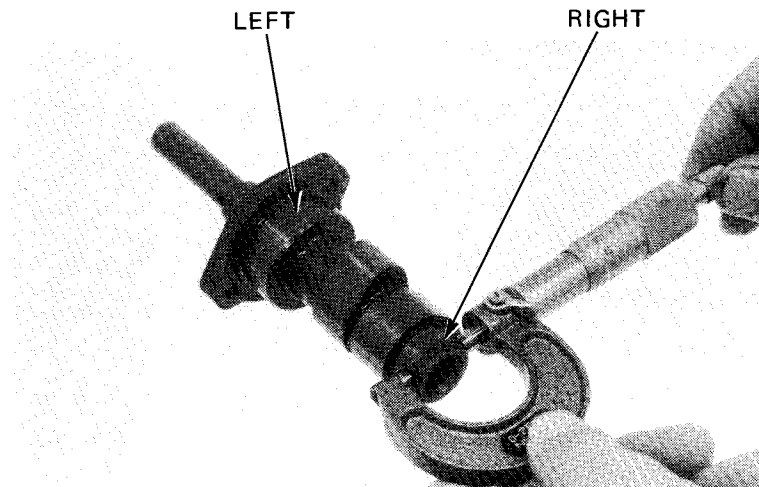

Using a micrometer, measure the height of each cam lobe height and inspect it for wear or damage.

- SERVICE LIMIT:**
INTAKE: 31.199 mm (1.2283 in)
EXHAUST: 30.798 mm (1.2125 in)

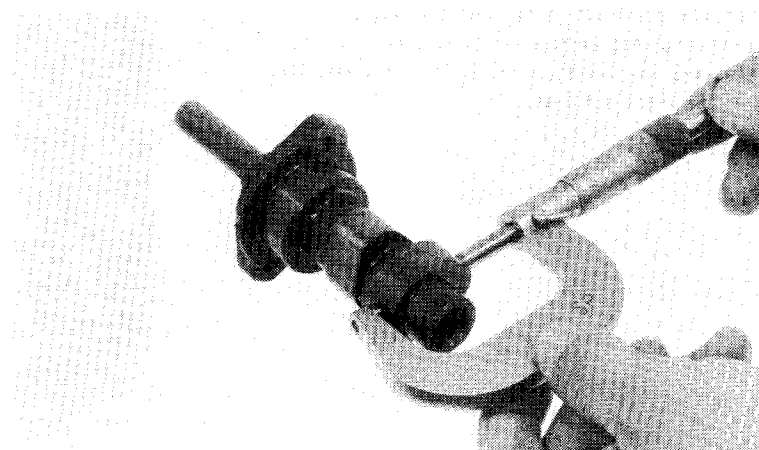

CYLINDER HEAD COVER REMOVAL

Remove the decompression cable from the valve lifter.
Loosen the cable clamp and remove the cable.
Remove the 6 mm socket bolts and 8 mm cap nuts.
Remove the cylinder head cover.

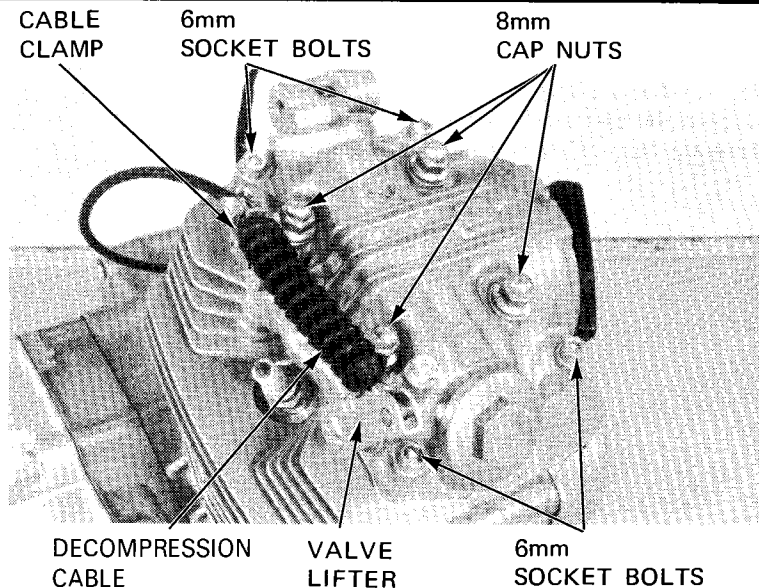

Remove the camshaft bushing and dowel pins.

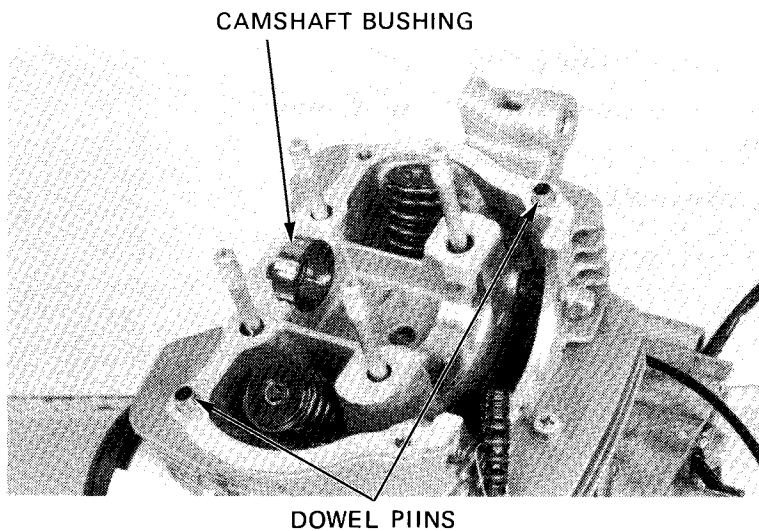

Remove the rocker arm shaft set plate.
Screw a 6 mm bolt into the rocker arm shaft threaded end. Pull on the bolt to remove the shafts and rocker arms.

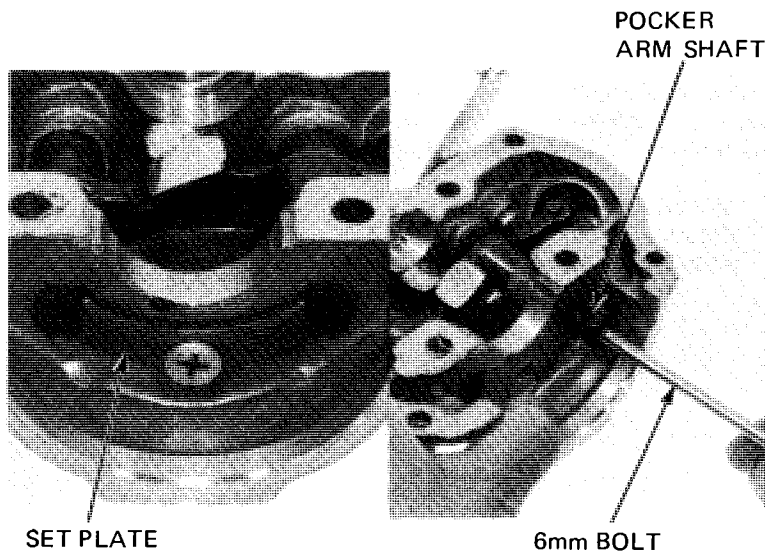

Remove the valve lifter and spring by removing the valve lifter guide bolt.

Remove the cable clamp.

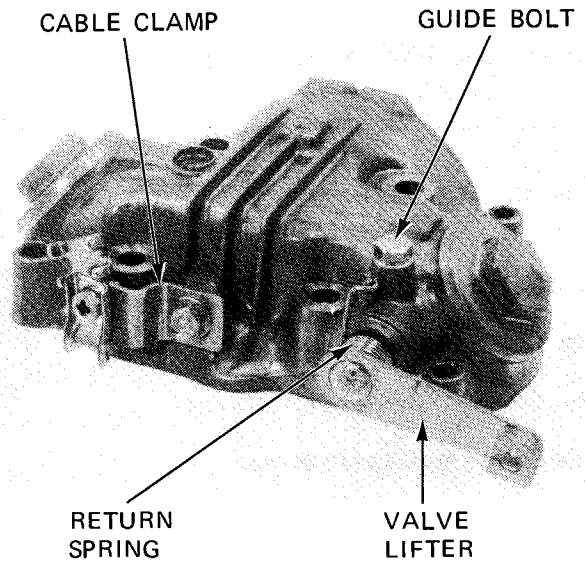

**VALVE LIFTER INSPECTION/
OIL SEAL REPLACEMENT**

Inspect the valve lifter and return spring for wear or damage.

Remove the oil seal from the cylinder head cover and press in a new oil seal.

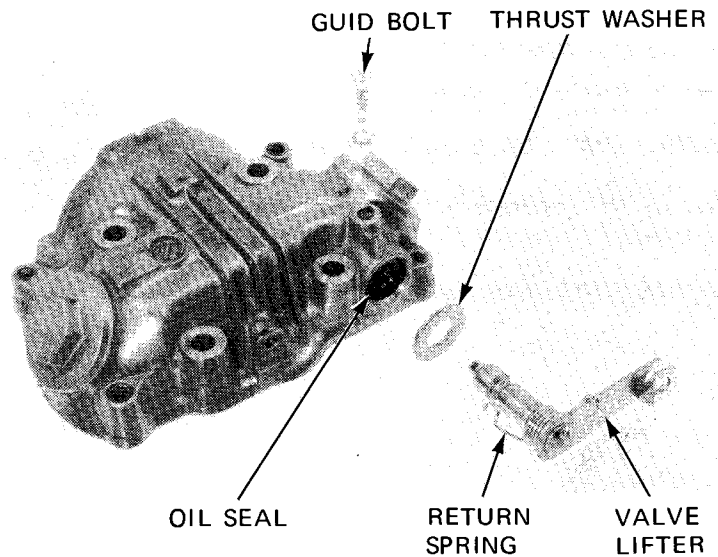

**ROCKER ARM / ROCKER ARM
SHAFT INSPECTION**

Inspect the rocker arms for damage, wear or clogged oil holes.

NOTE

If any rocker arms require servicing or replacement, inspect the cam lobes for scoring, chipping or flat spots.

Measure the I. D. of each rocker arm.

SERVICE LIMIT:
12.05 mm (0.474 in)

Inspect the rocker arm shafts for wear or damage.

Measure the O. D. with a micrometer.

SERVICE LIMIT:
11.93 mm (0.470 in)

Calculate the rocker arm-to-shaft clearance.

SERVICE LIMIT:
0.08 mm (0.003 in)

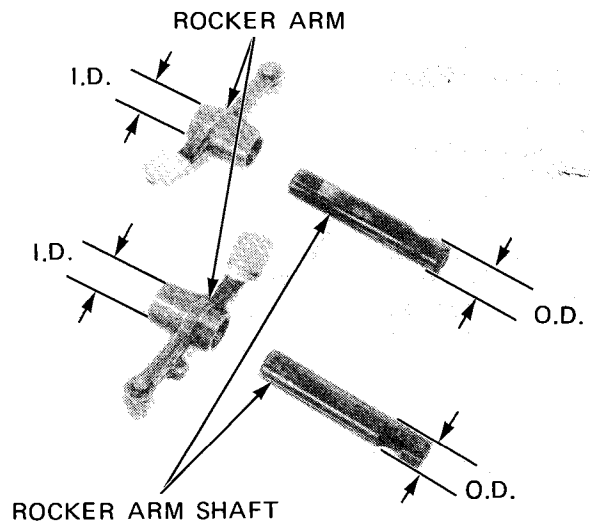

CYLINDER HEAD/VALVES

CAMSHAFT BEARING INSPECTION

Install the cylinder head cover with 8 mm nuts.

**TORQUE: 18–20 N·m (1.8–2.0 kg-m,
13–14 ft-lb)**

Measure the camshaft bearing I.D.

SERVICE LIMIT: 34.05 mm (1.341 in)

Calculate the camshaft-to-bearing clearance.

SERVICE LIMIT: 0.10 mm (0.004 in)

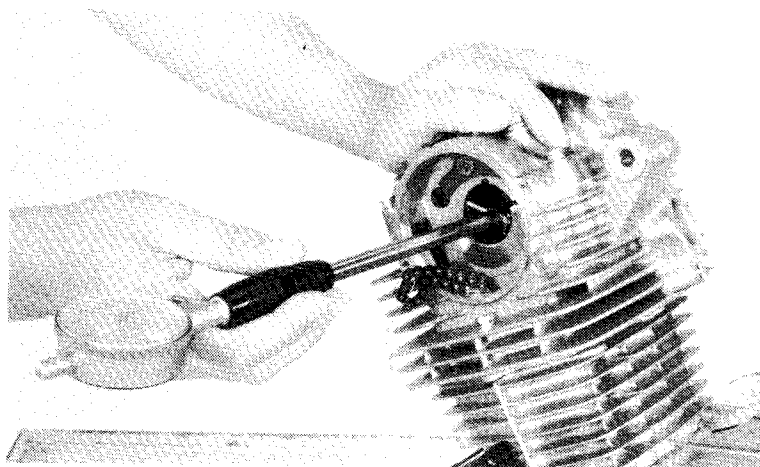

CAMSHAFT BUSHING INSPECTION

Measure the camshaft bushing I.D.

SERVICE LIMIT: 20.05 mm (0.789 in)

Calculate the camshaft bushing-to-camshaft clearance.

SERVICE LIMIT: 0.08 mm (0.003 in)

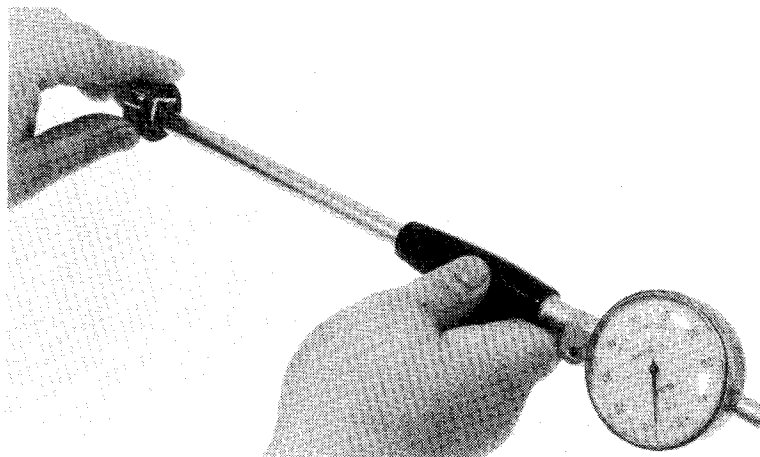

CYLINDER HEAD REMOVAL

Remove the cylinder head cover (Page 6–6).

Remove the cam chain tensioner bolt, cylinder head bolts and cylinder head.

NOTE

To prevent the cam chain from dropping into the crankcase, the cam chain should be held by a piece of wire.

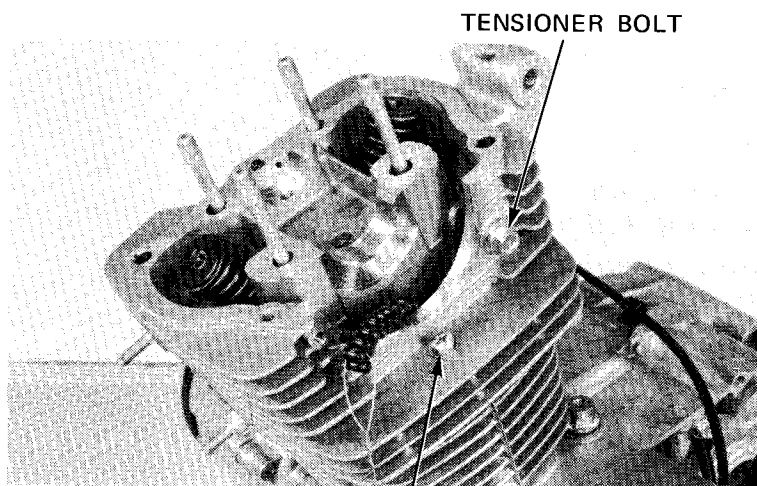

CYLINDER
HEAD BOLT

CYLINDER HEAD DISASSEMBLY

Remove the valve cotters, spring retainers and valve springs with a valve spring compressor.

VALVE SPRING COMPRESSOR
07757-001000
OR 07957-3290001

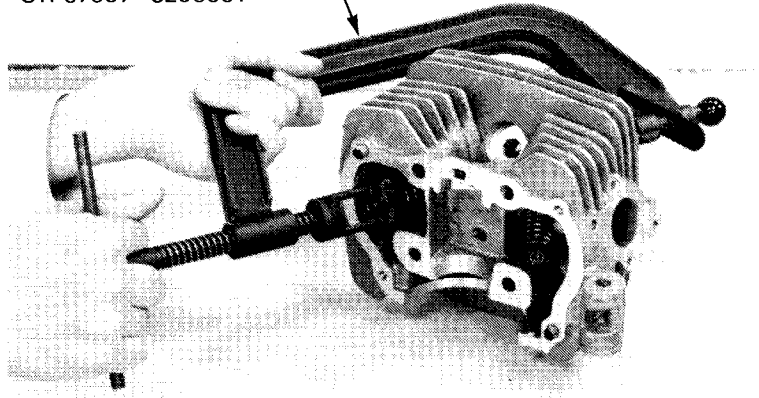

Remove carbon deposits from the combustion chamber.
Clean off any gasket material from the cylinder head surface.

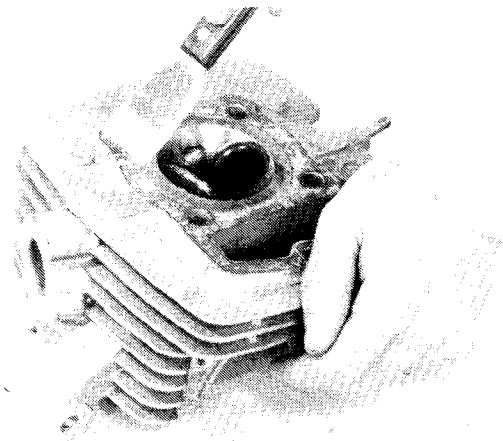

CYLINDER HEAD INSPECTION

Check the spark plug hole and valve area for cracks.
Check the cylinder head diagonally for warpage with a straight edge and feeler gauge.

SERVICE LIMIT:
0.10 mm (0.004 in)

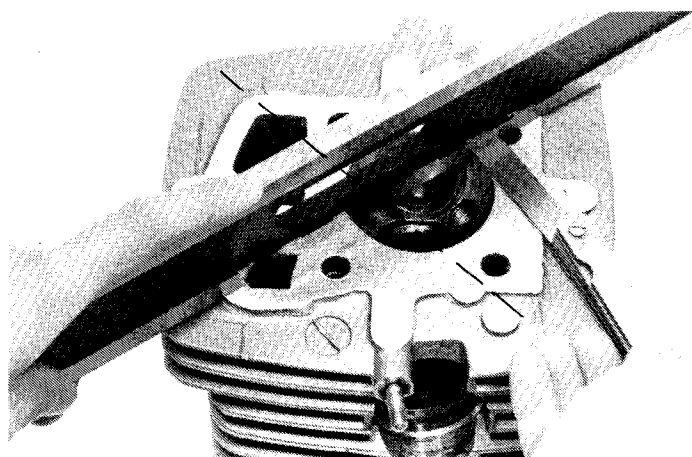

CYLINDER HEAD/VALVES

VALVE SPRING INSPECTION

Measure the free length of the inner and outer valve springs.

SERVICE LIMITS:

INNER: 35.5 mm (1.40 in)

OUTER: 41.0 mm (1.61 in)

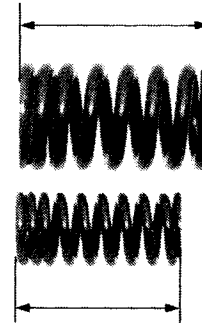

VALVE/VALVE GUIDE INSPECTION

Inspect each valve for trueness, burning, scratches or abnormal stem wear.
Check the valve movement in the guide.
Measure and record each valve stem O.D.

SERVICE LIMITS:

INTAKE: 5.42 mm (0.213 in)

EXHAUST: 5.40 mm (0.213 in)

Ream the guides to remove any carbon build up before checking the valve guide I.D.
Measure and record the valve guide I.D.
Calculate the stem-to-guide clearance.

SERVICE LIMITS :

INTAKE : 0.12 mm (0.005 in)

EXHAUST : 0.14 mm (0.006 in)

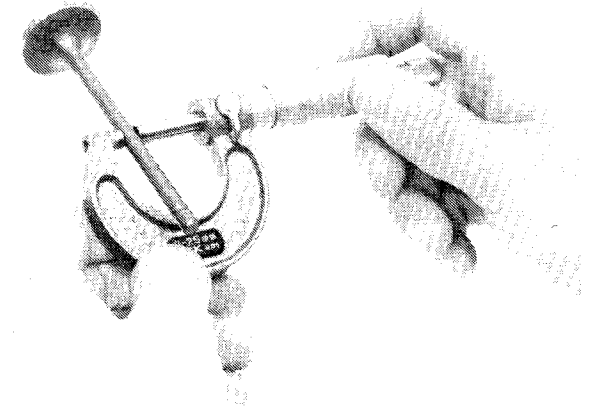

NOTE

- If the stem-to-guide clearance exceeds the service limit, determine if a new guide with standard dimensions would bring the clearance within tolerance. If so, replace guides as necessary and ream to fit.
- If the valve guide is replaced, the valve seat must be refaced.

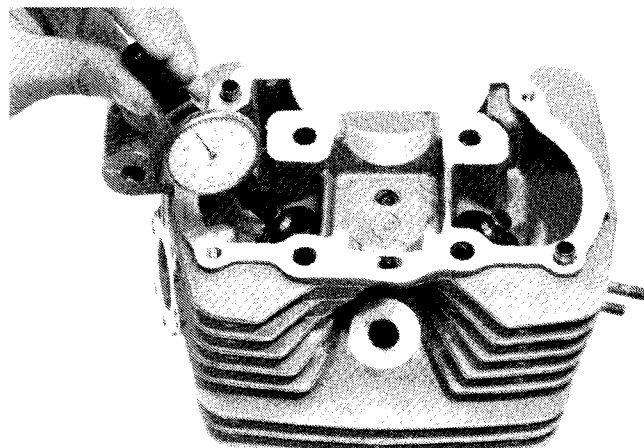

VALVE GUIDE REPLACEMENT

Support the cylinder head and drive out the guide from the valve port with a valve guide remover.

NOTE

When driving out the guide, be careful not to damage the head.

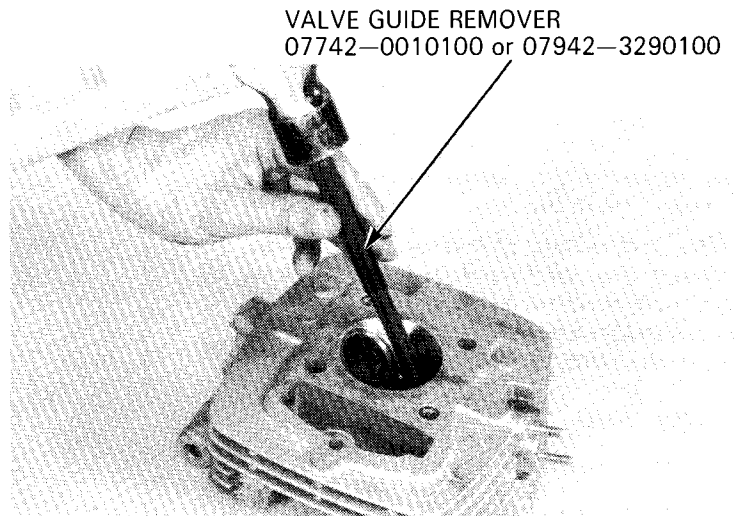

Install an O-ring on the new valve guide. Drive in the guide from the top of the head.

NOTE

Inspect the valve guide for damage.

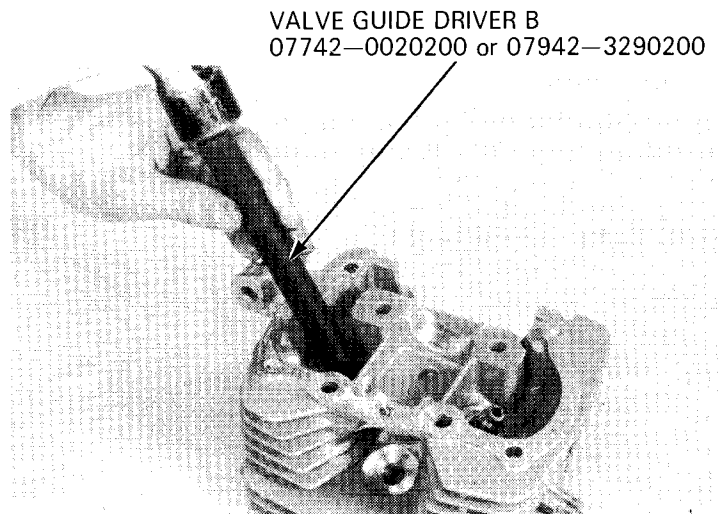

Ream the new valve guide after installation.

NOTE

- Use cutting oil on the reamer during this operation.
- Rotate the reamer when inserting and removing it.

Clean the cylinder head thoroughly to remove any metal particles.
Reface the valve seat.

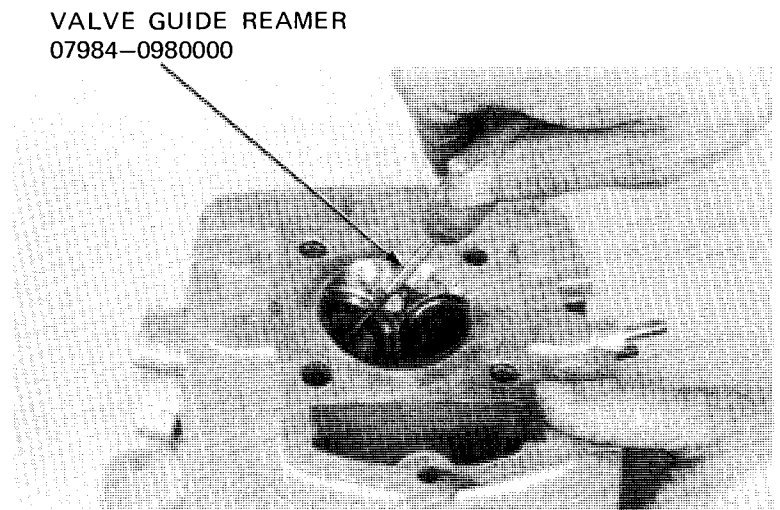

CYLINDER HEAD/VALVES

VALVE SEAT INSPECTION/REFACING

VALVE SEAT INSPECTION/REFACING

Clean all intake and exhaust valves thoroughly to remove carbon deposits.

Apply a light coating of Prussian Blue to each valve seat. Lap each valve and seat using a rubber hose or other hand-lapping tool.

Remove and inspect each valve.

Measure the width of the valve face.

SERVICE LIMIT: 2.0 mm (0.08 in)

CAUTION:

The valve cannot be ground. If the valve face is burned or badly worn or if it contacts the seat unevenly, replace the valve.

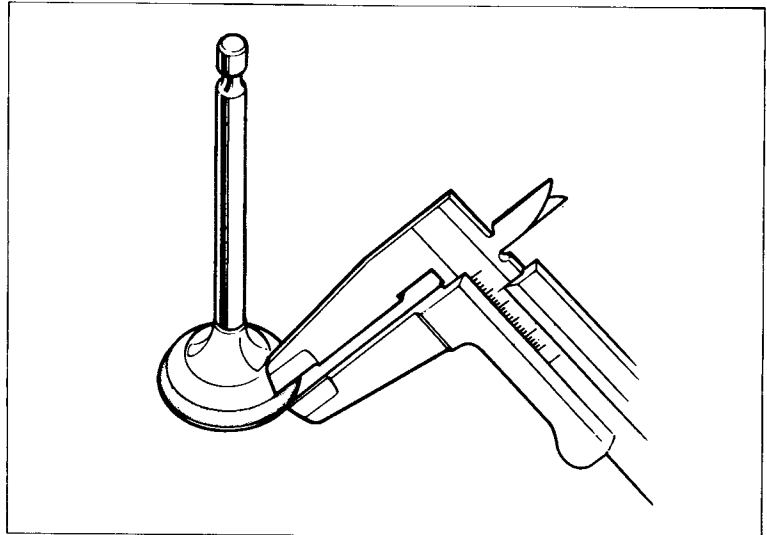

Inspect each valve seat.

If the seat is too wide, too narrow, or has low spots, the seat must be refinished to seal properly.

SERVICE LIMIT: 1.5 mm (0.06 in)

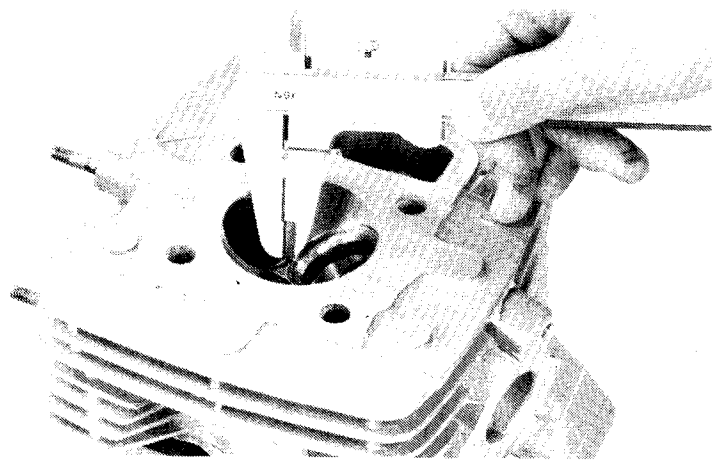

VALVE SEAT GRINDING

Honda Valve Seat Cutters, grinder or equivalent valve seat refacing equipment are recommended to correct a worn valve seat.

Follow the instructions supplied with the Valve Seat Refacing Equipment.

VALVE SEAT CUTTER

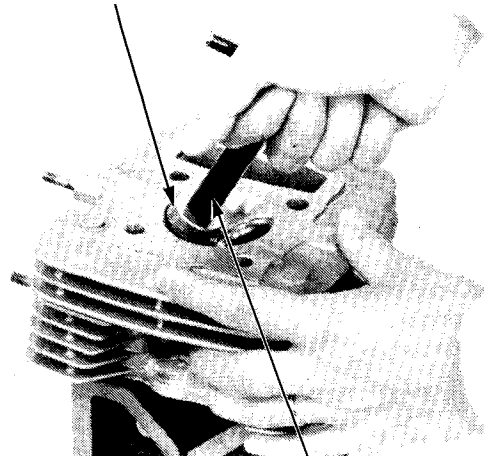

CUTTER HOLDER

Use a 45 degree cutter to remove any roughness or irregularities from the seat.

NOTE

Reface the seat with a 45 degree cutter when the valve guide is replaced.

Use a 32 degree cutter to remove 1/4 of the existing valve seat material.

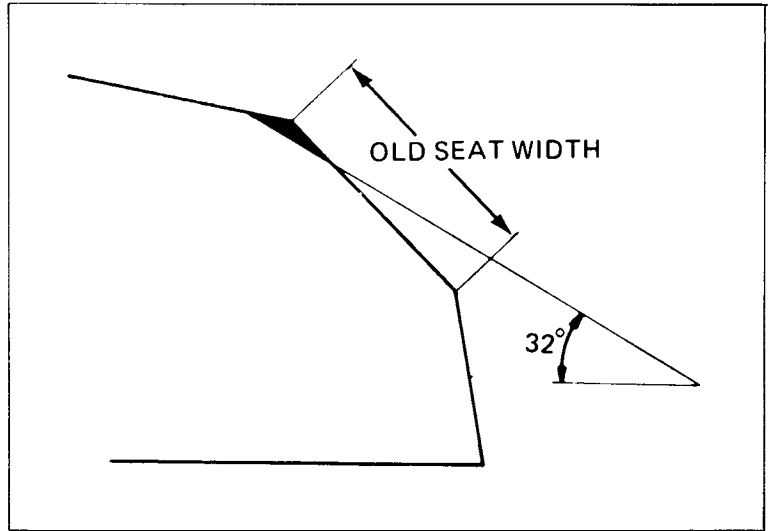

Use a 60 degree cutter to remove the lower 1/4 of the old seat. Remove the cutter and inspect the area you have just cut.

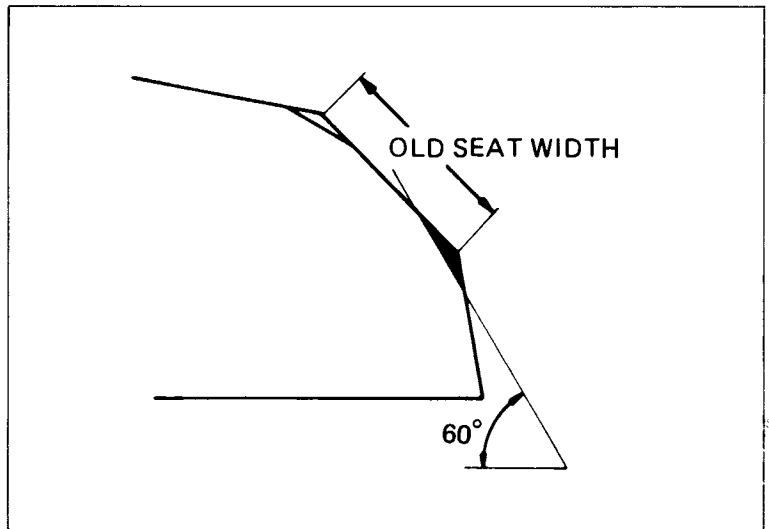

Install a 45 degree finish cutter and cut the seat to the proper width.

NOTE

Make sure that all pitting and irregularities are removed. Refinish if necessary.

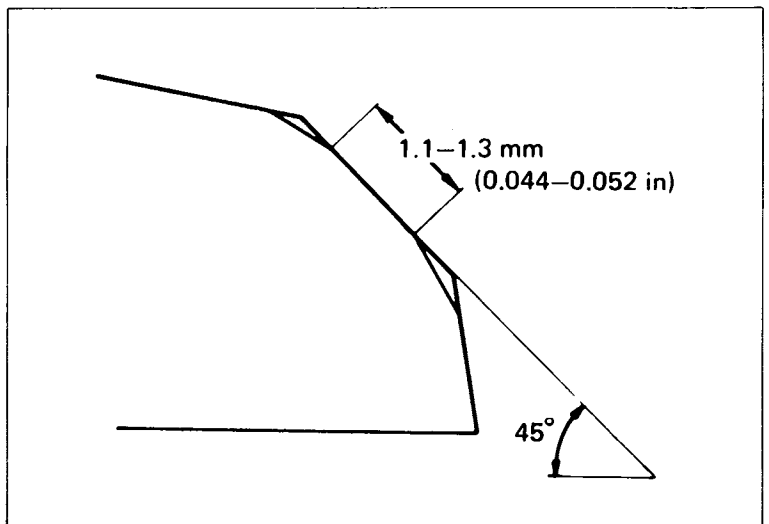

CYLINDER HEAD/VALVES

Apply a thin coating of Prussian Blue to the valve seat.

Press the valve through the valve guide and onto the seat without rotating it to make a clear pattern.

NOTE

The location of the valve seat in relation to the valve face is very important for good sealing.

If the contact area is too high on the valve, the seat must be lowered using a 32 degree flat cutter.

If the contact area is too low on the valve, the seat must be raised using a 60 degree inner cutter.

Refinish the seat to specifications using a 45 degree seat cutter.

After cutting the seat, apply lapping compound to the valve face and lap the valve using light pressure.

After lapping, wash all residual compound off the cylinder head and valve.

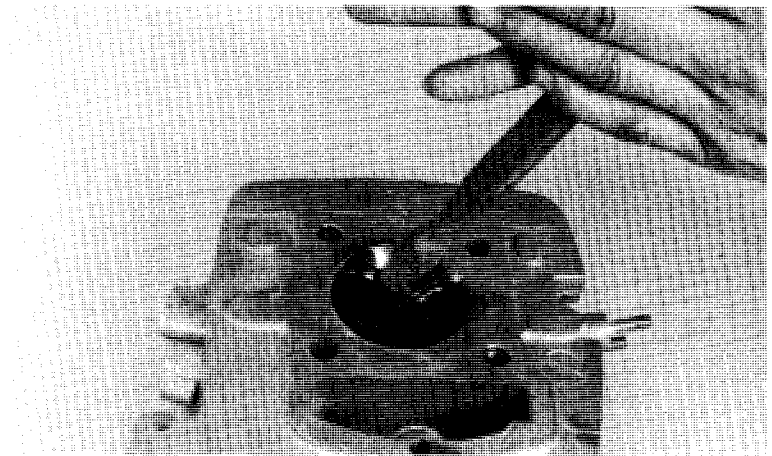
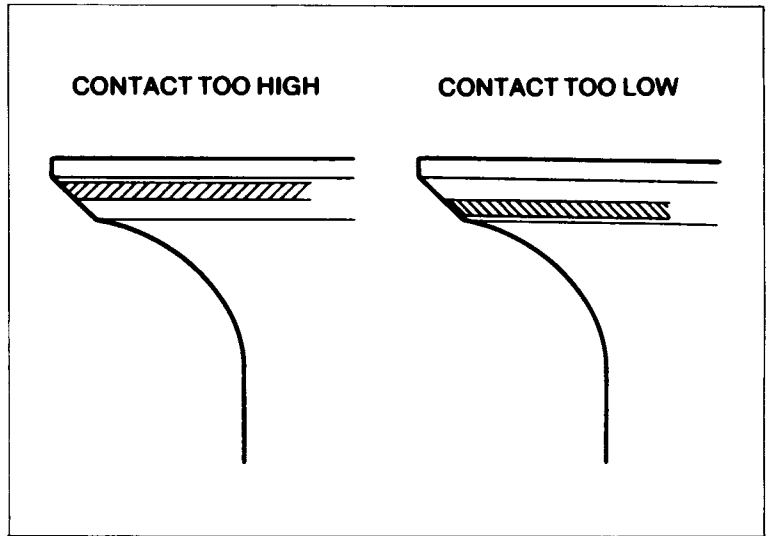

CYLINDER HEAD ASSEMBLY

Install new valve stem seals.

Lubricate each valve stem with oil and insert the valves into the valve guides.

Install the valve spring seats and valve springs with the tightly wound coils facing the cylinder head.

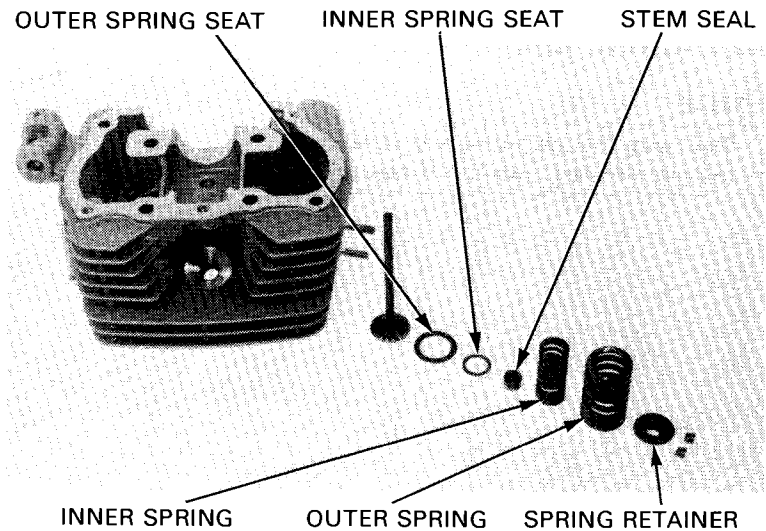

Install the valve spring retainers.
Install the valve cotters.

CAUTION:

To prevent loss of tension, do not compress the valve spring more than necessary.

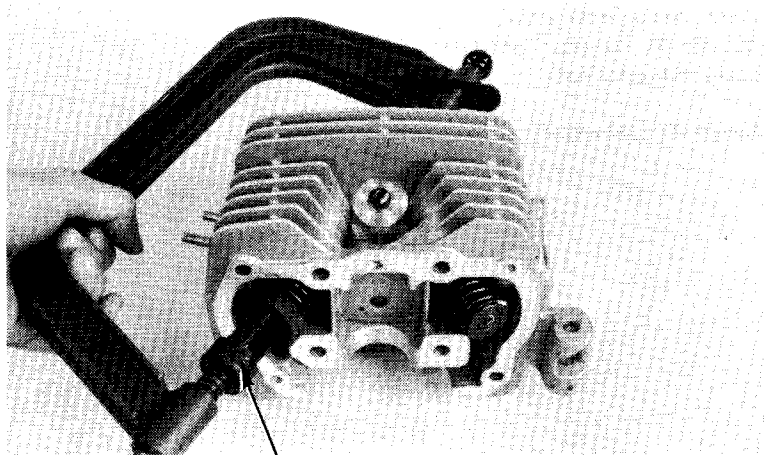

VALVE SPRING COMPRESSOR
07757-0010000 or 07957-3290001

Tap the valve stems gently with a plastic hammer to firmly seat the cotters.

CAUTION:

Support the cylinder head above the work bench surface to prevent possible valve damage.

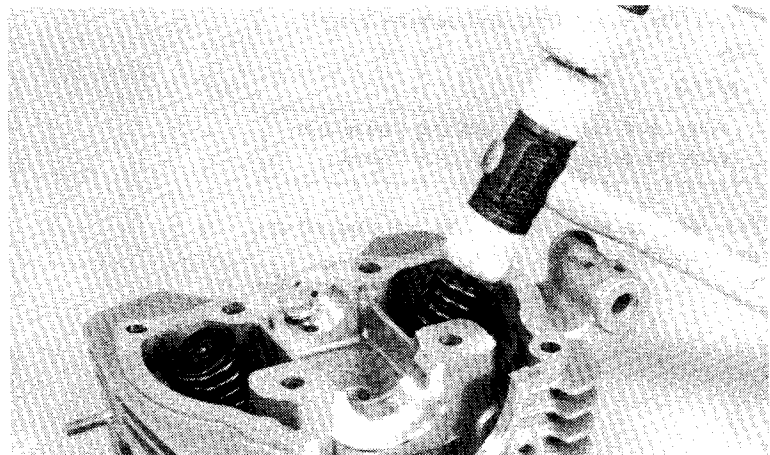

CYLINDER HEAD INSTALLATION

Clean off any gasket material from the cylinder surface.
Install the O-rings, dowel pins and a new gasket.

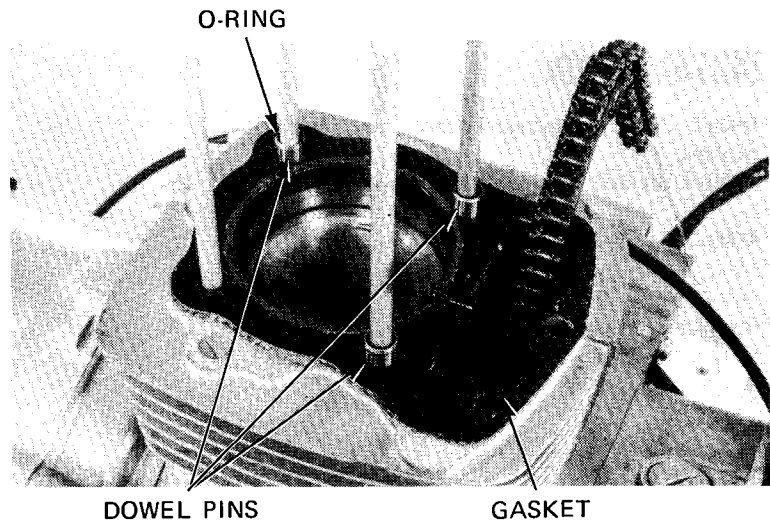

CYLINDER HEAD/VALVES

Install the cylinder head.
Install the cylinder head bolts and cam chain tensioner bolt.

Install the oil hole plug.

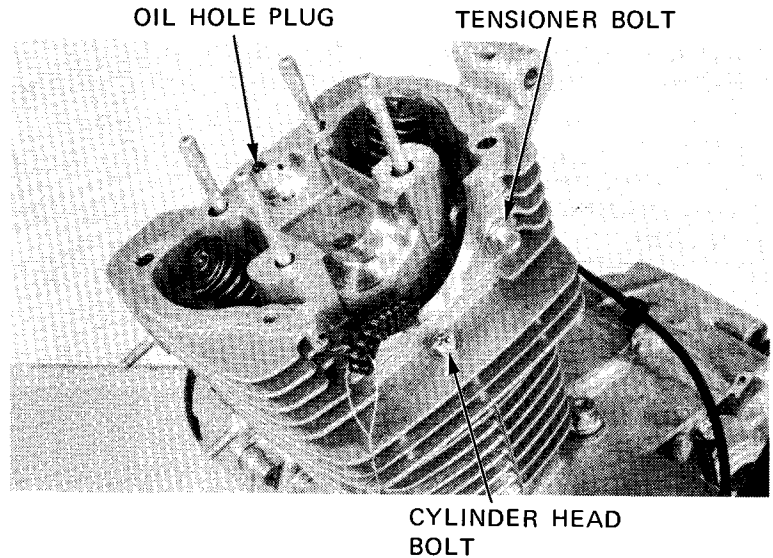

Install the dowel pins and camshaft bushings.

NOTE

Align the camshaft bushing dowel pin with the cutout in the cylinder head.

Pour oil into the cylinder head oil pockets so the cam lobes will be lubricated.

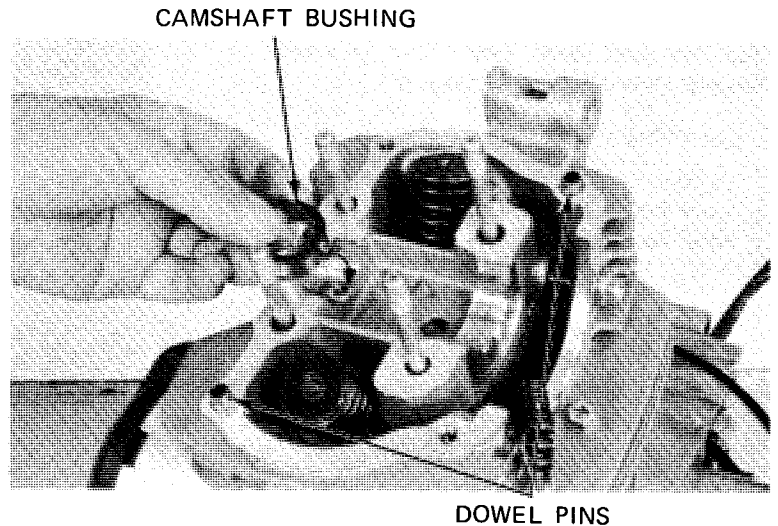

CYLINDER HEAD COVER INSTALLATION

Install the decompressor lever and thrust washer.
Tighten the decompressor lever pivot bolt.

**TORQUE: 5–7N·m (0.5–0.7 kg·m,
3.6–5.1 ft·lb)**

Install the return spring as shown.
Install the cable clamp and tighten the bolt securely.

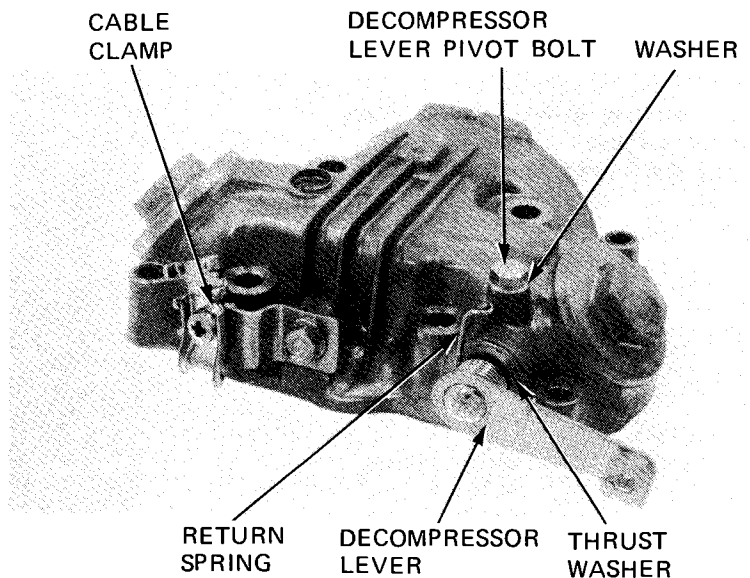

Install the rocker arms and rocker arm shafts in the cylinder head cover.
Install the set plate and tighten the set plate screw.

Loosen the valve adjusting screws.
Apply liquid sealant to the cylinder head cover mating surface.

NOTE

Keep sealant away from the camshaft bearing surfaces.

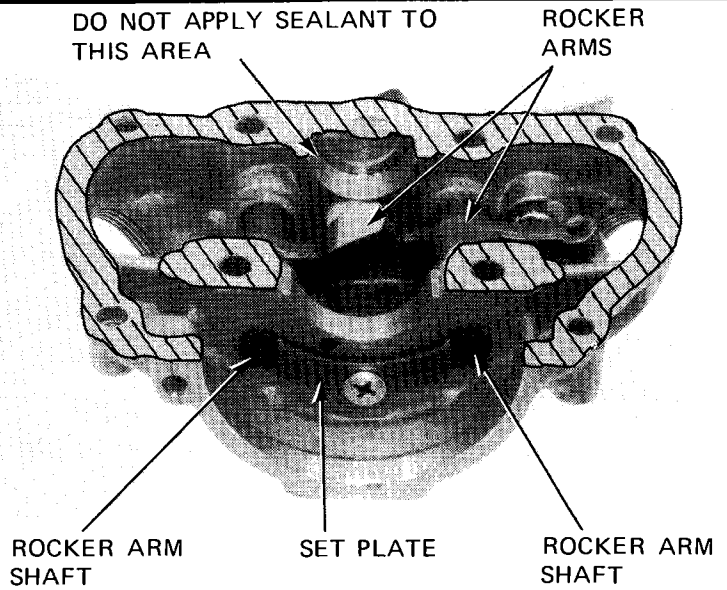

Coat the camshaft bearing and bushing with molybdenum disulfide grease.

Install the cylinder head cover.
Install and tighten the 8 mm cap nuts.

TORQUE: 28–30 N·m (2.8–3.0 kg-m, 20–22 ft-lb)

Install and tighten the 6 mm socket bolts.

TORQUE: 8–12 N·m (0.8–1.2 kg-m, 6–9 ft-lb)

NOTE

Tighten the 8 mm cap nuts and 6 mm bolts in a crisscross pattern in 2–3 steps.

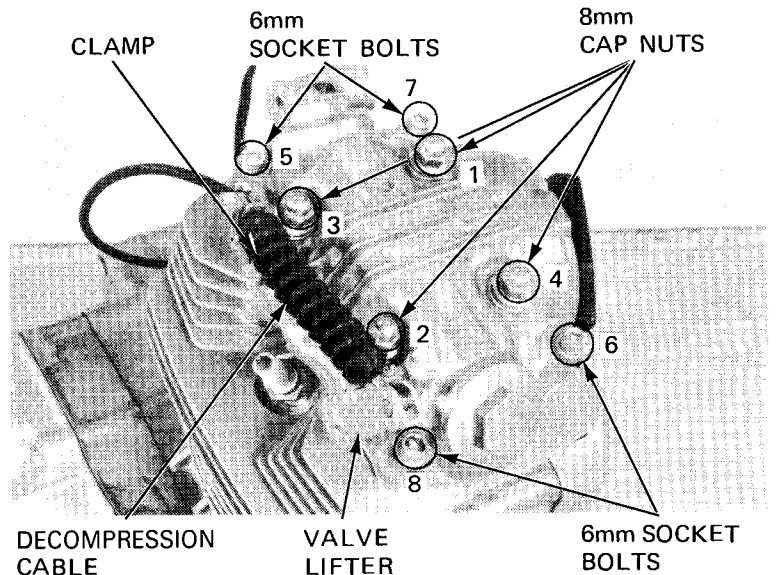

Connect the decompression cable to the valve lifter.
Clamp the cable and tighten the screw securely.

CAMSHAFT INSTALLATION

Coat the camshaft journals with molybdenum disulfide grease.

Place the thrust washer onto the camshaft.

Place the camshaft through the cam chain and into the cylinder head.

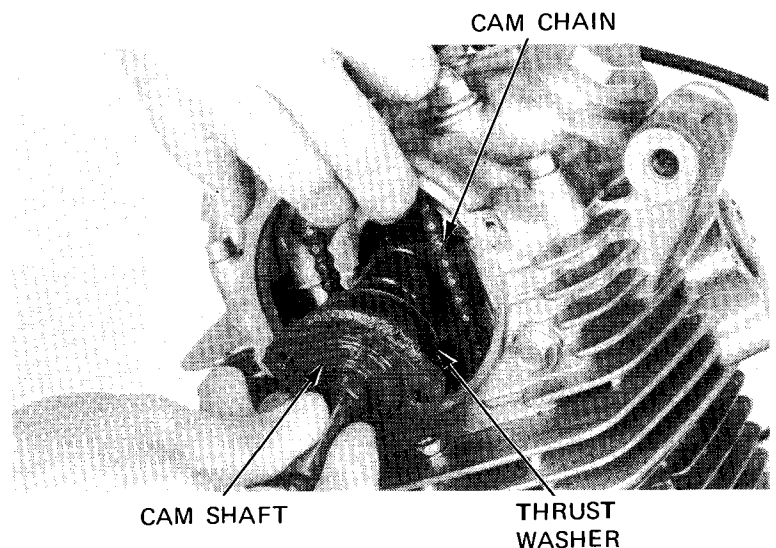

CYLINDER HEAD/VALVES

Turn the crankshaft with the recoil starter and align the "T" and index marks.
Install the cam sprocket. Align the timing mark "O" on the cam sprocket with the index mark on the cylinder head cover.

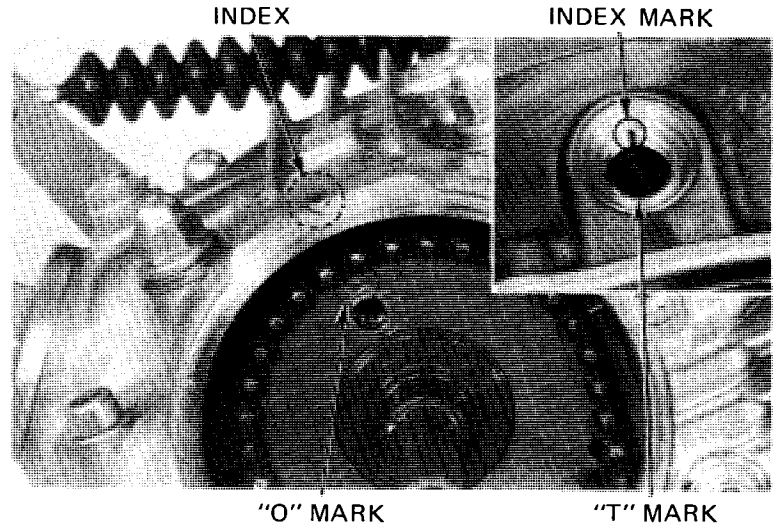

Tighten the cam sprocket bolt.

**TORQUE: 8–12 N·m (0.8–1.2 kg·m,
6–9 ft·lb)**

Press in a new oil seal and install the new o-ring and gasket on the pulse base.

NOTE

Do not turn the oil seal lip inside out.

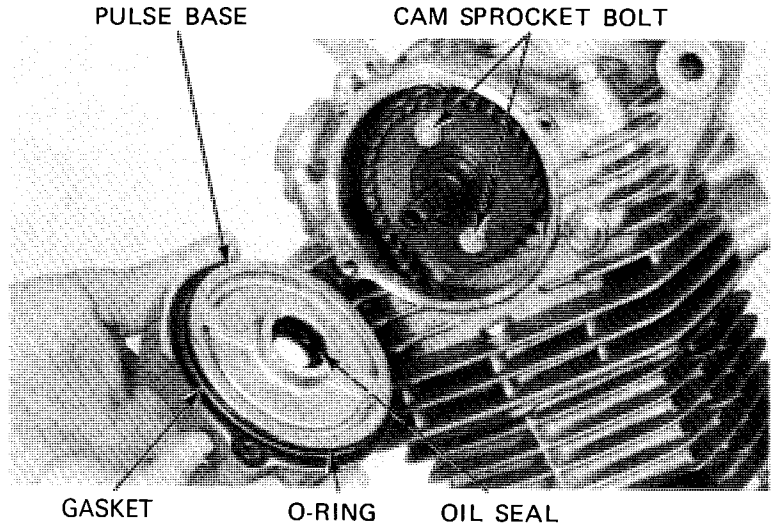

Tighten the pulse base bolts securely with the wire clamp.
Install the dowel pin.

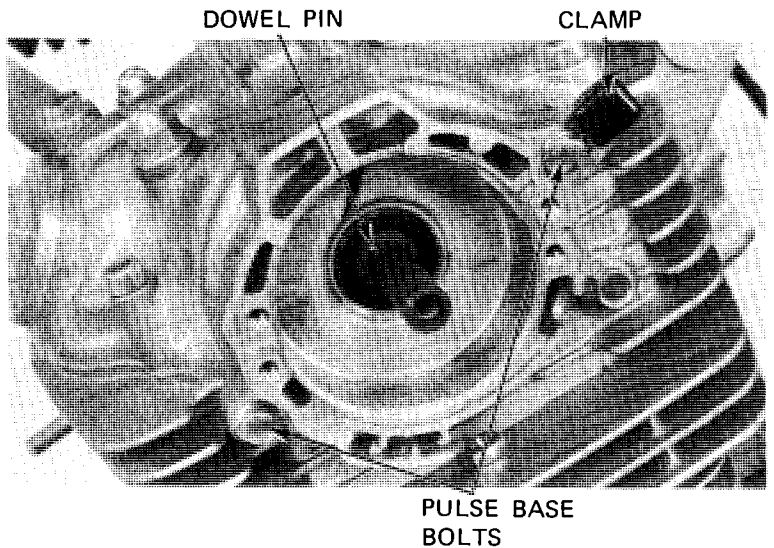

PULSE ROTOR ASSEMBLY

Align the punch mark on the rotor with the index mark on the spark advancer and assemble.

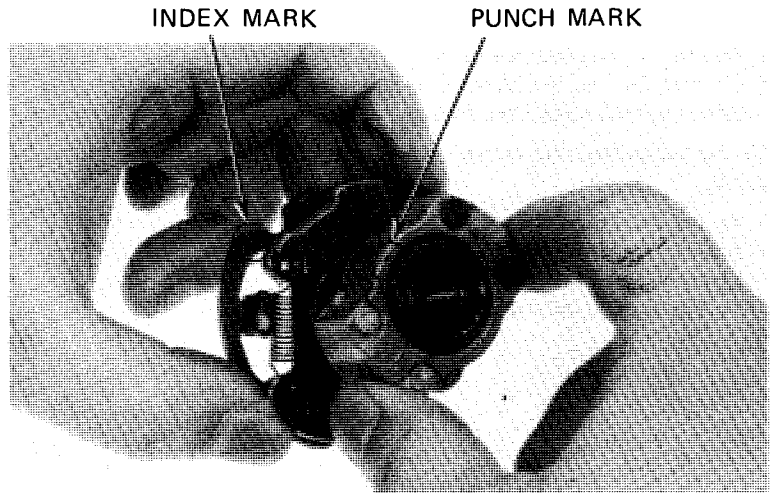

Install the pulse rotor/advancer assembly.

NOTE

Align the dowel pin with the advancer groove.

Tighten the pulse rotor bolt.

TORQUE: 8–12 N·m (0.8–1.2 kg-m,
6–9 ft-lb)

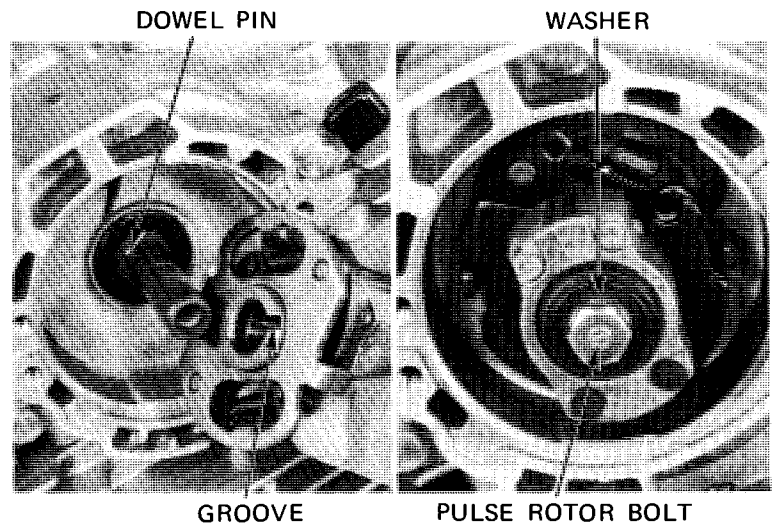

Install the pulse generator. Turn the crankshaft counterclockwise and align the "F" mark with the crankcase cover index mark.

Align the pulse rotor and pulse generator index marks.

Adjust the pulse rotor and generator air gap to 0.40–0.65 mm (0.015–0.025 in).

Clamp the pulse generator wire.

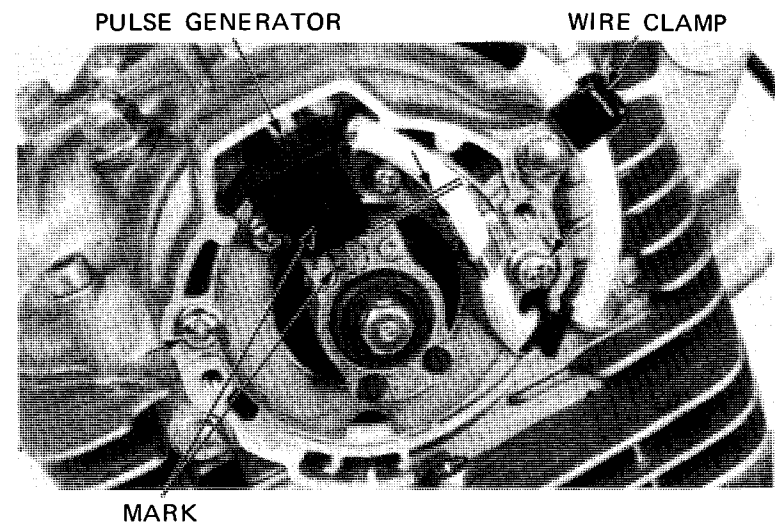

CYLINDER HEAD/VALVES

Install the pulse generator cover.

Pour fresh oil into the oil pockets in the cylinder head so that the cam lobes are submerged.

Do the following after installing the pulse generator cover.

- Adjust valve clearance (Page 3-6).
- Adjust cam chain tension (Page 3-8).
- Inspect ignition timing (Page 3-9).
- Test cylinder compression (Page 3-9).

PULSE
GENERATOR COVER

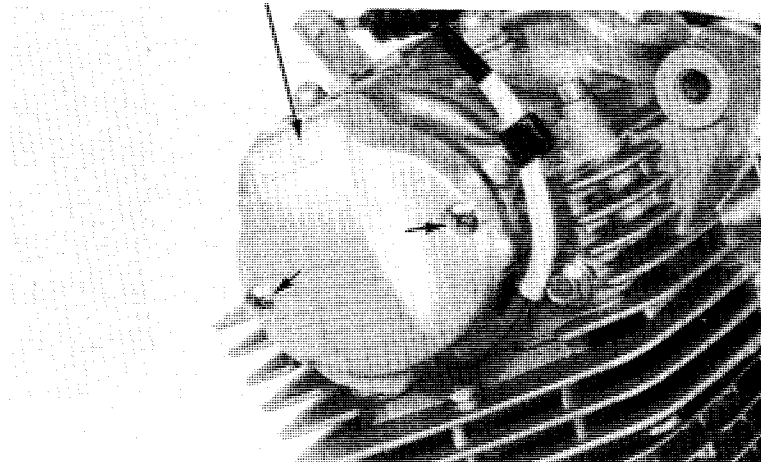



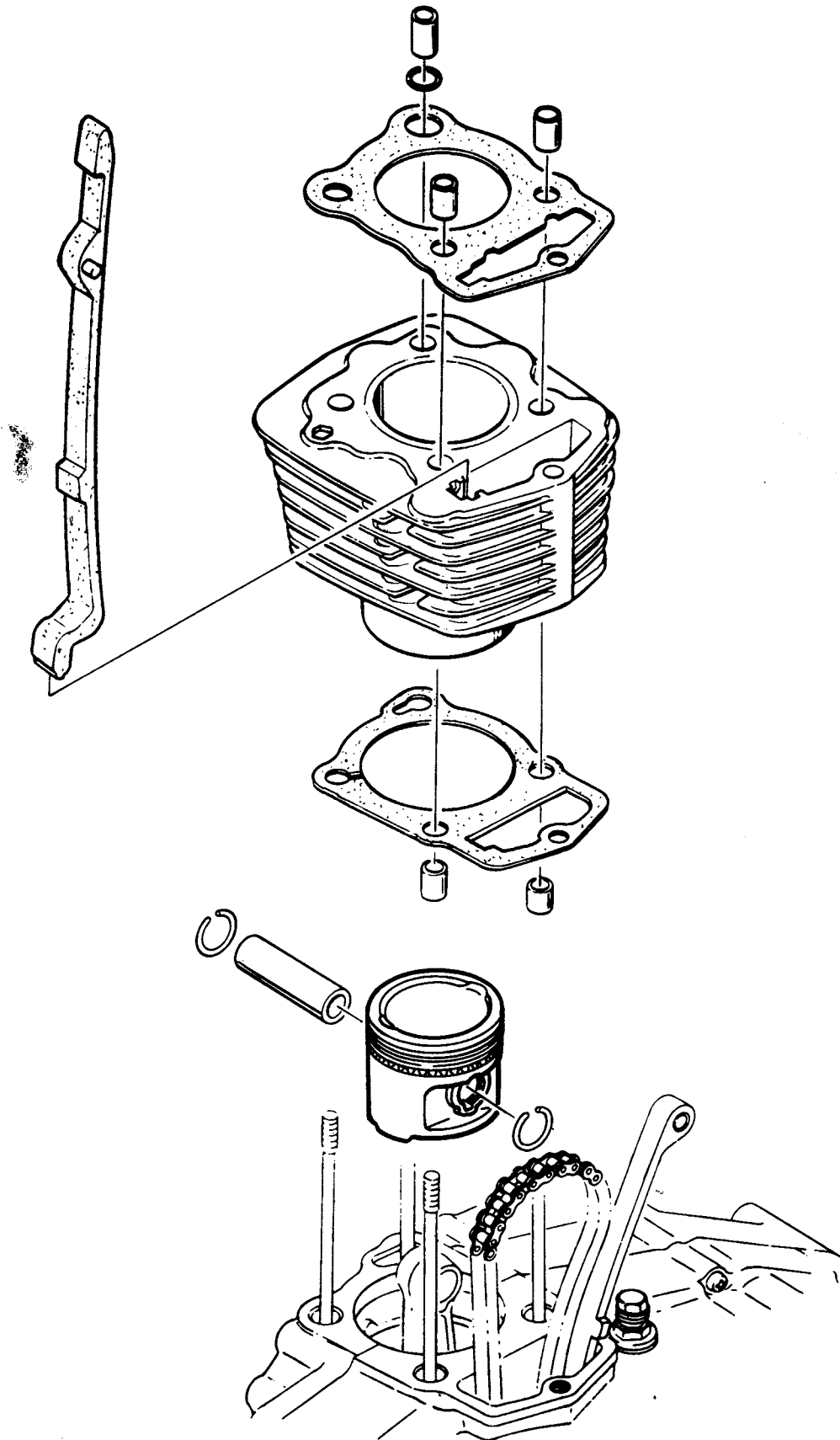

7. CYLINDER/PISTON

| | |
|-----------------------|-----|
| SERVICE INFORMATION | 7-1 |
| TROUBLESHOOTING | 7-1 |
| CYLINDER REMOVAL | 7-2 |
| PISTON REMOVAL | 7-3 |
| PISTON INSTALLATION | 7-6 |
| CYLINDER INSTALLATION | 7-6 |

SERVICE INFORMATION

GENERAL

- Camshaft lubrication oil is fed to the cylinder head through an orifice in the cylinder and crankcase. Be sure this orifice is not clogged and that the O-rings and dowel pins are in place before installing the cylinder head.

SPECIFICATIONS

| ITEM | | STANDARD | SERVICE LIMIT | |
|----------------------------------|-------------------------------------|-------------------------------------|-----------------------------------|--------------------|
| Cylinder | I.D. | 65.00–65.01 mm (2.559–2.560 in) | 65.10 mm (2.563 in) | |
| | Taper | ————— | 0.10 mm (0.004 in) | |
| | Out of round | ————— | 0.10 mm (0.004 in) | |
| | Warpage across top | ————— | 0.10 mm (0.004 in) | |
| Piston, piston pin, piston rings | Piston O.D. | 64.955–64.985 mm (2.5573–2.5585 in) | 64.90 mm (2.555 in) | |
| | Piston pin bore | 15.002–15.008 mm (0.5906–0.5909 in) | 15.04 mm (0.592 in) | |
| | Piston pin O.D. | 14.994–15.000 mm (0.5903–0.5906 in) | 14.96 mm (0.589 in) | |
| | Piston-to-pin clearance | 0.002–0.014 mm (0.0001–0.0006 in) | 0.02 mm (0.001 in) | |
| | Piston ring-to-ring groov clearance | TOP | 0.015–0.050 mm (0.0006–0.0020 in) | 0.09 mm (0.004 in) |
| | | SECOND | 0.015–0.045 mm (0.0006–0.0018 in) | 0.09 mm (0.004 in) |
| | Piston ring end gap | TOP/SECOND | 0.20–0.40 mm (0.008–0.016 in) | 0.50 mm (0.02 in) |
| OIL | | 0.30–0.90 mm (0.012–0.035 in) | ————— | |
| Cylinder-to-piston clearance | | 0.015–0.055 mm (0.0006–0.0022 in) | 0.10 mm (0.004 in) | |

TROUBLESHOOTING

Low or unstable compression

1. Worn cylinder or piston rings
2. Faulty decompressor lever out of adjustment.

Excessive smoke

1. Worn cylinder, piston, or piston rings
2. Improper installation of piston rings
3. Scored or scratched piston or cylinder wall

Overheating

1. Excessive carbon build-up on piston or combustion chamber wall

Knocking or abnormal noise

1. Worn piston and cylinder
2. Excessive carbon build-up

CYLINDER REMOVAL

Remove the cylinder head (Section 6).
Remove the gasket, dowel pins and O-ring.
Remove the cam chain guide.

NOTE

Keep the cam chain from falling into the crankcase when removing the cylinder.

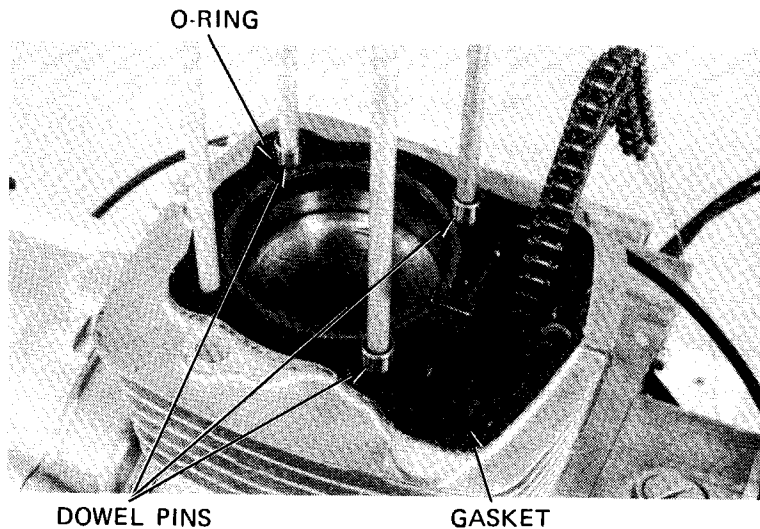

Remove the cylinder.
Remove the gasket and dowel pins.

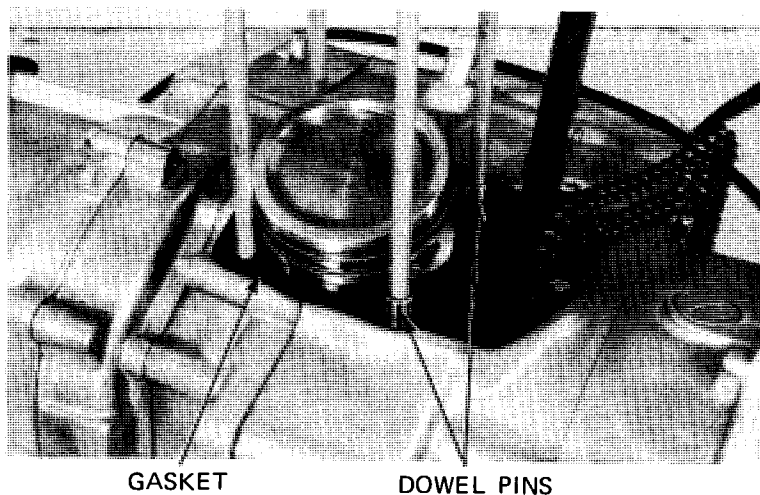

Clean off any gasket material from the cylinder surface.

NOTE

Be careful not to remove any metal from the gasket surface.

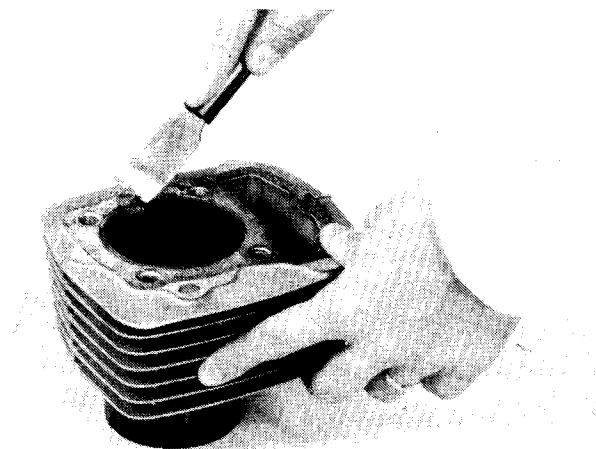

CYLINDER INSPECTION

Inspect the cylinder bore for wear or damage.
Measure the cylinder I.D.

SERVICE LIMIT: 65.10 mm (2.569 in)

Check the cylinder I.D. at X and Y axis at three locations.

Calculate the taper and out of round.

SERVICE LIMIT:

Taper: 0.10 mm (0.0039 in)

Out of round: 0.10 mm (0.0039 in)

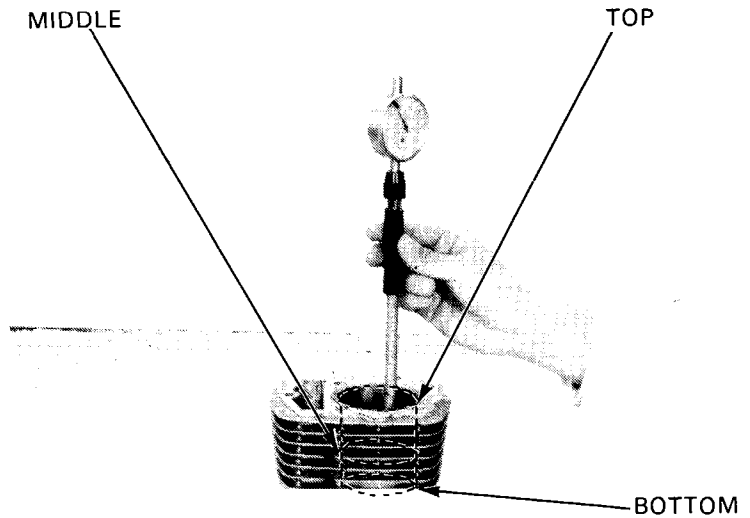

Inspect the top of the cylinder for warpage.

SERVICE LIMIT: 0.10 mm (0.0039 in)

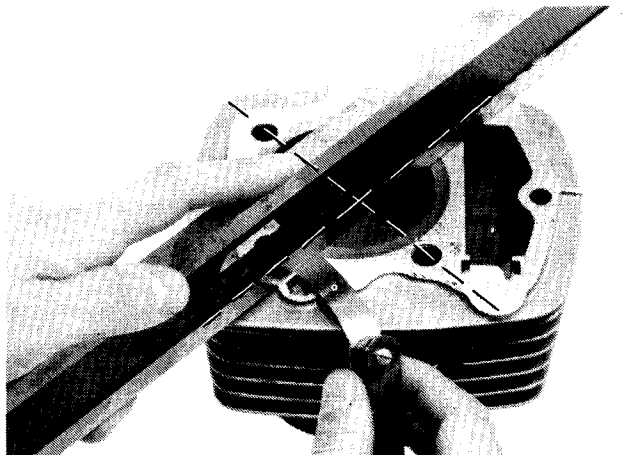
**PISTON REMOVAL**

Remove the piston pin clip with pliers.

NOTE

Do not let the clips fall into the crankcase.

Press the piston pin out of the piston and remove the piston.

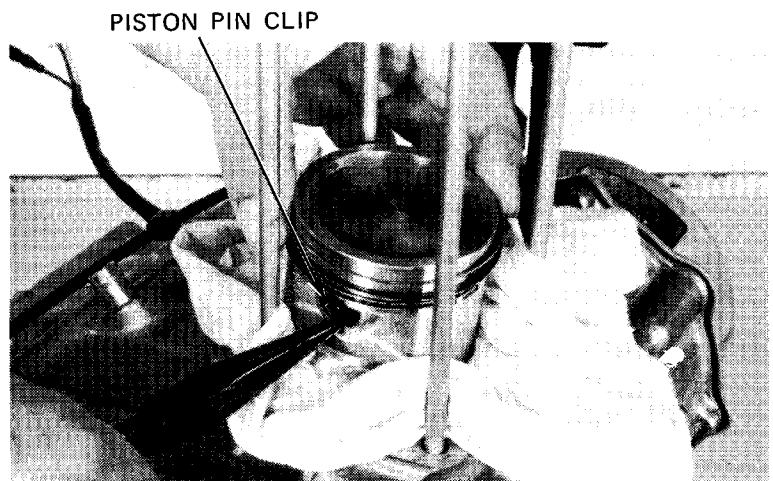

CYLINDER/PISTON

PISTON/PISTON RING INSPECTION

Measure the piston ring-to-groove clearance.
Remove the piston rings.

NOTE

Be careful not to damage the piston rings during removal.

SERVICE LIMIT:

TOP: 0.09 mm (0.004 in)

SECOND: 0.09 mm (0.004 in)

Inspect the piston for wear or damage.

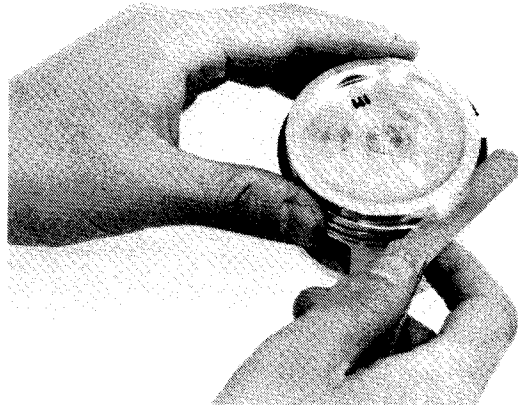

Insert each piston ring into the cylinder and measure the ring end gap.

SERVICE LIMIT:

TOP: 0.5 mm (0.02 in)

SECOND: 0.5 mm (0.02 in)



Measure the piston diameter at the skirt.

SERVICE LIMIT: 64.90 mm (2.555 in)

NOTE

Measure the piston diameter 10 mm from the bottom.

Calculate the piston-to-cylinder clearance.

SERVICE LIMIT: 0.10 mm (0.004 in)

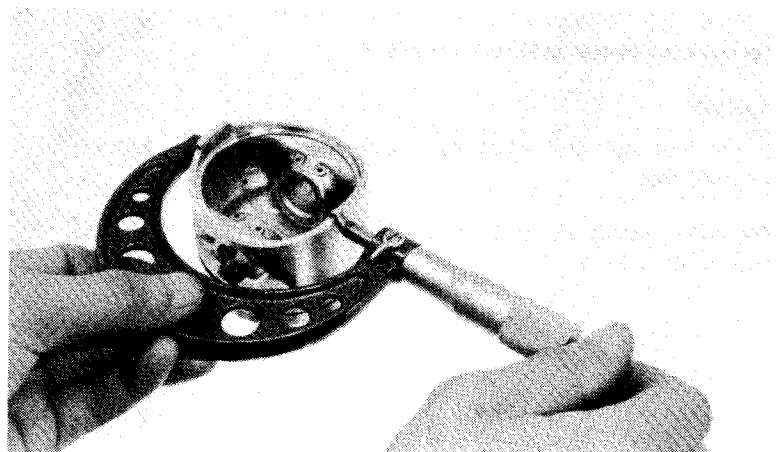

Measure the piston pin hole I.D.

SERVICE LIMIT: 15.04 mm (0.592 in)

Measure the piston pin O.D.

SERVICE LIMIT: 14.96 mm (0.589 in)

Calculate the piston-to piston pin clearance.

SERVICE LIMIT: 0.02 mm (0.001 in)

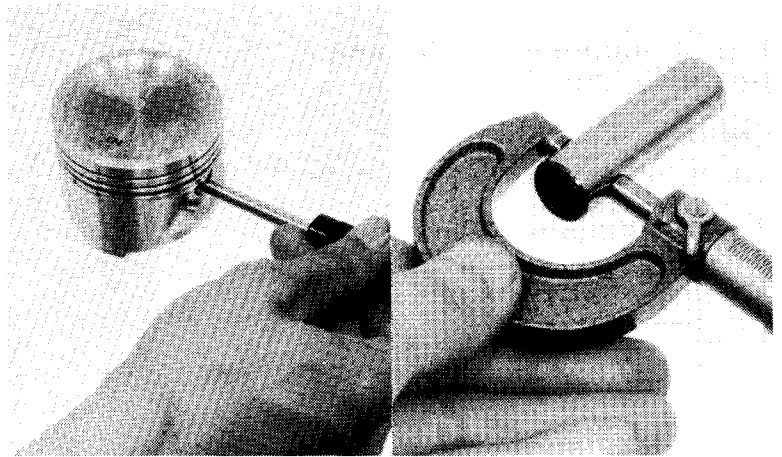

PISTON RING INSTALLATION

Clean the piston ring grooves thoroughly and install the piston rings.

NOTE

- Avoid piston and piston ring damage during installation.
- Install the piston rings with the markings facing up.
- Do not interchange the top and second rings.

Space the piston ring end gaps 120 degrees apart.

Do not align the gaps in the oil rings (side rails).

After installation, the rings should be free to rotate in the ring grooves.

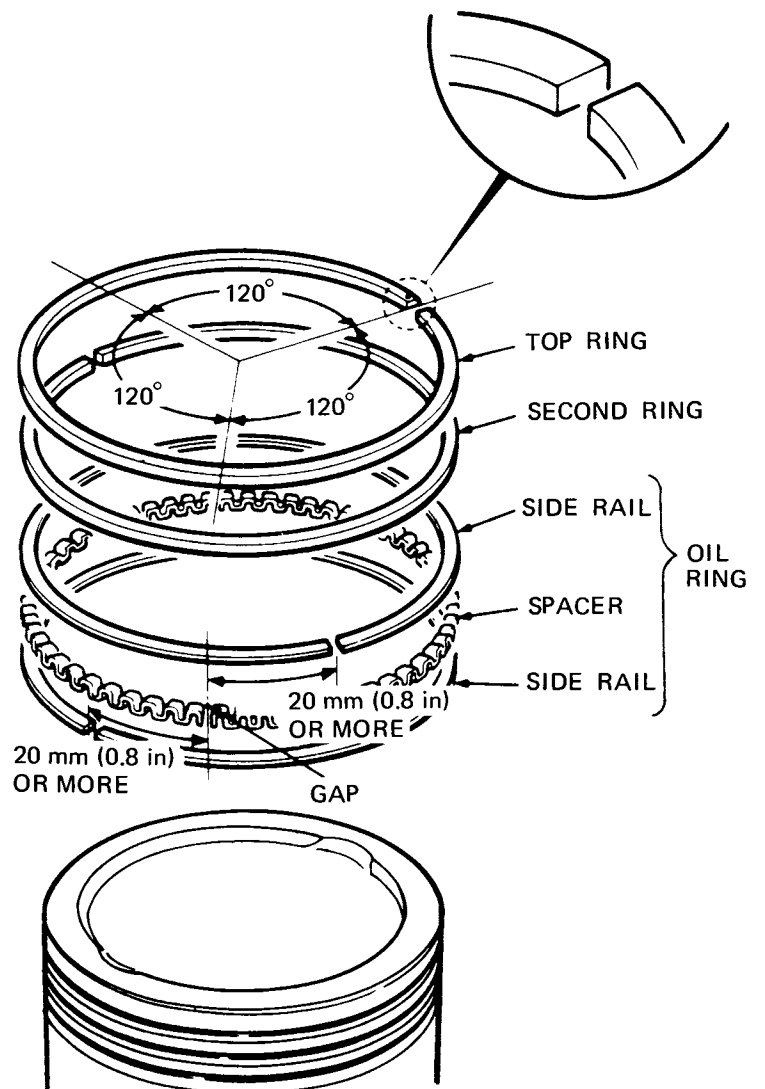
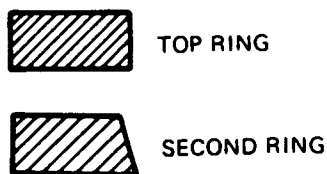

PISTON INSTALLATION

Install the piston and piston pin, using a new piston pin clip.

NOTE

- Position the piston "IN" mark on the intake valve side.
- Do not align the piston pin clip end gap with the piston cutout.
- Do not let the clip fall into the crankcase.

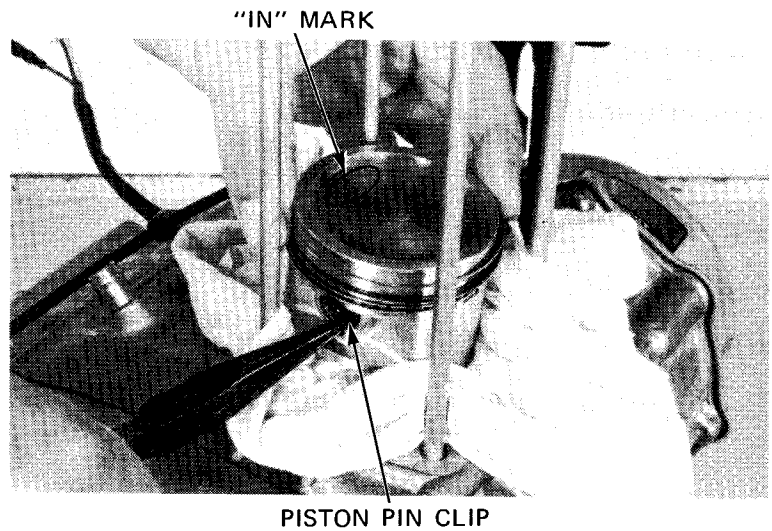

CYLINDER INSTALLATION

Install the base gasket and dowel pins.

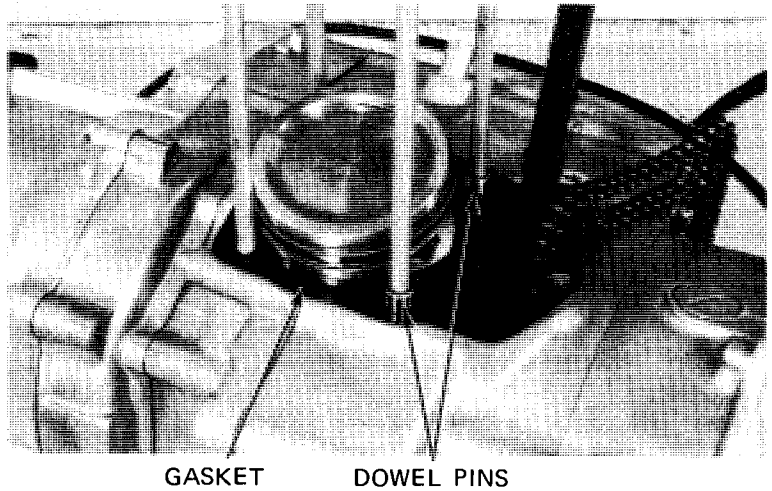

Coat the cylinder bore and piston rings with engine oil.
Install the cylinder.

NOTE

- Avoid piston ring damage during installation.
- Do not let the cam chain fall into the crankcase.

Install the cam chain guide.
Install a new cylinder head gasket.

Install the dowel pins and O-ring.
Install the cylinder head (Page 6–15).

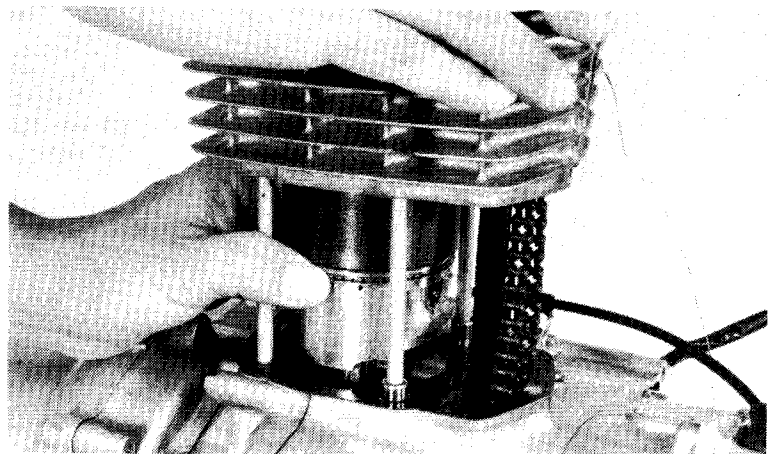



CLUTCH/OIL PUMP

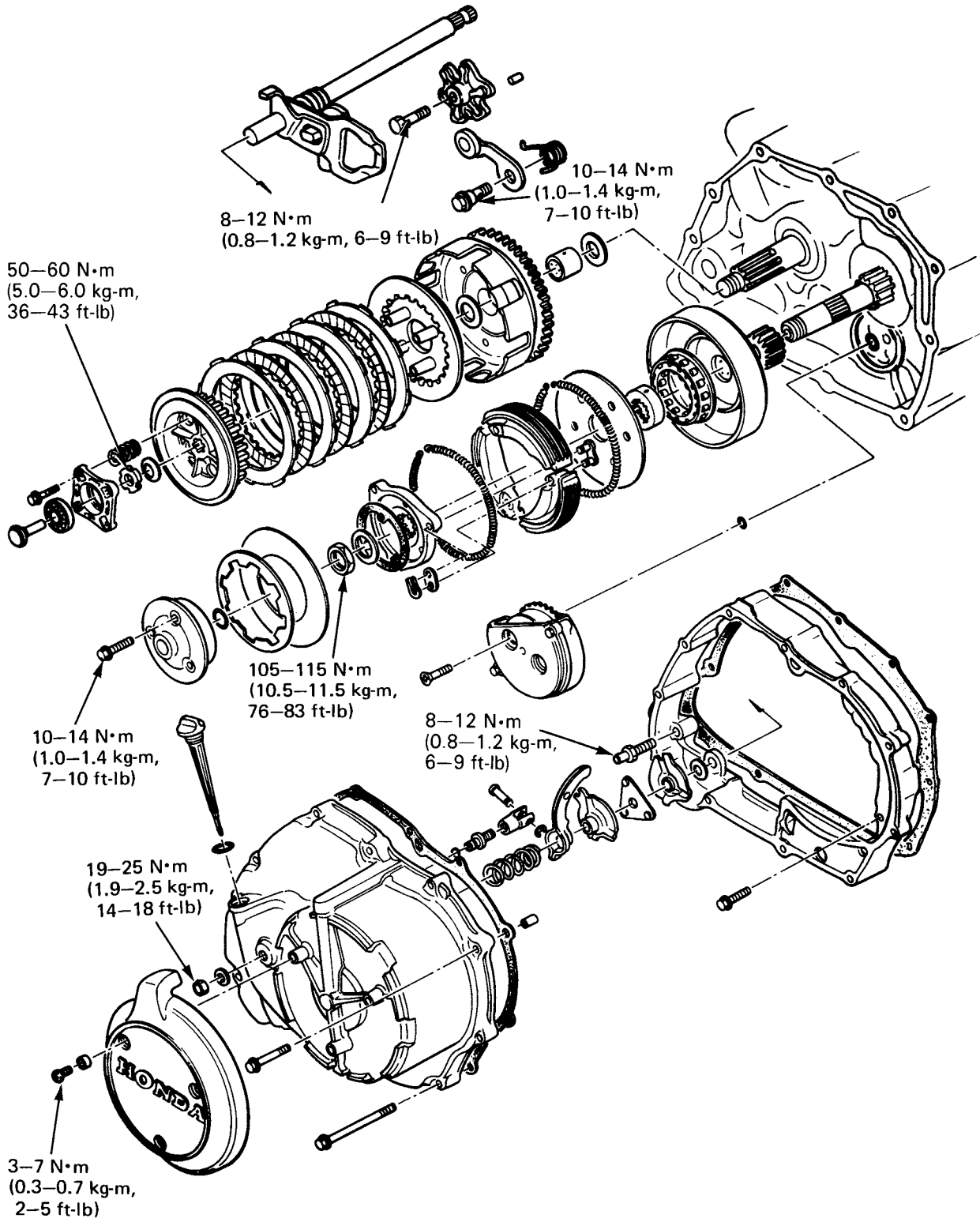

8. CLUTCH/OIL PUMP

| | | | |
|-------------------------------|-----|------------------------------------|------|
| SERVICE INFORMATION | 8-1 | MANUAL CLUTCH | 8-11 |
| TROUBLESHOOTING | 8-2 | OIL PUMP | 8-15 |
| RIGHT CRANKCASE COVER REMOVAL | 8-3 | GEARSHIFT LINKAGE | 8-19 |
| CENTRIFUGAL CLUTCH | 8-5 | RIGHT CRANKCASE COVER INSTALLATION | 8-21 |

SERVICE INFORMATION

GENERAL

- This section covers removal and installation of the centrifugal clutch, manual clutch, oil pump and gearshift linkage.
- The clutches, oil pump and gearshift linkage can be serviced with the engine installed in the frame.

SPECIFICATIONS

| ITEM | | STANDARD | | SERVICE LIMIT | |
|--------------------|--------------------------|------------------|--------------------|---------------|------------|
| Manual clutch | Spring free length | 25.7 mm | (1.01 in) | 25.0 mm | (0.98 in) |
| | Spring preload | 37.5 kg | (86.67 lb) | _____ | _____ |
| | Disc thickness | 2.9–3.0 mm | (0.11–0.12 in) | 2.6 mm | (0.10 in) |
| | Disc warpage | _____ | _____ | 0.20 mm | (0.008 in) |
| | Plate warpage | _____ | _____ | 0.20 mm | (0.008 in) |
| Centrifugal clutch | Drum I.D. | 116 mm | (4.57 in) | 116.3 mm | (4.58 in) |
| | Weight thickness | 4.3 mm | (0.17 in) | 4.1 mm | (0.16 in) |
| | Spring free length | 267.5 mm | (10.53 in) | 282 mm | (11.1 in) |
| | Spring preload | 12.3–13.7 kg | (27.10–30.20 lb) | _____ | _____ |
| | Clutch outer guide | 20.000–20.021 mm | (0.7874–0.7882 in) | 20.05 mm | (0.789 in) |
| Oil pump | Rotor-to-cover clearance | 0.15–0.20 mm | (0.006–0.008 in) | 0.25 mm | (0.010 in) |
| | Rotor tip clearance | 0.15 mm | (0.006 in) | 0.20 mm | (0.008 in) |
| | Rotor-to-body clearance | 0.30–0.36 mm | (0.012–0.014 in) | 0.40 mm | (0.016 in) |

TORQUE VALUES

| | | |
|-----------------------------------|-------------|-------------------------------|
| Oil filter rotor cover bolts | 10–14 N·m | (1.0–1.4 kg-m, 7–10 ft-lb) |
| Manual clutch lock nut | 50–60 N·m | (5.0–6.0 kg-m, 36–43 ft-lb) |
| Centrifugal clutch lock nut | 105–115 N·m | (10.5–11.5 kg-m, 76–83 ft-lb) |
| Clutch adjusting screw lock nut | 19–25 N·m | (1.9–2.5 kg-m, 14–18 ft-lb) |
| Clutch lifter stopper bolt | 18–25 N·m | (1.8–2.5 kg-m, 13–18 ft-lb) |
| Gearshift drum stopper arm bolt | 10–14 N·m | (1.0–1.4 kg-m, 7–10 ft-lb) |
| Gearshift drum stopper plate bolt | 8–12 N·m | (0.8–1.2 kg-m, 6–9 ft-lb) |

TOOLS

Special

| | | |
|------------------------|---------------|---|
| Flywheel Holder | 07925–9580001 | Not available in U.S.A. |
| Lock Nut Wrench, 30 mm | 07907–PD10000 | Equivalent commercially available in U.S.A. |
| Clutch Center Holder | 07923–9580000 | Not available in U.S.A. |

Common

| | |
|-----------------------------|--------------------------------|
| Lock Nut Wrench, 20 x 24 mm | 07716–0020100 or 07916–3710000 |
| Extension Bar | 07716–0020500 |

TROUBLESHOOTING

Faulty clutch operation can usually be corrected by adjusting the clutch.

Clutch slips when accelerating

1. Faulty clutch lifter
2. Discs worn
3. Springs weak

Clutch will not disengage

1. Faulty clutch lifter
2. Plates warped

Motorcycle creeps with clutch disengaged

1. Faulty centrifugal clutch
2. Plates warped

Clutch operation feels rough

- Outer drum slots rough

Hard to shift

1. Stopper plate damaged
2. Incorrect clutch adjustment
3. Faulty clutch lifter

Gearshift pedal will not return

1. Weak or broken shift return spring
2. Shift spindle binding with case

Transmission jumps out of gears

- Weak or broken stopper spring

Low oil pressure

1. Faulty oil pump
2. Oil pump drive gear broken

RIGHT CRANKCASE COVER REMOVAL

Drain the oil from the engine.

Remove the right crankcase cover bolts and cover.

Remove the gasket and dowel pins.

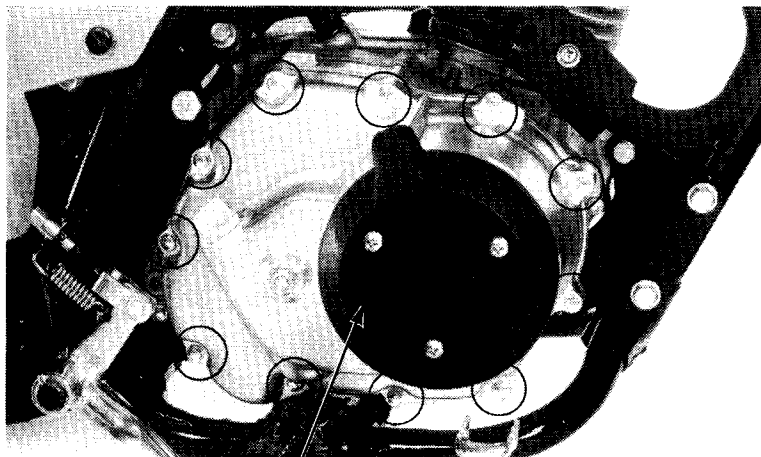

RIGHT CRANKCASE COVER

Remove the gasket and dowel pins.

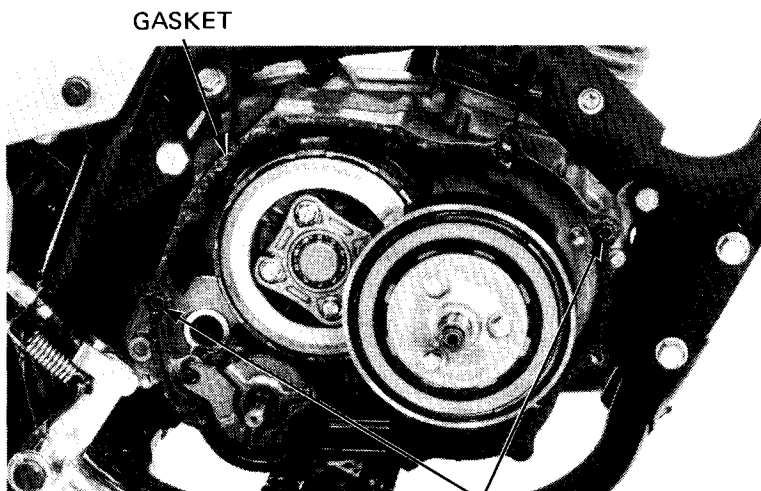

GASKET

DOWEL PINS

CLUTCH LIFTER DISASSEMBLY

Remove the clutch adjusting screw lock nut, washer and O-ring.

Remove the clutch lifter lever and spring.

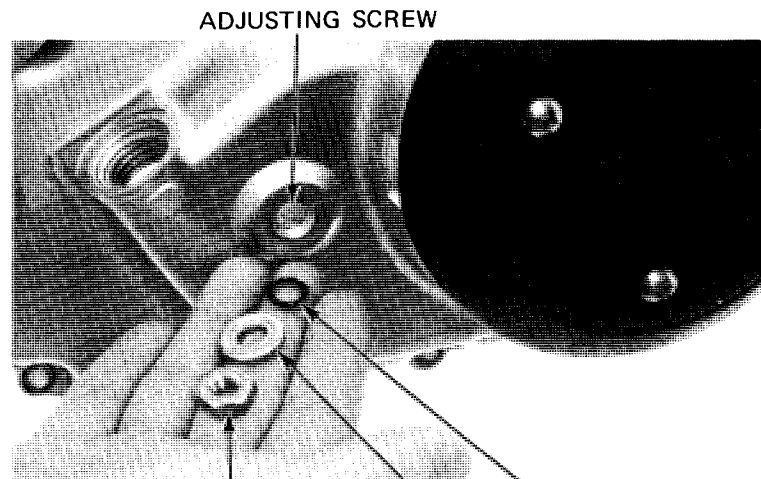

ADJUSTING SCREW

LOCK NUT

WASHER

O-RING

CLUTCH/OIL PUMP

Remove the clutch lifter lever assembly and clutch lifter spring.

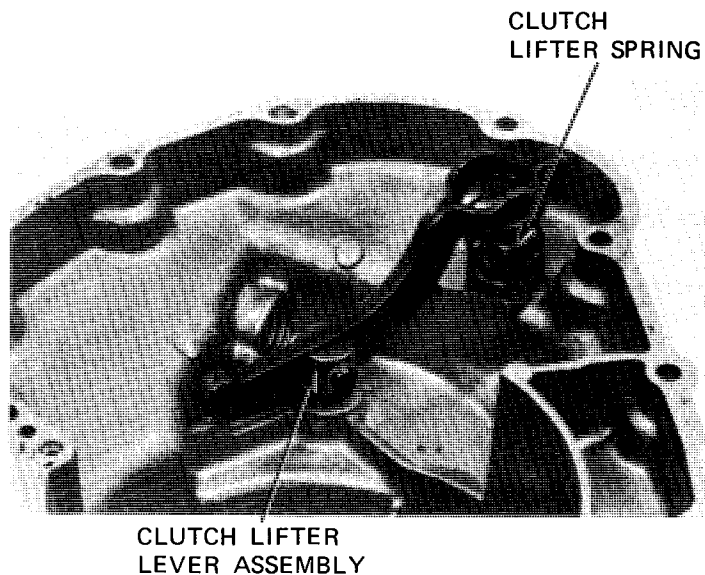

Remove the clutch adjusting screw.
Remove the circlip and disassemble the clutch lifter lever.

Check the disassembled parts for damage or wear and replace the parts if necessary.

CLUTCH LIFTER ASSEMBLY

Install the joint and joint pin on the lifter lever.

Install the circlip and screw in the clutch adjusting screw.

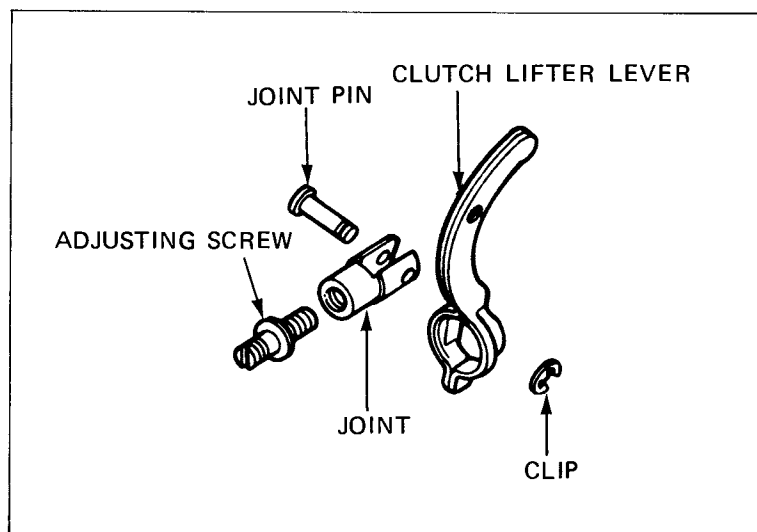

Install the spring and clutch lifter lever assembly onto the right crankcase cover.

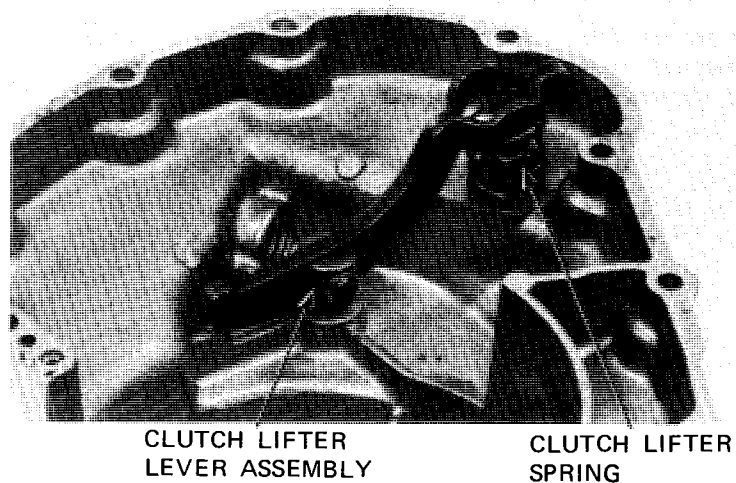

Slip the O-ring onto the clutch adjusting screw.

Install the lock nut loosely.
Install the right crankcase cover protector.

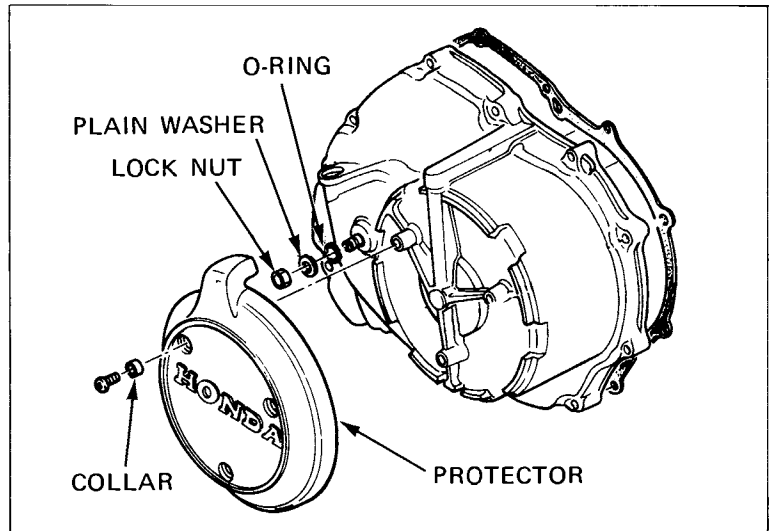

CENTRIFUGAL CLUTCH

CENTRIFUGAL CLUTCH REMOVAL

Remove the recoil starter from the left crankcase cover (Page 9-2)

Install a FLYWHEEL HOLDER or screwdriver to prevent the crankshaft from turning.

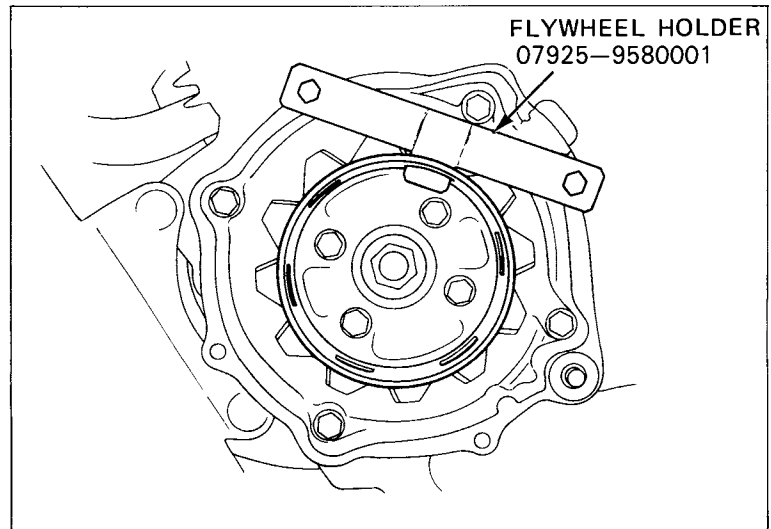

Remove the oil filter rotor cover, slide friction spring, plain washer and O-ring.

CAUTION:

Be careful not to damage the oil pressure pad.

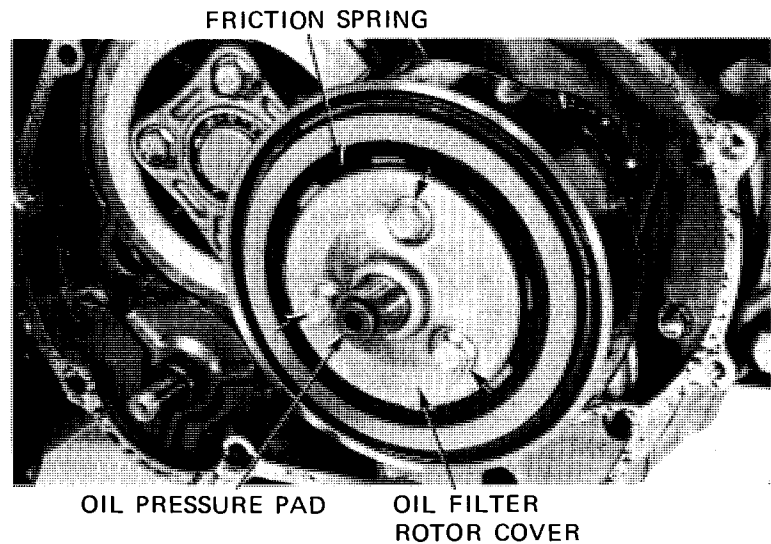

CLUTCH/OIL PUMP

Unstake the lock nut with a drill or grinder. Be careful that the threads on the shaft are not damaged.

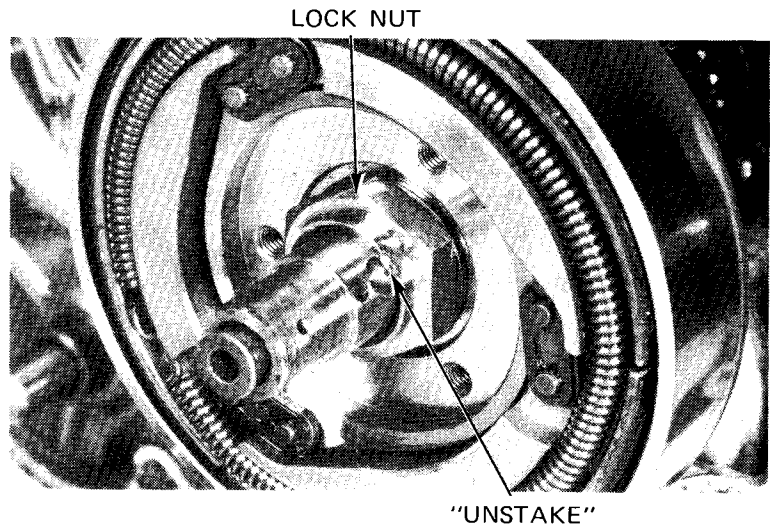

Remove the lock nut by turning it clockwise.

NOTE

The lock nut has left hand threads.

Remove the plain washer.

Remove the centrifugal clutch weights.

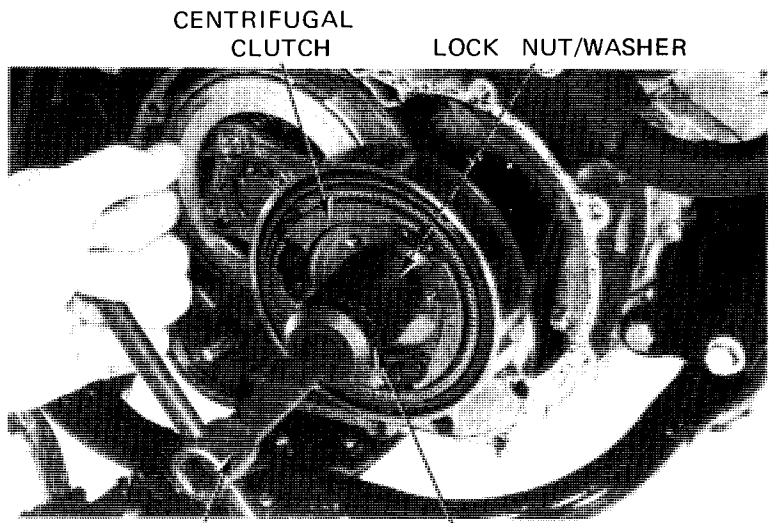

EXTENSION BAR
07716-0020500

LOCK NUT WRENCH, 30 mm
07907-PD10000 or Equivalent
commercially available in U.S.A.

Remove the springs.
Remove the clips and centrifugal clutch weight.

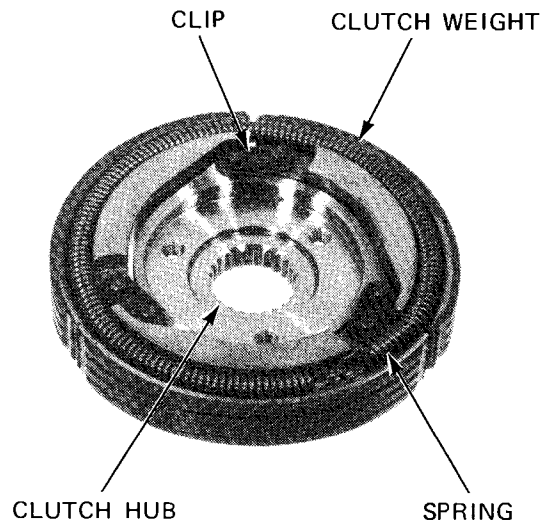

WEIGHT INSPECTION

Measure the weight lining thickness.
Measure the link joint hole I.D.

SERVICE LIMIT: 4.1 mm (0.16 in)

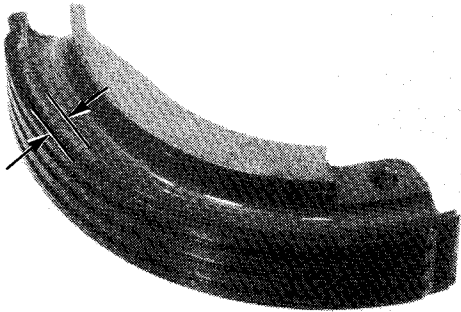

Measure the weight spring free length.

SERVICE LIMIT: 282 mm (11.1 in)

Replace the spring with a new one if it is longer than the service limit.

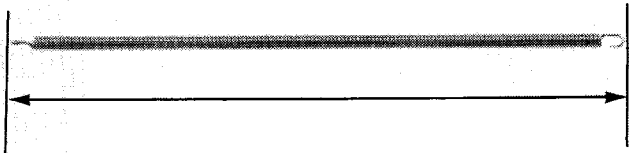

Remove the clutch plate.
Align the clutch outer cutout with the drive gear and remove the clutch drum.

CLUTCH PLATE

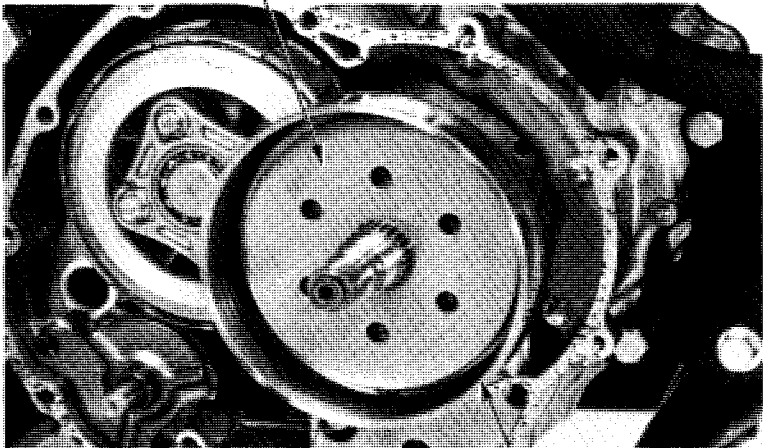

CLUTCH DRUM

CLUTCH/OIL PUMP

Remove the one-way clutch center and sprag.

CLUTCH DRUM INSPECTION

Check the inside of the centrifugal clutch drum for scratches or excessive wear.
Replace if necessary.
Measure the I.D. of the clutch drum.

SERVICE LIMIT: 116.3 mm (4.58 in)

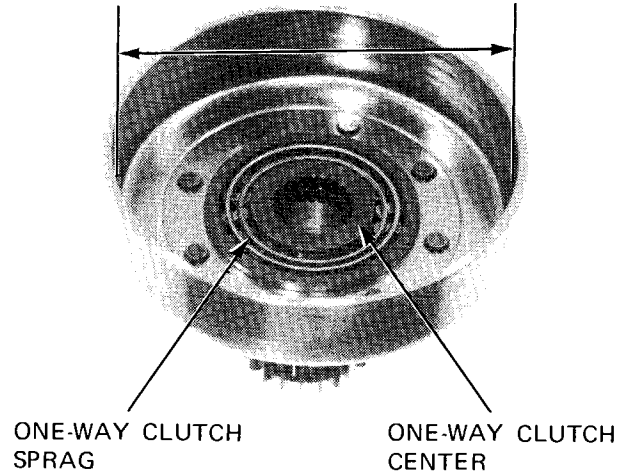

CUT-OUT

CENTRIFUGAL CLUTCH INSTALLATION

Install the clutch centrifugal clutch drum, aligning the clutch outer cutout with the drive gear.

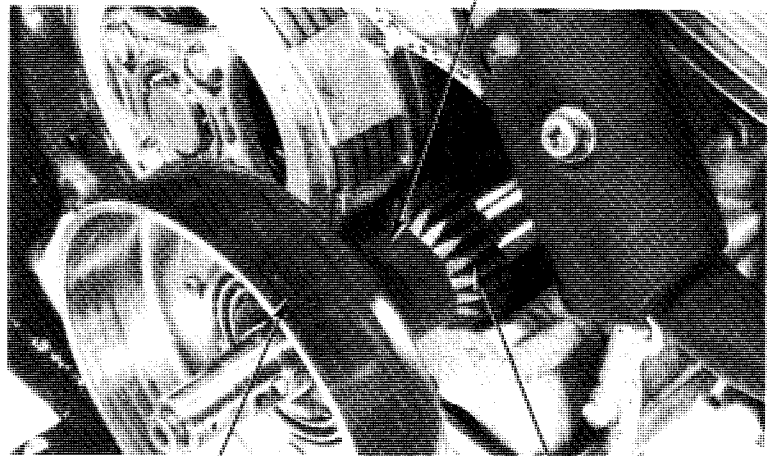

CLUTCH DRUM

DRIVE GEAR

Install the one-way clutch sprag.
Install the one-way clutch drum by turning it counterclockwise while pushing the clutch center in.
Install clutch plate B.

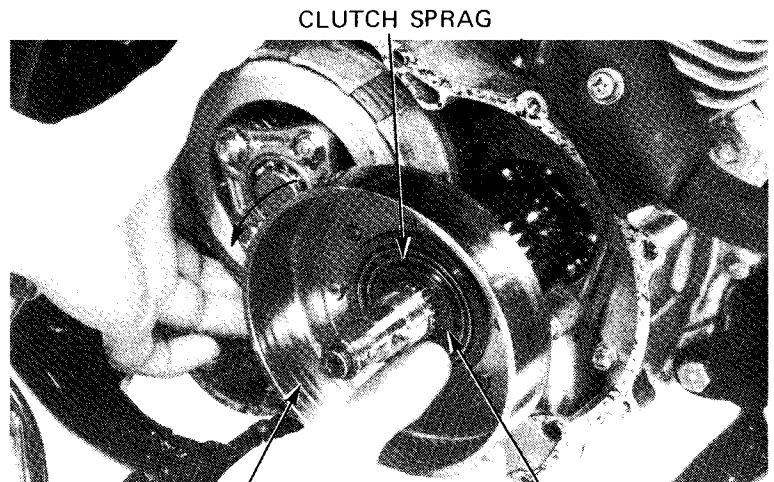

CLUTCH SPRAG

CLUTCH DRUM

CLUTCH CENTER

Attach the centrifugal clutch weights to the clutch hub with the links and clips.

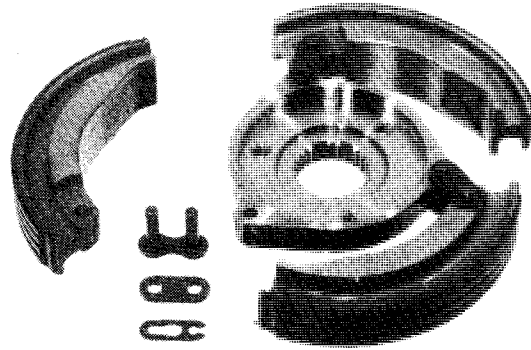

Install the centrifugal clutch springs, using a screwdriver.

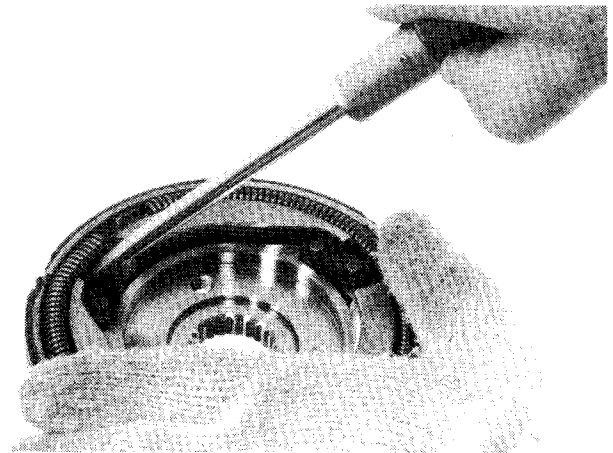

Install the centrifugal clutch weight assembly onto the clutch drum.
Install the lock washer and lock nut.

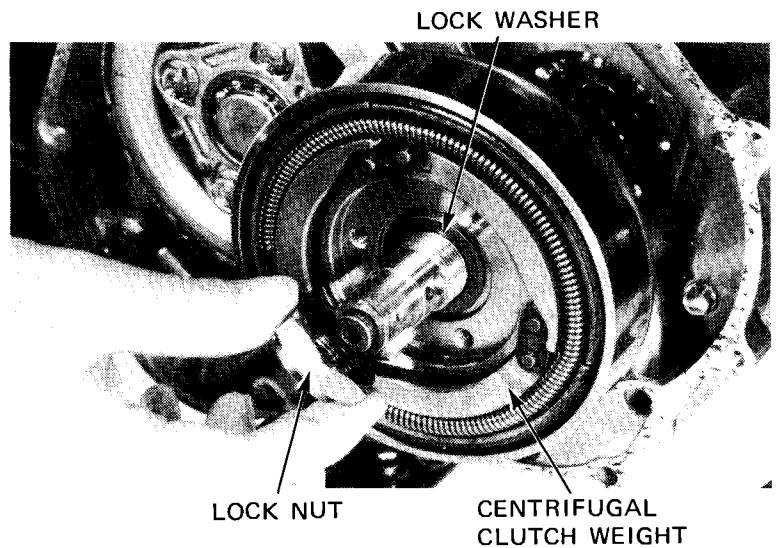

CLUTCH/OIL PUMP

Install the Flywheel Holder (Page 8-5).

Turn the lock nut counterclockwise to tighten it.

**TORQUE: 105–115 N·m (10.5–11.5 kg·m
76–83 ft·lb)**

NOTE

The lock nut has left hand threads.

Stake the lock nut.

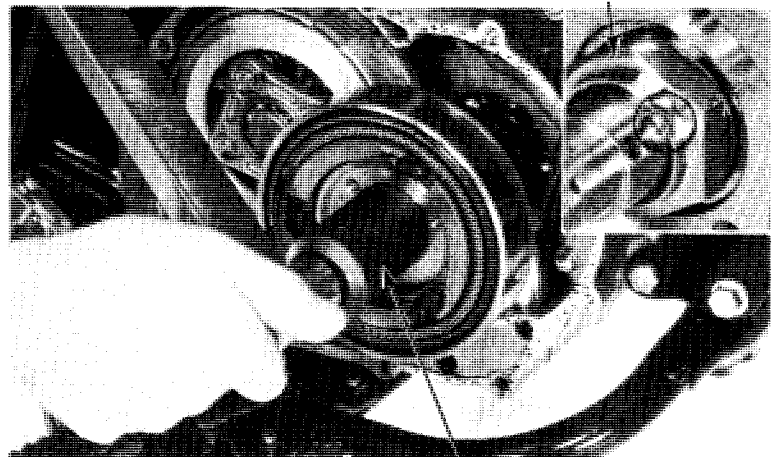

LOCK NUT

LOCK NUT WRENCH
07907-PD10000
or Equivalent commercially
available in U.S.A.

OIL FILTER
ROTOR COVER

Place the oil filter rotor cover gasket onto the clutch hub.

Slip a new O-ring onto the crankshaft.
Install the thrust washer, side friction spring
and oil filter rotor cover.

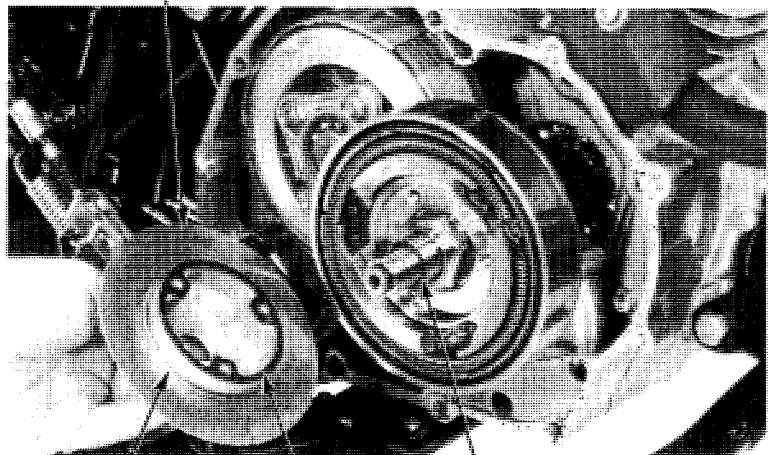

FRICITION
SPRING

GASKET

O-RING

NOTE

Align the teeth of the friction spring
with step on the cover.

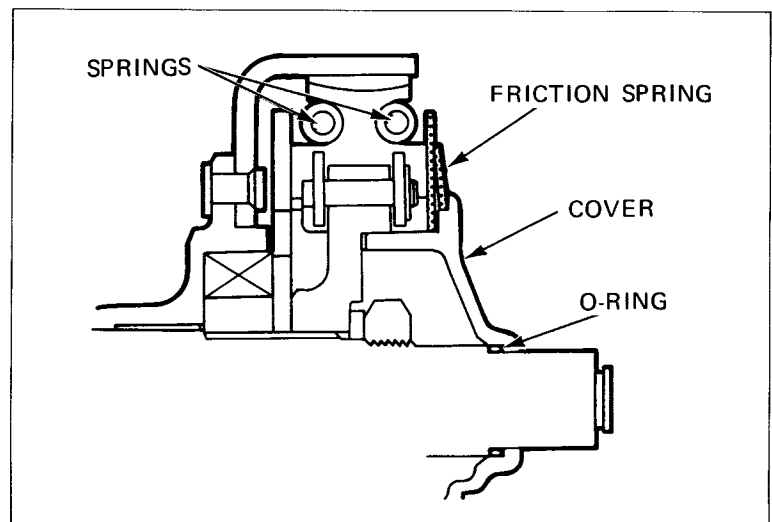

Tighten the cover bolts.

**TORQUE: 10–14 N·m (1.0–1.4 kg-m,
7–10 ft-lb)**

Remove the Flywheel Holder.
Install the cooling fan, starter pulley and
recoil starter (Page 9–6).
Install the neutral indicator (Page 9–12).

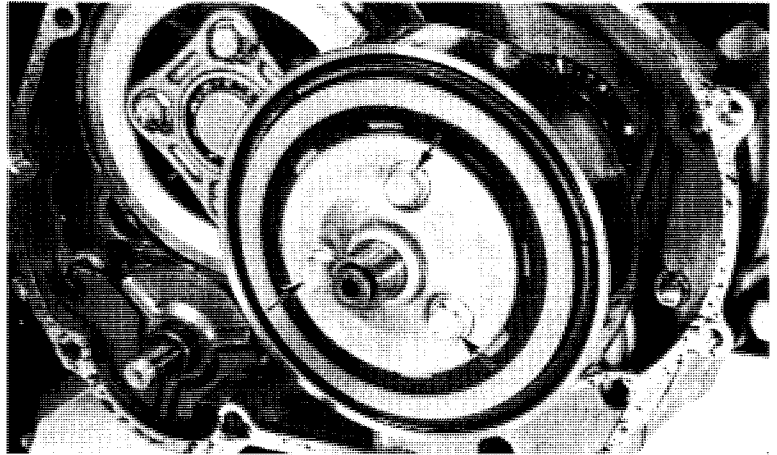

MANUAL CLUTCH

REMOVAL

Remove the centrifugal clutch (Page 8–5).
Remove the lifter plate and clutch springs by
removing the clutch bolts.
Remove the lifter guide and bearing from
the lifter plate.

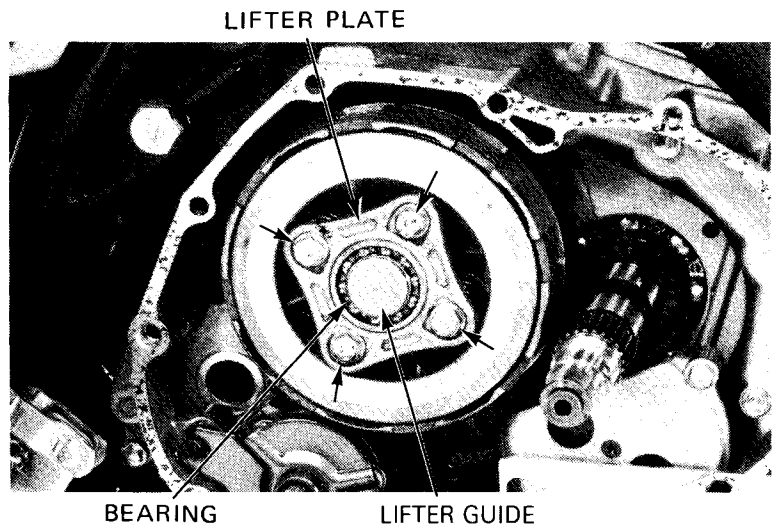

CLUTCH CENTER HOLDER
07923–9580000
Not available in U.S.A.

Install a CLUTCH CENTER HOLDER as
shown, and remove the clutch lock nut.

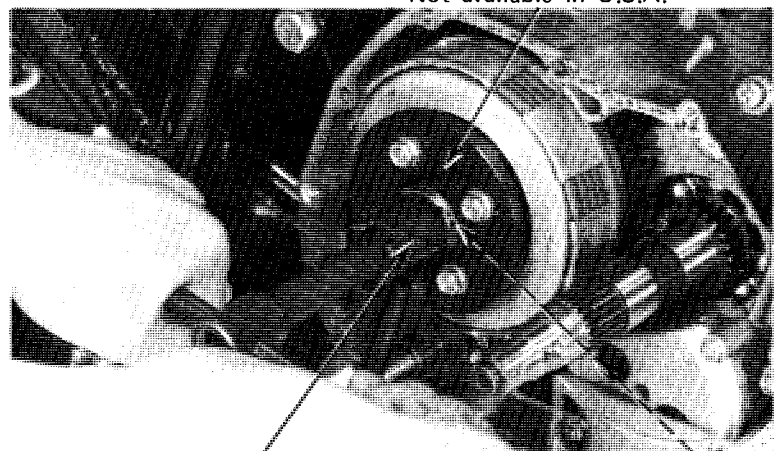

LOCK NUT WRENCH,
20 x 24 mm 07716–0020100 OR 07916–3710000 LOCK NUT
EXTENSION BAR

CLUTCH/OIL PUMP

Remove the clutch center, discs, plates, pressure plate and thrust washer.

Remove the clutch outer, clutch outer guide and thrust washer.

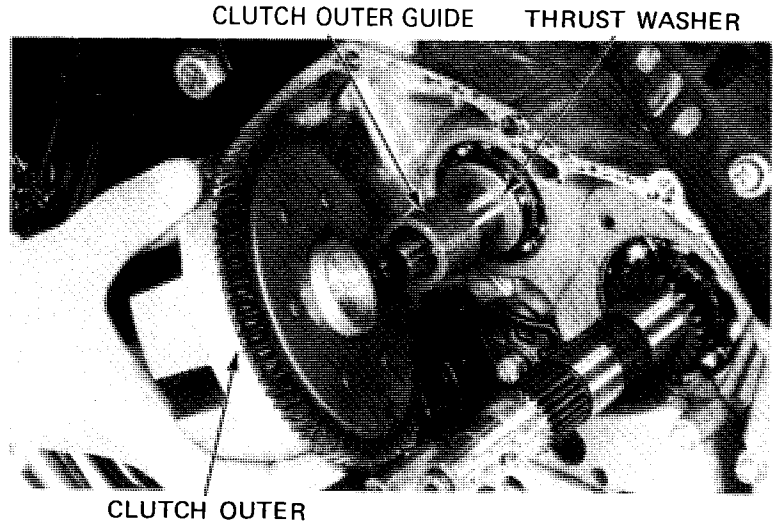

INSPECTION

Check the slots of the clutch outer for nicks, cuts or indentations made by the clutch discs. Replace if necessary.

Measure the I.D. of the clutch outer guide.

SERVICE LIMIT: 20.05 mm (0.789 in)

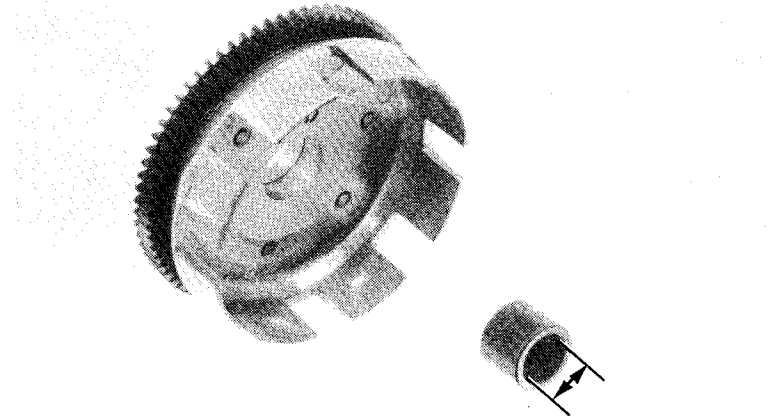

Measure the spring free length.

SERVICE LIMIT: 25.0 mm (0.98 in)

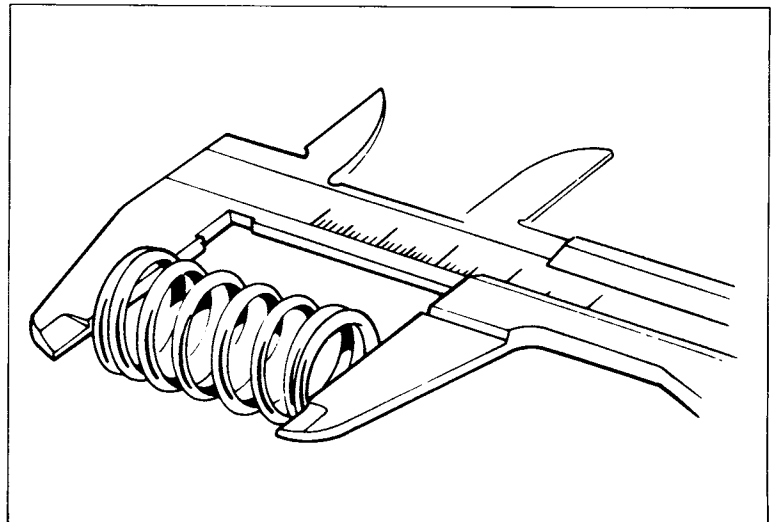

Replace the clutch discs if they show signs of scoring or discoloration.

Measure the disc thickness.

SERVICE LIMIT: 2.6 mm (0.10 in)

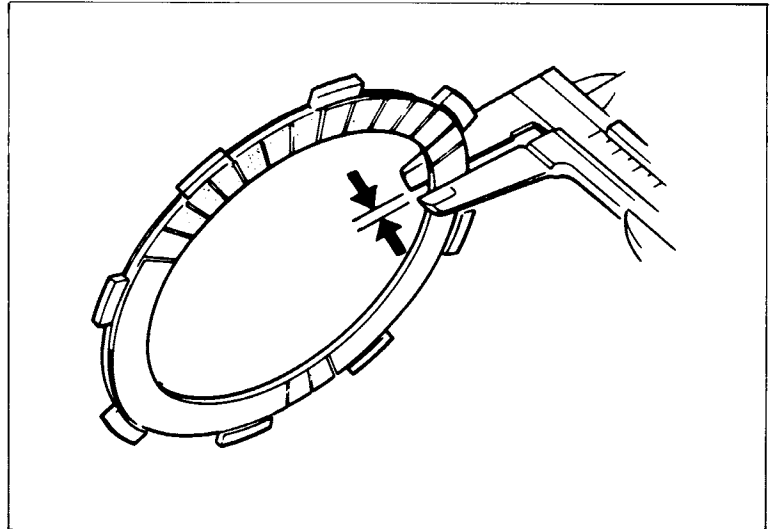

Check for plate and disc warpage on a surface plate using a feeler gauge.

SERVICE LIMIT: 0.20 mm (0.008 in)

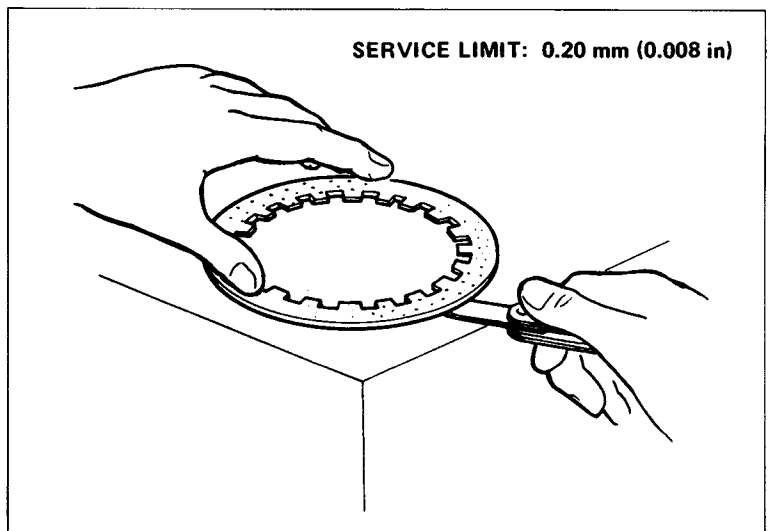

INSTALLATION

Assemble the clutch pressure plate, discs, plate and clutch center.

NOTE

- Stack the discs and plates alternately.
- Coat new clutch discs with engine oil.

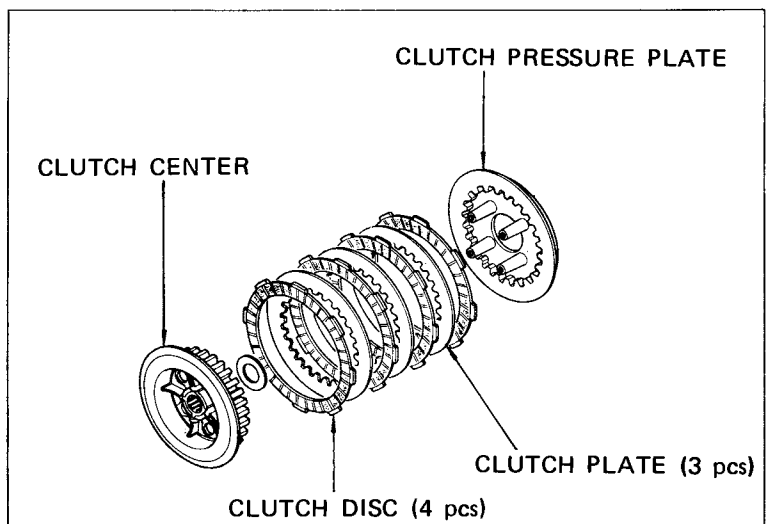

CLUTCH/OIL PUMP

Install the thrust washer, clutch outer guide, and clutch outer.

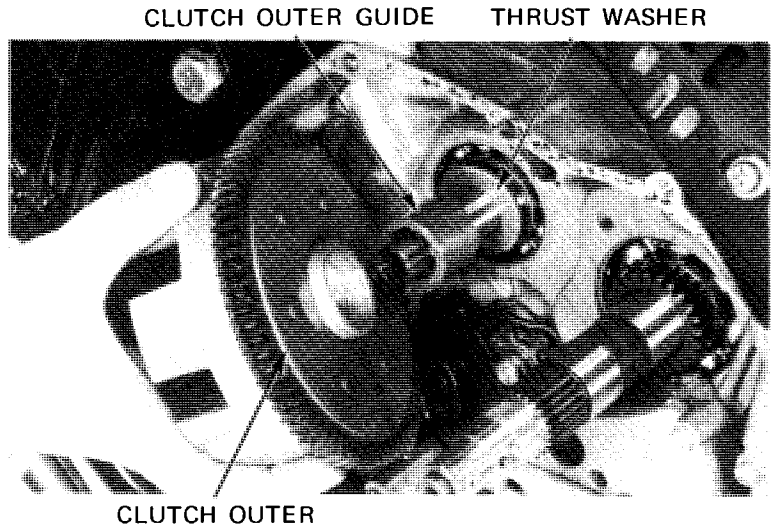

Install the thrust washer and clutch assembly. Install the lock washer with the "OUTSIDE" facing out.

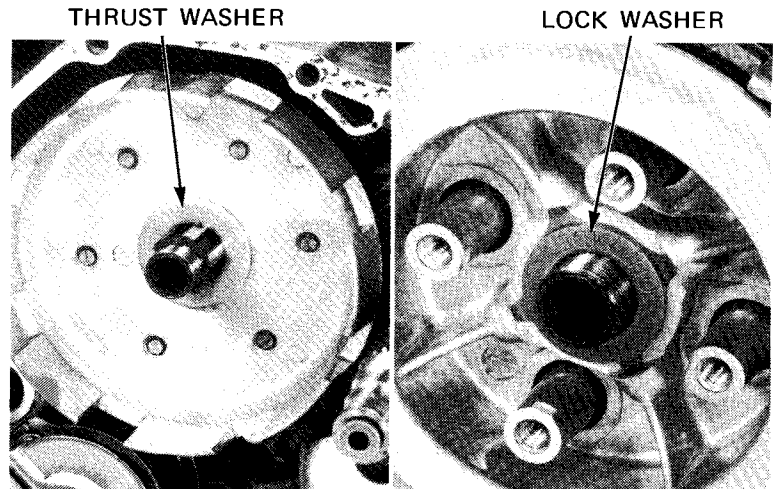

Install the clutch center holder with the clutch bolts.

Tighten the lock nut.

TORQUE:

50–60 N·m (5.0–6.0 kg·m, 36–43 ft·lb)

Install the clutch spring and lifter plate. Tighten the clutch bolts.

Install the bearing and push rod.

Install the centrifugal clutch (Page 8–8).

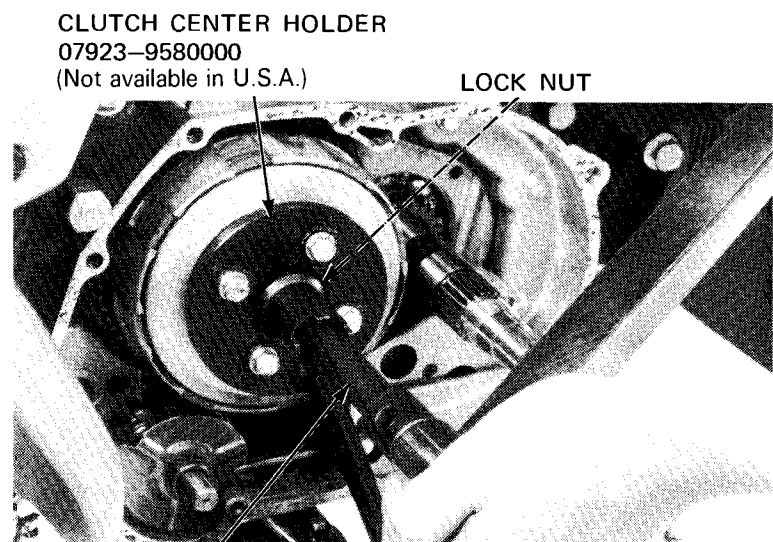

LOCK NUT WRENCH

20 x 24 mm 07716–0020100 OR 07916–3710000

OIL PUMP

REMOVAL

Remove the centrifugal clutch (Page 8-5).
Remove the manual clutch (Page 8-11).

Remove the clutch lifter cam, ball retainer and clutch lifter.

CLUTCH LIFTER

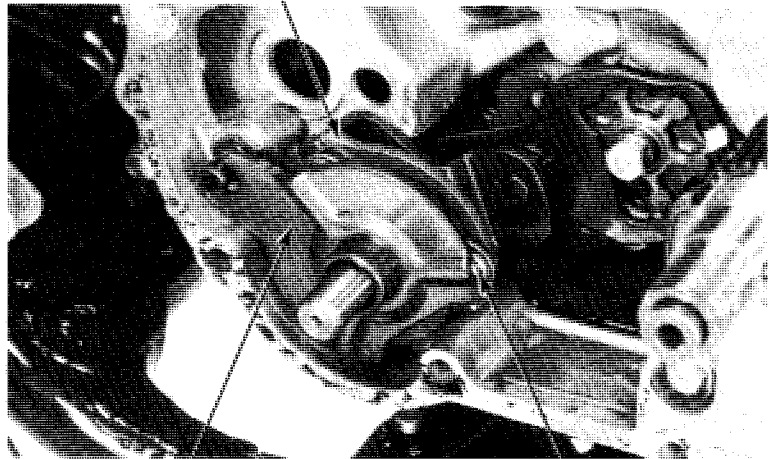

CLUTCH LIFTER CAM

BALL RETAINER

Remove the right crankcase spacer by removing the four bolts.

RIGHT CRANKCASE SPACER

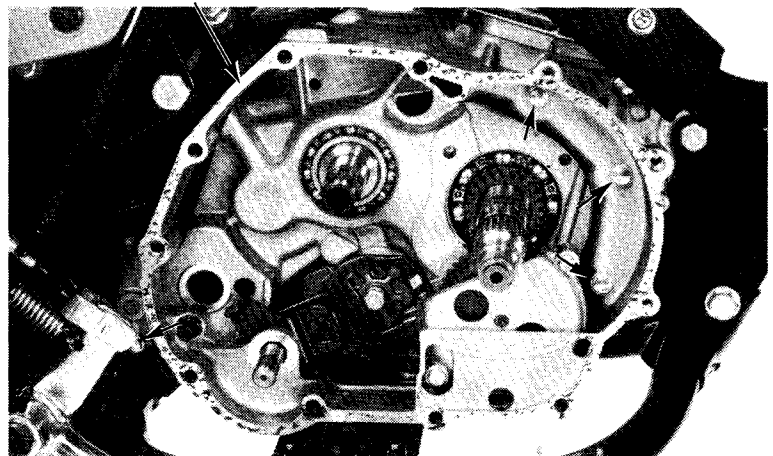

Remove the gasket and dowel pins.

GASKET

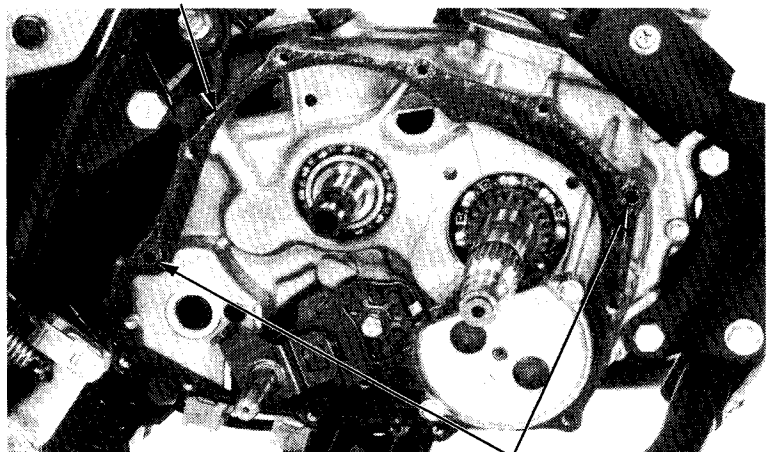

DOWEL PINS

CLUTCH/OIL PUMP

Align the oil pump setting screws with the gear cover holes and remove the oil pump setting screws.

Remove the O-rings.

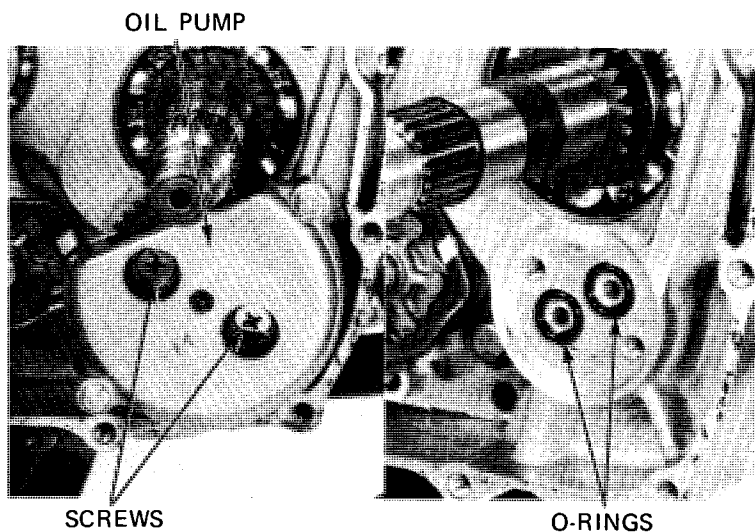

OIL PUMP DISASSEMBLY

Remove the oil pump cover and gasket.

Remove the oil pump inner and outer rotors.

Remove the bolts and pump gear cover.

Remove the pump driven gear.

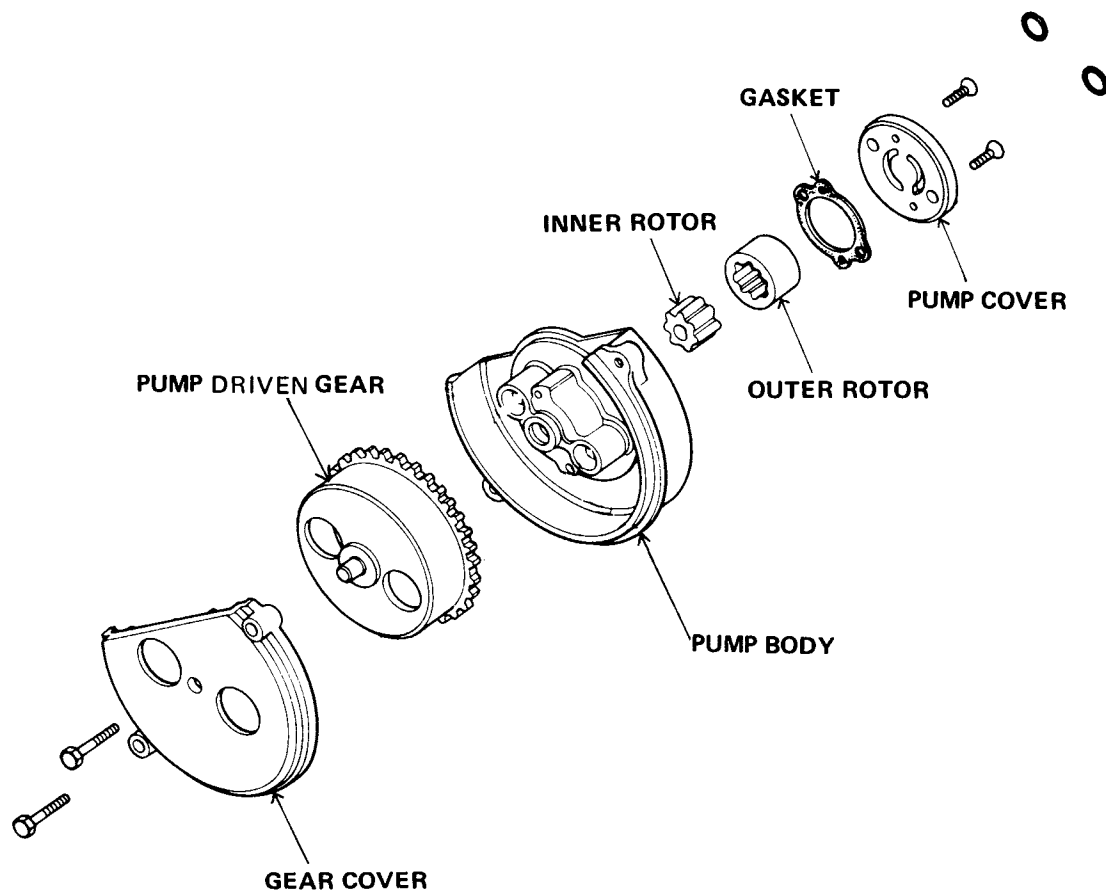

OIL PUMP INSPECTION

Measure the pump body clearance.

SERVICE LIMIT: 0.40 mm (0.016 in)

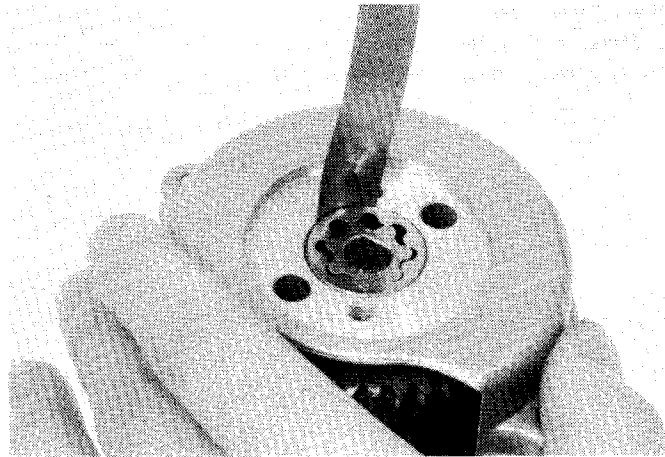

Measure the pump tip clearance.

SERVICE LIMIT: 0.20mm (0.008 in)

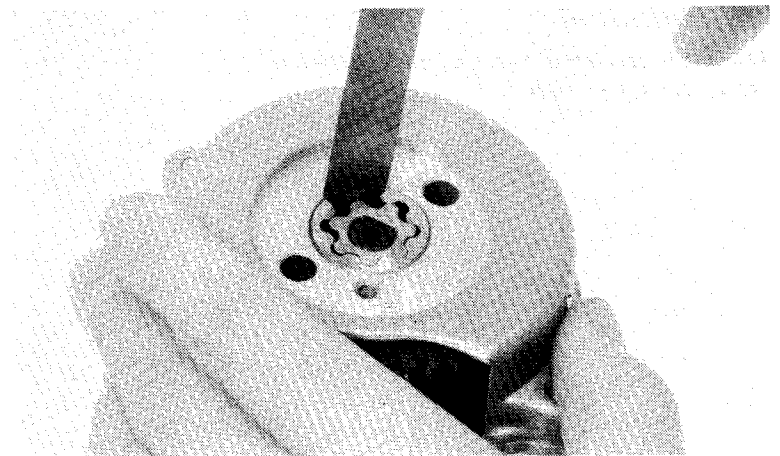

OIL PUMP ASSEMBLY

Install the pump gear and gear cover onto the oil pump body.

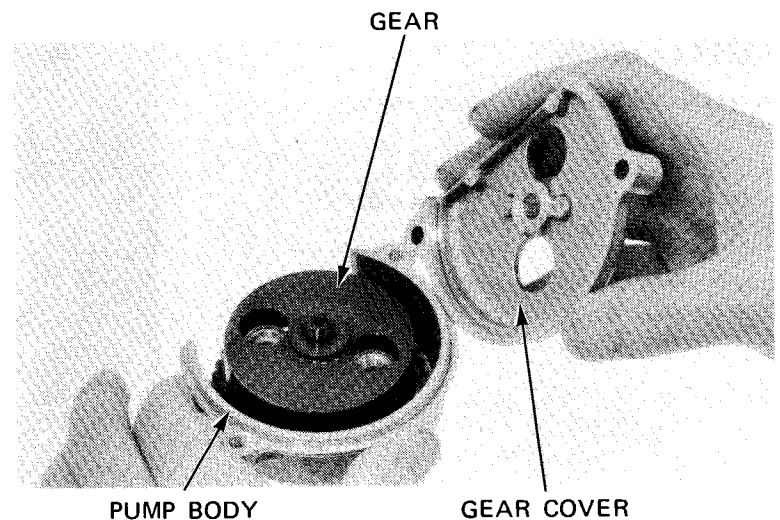

CLUTCH/OIL PUMP

Install the inner and outer rotors.
Install the gasket and install the pump cover by aligning the cover center with the gear shaft.

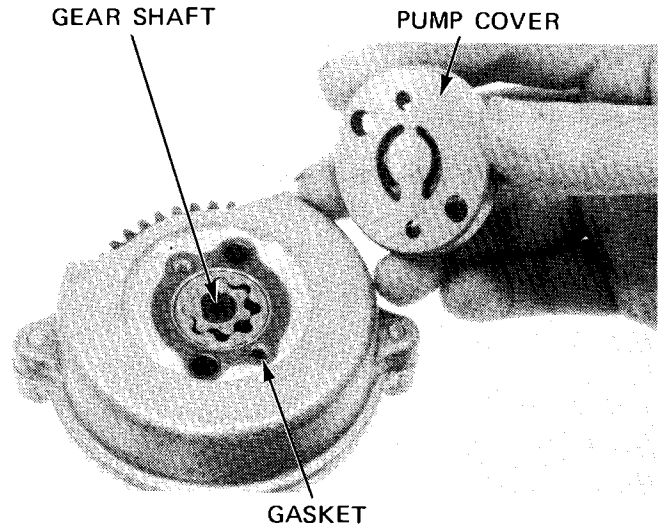

Tighten the screws.
Check the operation of the pump by rotating the pump gear by hand.

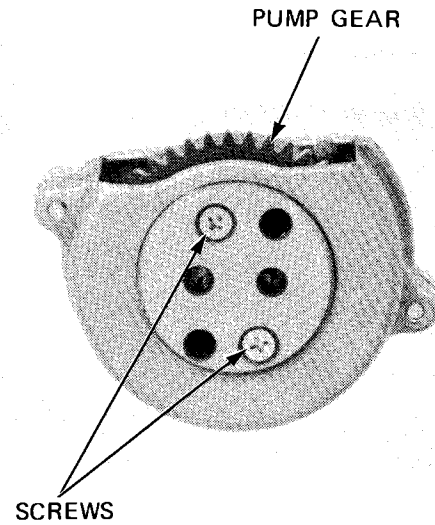

INSTALLATION

Install the O-rings and install the pump.

NOTE

Make sure that the O-rings remain in place when installing the pump.

Install the oil pump assembly.
Tighten the screws securely.

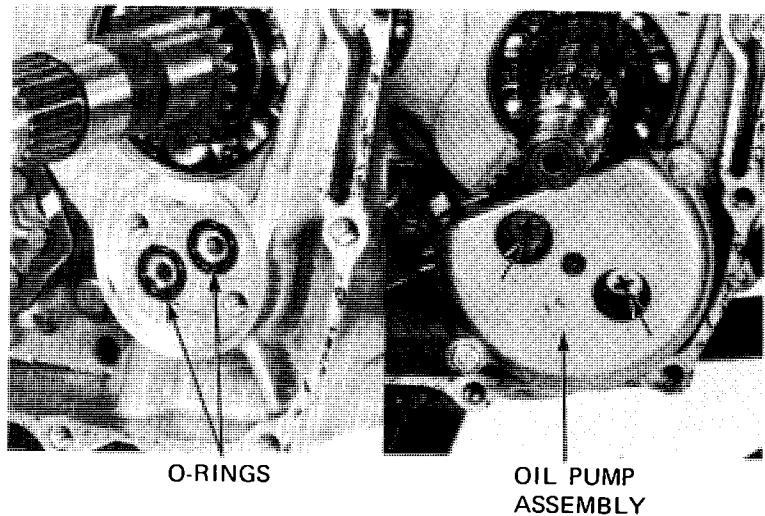

GEARSHIFT LINKAGE

DISASSEMBLY

Remove the following:

- right crank case cover (Page 8–3).
- centrifugal clutch and manual clutch (Page 8–5, 8–11).
- clutch lifter cam (Page 8–15).
- ball retainer and clutch lifter (Page 8–15).
- right crankcase spacer (Page 8–15).
- oil pump (Page 8–15).

Remove the gear shift pedal.
Pull the gear shift spindle out.

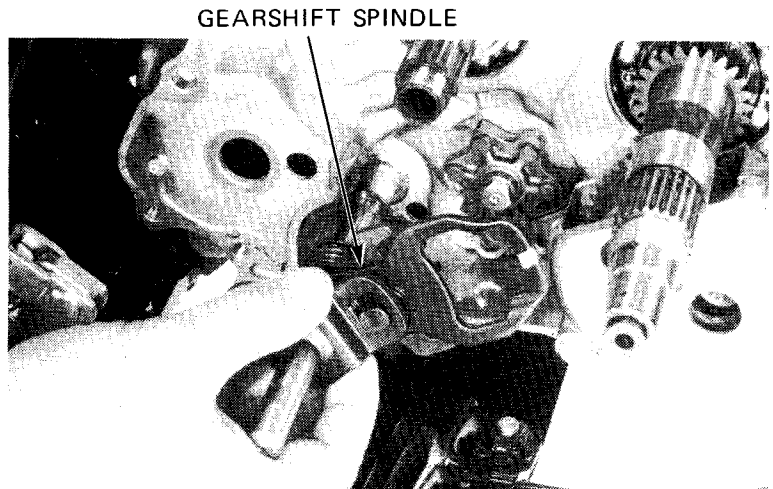

Remove the thrust washer and circlip and disassemble the gearshift spindle.

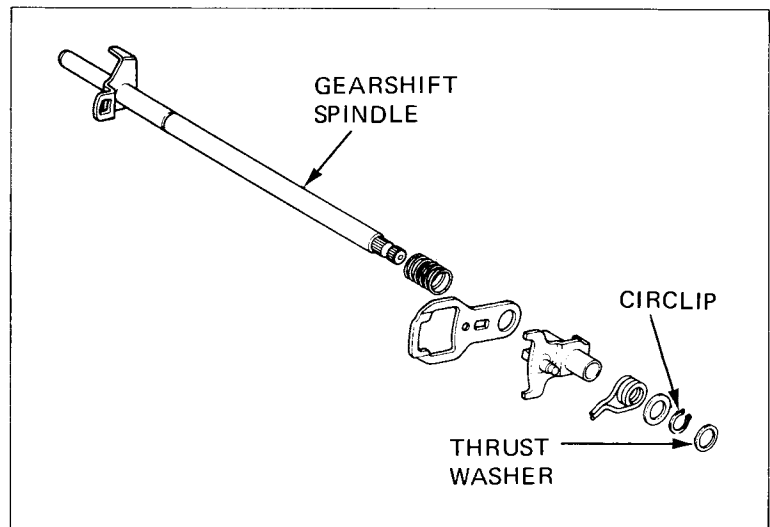

Remove the drum stopper, drum stopper arm and return spring.
Remove the dowel pin.

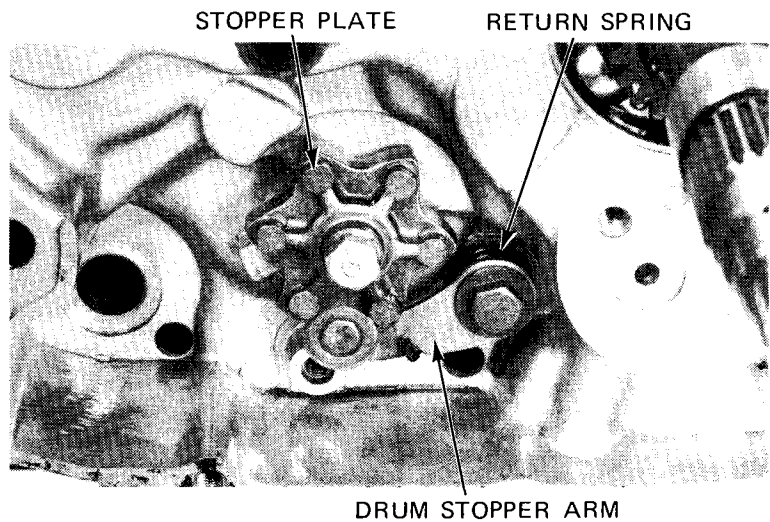

CLUTCH/OIL PUMP

ASSEMBLY

Install the drum stopper plate by aligning the hole and dowel pin.

Install the stopper arm with the return spring as shown.

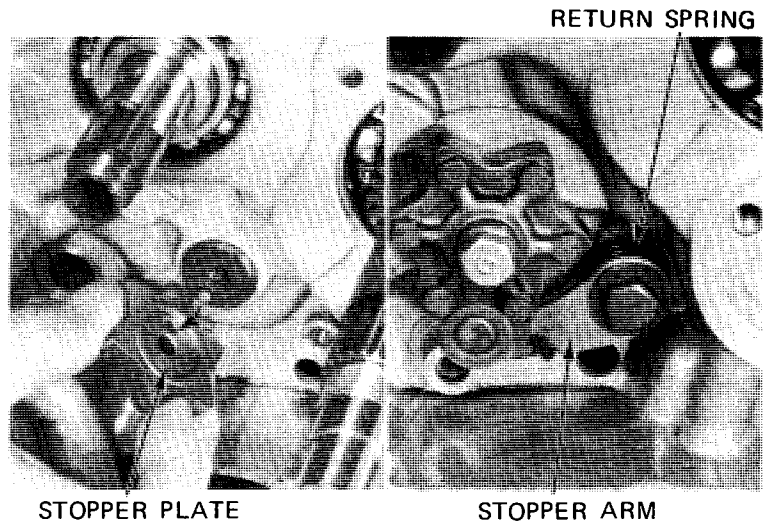

Assemble the gearshift spindle.

Install the gearshift spindle assembly.

Install the gear shift pedal.

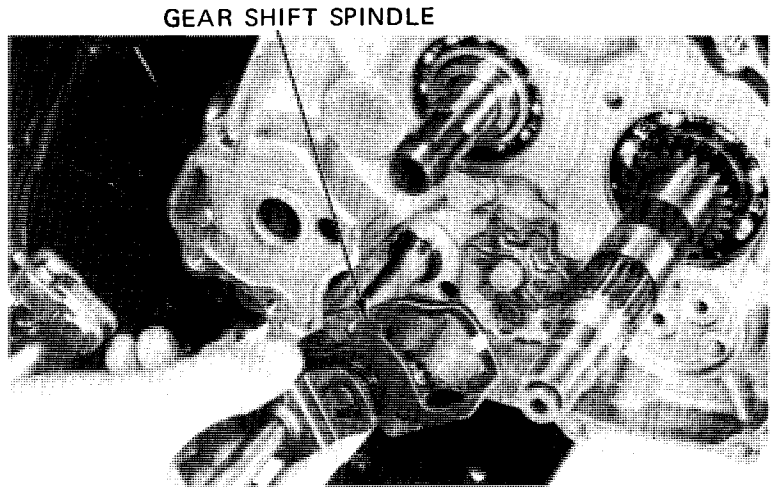

Install the oil pump (Page 8-18).

Install the dowel pins and a new gasket.

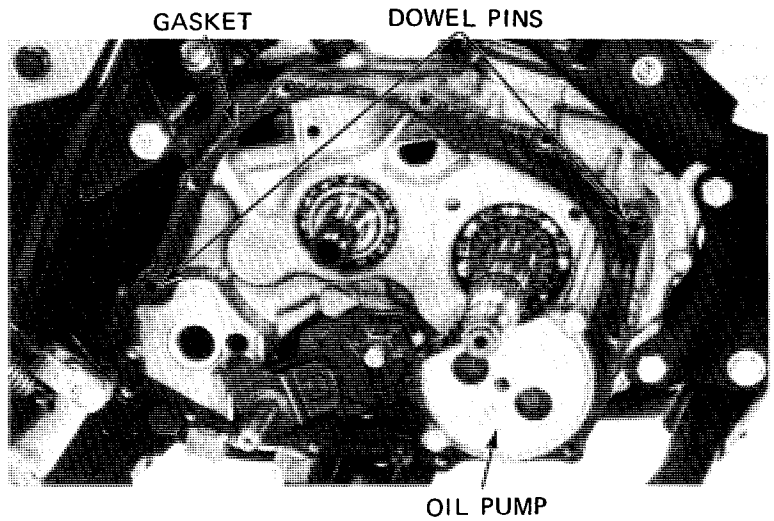

RIGHT
CRANKCASE SPACER

Install the right crankcase spacer.

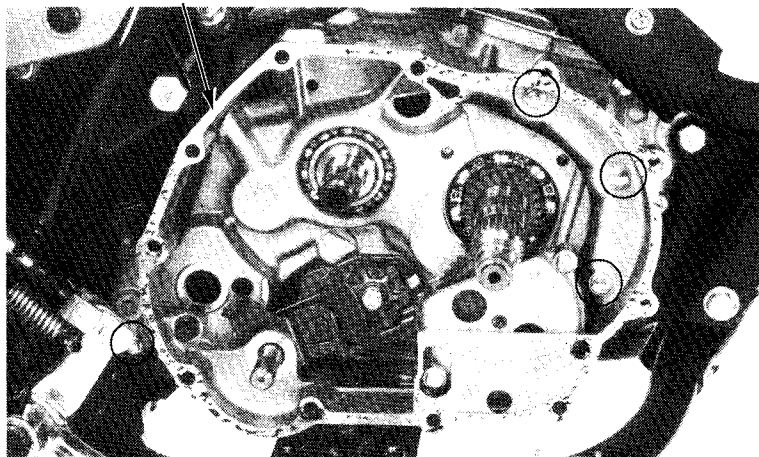

Install the thrust washer.

Install the clutch lifter by aligning the boss with the cut-out of the clutch lifter.

Install the ball retainer.

Install the clutch lifter cam by aligning the cut-out of the cam with the lifter cam stopper bolt on the crankcase spacer.

Install the manual clutch (Page 8–13).

Install the centrifugal clutch (Page 8–8).

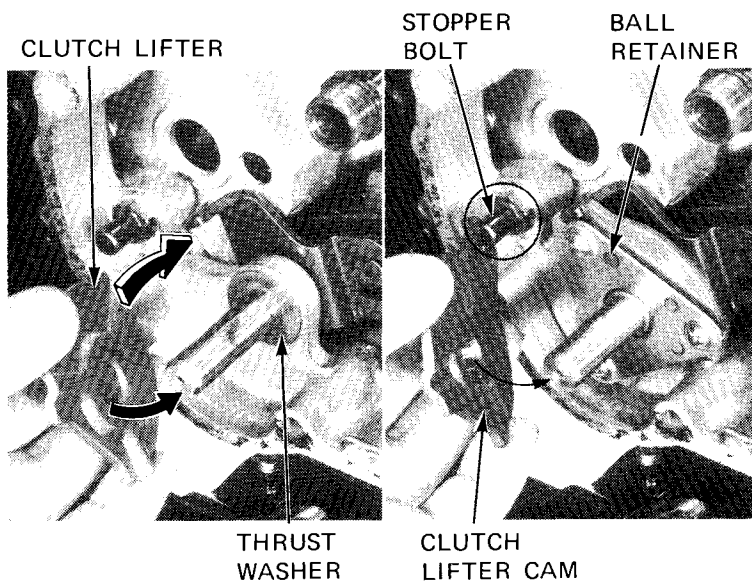

RIGHT CRANKCASE COVER INSTALLATION

Install the following:

- dowel pins and gasket.
- right crankcase cover.

Adjust the clutch (Page 3–16).

Fill the engine with the recommended oil (Page 2–2).

Start the engine and check the clutch for smooth operation.

Be sure there are no oil leaks.

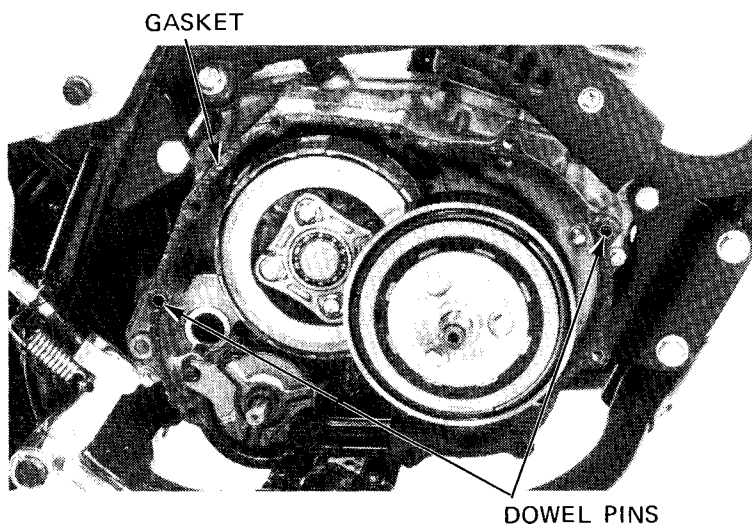

STARTER/A.C. GENERATOR

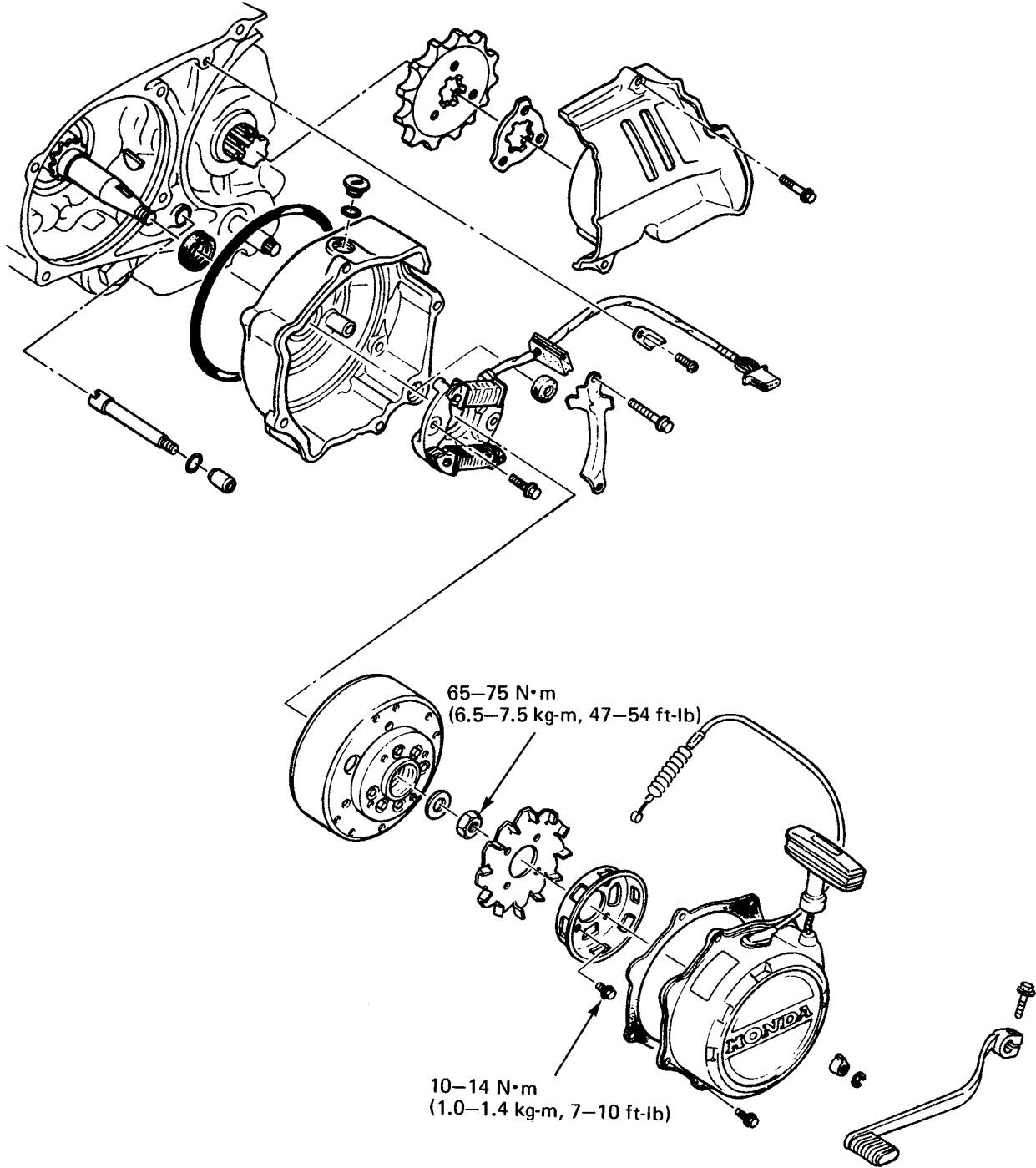

9. STARTER/ ALTERNATOR

| | |
|-----------------------------|------|
| SERVICE INFORMATION | 9-1 |
| TROUBLESHOOTING | 9-1 |
| RECOIL STARTER REMOVAL | 9-2 |
| RECOIL STARTER DISASSEMBLY | 9-3 |
| RECOIL STARTER ASSEMBLY | 9-6 |
| ALTERNATOR REMOVAL | 9-9 |
| ALTERNATOR INSTALLATION | 9-10 |
| RECOIL STARTER INSTALLATION | 9-12 |

SERVICE INFORMATION

GENERAL

- This section covers removal and installation of the recoil starter and alternator section.
- For alternator inspection and troubleshooting, refer to section 14.

TORQUE VALUES

| | |
|-----------------------------------|---------------------------------------|
| Alternator rotor nut | 65–75 N·m (6.5–7.5 kg-m, 47–54 ft-lb) |
| Recoil starter driven pulley bolt | 10–14 N·m (1.0–1.4 kg-m, 7–10 ft-lb) |

TOOLS

| | |
|---------------------------|------------------------------------|
| Common | |
| Flywheel and Rotor Puller | 07733–0010000 or 07933–0010000 |
| Special | |
| Flywheel Holder | 07925–9580001 Not available in USA |

TROUBLESHOOTING

Engine does not turn when operating recoil starter

1. Faulty starter ratchet
2. Faulty starter driven pulley
3. Faulty starter driven pulley

Starter rope does not recoil

- Faulty recoil spring

RECOIL STARTER REMOVAL

Disconnect the decompression cable from the valve lifter.
Loosen the clamp and remove the cable from the clamp.

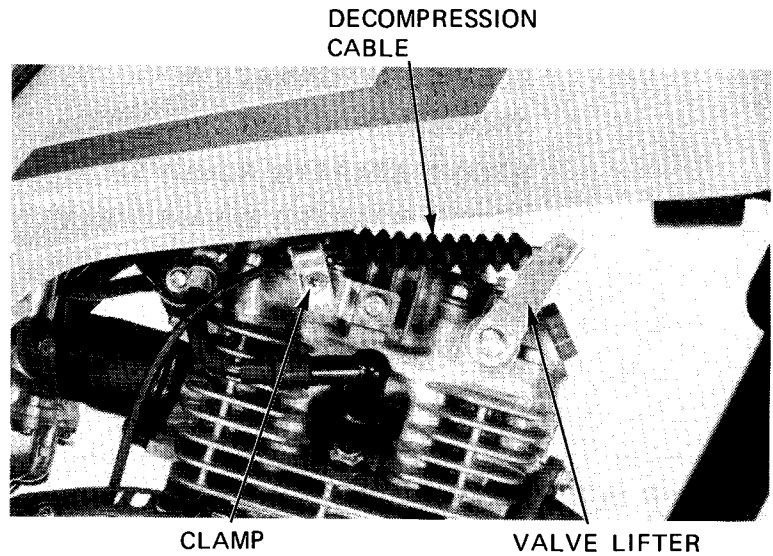

Shift the transmission into the neutral.
Remove the gearshift pedal.

Remove the cable from the clamp.

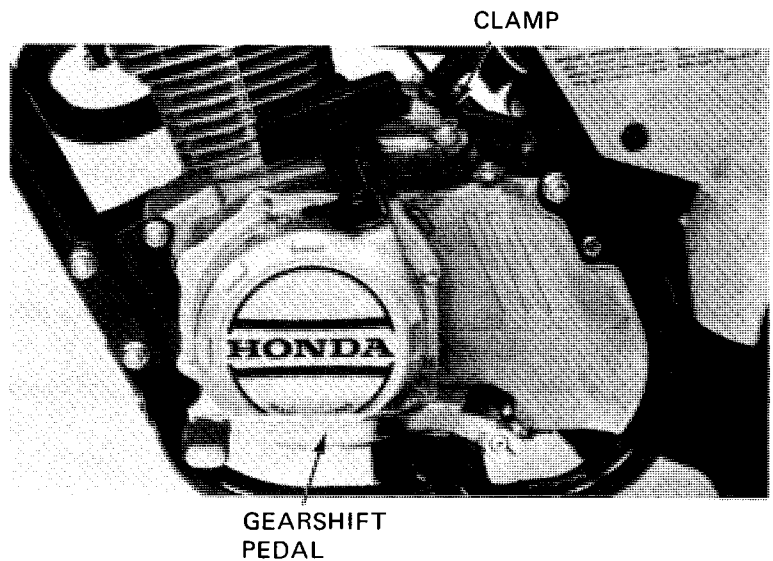

Remove the neutral indicator by removing the circlip.

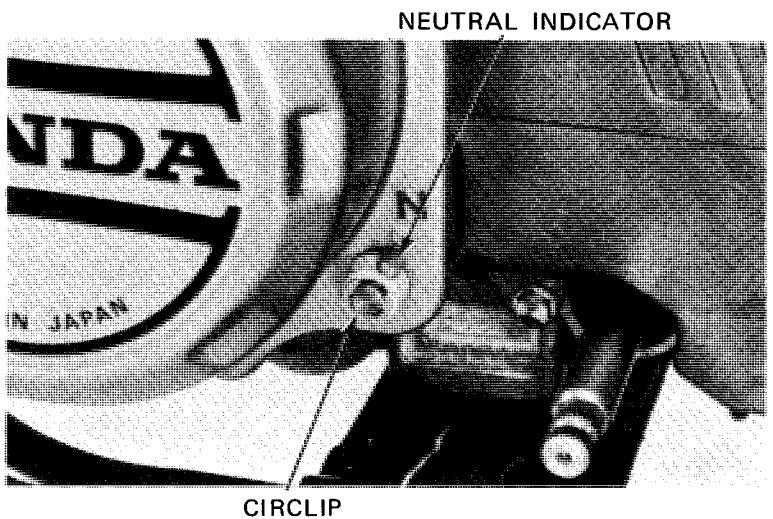

Remove the recoil starter by removing the bolts.

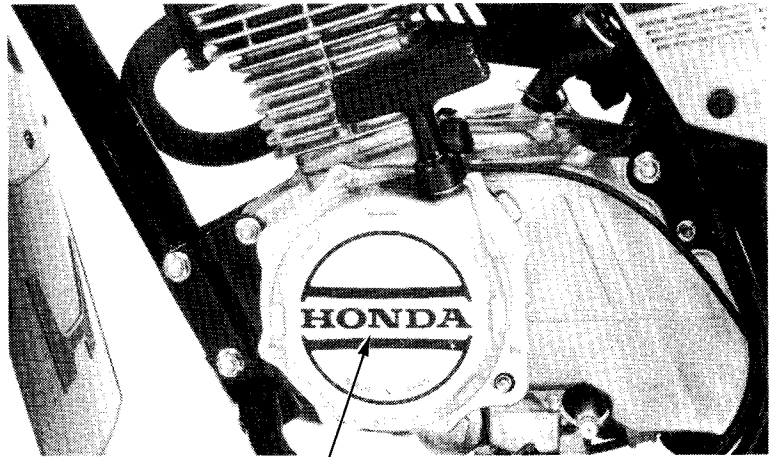

RECOIL STARTER

RECOIL STARTER DISASSEMBLY

Remove the recoil backing plate.

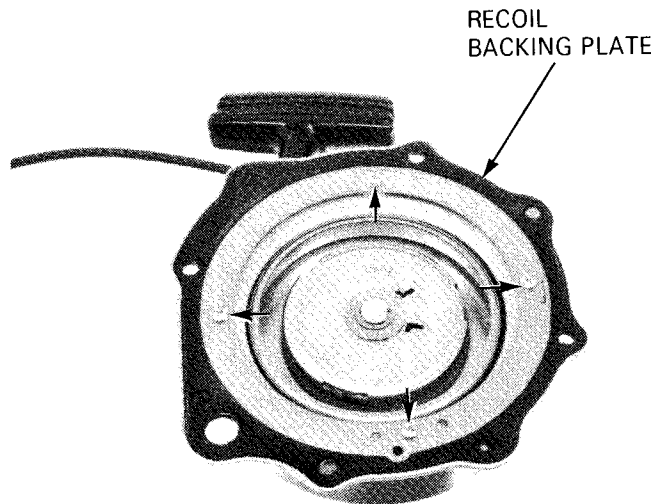

Pull up the hook case ring and remove the hook plate from the cable as shown.

Remove the hook plate cushion from the hook case ring.

Remove the cable with grommet from the case.

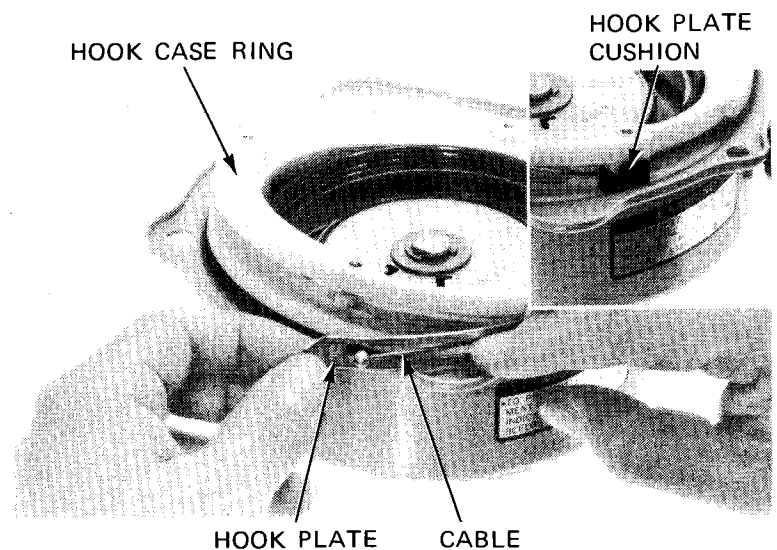

STARTER/ALTERNATOR

Remove the hook case ring and friction spring.

Check the friction spring.

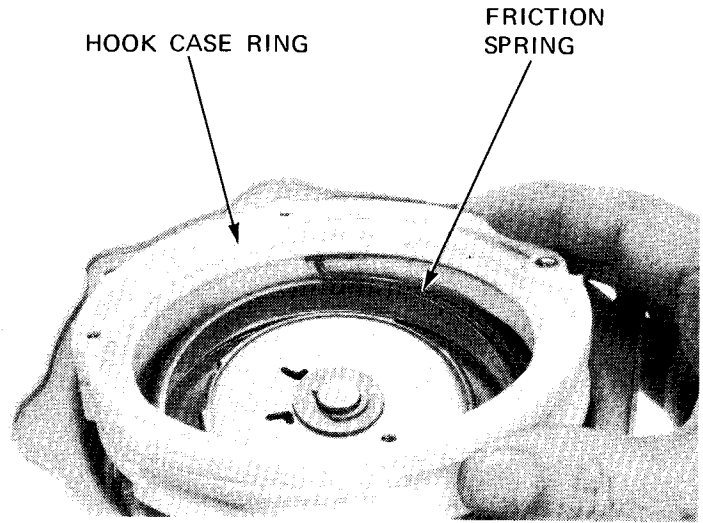

Remove the circlip.
Remove the thrust washer and ratchet cover.

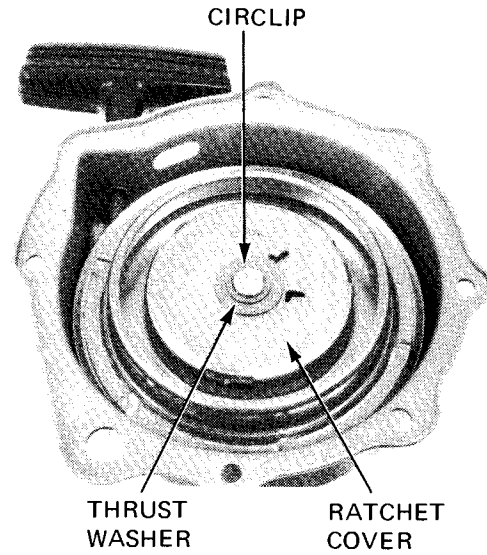

Remove the ratchets and ratchet springs.
Remove the spring and thrust washer.

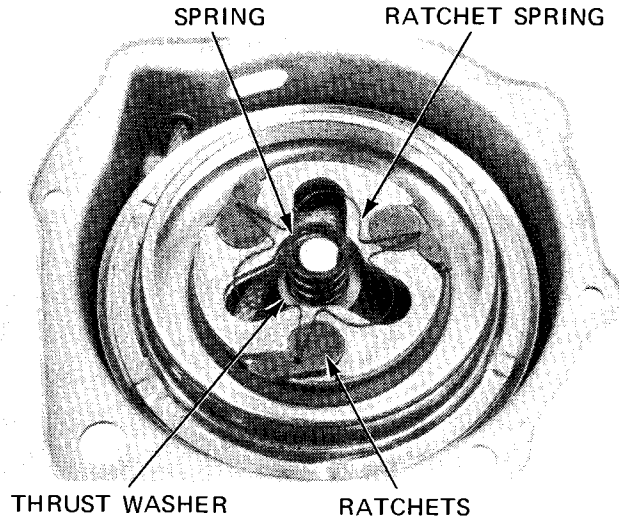

Remove the starter grip and release the starter rope slowly.

Remove the starter drive pulley by turning the pulley counterclockwise.

CAUTION:

Wear eye protection and use care when removing the drive pulley and starter spring. The spring can pop out of the housing if care is not used.

STARTER DRIVE PULLEY

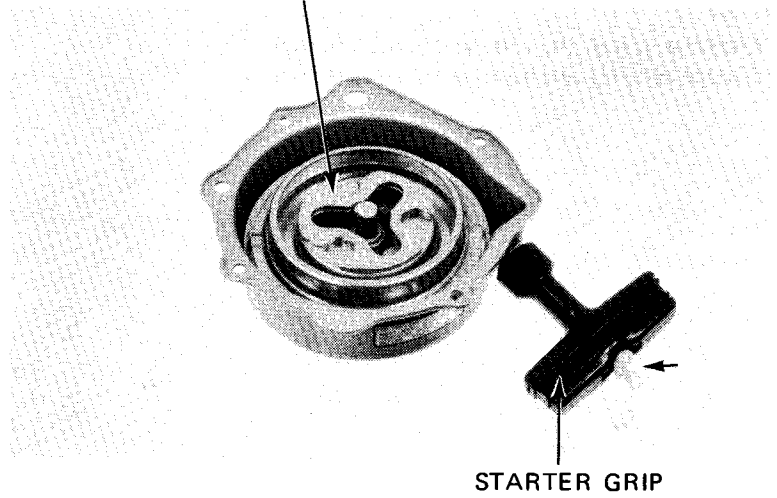

STARTER GRIP

Check the recoil starter spring for breakage. Remove the starter spring, if necessary.

SPRING

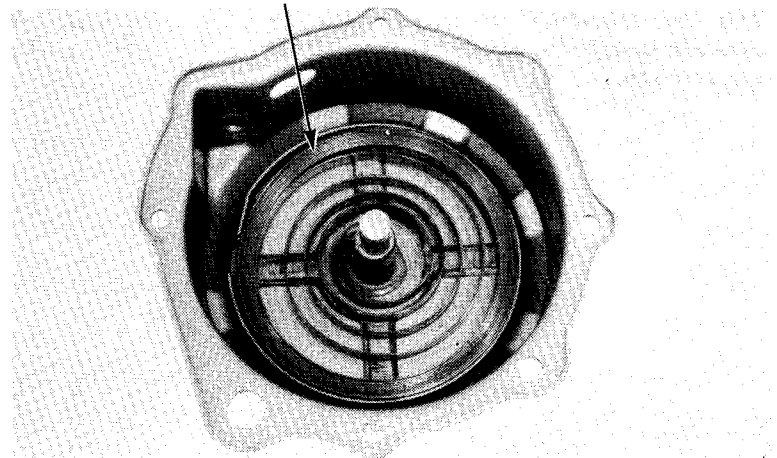

RECOIL STARTER INSPECTION

Check the starter rope and ratchet for wear or damage.

Check the ratchet spring for damage. Replace any damaged parts.

RATCHET SPRING

RATCHET

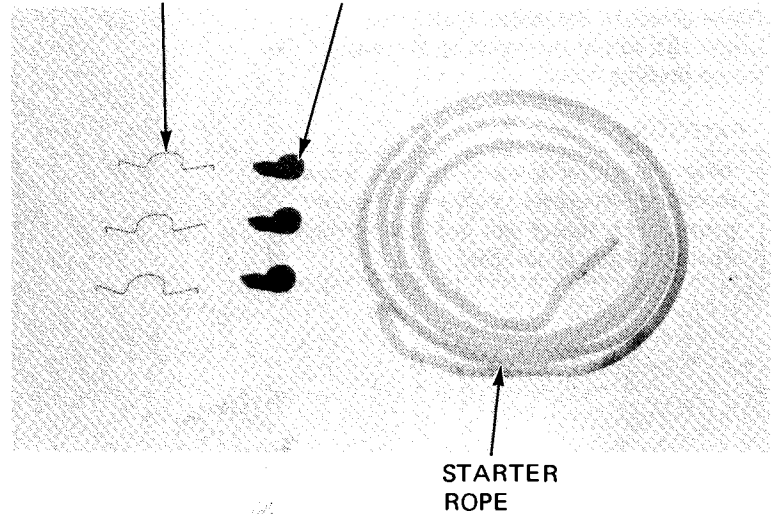

STARTER ROPE

RECOIL STARTER ASSEMBLY

Knot the end of the rope and route the rope through the hole on the drive pulley as shown.

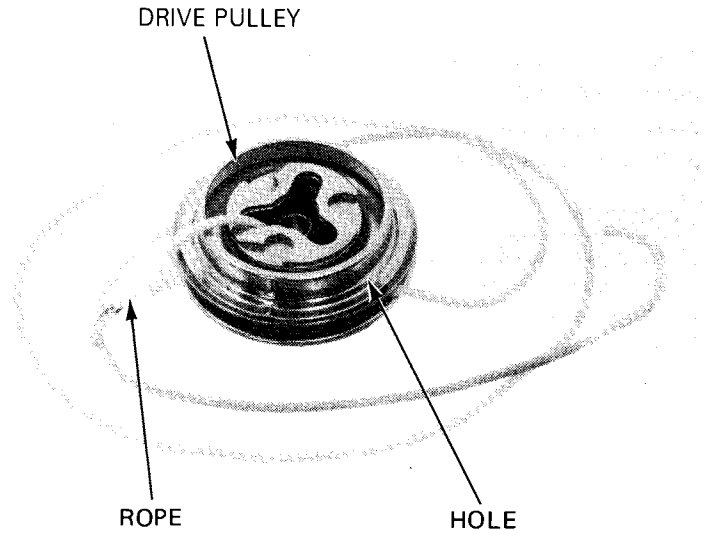

Wrap the rope around the starter pulley in a clockwise direction as viewed from the ratchet side as shown.

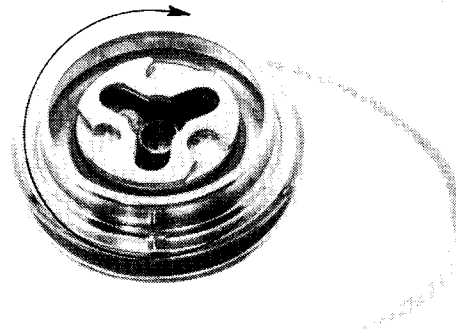

Apply grease to the pulley shaft.
Install the spring by hooking the end to the starter housing hook.

CAUTION:

Wear eye protection and use care when installing the drive pulley and starter spring. The spring can pop out of the housing if care is not used.

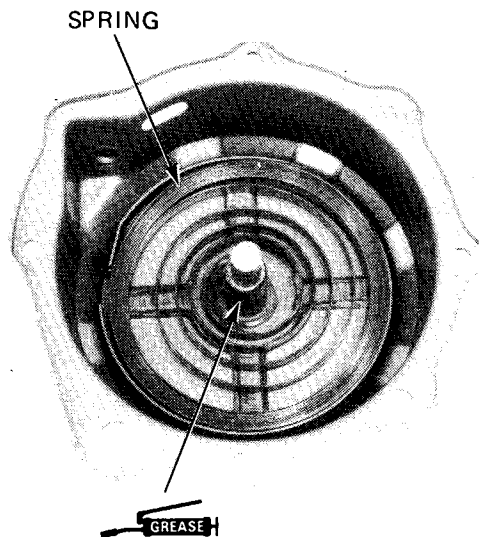

Install the starter drive pulley by turning it clockwise to align the spring end with the starter drive pulley boss.

Route the starter rope through the pulley cut-out.

Preload the starter spring by turning the pulley 2 turns clockwise.

Thread and knot the rope end through the grip.

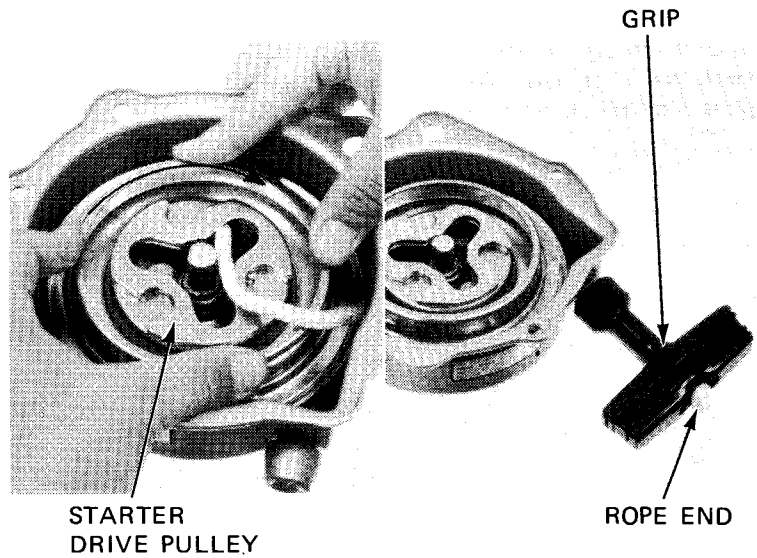

Apply grease to the ratchets.
Install the ratchets and ratchet springs.

Coat the thrust washer with grease and install it.

Install the spring.

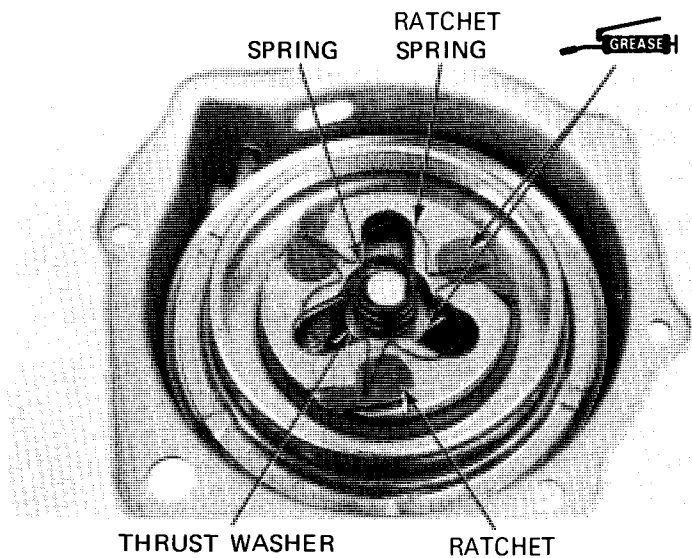

Install the ratchet cover, thrust washer and circlip.

Check recoil starter operation by pulling the starter grip.

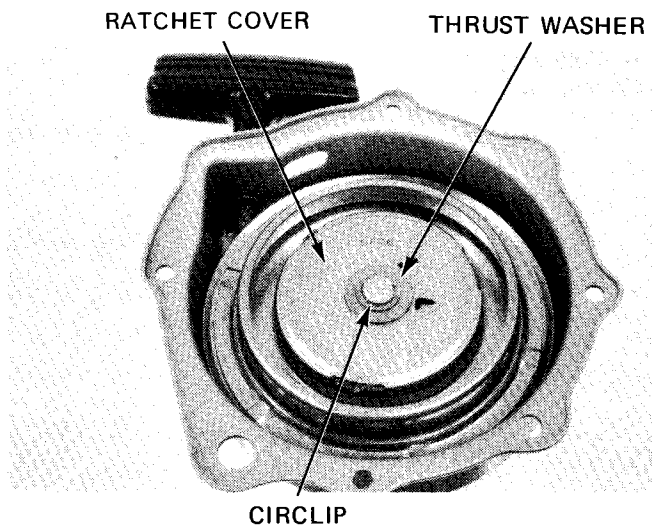

STARTER/ALTERNATOR

Install the spring over the ratchet cover.
Install the hook case ring by aligning the spring end with the hook case ring groove.

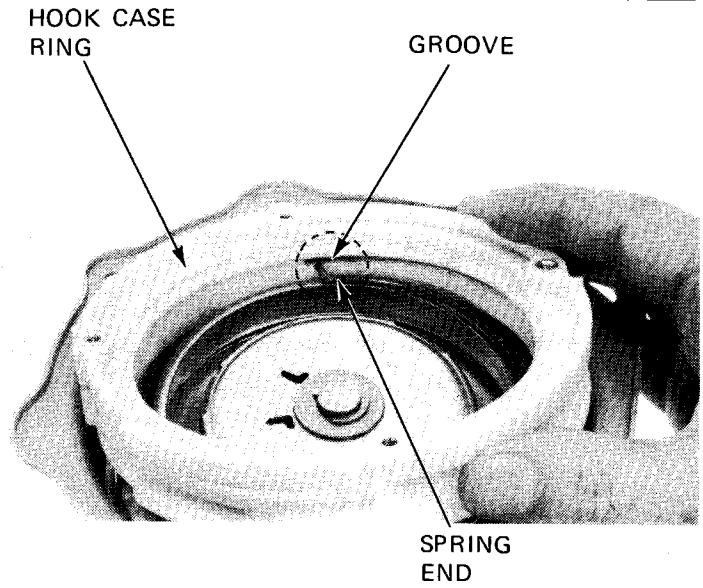

Route the decompression cable through the recoil starter case.
Install the hook plate cushion on the hook case ring.

Route the cable through the groove of the hook plate and install the hook plate as shown.
Install the grommet.

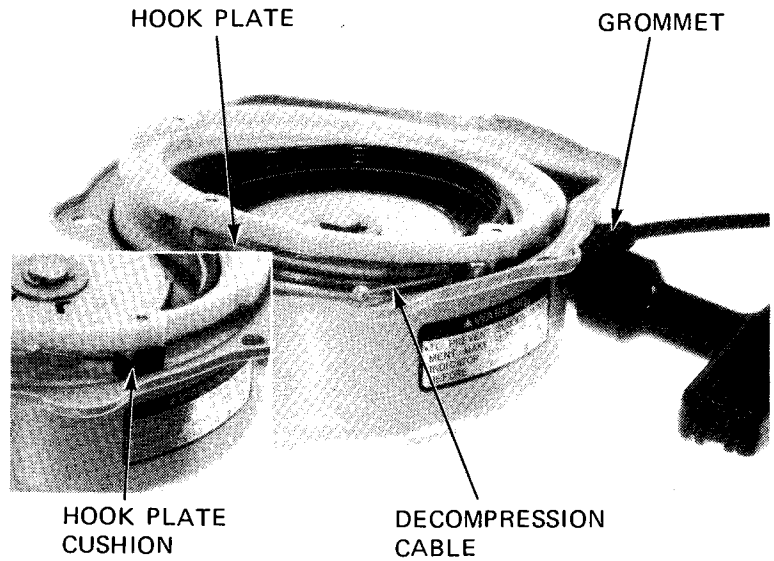

Install the recoil backing plate.
Tighten the four screws securely.

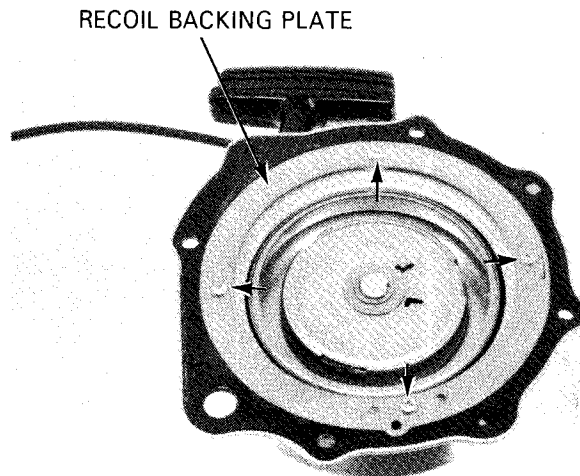

ALTERNATOR REMOVAL

Remove the recoil starter (Page 9-2).
Install a Flywheel Holder or use a screwdriver to prevent the rotor from turning.

FLYWHEEL HOLDER
07925-958000 Not available in U.S.A.

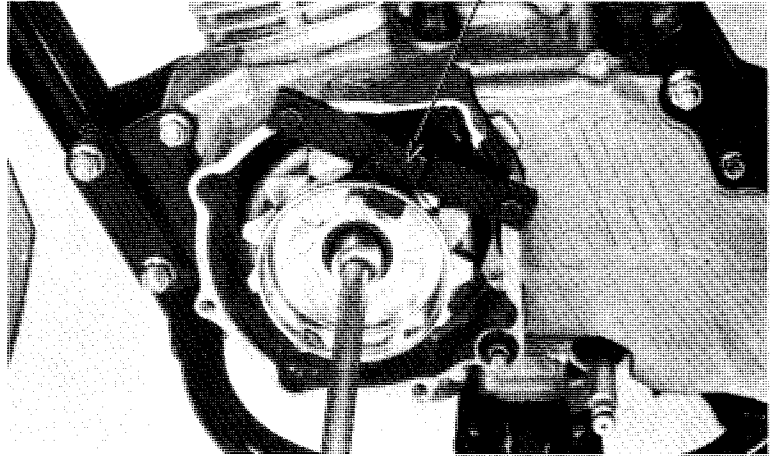

Remove the starter driven pulley and cooling fan.

STARTER
DRIVEN PULLEY

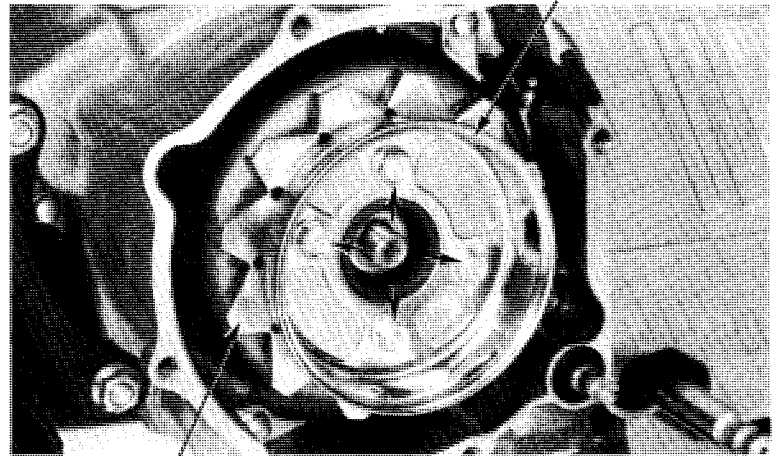

COOLING FAN

Loosen the Flywheel Holder setting bolts.
Remove the alternator rotor with the rotor puller.

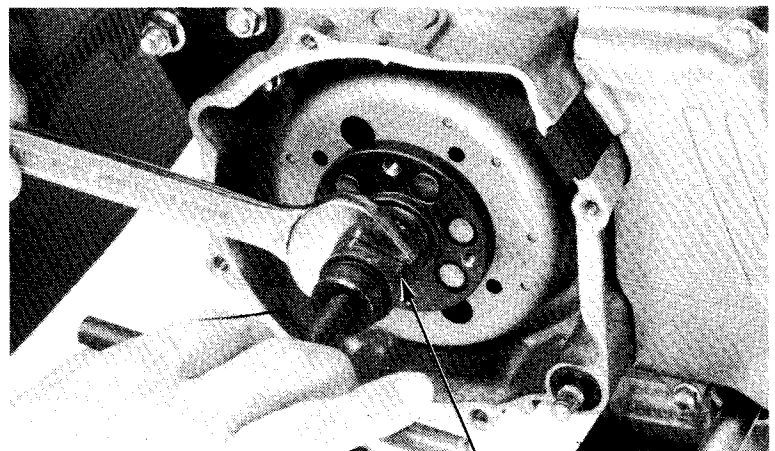

FLYWHEEL PULLER
07733-001000 OR 07933-001000

STARTER/ALTERNATOR

Remove the driver spricket cover.
Disconnect the alternator wire coupler.

Remove the wire band.

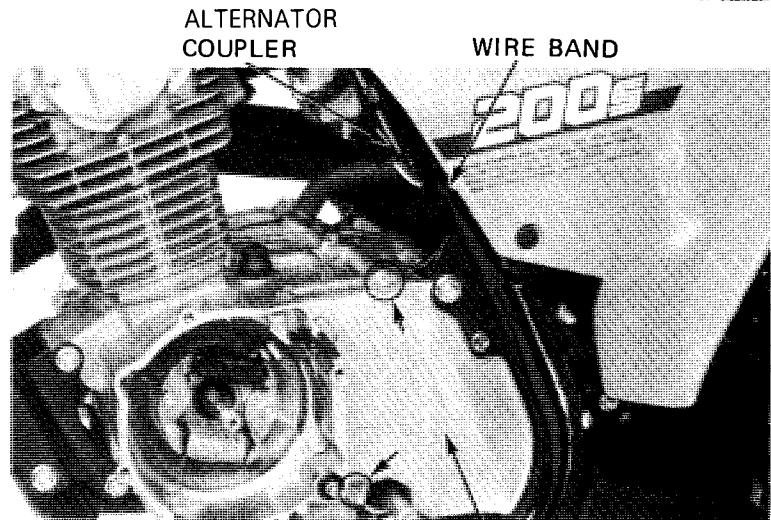

DRIVE SPROCKET
COVER

Remove the alternator wire holder and clamp.

Drain the engine oil.
Remove the alternator housing.
Remove the stator coils from the housing.

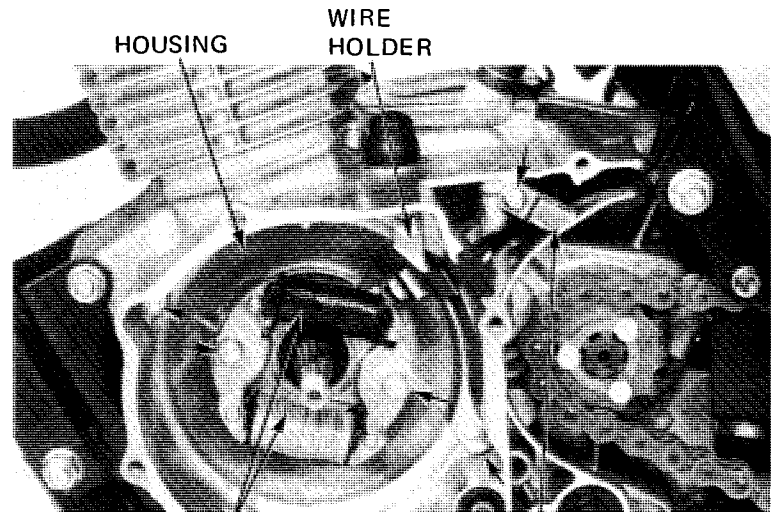

STATOR COILS

WIRE CLAMPS

ALTERNATOR INSTALLATION

Install the alternator stator coil onto the generator housing as shown.

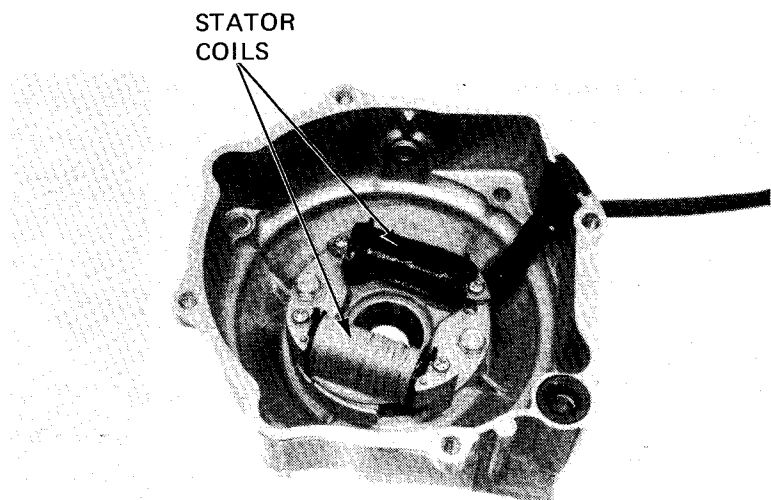

Install the dowel pin and O-rings.
Install the neutral indicator shaft.

Install the alternator housing by aligning the neutral indicator shaft groove with the gearshift drum cut-out.

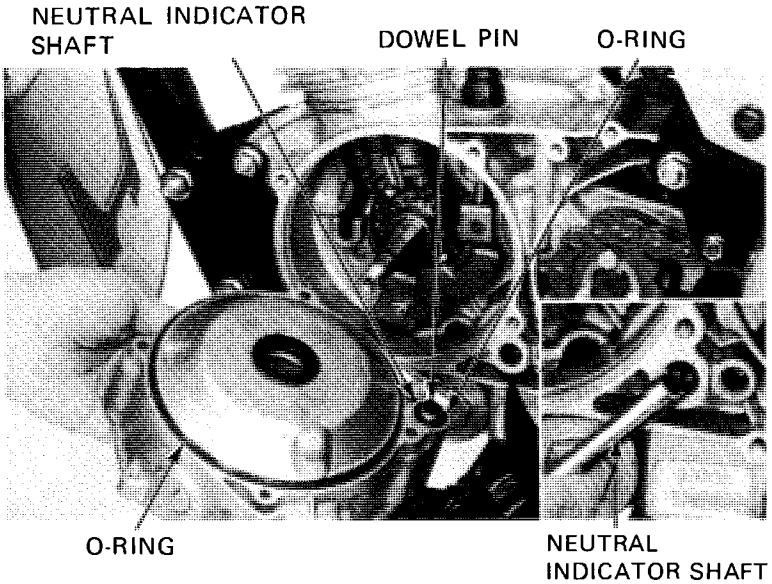

Tighten the housing bolts securely.

Install the alternator wire holder and clamp.

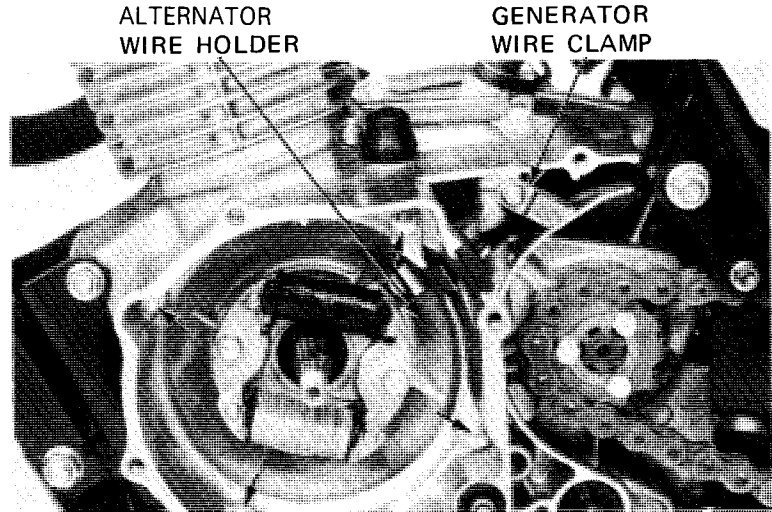

Install the drive sprocket cover.
Connect the alternator wire coupler.
Install the wire band as shown.

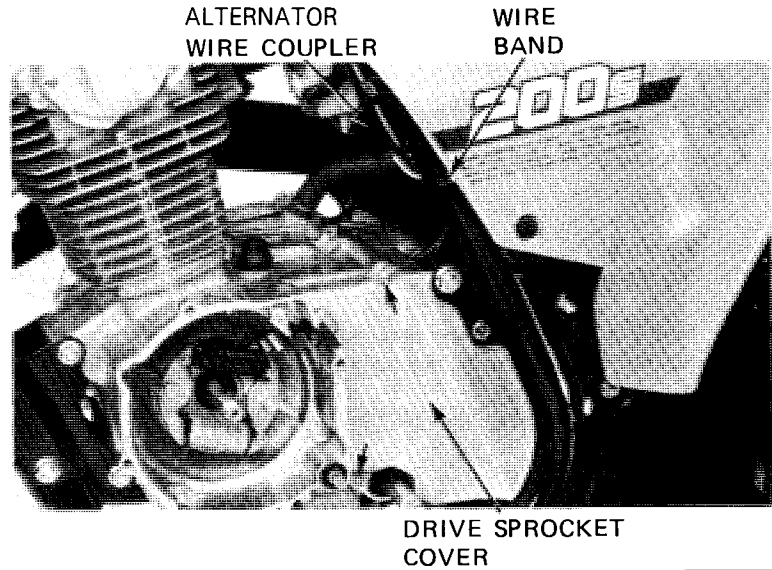

STARTER/ALTERNATOR

Install the rotor by aligning the keyway of the rotor with the woodruff key on the crankshaft.

Check for rotor-to-wire holder clearance.

MINIMUM CLEARANCE: 1 mm (0.04 in)

Replace or repair the wire holder, if the clearance is less than 1 mm (0.04 in).

Install the starter driven pulley and cooling fan.

**TORQUE: 10–14 N·m (1.0–1.4 kg·m,
7–10 ft·lb)**

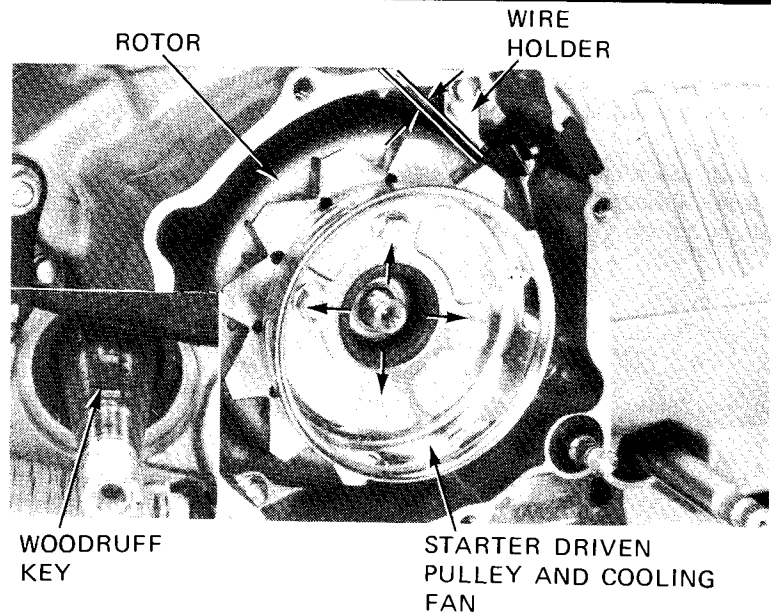

FLYWHEEL HOLDER

07925-9580000 Not available in U.S.A.

Install the Flywheel Holder.

Tighten the rotor nut.

**TORQUE: 65–75 N·m (6.5–7.5 kg·m,
47–54 ft·lb)**

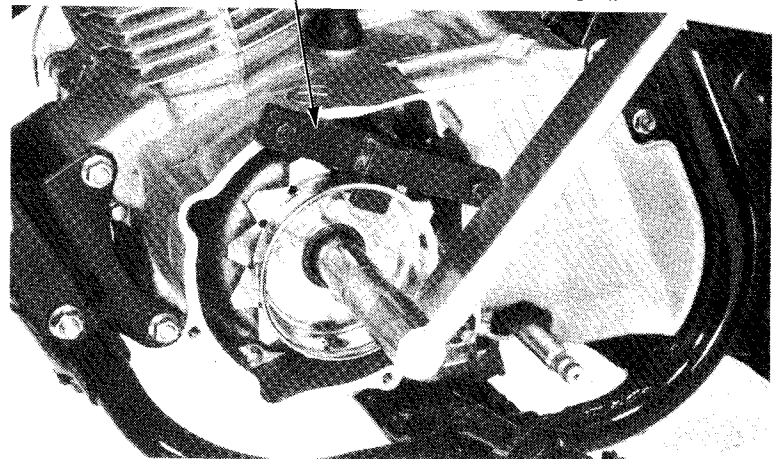

RECOIL STARTER INSTALLATION

Install the recoil starter.

Install the neutral indicator by aligning the indicator boss with the recoil starter housing "N" mark.

Install the circlip.

Install the gearshift pedal.

Check that the indicator aligns with the "N" mark when the transmission is in neutral.

Clamp the decompression cable by the clip as shown.

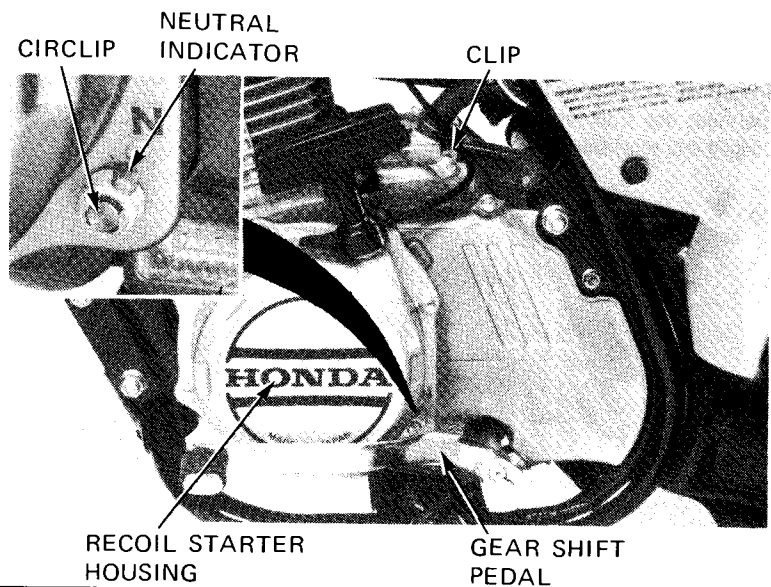

Connect the decompression cable to the valve lifter.

Clamp the cable and tighten the screw.

Make sure that the valve lifter operation is smooth by operating the recoil starter.

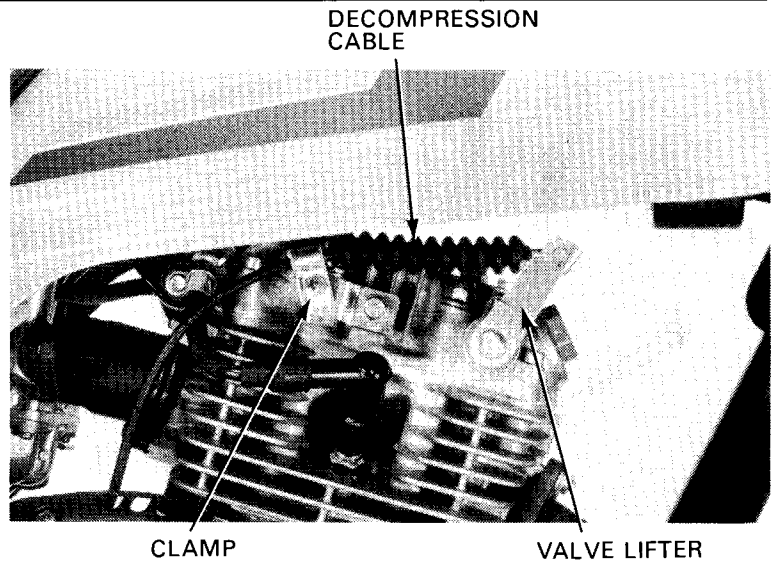

TRANSMISSION/CRANKSHAFT/KICK STARTER

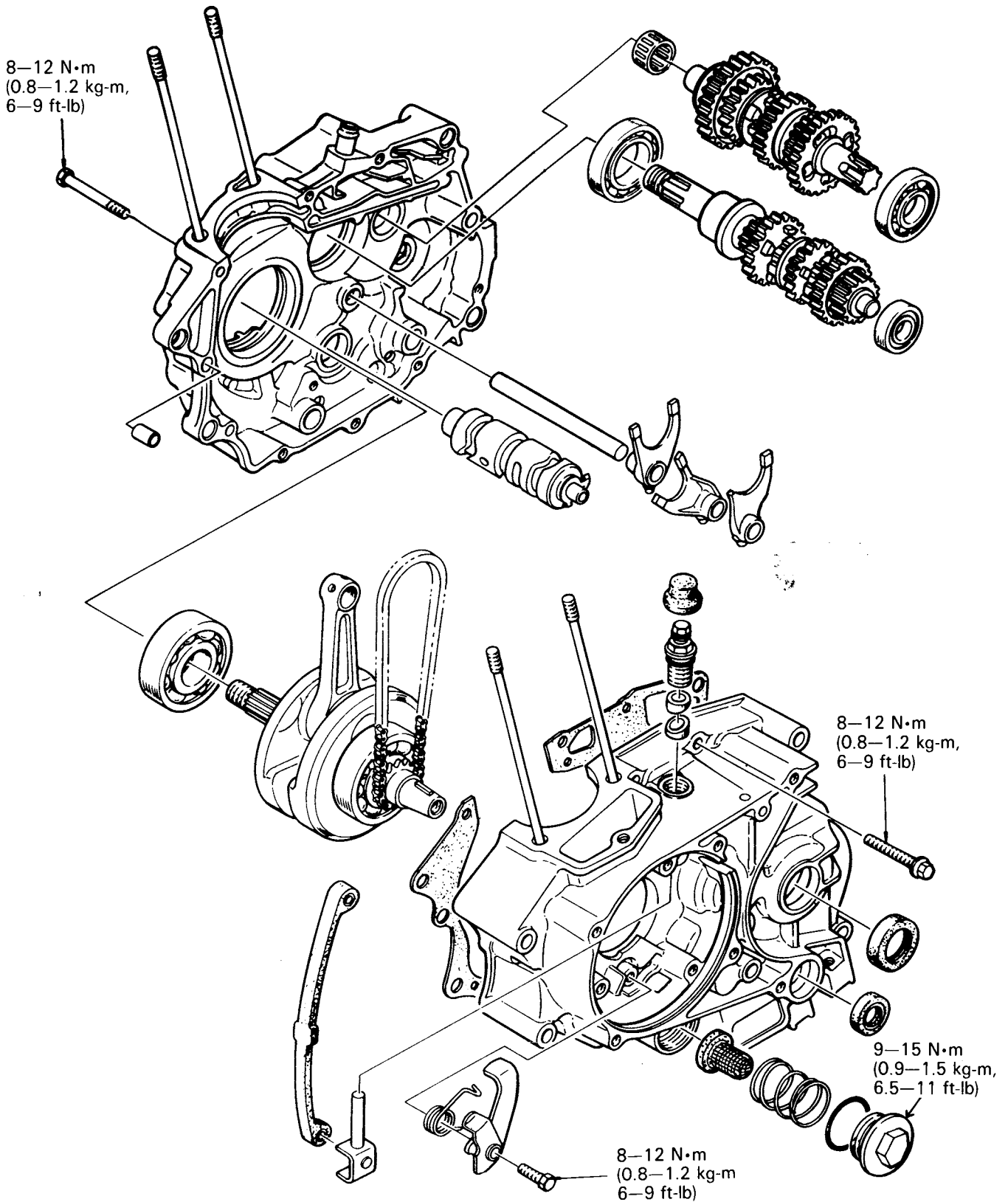

10. TRANSMISSION/CRANKSHAFT/ KICK STARTER

| | |
|--------------------------|------|
| SERVICE INFORMATION | 10-1 |
| TROUBLESHOOTING | 10-1 |
| CRANKCASE SEPARATION | 10-2 |
| CRANKSHAFT REMOVAL | 10-3 |
| TRANSMISSION DISASSEMBLY | 10-5 |
| TRANSMISSION ASSEMBLY | 10-7 |
| CRANKCASE ASSEMBLY | 10-8 |

SERVICE INFORMATION

GENERAL

- Use care not to damage the oil pressure pad on the crankshaft right end.
- The crankcase must be separated to service the crankshaft and transmission.

SPECIFICATIONS

| ITEM | | STANDARD | SERVICE LIMIT |
|----------------------------|---|----------------|-------------------------------------|
| Shift fork, guide shaft | Fork | I. D. | 12.016–12.034 mm (0.4731–0.4738 in) |
| | | Claw thickness | 4.93 – 5.00 mm (0.194–0.197 in) |
| | Shaft | I. D. | 11.976–11.994 mm (0.4715–0.4722 in) |
| Crankshaft | Connecting rod small end I. D. | | 15.010–15.028 mm (0.5909–0.5917 in) |
| | Connecting rod big end axial clearance | | 0.05 – 0.30 mm (0.002 – 0.012 in) |
| | Connecting rod big end radial clearance | | 0–0.008 mm (0–0.0003 in) |
| | Runout | | 0.05 mm (0.002 in) |

TROUBLESHOOTING

Hard to shift

1. Shift fork bent
2. Shift fork shaft bent

Transmission jumps out of gear

1. Gear dogs worn
2. Shift fork bent or damaged
3. Shift fork shaft bent

Crankshaft noisy

1. Worn connecting rod big end bearing
2. Bent connecting rod

Gears noisy

1. Worn transmission gear
2. Worn spline shafts

CRANKCASE SEPARATION

Remove the following parts before separating the crankcase.

- Cylinder head Section 6
- Cylinder and piston Section 7
- Clutch and gearshift linkage Section 8
- Alternator Section 9

Remove the cam chain tensioner adjusting bolt and tension arm.

Remove the cam chain tensioner and cam chain.

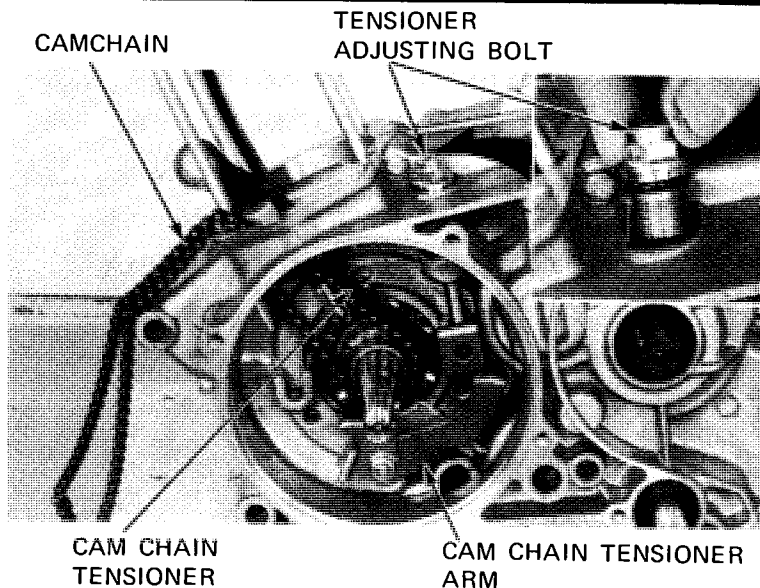

Remove the left crankcase 6 mm bolts.

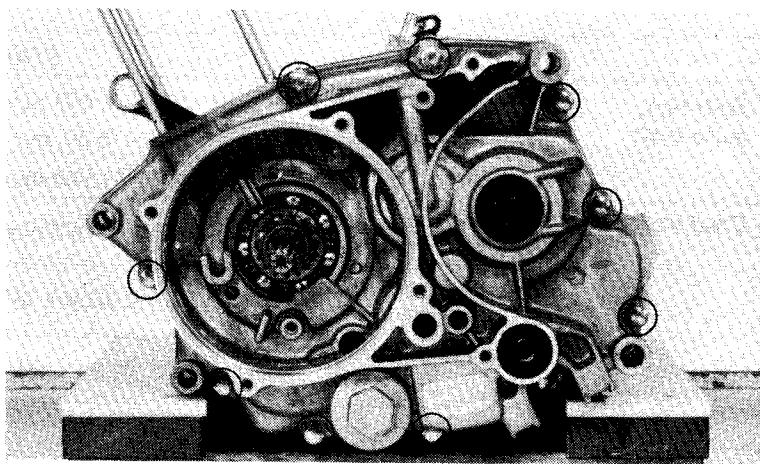

Set the engine on the left crankcase and remove the 6 mm bolt.

Separate the crankcase.

CAUTION:

Use care to prevent oil pressure pad damage or to misplace it.

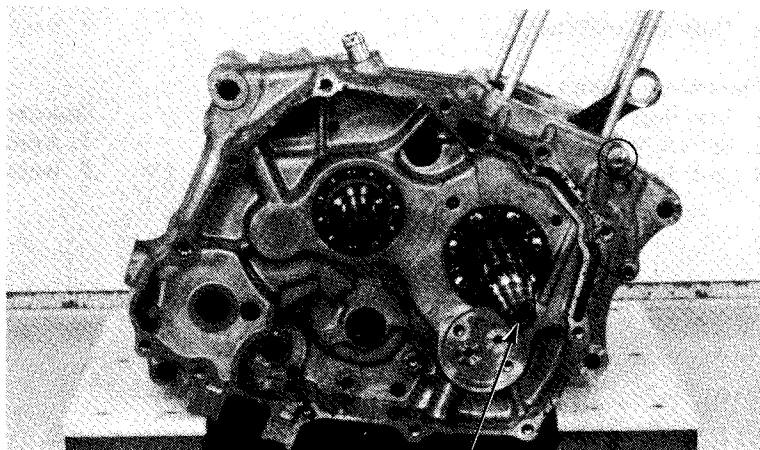

OIL PRESSURE PAD

Remove the gasket and dowel pins.

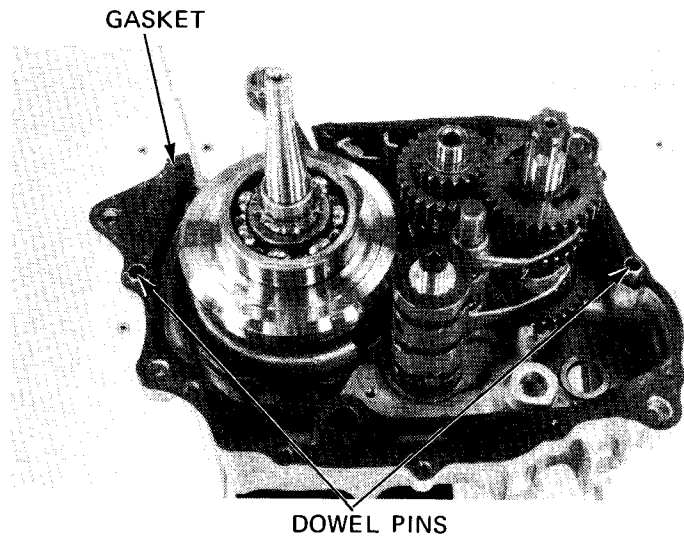

CRANKSHAFT REMOVAL

Remove the crankcase.

CAUTION:

- *Be careful not to damage the oil pressure pad.*

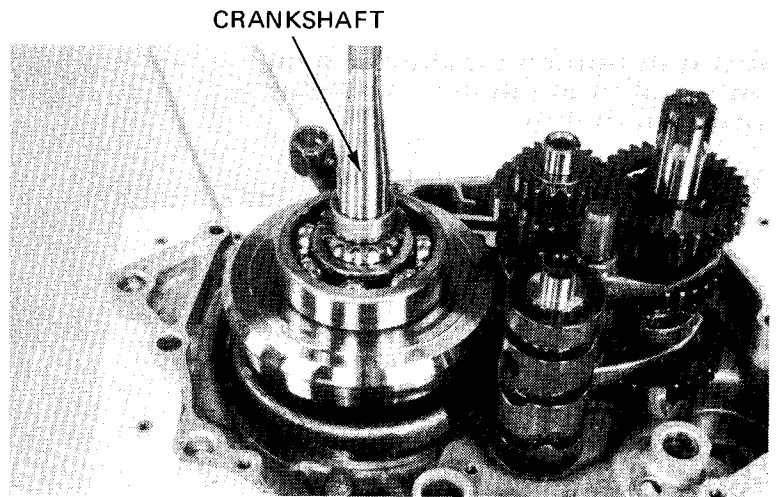

Set the crankshaft on a stand or V-blocks and read the runout using dial indicators.

SERVICE LIMITS:

- A : 0.12 mm (0.0047 in)
- B,C: 0.08 mm (0.0031 in)

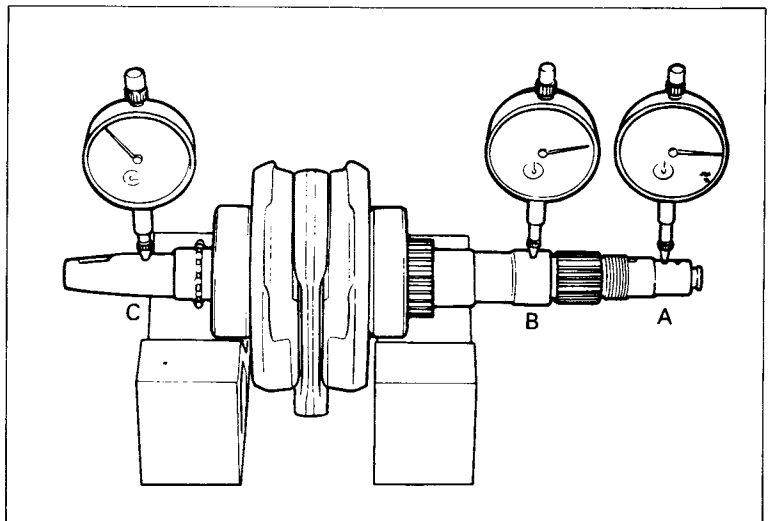

TRANSMISSION/CRANKSHAFT/KICK STARTER

Measure the side clearance at the connecting rod big end with a feeler gauge.

SERVICE LIMIT: 0.80 mm (0.032 in)

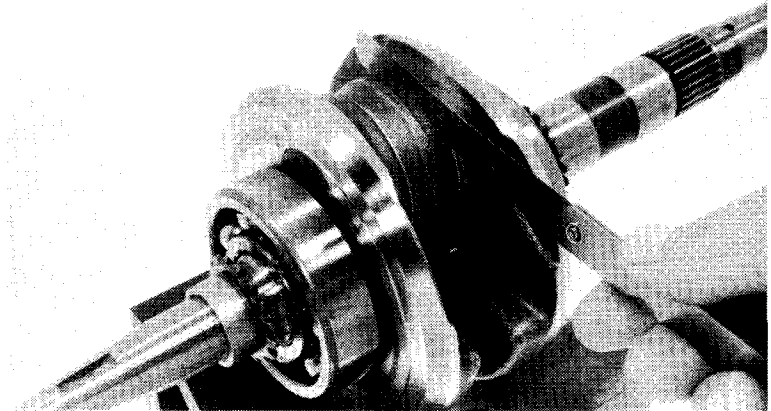

Measure the radial clearance at the connecting rod big end, at two points in the direction indicated by the arrows.

SERVICE LIMIT: 0.05 mm (0.002 in)

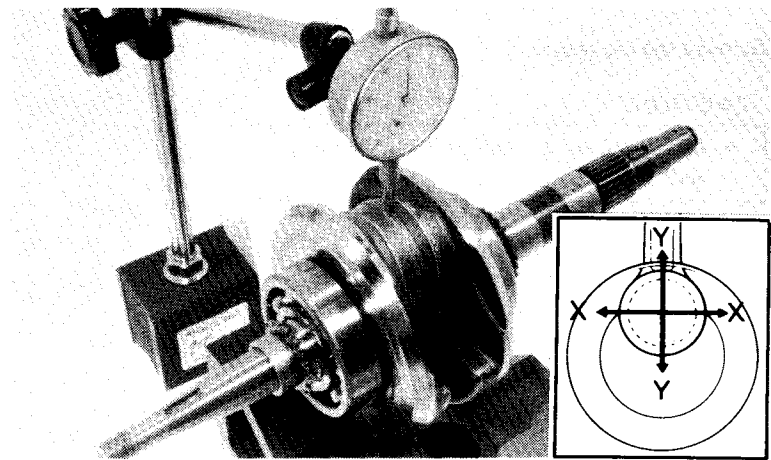

Measure the connecting rod small end I. D.

SERVICE LIMIT: 15.06 mm (0.593 in)

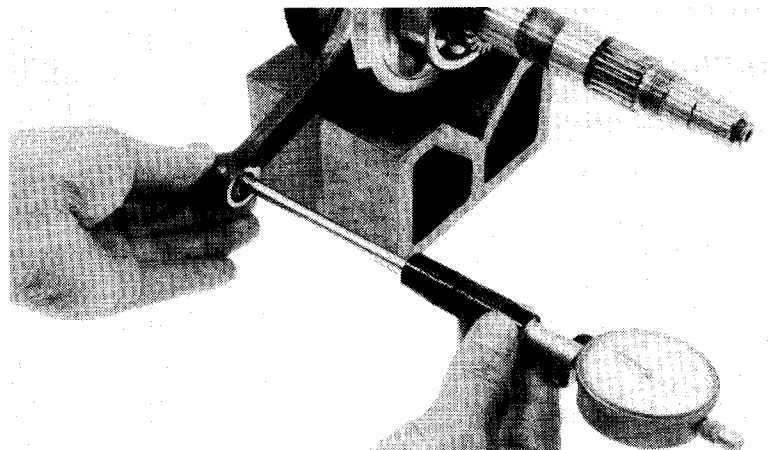

CRANKSHAFT BEARING INSPECTION

Spin the crankcase bearings by hand and check for play.

The bearings must be replaced if they are noisy or have excessive play.

SERVICE LIMIT:

- AXIAL: 0.05 mm (0.002 in)
- RADIAL: 0.10 mm (0.004 in)

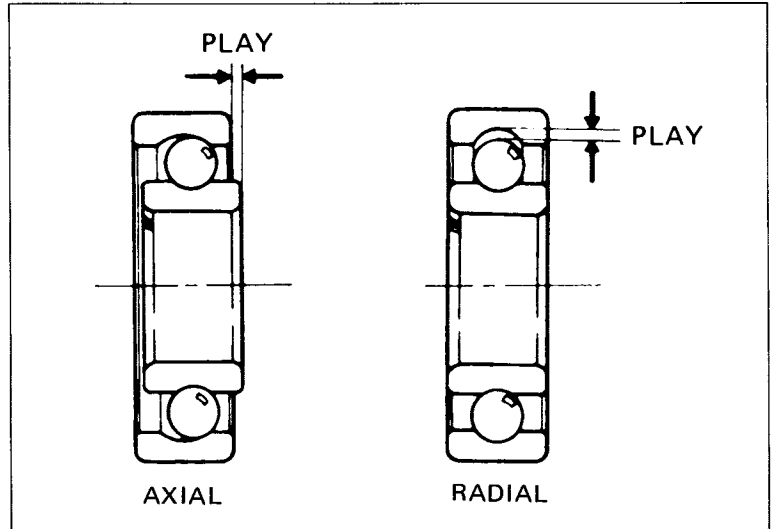

TIMING SPROCKET INSTALLATION

Install the sprocket, aligning any tooth center with the keyway center in the crankshaft.

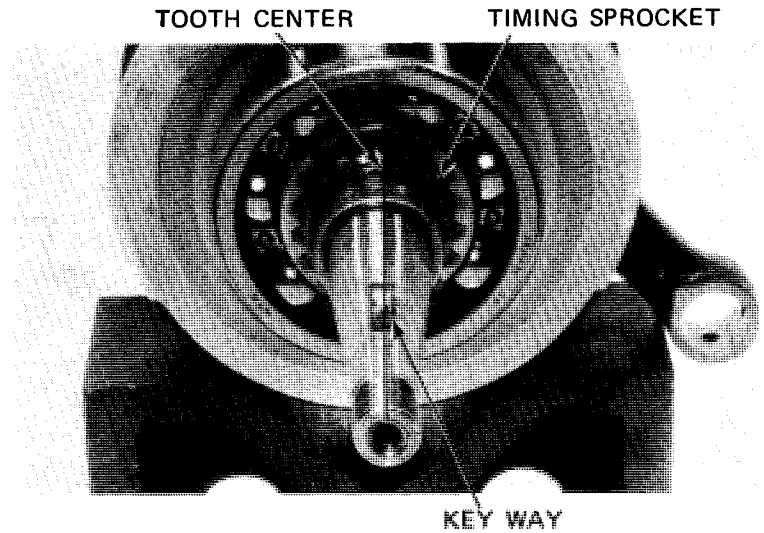

TRANSMISSION DISASSEMBLY

Remove the shift fork shaft and remove the shift forks.

Remove the shift drum.

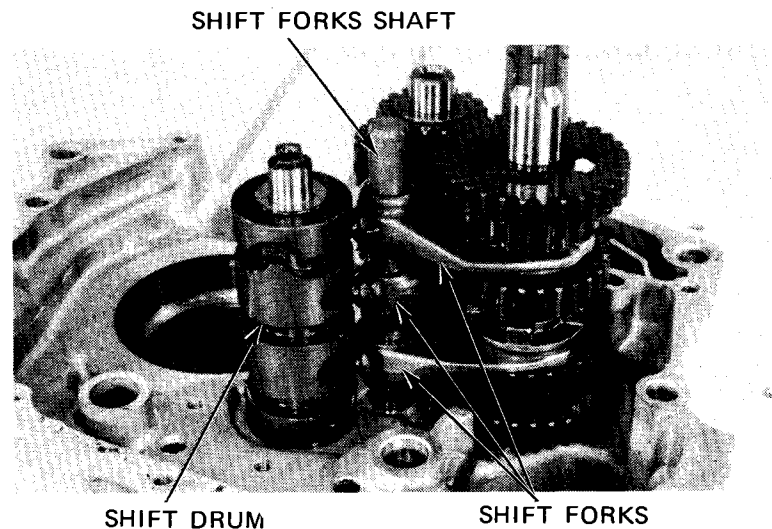

TRANSMISSION/CRANKSHAFT/KICK STARTER

INSPECTION

Check the shift fork for wear, bending or damage.

Measure the I. D.

SERVICE LIMIT: 12.04 mm (0.474 in)

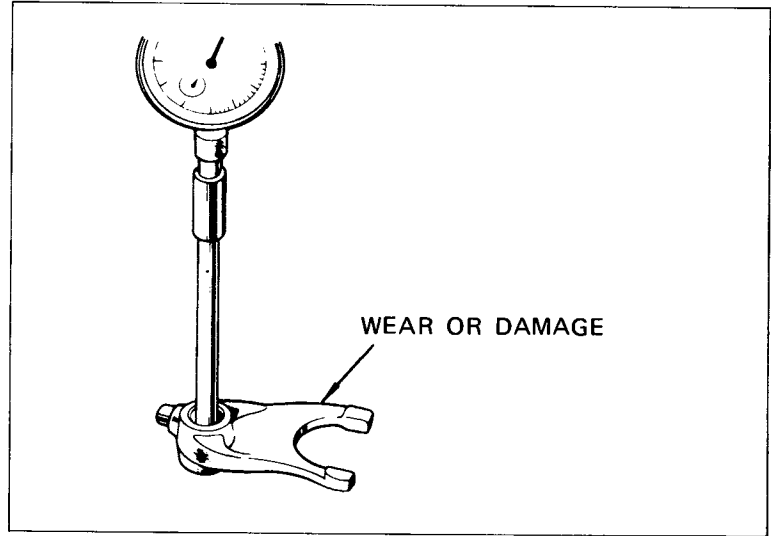

Measure the shift fork claw thickness.

SERVICE LIMIT: 4.50 mm (0.177 in)

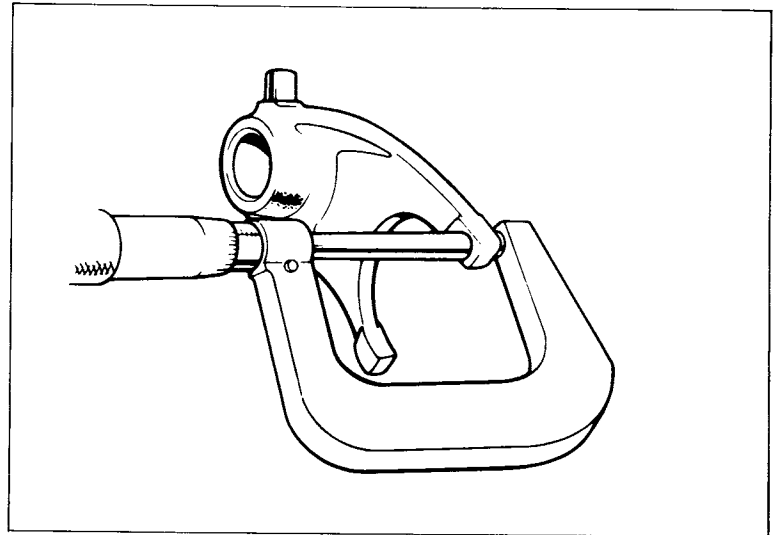

Measure the shift fork shaft O. D.

SERVICE LIMIT: 11.96 mm (0.471 in)

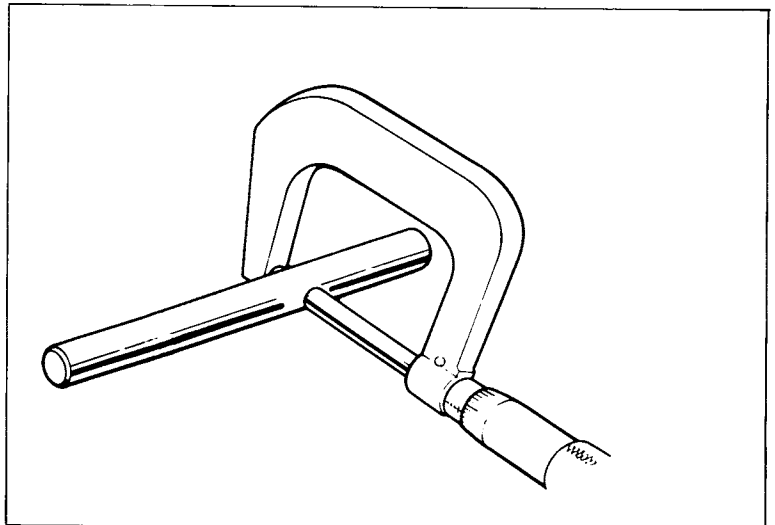

Remove the transmission gears.

Inspect each gear for wear or damage and replace if necessary.

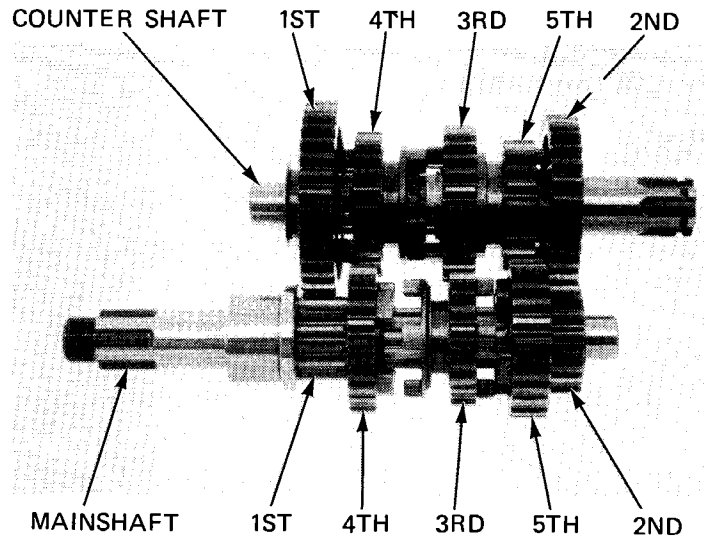

TRANSMISSION ASSEMBLY

Coat all parts with oil.

Assemble the transmission shafts and gears noting the locations of the thrust washers and snap rings.

NOTE

Make sure the snap rings are seated properly.

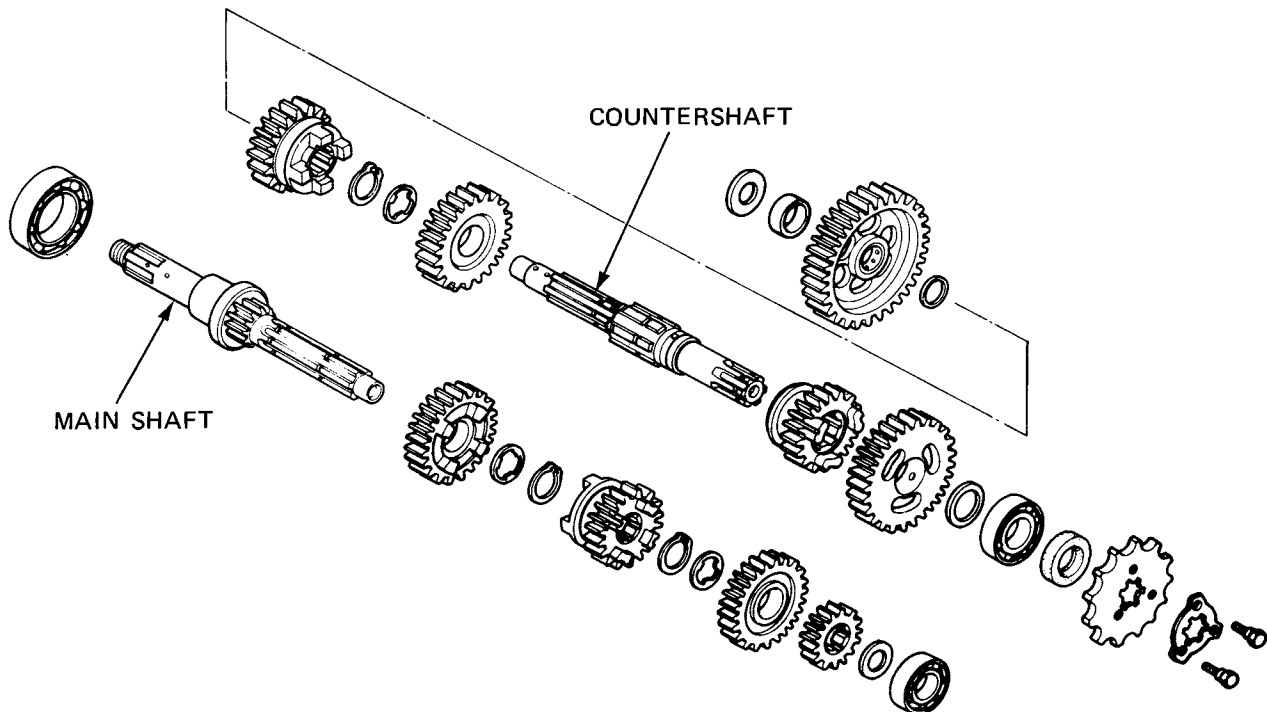

TRANSMISSION/CRANKSHAFT/KICK STARTER

Install the mainshaft and countershaft assemblies in the right crankcase.

NOTE

Make sure the thrust washer stays in place during this operation.

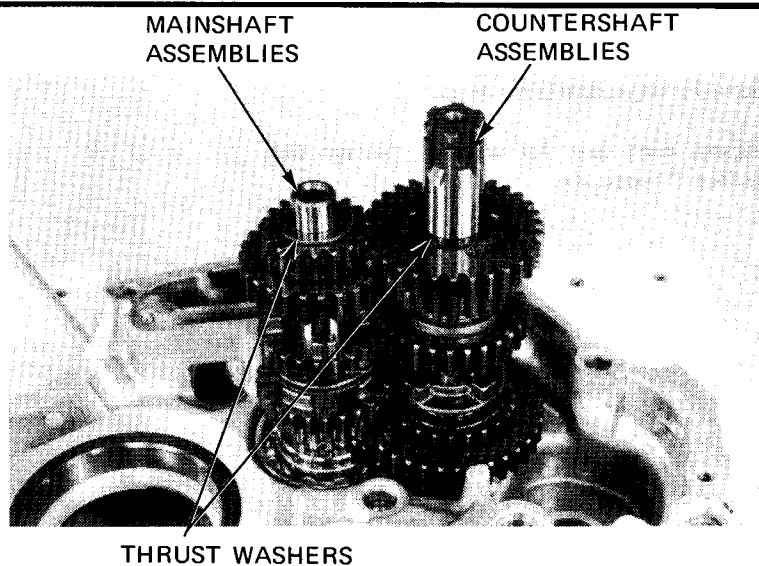

Install the shift drum and shift forks.

Install the fork guide shaft.

Rotate the mainshaft by hand to be sure gears rotate freely.

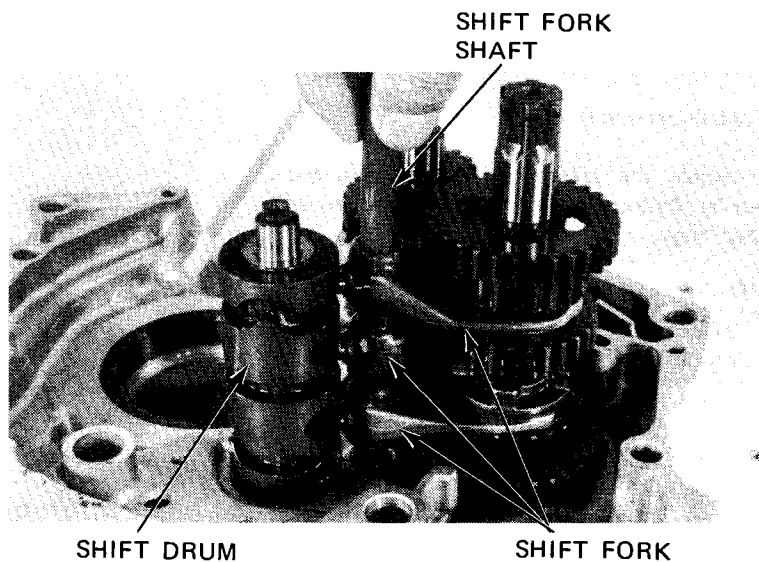

CRANKCASE ASSEMBLY

Install the crankshaft.
Install the gasket and dowel pins.

Install the left crankcase onto the right crankcase.

NOTE

Make sure that the gasket stays in place.

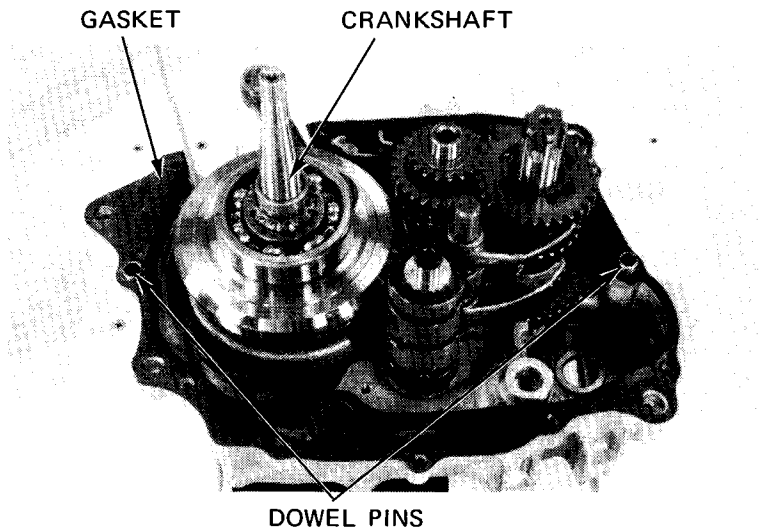

Tighten the left crankcase 6 mm bolts in a criss-cross pattern.

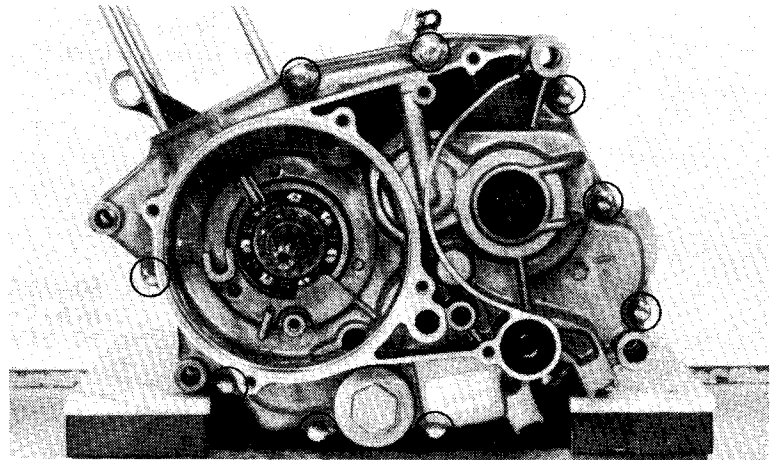

Tighten the right crankcase 6 mm bolt securely.

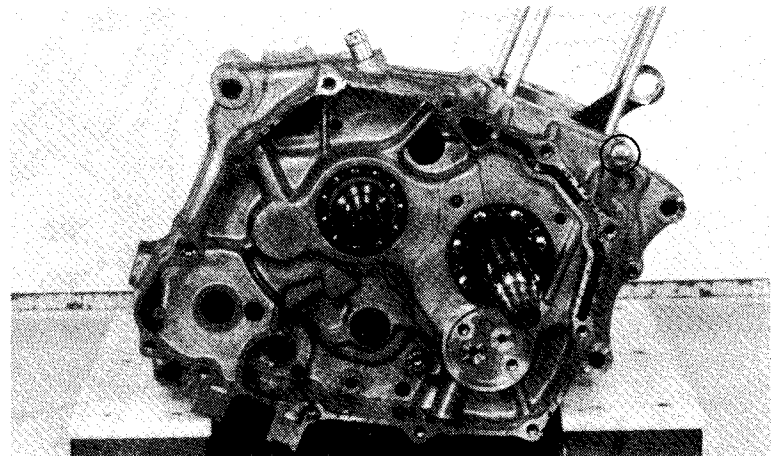

Install the cam chain tensioner and tensioner rod.

Install the cam chain and tensioner arm.
Install the tensioner lock collar and adjusting bolt with a new O-ring.
With the tensioner arm held down all the way, tighten the adjusting bolt.

NOTE

Note the tensioner lock collar direction.

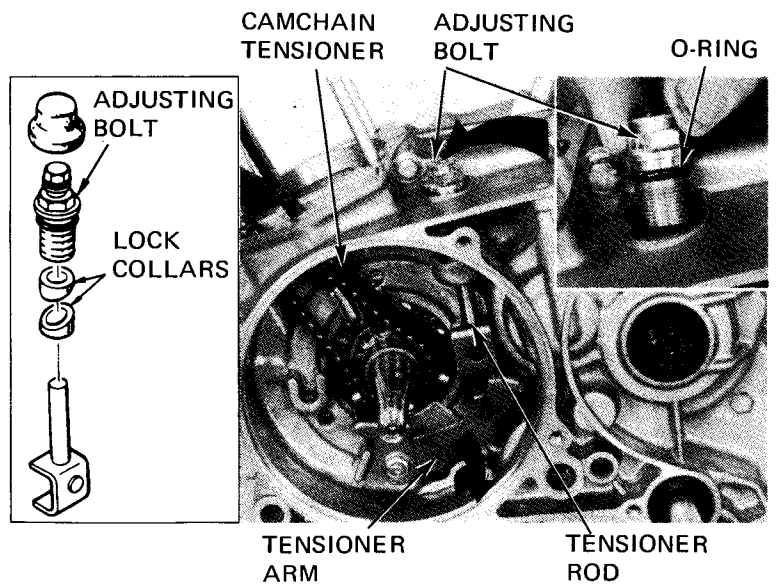

11. FRONT WHEEL/BRAKE/STEERING

| | |
|---------------------|-------|
| SERVICE INFORMATION | 11-1 |
| TROUBLESHOOTING | 11-2 |
| HEADLIGHT | 11-3 |
| HANDLEBAR | 11-5 |
| FRONT WHEEL | 11-9 |
| FRONT BRAKE | 11-19 |
| FRONT FORK | 11-21 |
| STEERING STEM | 11-27 |

SERVICE INFORMATION

GENERAL

- This section covers maintenance of the front wheel, front fork, front brake and steering system.
- A jack or other support is required to support the ATC.

SPECIFICATIONS

| ITEM | | STANDARD | SERVICE LIMIT |
|-------------------------------|----------|-----------------------------------|---------------------|
| Front axle runout | | _____ | 0.5 mm (0.02 in) |
| Front brake drum I.D. | | 110 mm (4.3 in) | 111 mm (4.4 in) |
| Front brake lining thickness | | 4 mm (0.2 in) | 2 mm (0.1 in) |
| Front wheel bearing play | Radial | _____ | 0.05 mm (0.002 in) |
| | Axial | _____ | 0.10 mm (0.004 in) |
| Front fork spring free length | Spring A | 281.6–287.2 mm (11.087–11.307 in) | 278.7 mm (10.97 in) |
| | Spring B | 39.3–40.1 mm (1.547–1.579 in) | 38.9 mm (1.5 in) |

TORQUE VALUES

| | | |
|------------------------------|-------|---|
| Handlebar upper holder bolt | 8 mm | 18–30 N•m (1.8–3.0 kg-m, 13–22 ft-lb) |
| Handlebar lower holder nut | 10 mm | 40–48 N•m (4.0–4.8 kg-m, 29–35 ft-lb) |
| Fork bridge bolt | 12 mm | 50–70 N•m (5.0–7.0 kg-m, 36–51 ft-lb) |
| Steering stem nut | 22 mm | 50–70 N•m (5.0–7.0 kg-m, 36–51 ft-lb) |
| Front axle | 14 mm | 70–110 N•m (7.0–11.0 kg-m, 51–80 ft-lb) |
| Front axle holder nut | 6 mm | 10–14 N•m (1.0–1.4 kg-m, 7–10 ft-lb) |
| Front wheel hub nut | 8 mm | 20–25 N•m (2.0–2.5 kg-m, 14–18 ft-lb) |
| Front brake drum bolt | 8 mm | 20–25 N•m (2.0–2.5 kg-m, 14–18 ft-lb) |
| Front fork mounting bolt/nut | 10 mm | 40–50 N•m (4.0–5.0 kg-m, 29–36 ft-lb) |
| Front fork socket bolt | 8 mm | 15–25 N•m (1.5–2.5 kg-m, 11–18 ft-lb) |

FRONT WHEEL/BRAKE/STEERING

TOOLS

| | |
|-----------------------------|--|
| Special | |
| Ball Race Remover | 07944—1150001 or M9360—277—91774 (U.S.A. only) |
| Universal bead breaker | GN-AH-958-BBI (U.S.A. only) |
| Hollow set wrench, 6 mm | 07917—3230000 or Equivalent commercially available in U.S.A. |
| Common | |
| Driver | 07749—0010000 or 07949—6110000 or 07949—3000000 or 07949—2860000 |
| Attachment, 37×40 mm | 07746—0010200 |
| Pilot, 15 mm | 07746—0040300 |
| Attachment, 42×47 mm | 07746—0010300 or 07949—6110000 |
| Pin Spanner | 07702—0010000 or M9361—412—099788 (U.S.A. only) |
| Fork seal driver | 07747—0010100 or 07947—3550000 |
| Fork seal driver attachment | 07747—0010400 |

TROUBLESHOOTING

Hard steering

1. Steering stem nut too tight.
2. Faulty steering stem bearings.
3. Damaged steering stem ball race or cone race.
4. Insufficient tire pressure.

Steers to one side or does not track straight

1. Bent front forks.
2. Bent front axle, wheel installed incorrectly.

Front wheel wobbling

1. Bent rim.
2. Worn front wheel bearing.
3. Faulty tire.
4. Axle not tightened properly.

Improper brake performance

1. Incorrect adjustment of lever.
2. Brake shoes worn.
3. Brake shoes contaminated.
4. Brake cam worn.
5. Brake drum worn.
6. Brake arm serrations improperly engaged.
7. Cam contacting area of shoes worn.

Soft suspension

- Weak fork spring.

Front suspension noise

- Loosen fork fasteners.

HEADLIGHT

REMOVAL

Remove the headlight by removing the screw.
Disconnect the wire connectors.

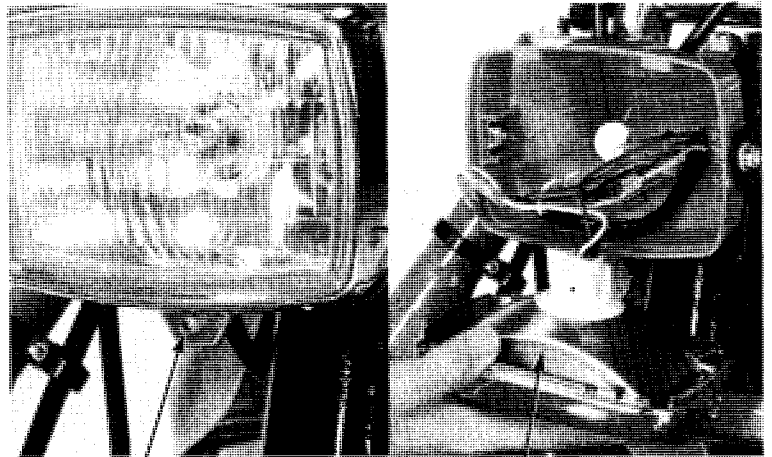

SCREW

HEADLIGHT

DISASSEMBLY

Disassemble the headlight.

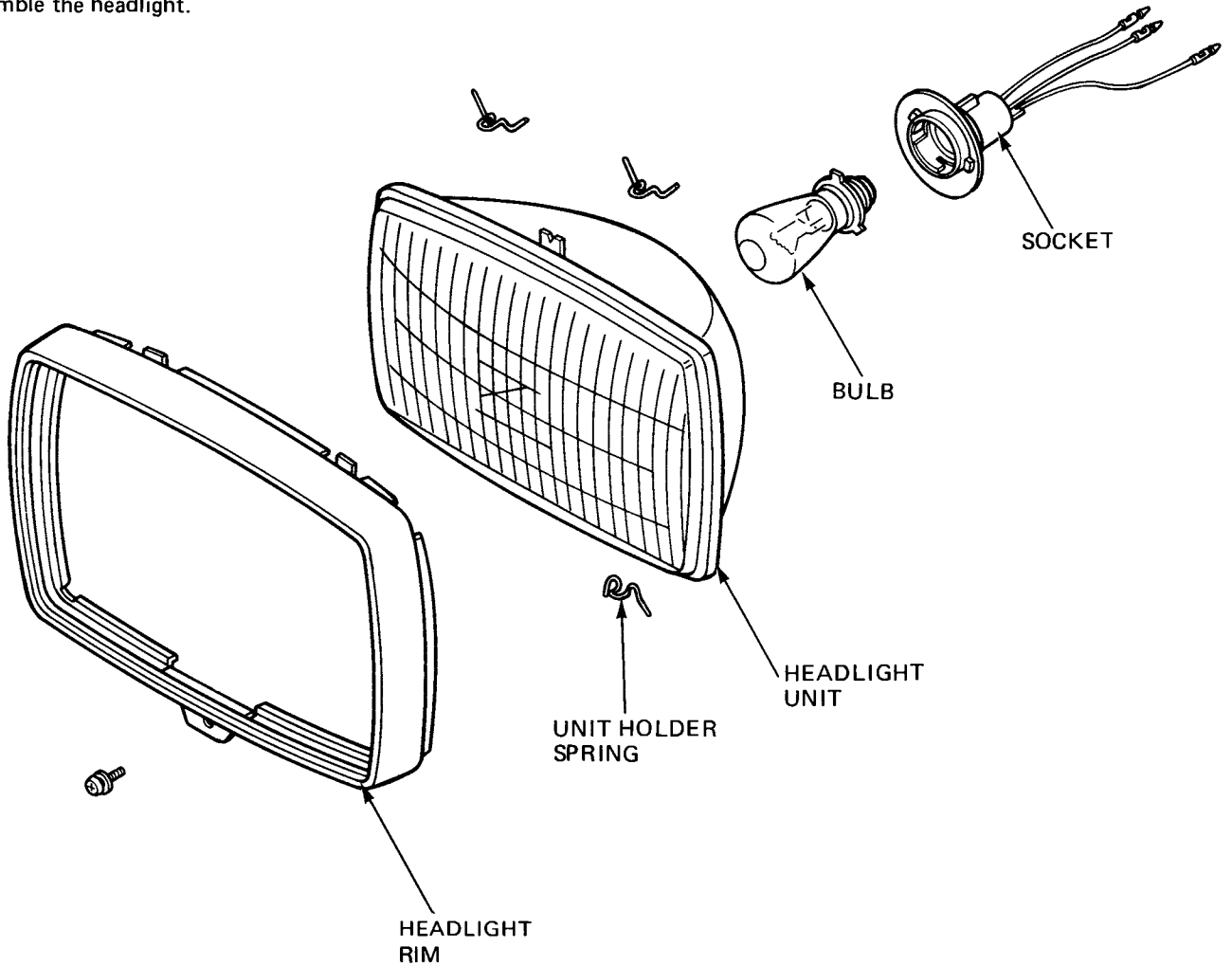

**HEADLIGHT CASE REMOVAL/
INSTALLATION**

Remove the headlight case by removing the mounting bolts.

Install the headlight case by routing the wires through the left hole in the headlight case. Tighten the mounting bolts securely.

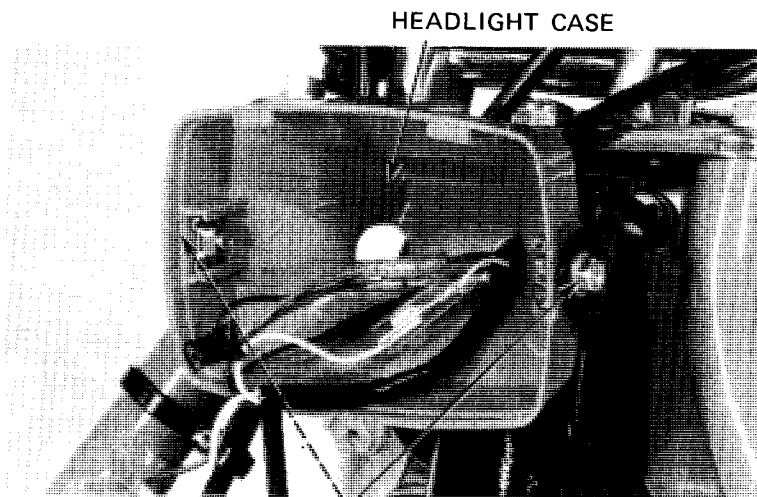

HEADLIGHT CASE

MOUNTING BOLTS

**HEADLIGHT ASSEMBLY /
INSTALLATION**

Position the headlight unit on the headlight rim and install the unit holder springs as shown.

Install the bulb in the headlight socket and install the bulb socket by aligning the lugs of the bulb socket with the cutouts of headlight unit.

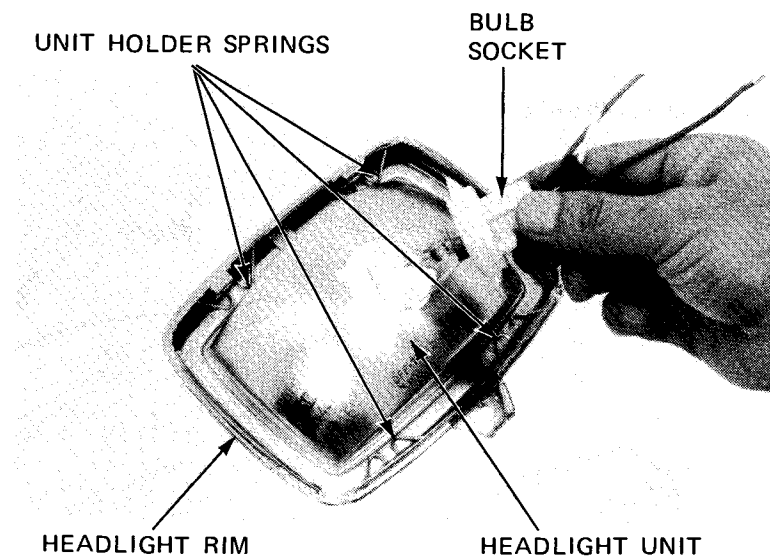

UNIT HOLDER SPRINGS

BULB SOCKET

HEADLIGHT RIM

HEADLIGHT UNIT

Connect the wire connectors color to color. Install the headlight on the case by using a screw.

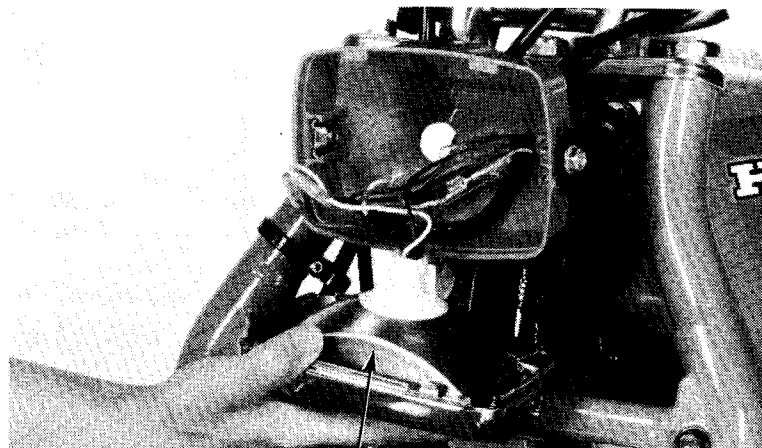

HEADLIGHT

**HEADLIGHT BRACKET REMOVAL/
INSTALLATION**

Remove the headlight case (Page 11-4).
Remove the lockpins and washers attached
the headlight bracket on both sides.
Remove the bracket from the fork bridge.

Install the bracket in the reverse order of
removal.

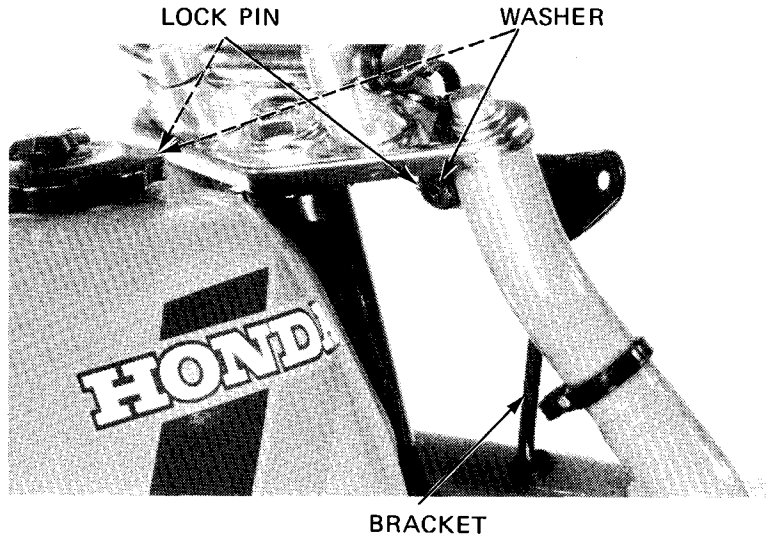

HANDLEBAR

REMOVAL

Remove the handlebar holder cover.

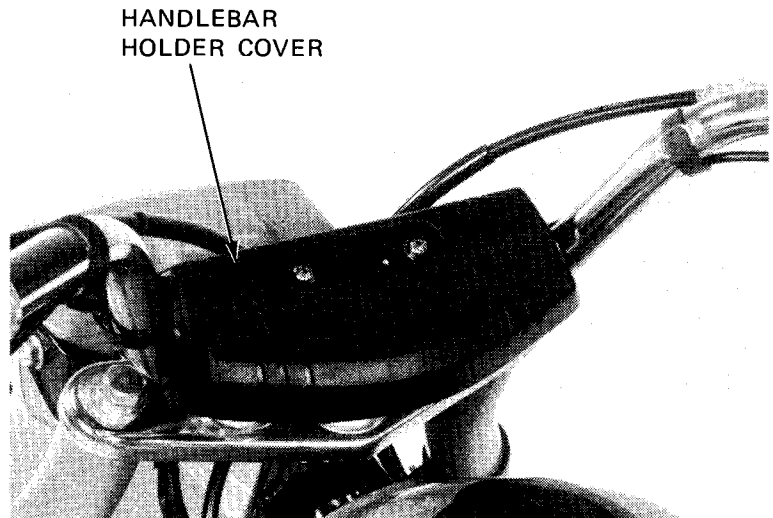

Remove the headlight and disconnect the wire
connectors.
Remove the wire bands and handlebar switch.

Disconnect the front and rear brake cables at
the brake levers.
Remove the throttle lever housing.

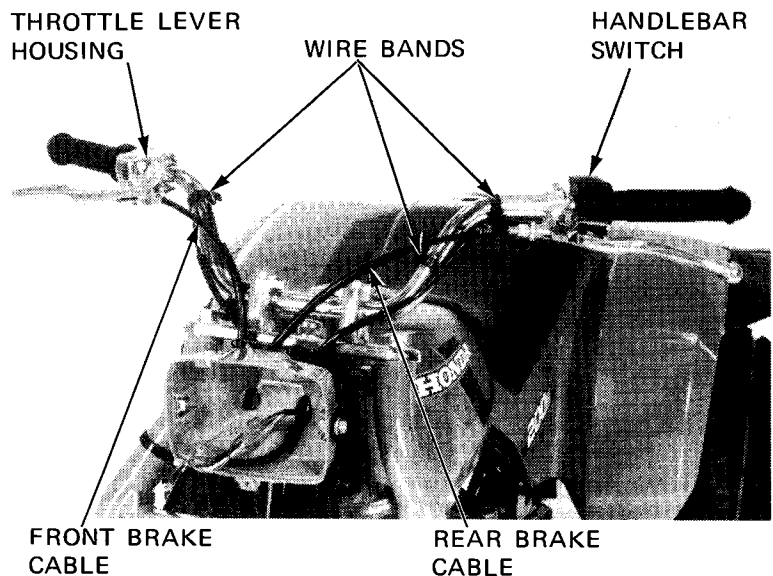

FRONT WHEEL/BRAKE/STEERING

Remove the throttle cable clamp.
Remove the handlebar upper holders and handlebar.

THROTTLE CABLE CLAMP

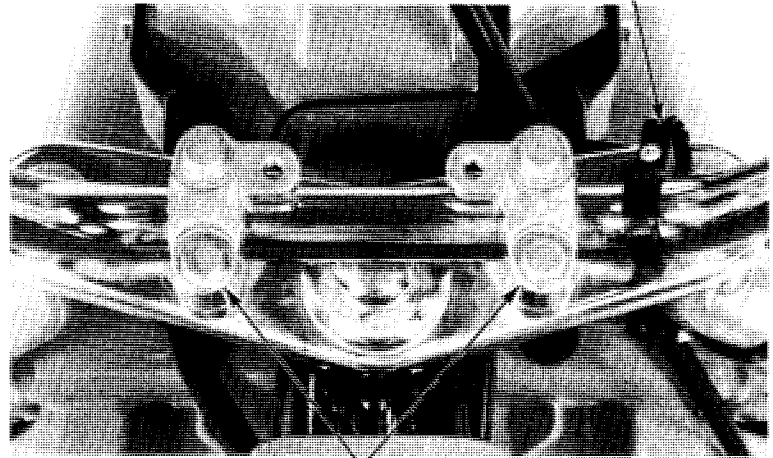

UPPER HOLDERS

INSTALLATION

Place the handlebar onto the lower holders, aligning the punch mark on the handlebar with the top of each lower holder.

Install the handlebar upper holders with the punch marks forward.
Tighten the front bolts first, then tighten the rear bolt.

**TORQUE: 18–30 N·m (1.8–3.0 kg·m,
13–22 ft·lb)**

PUNCH MARKS

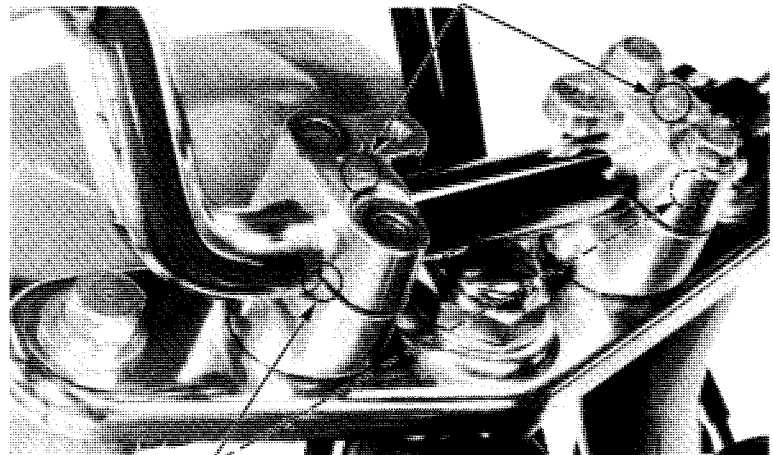

PUNCH MARKS

Install the front brake lever and connect the front brake cable.

NOTE :

Do not tighten the brake lever holder at this time.

'84 :
Align the cut-out of throttle lever housing with the handlebar pin and install the throttle lever housing.
Tighten the front holder screw first, then tighten the rear screw.

After '84 :
Install the throttle lever housing and holder on the handlebar with the lever horizontal.
Tighten the front holder screw first, then tighten the rear screw.

'84 :

PIN After '84 : HOUSING HOLDER

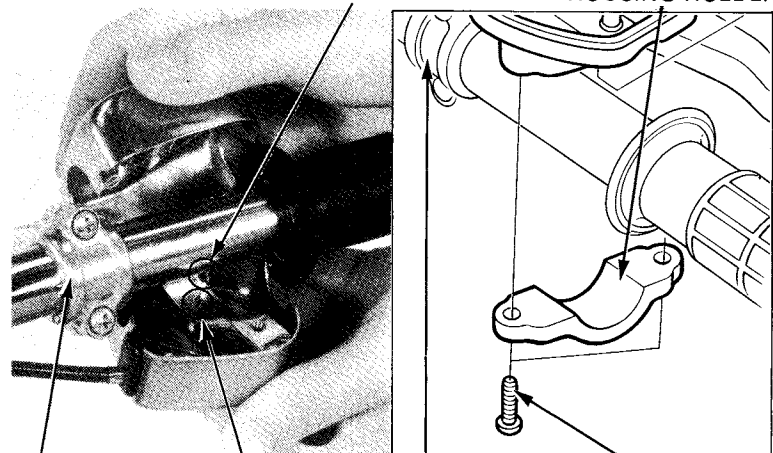

BRAKE LEVER CUT-OUT HOLDER

BRAKE LEVER HOLDER SCREW

Install the rear brake lever and connect the rear brake cable.

NOTE :

Do not tighten the rear brake lever holder at this time.

Install the handlebar switch and tighten the front screw first.

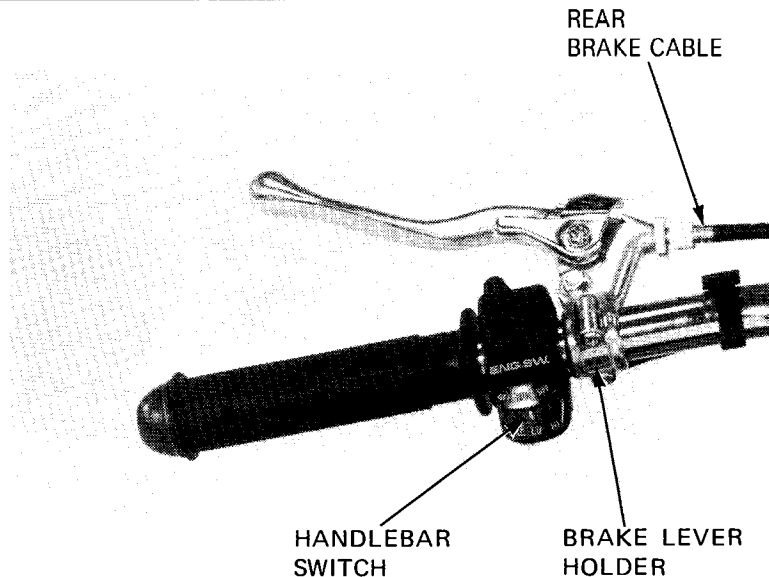

Route the handlebar switch wires as shown.
Install the wire bands.
Install the handlebar cover.

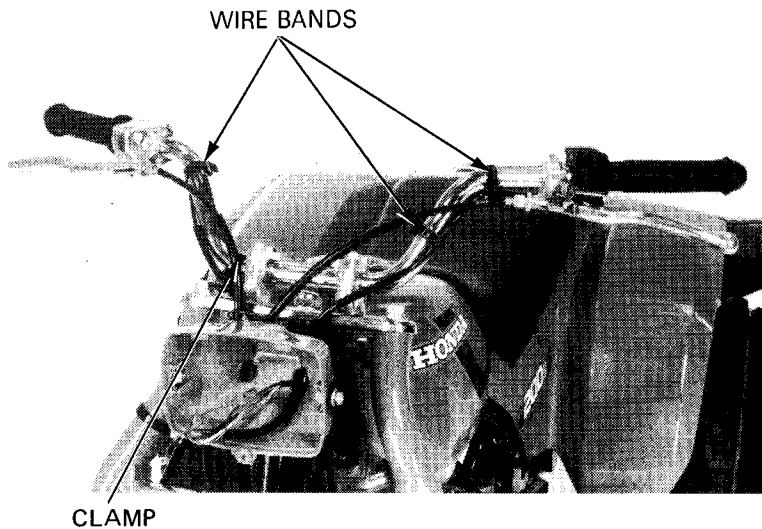

Install the front and rear brake levers at the angle shown.

Tighten the upper screws first, then tighten the lower screws securely.

Adjust the front and rear brake lever free play (Page 3-14, 15).

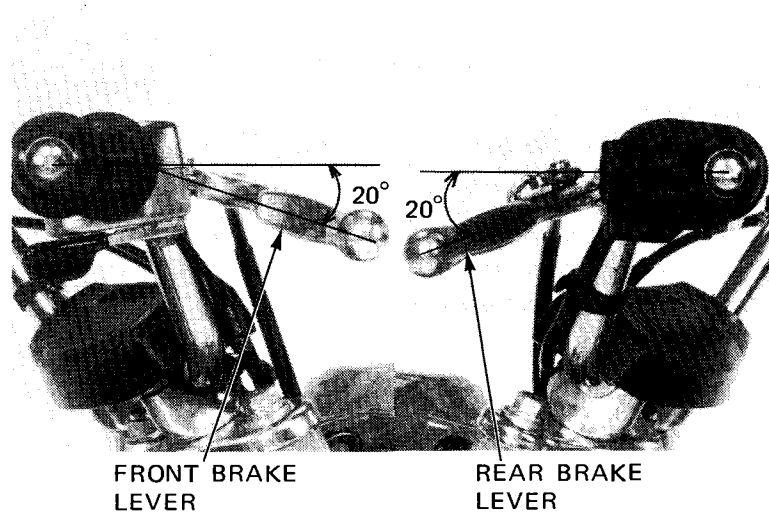

THROTTLE LEVER DISASSEMBLY

Remove the screws and throttle lever cover.

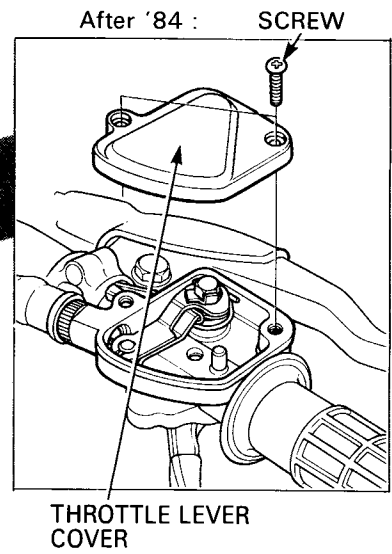
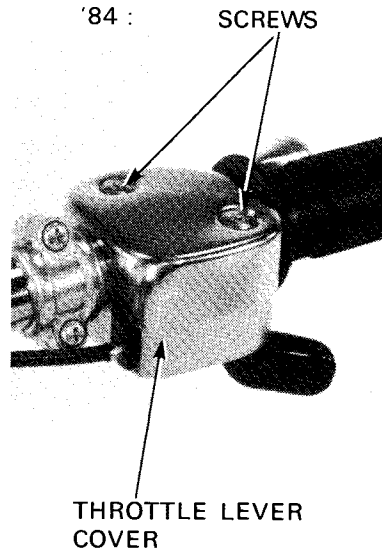

Raise the tab of the lock plate and remove the bolt.

Remove the throttle lever and spring. Disconnect the throttle cable.

'84 :

Remove the rubber seal.

After '84 :

Remove the screws.

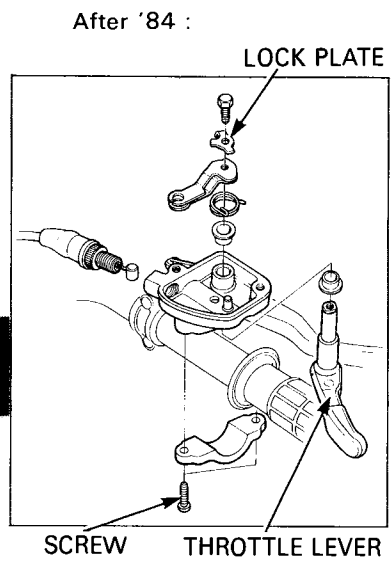
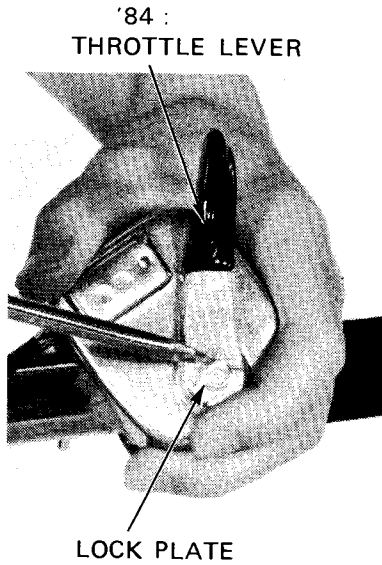

THROTTLE LEVER ASSEMBLY

'84 :

Install the throttle lever, spring, and rubber seal.

After '84 :

Install the throttle lever housing, throttle lever, and spring.

'84 and after :

Connect the throttle cable.

Install the lock plate.

Screw in the pivot bolt and check the lever for smooth operation.

Bend over the tabs of the lock plate.

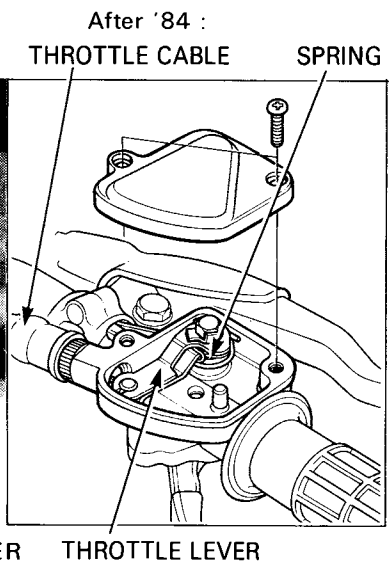
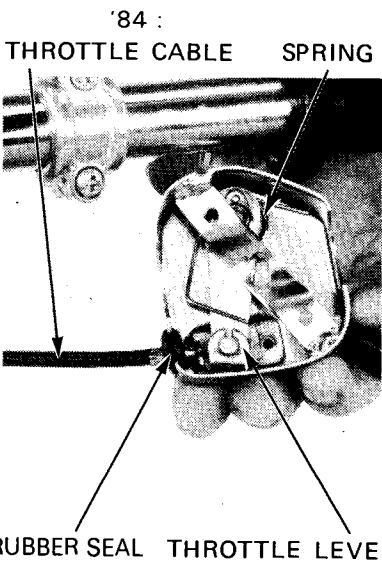

'84 :

Install the throttle lever cover onto the handlebar with the slit 3° below horizontal as shown.

After '84 :

Install the throttle lever cover onto the throttle lever housing.

Loosen the screws attaching the throttle lever housing and holder, and position the throttle housing on the handlebar with the lever horizontal as shown.

Tighten the front holder screw first, then tighten the rear screw.

'84 and after :

Adjust the throttle cable free play (Page 3-7).

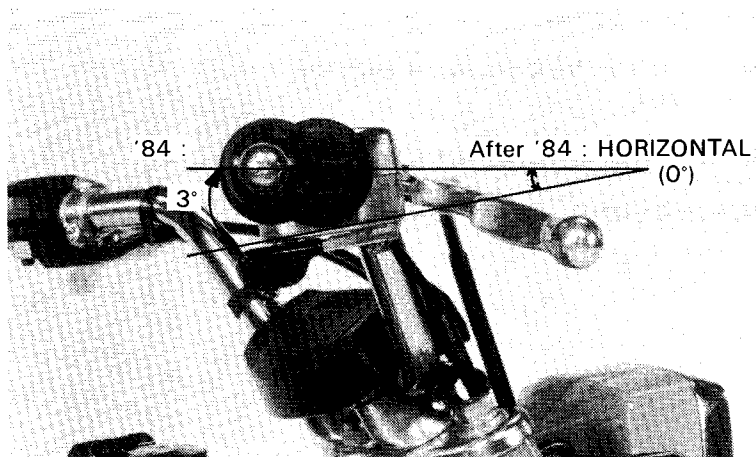

FRONT WHEEL

FRONT WHEEL REMOVAL

Raise the front wheel off the ground by placing a block or work stand under the engine.

Remove the front brake adjusting nut and disconnect the front brake cable.

FRONT BRAKE CABLE

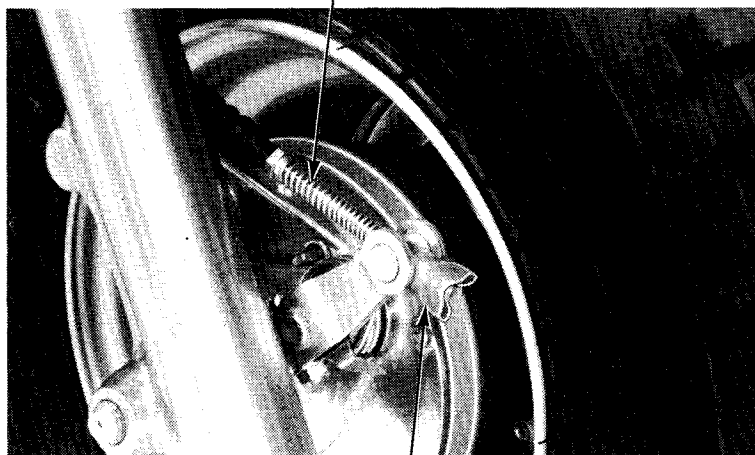

ADJUSTING NUT

Loosen the axle holder nuts and remove the front axle.

Remove the axle collar and front wheel.

NOTE:

Cover the wheel hub as soon as the axle has been removed to prevent the entry of dirt.

AXLE

AXLE COLLAR

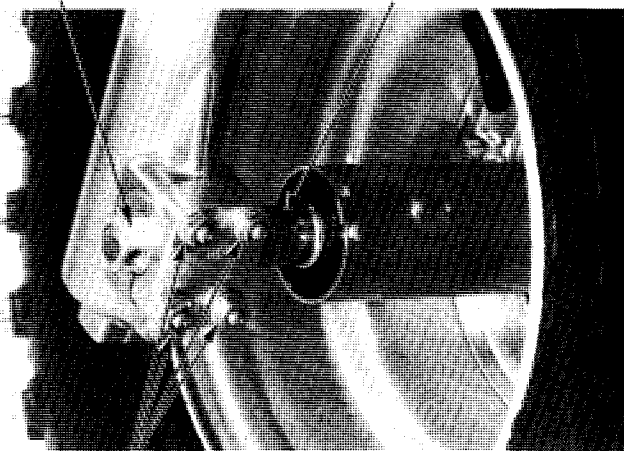

AXLE HOLDER NUTS

FRONT WHEEL/BRAKE/STEERING

INSPECTION

• FRONT AXLE

Set the axle in V-blocks and measure the shaft runout.

Actual runout is 1/2 of the total indicator reading.

SERVICE LIMIT: 0.5 mm (0.02 in)

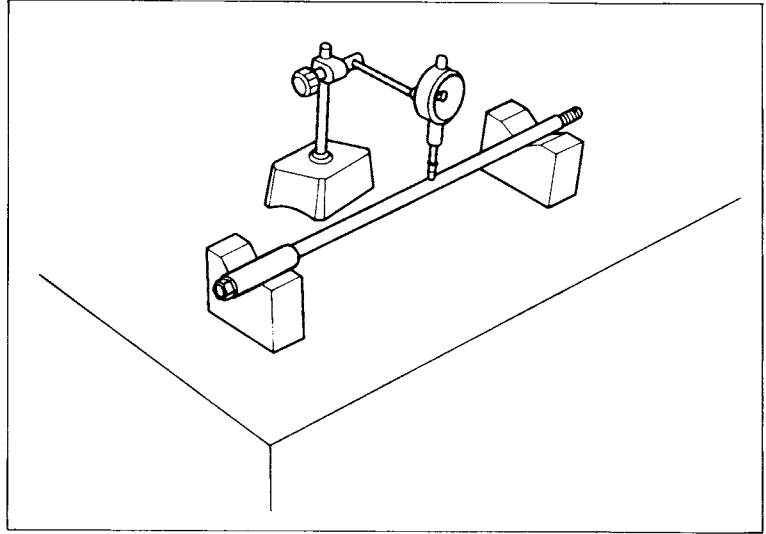

• BRAKE DRUM

Remove the brake panel assembly and measure the brake drum I.D.

SERVICE LIMIT: 111 mm (4.4 in)

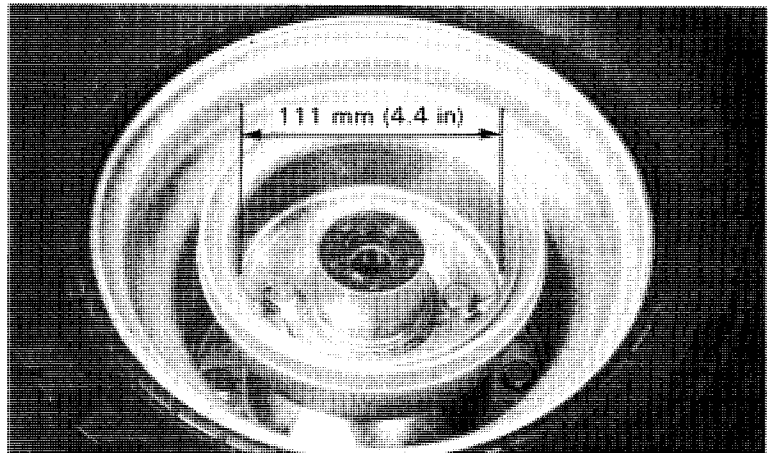

FRONT WHEEL DISASSEMBLY

Bend the tabs of the lock plates down.

Remove the brake drum bolts and brake drum.

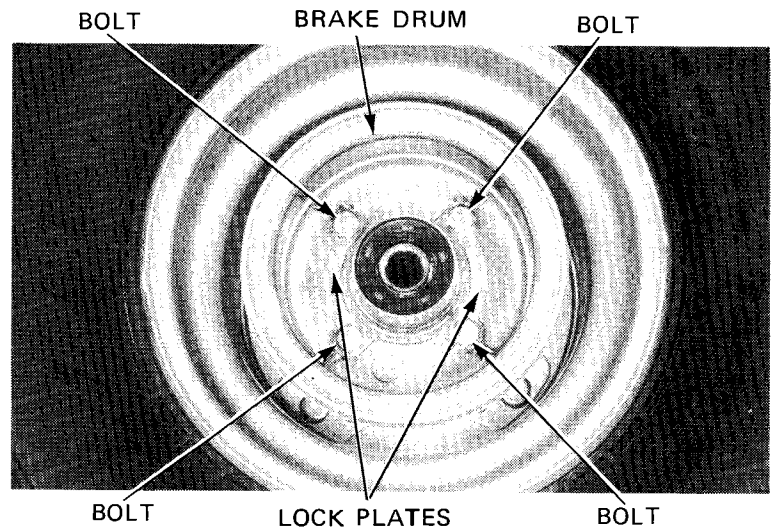

Remove the front wheel hub nuts and hub.

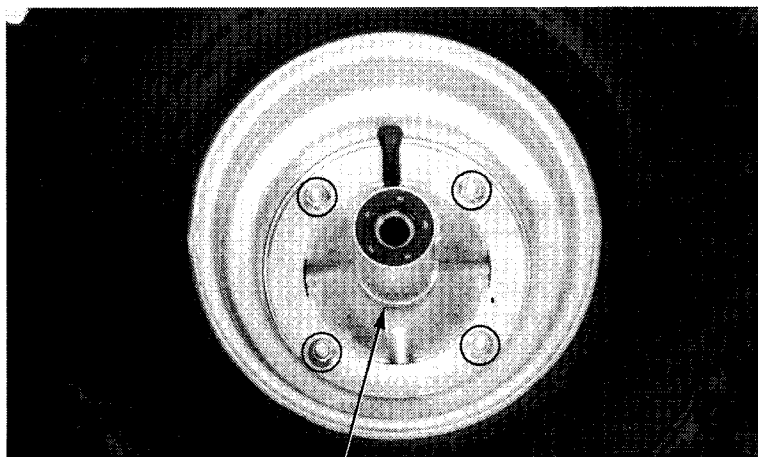

WHEEL HUB

BEARING INSPECTION

Turn the inner race of each bearing with your finger. The bearings should turn smoothly and quietly. Also check that the bearing outer race fits tightly in the hub.

Remove and discard the bearings if the races do not turn smoothly, quietly, or if they fit loosely in the hub.

NOTE:

Replace hub bearings in pairs

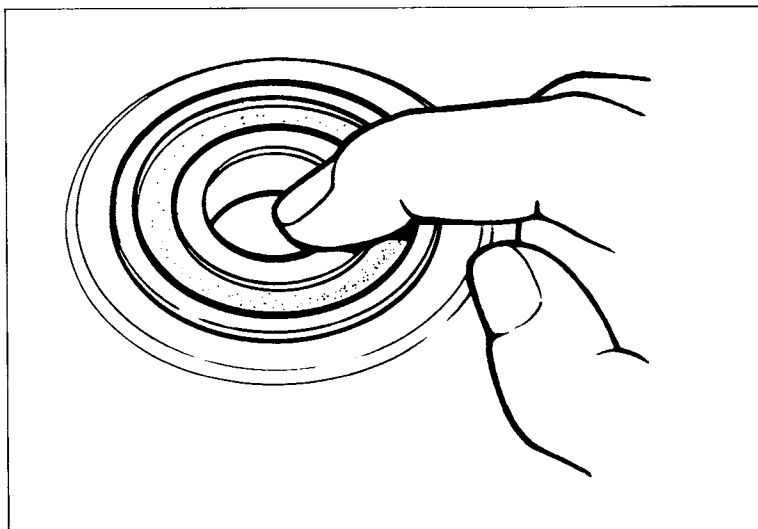

WHEEL HUB DISASSEMBLY

Remove the dust seals.
Drive the wheel bearings out and remove the center collar.

NOTE:

Once bearings have been removed from the hub, they should be replaced with new ones.

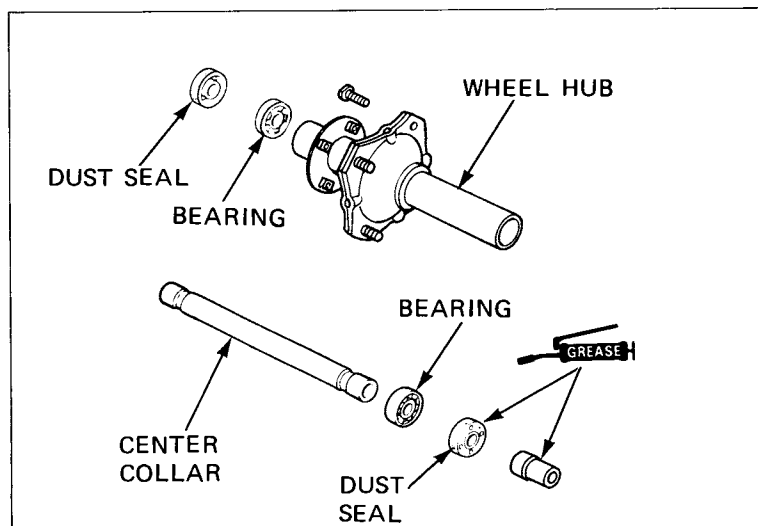

TIRE REMOVAL

NOTE:

This service requires the Universal Bead Breaker (GN-AH-958-BB1) available in U.S.A. only.

Remove the core from the valve stem.

CAUTION

- Use of the Bead Breaker tool is required for tire removal.
- Do not damage the bead seating area of the rim.
- Use a Coats 220 Tire Changer or equivalent to remove the tire from the rim. If a tire changer is not available, rim protectors and tire irons may be used.

Install the proper size blade onto the breaker arm assembly.

- Short blade – 7”/8” rims.
- Long blade – 9”/11” rims.

CAUTION

Use of an improper size blade may result in damage to the rim, tire or blade.

Place the proper size adapter onto the threaded shaft and then put the wheel over the threaded shaft and adapter.

Lube the bead area with rubber lubricant, pressing down on the tire sidewall/bead area in several places, to allow the lubricant to run into and around the bead. Also lube the area where the breaker arm will contact the sidewall of the tire.

While holding the breaker arm assembly at an approximate 45° position, insert the blade of the breaker arm between the tire and rim. Push the breaker arm inward and downward until it is in the horizontal position with its press block in contact with the rim.

NOTE

It may be necessary to tap the breaker arm with a brass hammer to install it the last 3 mm. While doing so, be sure to hold the arm down in the horizontal position.

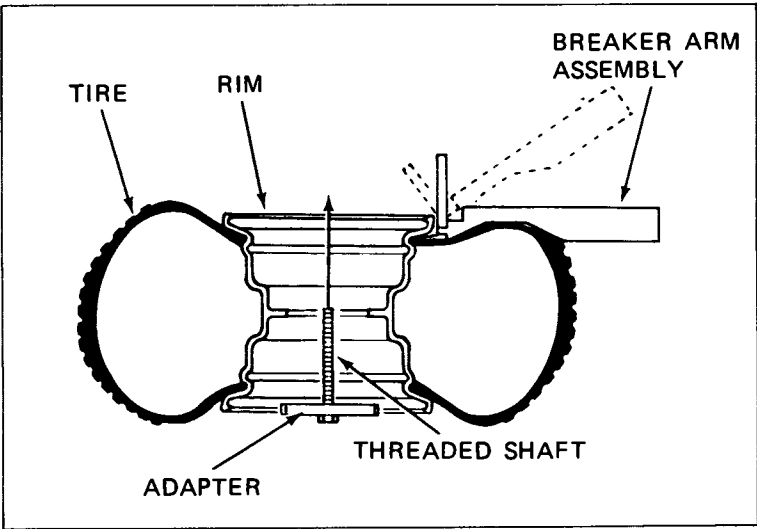
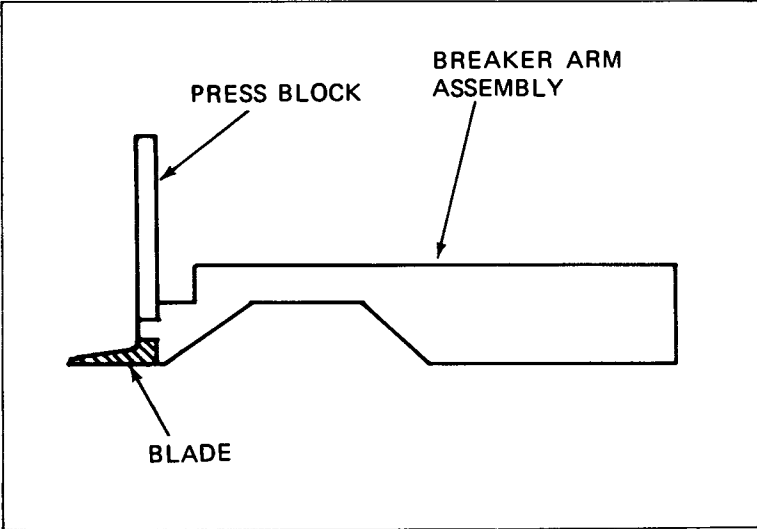

With the breaker arm in the horizontal position, place the breaker press head assembly over the breaker arm press block. Make sure the press head bolt is backed out all the way and then position the nylon buttons on the press head against the inside edge of the rim.

Insert the threaded shaft through the appropriate hole in the breaker press head assembly and then tighten the lever nut until both ends of the breaker press head assembly are in firm contact with the rim.

NOTE

Insert bolts through the holes in the rim hub mounting tabs and the adapter to position the adapter properly.

Tighten the press head bolt until the reference mark on the press block is aligned with the top edge of the press head.

If the rest of the bead cannot be pushed down into the center of the rim by hand, loosen the press head bolt and the lever nut. Rotate the breaker arm assembly and breaker press head assembly $1/8$ to $1/4$ the circumference of the rim. Tighten the lever nut and then tighten the press head bolt as described. Repeat this procedure as necessary until the remainder of the bead can be pushed down into the center of the rim.

Assemble the Universal Bead Breaker on the other side of the wheel and break the bead following the same procedures.

Remove the tire from the rim using a tire changer machine or tire irons and rim protectors.

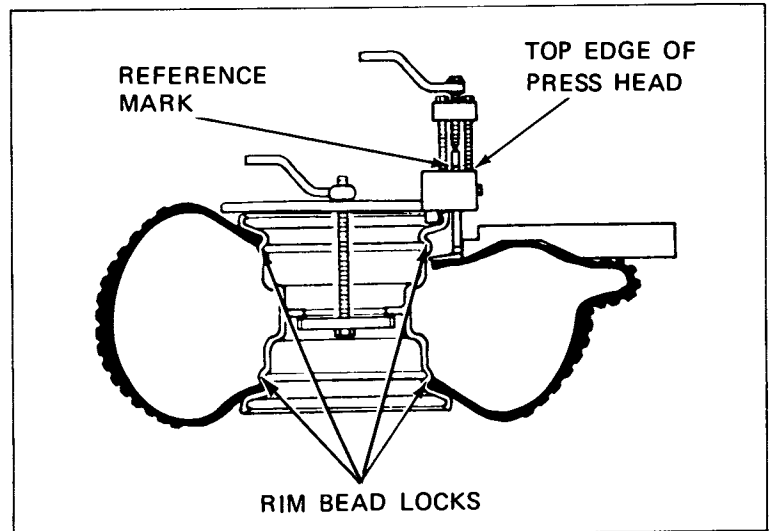
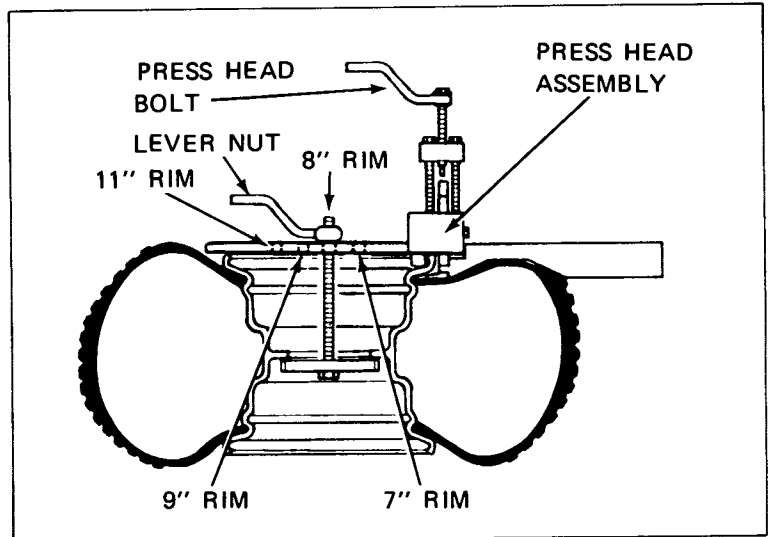

FRONT WHEEL/BRAKE/STEERING

TIRE REPAIR (WITH COLD PATCH)

Check the tire tread for puncturing objects. Chalk mark the punctured area and remove the puncturing object.

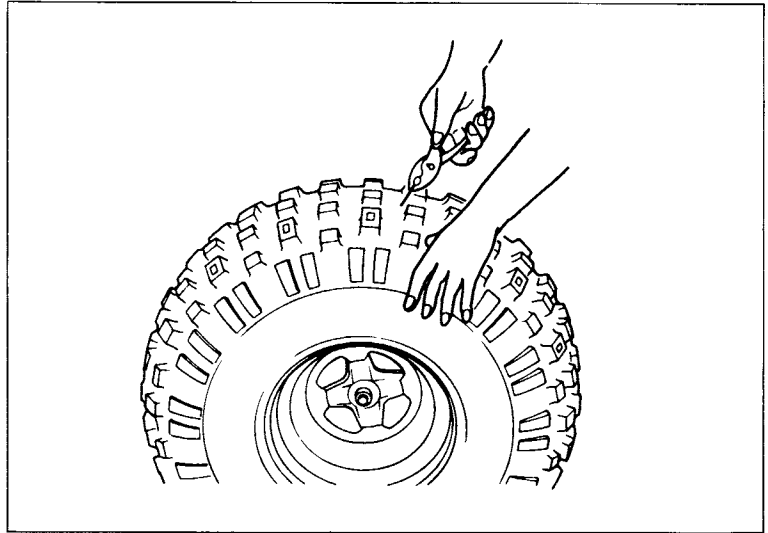

Clean and roughen the punctured area with tire rubber cleaner or a wire brush. Clean the area with non-flammable solvent.

NOTE:

Use a solvent that will not leave an oily residue. Do not use gasoline.

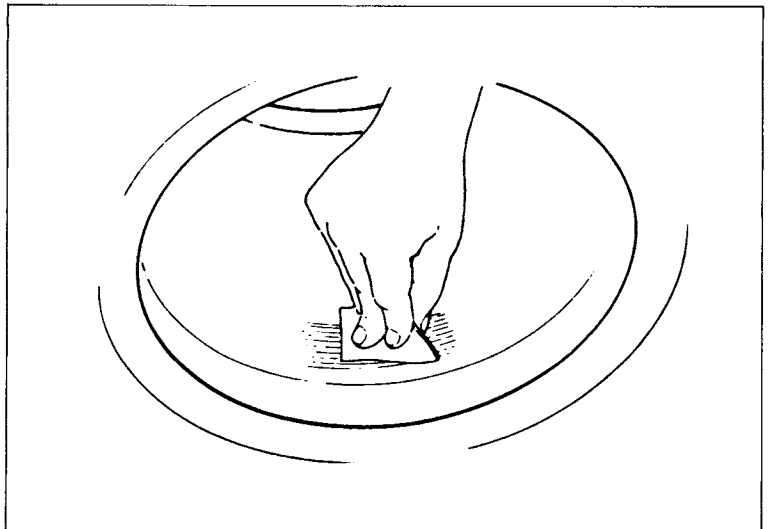

Apply rubber cement around the torn area and allow it to dry. Remove the lining from the patch and center it over the puncture. Press the patch against the puncture using a special roller.

NOTE:

- Allow the cement to dry until tacky before applying a patch.
- Do not touch the cement surface with dirty or greasy hands.

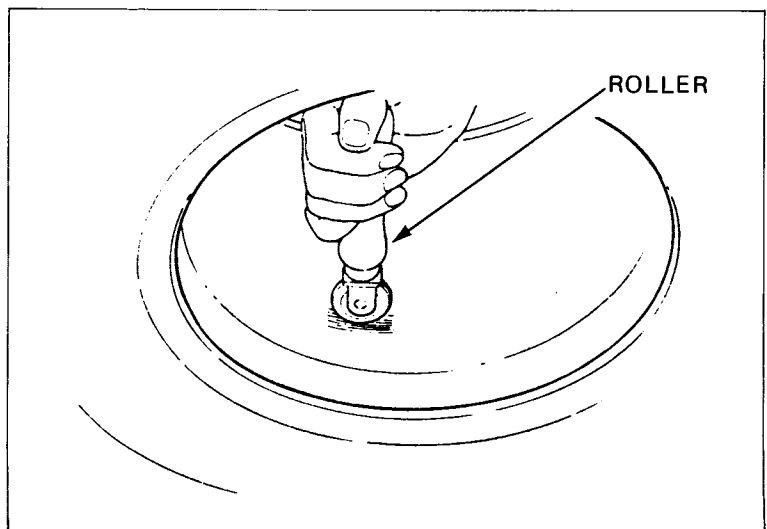

TIRE REPAIR (WITH RUBBER PLUG)

NOTE:

This method is an emergency repair only. Replace the plug at the first opportunity with a cold patch.

Remove the puncturing object.
 Insert a rubber plug through the eye of an inserting needle.

Apply patching cement to the plug.

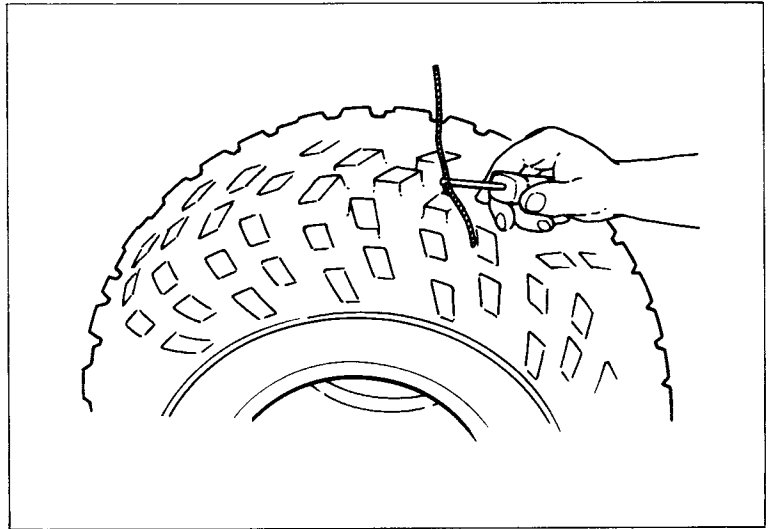

Center the needle on the plug and insert until the plug is all the way in the tire.
 Twist the needle several times.

Pull the needle straight out so that the plug is about 10 mm (3/8 in) above the tread surface.
 Trim the plug 2 mm (1/16 in) above the surface.

Repeat the above procedure if the puncture is large.

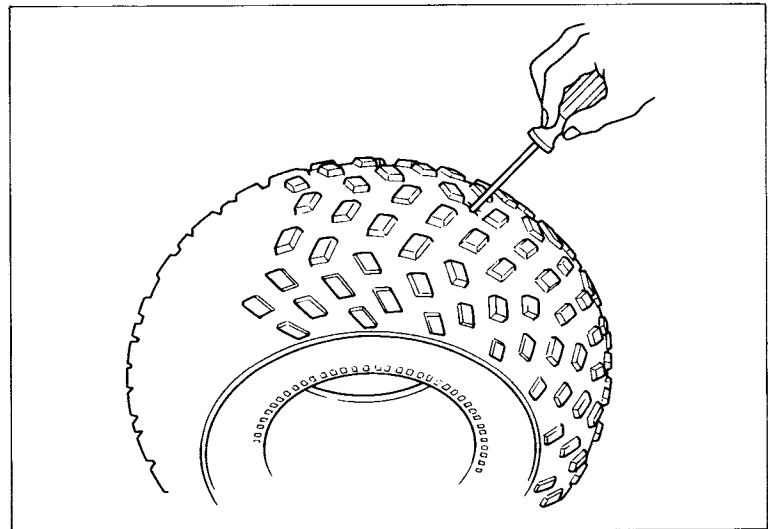

TIRE ASSEMBLY

Clean the rim bead seat and flanges.

Install the tire on the rim.

Apply a coat of clean water to the rim flanges, bead seat and tire bead.

CAUTION:

Never use silicone lubricants.

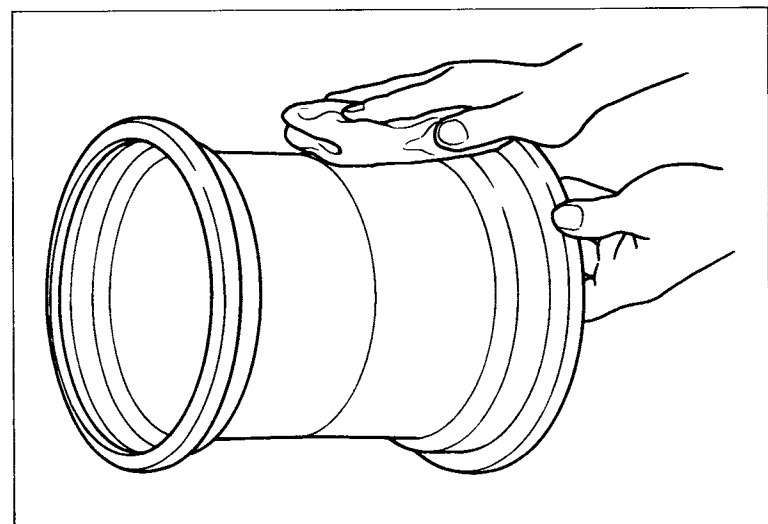

FRONT WHEEL/BRAKE/STEERING

Inflate the tire to seat the tire bead.

CAUTION:

Be careful not to inflate the tire with more than 1.2 kg/cm² (17 psi) of air.

If the tire does not seat on the rim with 1.2 kg/cm² (17 psi) of air pressure, release the air from the tire and apply a coat of soapy water to the tire bead and bead seating surface of the rim. Then, inflate the tire with air again.

Deflate the tire. Wait 1 hour and inflate the tire to the specified pressure.

| Recommended pressure | Min. pressure | Max. pressure | Standard tire circumference |
|--|--|--|-----------------------------|
| 2.2psi (15kpa, (0.15kg/cm ²) | 1.7psi (12kpa, (0.12kg/cm ²) | 2.6psi (18kpa, (0.18kg/cm ²) | 1759mm (69.3in) |

NOTE:

The rear tires must have the same circumference to prevent improper steering and handling.

Check for air leaks and install the valve cap.

FRONT WHEEL ASSEMBLY

Pack all front wheel bearing cavities with wheel bearing grease.

Drive in the left bearing.

Install the collar and drive in the right bearing.

NOTE:

Do not allow the bearings to tilt while driving them in.

Apply grease to the inside of each dust seal. Install the dust seals.

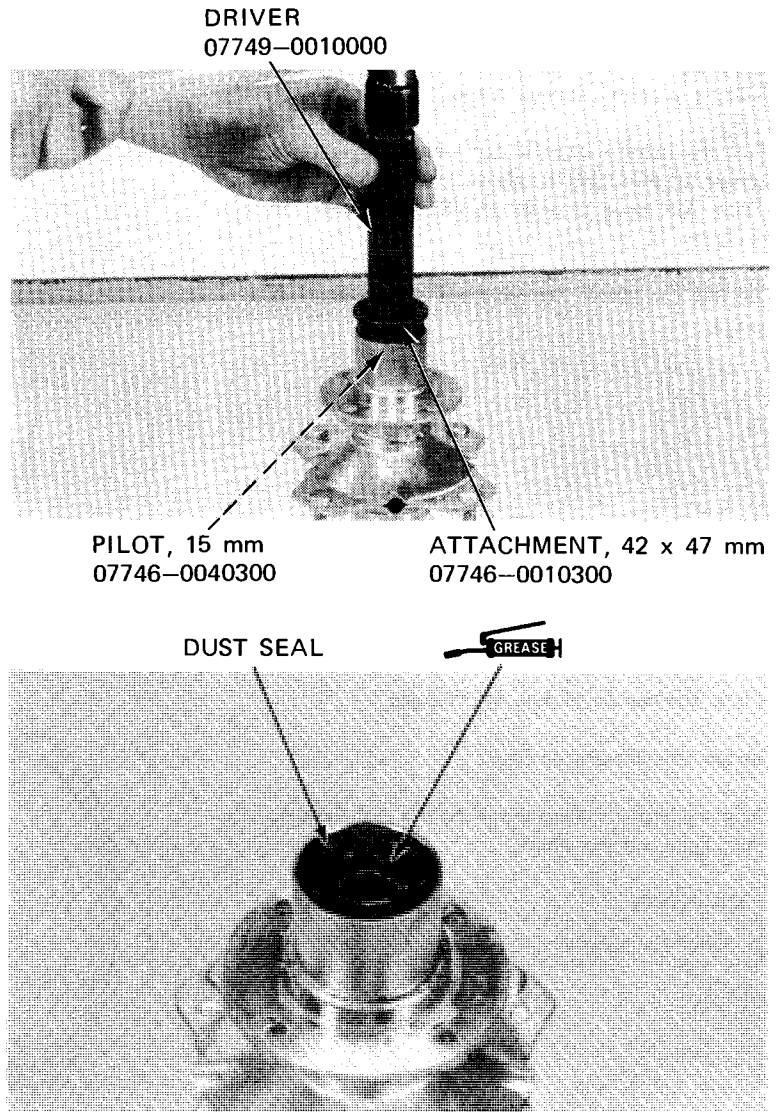

Install the front wheel hub and tighten the hub nuts.

TORQUE: 20–25 N·m (2.0–2.5 kg·m, 14–18 ft·lb)

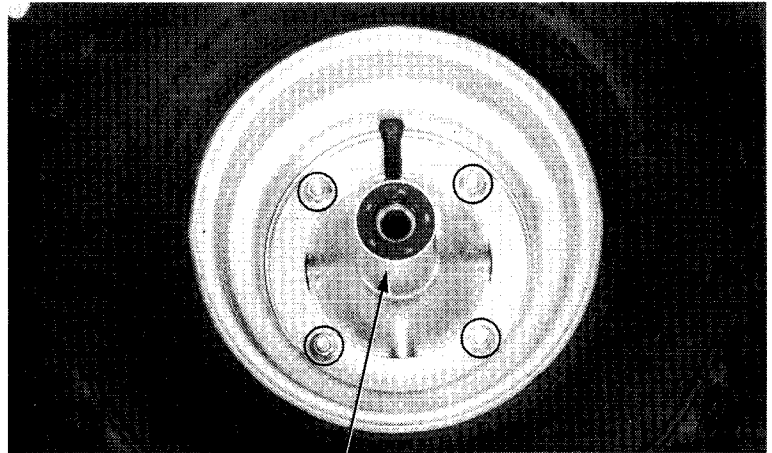

WHEEL HUB

Install the brake drum and lock plates.

Tighten the bolts to the specified torque.

TORQUE: 20–25 N·m (2.0–2.5 kg·m, 14–18 ft·lb)

Bend the tabs of the lock plates up.

BRAKE DRUM

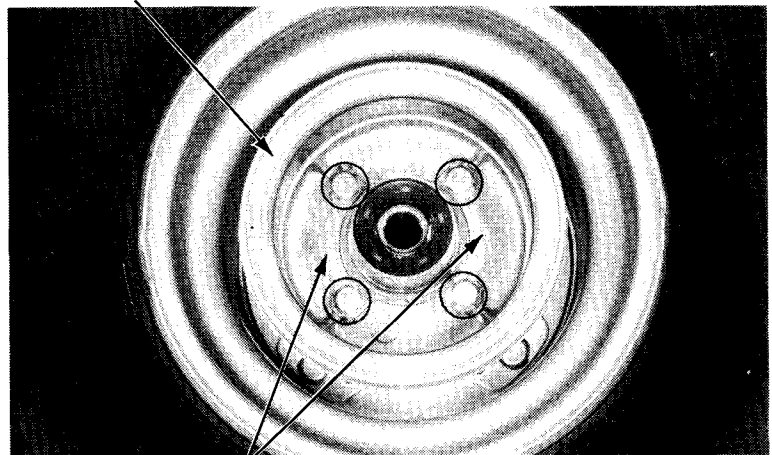

LOCK PLATES

AXLE COLLAR

BRAKE PANEL

FRONT WHEEL INSTALLATION

Install the axle collar and brake panel.

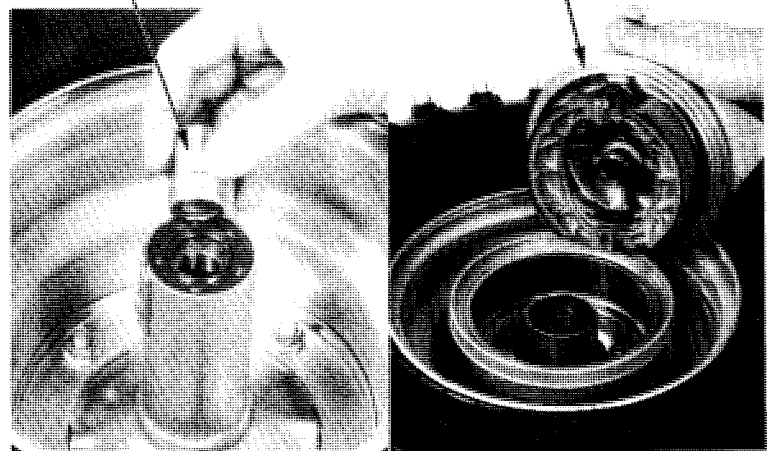

FRONT WHEEL/BRAKE/STEERING

Install the axle holder with the "UP" mark facing upwards. Install the axle holder nuts.

NOTE

Do not tighten the nuts at this time.

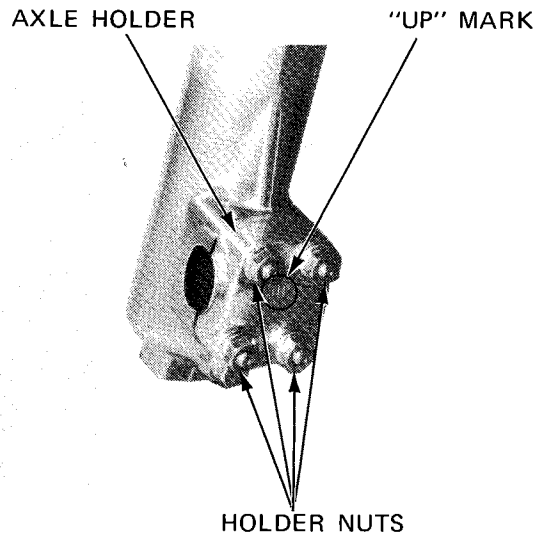

Install the front wheel between the front forks aligning the tab on the brake panel with the hole in the right front fork. Insert the front axle from the left front fork. Tighten the axle to the specified torque.

TORQUE: 70–110 N·m (7.0–11.0 kg·m, 51–80 ft·lb)

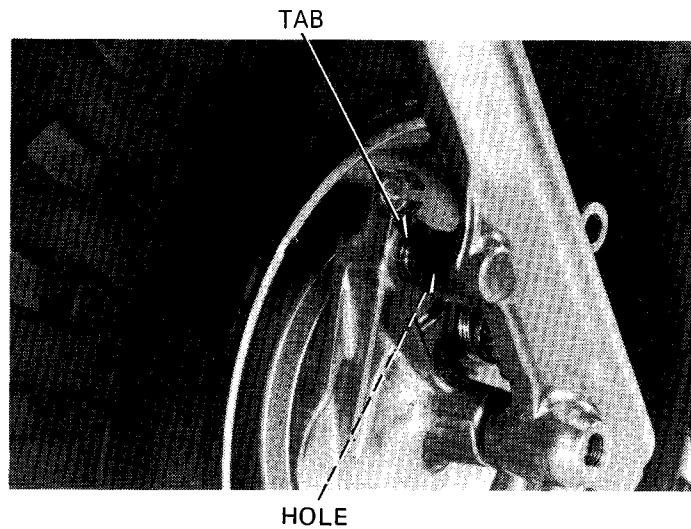

Tighten the axle holder nuts to the specified torque.

TORQUE: 10–14 N·m (1.0–1.4 kg·m, 7–10 ft·lb)

Install the front brake cable and adjust the front brake lever free play (Page 3-14).

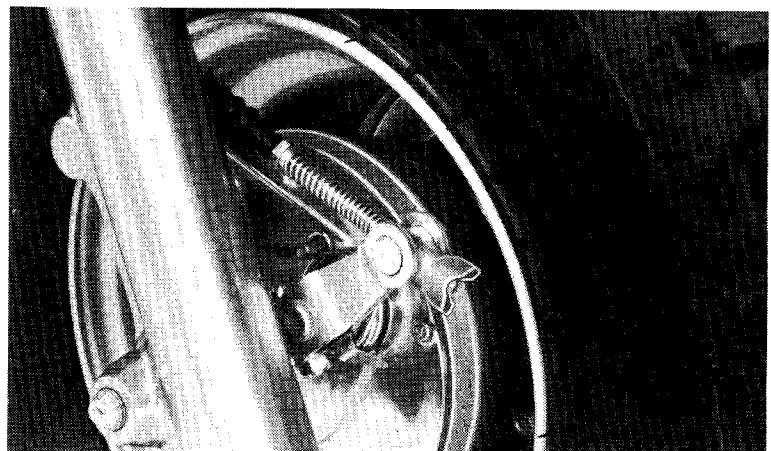

FRONT BRAKE

REMOVAL

Remove the front wheel (Page 11-9).
Remove the brake panel from the wheel.

BRAKE LINING INSPECTION

Measure the brake lining thickness.

SERVICE LIMIT: 2 mm (0.1 in)

Replace the brake shoes if the linings are thinner than the service limit.

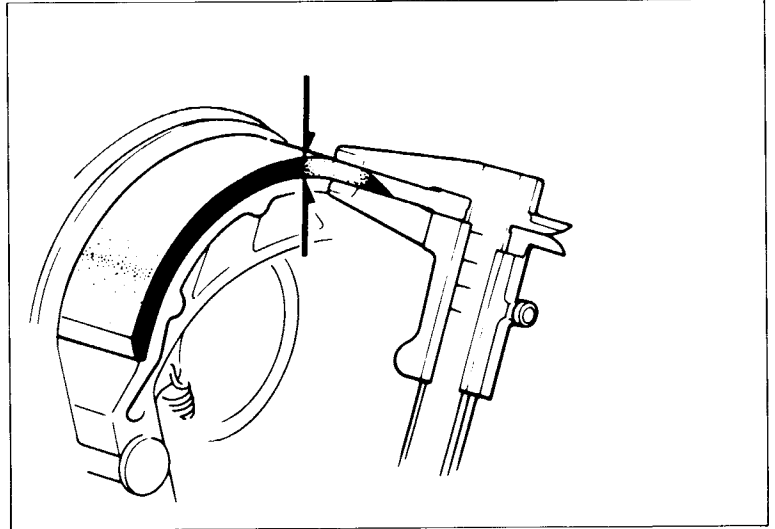

BRAKE PANEL DISASSEMBLY

Expand and remove the brake shoes by hand.

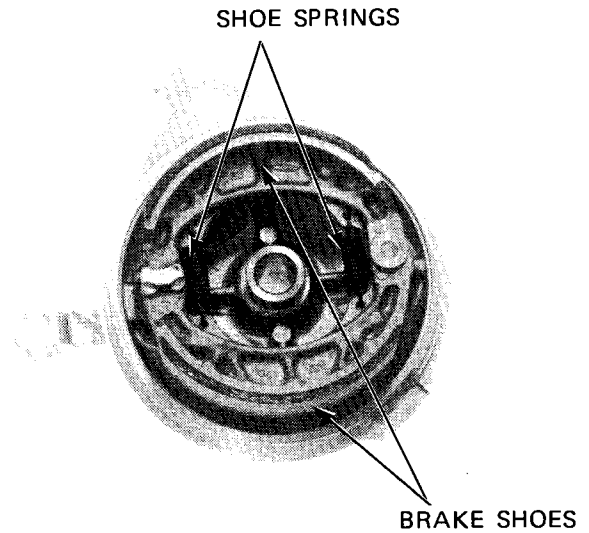

Disengage the return spring.
Remove the brake arm bolt, brake arm, indicator plate and return spring.
Remove the brake cam and thrust washer, rubber seals and dust seal.

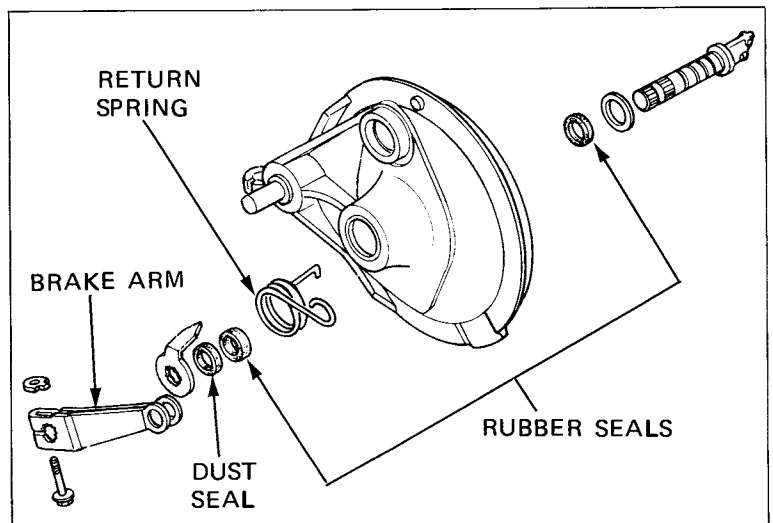

FRONT WHEEL/BRAKE/STEERING

BRAKE PANEL ASSEMBLY

Install new rubber and dust seals.

Install the thrust washer.

Apply grease to the brake camshaft.

WARNING

- *A contaminated brake lining reduces stopping power.*
- *Keep grease off the linings. Wipe excess grease off the cam.*

Install the brake camshaft.

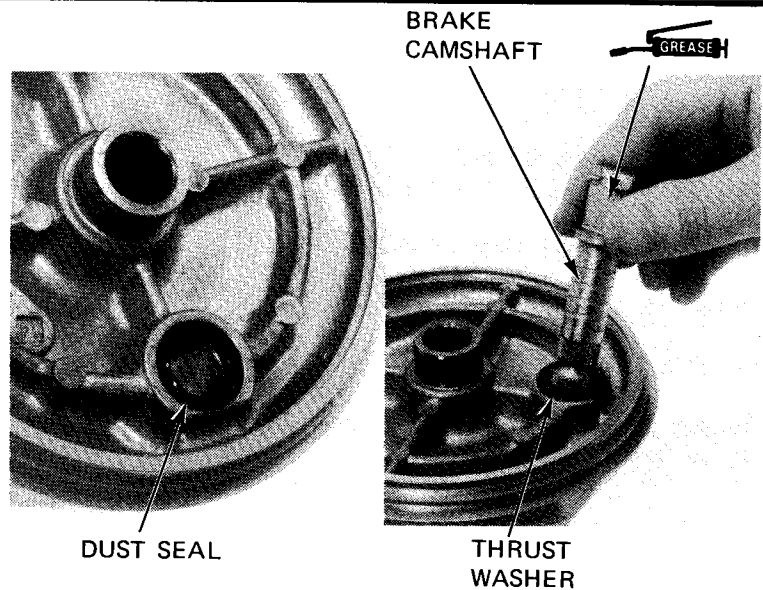

Install and engage the return spring as shown. Install the wear indicator aligning the indicator tab with the brake cam groove.

Install the brake arm aligning the brake cam with brake arm punch marks.

Engage the return spring to the brake arm.

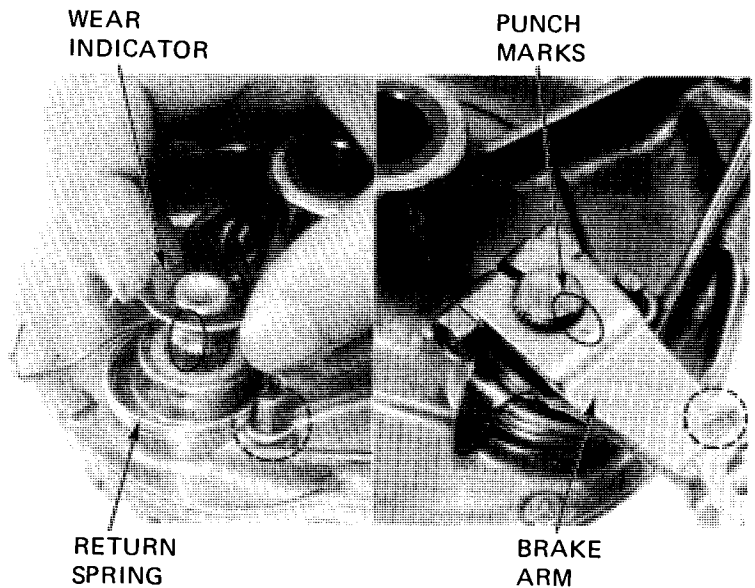

Install the shoe springs and brake shoes.

Install the brake panel onto the wheel (Page 11-17).

Install the front wheel (Page 11-18).

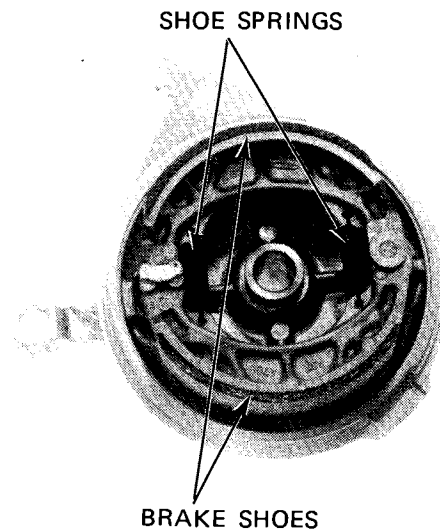

FRONT FORK

DISASSEMBLY

Place a support block under the engine to raise the front wheel off the ground.
Remove the front wheel (Page 11-9).

Remove the front fork setting bolts and remove the front fork.

SETTING BOLTS

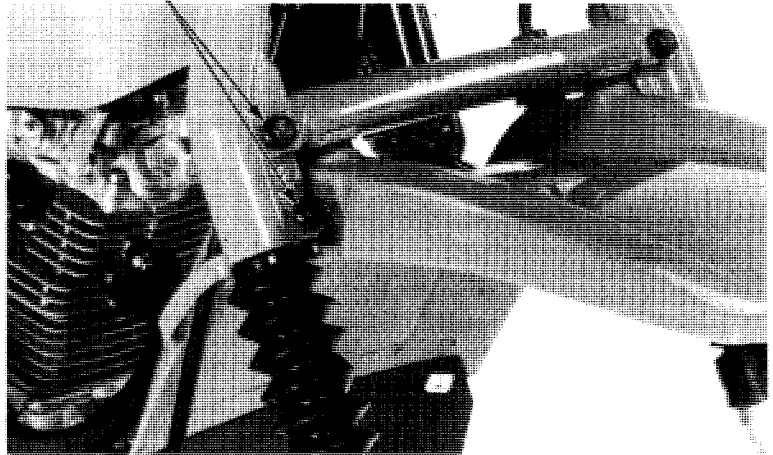

Loosen the fork boot clamp.
Remove the fork boot.

FORK BOOT CLAMP

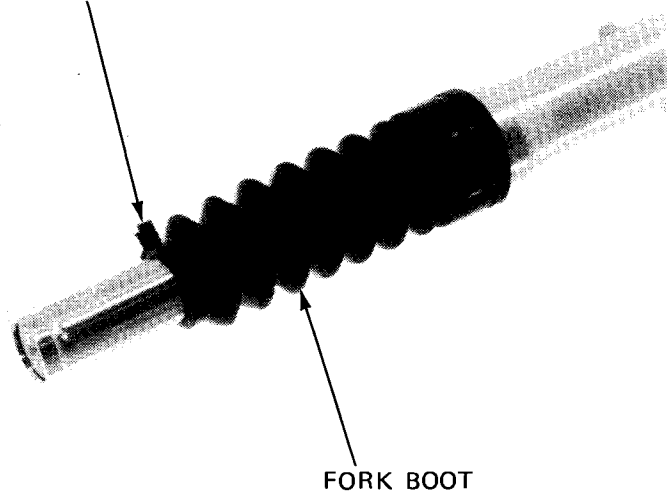

Hold the fork slider in a vise with soft jaws or a shop towel.
Remove the hex bolt.

HOLLOW SET WRENCH 6 mm
07917-3230000 OR EQUIVALENT

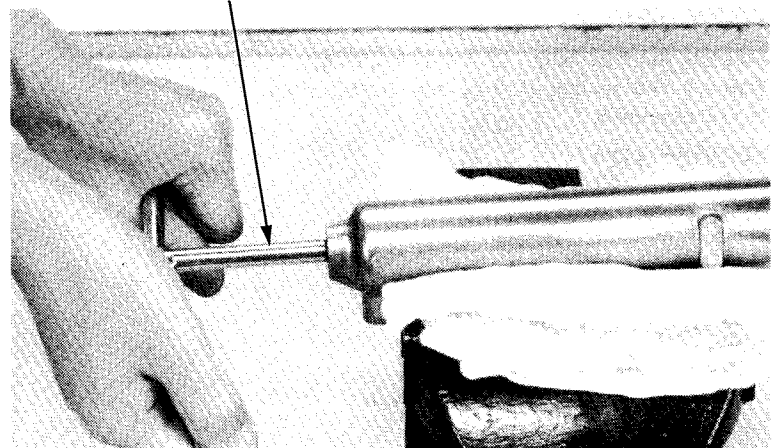

CAUTION:

*Do not overtighten the slider in the vise.
Overtightening will damage the slider.*

FRONT WHEEL/BRAKE/STEERING

Support the fork tube in a hydraulic press. Compress the fork cap about 20 mm and remove the circlip.

NOTE

Use an appropriate cone shaped adapter on the hydraulic press.

CAUTION

- *Do not compress the fork cap more than necessary to remove the circlip.*
- *Always wear eye and face protection whenever operating a hydraulic press.*

Remove the fork tube from the press.
Remove the fork cap.

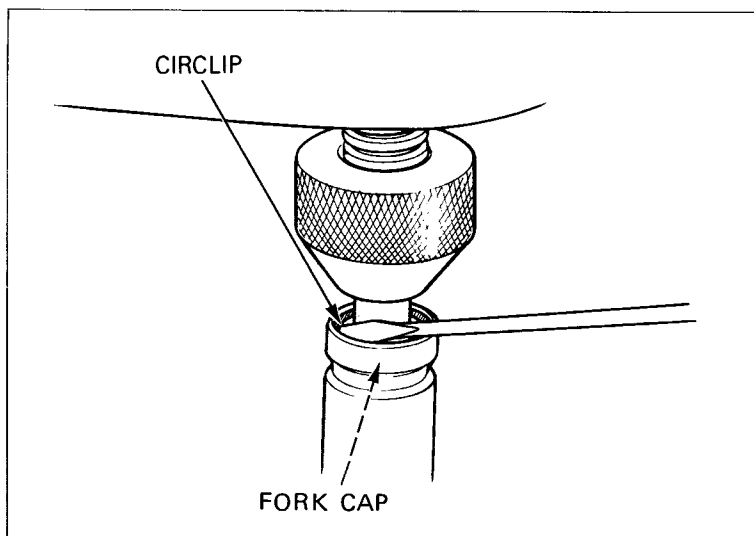

Remove the washer and fork springs.
Turn the fork tube upside down and pump it to help drain the fork fluid.

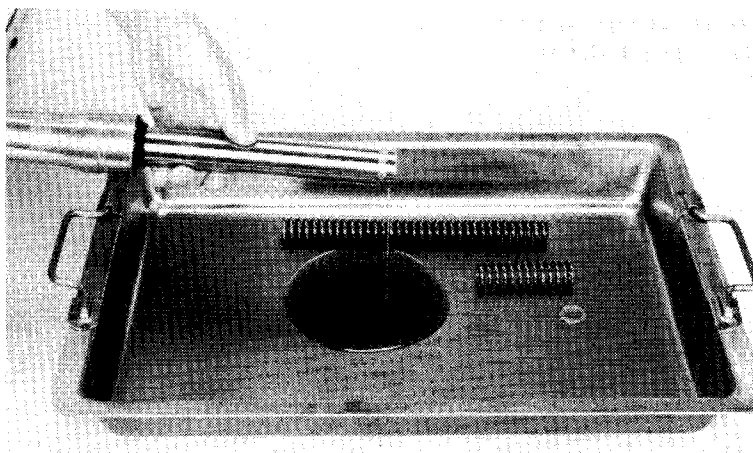

FORK SPRING INSPECTION

Measure the free length of the fork springs.
Replace the springs if they are shorter than the service limit.

SERVICE LIMIT:

Spring A: 278.7 mm (10.97 in)

Spring B: 38.9 mm (1.5 in)

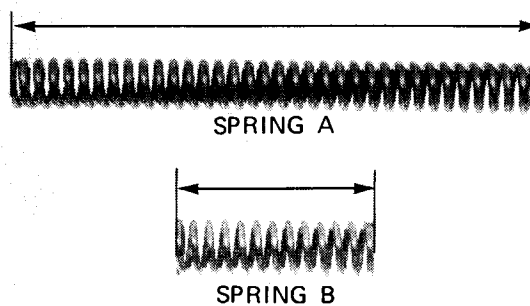

Remove the fork tube from the fork slider.
Remove the oil lock piece, piston and rebound spring.

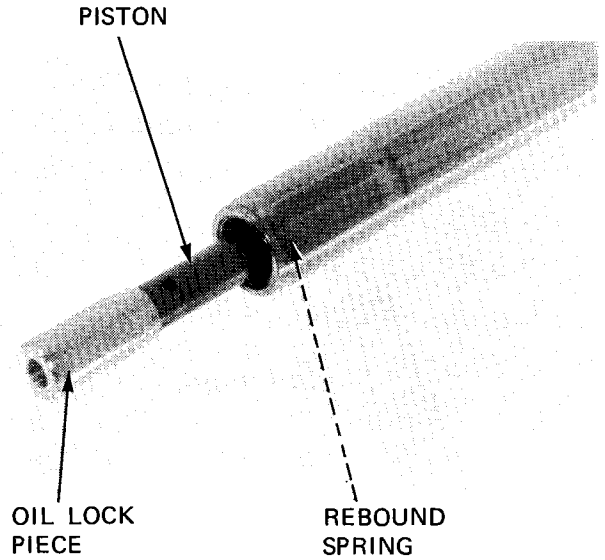

Remove the dust seal.
Remove the snap ring and oil seal.

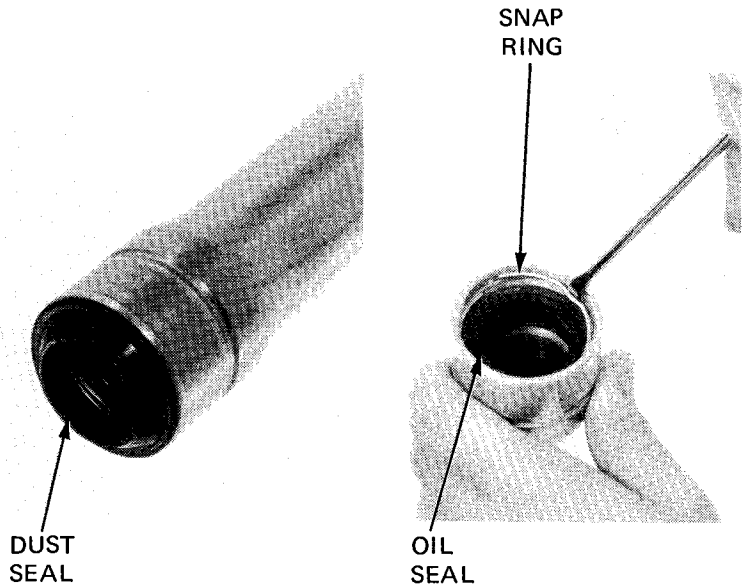

FORK TUBE, PISTON AND FORK SLIDER INSPECTION

Check the fork tube, piston and slider for score marks, scratches or abnormal wear. Replace any components which are worn or damaged.

Check the fork piston ring for wear or damage.
Check the rebound spring for fatigue or damage.

Place the fork tube in V blocks and read the runout.

Take 1/2 of the total indicator reading to determine the actual amount of runout.

SERVICE LIMIT: 0.20 mm (0.008 in)

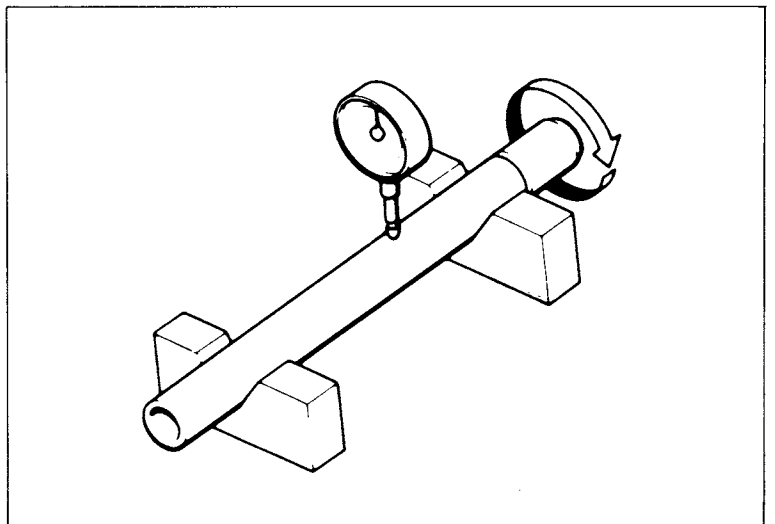

FRONT WHEEL/BRAKE/STEERING

INSTALLATION

NOTE:

Wash all removed parts in non-flammable solvent and wipe them off thoroughly before assembly.

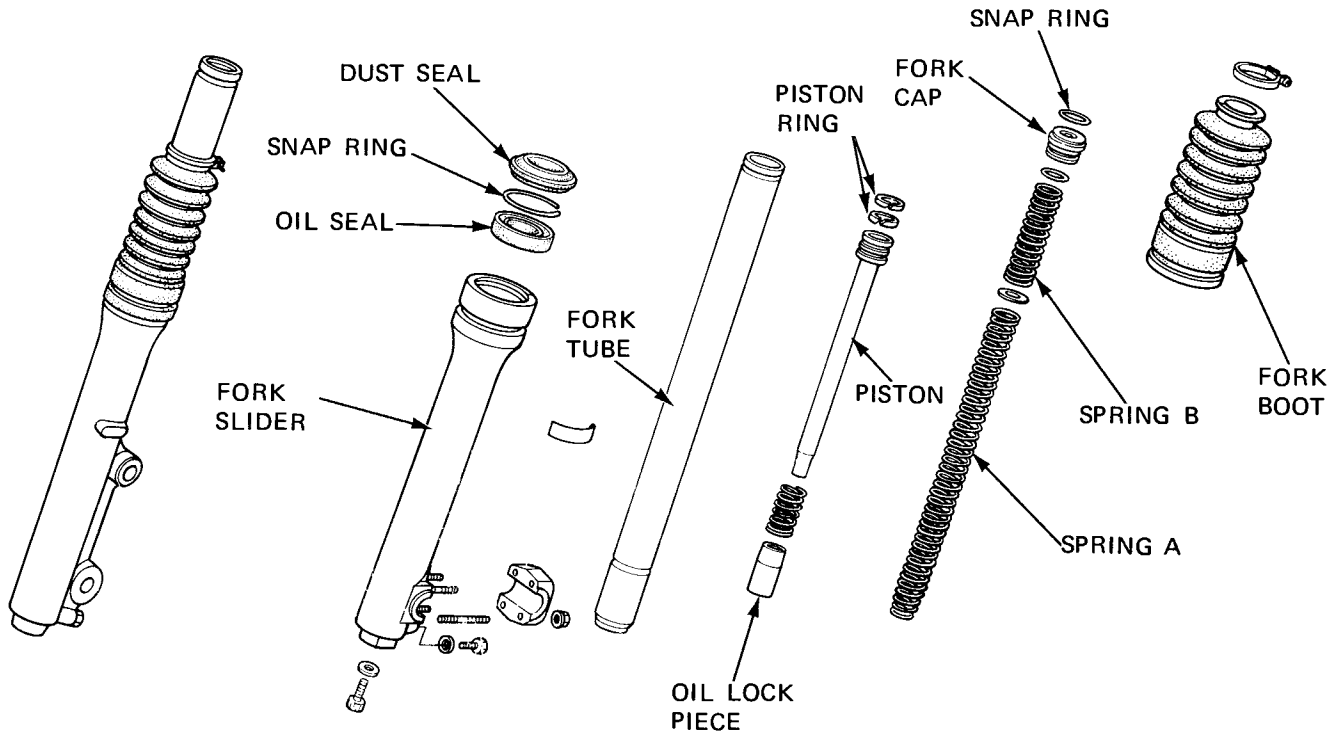

Install the piston ring on the piston.

Place the rebound spring and piston into the fork tube. Place the oil lock piece on the end of the piston and insert the fork tube into the slider.

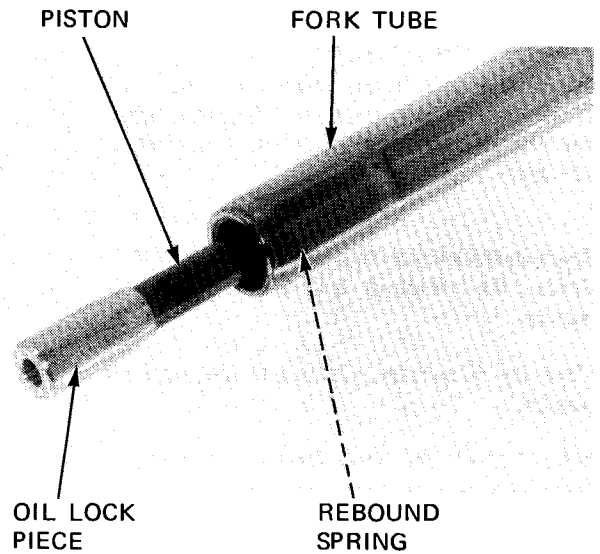

Clean the hex bolt threads and apply a locking agent to the threads.

NOTE:

- To tighten the hex bolt, it may be necessary to install the fork springs and tighten the fork cap temporarily (Page 11-26).
- Take care not to distort the slider in the vise.

TORQUE: 15–25 N·m (1.5–2.5 kg·m, 11–18 ft·lb)

Tighten the oil drain plug securely.

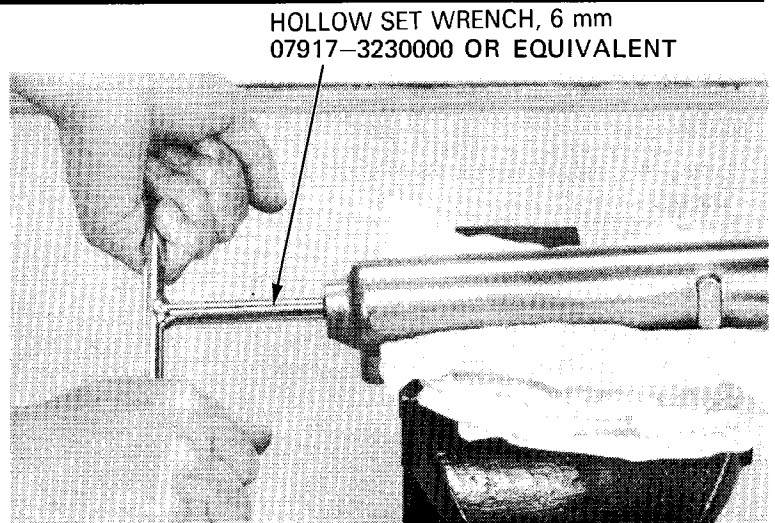

Install the oil seal into the top of the slider.
Apply ATF to the oil seal and drive it in with the fork seal driver.
The fork seal is seated when the groove in the slider is seen at the top of the seal.
Install the snap ring and dust seal.

FORK SEAL DRIVER 07747–0010100
ATTACHMENT 07747–0010500

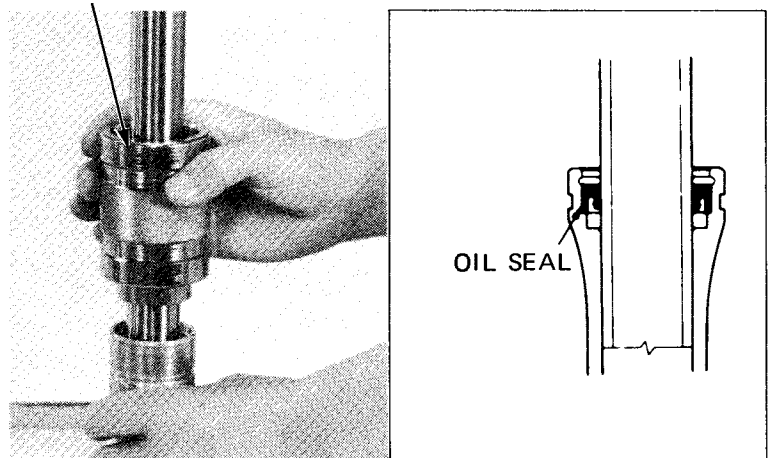

Fill the forks with the specified amount of ATF.

SPECIFIED FLUID: ATF or equivalent
CAPACITY: 90 ± 2.2 cc (3.0 ± 0.08 oz)

NOTE:

- Do not overfill. Overfilling causes harsh suspension performance.
- Fill both forks with equal amounts of ATF.

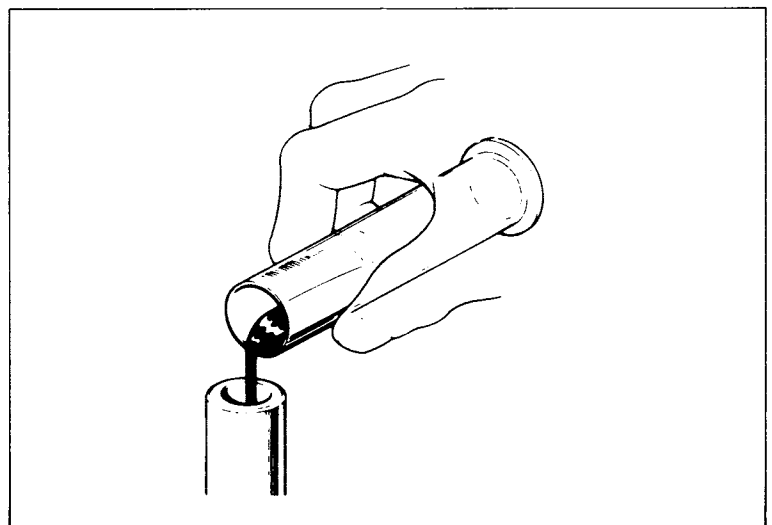

FRONT WHEEL/BRAKE/STEERING

Install the spring B, thrust washer and spring A into the fork tube.

NOTE

Spring A's tightly wound coils should face up.

Place the fork cap into place.

Support the fork tube in a hydraulic press.

Compress the cap about 20 mm and install the circlip.

Install the fork tube seal dust cover.

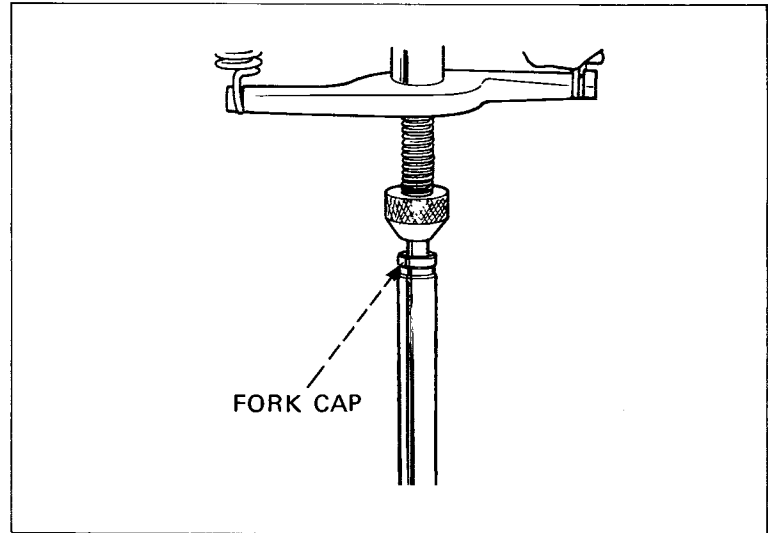

Install the boot and boot clamp.

NOTE:

Do not tighten the clamps until the forks are properly installed on the vehicle.

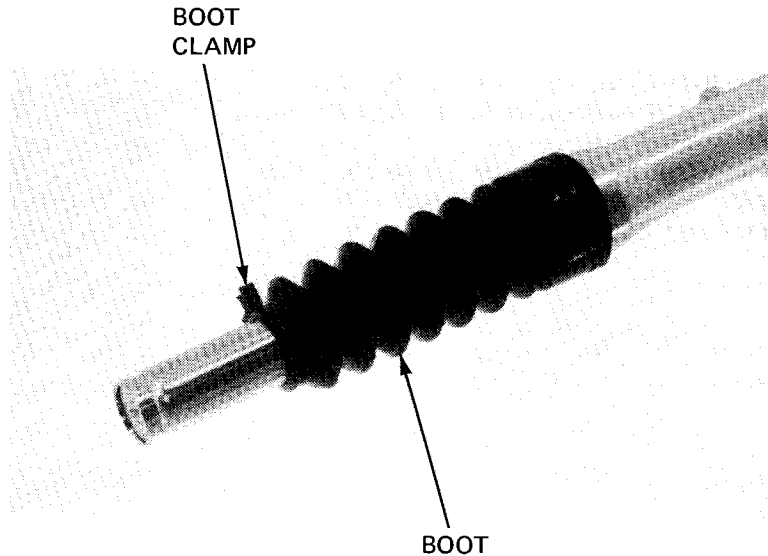

Insert the front forks into the steering stem. Install the front fork upper bolt, aligning the groove on the front fork tube with the bolt.

Tighten the bolts to the specified torque.

**TORQUE: 40–50 N·m (4–5 kg·m,
29–36 ft·lb)**

Slide the fork boot up to the steering stem and tighten the fork boot clamp.

Install the front wheel (Page 11-8).

Adjust the front brake lever free play. (Page 3-14).

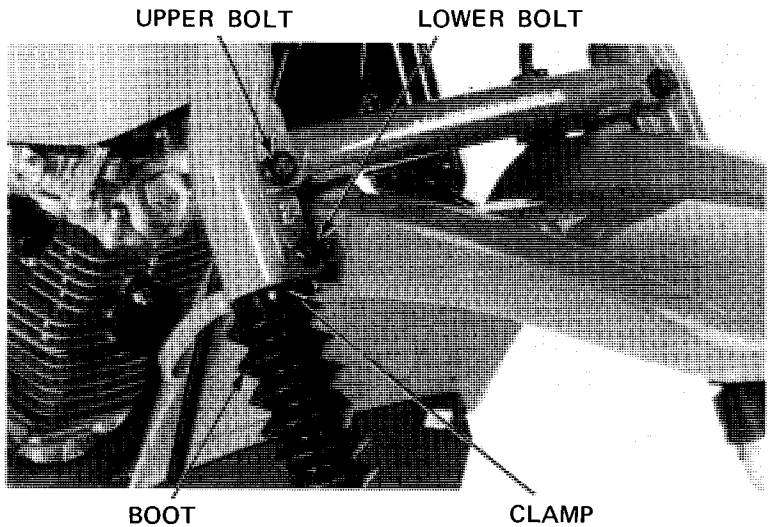

STEERING STEM

FORK BRIDGE REMOVAL

Remove the following:

- headlight and headlight case bracket (Page 11-3).
- Handlebar (Page 11-5).
- front wheel (Page 11-9).
- front fender.

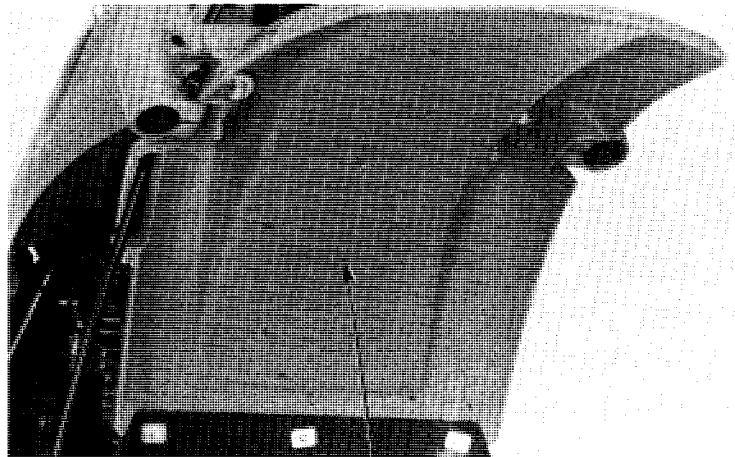

FRONT
FENDER

EXTENSION BAR
07716-0020500

LOCK NUT WRENCH, 30 x 32 mm
07716-0020400 or equivalent

Remove the steering stem nut and fork bridge bolts.
Remove the fork bridge.

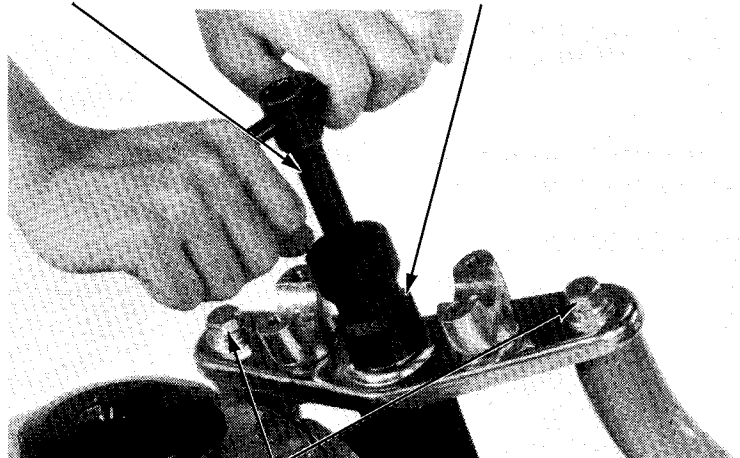

FORK BRIDGE
BOLTS

PIN SPANNER
07702-0010000 or M9361-412-1299788 (Available in U.S.A.)

FRONT FORK REMOVAL

Remove the steering stem top thread nut.

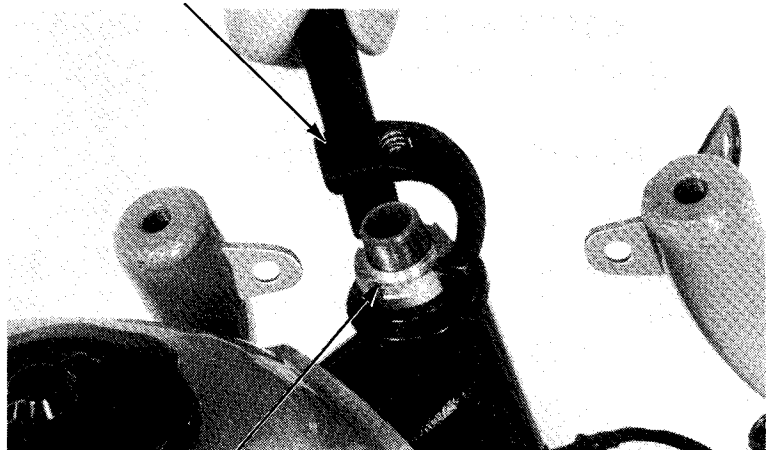

TOP THREAD NUT

FRONT WHEEL/BRAKE/STEERING

Remove the front fork and bearings being careful not to drop the ball bearings.

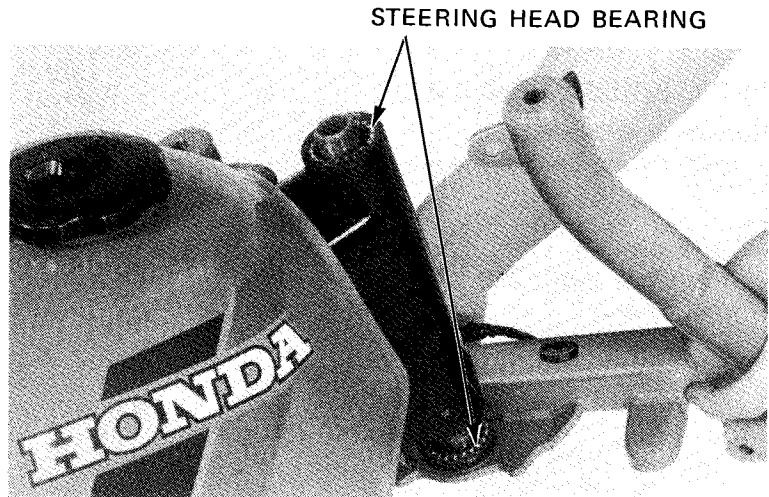

Check the cone and ball races for wear or damage and replace if necessary.

NOTE:

Replace the balls and races as a set when any component is damaged.

Remove the ball race.

BALL RACE REMOVER
07944-1150001 or M9360-277-91774 (U.S.A)

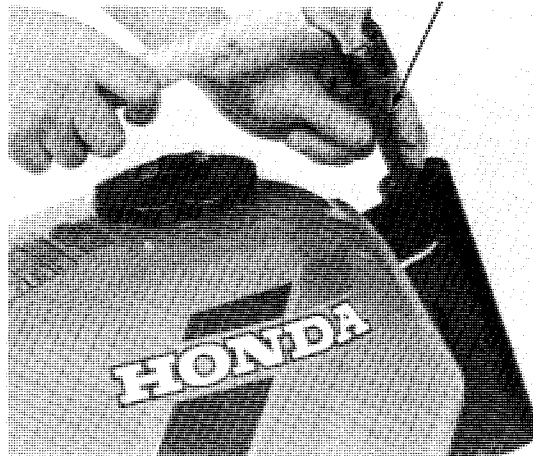

STEERING STEM INSTALLATION

Install the washer and dust seal onto the steering stem.

Press the bottom cone race onto the steering stem.

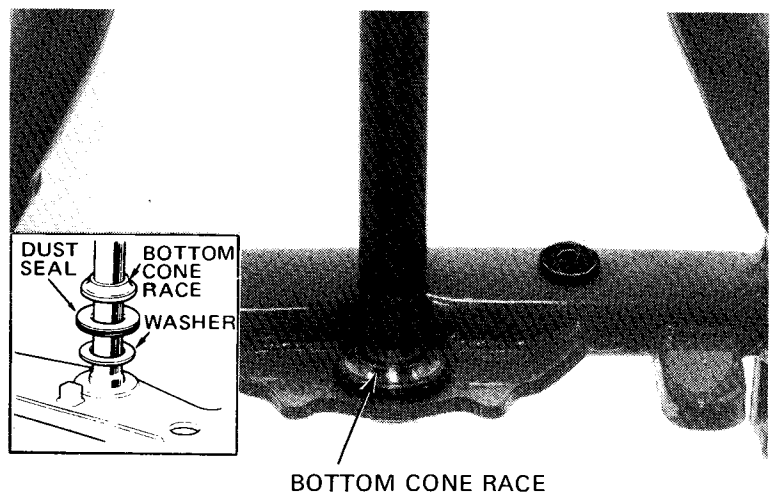

Drive in the ball races with the driver and attachment.

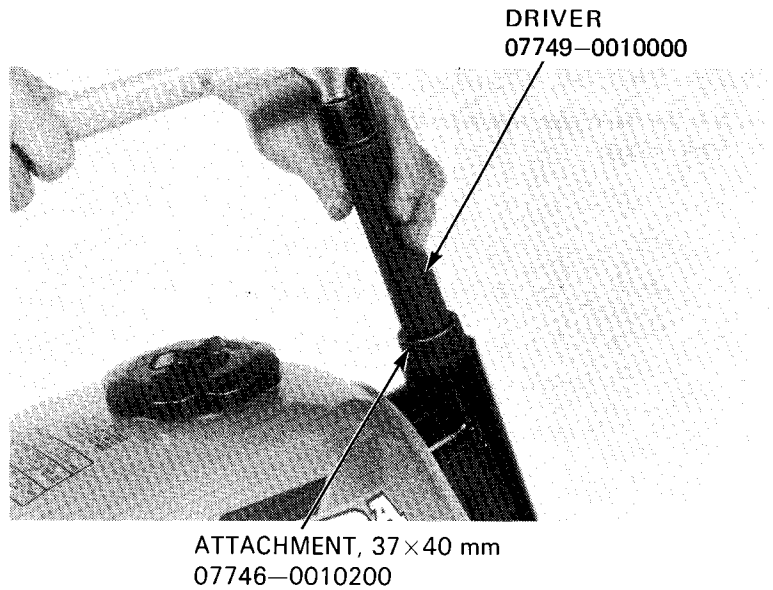

Apply grease to the ball races and cone races and install the steel balls on the races.

NOTE:

21 steel balls are used for both the top and bottom races.

Slide the steering stem through the steering head from the bottom.

Install the top cone race.
Thread on the top thread nut.

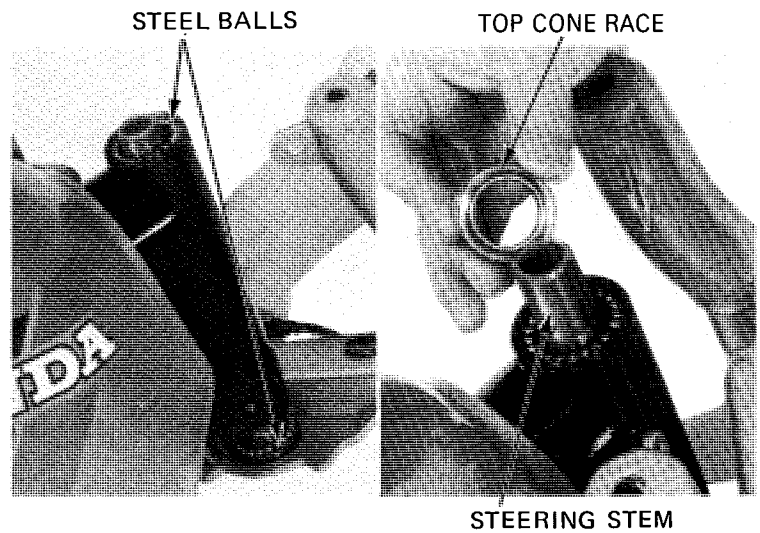

Tighten the top thread nut until snug against the top ball race and back off about 1/8 turn.
Check that the stem rotate freely without axial play.

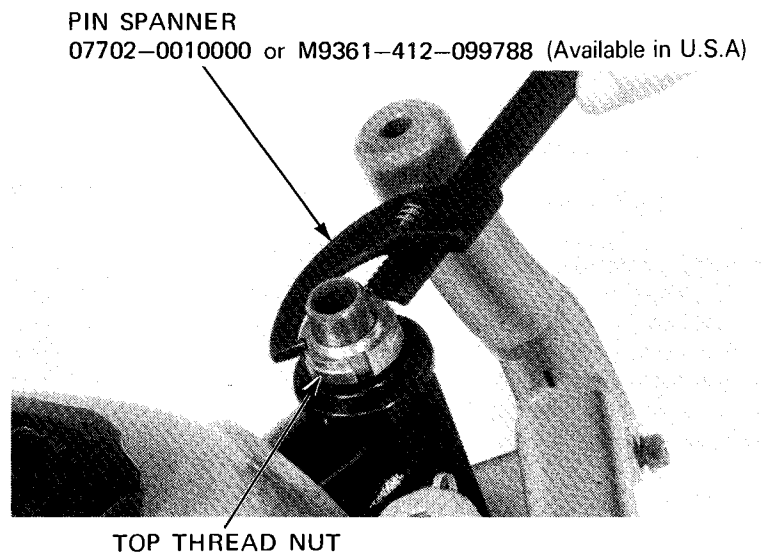

FRONT WHEEL/BRAKE/STEERING

FORK BRIDGE INSTALLATION

Attach the handlebar lower holders loosely to the fork bridge.

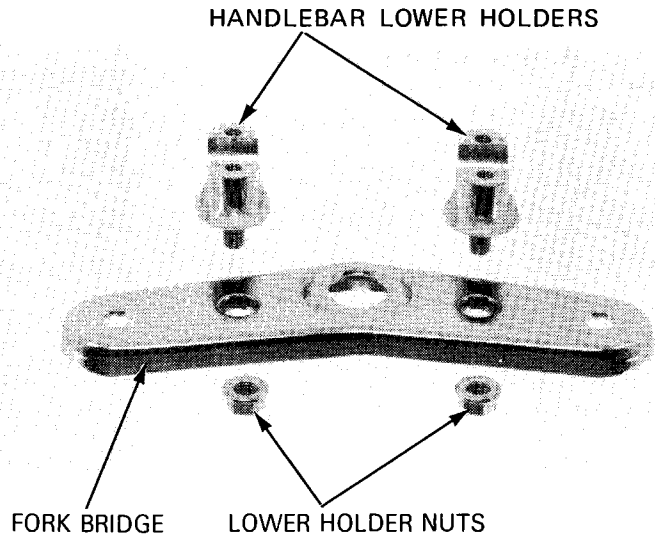

Install the fork bridge and tighten the steering stem nut.

**TORQUE: 50–70 N·m (5.0–7.0 kg·m,
36–51 ft·lb)**

Tighten the fork bolts.

**TORQUE: 50–70 N·m (5.0–7.0 kg·m,
36–51 ft·lb)**

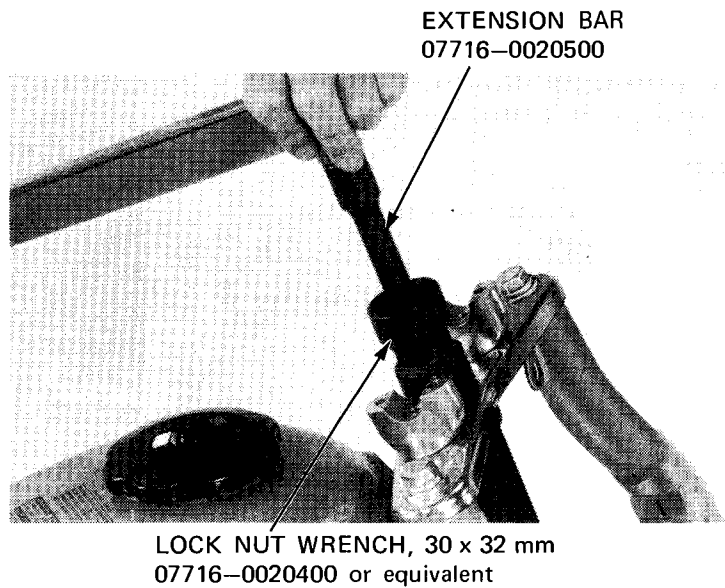

Install the handlebar.

Tighten the handlebar lower holder nuts.

**TORQUE: 40–48 N·m (4.0–4.8 kg·m,
29–35 ft·lb)**

Install the following:

- front fender.
- front fork (Page 11-26).
- front wheel (Page 11-17).
- handlebar (Page 11-5).
- headlight case bracket. (Page 11-5).
- headlight (Page 11-4).

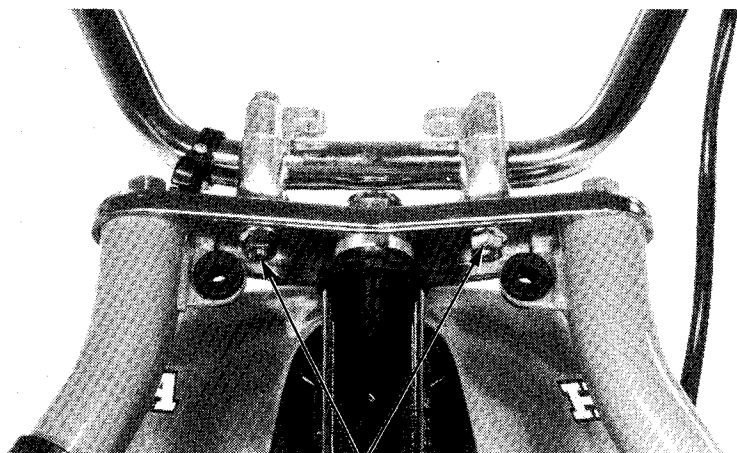



REAR WHEEL/BRAKE/DRIVE MECHANISM

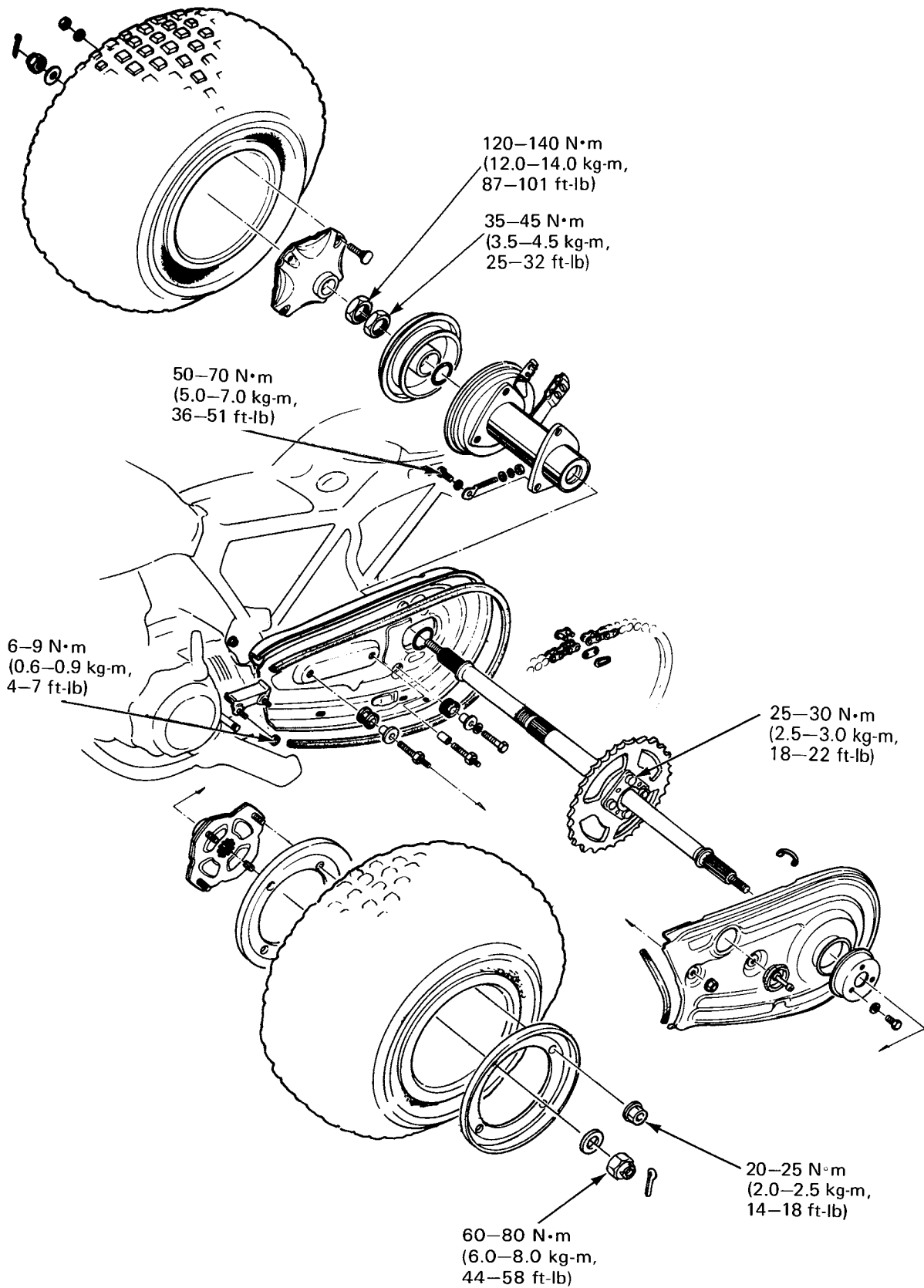

12. REAR WHEEL/BRAKE/ DRIVE MECHANISM

| | |
|---------------------------------|-------|
| SERVICE INFORMATION | 12-1 |
| TROUBLESHOOTING | 12-2 |
| REAR WHEEL | 12-3 |
| REAR AXLE/FINAL DRIVEN SPROCKET | 12-3 |
| REAR BRAKE | 12-10 |
| REAR AXLE BEARING HOLDER | 12-15 |
| DRIVE CHAIN CASE | 12-17 |

SERVICE INFORMATION

GENERAL

- This section covers maintenance of the rear wheel and drive mechanism.
- A jack or block is required to support the ATC.

SPECIFICATIONS

| ITEM | STANDARD | SERVICE LIMIT |
|-----------------------------|-----------------|--------------------|
| Rear axle runout | ————— | 3.0 mm (0.12 in) |
| Rear brake drum I.D. | 140 mm (5.5 in) | 141 mm (5.6 in) |
| Rear brake lining thickness | 4 mm (0.2 in) | 2 mm (0.1 in) |
| Rear wheel bearing play | Radial | 0.05 mm (0.002 in) |
| | Axial | 0.10 mm (0.004 in) |

TORQUE VALUES

| | | |
|-------------------------------|-----------|--|
| Damper holder nut | | 25–30 N•m (2.5–3.0 kg-m, 18–22 ft-lb) |
| Rear brake drum nut | INNER NUT | 35–45 N•m (3.5–4.5 kg-m, 25–32 ft-lb) |
| | OUTER NUT | 120–140 N•m (12–14 kg-m, 87–101 ft-lb) |
| Rear wheel hub nut | | 20–25 N•m (2.0–2.5 kg-m, 14–18 ft-lb) |
| Rear axle bearing holder bolt | | 50–70 N•m (5.0–7.0 kg-m, 36–51 ft-lb) |
| Drive chain slider nut | | 6–9 N•m (0.6–0.9 kg-m, 4–7 ft-lb) |
| Rear axle nut | | 60–80 N•m (6.0–8.0 kg-m, 44–58 ft-lb) |

TOOLS

SPECIAL

| | | |
|-------------------------|---------------|---------------------------|
| Lock nut spanner, 41 mm | 07916–9580200 | } Not available in U.S.A. |
| Lock nut wrench, 41 mm | 07916–9580300 | |

Common

| | | |
|----------------------|---------------|---------------------------|
| Attachment, 62×68 mm | 07746–0010500 | } Not available in U.S.A. |
| Driver | 07749–0010000 | |
| Pilot, 35 mm | 07746–0040800 | |

TROUBLESHOOTING

Wobble or vibration in motorcycle

1. Bent rim
2. Loose wheel bearing
3. Faulty rear axle bearing holder
4. Faulty tire
5. Axle not tightened properly

Poor brake performance

1. Improper brake adjustment
2. Worn brake shoes
3. Brake linings oily, greasy or dirty
4. Worn brake cam
5. Worn brake drum
6. Brake arm serrations improperly engaged
7. Brake shoes worn at cam contact area

REAR WHEEL

REMOVAL

Raise the rear wheels off the ground with a jack or block under the engine.
Remove the rear wheel nuts.
Remove the rear wheels.

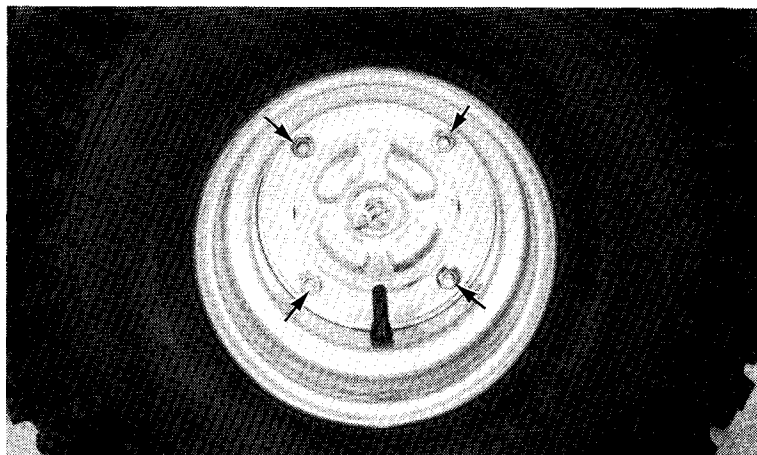

REAR TIRE DISASSEMBLY/ASSEMBLY

For tire disassembly, assembly, and repair, refer to page 11-12.

INSTALLATION

Install each rear wheel with the tire valve facing out.

Tighten the wheel nuts.

**TORQUE: 20–25 N·m (2.0–2.5 kg·m,
14–18 ft·lb)**

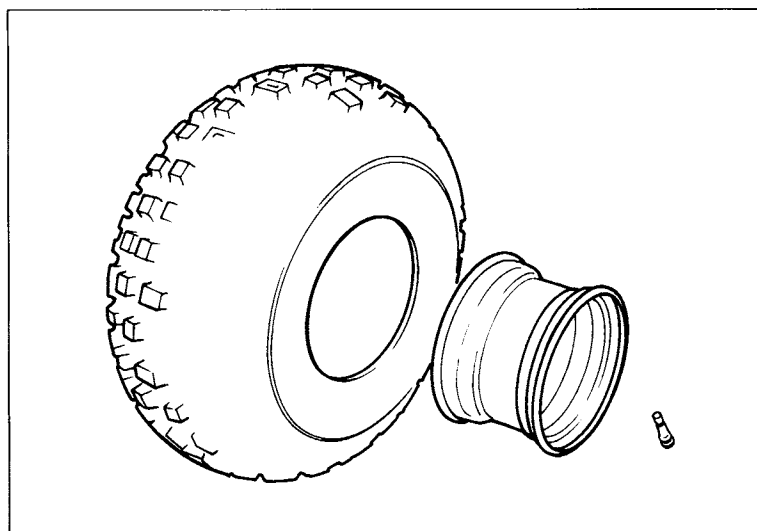

REAR AXLE/FINAL DRIVEN SPROCKET

REAR AXLE REMOVAL

Raise the rear wheels off the ground with a jack or block under the engine.
Remove the rear wheel nuts and rear wheels.

Remove the cotter pin from the axle shaft and loosen the wheel hub nut.
Remove the hub nuts, lock washer and wheel hubs from the shaft.

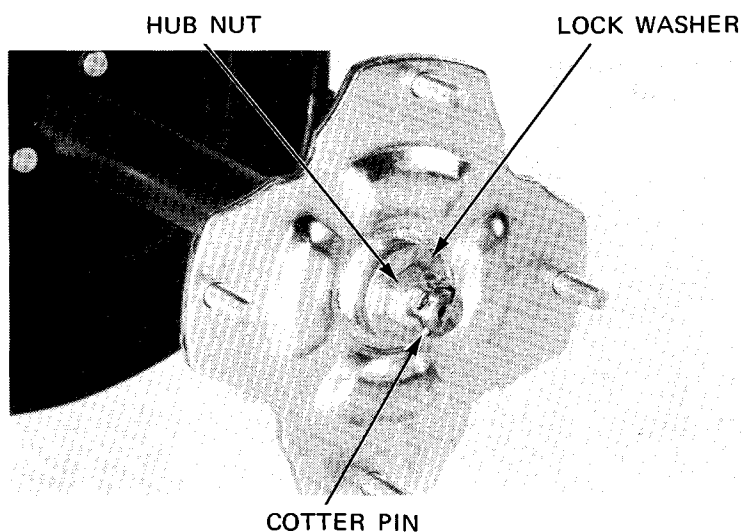

REAR WHEEL/BRAKE/DRIVE MECHANISM

Remove the four bolts holding the skid plate and remove the skid plate.

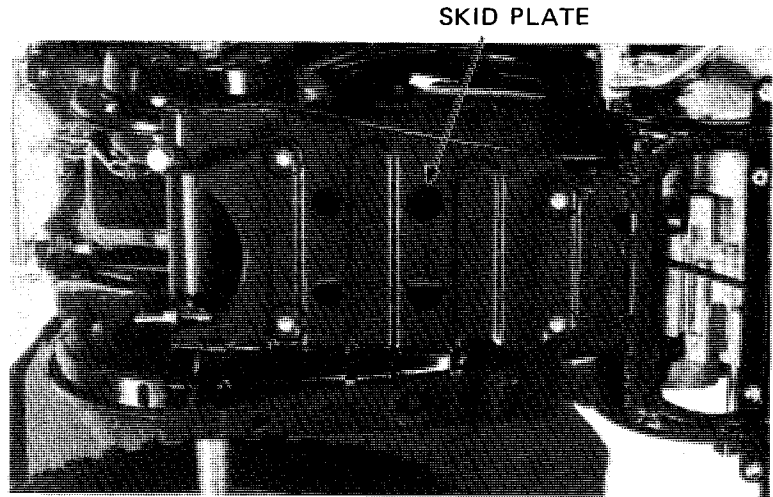

Remove the sealed cover by removing the three bolts.
Pull off the chain cover clips and remove the drive chain cover by removing the two nuts.

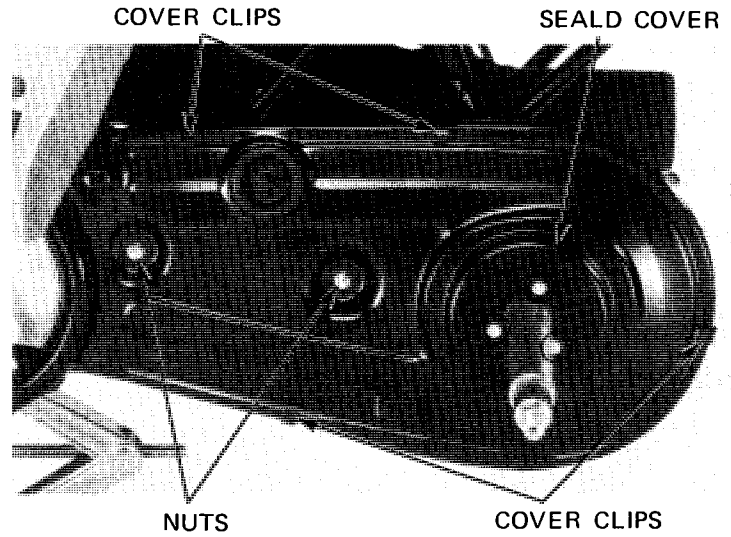

Loosen the bearing holder bolts and drive chain adjuster.

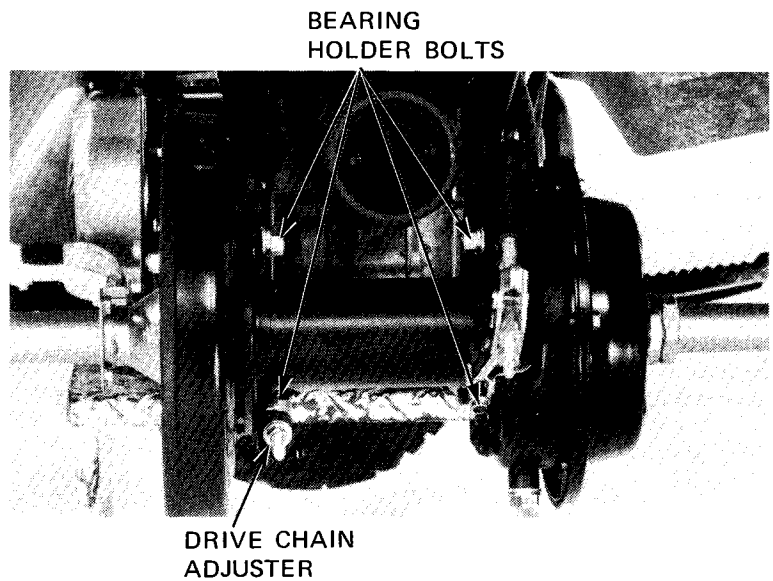

Remove the chain clip, master link and rive chain.

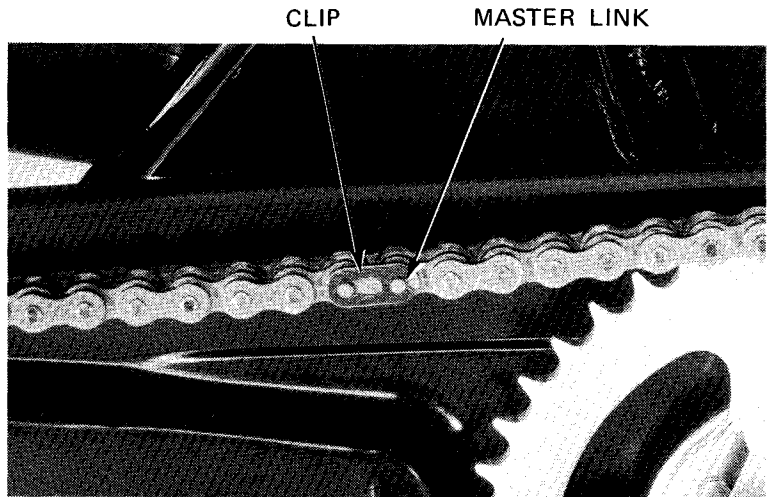

Remove the brake drum nuts by using the special tools (Not available in U.S.A.).

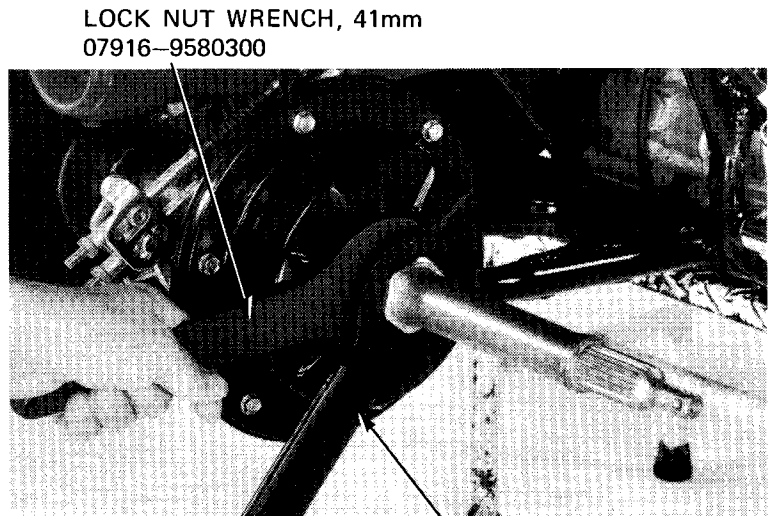

LOCK NUT WRENCH, 41mm
07916-9580300

LOCK NUT SPANNER, 41mm
07916-9580200

Remove the spring washer and O-ring.
Remove the axle.

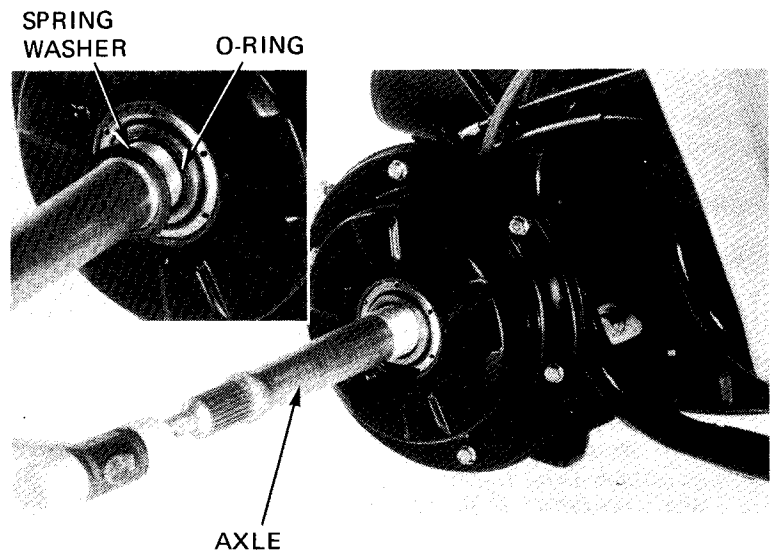

REAR WHEEL/BRAKE/DRIVE MECHANISM

FINAL DRIVEN FLANGE DISASSEMBLY

Remove the driven flange nuts.
Remove the sprocket hub.

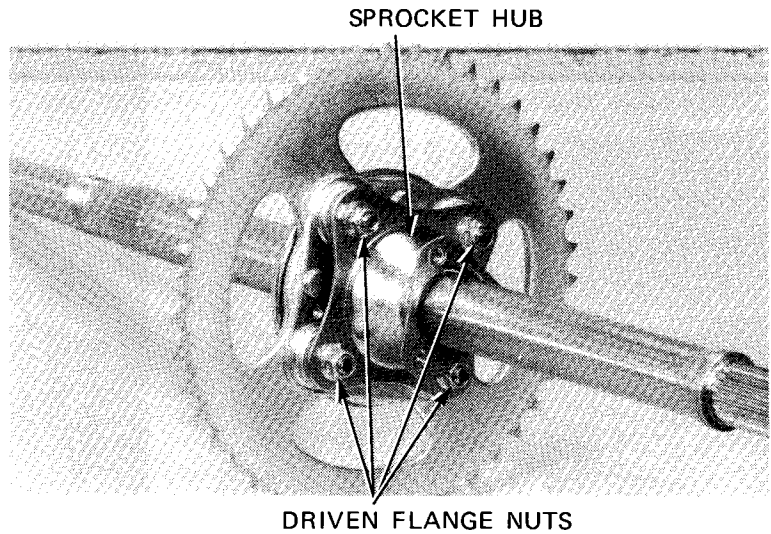

Remove the snap ring and washer.
Remove the final driven sprocket with the hub by tapping it with a plastic hammer from the inside.

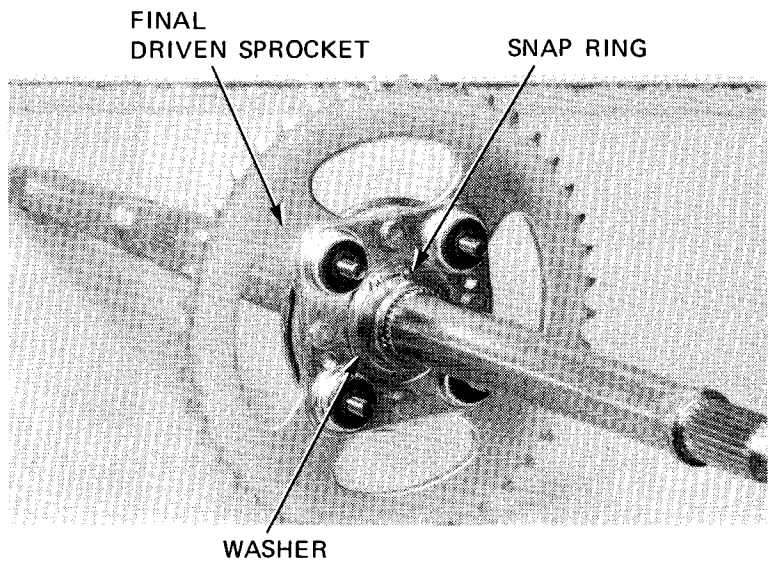

FINAL DRIVEN SPROCKET INSPECTION

Check the rubber bushings for damage. Replace the sprocket if necessary.

Check the condition of the final driven sprocket teeth.

Replace the sprocket if it is worn or damaged.

NOTE

- If the driven sprocket is worn or damaged, the drive chain and the drive sprocket must be inspected.
- Never install a new drive chain on worn sprocket or a worn chain on new sprockets. Both chain and sprockets must be in good condition or the replacement chain or sprockets will wear rapidly.

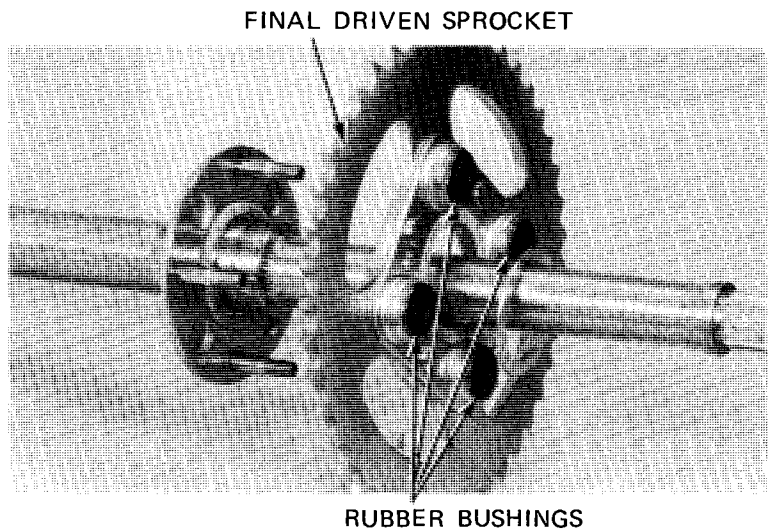

AXLE INSPECTION

Place the rear axle in V-blocks and measure the runout.

The actual runout is 1/2 of the total indicator reading.

SERVICE LIMIT: 3.0 mm (0.12 in)

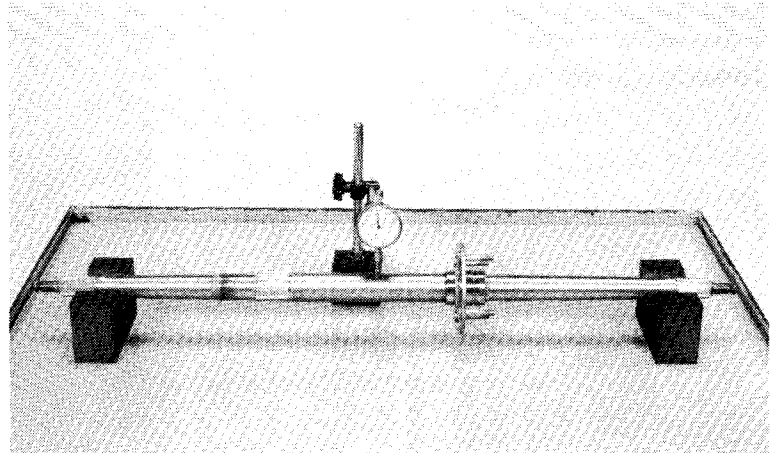

FINAL DRIVEN FLANGE ASSEMBLY

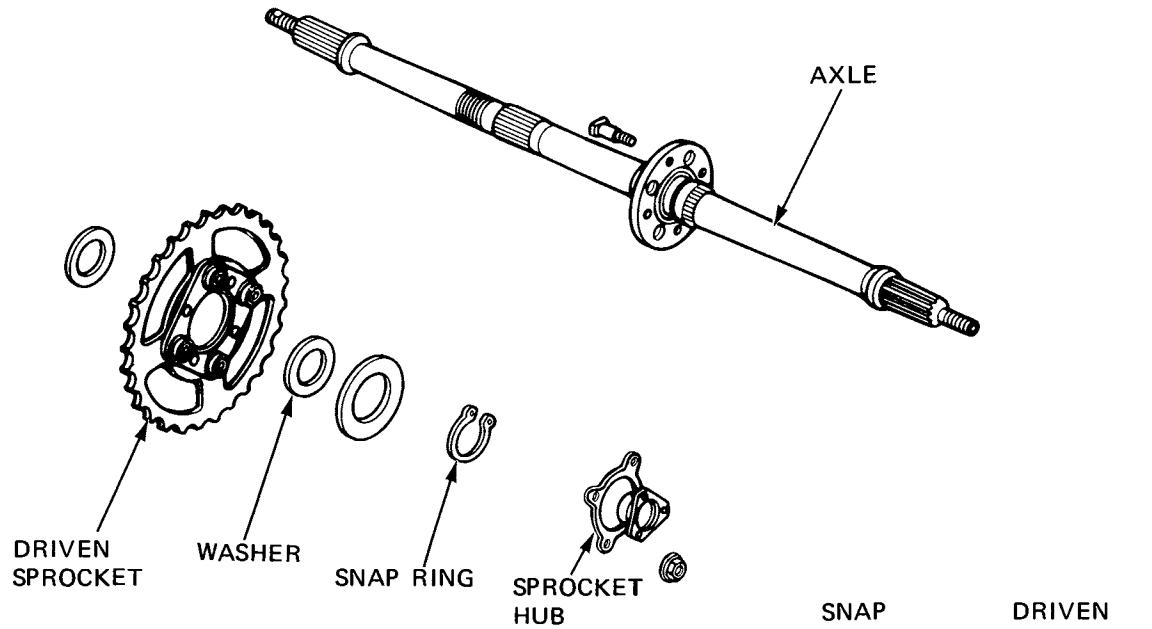

Install the final driven sprocket with the hub.
Install the washer and snap ring.

CAUTION:

Install the snap ring with the chamfered side toward the sprocket.

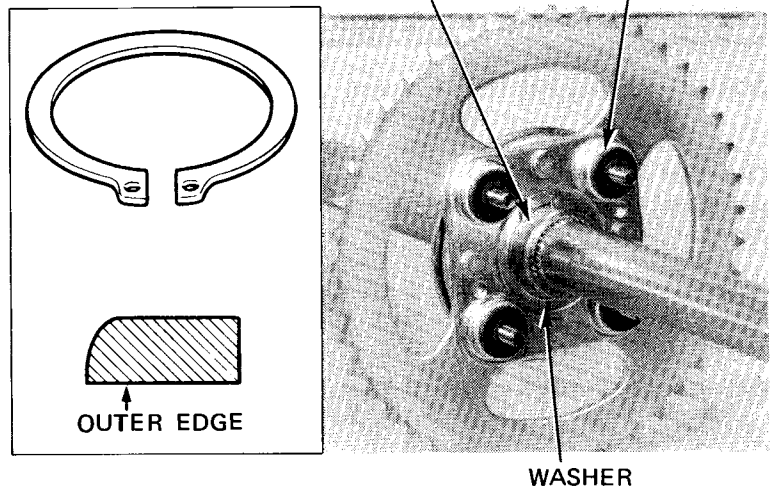

REAR WHEEL/BRAKE/DRIVE MECHANISM

Install the sprocket hub and tighten the nuts to the specified torque.

TORQUE: 25-30N·m (2.5-3.0 kg-m, 18-22 ft-lb)

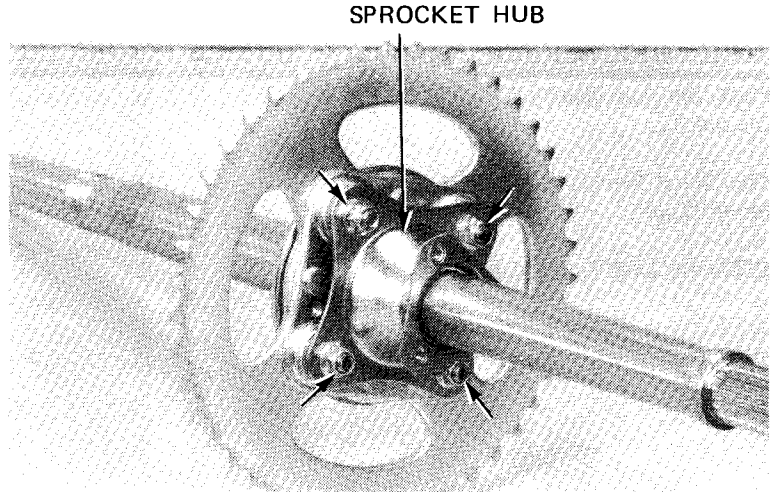

REAR AXLE INSTALLATION

Coat the O-rings with grease.
Install the O-ring onto the axle.
Install the rear axle from the left side.

Install the other O-ring and spring washer onto the axle.

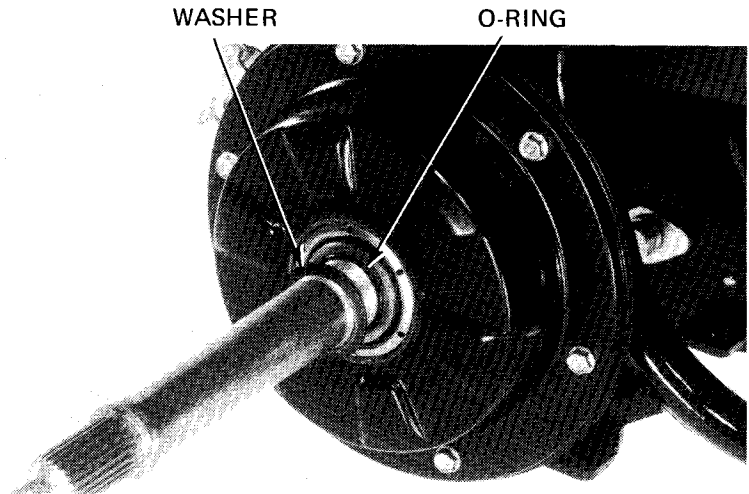

LOCK NUT WRENCH, 41 mm
07916-9580300

Install the axle inner nut and tighten to the specified torque.

TORQUE: 35-45 N·m (3.5-4.5 kg-m, 25-33 ft-lb)

Clean and grease or dirt off the axle threads and apply LOCKTILE® or equivalent to the threads.

Hold the inner nut with a 41 mm wrench and tighten the outer nut, also with a 41 mm wrench.

TORQUE: 120-140 N·m (12-14 kg-m, 87-101 ft-lb)

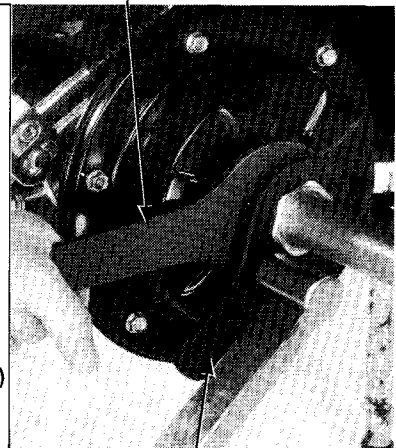
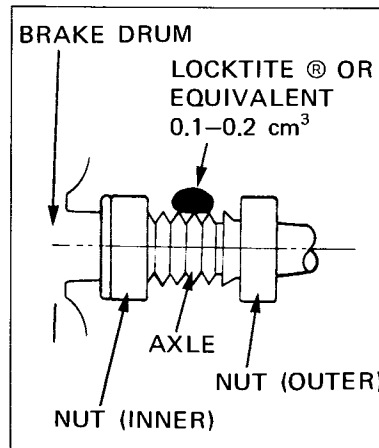

LOCK NUT SPANNER, 41 mm
07916-9580200

REAR WHEEL/BRAKE/DRIVE MECHANISM

Install and connect the drive chain with the master link.

Install the master link clip in the direction shown.

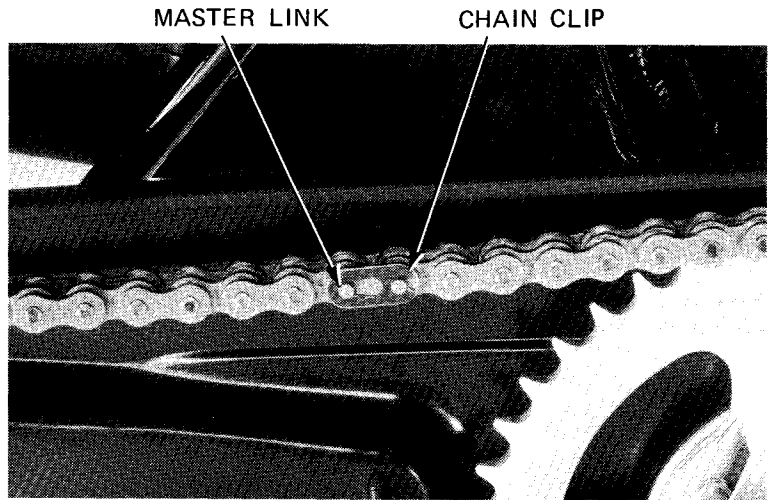

Adjust the drive chain (Page 3-10).
Tighten the bearing holder attaching bolts.

**TORQUE: 50–70 N·m (5.0–7.0 kg·m,
36–51 ft·lb)**

Install the chain cover rubber seal and chain cover.

Install the skid plate.

Coat the axle with grease.

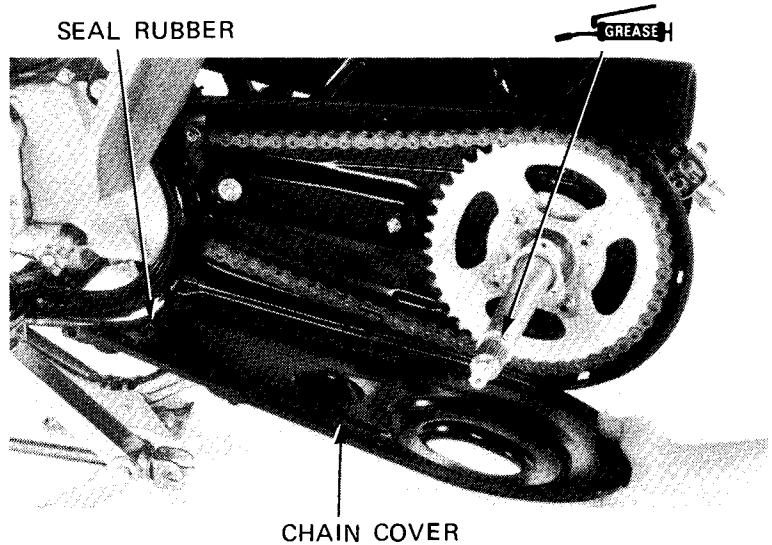

Install the wheel hubs.
Install the lock washer with the word "OUT-SIDE" facing out.

Install and tighten the rear axle nuts.

**TORQUE: 70–110 N·m (7.0–11.0 kg·m,
51–80 ft·lb)**

Install the new cotter pins and bend the ends.
Install the rear wheel (Page 12-3) and adjust the rear brake (Page 3-15).

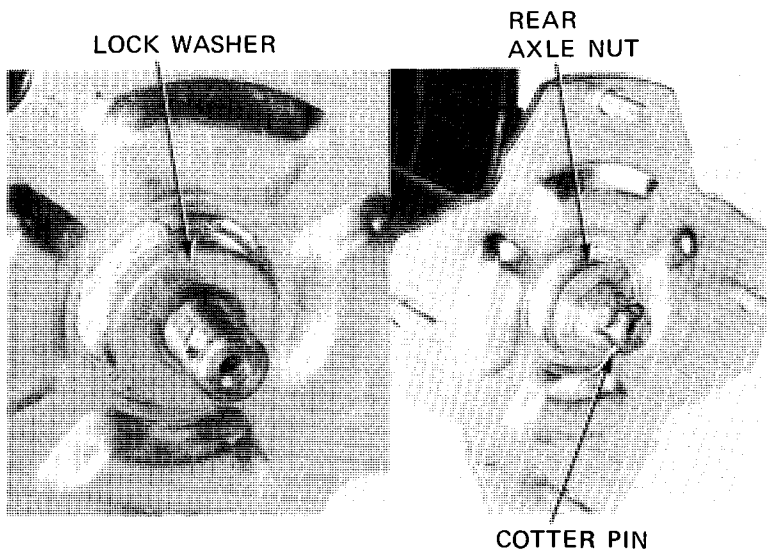

REAR BRAKE

BRAKE DRUM COVER/DRUM REMOVAL

Place a support block under the engine to raise the rear wheel off the ground.
Remove the right rear wheel and hub (Page 12-3).

Remove the drum cover bolts.
Remove the drum cover and brake drum.

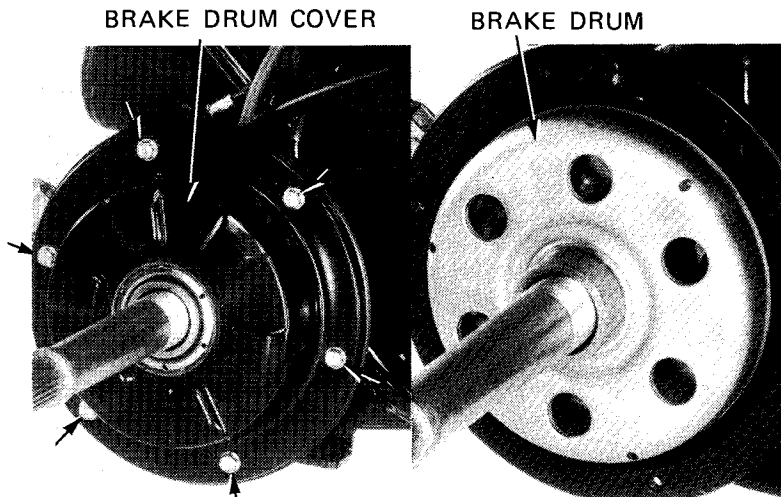

BRAKE DRUM COVER INSPECTION

Remove the dust seal.
Check the brake drum cover gasket and dust seal for damage and replace if necessary.



BRAKE DRUM COVER ASSEMBLY

Lubricate the inside of the dust seal with grease.
Drive the dust seal squarely into the brake drum cover.

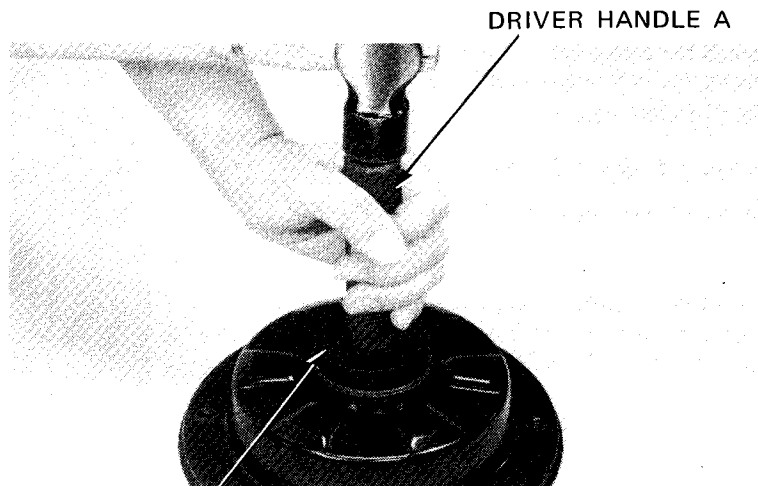

DRIVER OUTER, 62 x 68 mm
07746-0010500

BRAKE LINING INSPECTION

Measure the brake lining thickness.

SERVICE LIMIT: 2 mm (0.1 in)

Replace the brake shoe if the lining is thinner than the service limit.

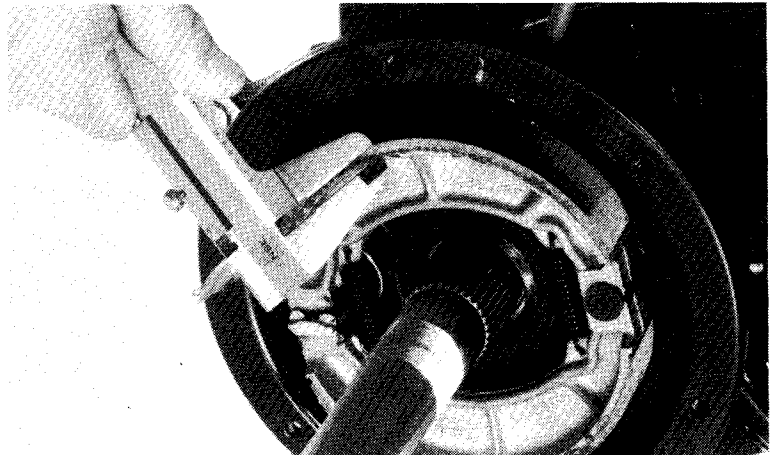

REAR BRAKE DRUM INSPECTION

Measure the brake drum I.D.

SERVICE LIMIT: 141 mm (5.6 in)

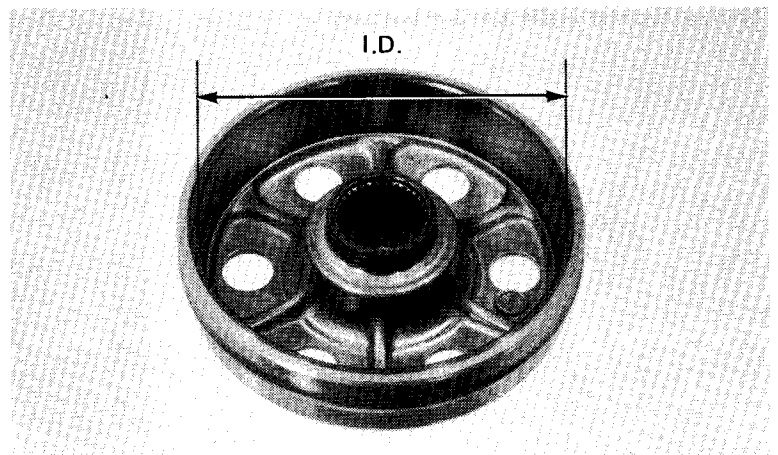

REAR BRAKE DISASSEMBLY

Expand and remove the brake shoes by hand.
Remove the springs from the brake shoes.

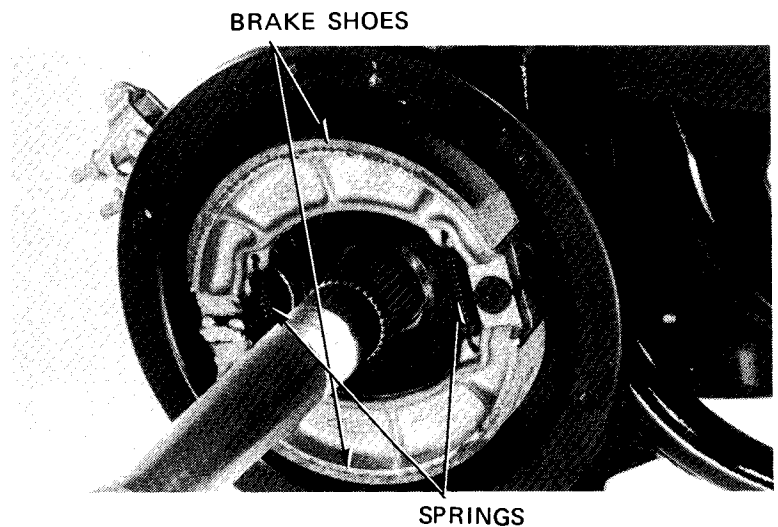

REAR WHEEL/BRAKE/DRIVE MECHANISM

Disconnect the rear brake cables from the rear brake arm.

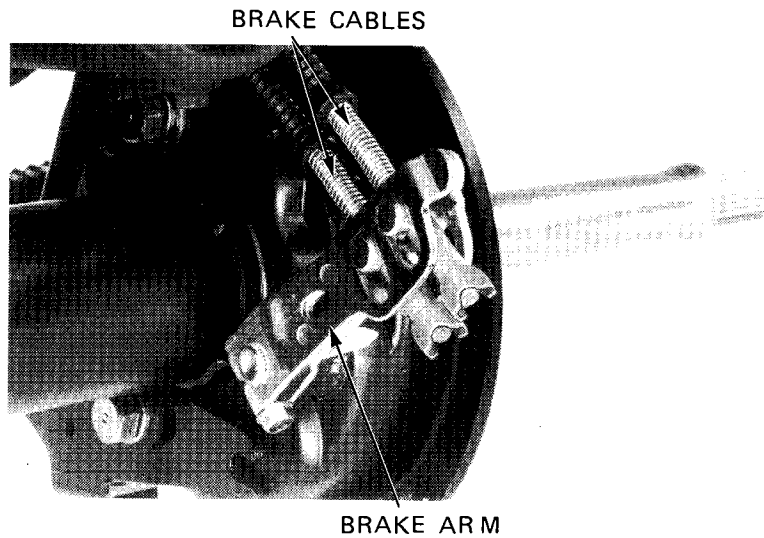

Remove the rear brake arm and indicator.

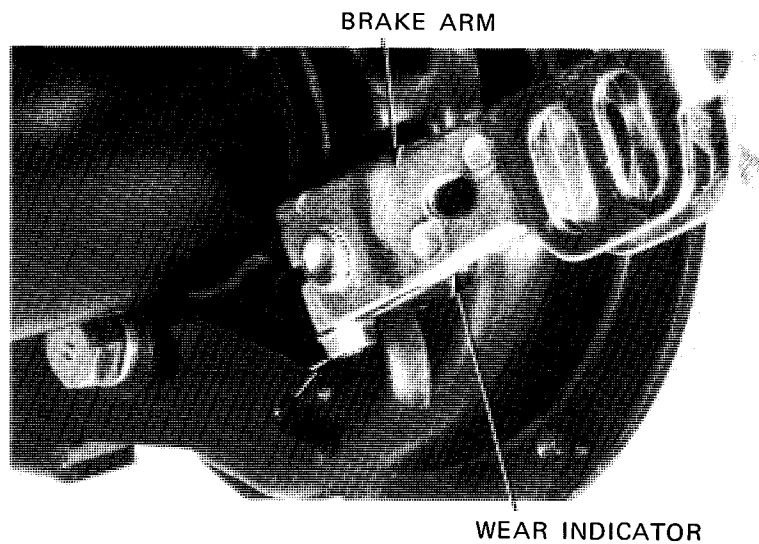

Remove the brake cam and return spring.

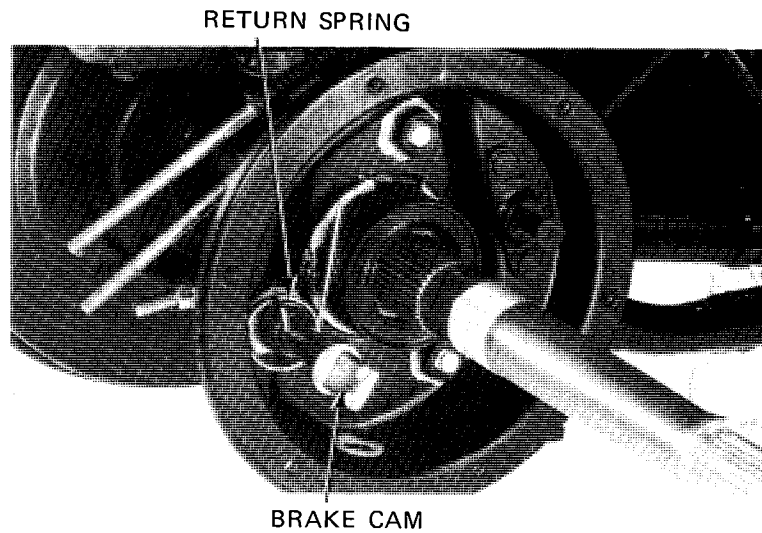

REAR BRAKE ASSEMBLY

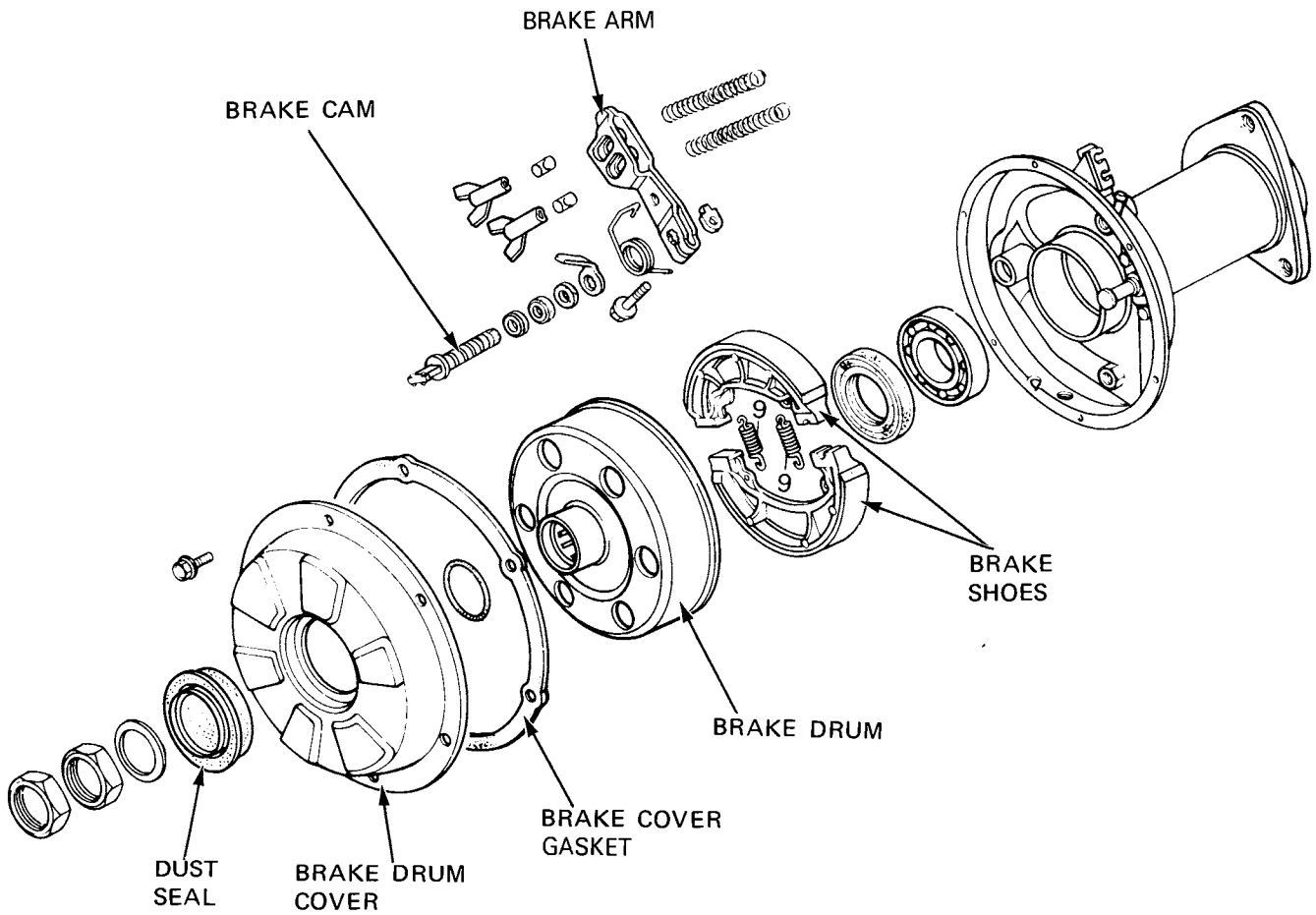

Apply grease to the brake cam shaft.
 Install the dust seals.
 Install the spring aligning the spring end with the cam shaft hole.

Install the wear indicator aligning the cam shaft groove with indicator tab.

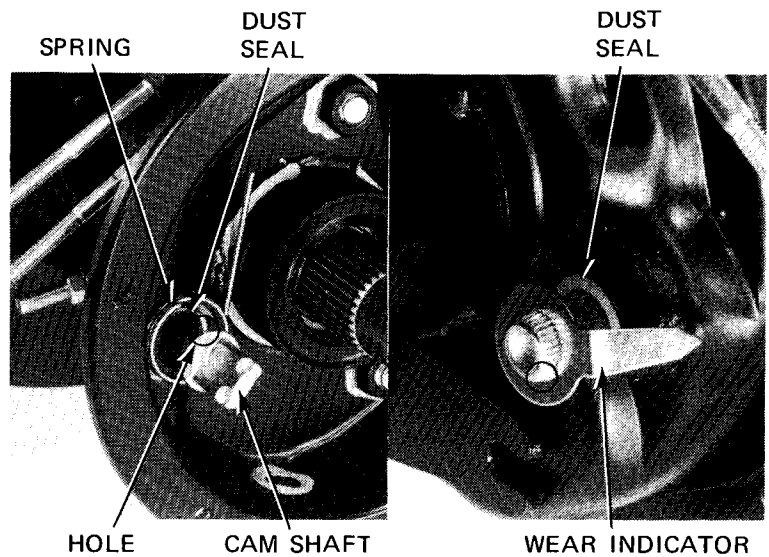

REAR WHEEL/BRAKE/DRIVE MECHANISM

Install the brake arm on the brake cam, aligning the punch marks. Tighten the brake arm bolt.

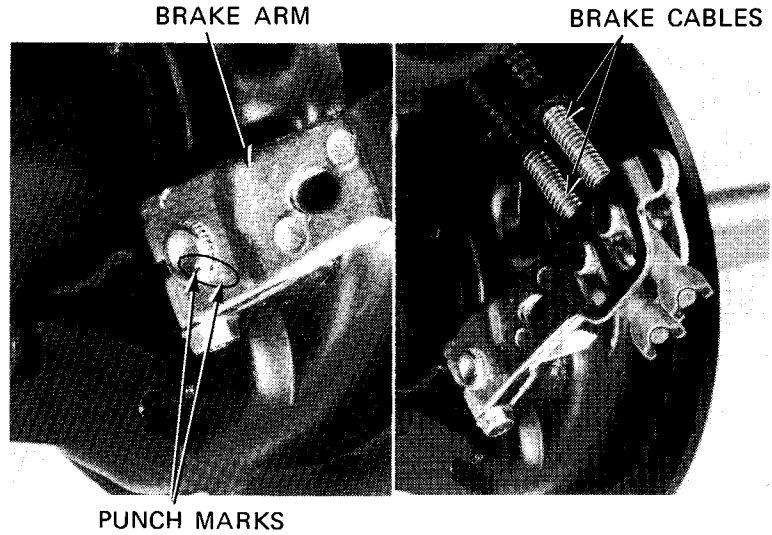

Install the brake shoes on the brake panel.

WARNING

- *Contaminated brake linings reduce stopping power. Keep grease off the linings. Wipe excess grease off the cam.*

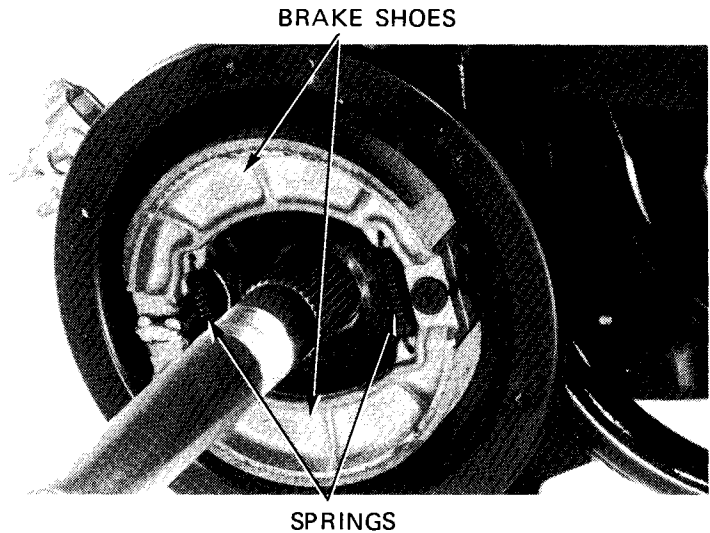

BRAKE DRUM COVER/DRUM INSTALLATION

Install the gasket on the cover and reinstall the cover.

Tighten the bolts in two or more steps in a criss-cross pattern.

TORQUE: 8–12 N·m (0.8–1.2 kg·m, 6–9 ft·lb)

Install the brake drum nuts (Page 12-8).

Install the rear wheel (Page 12-3).

Adjust the rear brake lever free play (Page 3-15).

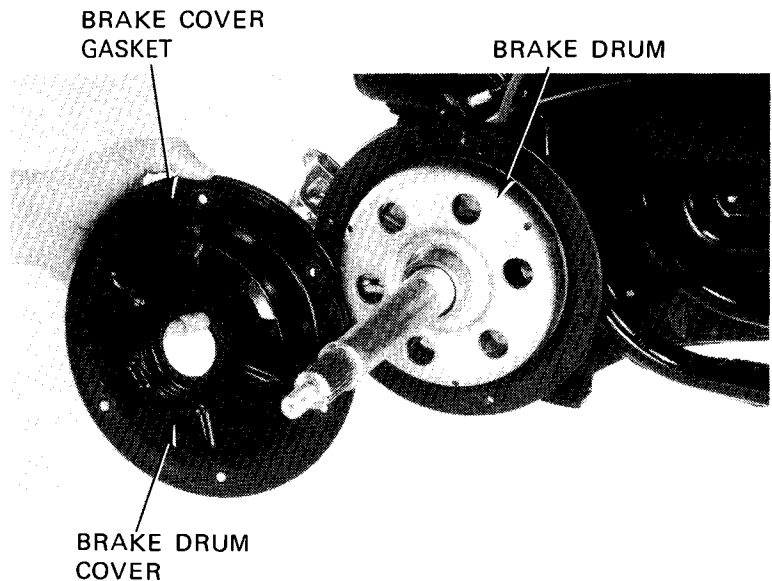

REAR AXLE BEARING HOLDER

REMOVAL

Remove the rear brake (page 12-10).
Remove the rear wheel bearing holder bolts and holder.

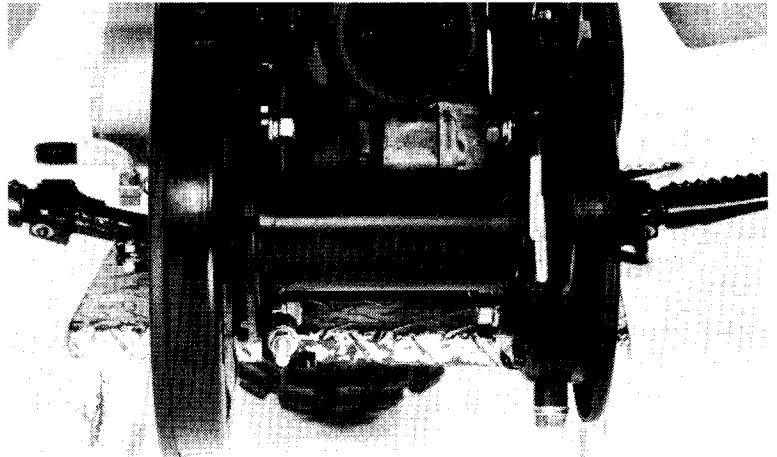

BEARING INSPECTION

Turn the inner race of each bearing with your finger. The bearings should turn smoothly and quietly. Also check that the bearing outer race fits tightly in the hub.

Remove and discard the bearings if the races do not turn smoothly, quietly, or if they fit loosely in the hub.

NOTE:

Replace hub bearings in pairs.

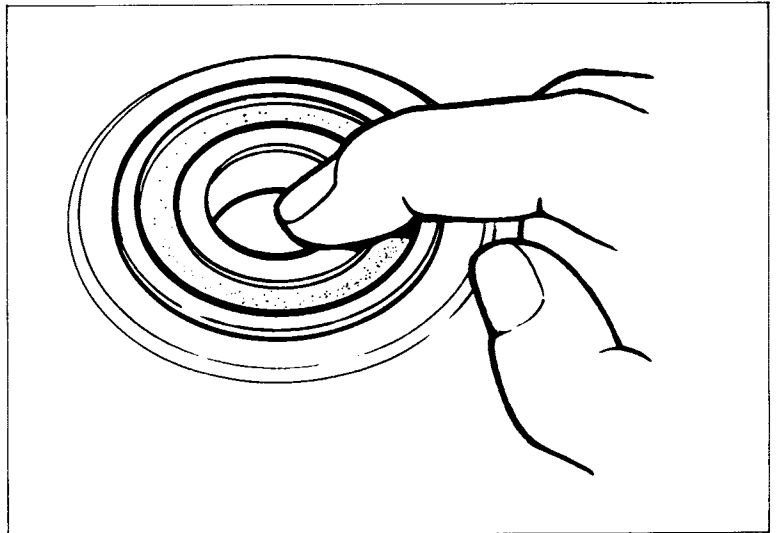

REAR WHEEL BEARING HOLDER DISASSEMBLY

Remove the dust seals and O-rings.
Drive out the bearings and center collar.

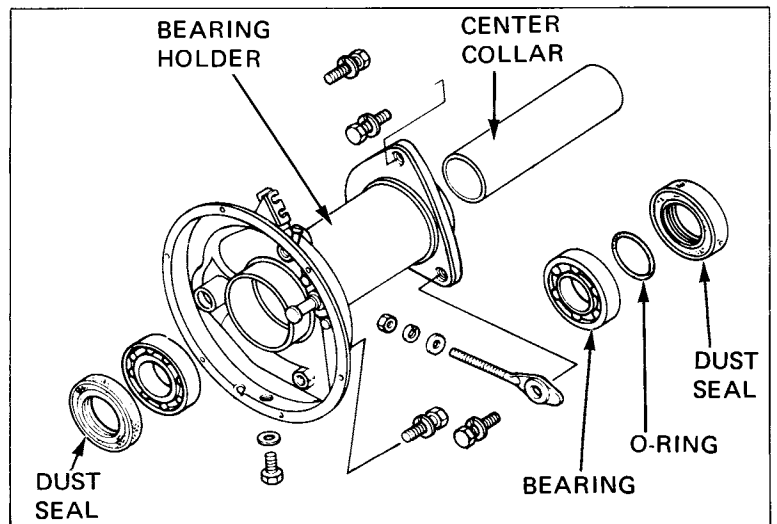

REAR WHEEL/BRAKE/DRIVE MECHANISM

REAR WHEEL BEARING HOLDER ASSEMBLY

Pack the bearing cavities with grease.
Drive the right bearing squarely into the bearing holder until it seats.
Install the center collar and drive the left bearing in squarely until it seats.

NOTE

Install the bearings with marks facing out.

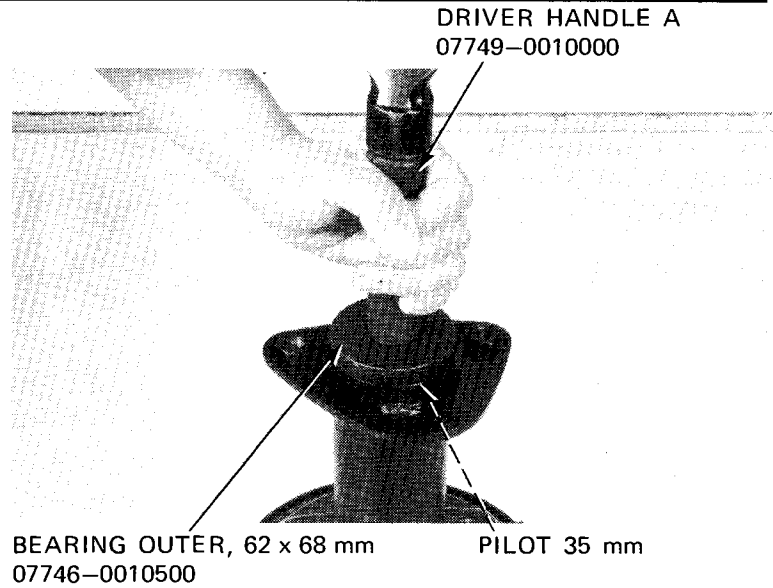

Coat the dust seal lips with grease and drive the dust seals into the bearing holder.

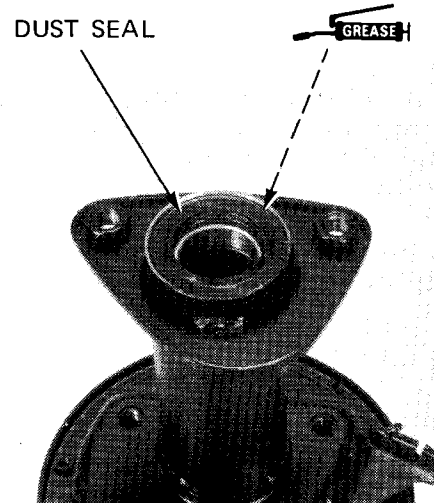

REAR WHEEL BEARING HOLDER INSTALLATION

Install the rear bearing holder and drive chain adjuster.

Install the axle (Page 12-8).
Install the rear brake (Page 12-14).
Tighten the bearing holder bolts after adjust the drive chain.

**TORQUE: 50-70 N-m (5.0-7.0 kg-m,
36-51 ft-lb)**

Install the rear wheel (page 12-3).

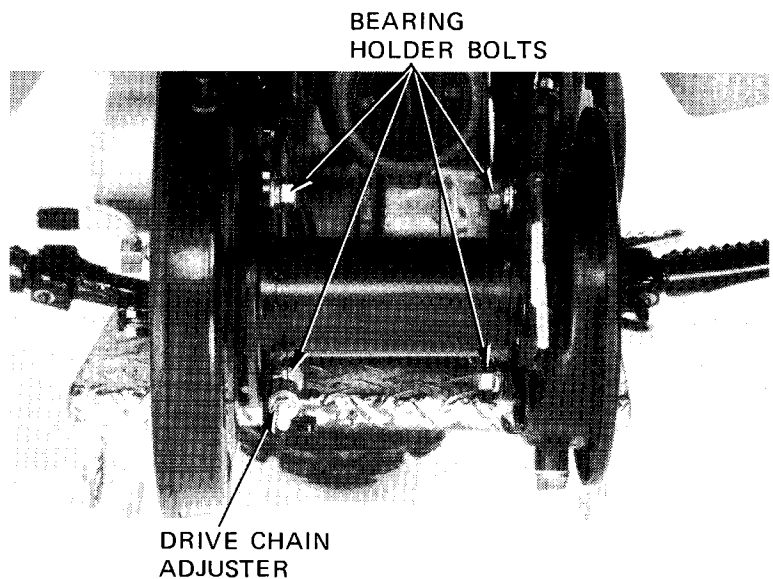

DRIVE CHAIN CASE

REMOVAL/INSTALLATION

Raise the rear wheels off the ground with a jack or block under the engine.

Remove the following parts:

- rear wheel.
- drive chain.
- axle.

Remove the chain slider.

Remove the chain case mount nuts and bolts.

Remove the chain case.

Install the chain case in the reverse order of removal.

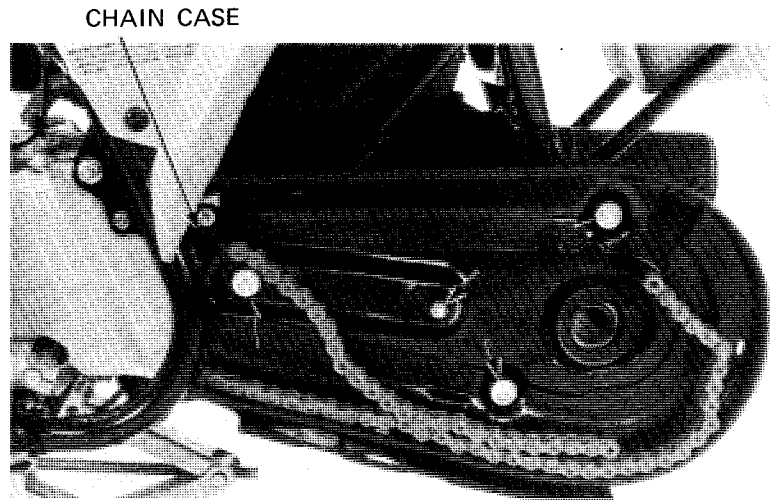

13. REAR FENDER EXHAUST SYSTEM

REAR FENDER
EXHAUST SYSTEM

13-1

13-2

REAR FENDER

REMOVAL

Remove the seat.
Remove the rear fender.

Remove the screws and mud guards.
Remove the rear fender stays.

REAR FENDER INSTALLATION

The installation sequence is the reverse order of removal.

NOTE

Be sure to include the collar with the fender bolts.

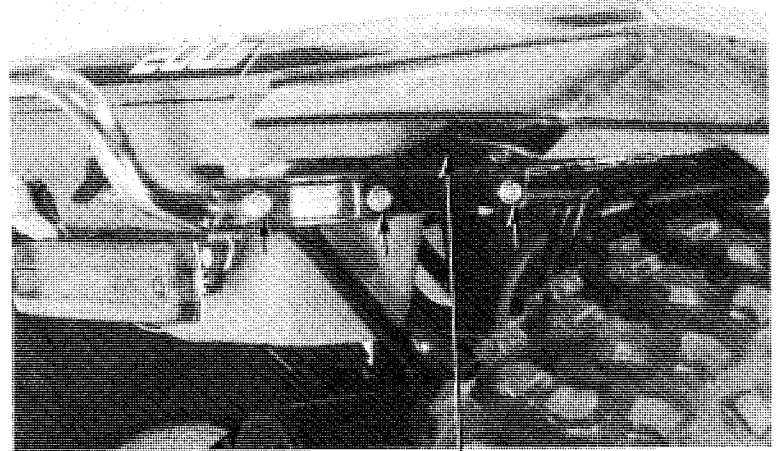
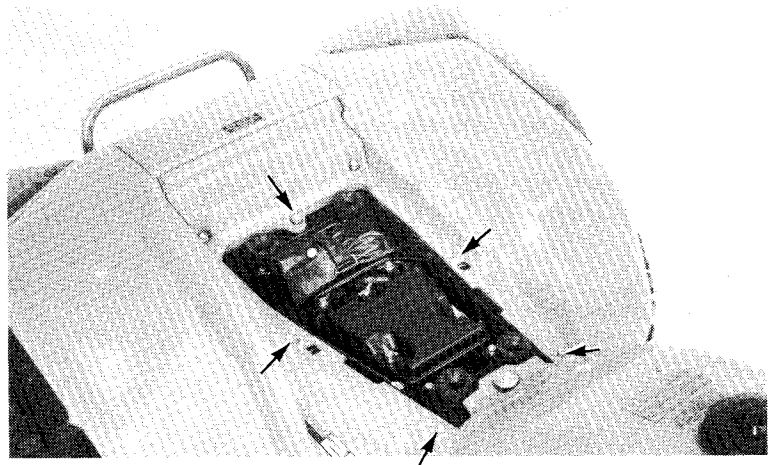

FENDER STAY

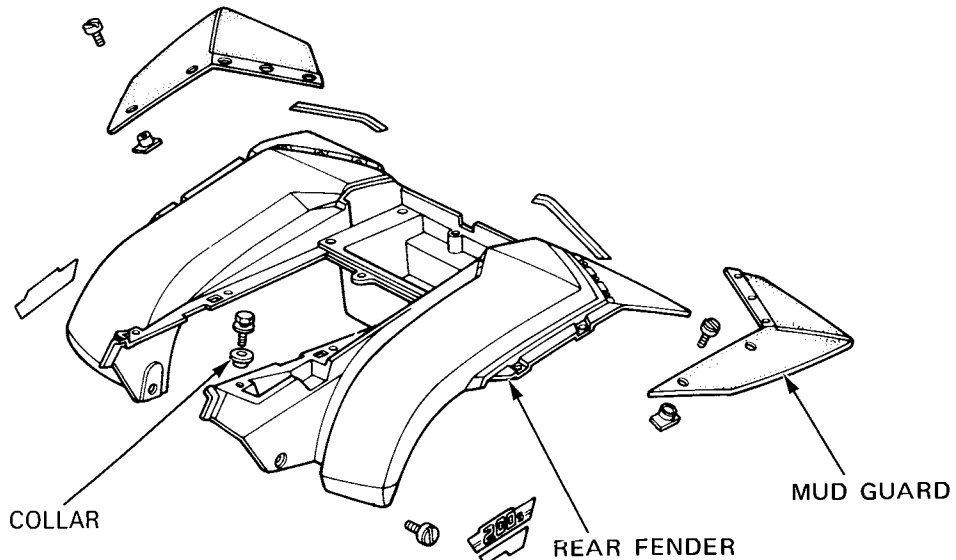

EXHAUST SYSTEM

REMOVAL

WARNING

Do not service the exhaust pipe or muffler while they are hot.

Remove the seat and rear fender.
Remove the exhaust pipe flange nuts.
Loosen the clamp bolt and remove the exhaust pipe.
Remove the two muffler mount bolts and remove the muffler.

NOTE:

Check the gasket and pipe seal for wear.
Replace with a new one if necessary.

EXHAUST PIPE

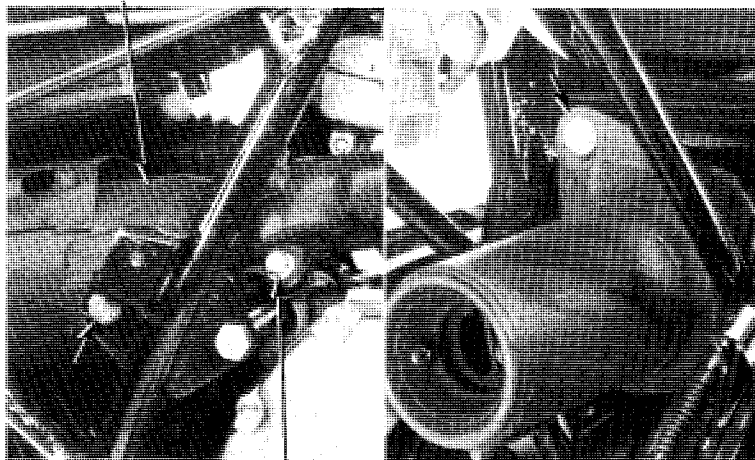

CLAMP
BOLT

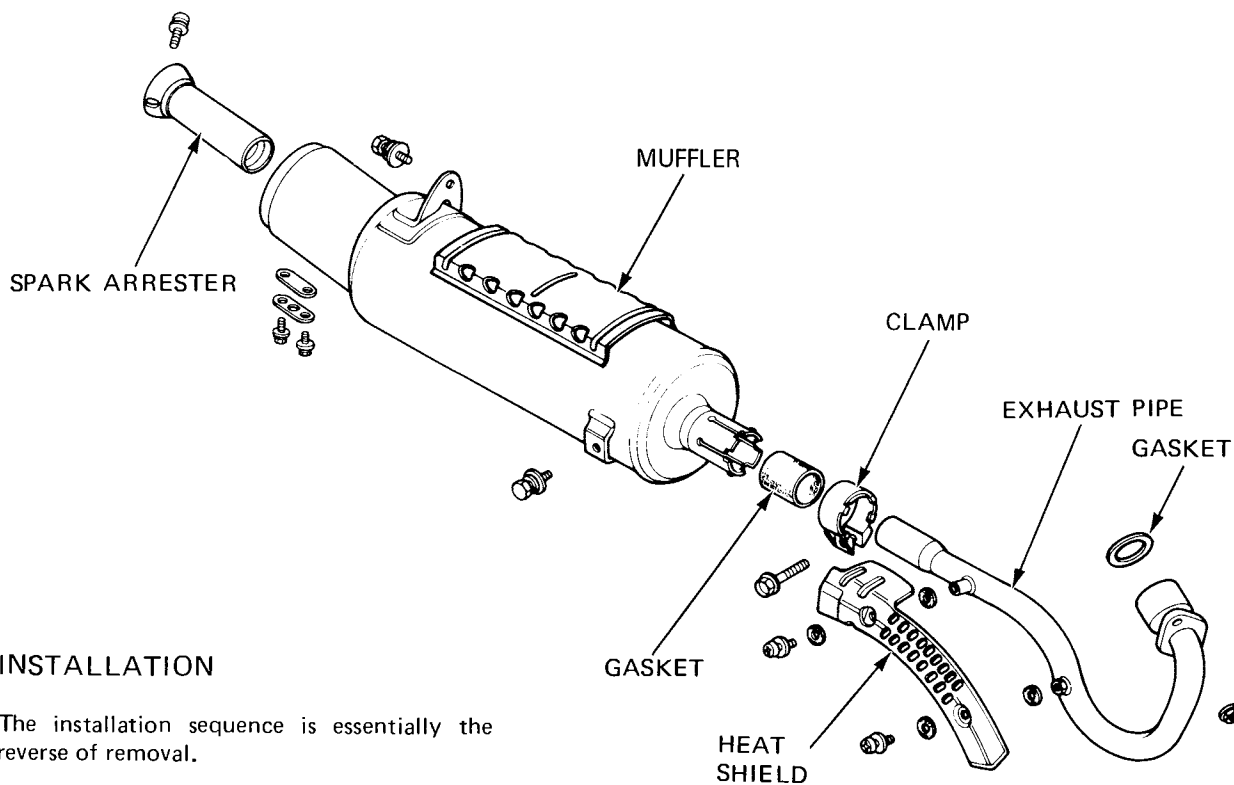

INSTALLATION

The installation sequence is essentially the reverse of removal.

NOTE:

- Tighten the exhaust pipe flange nuts first, then tighten the other bolts.
- Align the tab of the clamp with the groove of the muffler.
- After installing, make sure that there are no exhaust leaks.



IGNITION SYSTEM

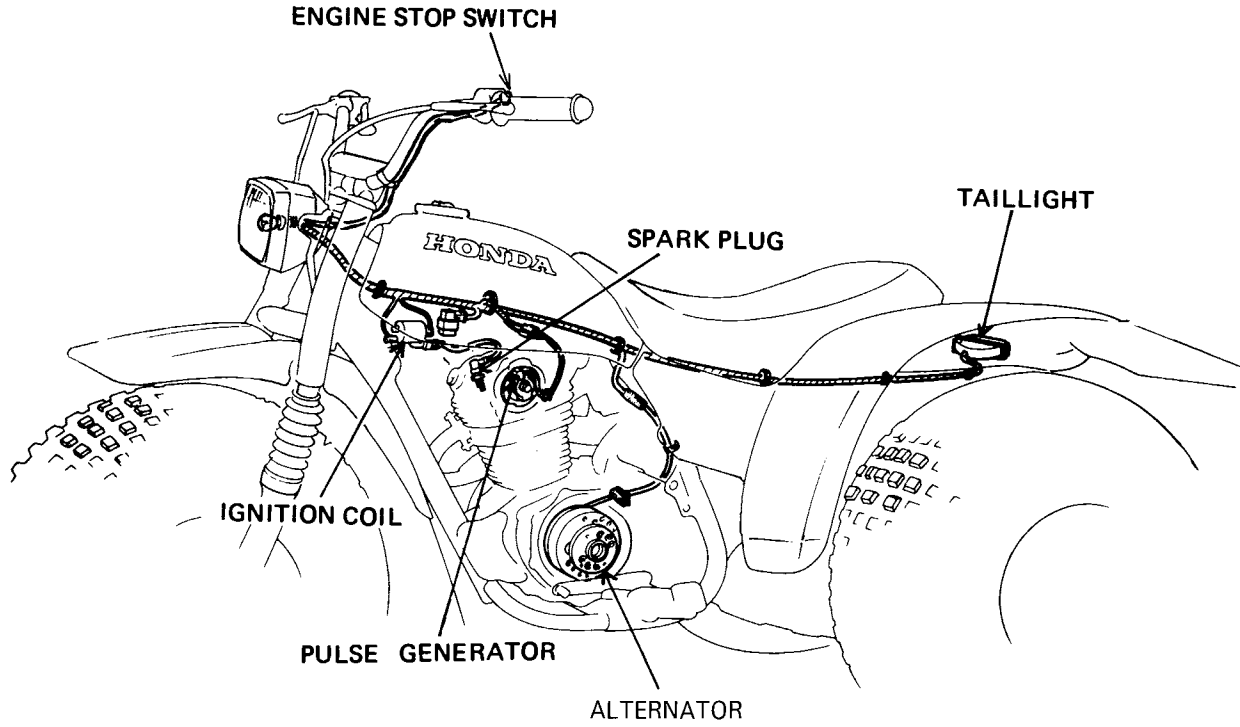

'84 :

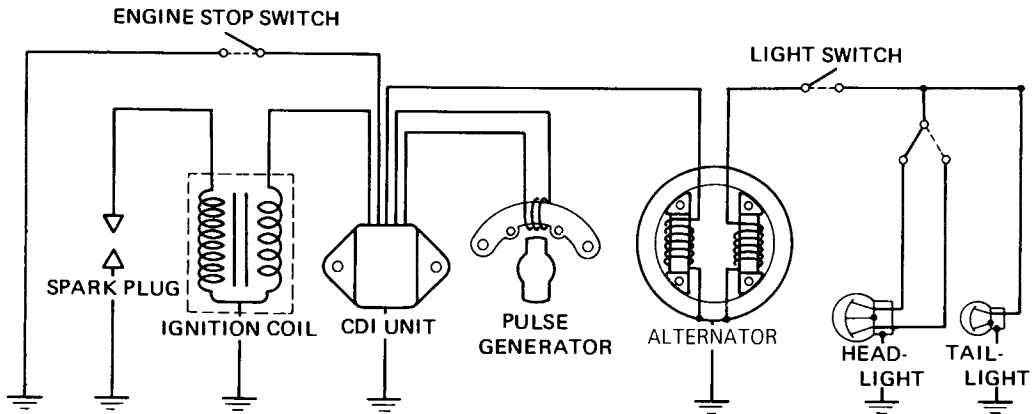

After '84 :

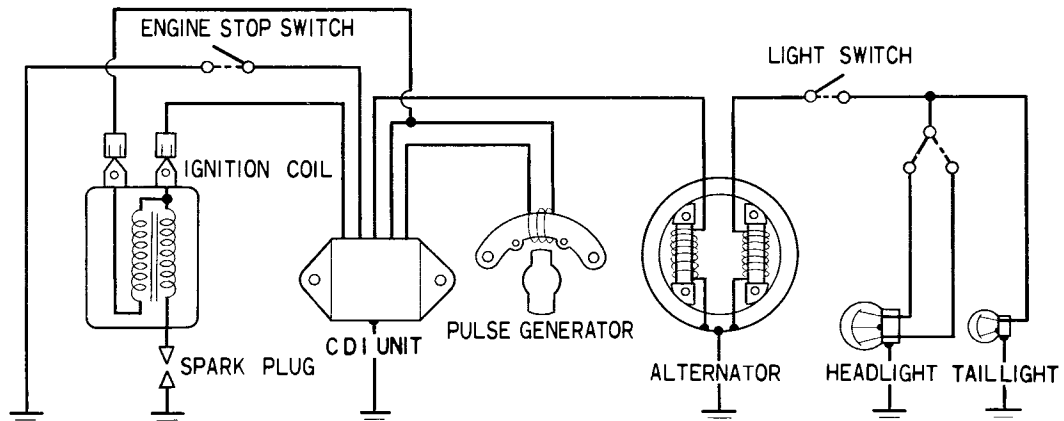

14. IGNITION SYSTEM

| | |
|---------------------|------|
| SERVICE INFORMATION | 14-1 |
| TROUBLESHOOTING | 14-2 |
| IGNITION COIL | 14-3 |
| ALTERNATOR | 14-3 |
| CDI UNIT | 14-4 |
| PULSE GENERATOR | 14-5 |
| IGNITION TIMING | 14-5 |

SERVICE INFORMATION

GENERAL

- Ignition timing does not normally need to be adjusted since the CDI (Capacitive Discharge Ignition) unit is factory pre-set.
- For spark plug inspection, refer to page 3-5.
- For pulse generator removal, see page 6-3.
- All plastic connectors have locking tabs that must be released before disconnecting, and must be aligned when reconnecting.
- To isolate an electrical failure, check the continuity of the electrical path through the part. A continuity check can usually be made without removing the part from the motorcycle—by simply disconnecting the wires and connecting a continuity tester or voltmeter to the terminals or connections.

SPECIFICATIONS

| | |
|------------------|--|
| Spark plug | (NGK) DR8ES-L (ND) X24ESR-U |
| Spark plug gap | 0.6–0.7mm (0.024–0.028 in) |
| Ignition timing: | |
| Initial | $10^{\circ} \pm 2^{\circ}$ BTDC/1,400 \pm 100rpm |
| Advance start | 1,950 \pm 150rpm |
| Full advance | $30^{\circ} \pm 2^{\circ}$ BTDC/3,350 \pm 150rpm |
| Alternator | 50W/5,000rpm |

TOOL

| | |
|----------------------|-----------------------------|
| Digital multi-tester | KS-AHM-32-003 (U.S.A. only) |
|----------------------|-----------------------------|

TROUBLESHOOTING

Engine starts but stops

1. No spark at plug.
2. Improper ignition timing.
3. Faulty spark plug.

No spark at plug

1. Engine stop switch "OFF".
2. Poorly connected, broken or shorted wires.
 - Between alternator and CDI unit.
 - Between CDI unit and engine stop switch.
 - Between CDI unit and ignition coil.
 - Between ignition coil and spark plug.
 - Between pulse generator and CDI unit.
3. Faulty ignition coil.
4. Faulty CDI unit.
5. Faulty pulse generator.
6. Faulty alternator.
7. Improper pulse generator coil air gap.

Engine starts but runs poorly

1. Ignition primary circuit.
 - Faulty ignition coil.
 - Loose or bare wire.
 - Faulty alternator.
 - Faulty CDI unit.
 - Faulty pulse generator.
2. Ignition secondary circuit.
 - Faulty plug.
 - Faulty spark plug wire.
 - Faulty ignition coil.
3. Improper ignition timing.
 - Faulty advancer rotor.
 - Faulty pulse generator.
 - Faulty CDI unit.

Hard starting

1. Improper pulse generator coil air gap.

IGNITION COIL

REMOVAL

Remove the seat and fuel tank.
 Disconnect the wire leads.
 Remove the spark plug cap from the spark plug.

'84 :

Remove the ignition coil by removing the mounting bolts.

After '84 :

Remove the ignition coil by pulling ignition coil.

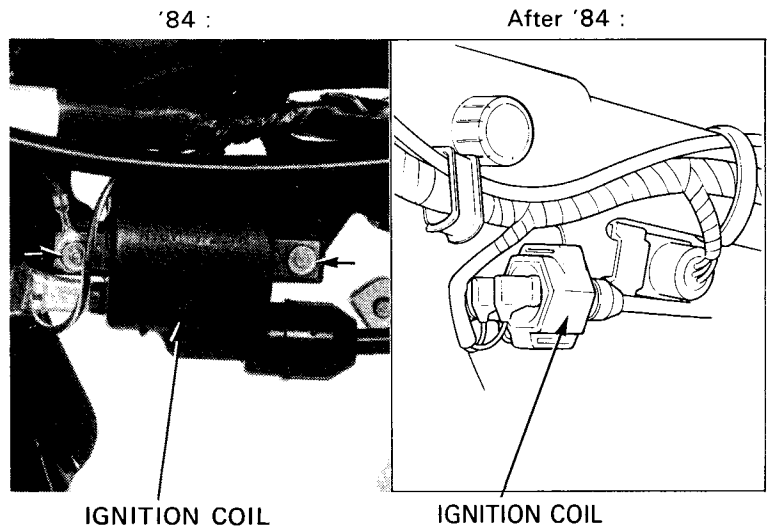

INSPECTION

Check the resistances between the leads of the primary and secondary coils:

| | | |
|------------------------|-------------|--------------------|
| Primary coil: | '84 : | 0.2—0.4 Ω |
| | After '84 : | 0.16—0.20 Ω |
| Secondary coil: | '84 : | 3—5 k Ω |
| | After '84 : | 3.6—4.6 k Ω |

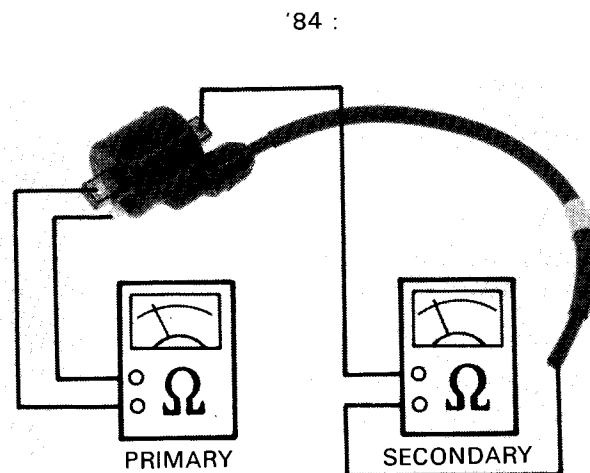

INSTALLATION

Install the ignition coil in the reverse order of removal.

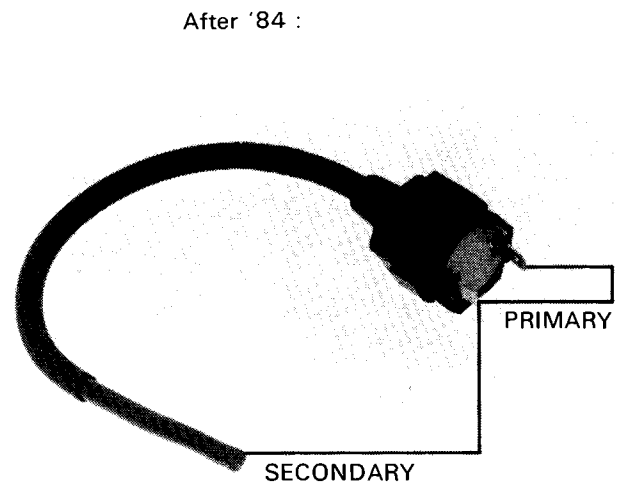

IGNITION SYSTEM

ALTERNATOR

Disconnect the alternator wire connector and coupler and test as follows:

NOTE:

It is not necessary to remove the stator coil to make this test.

LIGHTING COIL

The lamp coil is correct if there is continuity between the yellow wire and body ground.

EXCITER COIL

The exciter coil is normal if there is continuity between the black wire and body ground.

RESISTANCE: 150—400Ω

CDI UNIT

REMOVAL

Remove the seat and fuel tank.
Disconnect the coupler.
Remove the CDI unit from the mounting rubber.

INSPECTION

Replace the CDI unit if the readings are not within the limits shown in the table.

NOTE:

For accurate testing, use only a Sanwa Electric Tester (P/N 07308-0020000) or a Kowa Digital Multi-Tester (KS-AHM-32-003 : U.S.A. only). Use of another tester may result in a false reading.

WIRE COUPLER

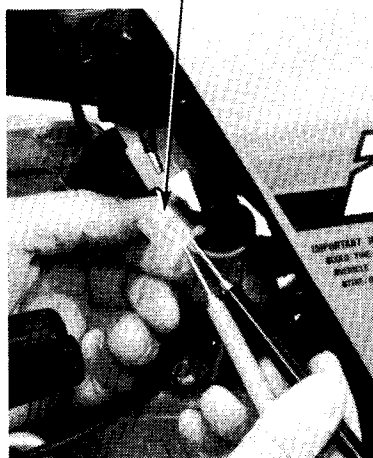

WIRE CONNECTOR

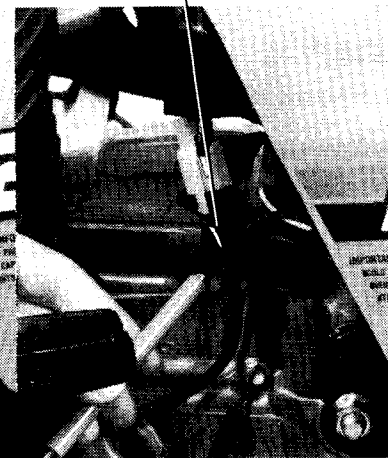

CDI UNIT

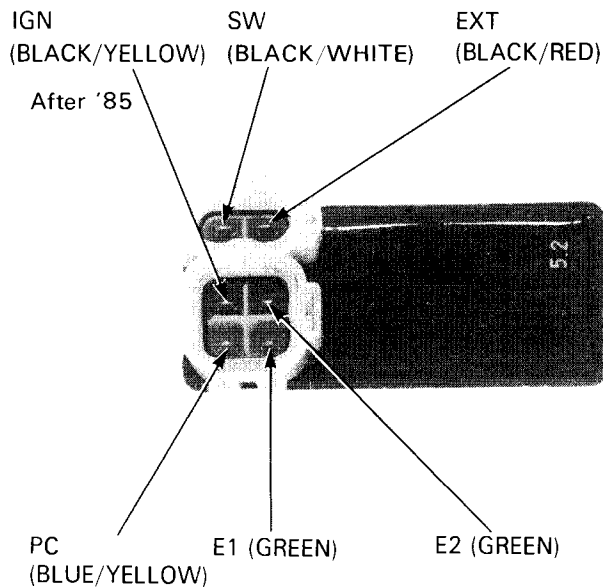
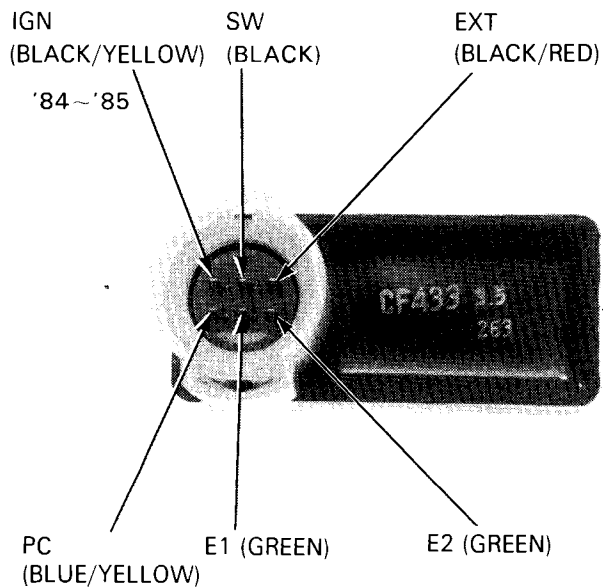

Set the tester on the R x K Ω

Unit : K Ω

| +Probe -Probe | SW (Bk) | EXT (Bk/R) | PC (Bu/Y) | E1 (G) E2 (G) | IGN (Bk/Y) |
|------------------|------------|---------------|--------------|------------------|---------------|
| SW (Bk) | | ∞ | ∞ | ∞ | ∞ |
| EXT (Bk/R) | 0.1-20 | | ∞ | ∞ | ∞ |
| PC (Bu/Y) | 0.5-200 | 0.5-100 | | 1-5 | ∞ |
| E1(G) E2(G) | 0.2-60 | 0.1-2.0 | ∞ | | ∞ |
| IGN (Bk/Y) | ∞ | ∞ | ∞ | ∞ | |

PULSE GENERATOR

NOTE:

This test can be made without removing the pulse generator.

Remove the seat fender and fuel tank.
Disconnect the generator wires.

Measure the resistance between the Blue/
Yellow and Green wires.

RESISTANCE: 20-30 Ω

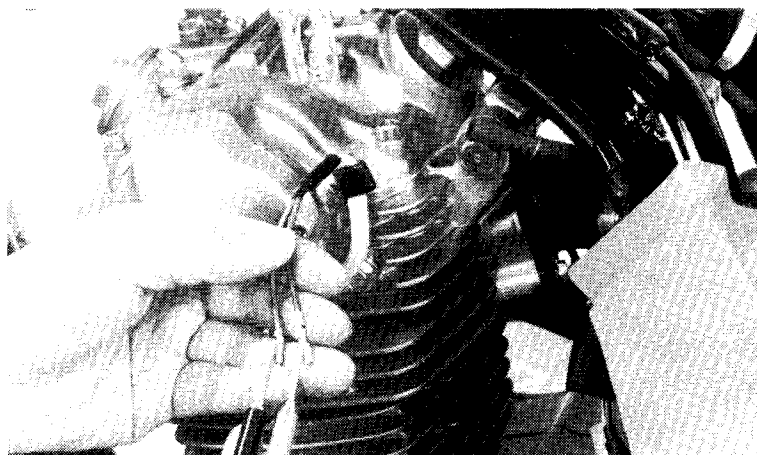

IGNITION TIMING

INSPECTION

Remove the timing hole cap.
Connect a timing light and tachometer.

Start the engine and check the ignition timing:

At 1,300 \pm 100 rpm: The index mark should be aligned with the F mark.

At 1,950 \pm 150 rpm: Timing advance should start.

At 3,350 \pm 150 rpm: Timing advance should cease. The index mark should be between the full advance marks.

ADJUSTMENT

Remove the pulse generator cover.
Loosen the screws attaching the pulse generator base plate and rotate the base plate until the correct ignition timing is obtained.

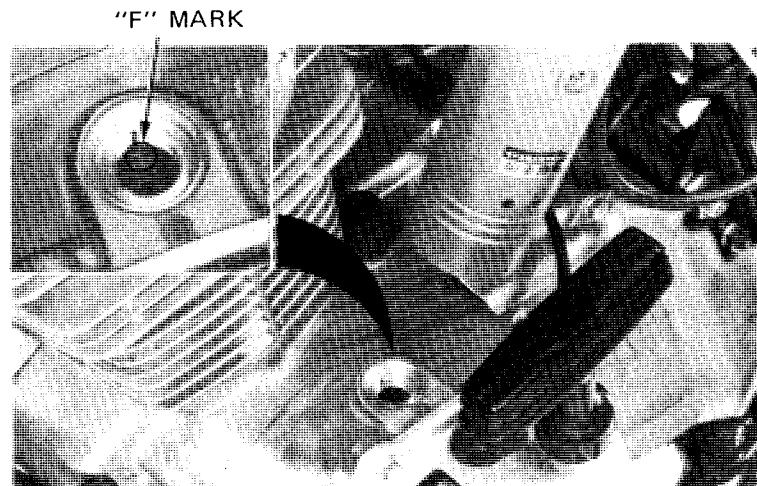

Turn the base plate in direction A to advance the timing.
Turn the base plate in direction B to retard the timing.

Recheck the ignition timing.

Check the pulse generator air gap as described below.

PULSE AIR GAP ADJUSTMENT

Measure the air gap between the pulse generator and rotor.

AIR GAP: 0.3–0.4 mm (0.012–0.016 in)

When adjustment is necessary, loosen the pulse generator coil attaching screws and move the coil to achieve the correct gap.

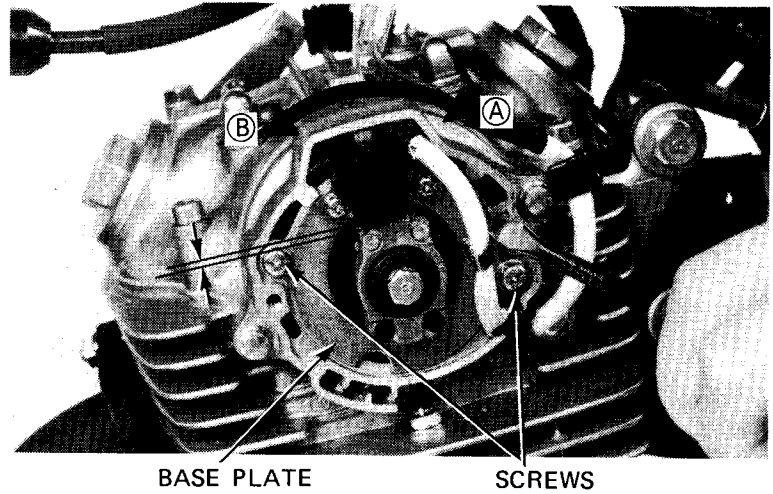

15. LIGHTS/SWITCHES

| | |
|---------------------|------|
| SERVICE INFORMATION | 15-1 |
| TROUBLESHOOTING | 15-1 |
| HEADLIGHT | 15-2 |
| TAILLIGHT | 15-2 |
| HANDLEBAR SWITCH | 15-3 |
| ENGINE STOP SWITCH | 15-3 |

SERVICE INFORMATION

GENERAL

A continuity check can usually be made without removing the part from the ATC by simply disconnecting the wires and connecting a continuity tester or voltmeter to the terminals.

SPECIFICATIONS

| | |
|-----------|-------------|
| Headlight | 12V 45/45 W |
| Taillight | 12V 5W |

TROUBLESHOOTING

Light does not come on when light switch is turned on (Engine is running)

1. Bulb burned out
2. Faulty switch
3. Wiring to that component has an open circuit
4. Faulty lighting coil. (See page 14-3)

Headlight beams do not shift when hi-lo switch is operated

- Faulty dimmer switch

HEADLIGHT

HEADLIGHT DISASSEMBLY/ ASSEMBLY

Refer to Page 11-3 and 11-4 for disassembly
and assembly.

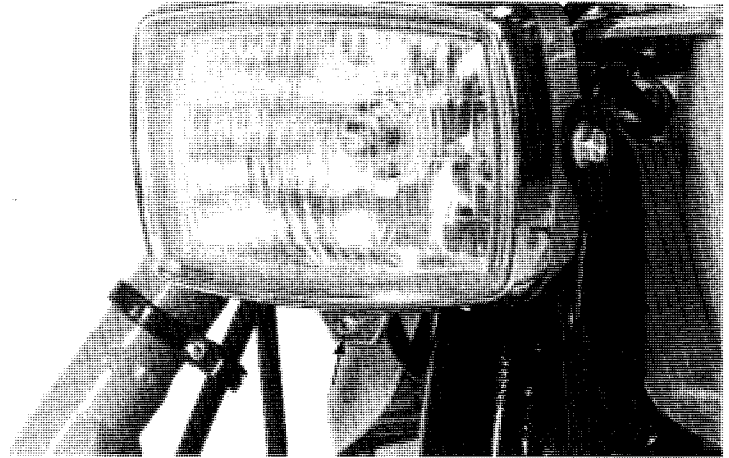

TAILLIGHT

DISASSEMBLY

Remove the two screws and lens.
Remove the bulb.

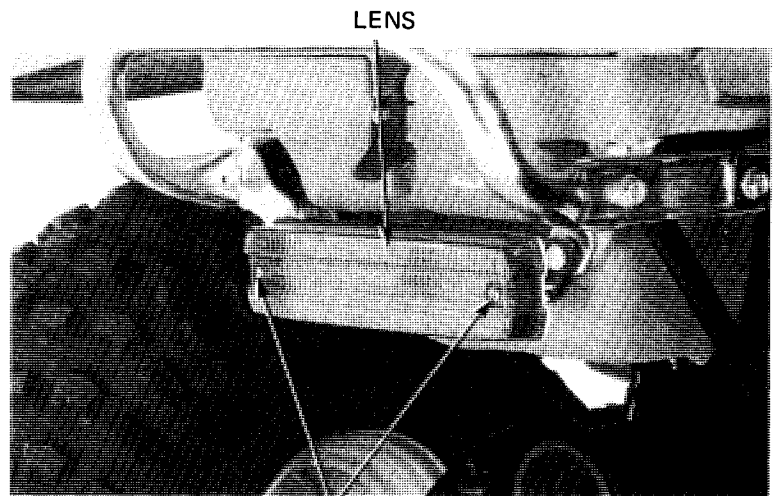

TAILLIGHT ASSEMBLY

Assemble the taillight in the reverse order of
disassembly.

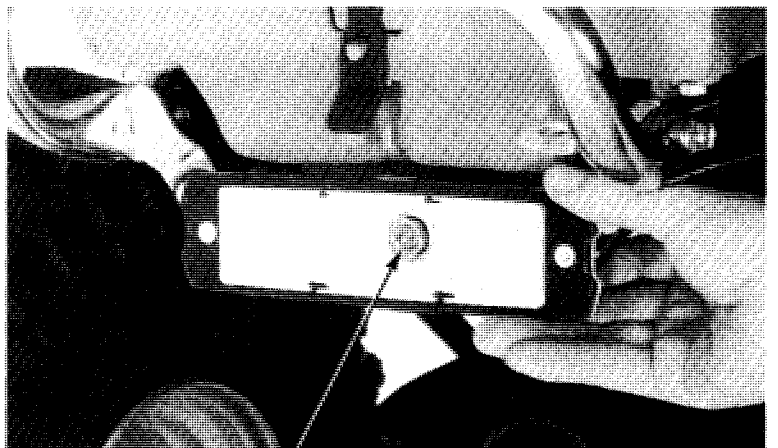

HANDLEBAR SWITCH

Remove the headlight (page 11-3).
 Disconnect the switch coupler and connector.
 Check each switch for continuity between the terminals shown in the table for each switch position.

The switch is normal if there is continuity between the circuit marked "○—○".

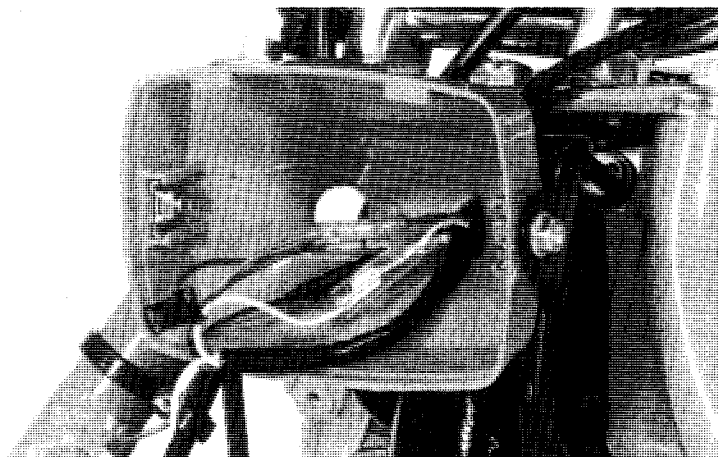

'84 ~ '85 :

LIGHTING SWITCH

| | WHITE | YELLOW | BROWN | BLUE |
|------|-------|--------|-------|------|
| OFF | | | | |
| LOW | ○—○ | ○—○ | ○—○ | |
| HIGH | | ○—○ | ○—○ | ○—○ |

After '85 :

| | WHITE | YELLOW | BROWN | BLUE |
|------|-------|--------|-------|------|
| OFF | | | | |
| LOW | ○—○ | ○—○ | ○—○ | |
| (N) | ○—○ | ○—○ | ○—○ | ○—○ |
| HIGH | | ○—○ | ○—○ | ○—○ |

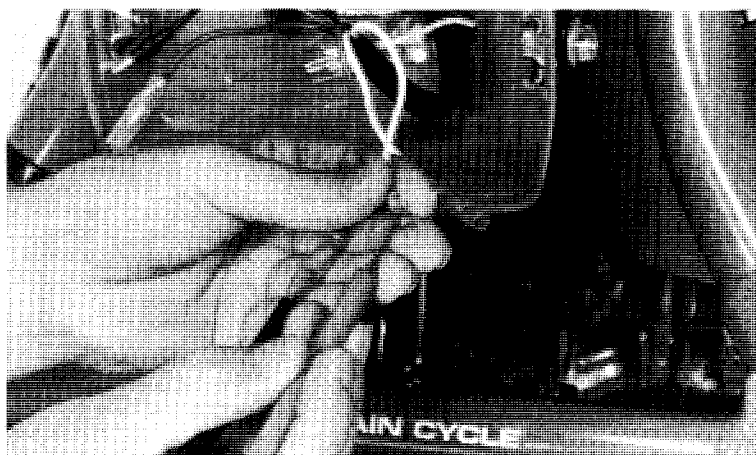

'84 :

ENGINE STOP SWITCH

| | BLACK | GREEN |
|-----|-------|-------|
| OFF | ○—○ | ○—○ |
| RUN | | |

After '84 :

| | BLACK WHITE | GREEN |
|-----|-------------|-------|
| OFF | ○—○ | ○—○ |
| RUN | | |

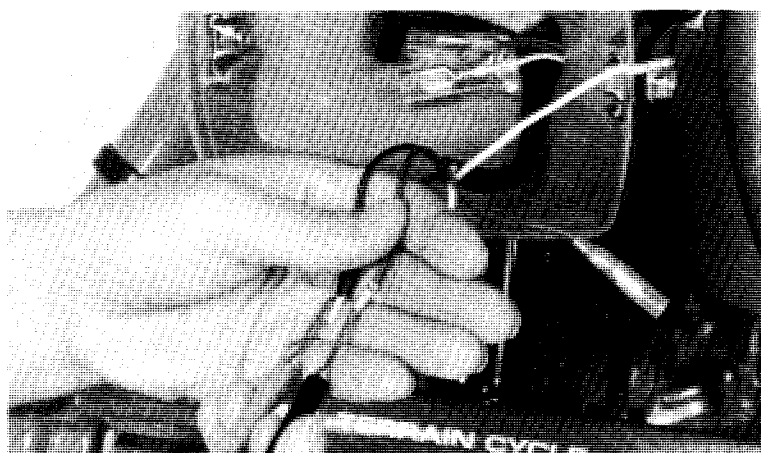

16. WIRING DIAGRAM

WIRING DIAGRAM '84:

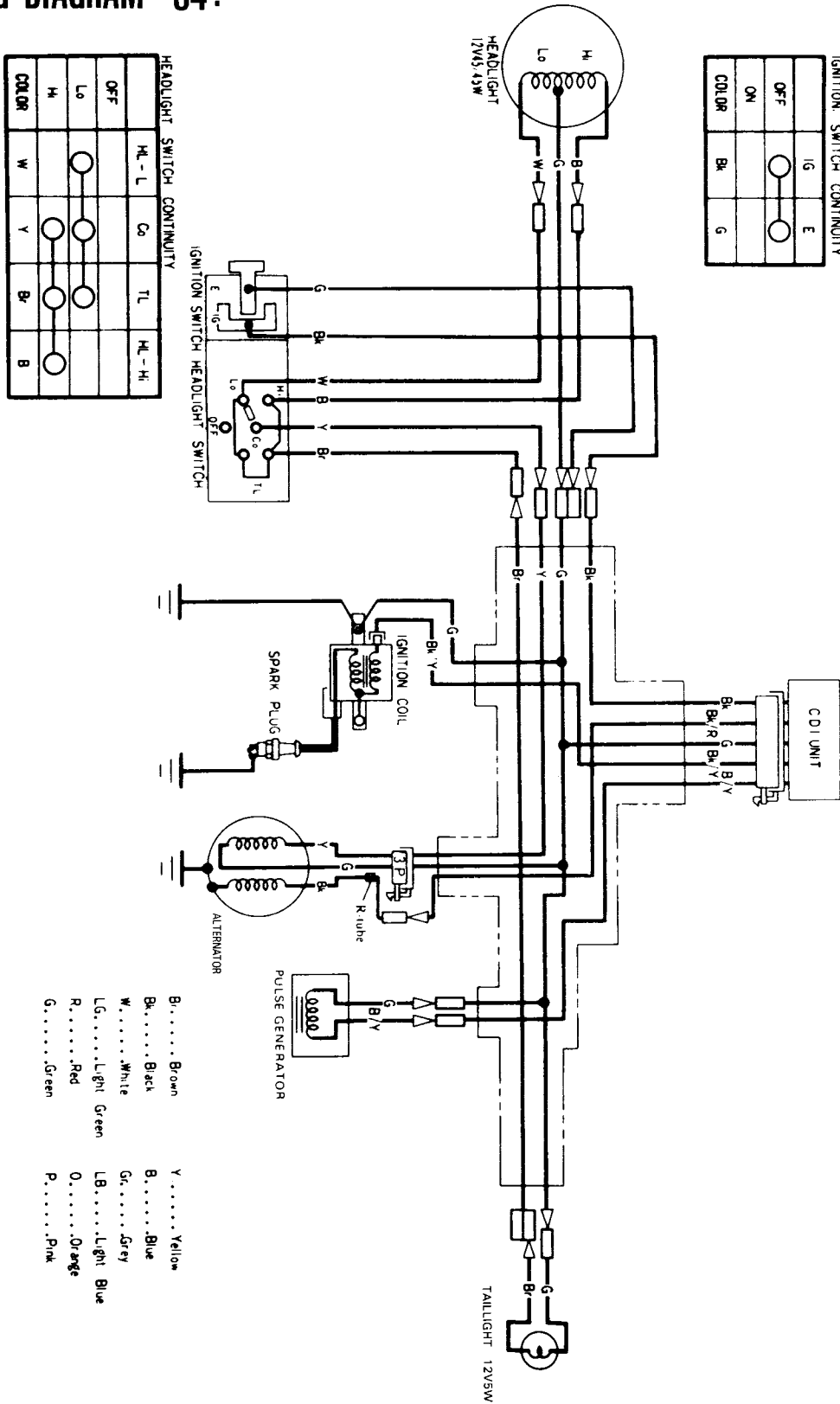

WIRING DIAGRAM '85 :

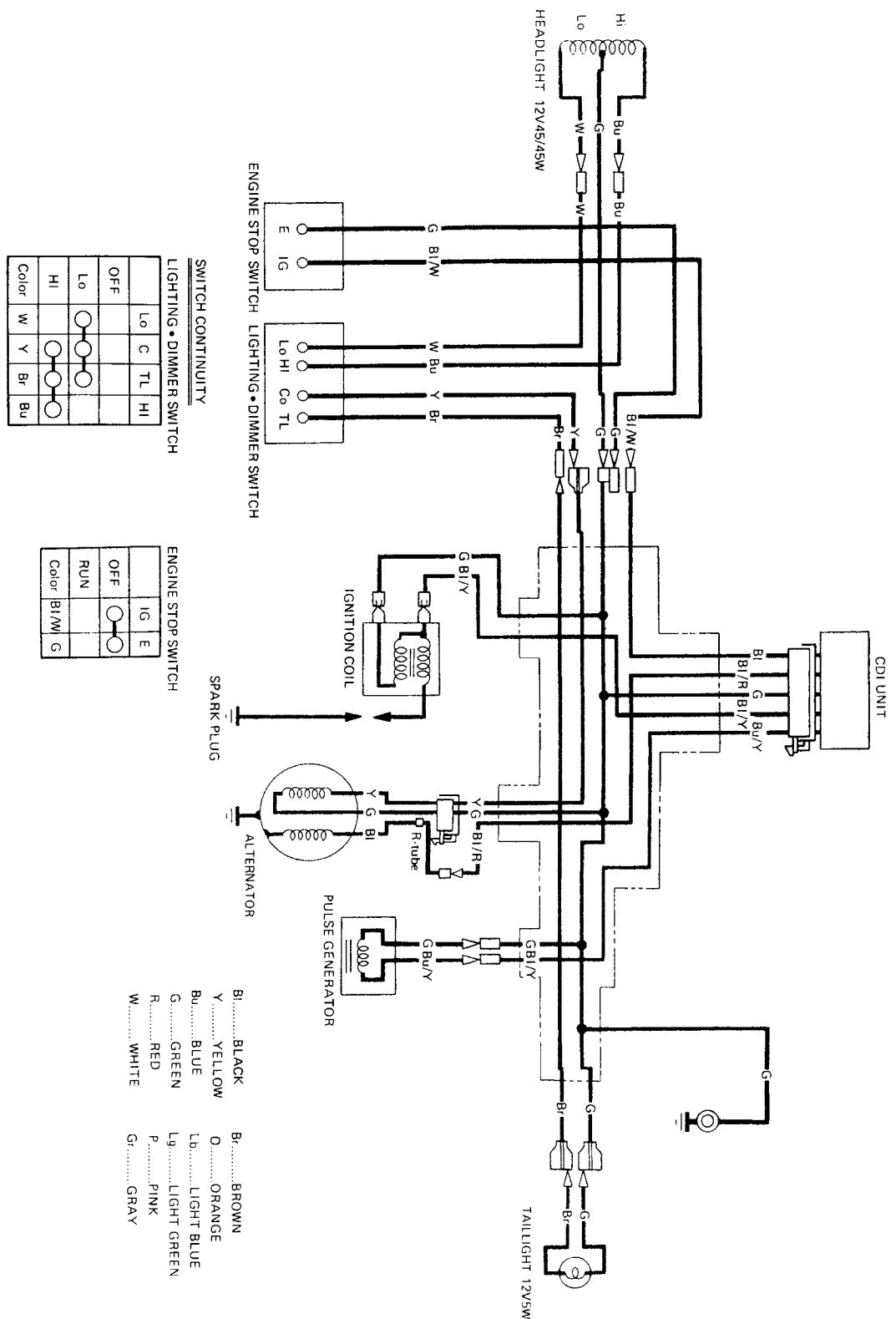

WIRING DIAGRAM After '85 :

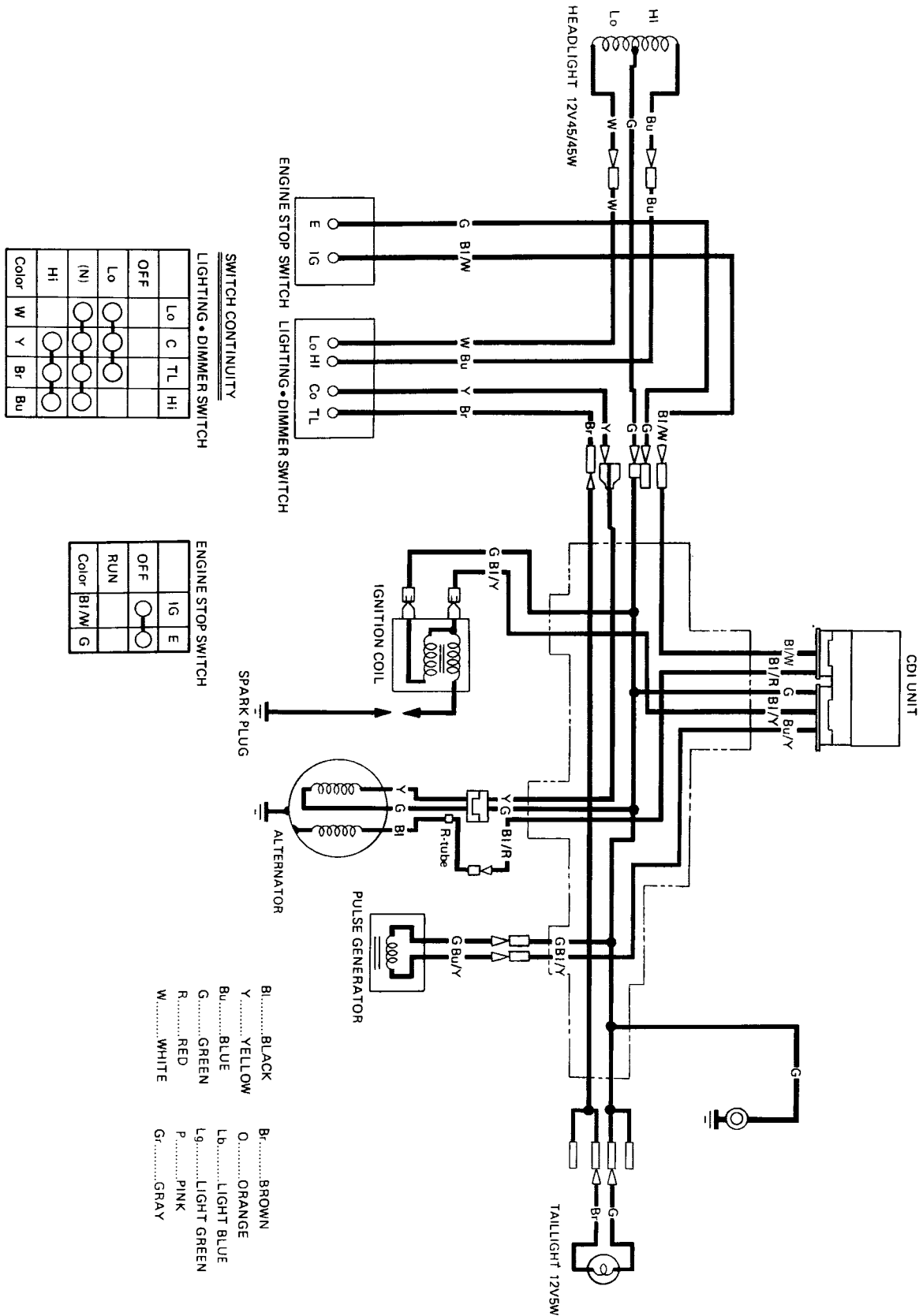

17. TROUBLESHOOTING

| | |
|---|------|
| ENGINE DOES NOT START OR IS HARD TO START | 17-1 |
| ENGINE LACKS POWER | 17-2 |
| POOR PERFORMANCE AT LOW AND IDLE SPEEDS | 17-3 |
| POOR PERFORMANCE AT HIGH SPEEDS | 17-4 |
| POOR HANDLING | 17-4 |

ENGINE DOES NOT START OR IS HARD TO START



ENGINE LACKS POWER

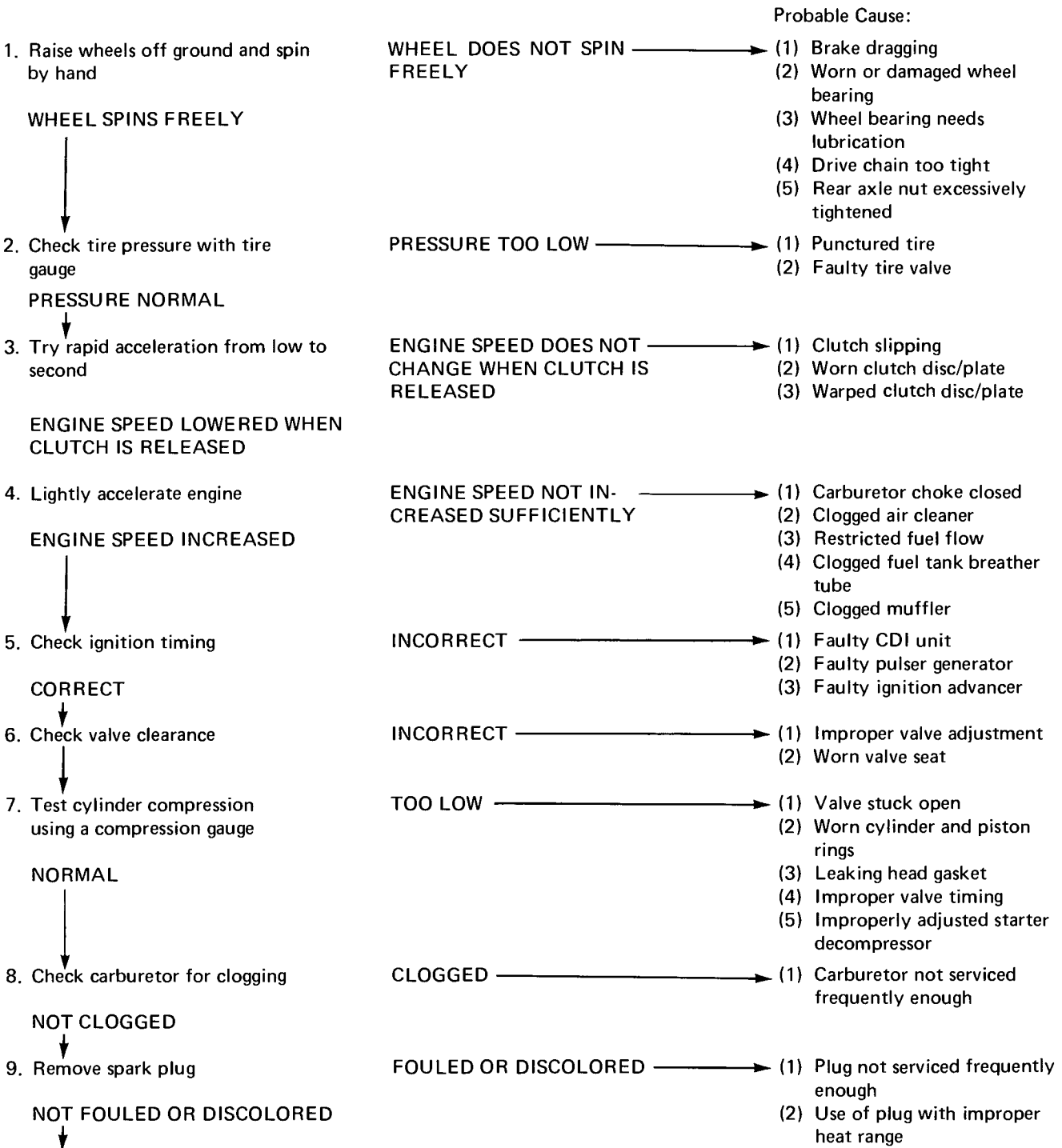

10. Remove oil level gauge and check oil level

CORRECT

11. Remove cylinder head cover and inspect lubrication

VALVE TRAIN LUBRICATED PROPERLY

12. Check if engine overheats

NOT OVERHEATED

13. Accelerate or run at high speed

ENGINE DOES NOT KNOCK

OIL LEVEL INCORRECT

- (1) Oil level too high
- (2) Oil level too low
- (3) Contaminated oil

VALVE TRAIN NOT LUBRICATED PROPERLY

- (1) Clogged oil passage
- (2) Clogged oil control orifice

OVERHEATED

- (1) Excessive carbon build-up in combustion chamber
- (2) Use of improper quality of fuel
- (3) Clutch slipping
- (4) Fuel-air mixture too lean

ENGINE KNOCKS

- (1) Worn piston and cylinder
- (2) Fuel-air mixture too lean
- (3) Use of improper grade of fuel
- (4) Excessive carbon build-up in combustion chamber
- (5) Ignition timing too advanced (Faulty CDI unit or advancer)

POOR PERFORMANCE AT LOW AND IDLE SPEEDS

1. Check ignition timing and valve clearance

CORRECT

2. Check carburetor pilot screw adjustment

CORRECT

3. Check if air is leaking past carburetor insulator

NOT LEAKING

4. Try spark test

GOOD SPARK

INCORRECT

Probable Cause:

- (1) Improper valve clearance
- (2) Improper ignition timing (Faulty CDI unit or spark advancer)

INCORRECT

- (1) Fuel-air mixture too lean
- (2) Fuel-air mixture too rich

LEAKING

- (1) Deteriorated insulator O-ring
- (2) Loose carburetor

WEAK OR INTERMITTENT SPARK

- (1) Faulty, carbon or wet fouled spark plug
- (2) Faulty CDI unit
- (3) Alternator faulty
- (4) Faulty ignition coil
- (5) Faulty pulse generator

POOR PERFORMANCE AT HIGH SPEEDS

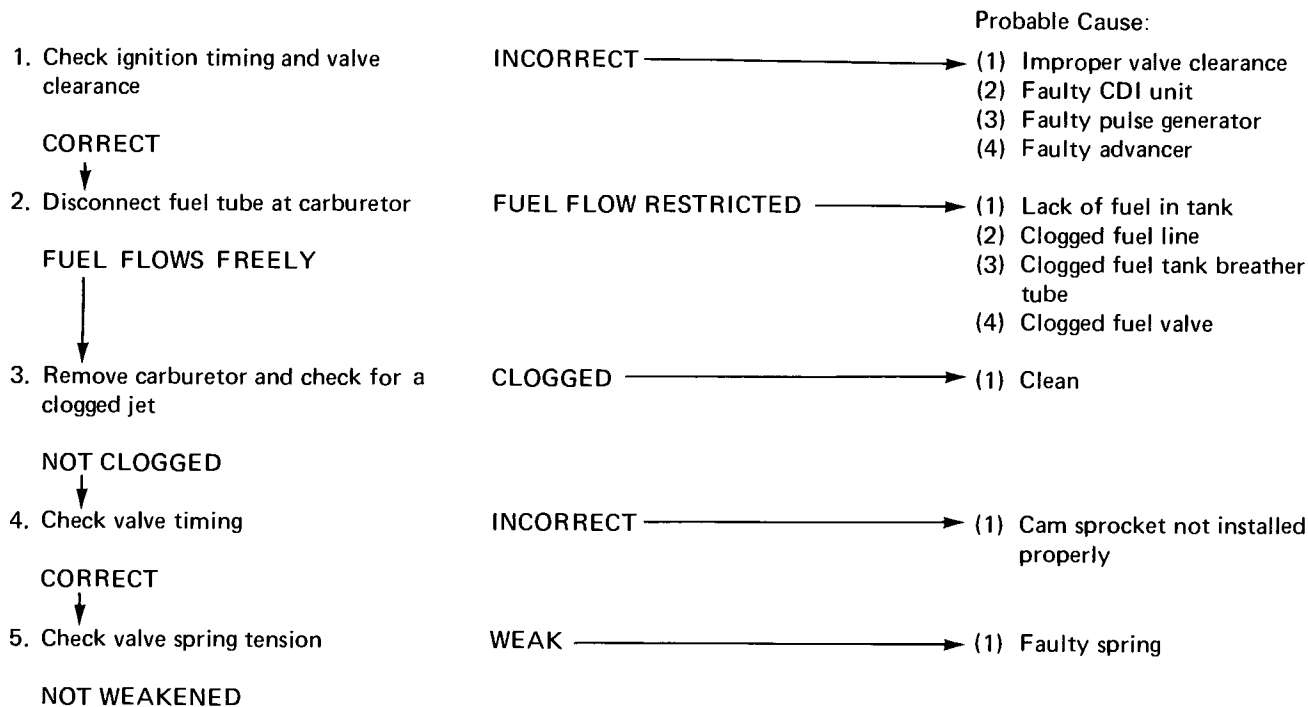

POOR HANDLING

Check tire pressure

