

HONDA

SERVICE MANUAL



85-87
ATC250ES

IMPORTANT SAFETY NOTICE



WARNING *Indicates a strong possibility of severe personal injury or loss of life if instructions are not followed.*

CAUTION: *Indicates a possibility of personal injury or equipment damage if instructions are not followed.*

NOTE: Gives helpful information.

Detailed descriptions of standard workshop procedures, safety principles and service operations are not included. It is important to note that this manual contains *some* warnings and cautions against some specific service methods which could cause **PERSONAL INJURY** to service personnel or could damage a vehicle or render it unsafe. Please understand that those warnings could not cover all conceivable ways in which service, whether or not recommended by Honda, might be done or of the possibly hazardous consequences of each conceivable way, nor could Honda investigate all such ways. Anyone using service procedures or tools, whether or not recommended by Honda, *must satisfy himself thoroughly* that neither personal safety nor vehicle safety will be jeopardized by the service method or tools selected.

HOW TO USE THIS MANUAL

Sections 1 through 3 apply to the whole ATC, while sections 4 through 18 describe parts of the ATC, grouped according to location.

Find the section you want on this page, then turn to the table of contents on page 1 of that section.

Most sections start with an assembly or system illustration, service information and troubleshooting for the section. The subsequent pages give detailed procedures.

If you don't know what the source of the trouble is, refer to section 19, Troubleshooting.

ALL INFORMATION, ILLUSTRATIONS, DIRECTIONS AND SPECIFICATIONS INCLUDED IN THIS PUBLICATION ARE BASED ON THE LATEST PRODUCT INFORMATION AVAILABLE AT THE TIME OF APPROVAL FOR PRINTING. HONDA MOTOR CO., LTD. RESERVES THE RIGHT TO MAKE CHANGES AT ANY TIME WITHOUT NOTICE AND WITHOUT INCURRING ANY OBLIGATION WHATSOEVER. NO PART OF THIS PUBLICATION MAY BE REPRODUCED WITHOUT WRITTEN PERMISSION.

HONDA MOTOR CO., LTD.
Service Publications Office

CONTENTS

	GENERAL INFORMATION	1
	LUBRICATION	2
	MAINTENANCE	3
ENGINE	FUEL SYSTEM	4
	ENGINE REMOVAL/INSTALLATION	5
	CYLINDER HEAD/VALVES	6
	CYLINDER/PISTON	7
	CLUTCH/OIL PUMP/KICK STARTER	8
	ALTERNATOR/STARTER CLUTCH/ GEARSHIFT LINKAGE	9
	CRANKCASE/CRANKSHAFT/ TRANSMISSION	10
CHASSIS	FRONT WHEEL/BRAKE/SUSPENSION/ STEERING	11
	REAR WHEEL/BRAKE/ SUSPENSION/FINAL DRIVE	12
	CARRIERS/REAR FENDER/ EXHAUST MUFFLER	13
ELECTRICAL	IGNITION SYSTEM	14
	BATTERY/CHARGING SYSTEM	15
	STARTER SYSTEM	16
	LIGHTS/SWITCHES	17
	WIRING DIAGRAMS	18
	TROUBLESHOOTING	19
	INDEX	20

CONTENTS

APPENDIX INFORMATION

HOW TO USE THIS MANUAL

Get the most from this manual by reading it through from beginning to end. The information is organized in a logical sequence to help you understand the concepts and procedures involved in the use of this manual.

Read the manual from beginning to end. The information is organized in a logical sequence to help you understand the concepts and procedures involved in the use of this manual.

Read the manual from beginning to end. The information is organized in a logical sequence to help you understand the concepts and procedures involved in the use of this manual.

Read the manual from beginning to end. The information is organized in a logical sequence to help you understand the concepts and procedures involved in the use of this manual.

Read the manual from beginning to end. The information is organized in a logical sequence to help you understand the concepts and procedures involved in the use of this manual.

Read the manual from beginning to end. The information is organized in a logical sequence to help you understand the concepts and procedures involved in the use of this manual.

Read the manual from beginning to end. The information is organized in a logical sequence to help you understand the concepts and procedures involved in the use of this manual.

1. GENERAL INFORMATION

GENERAL SAFETY	1-1
SERVICE RULES	1-1
MODEL IDENTIFICATION	1-2
SPECIFICATIONS	1-3
TORQUE VALUES	1-5
TOOLS	1-9
CABLE & HARNESS ROUTING	1-11
NOISE EMISSION CONTROL SYSTEM	1-17

GENERAL SAFETY

WARNING

If the engine must be running to do some work, make sure the area is well-ventilated. Never run the engine in a closed area. The exhaust contains poisonous carbon monoxide gas.

WARNING

The battery generates hydrogen gas which can be highly explosive. Do not smoke or allow flames or sparks near the battery, especially while charging it.

WARNING

Gasoline is extremely flammable and is explosive under certain conditions. Do not smoke or allow flames or sparks in your work area.

WARNING

The battery electrolyte contains sulfuric acid. Protect your eyes, skin and clothing. In case of contact, flush thoroughly with water and call a doctor if electrolyte gets in your eyes.

SERVICE RULES

1. Use genuine HONDA or HONDA-recommended parts and lubricants or their equivalents. Parts that don't meet HONDA's design specifications may cause damage to the ATC.
2. Use the special tools designed for this product to avoid damage and incorrect assembly.
3. Use only metric tools when servicing this ATC. Metric bolts, nuts, and screws are not interchangeable with English fasteners.
4. Install new gaskets, O-rings, cotter pins, lock plates, when reassembling.
5. When tightening bolts or nuts, begin with larger-diameter or inner bolts first. Then tighten to the specified torque diagonally in 1–5 steps, unless a particular sequence is specified.
6. Clean parts in non-flammable or high flash point solvent upon disassembly.
7. Lubricate any sliding surfaces before reassembly.
8. After reassembly, check all parts for proper installation and operation.

MODEL IDENTIFICATION

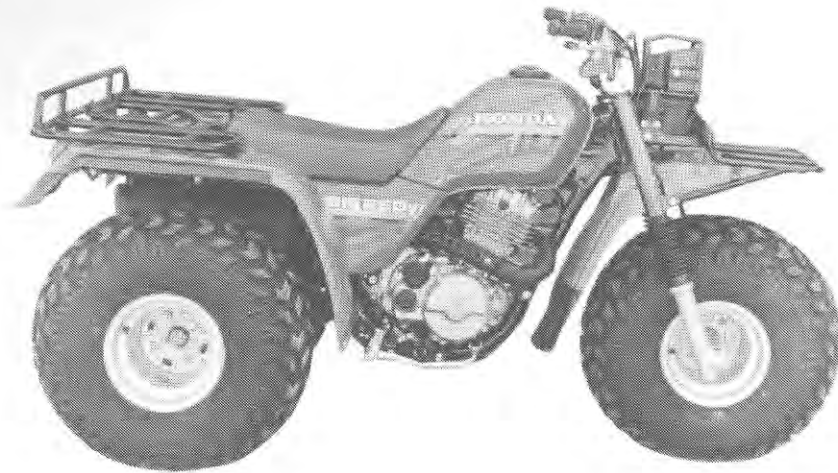

VEHICLE IDENTIFICATION (VIN) NUMBER



The vehicle identification number (VIN) is on the steering head's left side.

FRAME SERIAL NUMBER

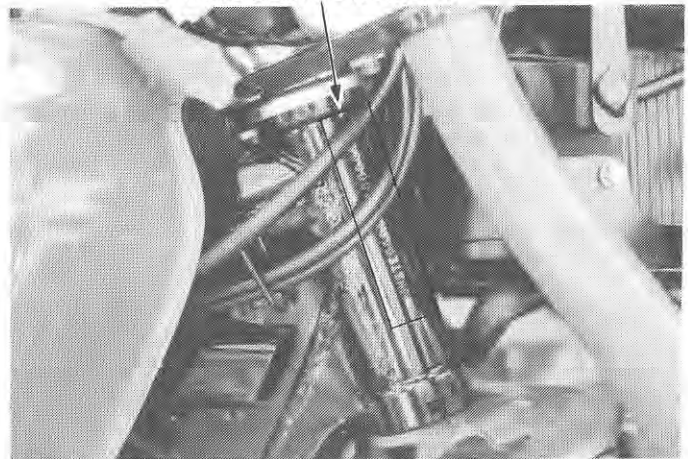

The frame serial number is stamped on the steering head right side.

ENGINE SERIAL NUMBER

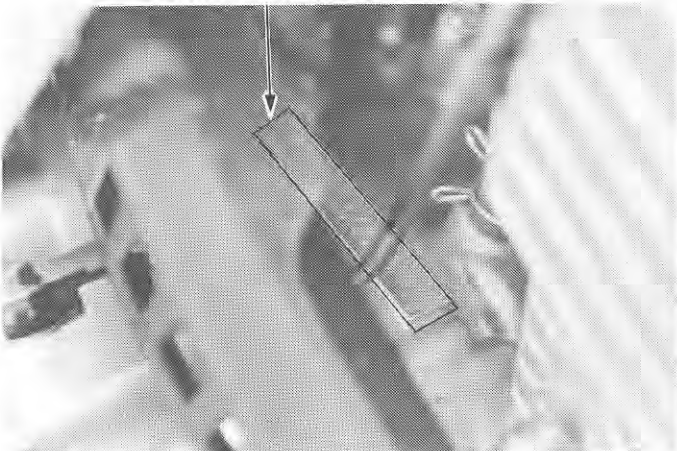

The engine serial number is stamped on the crankcase lower right side.

CARBURETOR IDENTIFICATION

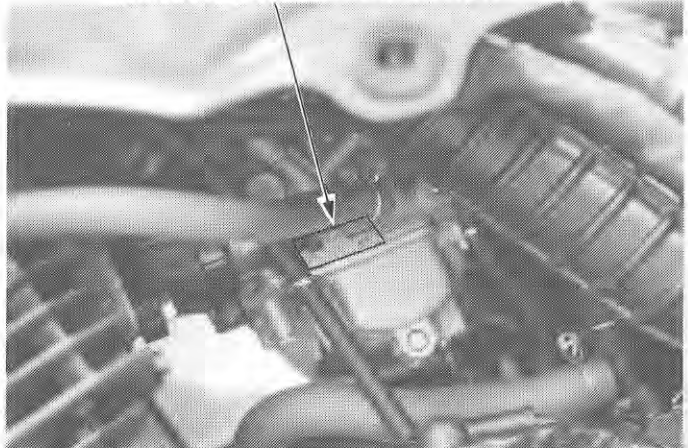

The carburetor identification number is on the carburetor body left side.

SPECIFICATIONS

<p>DIMENSIONS</p>	<p>Overall length Overall width Overall height Wheel base Rear tread Seat height Foot peg height Ground clearance Dry weight</p>	<p>1,887 mm (74.3 in) 1,137 mm (44.8 in) 1,038 mm (40.9 in) 1,237 mm (48.7 in) 840 mm (33.0 in) 705 mm (27.8 in) 267 mm (10.5 in) 165 mm (6.5 in) '85: 184 kg (406 lb) After '85: 186 kg (410 lb)</p>
<p>FRAME</p>	<p>Type Front suspension, travel Rear suspension, travel Rim size Front Rear Front tire size, pressure Rear tire size, pressure Front brake Rear brake Fuel capacity Fuel reserve capacity Caster Trail Front fork oil capacity</p>	<p>Semi-double cradle Telescopic fork, 115 mm (4.5 in) Swingarm, 110 mm (4.3 in) 9 in 9 in 25 x 12.00-9, 0.15 kg/cm² (2.2 psi) 25 x 12.00-9, 0.15 kg/cm² (2.2 psi) Cable operated leading shoe Cable operated leading shoe 12 liters (3.2 US gal, 2.6 Imp gal) 2.0 liters (0.53 US gal, 0.44 Imp gal) 19.5° 0 mm (0 in) 113±2.5 cc (3.8±0.08 oz)</p>
<p>ENGINE</p>	<p>Type Cylinder arrangement Bore x stroke Displacement Compression ratio Valve train Maximum horsepower Maximum torque Oil capacity Lubrication system Cylinder compression Intake valve Exhaust valve Valve clearance (Cold) Engine dry weight</p>	<p>Gasoline, air-cooled 4-stroke Single cylinder inclined 20° 74.0 x 57.3 mm (2.91 x 2.26 in) 246 cc (15.0 cu in) 9 : 1 Overhead camshaft chain drive 17.8 BHP/7000 rpm (18PS/7000 rpm) 1.9 kg-m/6000 rpm (13.7 ft-lb/6000 rpm) 2.5 liter (2.6 US qt, 2.2 Imp qt) after disassembly 2.1 liter (2.2 US qt, 1.8 Imp qt) after draining Forced pressure and wet sump 12-13 kg/cm² (170-185 psi) 8° BTDC 35° ABDC 40° BBDC 5° ATDC } at 1 mm lift 0.08 mm (0.003 in) 0.08 mm (0.003 in) 46.3 kg (102 lb)</p>
<p>CARBURETOR</p>	<p>Type Venturi dia. Main jet Primary jet Starter fuel jet Pilot screw opening Jet needle Float level Idle speed</p>	<p>Dual valve 27 mm (1.06 in) #130 #45 see page 4-1 2 turns out 4 DB-2nd groove 18.5 mm (0.73 in) 1,400±100 rpm</p>

GENERAL INFORMATION

DRIVE TRAIN	Clutch Transmission Primary reduction Gear ratio <table style="margin-left: 100px;"> <tr><td>SL</td></tr> <tr><td>I</td></tr> <tr><td>II</td></tr> <tr><td>III</td></tr> <tr><td>IV</td></tr> <tr><td>Reverse</td></tr> </table> Final reduction Gearshift pattern	SL	I	II	III	IV	Reverse	Wet multi-plate, semi-automatic 5-speed constant mesh with reverse 2.407 (65/27) 4.083 (49/12) 2.389 (43/18) 1.609 (37/23) 1.179 (33/28) 0.906 (29/32) 7.333 (34/12) (44/17) 5.684 (19/13) (35/9) Left foot operated return system, Forward : N-SL-1-2-3-4 Reverse : N-R
SL								
I								
II								
III								
IV								
Reverse								
ELECTRICAL	Ignition Ignition timing <table style="margin-left: 100px;"> <tr><td>Initial</td></tr> <tr><td>Full advance</td></tr> </table> Alternator Battery Spark plug Spark plug gap Headlight Taillight Neutral indicator Reverse indicator	Initial	Full advance	C.D.I. 13° BTDC at idle 31° BTDC at 3,500 rpm 200 W/5,000 rpm 12V-10 AH DR8ES-L (NGK) X24ESR-U (ND) 0.6-0.7 mm (0.024-0.028 in) 12V 60W/60W 12V 5W x 2 12V 3W 12V 3W				
Initial								
Full advance								

TORQUE VALUES

'85

ENGINE

Item	Q'ty	Thread Size (mm)	Torque		
			N·m	kg-m	ft-lb
Cylinder head socket bolt	3	8 x 1.25	22-28	2.2-2.8	16-20
Cylinder head cap nut	4	10 x 1.25	35-45	3.5-4.5	25-33
Crankcase SH bolt	14	6 x 1.0	8-12	0.8-1.2	6-9
Gearshift return spring pin	1	8 x 1.25	18-25	1.8-2.5	13-18
Output gear case socket bolt	3	8 x 1.25	20-25	2.0-2.5	15-18
Output driven gear bearing holder socket bolt	3	8 x 1.25	20-25	2.0-2.5	15-18
Output gear bearing outer lock nut	1	64 x 1.5	90-110	9.0-11.0	65-80
Output driven gear bearing outer lock nut	1	60 x 1.5	90-110	9.0-11.0	65-80
Output gear bearing inner lock nut	1	28 x 1.0	70-80	7.0-8.0	51-58
Kick starter stopper plate socket bolt	2	6 x 1.0	10-14	1.0-1.4	7-10
Flywheel bolt	1	12 x 1.25	100-120	10.0-12.0	72-87
Pulse generator screw	2	5 x 0.8	8-12	0.8-1.2	6-9
Right crankcase cover SH bolt	12	6 x 1.0	8-12	0.8-1.2	6-9
Left crankcase cover SH bolt	11	6 x 1.0	8-12	0.8-1.2	6-9
Oil separator plate SH bolt	2	6 x 1.0	8-12	0.8-1.2	6-9
Manual clutch lock nut	1	18 x 1.0	100-120	10-12	72-87
Clutch lifter cap bolt	4	6 x 1.0	10-14	1.0-1.4	7-10
Centrifugal clutch lock nut	1	20 x 1.0	110-130	11.0-13.0	80-94
Cylinder base SH bolt	2	6 x 1.0	8-12	0.8-1.2	6-9
Cam sprocket bolt	2	7 x 1.0	17-23	1.7-2.3	12-17
Cylinder head cover SH bolt	7	6 x 1.0	8-12	0.8-1.2	6-9
Valve adjusting lock nut	2	6 x 0.75	15-18	1.5-1.8	11-13
Cam chain holder socket bolt	1	6 x 1.0	8-12	0.8-1.2	6-9
	3	7 x 1.0	8-12	0.8-1.2	6-9
Spark plug	1	12 x 1.25	15-20	1.5-2.0	11-15
Intake manifold band screw	1	5 x 0.8	3-5	0.3-0.5	2-4
Oil filter cover SH bolt	3	6 x 1.0	8-12	0.8-1.2	6-9
Neutral/Reverse switch	2	10 x 1.25	11-15	1.1-1.5	8-11
Starter clutch socket bolt	6	8 x 1.25	18-25	1.8-2.5	13-18
Cam chain tensioner lifter SH bolt	2	6 x 1.0	8-12	0.8-1.2	6-9
Alternator stator SH bolt	3	6 x 1.0	8-12	0.8-1.2	6-9
Breather plate socket bolt	1	6 x 1.0	10-14	1.0-1.4	7-10
Clutch adjusting screw lock nut	1	8 x 1.25	19-25	1.9-2.5	14-18
Cam chain tensioner lifter sealing bolt	1	6 x 1.0	8-12	0.8-1.2	6-9

GENERAL INFORMATION

FRAME

Item	Q'ty	Thread Size (mm)	Torque		
			N·m	kg-m	ft-lb
Handlebar upper holder bolt	4	8 x 1.25	18–30	1.8–3.0	13–22
Handlebar upper holder nut	2	10 x 1.25	40–50	4.0–5.0	29–36
Fork bridge bolt	2	12 x 1.25	50–70	5.0–7.0	36–51
Steering stem nut	1	24 x 1.0	70–90	7.0–9.0	51–65
Steering bearing adjustment nut (Initial) (Final)	1	24 x 1.0	25–35 7–8	2.5–3.5 0.7–0.8	18–25 5–6
Wheel nut	12	10 x 1.25	50–60	5.0–6.0	36–43
Front axle	1	14 x 1.5	70–110	7.0–11.0	51–80
Rear axle nut	2	20 x 1.5	80–120	8.0–12.0	58–87
Rear brake panel nut	4	10 x 1.25	50–60	5.0–6.0	36–43
Rear shock absorber mount bolt	2	10 x 1.25	50–60	5.0–6.0	36–43
Front fork mount bolt	4	10 x 1.25	50–60	5.0–6.0	36–43
Swingarm right pivot bolt	1	30 x 1.5	16–20	1.6–2.0	12–15
Swingarm left pivot bolt	1	30 x 1.5	100–130	10.0–13.0	72–94
Swingarm pivot lock nut	1	30 x 1.5	100–130	10.0–13.0	72–94
Final gear case mount bolt	4	10 x 1.25	50–60	5.0–6.0	36–43
	4	8 x 1.25	28–35	2.8–3.5	20–25
Rear left bearing housing bolt	4	8 x 1.25	28–35	2.8–3.5	20–25
Engine hanger bolt	9	10 x 1.25	45–65	4.5–6.5	33–47
Gearshift pedal bolt	1	6 x 1.0	10–14	1.0–1.4	7–10
Foot peg bracket bolt	4	10 x 1.25	40–50	4.0–5.0	29–36
Intake manifold bolt	2	6 x 1.0	6–9	0.6–0.9	5–7
Muffler clamp bolt	2	8 x 1.25	18–28	1.8–2.8	13–20
Front fork socket bolt	2	8 x 1.25	18–25	1.8–2.5	13–18
Rear shock absorber rod lock nut	1	12 x 1.25	38–60	3.8–6.0	27–43
Final gear case cover bolt	2	10 x 1.25	45–50	4.5–5.0	25–36
	6	8 x 1.25	23–28	2.3–2.8	17–20
Pinion joint nut	1	16 x 1.5	100–120	10.0–12.0	72–87
Pinion bearing outer race lock nut	1	60 x 1.5	90–110	9.0–11.0	65–80

Torque specifications listed above are for the most important tightening points. If a torque specification is not listed, follow the standards given below.

STANDARD TORQUE VALUES

Item	Torque N·m (kg-m, ft-lb)	Item	Torque N·m (kg-m, ft-lb)
5 mm bolt, nut	4.5–6 (0.45–0.6, 3–4)	5 mm screw	3.5–5 (0.35–0.5, 2–4)
6 mm bolt, nut	8–12 (0.8–1.2, 6–9)	6 mm screw, SH bolt	7–11 (0.7–1.1, 5–8)
8 mm bolt, nut	18–25 (1.8–2.5, 13–18)	6 mm flange bolt, nut	10–14 (1.0–1.4, 7–10)
10 mm bolt, nut	30–40 (3.0–4.0, 22–29)	8 mm flange bolt, nut	24–30 (2.4–3.0, 17–22)
12 mm bolt, nut	50–60 (5.0–6.0, 36–43)	10 mm flange bolt, nut	35–45 (3.5–4.5, 25–33)

AFTER '85: ENGINE

Item	Q'ty	Thread Size (mm)	Torque		
			N-m	kg-m	ft-lb
Cylinder head socket bolt	3	8 x 1.25	22-28	2.2-2.8	16-20
Cylinder head cap nut	4	10 x 1.25	35-45	3.5-4.5	25-33
Crankcase SH bolt	14	6 x 1.0	8-12	0.8-1.2	6-9
Gearshift return spring pin bolt	1	8 x 1.25	18-25	1.8-2.5	13-18
Output gear case bolt	3	8 x 1.25	30-34	3.0-3.4	22-25
Output driven gear bearing holder socket bolt	3	8 x 1.25	20-25	2.0-2.5	14-18
Output gear bearing outer lock nut	1	64 x 1.5	90-110	9.0-11.0	65-80
Output driven gear bearing outer lock nut	1	60 x 1.5	90-110	9.0-11.0	65-80
Output gear bearing inner lock nut	1	28 x 1.0	70-80	7.0-8.0	51-58
Kick starter stopper plate socket bolt	2	6 x 1.0	10-14	1.0-1.4	7-10
Flywheel bolt	1	12 x 1.25	100-120	10.0-12.0	72-87
Pulse generator screw	2	5 x 0.8	5-7	0.5-0.7	4-5
Right crankcase cover SH bolt	12	6 x 1.0	8-12	0.8-1.2	6-9
Left crankcase cover SH bolt	11	6 x 1.0	8-12	0.8-1.2	6-9
Oil separator plate SH bolt	2	6 x 1.0	8-12	0.8-1.2	6-9
Manual clutch lock nut	1	18 x 1.0	100-120	10.0-12.0	72-87
Clutch lifter bolt	4	6 x 1.0	10-14	1.0-1.4	7-10
Centrifugal clutch lock nut	1	20 x 1.0	110-130	11.0-13.0	80-94
Cylinder base SH bolt	2	6 x 1.0	8-12	0.8-1.2	6-9
Cam sprocket bolt	2	7 x 1.0	17-23	1.7-2.3	12-17
Cylinder head cover SH bolt	7	6 x 1.0	8-12	0.8-1.2	6-9
Valve adjusting lock nut	2	6 x 0.75	15-18	1.5-1.8	11-13
Cam chain holder socket bolt	1	6 x 1.0	10-14	1.0-1.4	7-10
Oil pipe bolt	3	7 x 1.0	10-14	1.0-1.4	7-10
Spark plug	1	12 x 1.25	15-20	1.5-2.0	11-14
Intake pipe band screw	1	5 x 0.8	3-5	0.3-0.5	2-4
Oil filter cover SH bolt	3	6 x 1.0	8-12	0.8-1.2	6-9
Neutral/Reverse switch	2	10 x 1.25	11-15	1.1-1.5	8-11
Starter clutch torx bolt	6	8 x 1.25	20-25	2.0-2.5	14-18
Cam chain tensioner lifter SH bolt	2	6 x 1.0	8-12	0.8-1.2	6-9
Alternator stator SH bolt	3	6 x 1.0	8-12	0.8-1.2	6-9
Breather plate socket bolt	1	6 x 1.0	10-14	1.0-1.4	7-10
Clutch adjusting screw lock nut	1	8 x 1.25	18-25	1.8-2.5	13-18
Cam chain tensioner lifter sealing bolt	1	6 x 1.0	8-12	0.8-1.2	6-9
Engine oil drain plug	1	12 x 1.5	20-30	2.0-3.0	14-22
Intake pipe bolt	2	6 x 1.0	10-14	1.0-1.4	7-10
Gear case drain bolt	1	8 x 1.25	10-14	1.0-1.4	7-10
Gear case filler cap	1	30 x 1.5	10-14	1.0-1.4	7-10

GENERAL INFORMATION

FRAME

Item	Q'ty	Thread Size (mm)	Torque			
			N·m	kg·m	ft·lb	
Handlebar upper holder bolt	4	8 x 1.25	18–30	1.8–3.0	13–22	
Handlebar lower holder nut	2	10 x 1.25	40–50	4.0–5.0	29–36	
Fork bridge bolt	2	12 x 1.25	50–70	5.0–7.0	36–51	
Steering stem nut	1	24 x 1.0	70–90	7.0–9.0	51–65	
Steering bearing adjustment nut (Initial) (Final)	1	24 x 1.0	25–35 7–8	2.5–3.5 0.7–0.8	18–25 5–6	
Wheel nut	12	10 x 1.25	60–70	6.0–7.0	43–51	
Front axle	1	14 x 1.5	70–110	7.0–11.0	51–80	
Rear axle nut	2	18 x 1.5	80–140	8.0–14.0	58–101	
Rear brake panel nut	4	10 x 1.25	50–60	5.0–6.0	36–43	
Rear shock absorber mount bolt	2	10 x 1.25	50–60	5.0–6.0	36–43	
Front fork pinch bolt	4	10 x 1.25	50–60	5.0–6.0	36–43	
Swingarm right pivot bolt	1	30 x 1.5	16–20	1.6–2.0	12–14	
Swingarm left pivot bolt	1	30 x 1.5	100–130	10.0–13.0	72–94	
Swingarm pivot lock nut	1	30 x 1.5	100–130	10.0–13.0	72–94	
Final gear case mount bolt	4	10 x 1.25	50–60	5.0–6.0	36–43	
	4	8 x 12.5	30–36	3.0–3.6	22–26	
Left rear bearing housing bolt	4	8 x 1.25	30–36	3.0–3.6	22–26	
Engine hanger bolt	10 mm	9	10 x 1.25	45–65	4.5–6.5	33–47
	8 mm	2	8 x 1.25	24–30	2.4–3.0	17–22
Gearshift pedal bolt	1	6 x 1.0	14–18	1.4–1.8	10–13	
Foot peg bracket bolt	4	10 x 1.25	40–50	4.0–5.0	29–36	
Intake manifold bolt	2	6 x 1.0	10–14	1.0–1.4	7–10	
Muffler clamp bolt	2	8 x 1.25	18–28	1.8–2.8	13–20	
Front fork socket bolt	2	8 x 1.25	15–25	1.5–2.5	11–18	
Rear shock absorber rod lock nut	1	12 x 1.25	38–60	3.8–6.0	27–43	
Final gear case cover bolt	10 mm	2	10 x 1.25	45–50	4.5–5.0	33–36
	8 mm	6	8 x 1.25	23–28	2.3–2.8	17–20
Pinion joint nut	1	16 x 1.5	100–120	10.0–12.0	72–87	
Pinion bearing outer race lock nut	1	60 x 1.5	90–110	9.0–11.0	65–80	
Front axle holder nut	4	6 x 1.0	10–14	1.0–1.4	7–10	

Torque specifications listed above are for the most important tightening points. If a torque specification is not listed, follow the standards given below.

STANDARD TORQUE VALUES

Item	Torque N·m (kg·m, ft·lb)	Item	Torque N·m (kg·m, ft·lb)
5 mm bolt, nut	4.5–6 (0.45–0.6, 3–4)	5 mm screw	3.5–5 (0.35–0.5, 2–4)
6 mm bolt, nut	8–12 (0.8–1.2, 6–9)	6 mm screw, SH bolt	7–11 (0.7–1.1, 5–8)
8 mm bolt, nut	18–25 (1.8–2.5, 13–18)	6 mm flange bolt, nut	10–14 (1.0–1.4, 7–10)
10 mm bolt, nut	30–40 (3.0–4.0, 22–29)	8 mm flange bolt, nut	24–30 (2.4–3.0, 17–22)
12 mm bolt, nut	50–60 (5.0–6.0, 36–43)	10 mm flange bolt, nut	35–45 (3.5–4.5, 25–33)

TOOLS

SPECIAL

DESCRIPTION	TOOL NUMBER	ALTERNATIVE TOOL	TOOL NUMBER	REF. SECTION
Pinion joint holder	07924-HA00000			12
Pinion gear driver	07945-HA00000			12
Universal bearing puller	07631-0010000	Bearing driver Commercially available in U.S.A.		10, 12
Socket bit, 17 mm	07703-0020500			12
Pivot lock nut wrench	07908-4690001	Lock nut wrench (U.S.A.)	KS-HBA-08-469	12
Attachment	07965-SA00600			12
Steering stem socket	07916-3710100			11
Lock nut wrench, 34 x 44 mm	07916-ME50000			10
Clutch holder	07923-HA80000	07923-HB3000A- U.S.A. only		8
Clutch puller	07933-HA80000	07933-HB3000A- U.S.A. only		8
Hex wrench, 6 mm	07917-3230000	Commercially available in U.S.A.		11
Clutch center holder	07923-KE10001	Commercially available in U.S.A.		8
Pinion holder	07924-ME50000			10, 12
Crank assembly kit	07931-KF00000			10
- Assembly collar	07931-KF00100			10
- Threaded adapter	07931-KF00200			10
- Shaft puller	07931-ME40000			10, 12
Bearing remover, 17 mm	07936-3710300			8, 10
Remover handle	07936-3710100			10, 12
Remover weight	07741-0010201	Remover weight	07936-3710200	9, 10, 12
Bearing remover set, 10 mm	07936-GE00000			9
Bearing remover set, 20 mm	07936-3710001			8
- Bearing remover, 20 mm	07936-3710600			8
- Remover handle	07936-3710100			8
- Remover weight	07741-0010201			8
Bearing remover, 15 mm	07936-KC10000		07936-3710200	10
- Bearing remover, 15 mm	07936-KC10500			10
- Remover weight	07741-0010201			10
Attachment, 28 x 30 mm	07946-1870100			8, 10
Attachment	07946-3290000			11
Steering stem driver	07946-4300101	Steering stem driver and attachment (U.S.A. only)	07946-MB00000 GN-HT-54	11
Ball race remover	07953-3330000			11
Valve guide reamer	07984-0980000			6
Universal bead breaker	GN-AH-958-BB1	(U.S.A. only)		11
Lock nut wrench, 30 x 64 mm	07916-MB00000			10
Shock absorber compressor base	07959-MB10000			12
Bearing remover	07936-4150000		07936-3710500	12
Fork seal driver	07747-0010100		07947-3330000	11
Attachment	07749-0010501		07947-3330000	11
Water seal driver	07947-HA00000			12

GENERAL INFORMATION

COMMON

DESCRIPTION	TOOL NUMBER	ALTERNATIVE TOOL	TOOL NUMBER	REF. SECTION
Float level gauge	07401-0010000			4
Valve adjusting wrench, 10 x 12 mm	07708-0030200	Commercially available in U.S.A.		3
Valve adjusting wrench A	07708-0030300			3
Valve adjusting wrench B	07708-0030400			3
Lock nut wrench, 17 x 27 mm	07716-0020300	Commercially available in U.S.A.		8
Lock nut wrench, 30 x 32 mm	07716-0020400			11
Extension	07716-0020500	Commercially available in U.S.A.		8, 11
Flywheel holder	07725-0040000	Strap wrench commercially available in U.S.A.		9
Rotor puller	07733-0020001	Rotor puller	07933-3950000	9
Valve guide remover, 5.5 mm	07742-0010100	Valve guide remover	07942-3290100	6
Attachment, 24 x 26 mm	07746-0010700			9, 12
Attachment, 37 x 40 mm	07746-0010200			10, 12
Pilot, 17 mm	07746-0040400			8, 10
Pilot, 15 mm	07746-0040300			10, 11
Attachment, 42 x 47 mm	07746-0010300			8, 10, 11, 12
Pilot, 25 mm	07746-0040600			10
Pilot, 20 mm	07746-0040500			8, 10
Pilot, 22 mm	07746-0041000			10
Attachment, 52 x 55 mm	07746-0010400			10, 12
Pilot, 28 mm	07746-0041100			10
Attachment, 62 x 68 mm	07746-0010500			12
Pilot, 35 mm	07746-0040800			10, 12
Attachment, 72 x 75 mm	07746-0010600			10
Driver	07749-0010000			8, 9, 10, 11, 12
Driver	07746-0030100			10
Attachment, 30 mm I.D.	07746-0030300			10
Fork seal driver	07747-0010100			
Fork seal driver attachment	07747-0010501			
Valve spring compressor	07757-0010000	Valve spring compressor	07957-3290001	6
Shock absorber compressor	07959-3290001			12
Attachment, 20 mm I.D.	07746-0020400			12
Driver	07746-0020100			12
Tire breaker set	07772-0050000			11
—Breaker arm compressor	07772-0050100			11
—Breaker arm	07772-0050200			11
Pilot, 30 mm	07746-0040700			11
Digital multi-tester (KOWA)	KS-AHM-32-003	Electric tester	P/N 7308-0020000	14
Digital volt meter	07411-0020000			

CABLE & HARNESS ROUTING

Note the following when routing cables and wire harnesses:

- A loose wire, harness or cable can be a safety hazard. After clamping, check each wire to be sure it is secure.
- Do not squeeze wires against a weld or end of a clamp.
- Secure wires and wire harnesses to the frame with their respective wire bands at the designated locations. Tighten the bands so that only the insulated surfaces contact the wires or wire harnesses.
- Route harnesses so they are not pulled taut or have excessive slack.
- Protect wires and harnesses with electrical tape or tubing if they are in contact with a sharp edge or corner. Clean the attaching surface thoroughly before applying tape.
- Do not use any wires or harnesses with a broken insulator. Repair by wrapping them with a protective tape or replace them.
- Route wire harnesses to avoid sharp edges or corners.
- Also avoid the projected ends of bolts and screws.
- Keep wire harnesses away from the exhaust pipes and other hot parts.
- Be sure grommets are seated in their grooves properly.
- After clamping, check each harness to be certain that it does not interfere with any moving or sliding parts.
- Wire harnesses routed along the handlebars should not be pulled taut, have excessive slack, be pinched, or interfere with adjacent or surrounding parts in all steering positions.
- After routing, check that the wire harnesses are not twisted or kinked.
- Do not bend or twist control cables. Damaged control cables will not operate smoothly and may stick or bind.

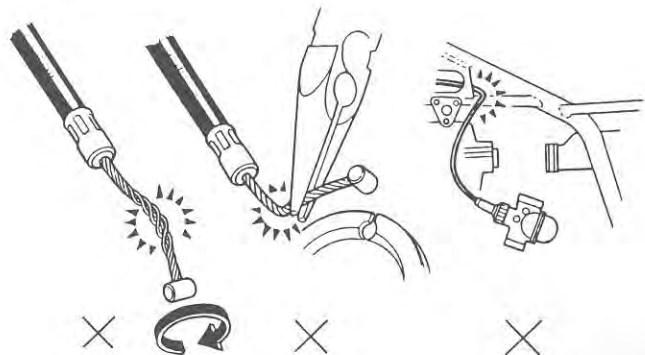
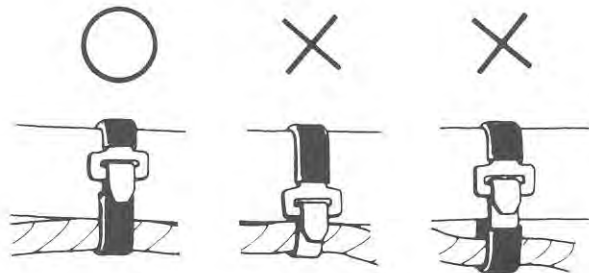
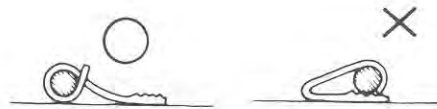
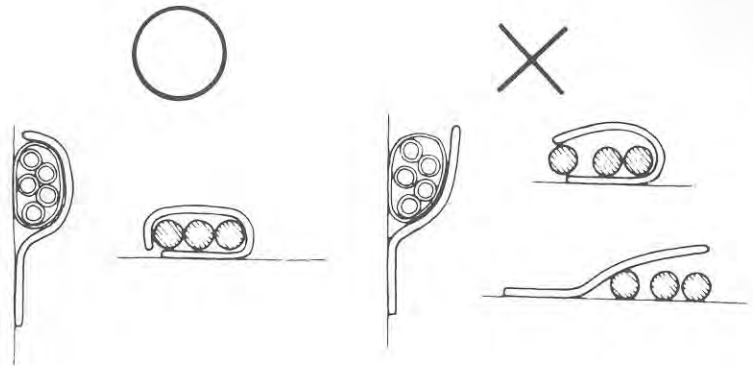

○...Correct
X...Incorrect

GENERAL INFORMATION

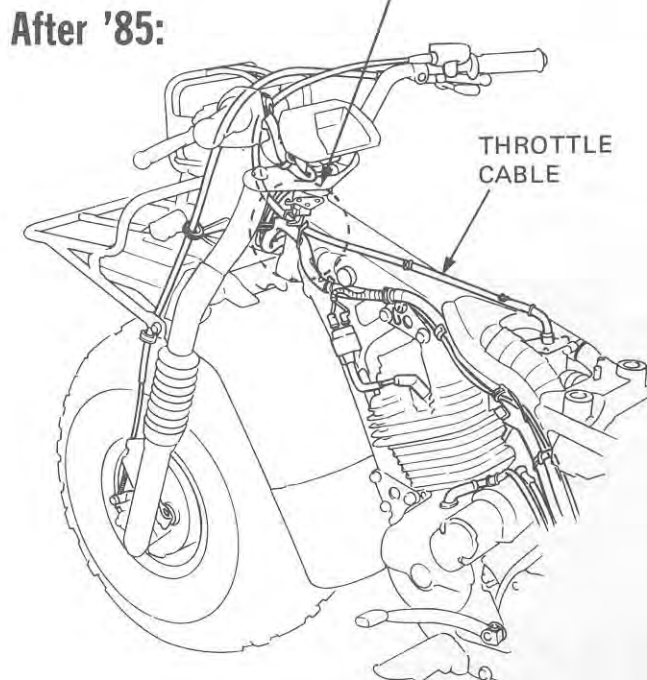
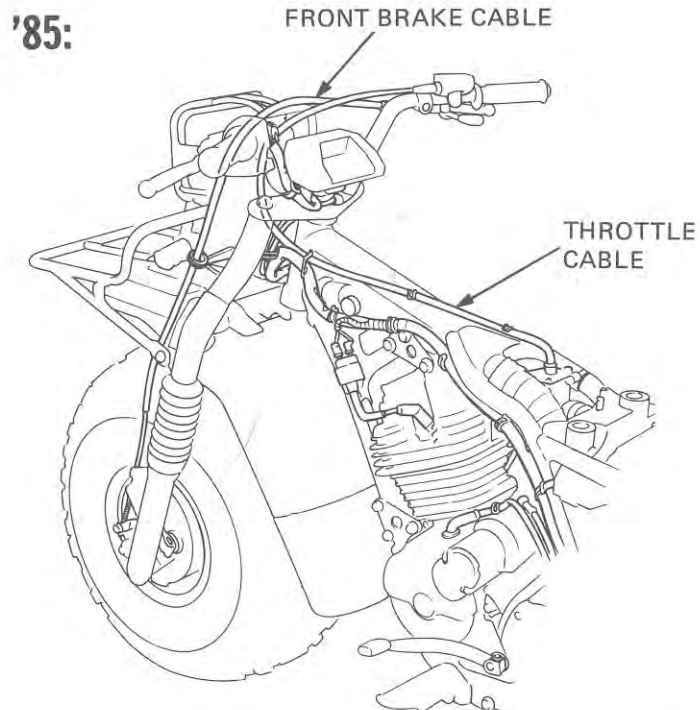
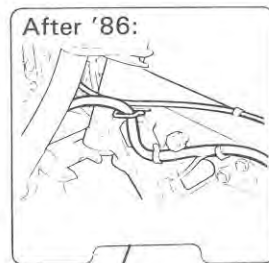
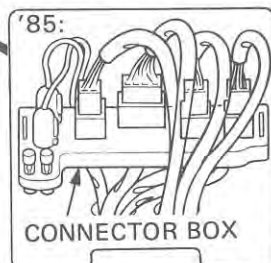
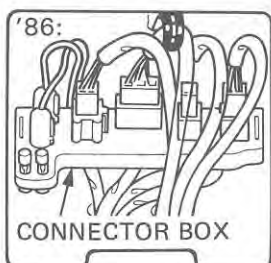
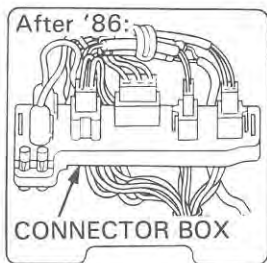
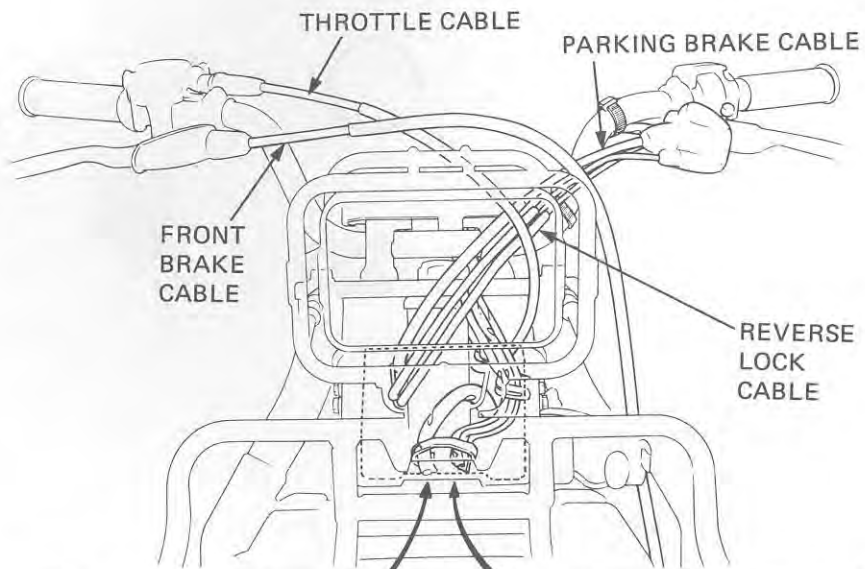

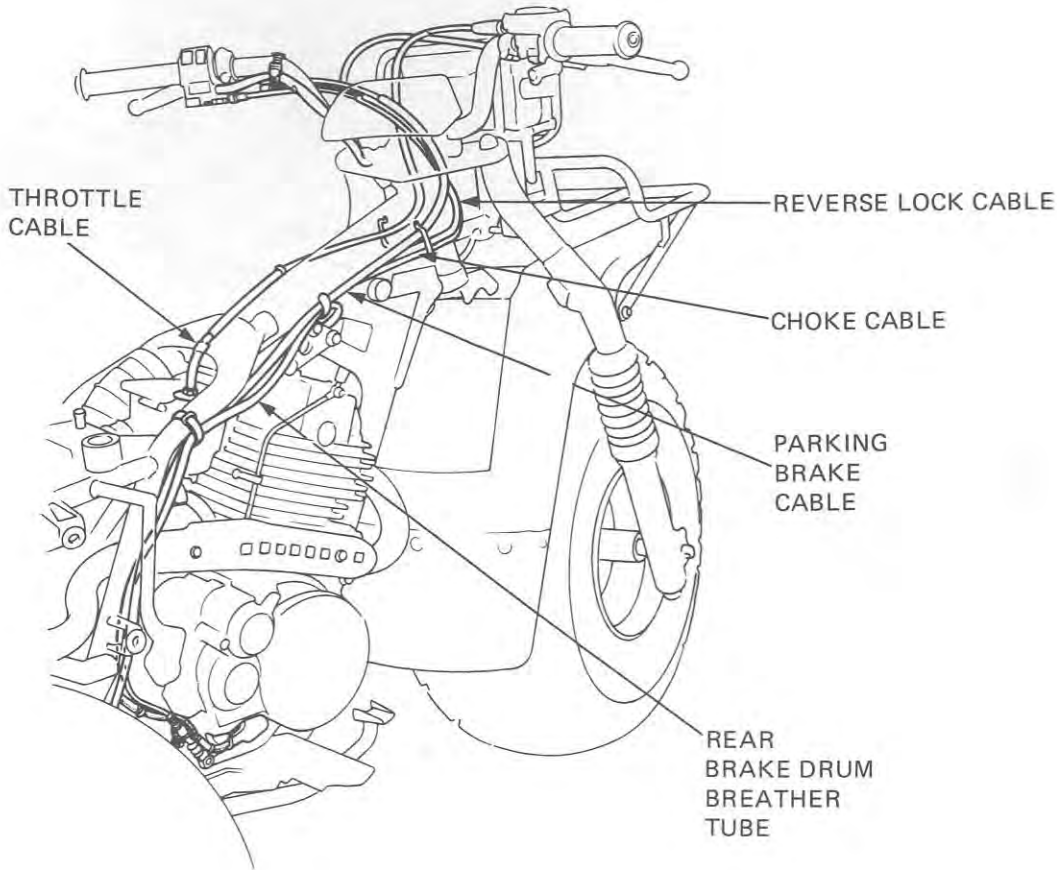

'85:

REAR BRAKE DRUM BREATHER TUBE

AFTER '85:

REAR BRAKE DRUM BREATHER TUBE

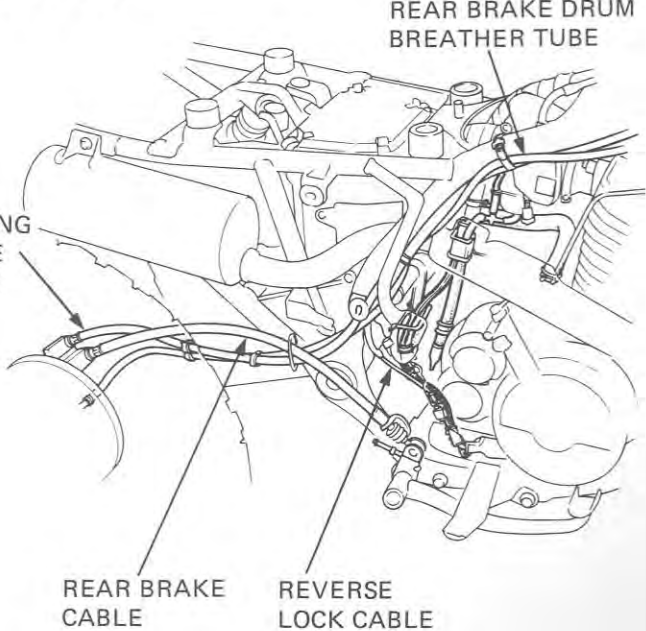
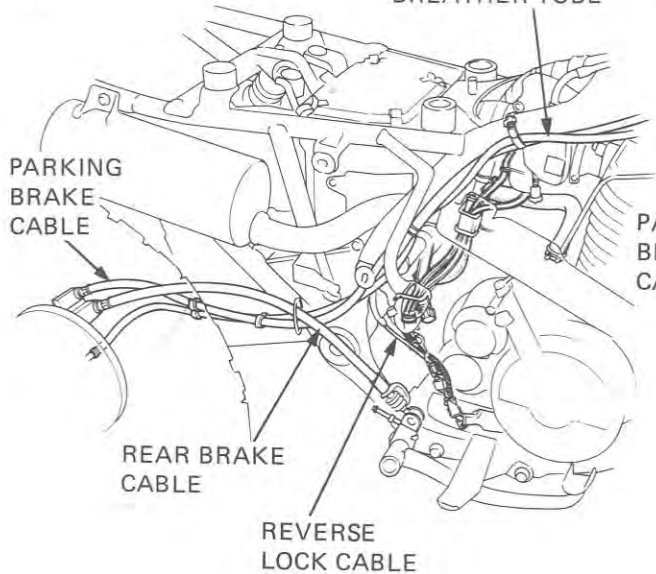

GENERAL INFORMATION

TAILLIGHT WIRE HARNESS

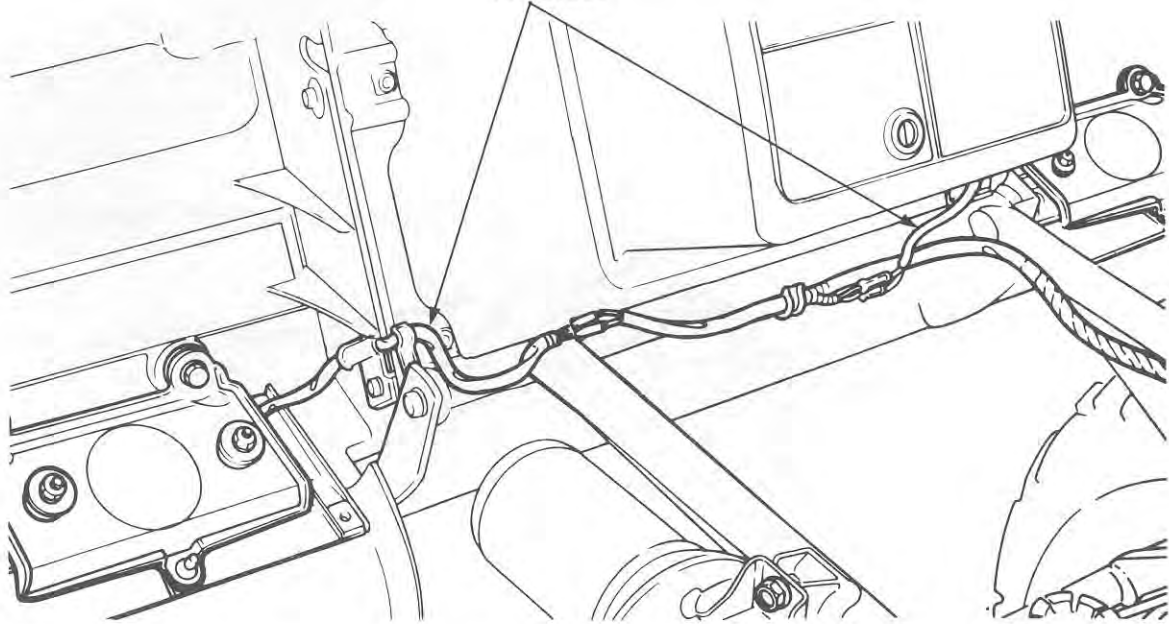

'85:

FINAL GEAR CASE BREATHING TUBE

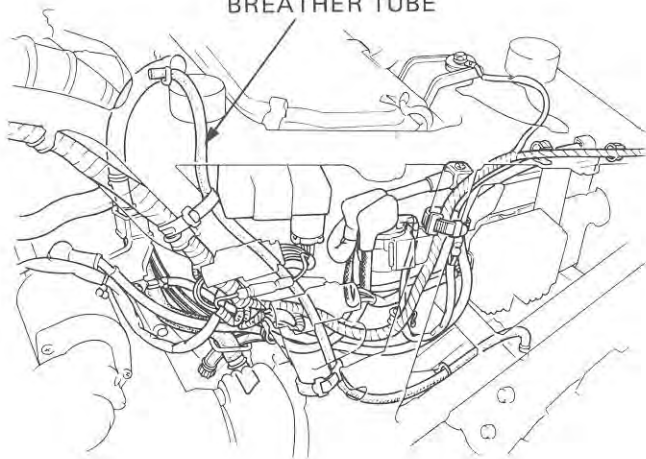

AFTER '85:

FINAL GEAR CASE BREATHING TUBE

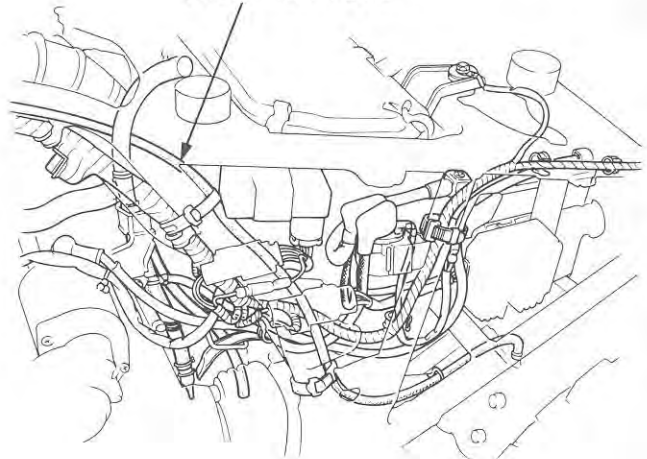

'85:

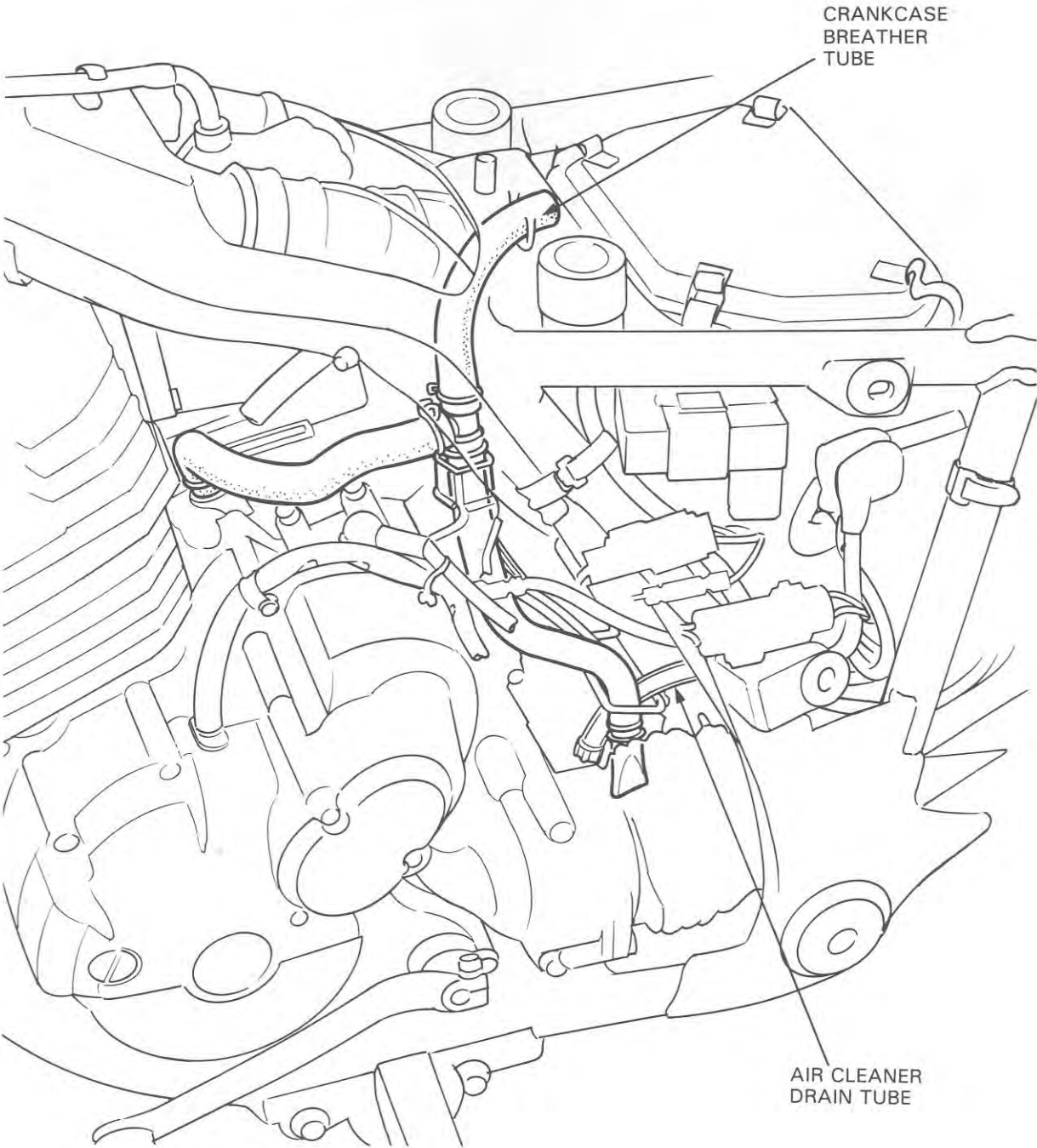

AFTER '85:

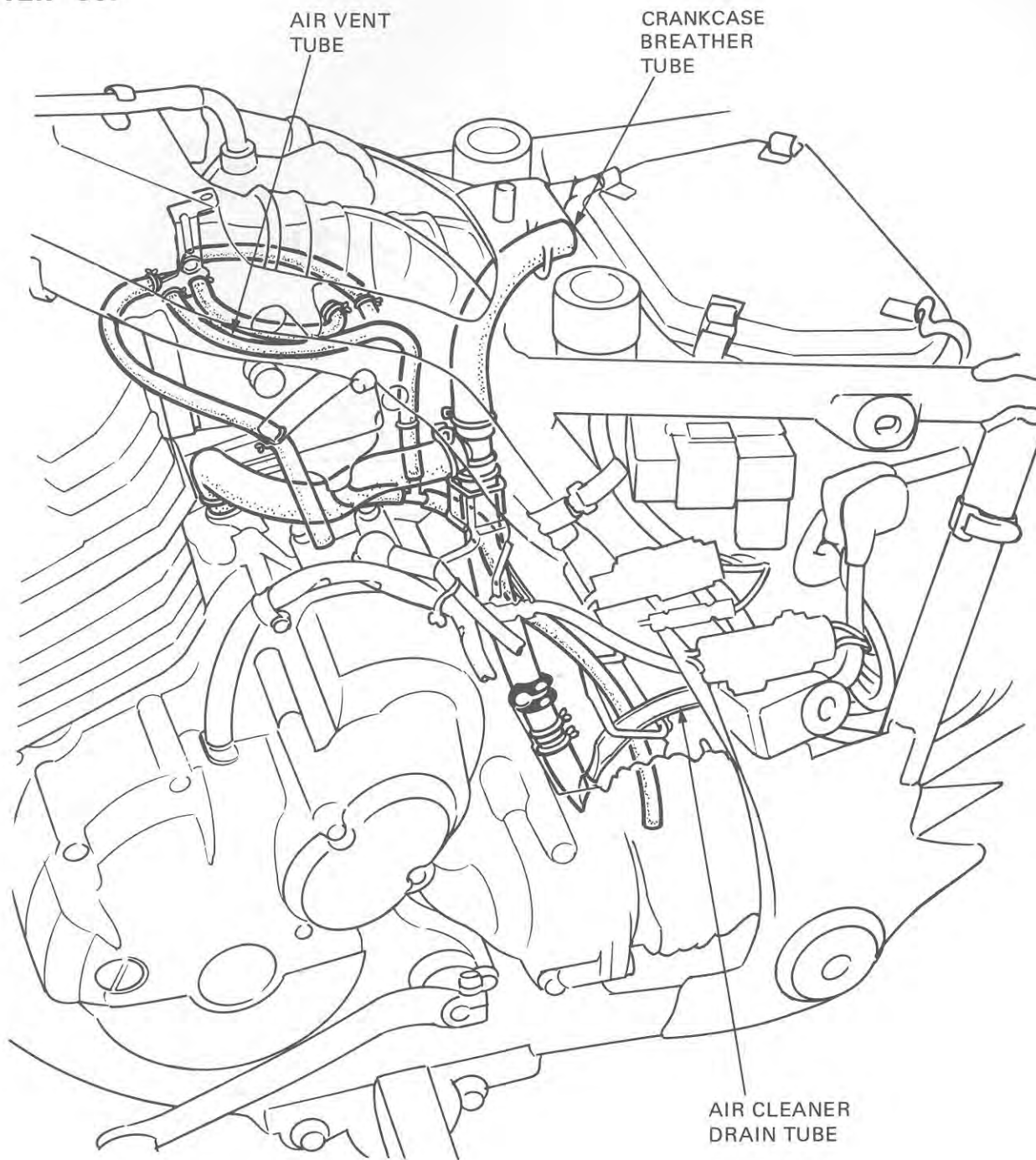

NOISE EMISSION CONTROL SYSTEM

The U.S. Environmental Protection Agency requires manufacturers to certify that vehicles built after January 1, 1983 will comply with applicable noise emission standards for one year or 1,865 miles (3,000 km) after the time of sale to the ultimate purchaser, when operated and maintained according to the instructions provided. Compliance with the terms of the Distributor's Warranty for the Honda Vehicle Noise Emission Control System is necessary in order to keep the noise emission control system in effect.

TAMPERING WITH THE NOISE CONTROL SYSTEM IS PROHIBITED: Federal law prohibits the following acts or the causing thereof: (1) The removal or rendering inoperative by any person, other than for purposes of maintenance, repair, or replacement, of any device or element of design incorporated into any new vehicle for the purpose of noise control prior to its sale or delivery to the ultimate purchaser or while it is in use; or (2) the use of the vehicle after such device or element of design has been removed or rendered inoperative by any person.

AMONG THOSE ACTS PRESUMED TO CONSTITUTE TAMPERING ARE THE ACTS LISTED BELOW:

1. Removal of, or puncturing the muffler, baffler, header pipes or any other component which conducts exhaust gases.
2. Removal of, or puncturing of any parts of the intake system.
3. Lack of proper maintenance.
4. Replacing any moving parts of the vehicle, or parts of the exhaust or intake system, with parts other than those specified by the manufacturer.



2. LUBRICATION

SERVICE INFORMATION	2-1
TROUBLESHOOTING	2-1
ENGINE OIL LEVEL	2-2
ENGINE OIL & FILTER CHANGE	2-2
FINAL DRIVE OIL	2-3
LUBRICATION POINTS	2-4

SERVICE INFORMATION

GENERAL

- Section 8 shows how to service the oil pump.

SPECIFICATIONS

Engine oil capacity	2.5 liters (2.6 US qt, 2.2 Imp qt) after disassembly 2.1 liter (2.2 US qt, 1.8 Imp qt) after draining
Engine oil recommendation	Use Honda 4-stroke oil or equivalent. API Service Classification: SE or SF Viscosity: SAE 10W-40 Other viscosities shown in the chart may be used when the average temperature in your riding area is within the indicated range.
Final drive oil capacity	100 cc (3.4 oz)
Final drive oil recommendation	Hypoid gear oil SAE #80

TORQUE VALUES

Engine drain plug	20-30 N·m (2.0-3.0 kg-m, 14-22 ft-lb)
Gear case drain bolt	10-14 N·m (1.0-1.4 kg-m, 7-10 ft-lb)
Gear case filler bolt	10-14 N·m (1.0-1.4 kg-m, 7-10 ft-lb)

TROUBLESHOOTING

Oil level too low - high oil consumption

1. Normal oil consumption
2. External oil leaks
3. Worn piston rings
4. Oil not changed often enough
5. Faulty head gasket

Oil contamination

1. Oil or filter not changed often enough.
2. Head gasket faulty.
3. Worn piston rings.

OIL VISCOSITIES

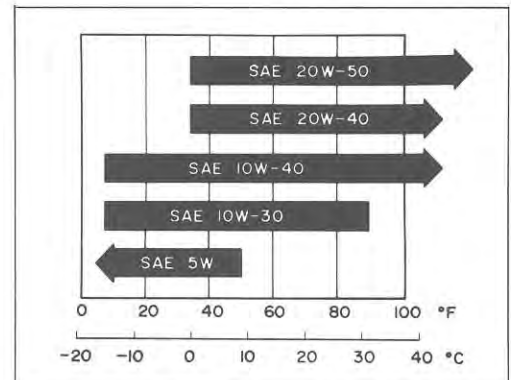

LUBRICATION

ENGINE OIL LEVEL

Place the ATC on level ground.
Check the oil level with the oil filler cap/dipstick.
Do not screw it in when making this check.

If the oil level is below or near the lower level mark on the dipstick, add the recommended oil (page 2-1) up to the upper level line.

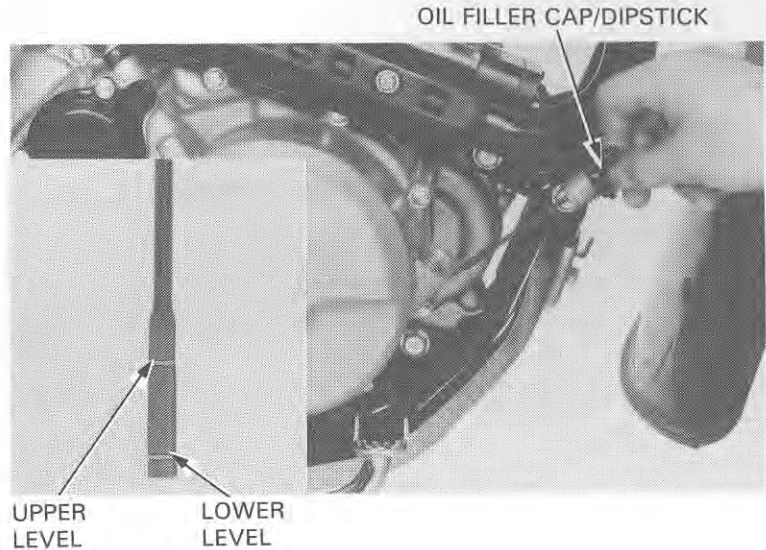

ENGINE OIL & FILTER CHANGE

NOTE

Change engine oil with the engine warm and the ATC on level ground to assure complete draining.

Remove the oil filler cap and drain plug.

Remove the three bolts attaching the oil filter cover, oil filter and spring.
Discard the oil filter.

Check that the sealing washer on the drain plug is in good condition and install the drain plug.

TORQUE: 20–30 N·m (2.0–3.0 kg·m, 14–22 ft·lb)

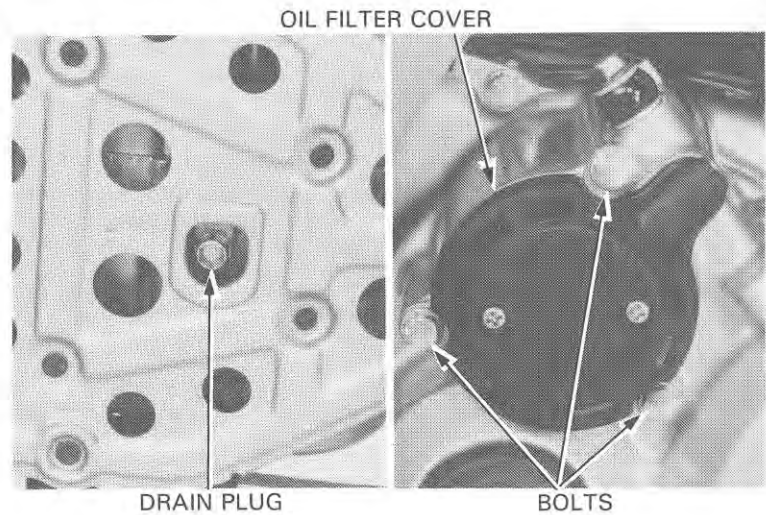

Make sure that the oil filter cover O-ring is in good condition, and coat it with oil before installing it.

Install the oil filter spring, filter and cover using the three bolts.

Fill the crankcase with 2.1 liters (2.2 US qt, 1.8 Imp qt) of the recommended oil (page 2-1).
Install the oil filler cap/dipstick.
Start the engine and let it idle for 2-3 minutes.

Stop the engine and check that the oil level is at the upper level line on the dipstick. Make sure there are no oil leaks.

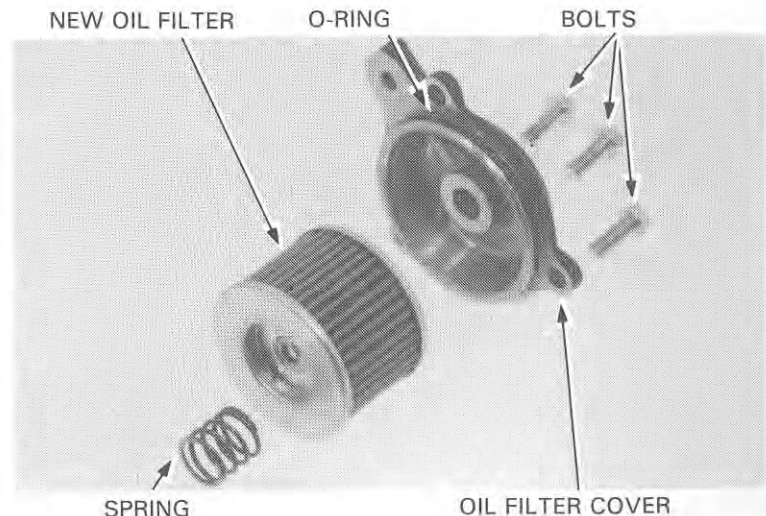

FINAL DRIVE OIL

CHECK

Remove the oil filler cap.

Place a support block under the engine. (The front and rear axles should be in the same plane.) Check that the oil level reaches the lower edge of the oil filler cap hole.

Check for leaks. If the level is low, pour fresh oil through the oil filler hole until it reaches the lower edge.

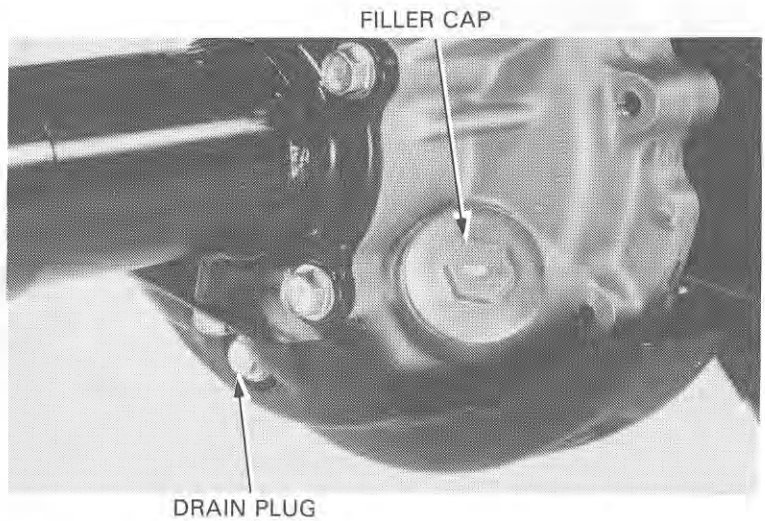

CHANGE

Remove the oil filler cap.

Remove the drain bolt to drain all oil from the final gear case.

Install the drain bolt securely.

Fill the gear case with the recommended oil up to the correct level.

OIL CAPACITY: 100 cc (3.4 US oz)

RECOMMENDED OIL: Hypoid gear oil SAE #80

TORQUE:

DRAIN BOLT: 10–14 N·m (1.0–1.4 kg-m,
7–10 ft-lb)

FILLER CAP: 10–14 N·m (1.0–1.4 kg-m,
7–10 ft-lb)

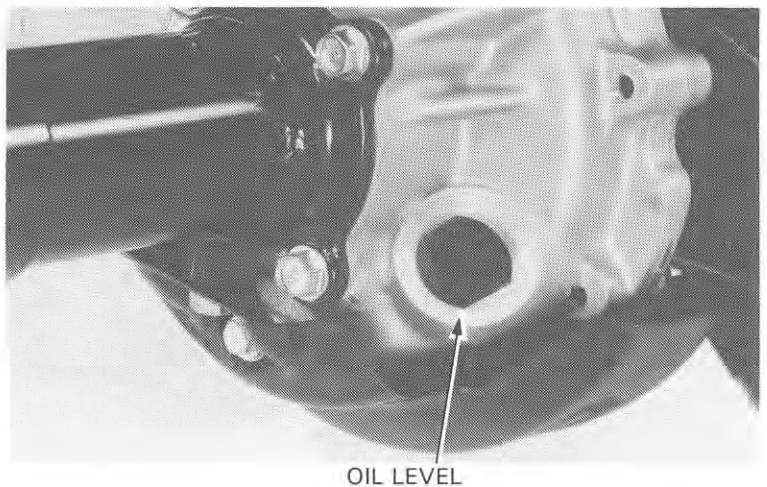

LUBRICATION

LUBRICATION POINTS

Use general purpose grease when no other specification is given. Apply oil or grease to any 2 sliding surfaces and cables not shown here.

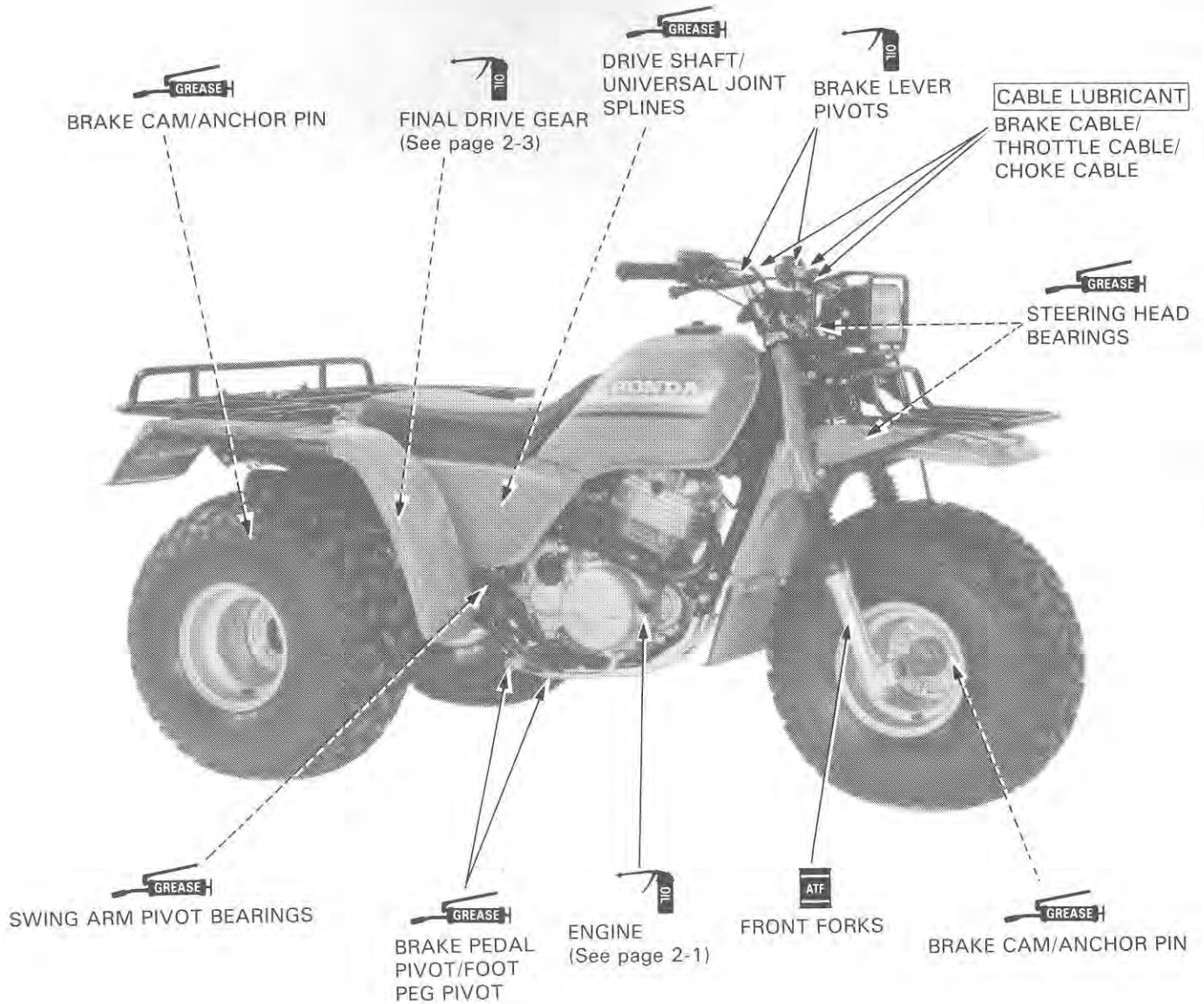

3. MAINTENANCE

SERVICE INFORMATION	3-1	BRAKE SHOES	3-9
MAINTENANCE SCHEDULE	3-2	BRAKE CONTROL LINKAGE	3-9
AIR CLEANER	3-4	CLUTCH	3-11
SPARK PLUG	3-5	SUSPENSION	3-12
BREATHER TUBE	3-5	SPARK ARRESTER	3-12
VALVE CLEARANCE	3-5	REVERSE LOCK SYSTEM	3-13
CARBURETOR IDLE SPEED	3-6	LIGHTING EQUIPMENT	3-13
FUEL LINE	3-7	TIRES	3-14
FUEL STRAINER	3-7	STEERING HEAD BEARINGS	3-14
THROTTLE OPERATION	3-8	NUTS, BOLTS, FASTENERS	3-14
CYLINDER COMPRESSION	3-8	ENGINE UNDER GUARD AND SKID PLATE	3-14

SERVICE INFORMATION

SPECIFICATION

Spark plug gap:	0.6–0.7 mm (0.024–0.028 in)
Recommended spark plugs:	DR8ES-L (NGK) X24ESR-U (ND)
Valve clearance:	Intake: 0.08 mm (0.003 in) Exhaust: 0.08 mm (0.003 in)
Idle speed:	1,400 ± 100 rpm
Throttle lever free play	3–8 mm (1/8–1/4 in)
Cylinder compression:	12–13 kg/cm ² (170–185 psi)
Front brake lever free play:	15–20 mm (5/8–3/4 in)
Rear (parking) brake lever free play:	15–20 mm (5/8–3/4 in)
Rear brake pedal free play:	15–20 mm (5/8–3/4 in)
Reverse selector lever free play:	2–4 mm (1/16–1/8 in)
Front tire size:	25 x 12.00–9
Rear tire size:	25 x 12.00–9
Recommended tire pressure:	Front: 0.15 kg/cm ² (2.2 psi) Rear: 0.15 kg/cm ² (2.2 psi)
Standard tire circumference:	Front: 1,915 mm (75.4 in) Rear: 1,915 mm (75.4 in)

TORQUE VALUES

Clutch adjusting screw lock nut	18–25 N·m (1.8–2.5 kg-m, 13–18 ft-lb)
Valve adjusting lock nut	15–18 N·m (1.5–1.8 kg-m, 11–13 ft-lb)

TOOLS

Common

Valve adjusting wrench, 10 x 12 mm	07708–0030200	Commercially available in U.S.A.
'85: valve adjusting wrench A	07708–0030300	
After '85: valve adjusting wrench B	07708–0030400	

MAINTENANCE

MAINTENANCE SCHEDULE

'85:

- The maintenance intervals shown in the following schedule are based upon average riding conditions. ATCs subjected to severe use, or ridden in wet or unusually dusty areas, require more frequent servicing. Items marked * should be serviced by an authorized Honda dealer, unless the owner has the proper tools and is mechanically proficient. Other maintenance items are simple to perform and may be serviced by the owner. Perform the Pre-ride Inspection in the Owner's Manual at every maintenance period.

I: Inspect and clean, adjust, lubricate or replace, if necessary.

C: Clean

R: Replace

A: Adjust

ITEM	FREQUENCY	INITIAL SERVICE PERIOD (First week of operation)	REGULAR SERVICE PERIOD (Every 30 operating days)	Refer to page
ENGINE OIL	(NOTE 1,2)	R	R	2-1
ENGINE OIL FILTER		R	R	2-2
AIR CLEANER ELEMENT	(NOTE 2)		C	3-4
SPARK PLUG			I	3-5
BREATHER TUBE			I	3-5
* VALVE CLEARANCE		I	I	3-5
* CARBURETOR		I	I	3-6
FUEL LINE		I: (EVERY YEAR)		3-7
* FUEL STRAINER		C	C	3-7
THROTTLE OPERATION		I	I	3-7
FINAL DRIVE OIL		I: (EVERY YEAR), R: (EVERY 2 YEARS)		2-3
* BRAKE SHOES		I: (EVERY YEAR)		3-9
BRAKE CONTROL LINKAGE		I	I	3-9
* CLUTCH		A	A	3-11
* SPARK ARRESTER			C	3-11
REVERSE LOCK MECHANISM		I	I	3-12
ALL NUTS, BOLTS, FASTENERS		I	I	3-12
LIGHTING EQUIPMENT		I	I	3-12
TIRES		I	I	3-13
* STEERING HEAD BEARINGS		A: (EVERY YEAR)		3-14

- NOTES: 1. Replace every 30 operating days or every 3 months, whichever comes first.
2. Service more frequently when riding in dusty areas.

AFTER '85:

The maintenance intervals shown in the following schedule are based upon average riding conditions. ATCs subjected to severe use, or ridden in wet or unusually dusty areas, require more frequent servicing. Items marked * should be serviced by an authorized Honda dealer, unless the owner has the proper tools and is mechanically proficient. Other maintenance items are simple to perform and may be serviced by the owner. Perform the Pre-ride Inspection in the Owner's Manual at every maintenance period. ** In the interest of safety, we recommend these items be serviced only by an authorized Honda dealer.

I: Inspect and clean, adjust, lubricate or replace, if necessary.

C: Clean

R: Replace

A: Adjust

		EVERY	INITIAL SERVICE PERIOD (First week of operation)	REGULAR SERVICE PERIOD (Every 30 operating days)	Refer to page
*	FUEL LINE	YEAR: I			3-7
*	FUEL STRAINER SCREEN	YEAR: C			3-7
*	THROTTLE OPERATION		I	I	3-8
*	CARBURETOR CHOKE			I	4-5
	AIR CLEANER	(NOTE 2)		C	3-4
	AIR CLEANER CASE DRAIN TUBE	(NOTE 3)		I	3-5
	SPARK PLUG			I	3-5
*	VALVE CLEARANCE		I	I	3-5
	ENGINE OIL		R	R	2-2
	ENGINE OIL FILTER		R	R	2-2
*	CARBURETOR IDLE SPEED		I	I	3-6
	FINAL DRIVE OIL	YEAR: I 2 YEARS: R			2-3
*	BRAKE SHOE WEAR	YEAR: I (NOTE 3)			3-9
	BRAKE SYSTEM		I	I	3-10
*	REVERSE LOCK SYSTEM		I	I	3-13
*	CLUTCH SYSTEM		I	I	3-11
*	SUSPENSION			I	3-12
*	SPARK ARRESTER	(NOTE 1)		C	3-12
*	NUT, BOLT, FASTENER		I	I	3-14
**	WHEELS		I	I	3-14
**	STEERING HEAD BEARING	YEAR: I			3-14
	ENGINE UNDER GUAD AND SKID PLATE	(NOTE 4)		I	3-14

NOTES: 1. USA only.

2. Service more frequently when riding in dusty areas, sand or snow.

3. Service more frequently after riding in very wet or muddy conditions.

4. After '86 models only.

MAINTENANCE

AIR CLEANER

Remove the seat by pulling the seat latch lever.
Release the retaining clips holding the air cleaner case cover.
Remove the air cleaner case cover.

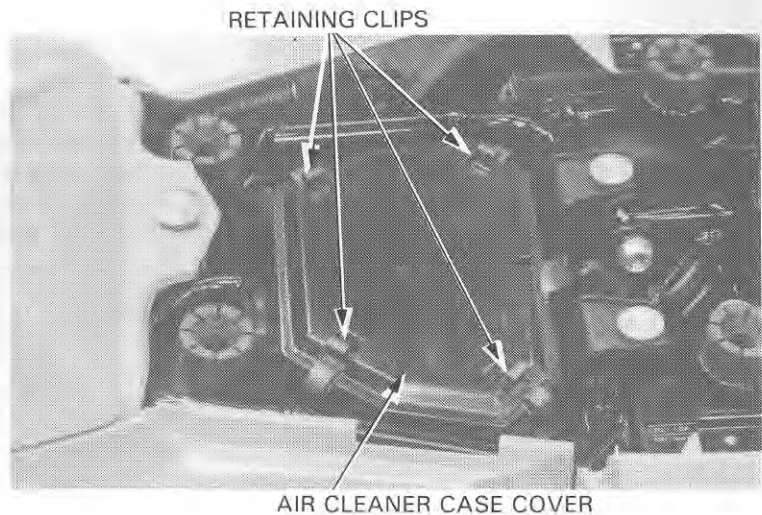

Loosen the air cleaner element band screw.
Remove the element holder attaching screw and remove the air cleaner element assembly from the case.

Remove the element holder by turning it counterclockwise.
Remove the element band and remove the element from the element core.

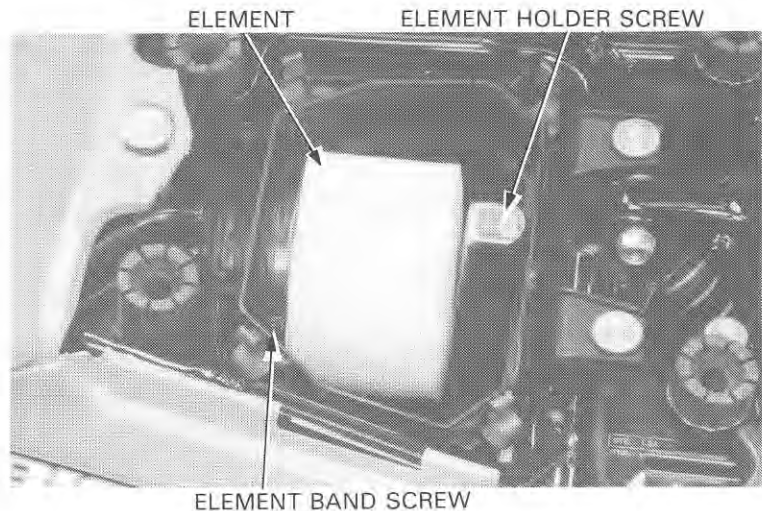

Wash the element in non-flammable or high flash point solvent, squeeze out the solvent thoroughly, and allow to dry.

Soak the element in gear oil (SAE 80–90) and squeeze out excess.
Place the element onto the element core and replace the element band and holder.

Install the element in the air cleaner case.
Install the air cleaner case cover and clips.
Install the seat.

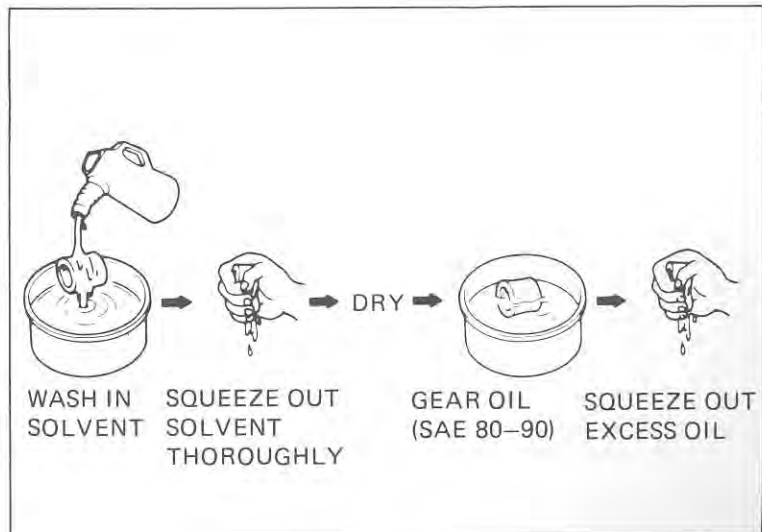

SPARK PLUG

Disconnect the spark plug cap and remove the spark plug.

Visually inspect the spark plug electrodes for wear. The center electrode should have square edges and the side electrode should have a constant thickness. Discard the spark plug if there is apparent wear or if the insulator is cracked or chipped. Measure the gap with a wire-type feeler gauge and adjust by carefully bending the side electrode.

SPARK PLUG GAP:

0.6–0.7 mm (0.024–0.028 in)

RECOMMENDED REPLACEMENT PLUG:

DR8ES–L (NGK)
X24ESR–U (ND)

Check the sealing washer and replace with a new one if damaged.

With the sealing washer attached, thread the spark plug in by hand to prevent cross-threading. Tighten the spark plug another 1/2 turn with a spark plug wrench to compress the sealing washer.

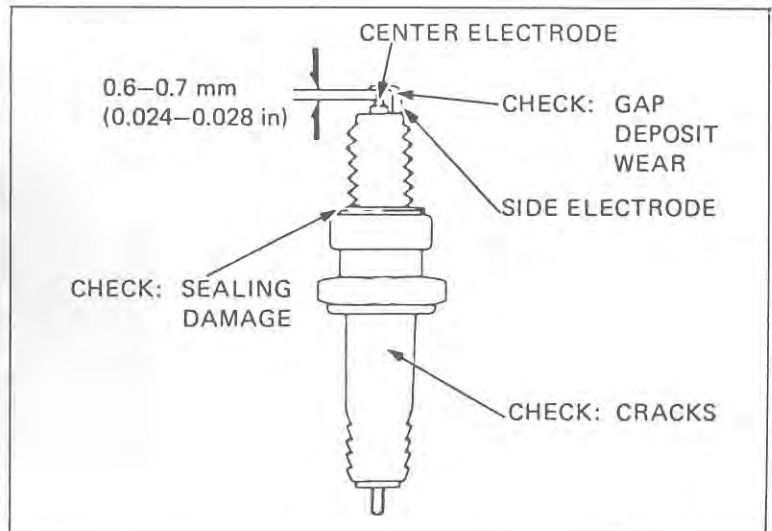

BREATHER TUBE

Remove the tube from the drain tube to empty any deposits.

Install the drain tube.

NOTE

Service more frequently when riding in rain or at full throttle, or if the deposit level can be seen in the transparent section of the drain tube.

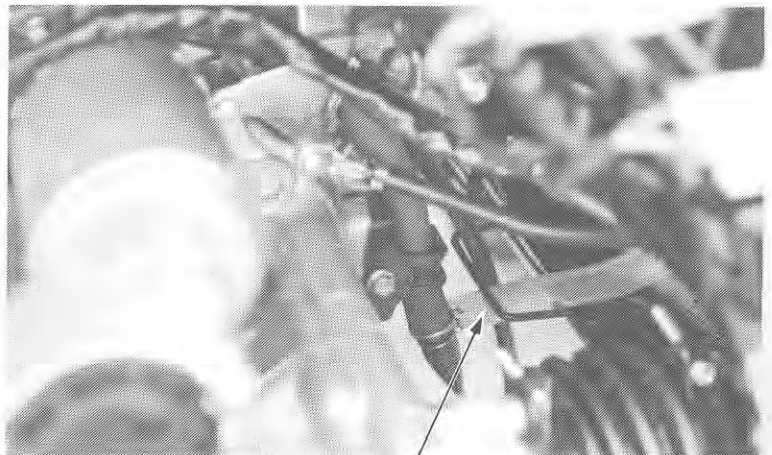

VALVE CLEARANCE

NOTE

Inspect and adjust valve clearance while the engine is cold (below 35°C/95°F).

Remove the frame side covers, seat and fuel tank. Remove the timing hole cap and rotor cap. Remove the valve adjusting covers.

Rotate the crankshaft clockwise and align the "T" mark in the rotor with the index mark. The piston must be at TDC on the compression stroke.

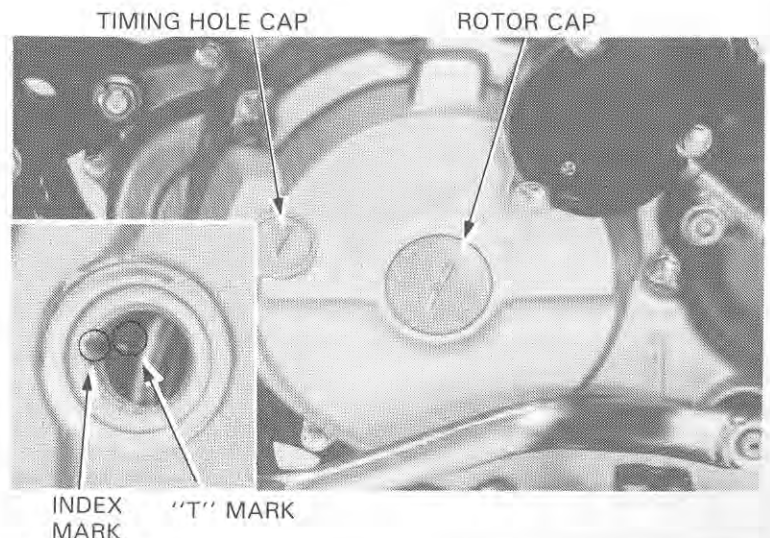

MAINTENANCE

Inspect the intake and exhaust valve clearances by inserting the feeler gauge between the adjusting screw and valve stem.

VALVE CLEARANCES

Intake: 0.08 mm (0.003 in)

Exhaust: 0.08 mm (0.003 in)

Adjust by loosening the lock nut and turning the adjusting screw until there is a slight drag on the feeler gauge.

Hold the adjusting screw and tighten the lock nut.

Recheck the valve clearance and install the valve adjuster covers.

Install the rotor cap and timing hole cap.

Install the fuel tank, seat and frame side covers.

'85:

ADJUSTING SCREW LOCK NUT

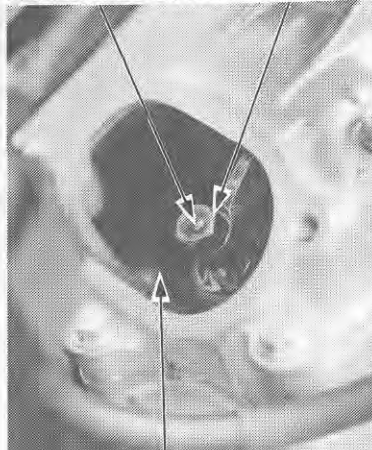

FEELER GAUGE

AFTER '85:

ADJUSTING SCREW LOCK NUT

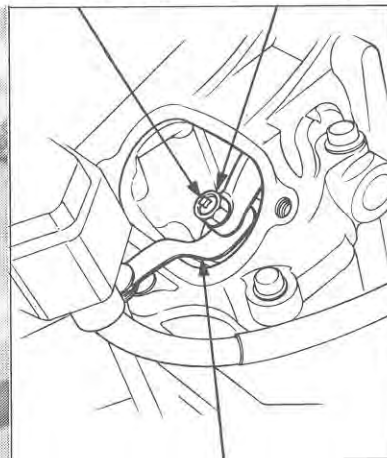

FEELER GAUGE

'85:

VALVE ADJUSTING WRENCH,
10 x 12 mm 07708-0030200
COMMERCIALY AVAILABLE
IN U.S.A.

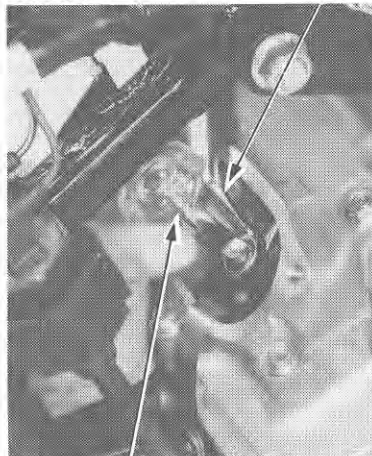

VALVE ADJUSTING WRENCH A
07708-0030300

AFTER '85:

VALVE ADJUSTING WRENCH
10 x 12 mm, 07708-0030200
COMMERCIALY AVAILABLE
IN U.S.A.

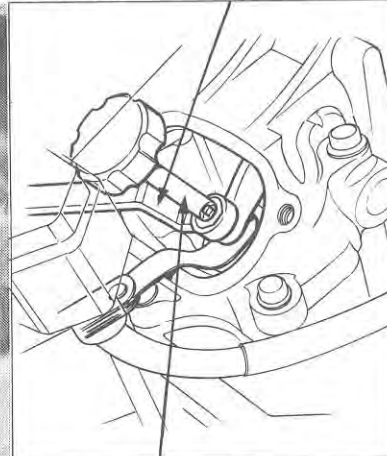

VALVE ADJUSTING WRENCH B
07708-0030400

CARBURETOR IDLE SPEED

NOTE

- Inspect and adjust the idle speed after all other maintenance items have been performed and are within specifications.
- The engine must be warm for accurate idle speed inspection and adjustment.

Warm up the engine for about ten minutes. Turn the throttle stop screw as required to obtain the specified idle speed.

IDLE SPEED: 1,400 ± 100 rpm



THROTTLE STOP SCREW

FUEL LINE

Remove the left frame side cover and check the fuel line.

Replace any parts which show signs of deterioration, damage or leaks.

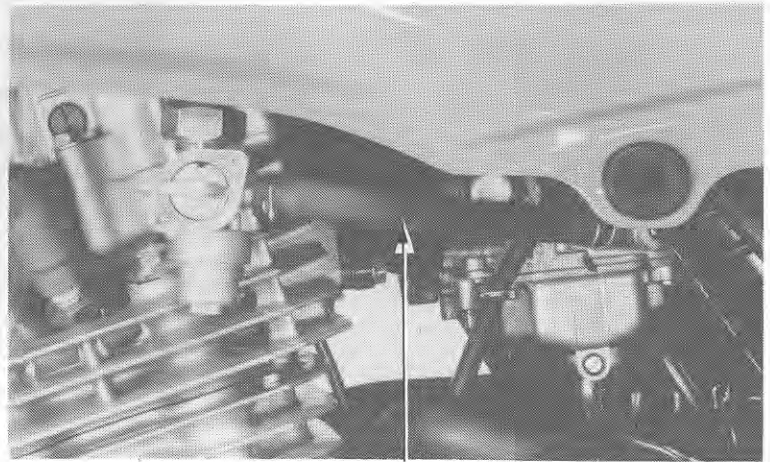

FUEL LINE

FUEL STRAINER

Turn the fuel valve OFF.

Remove the fuel cup, O-ring and filter screen, and drain the gasoline into a suitable container.

WARNING

Gasoline is flammable and is explosive under certain conditions. Do not smoke or allow flames or sparks near the equipment while draining fuel.

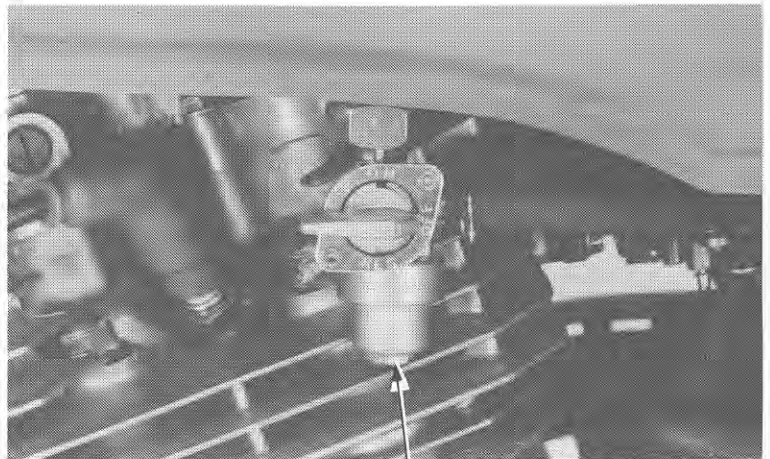

FUEL CUP

Wash the cup and filter screen in clean non-flammable or high flash point solvent.

Reinstall the screen, aligning the index marks on the fuel valve body and filter screen.

Install a new O-ring into the fuel valve body.

Reinstall the fuel cup, making sure the new O-ring is in place.

Tighten the fuel cup.

CAUTION

Do not overtighten the fuel cup.

After installing, turn the fuel valve ON and check that there are no fuel leaks.

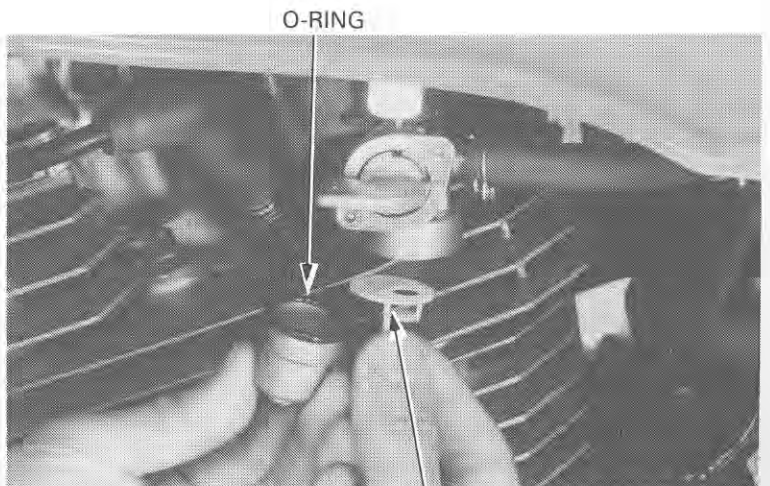

FILTER SCREEN

THROTTLE OPERATION

Check for smooth throttle lever full opening and automatic full closing in all steering positions. Make sure there is no deterioration, damage or kinking in the throttle cable. Replace any damaged parts. Disconnect the throttle cable at the upper end. Thoroughly lubricate the cable and pivot point with a commercially available cable lubricant to prevent premature wear.

Install the throttle cable in the reverse order of removal.

Make sure the throttle lever free play is 3–8 mm (1/8–1/4 in) at the tip of the throttle lever.

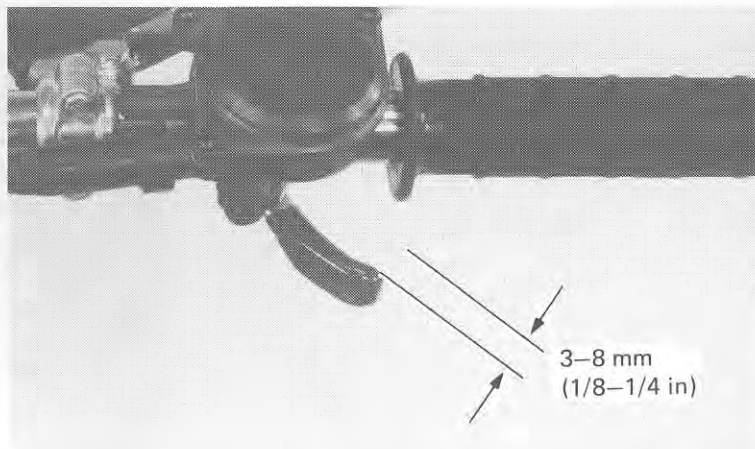

Adjust as follows:

Slide the rubber boot off the cable adjuster.

Loosen the lock nut and adjust the throttle cable free play by turning the cable adjuster.

Tighten the lock nut and install the rubber boot securely.

CYLINDER COMPRESSION

Warm up the engine to normal operating temperature. Stop the engine and remove the spark plug.

Insert the compression gauge. Open the throttle all the way and crank the engine with the starter motor. Crank the engine until the gauge reading stops rising. The maximum reading is usually reached within 4-7 seconds.

COMPRESSION PRESSURE:

12–13 kg/cm² (170–185 psi)

If compression is low, check for the following:

- Improper valve adjustment
- Valve leakage
- Cylinder head gasket leaking
- Worn piston ring or cylinder

If compression is high, it indicates that carbon deposits have accumulated on the combustion chamber and/or the piston crown.

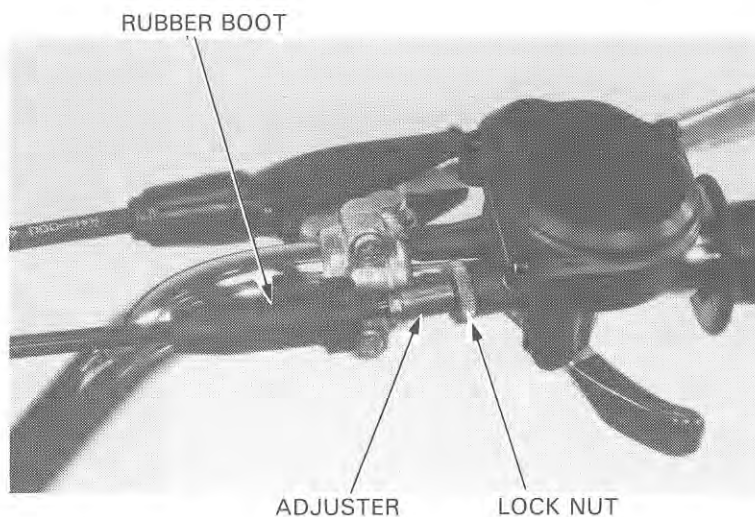

COMPRESSION GAUGE, COMMERCIALLY AVAILABLE IN U.S.A.

BRAKE SHOES

Replace the brake shoes if the indicator plate aligns with the brake index mark when the front brake lever, rear brake lever or pedal is applied.

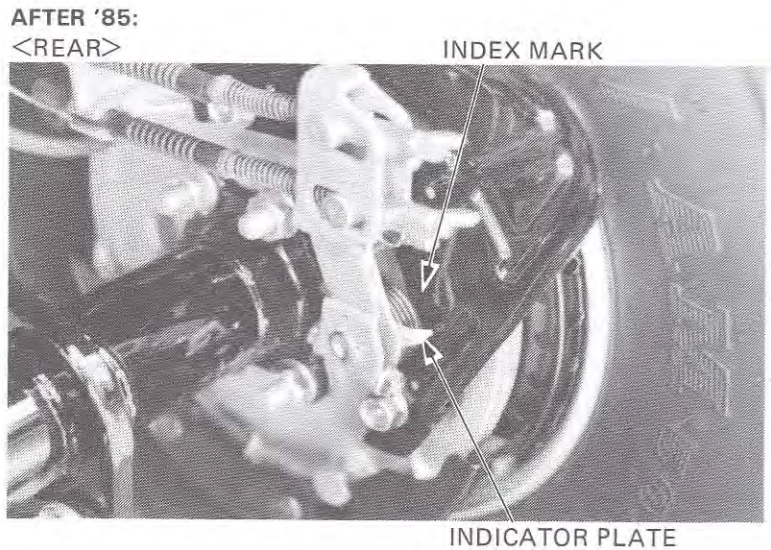
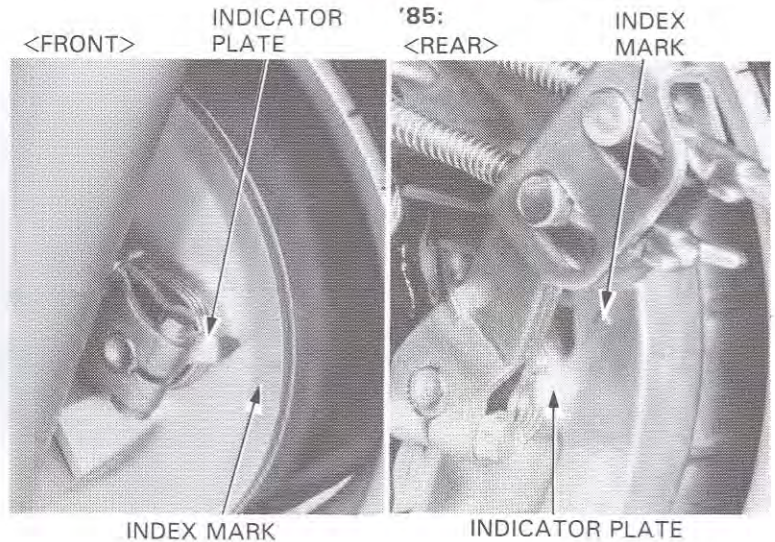

BRAKE CONTROL LINKAGE

FRONT BRAKE

Check the cable and brake lever for loose connections, excessive play, or other damage. Replace or repair if necessary.

Disconnect the brake cable at the upper end. Thoroughly lubricate the cable and pivot point with a commercially available cable lubricant to prevent premature wear.

Install the brake cable.

Measure the front brake lever free play at the end of the brake lever.

FRONT BRAKE LEVER FREE PLAY:

15–20 mm (5/8–3/4 in)

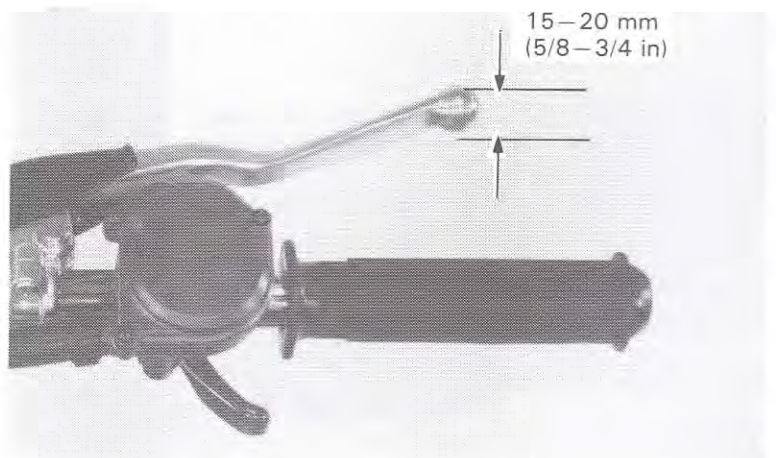

MAINTENANCE

Minor adjustments can be made with the upper adjuster on the front brake lever. Slide the rubber cover off the adjuster, loosen the lock nut and adjust.

Major adjustments should be made with the lower adjusting nut. Adjust to the specified free play. After adjustment, make sure that the cut-out of the adjusting nut is seated on the brake arm pin.

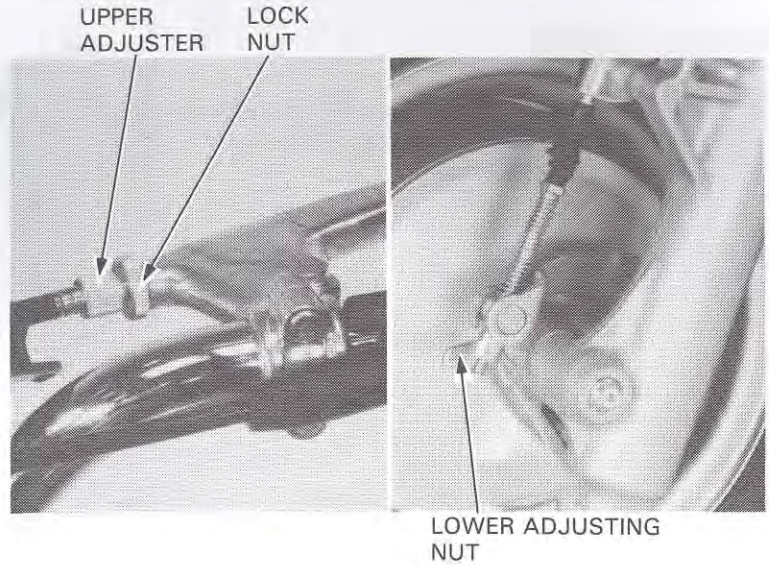

REAR BRAKE

Check the cable, brake lever and brake pedal for loose connections, excessive play, or other damage.

Replace or repair if necessary.

Disconnect the brake cables at the brake lever or pedal ends.

Thoroughly lubricate the cables and their pivot point with a commercially available cable lubricant to prevent premature wear.

Install the cables.

Measure the rear brake lever (parking brake) free play at the end of the brake lever.

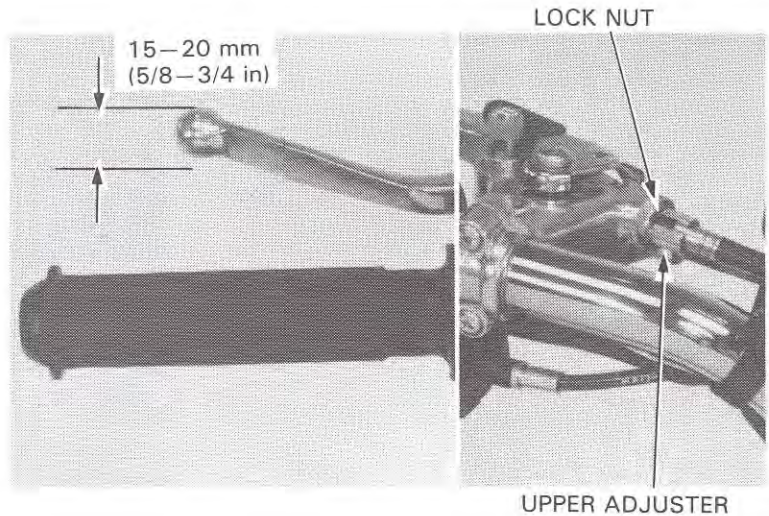

REAR BRAKE LEVER FREE PLAY:

15-20 mm (5/8-3/4 in)

Minor adjustments can be made with the upper adjuster. Slide the rubber cover off the adjuster, loosen the lock nut and adjust.

Major adjustments should be made with the lower adjusting nut at the rear brake arm.

Measure the brake pedal free play at the end of the brake pedal and adjust as above.

BRAKE PEDAL FREE PLAY:

15-20 mm (5/8-3/4 in)

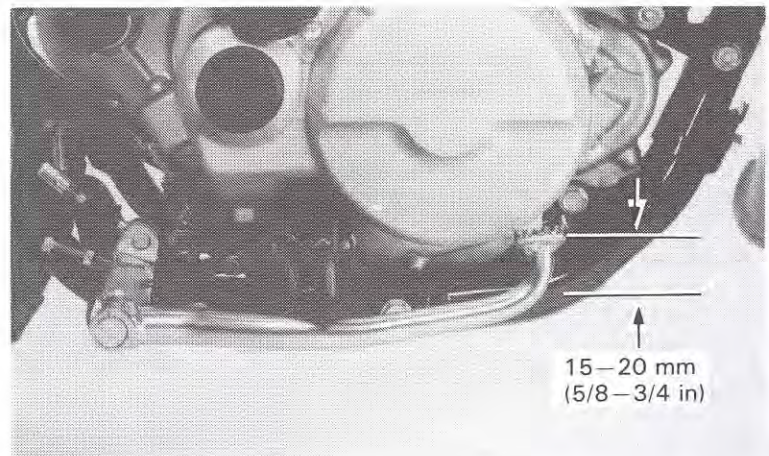

NOTE

Make sure the cut-out of each adjusting nut is seated on the brake arm pin.

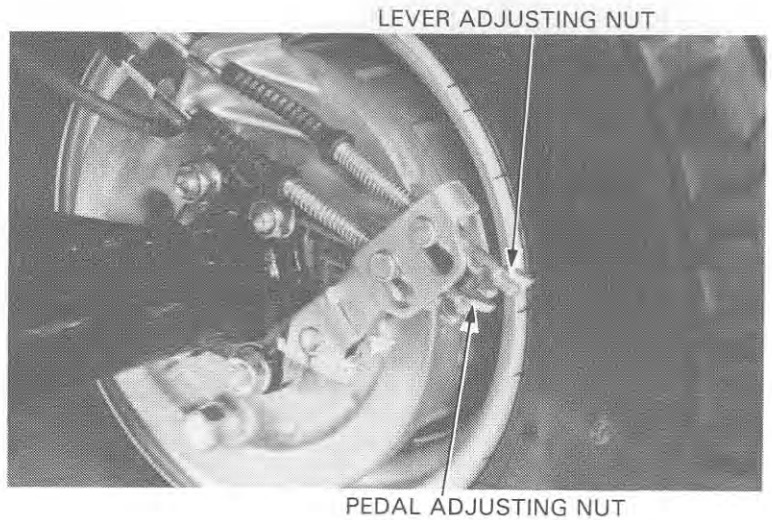

REAR BRAKE PEDAL HEIGHT

Loosen the lock nut and adjust the pedal height by turning the stopper bolt. Tighten the lock nut securely. After adjustment, check the rear brake pedal free play and adjust if necessary.

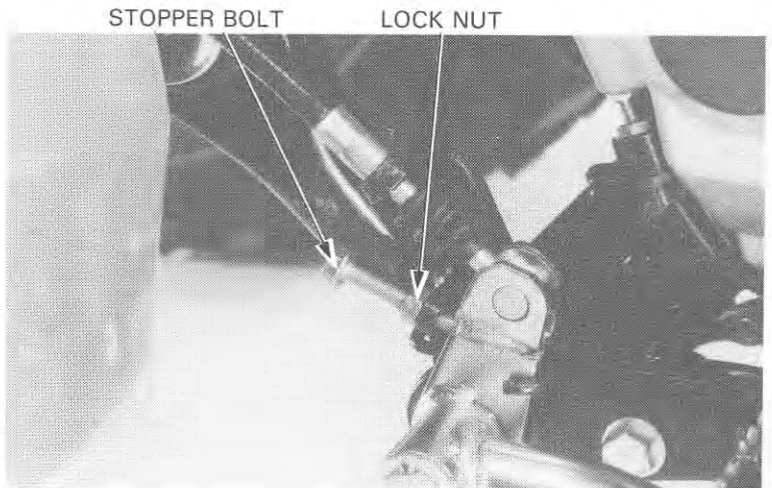

CLUTCH

Stop the engine.
Remove the adjusting screw cap.
Loosen the clutch adjusting screw lock nut.

Slowly turn the adjusting screw counterclockwise until resistance is felt.

Then turn the adjusting screw clockwise 1/4 turn, and tighten the lock nut.

TORQUE: 18–25 N·m
(1.8–2.5 kg·m, 13–18 ft·lb)

Install the cap over the adjusting screw.
After adjustment, start the engine and check for proper clutch operation.

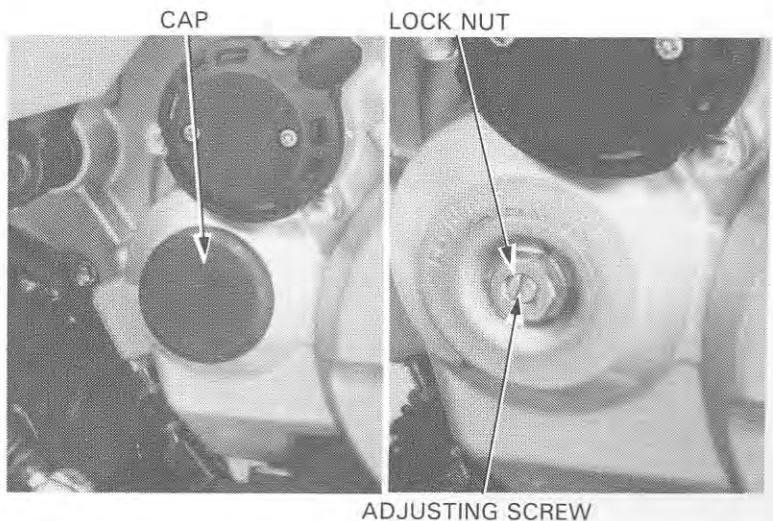

MAINTENANCE

AFTER '85 SUSPENSION

WARNING

- *Do not ride a vehicle with faulty suspension. Loose, worn or damaged suspension parts may impair vehicle stability and control.*

Check the front and rear suspensions for leaks by compressing them several times.

Check the front and rear suspensions for leaks or damage. Replace damaged components which cannot be repaired.

Tighten all nuts and bolts.

FRONT



REAR

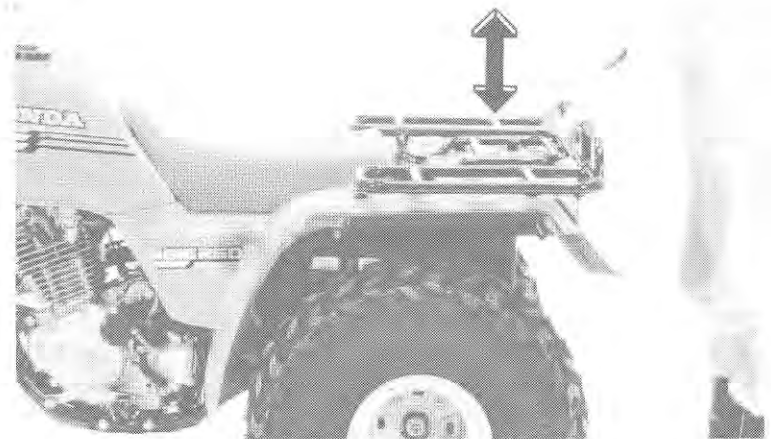

SPARK ARRESTER CLEANING

WARNING

- *Do not touch the exhaust components while the exhaust system is hot.*
- *Perform this operation in a well-ventilated area, free from fire hazard.*
- *Use adequate eye protection.*

Remove the drain hole cover.

Start the engine with the transmission in neutral, and purge accumulated carbon from the spark arrester system by momentarily revving the engine several times.

Stop the engine and allow the exhaust system to cool. Install the drain hole cover.

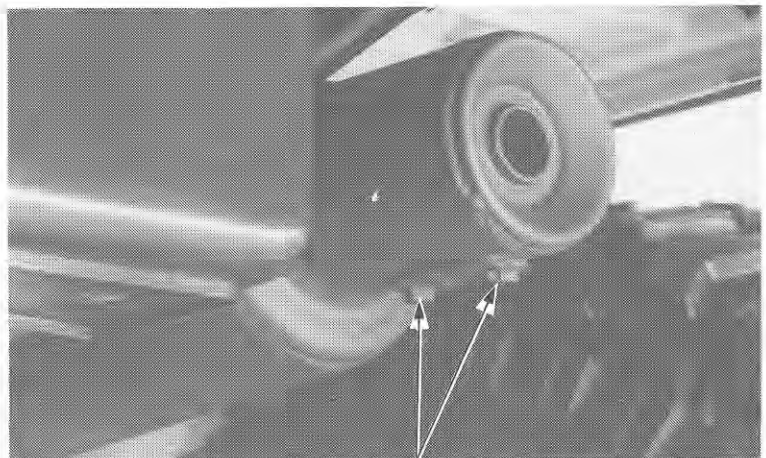

DRAIN HOLE COVER BOLTS

REVERSE LOCK SYSTEM

Check the reverse selector cable and lever for loose connection, excessive play, or other damage. Replace or repair if necessary.

Measure the reverse selector lever free play at the lever end of the cable side.

FREE PLAY: 2–4 mm (1/16–1/8)

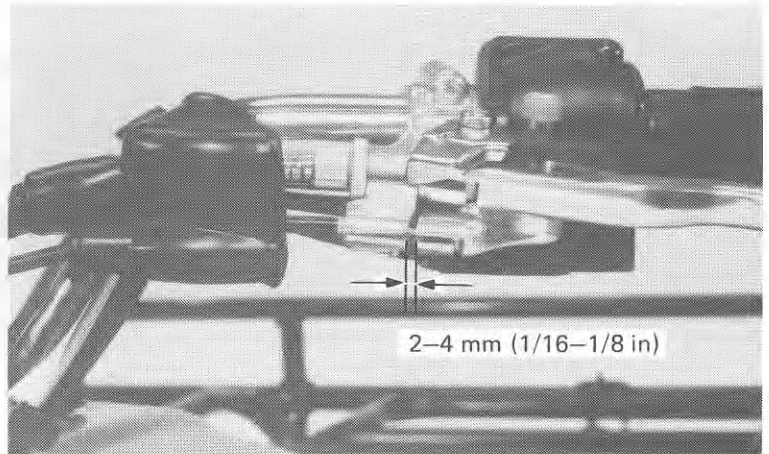

Adjust by loosening the lock nut and turning the adjusting nut. Tighten the lock nut securely.

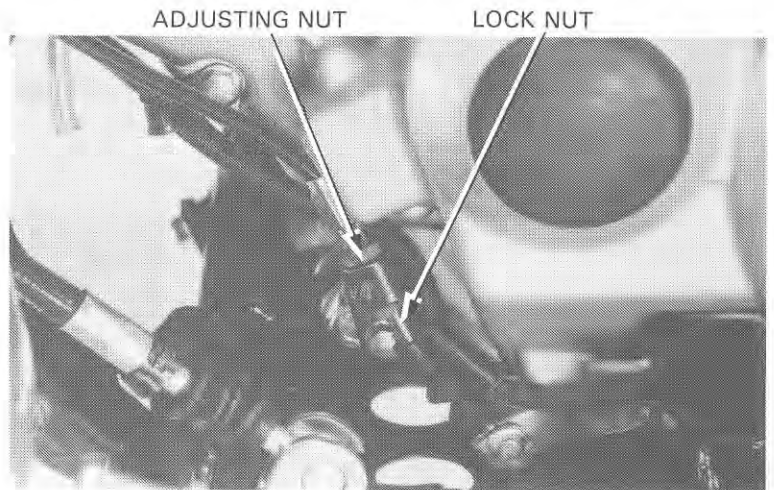

LIGHTING EQUIPMENT

Turn the ignition switch ON. Check the headlight and taillight by operating the lighting switch and dimmer switch.

Position		Function
OFF		Headlight and taillight are OFF.
ON	LO	Headlight low beam and taillight should be ON.
	HI	Headlight high beam and taillight should be ON.

If the light does not work properly, check the bulbs and refer to page 17-5 to test the switch if necessary.

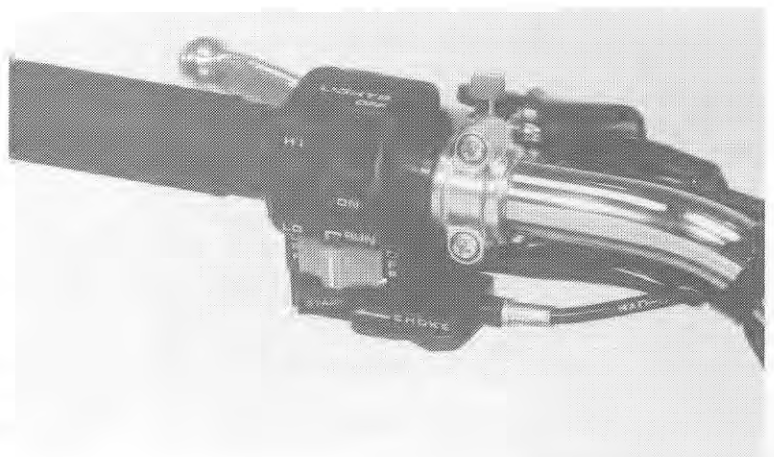

MAINTENANCE

TIRES

Check the tires for cuts, imbedded objects, or other damage.

NOTE

Tire pressure should be checked when the tires are COLD.

Check the tire pressures.

TIRE PRESSURES: 2.2 psi (15 kPa, 0.15 kg/cm²)

**STANDARD TIRE CIRCUMFERENCE:
1,915 mm (75.4 in)**

NOTE

Raise the wheels off the ground when measuring tire circumferences.

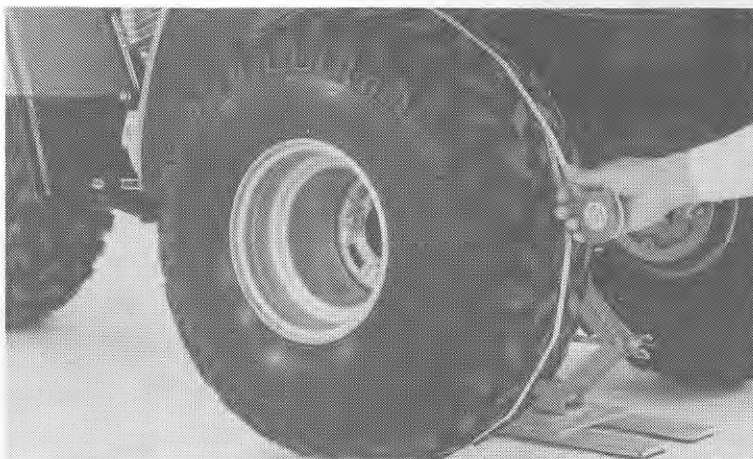

STEERING HEAD BEARINGS

NOTE

Make sure the cables do not interfere with the rotation of the handlebar.

Raise the front wheel off the ground and make sure that the handlebar rotates freely.

If the handlebar moves unevenly, binds or has vertical movement, adjust the steering head bearing by turning the steering head adjusting nut. (page 11-29).



NUTS, BOLTS, FASTENERS

Tighten bolts, nuts and fasteners at regular intervals shown in the Maintenance Schedule (page 3-2).

Check that all chassis nuts and bolts are tightened to their correct torque values (page 1-5). Check that all cotter pins and safety clips are in place.

ENGINE UNDER GUARD AND SKID PLATE (AFTER '86)

The engine under guard ① and skid plate ② protect the engine and rear differential from rocks. Check the under guard and plate for cracks, damage or looseness at intervals shown in the Maintenance Schedule.

Replace the under guard and plate if they are cracked or damaged.

If the under guard and plate bolts are loose, tighten them to 24–30 N·m (2.4–3.0 kg·m, 17–22 ft·lb)

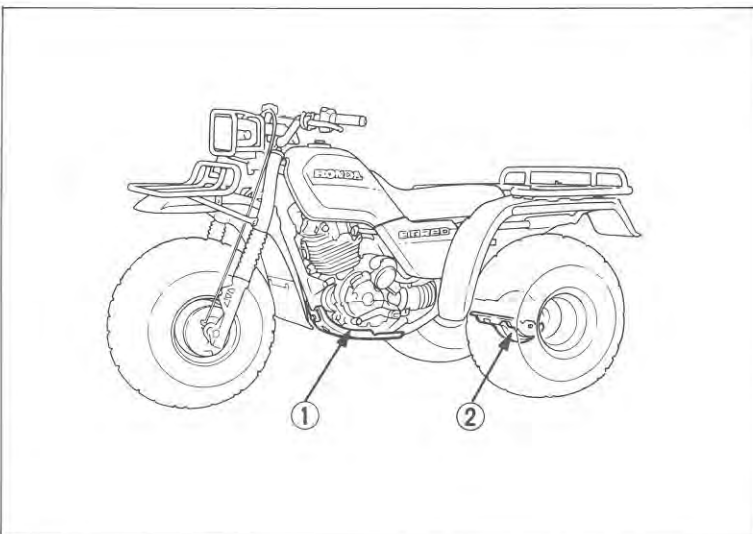

MEMO

FUEL SYSTEM

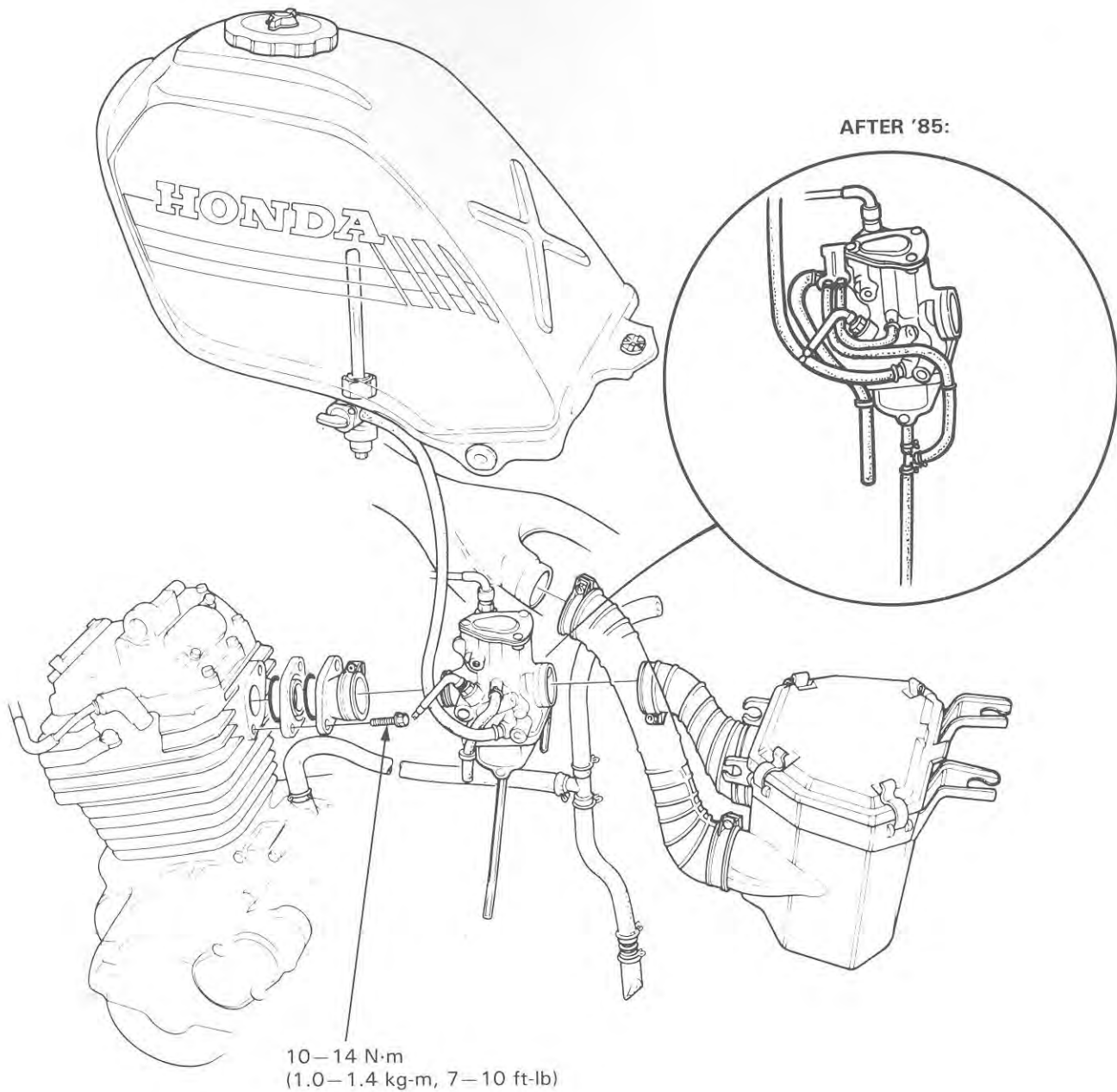

4. FUEL SYSTEM

SERVICE INFORMATION	4-1	FLOAT CHAMBER	4-10
TROUBLESHOOTING	4-2	THROTTLE VALVE	4-13
FUEL TANK	4-3	CARBURETOR INSTALLATION	4-15
AIR CLEANER CASE	4-4	PILOT SCREW ADJUSTMENT	4-15
CARBURETOR CHOKE	4-5	HIGH ALTITUDE ADJUSTMENT	4-15
CARBURETOR REMOVAL	4-6		

SERVICE INFORMATION

GENERAL

- Use caution when working with gasoline. Always work in a well ventilated area away from sparks or flames.
- When disassembling fuel system parts, note the locations of the O-rings. Replace them with new O-rings during reassembly.
- The carburetor float bowl has a drain screw that can be loosened to drain gasoline.

CAUTION

- Do not bend or twist control cables. Damaged control cables will not operate smoothly and may stick or bind.

SPECIFICATIONS

Fuel tank capacity 12.0 liter (3.2 US gal, 2.6 Imp. gal)
 Fuel reserve capacity 2.0 liter (0.53 US gal, 0.44 Imp. gal)

Carburetor

ITEM	'85:		After '85:
	QA01A [A], QA01A [B]	QA01A [C], QA01A [D]	QA07A [A]
Identification mark			
Venturi dia	27 mm (1.06 in)	←	←
Float level	18.5 mm (0.73 in)	←	←
Pilot screw opening	2 turns out	←	←
Idle speed	1,400 ± 100 rpm	←	←
Main jet	#130	←	←
Primary jet	#45	←	←
Slow jet	#38	←	←
Starter fuel jet	Press fit	#70	#80
Jet needle	2nd groove	←	←
Throttle lever free play	3–8 mm (1/8–5/16 in)	←	←

TORQUE VALUES

Intake pipe bolt 10–14 N·m (1.0–1.4 kg·m, 7–10 ft·lb)
 Intake pipe band bolt 3–5 N·m (0.3–0.5 kg·m, 2–4 ft·lb)

TOOL

Common

Float level gauge 07401–0010000

TROUBLESHOOTING

Engine cranks but won't start

1. No fuel in tank
2. No fuel to carburetor
3. Too much fuel getting to cylinder
4. No spark at plug (ignition malfunction)
5. Air cleaner clogged

Engine idles roughly, stalls, or runs poorly

1. Idle speed incorrect
2. Ignition malfunction
3. Rich mixture
4. Lean mixture
5. Air cleaner dirty
6. Insulator leaks

Lean mixture

1. Carburetor fuel jet clogged
2. Fuel cap vent blocked
3. Fuel filter clogged
4. Fuel line kinked or restricted
5. Float valve faulty
6. Float level too low

Rich mixture

1. Carburetor choke stuck closed
2. Float valve faulty
3. Float level too high
4. Carburetor air jet clogged
5. Air cleaner dirty

FUEL TANK

Remove the seat and both frame side covers.
Turn the fuel valve OFF and disconnect the fuel line at the fuel valve.

Remove the fuel tank mounting bolt and the tank.

WARNING

*Keep gasoline away from flames or sparks.
Wipe up spilled gasoline at once.*

Use a drain pan and check that fuel flows freely out of the fuel valve by turning the fuel valve ON.
If flow is restricted, clean the fuel strainer (page 3-7) and fuel filter screen.

Check the vent hole in the filler cap for blockage.
Install the fuel tank by sliding its front brackets onto the rubber cushions on the frame and tighten the mounting bolt.

Connect the fuel line to the fuel valve.

Install the seat.

Turn the fuel valve ON and make sure that there are no fuel leaks.

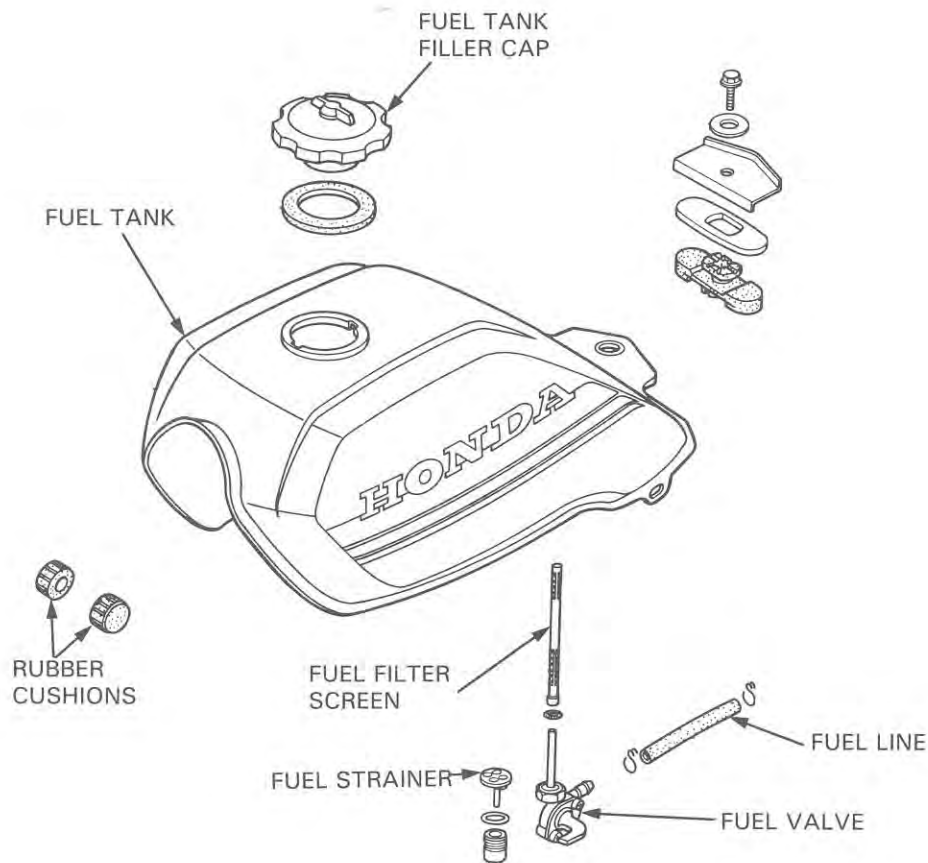
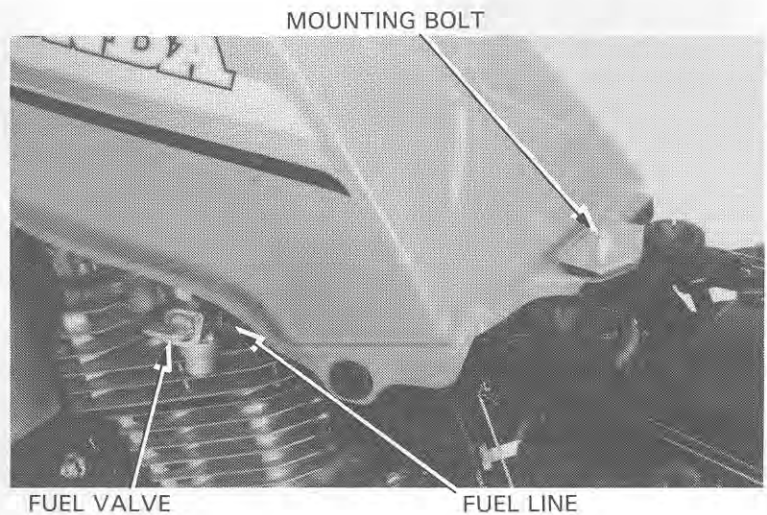

AIR CLEANER CASE

Remove the fuel tank (page 4-3).
Remove the battery case mounting bolt and move the case to the rear.

BATTERY CASE MOUNTING BOLT

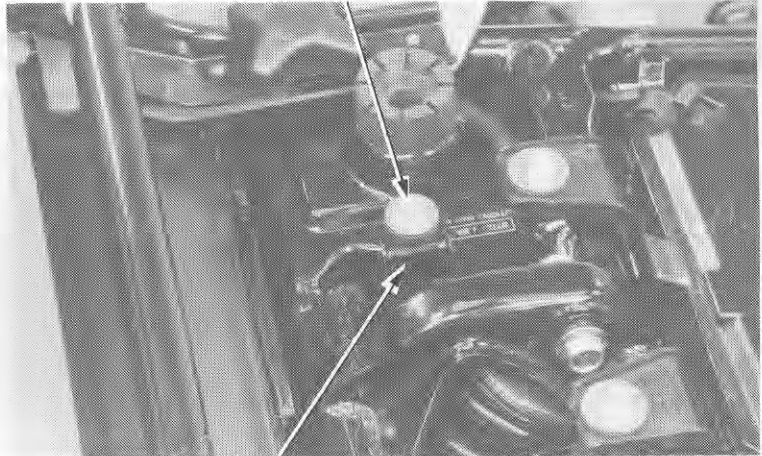

BATTERY CASE

Loosen the air cleaner-to-carburetor and air cleaner-to-frame connecting tube bands.
Remove the two air cleaner case mounting bolts and the air cleaner case.

AIR CLEANER-TO-CARBURETOR
CONNECTING TUBE BAND

CASE MOUNTING BOLTS

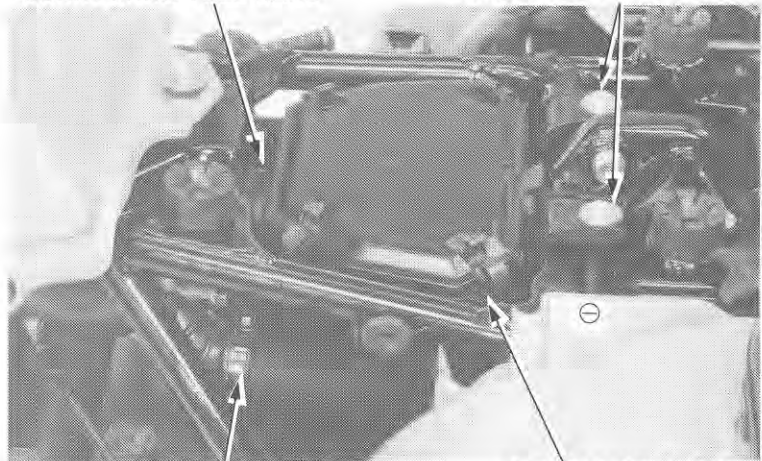

AIR CLEANER-TO-FRAME
CONNECTING TUBE BAND

AIR CLEANER CASE

AIR CLEANER CASE COVER

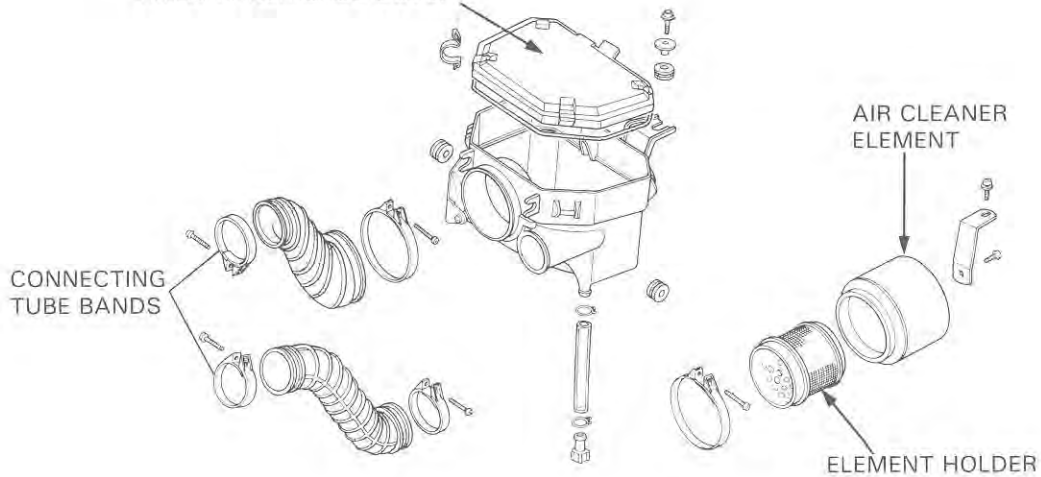

CONNECTING
TUBE BANDS

AIR CLEANER
ELEMENT

ELEMENT HOLDER

CARBURETOR CHOKE

The choke system uses a fuel enrichment circuit controlled by a starter valve. The starter valve opens the enrichment circuit via a cable when the choke lever on the handlebar is moved to the left.

Check for smooth choke lever operation. Lubricate the choke cable if the operation is not smooth.

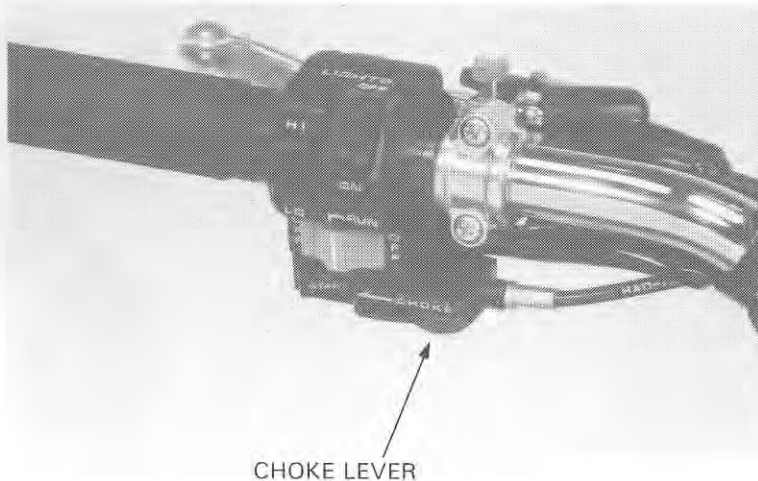

Loosen the starter valve nut and remove the valve from the carburetor.

Move the choke lever all the way to the left and measure the starter valve stroke.

STARTER VALVE STROKE: 7.0 mm (0.28 in)

Check the starter valve and spring for nicks, grooves, or other damage.

STARTER VALVE NUT

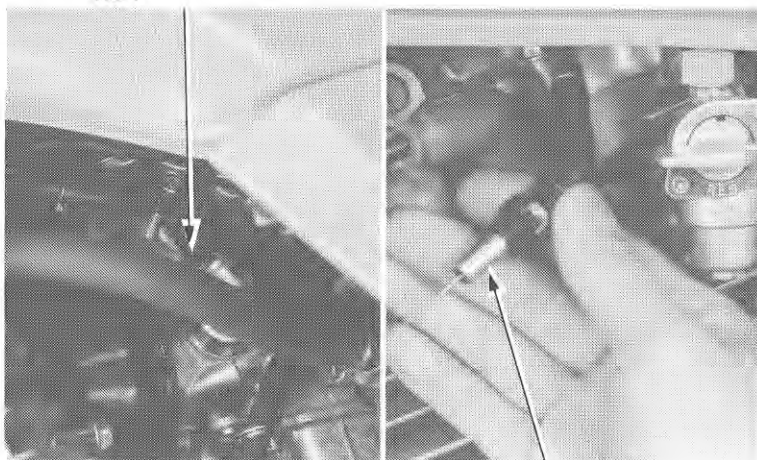

After '85

Make sure the O-ring is in good condition.

STARTER VALVE NUT

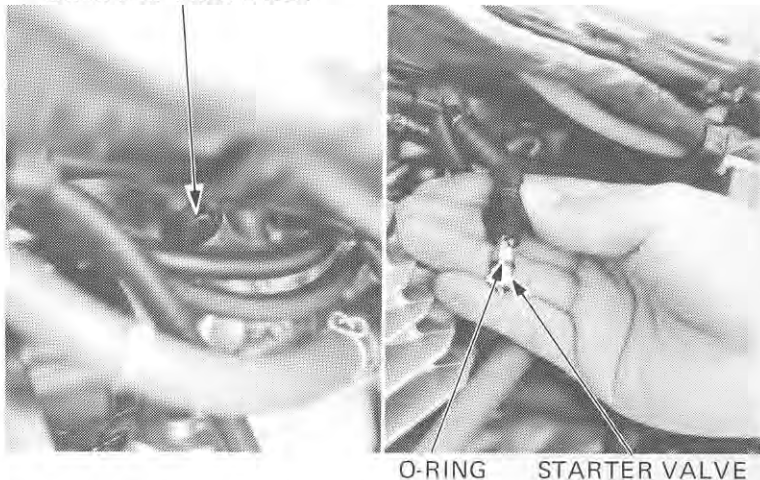

FUEL SYSTEM

Disconnect the choke cable end from the starter valve and replace the valve and spring if necessary.

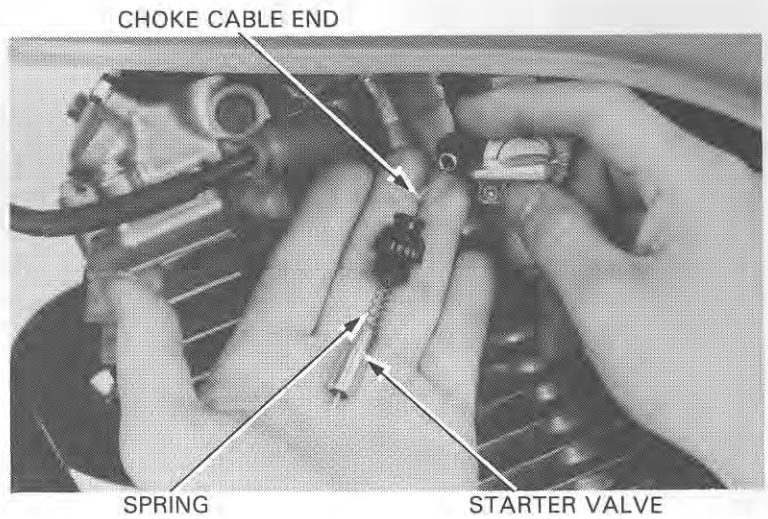

CARBURETOR REMOVAL

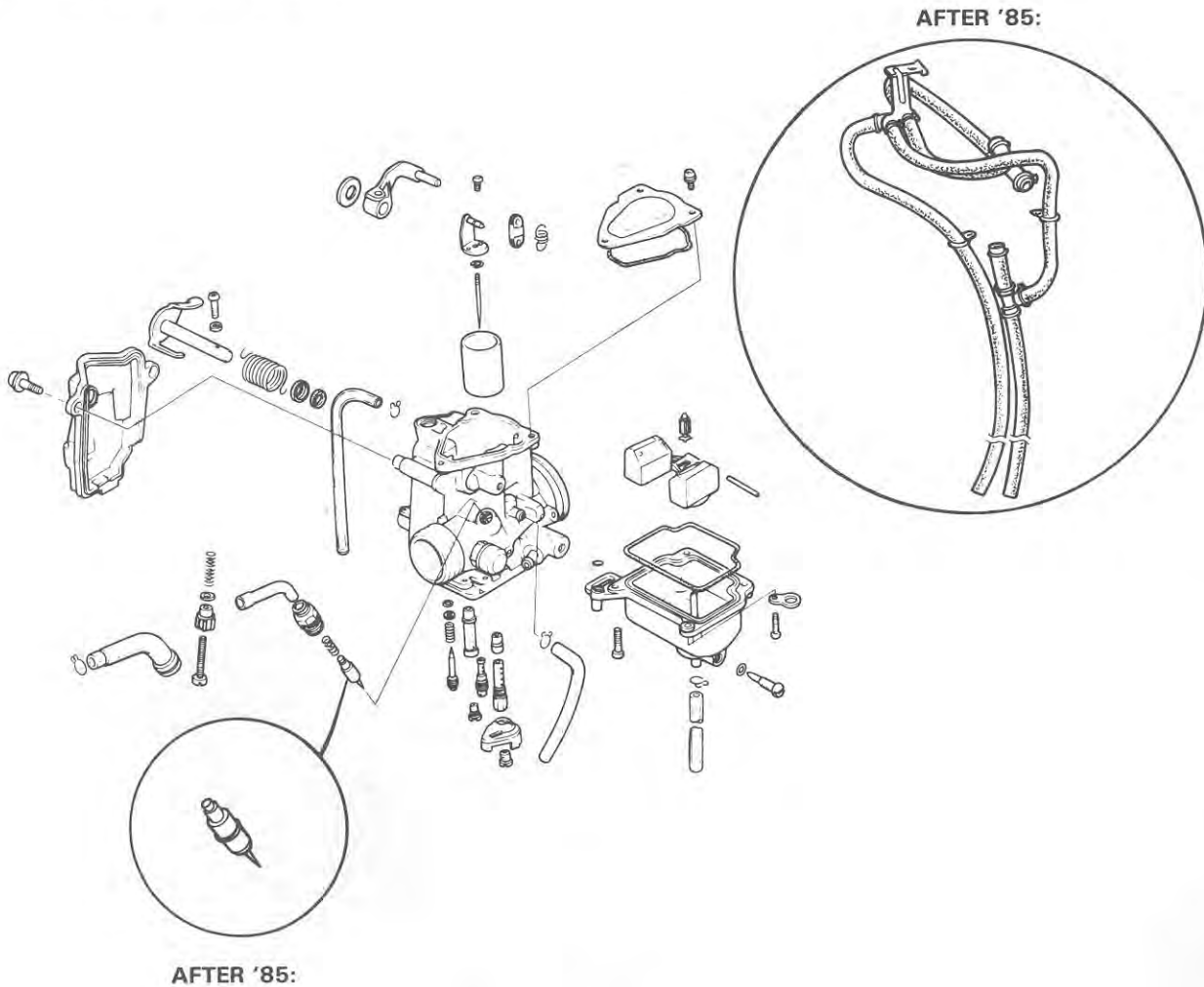

Remove the frame side covers, seat and fuel tank.
Drain the gasoline from the float chamber.
Loosen the air cleaner connecting tube band.
Remove the two intake pipe bolts and remove the carburetor from the right side.

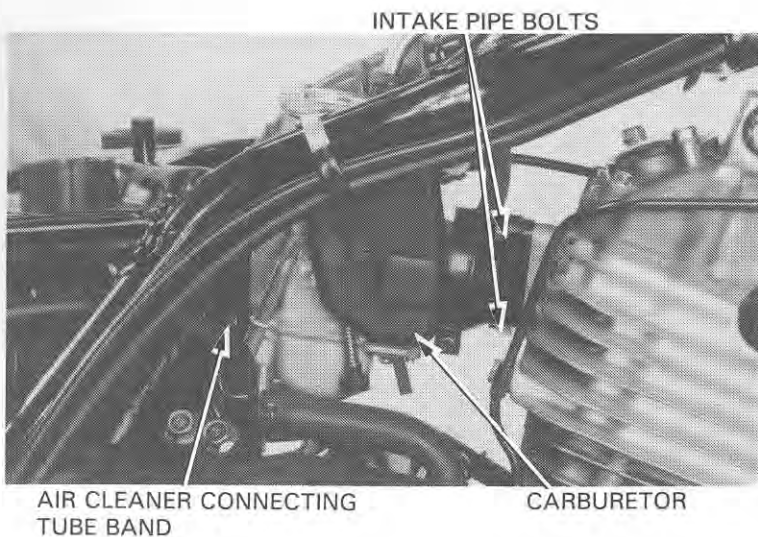

Remove the two carburetor cover screws and the cover.

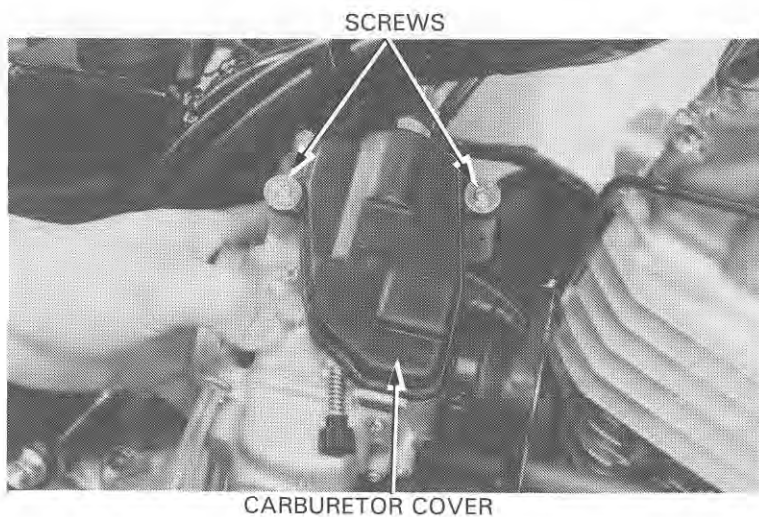

Disconnect the throttle cable end from the throttle drum.
Remove the throttle cable from the carburetor body.

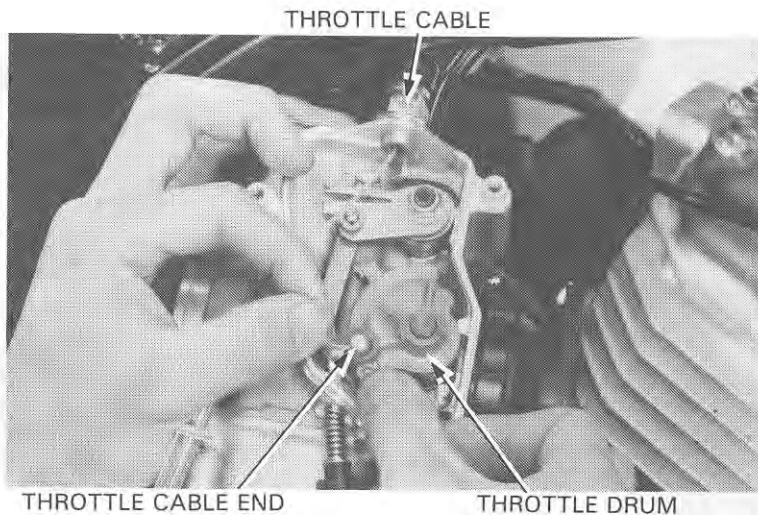

FUEL SYSTEM

Loosen the starter valve nut and disconnect the choke cable from the carburetor.

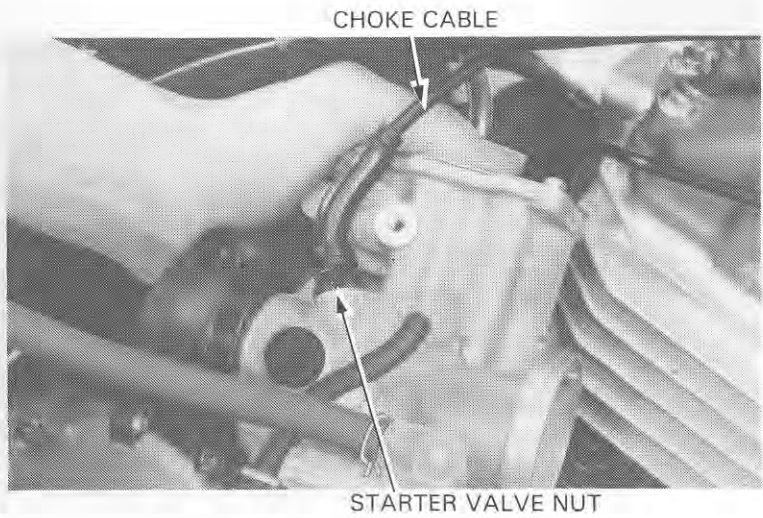

After '85

Remove the frame side covers, seat and fuel tank.

Drain the gasoline from the float chamber.

Remove the air vent tube from the frame clamp.

Remove the starter valve nut and disconnect the choke cable from the carburetor.

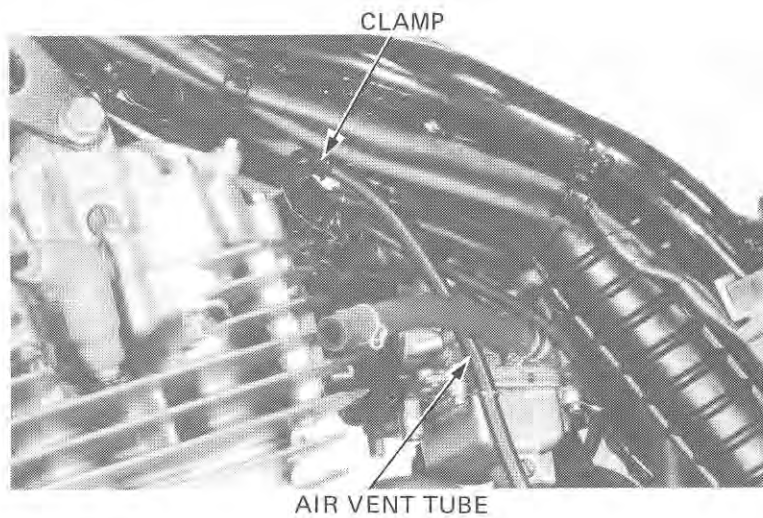

Disconnect the inlet tube from the air cleaner.

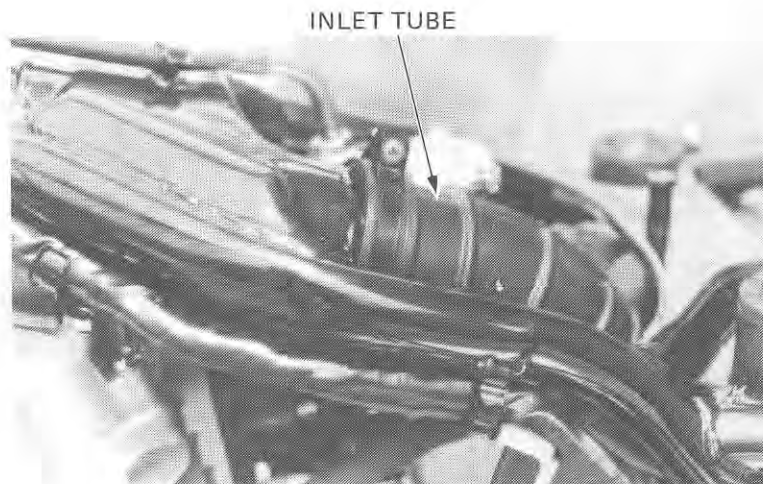

Loosen the carburetor band screws and air cleaner connecting tube band screw.
Remove the carburetor from the top side.



Remove the air vent tube of the carburetor.
Remove the two carburetor cover screws and the cover.

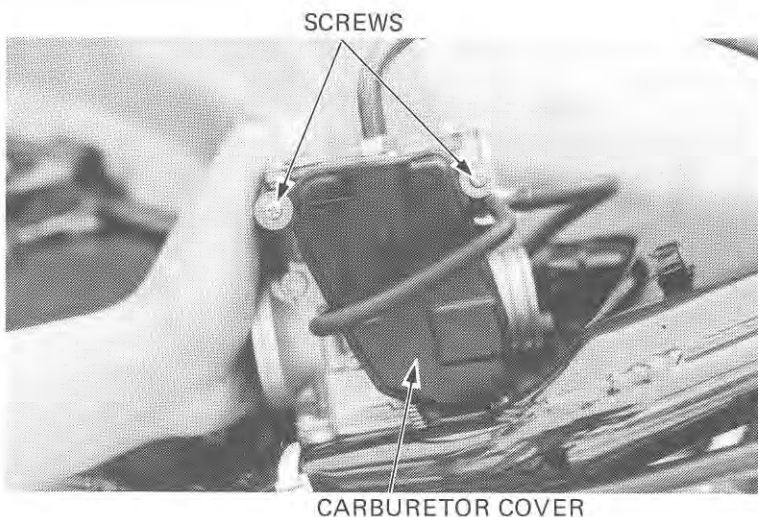

Disconnect the throttle cable end from the throttle drum.
Remove the throttle cable from the carburetor body.

NOTE

- Apply grease to the throttle cable end when installing.

CAUTION

Do not twist or bend the throttle cable when installing or removing it from the throttle drum. Use the same care when handling the carburetor assembly. Twisting or bending the cable can damage it and cause throttle operation to be rough.

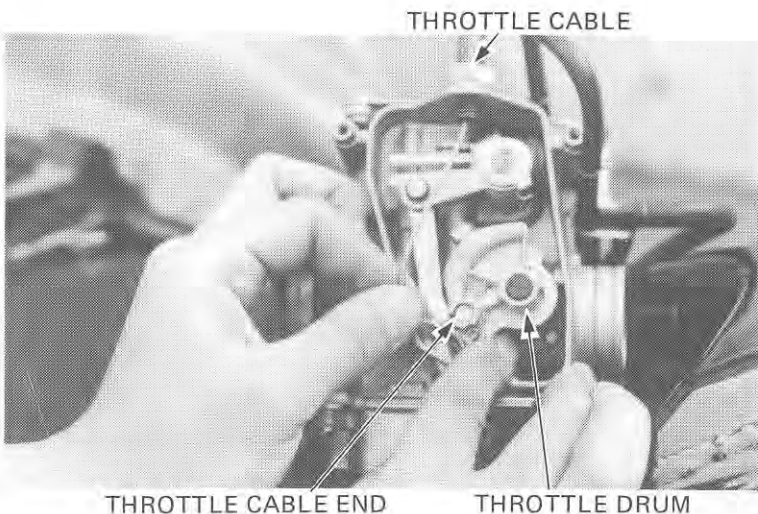

FUEL SYSTEM

Remove the air vent tubes.

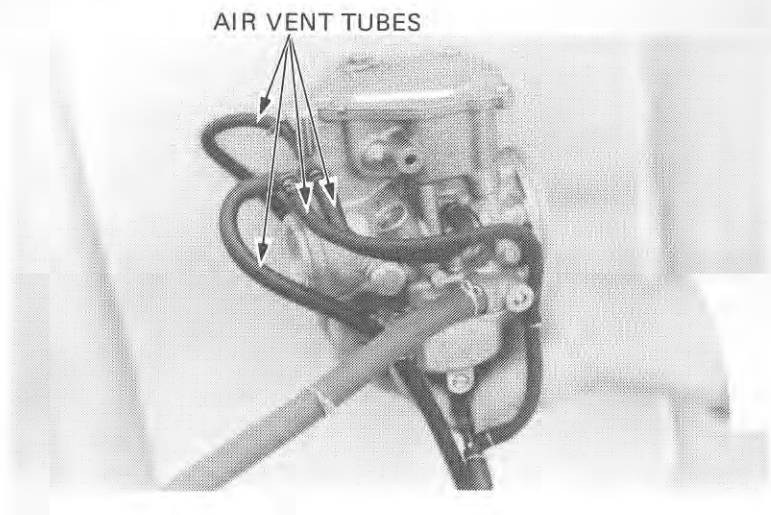

FLOAT CHAMBER

REMOVAL

Remove the four float chamber screws and the float chamber.

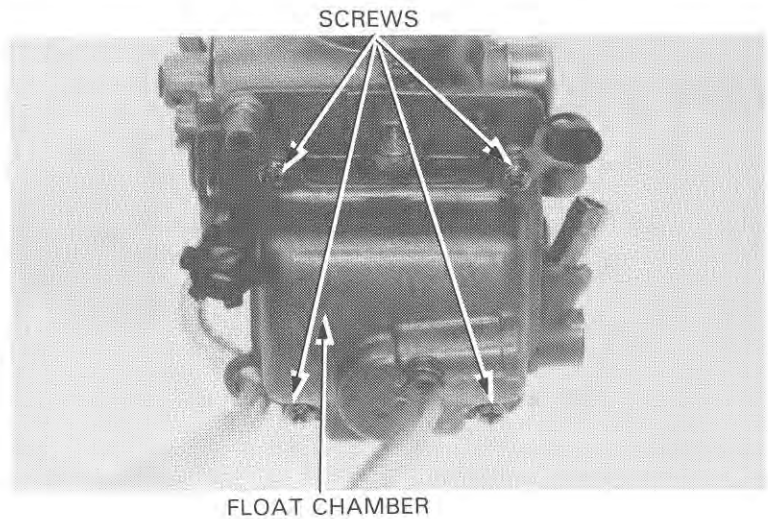

FLOAT LEVEL

Measure the float level with a float level gauge as shown.

SPECIFICATIONS: 18.5 mm (0.73 in)

The float can not be adjusted.
Replace the float assembly if it is out of specification.

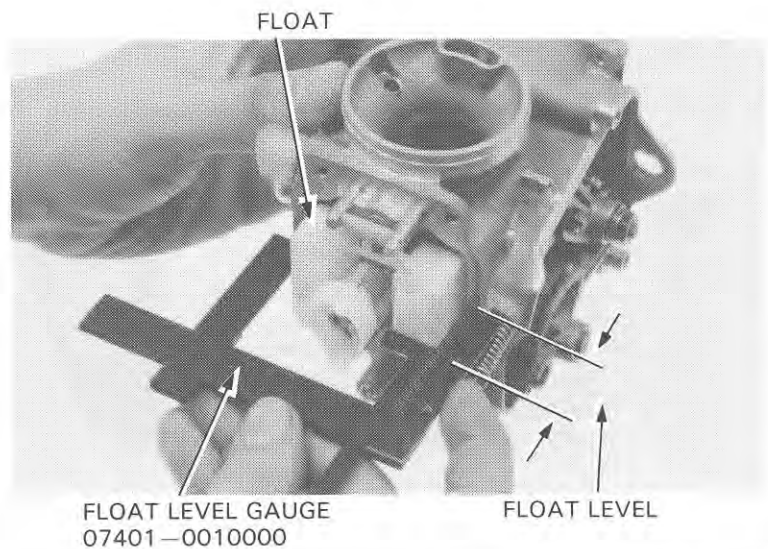

FLOAT AND JETS

Remove the float pin, baffle, float and float valve.

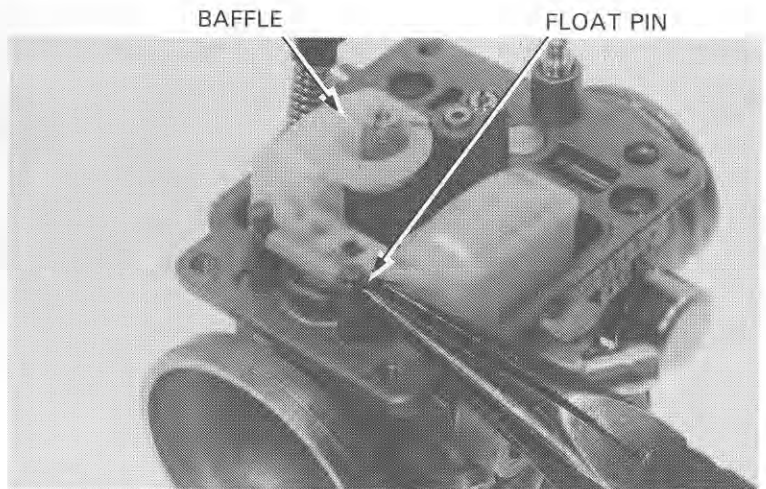

Inspect the float valve for grooves and nicks. Replace as required. Inspect the operation of the float valve.

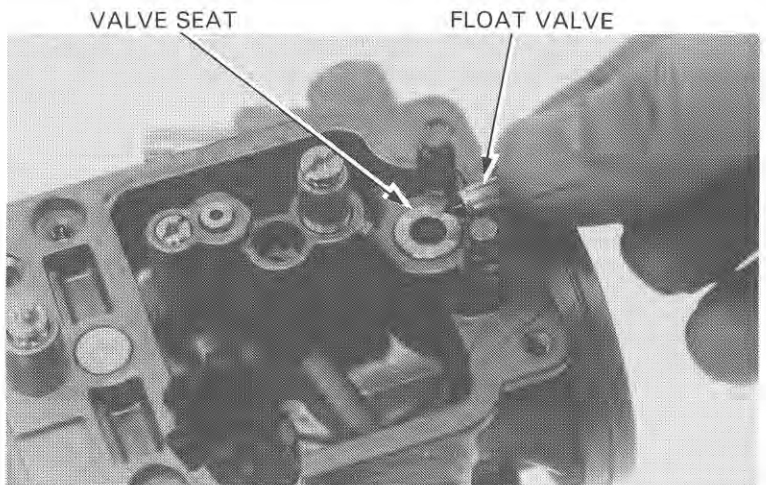

Remove the main jet, needle jet holder and needle jet. Remove the slow jet, primary jet and primary nozzle. Turn the pilot screw in and record the number of turns before it seats lightly. Use this as a reference for reinstallation.

CAUTION

Damage to the pilot screw seat will occur if the pilot screw is tightened against the seat.

Remove the pilot screw.

NOTE

Starter jets on carburetors with I.D. Numbers QA01A **A** or QA01A **B** are press fit. Do not attempt to remove them (see page 4-1).

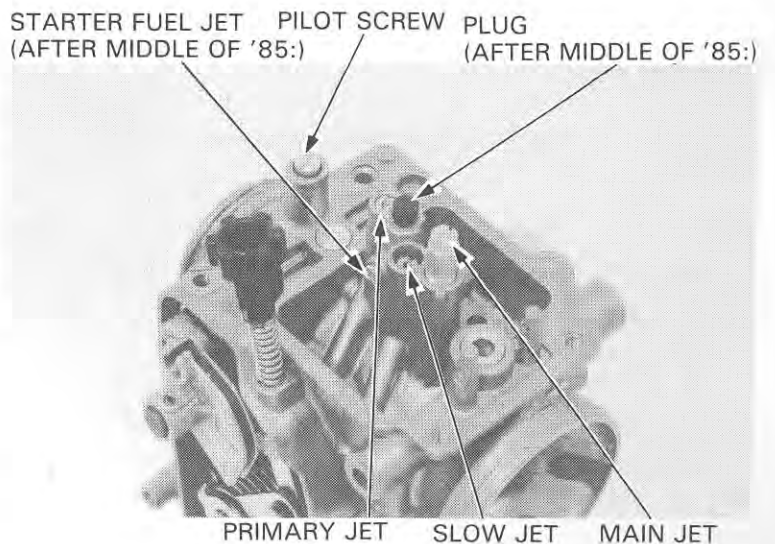

FUEL SYSTEM

Inspect the pilot screw and each jet and replace them if they are worn or damaged.
Blow open all jets with compressed air.

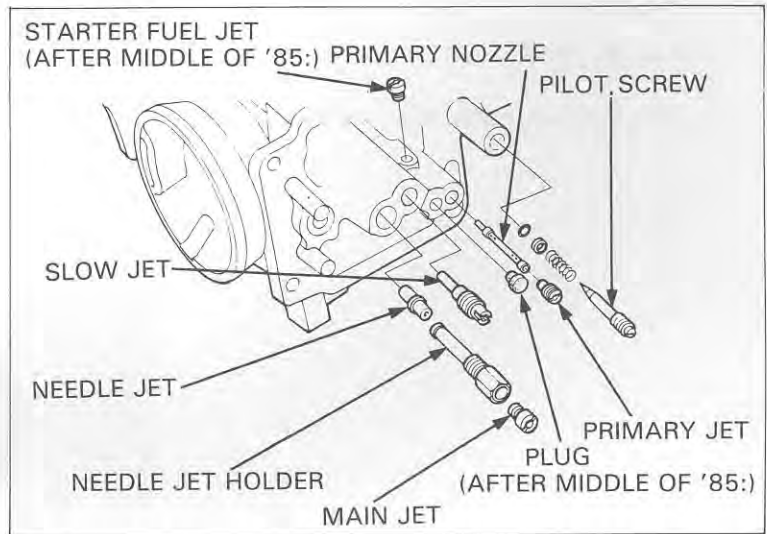

Remove the primary throttle valve (page 4-13) and blow open all carburetor body openings with compressed air.

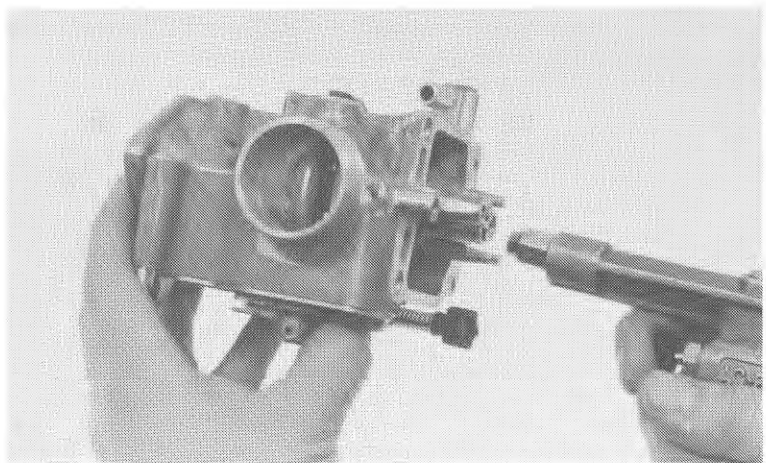

ASSEMBLY

Float chamber assembly is essentially the reverse order of disassembly.

NOTE

- Use new O-rings whenever the carburetor is reassembled.
- Handle all jets with care. They can easily be scored or scratched.
- Set the pilot screw to the position recorded during disassembly.
- Align the overflow tube on the chamber with the hole in the baffle as shown.

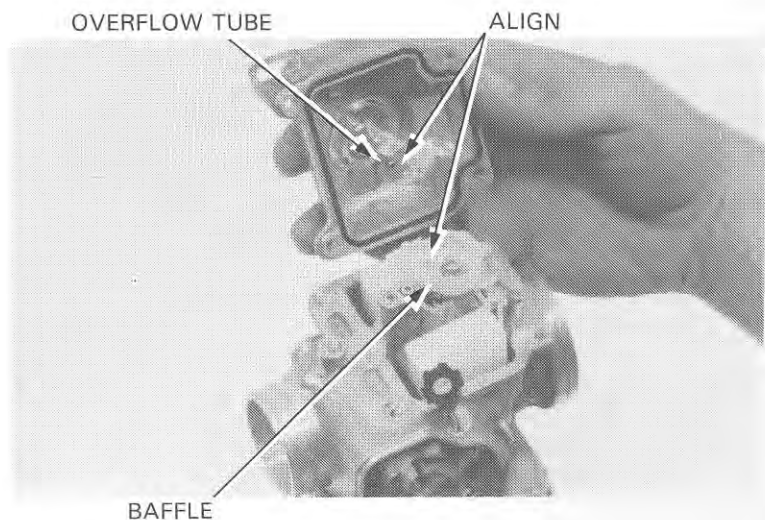

THROTTLE VALVE

NOTE

The butterfly throttle valve attaching screws are staked and the valve can not be removed.

PISTON THROTTLE VALVE REMOVAL

Remove the throttle valve arm set screw.

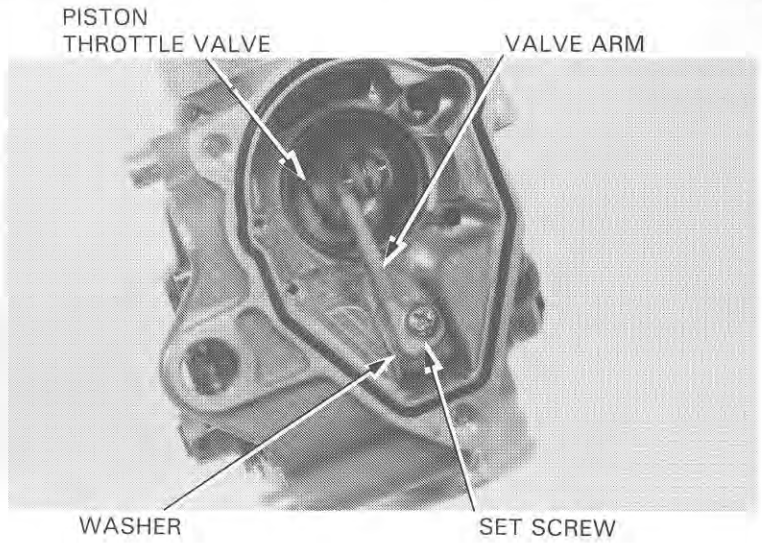

Pull the shaft out and remove the throttle valve and washer.

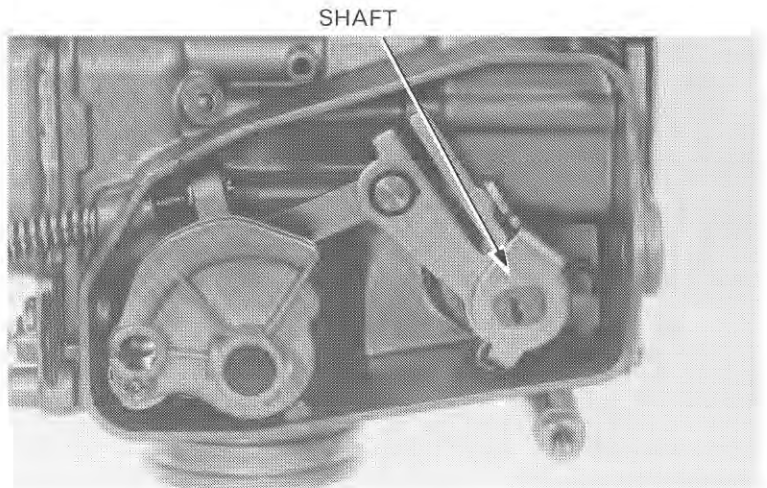

Remove the two screws attaching the valve arm to the valve and remove the valve and jet needle from the arm.

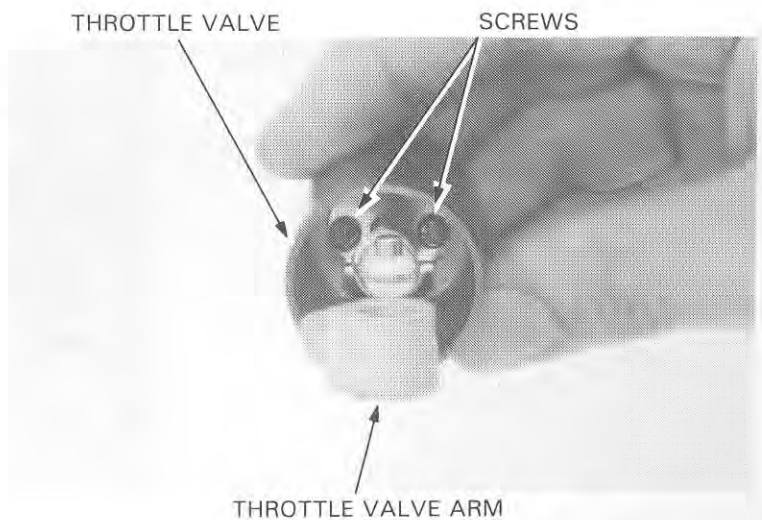

FUEL SYSTEM

Check the throttle valve and jet needle for wear or damage.

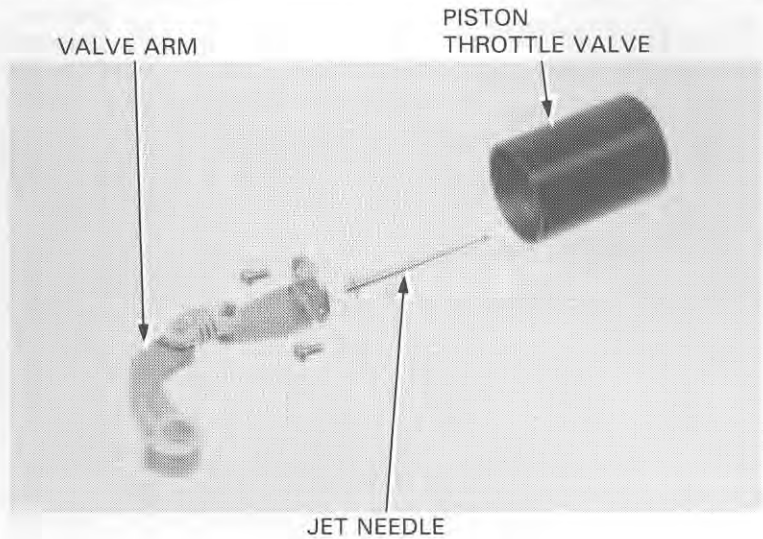

PISTON THROTTLE VALVE INSTALLATION

Install the needle clip on the jet needle.

STANDARD SETTING: 2nd groove

Install the primary throttle valve in the reverse order of removal.

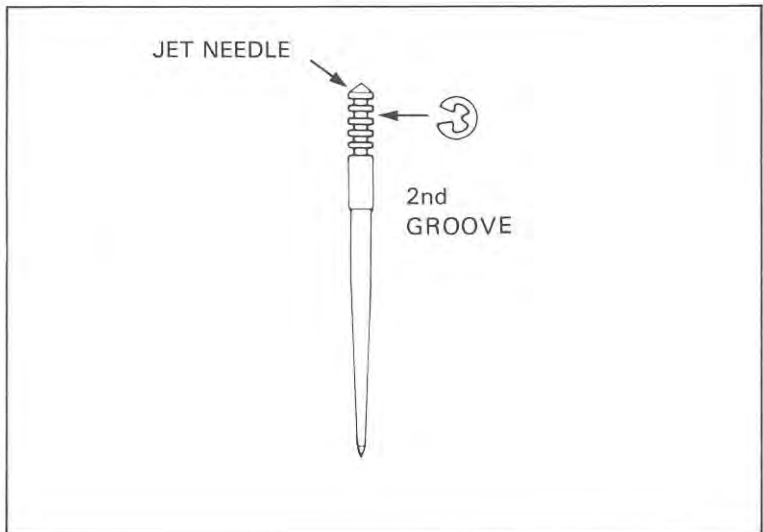

THROTTLE VALVE SYNCHRONIZATION

Close the throttle valve fully.
Make sure that the throttle slide is closed fully and there is no clearance between the throttle link and the throttle slide shaft arm.

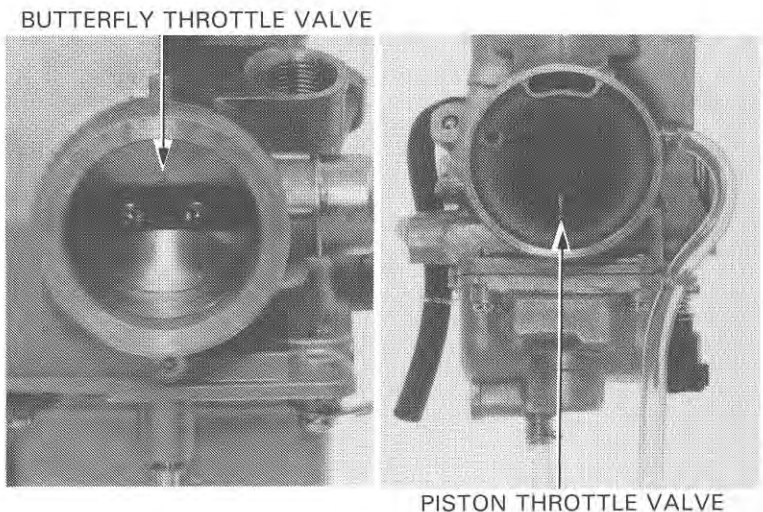

Adjust synchronization by opening or closing the slot in the throttle link.

CARBURETOR INSTALLATION

Installation is essentially the reverse of removal.

NOTES

- Route the throttle and choke cables properly (page 1-12).
- Apply grease to the throttle cable end when installation.
- Damage to the wire occurs if the throttle cable is bent.

Perform the following inspections and adjustments.

- Throttle operation (page 3-8)
- Carburetor choke (page 4-5).
- Carburetor idle speed (page 3-6).

PISTON THROTTLE VALVE
SHAFT ARM

THROTTLE LINK

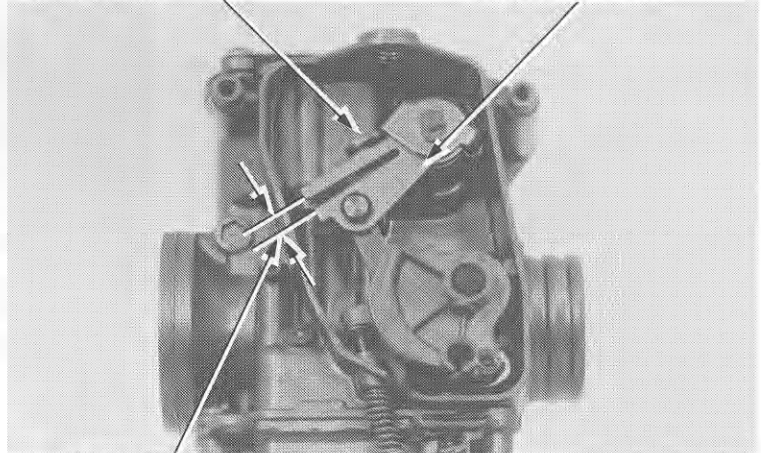

OPEN OR CLOSE

PILOT SCREW ADJUSTMENT

NOTE

The pilot screw is factory pre-set. Adjustment is not necessary unless the carburetor is overhauled or a new pilot screw is installed.

CAUTION

Damage to the pilot screw seat will occur if the pilot screw is tightened against the seat.

Turn the pilot screw clockwise until it seats lightly and back it out 2 turns.

This is an initial setting prior to the final pilot screw adjustment.

Warm the engine up to operating temperature.

Stop the engine and connect a tachometer.

Start the engine and adjust the idle speed with the throttle stop screw.

IDLE SPEED: 1,400 ± 100 rpm

Turn the pilot screw clockwise slowly until the engine stops, and then back it out 1 turn. Start the engine and readjust the idle speed with the throttle stop screw, if necessary.

HIGH ALTITUDE ADJUSTMENT

The carburetor must be adjusted for high altitude riding (above 6,000 ft/1,800 m).

STANDARD SETTING

6,000 ft (1,800 m) max.

HIGH ALTITUDE SETTING:

5,000 ft (1,500 m) min.

High altitude carburetor adjustment is performed as follows:

THROTTLE STOP SCREW

PILOT SCREW

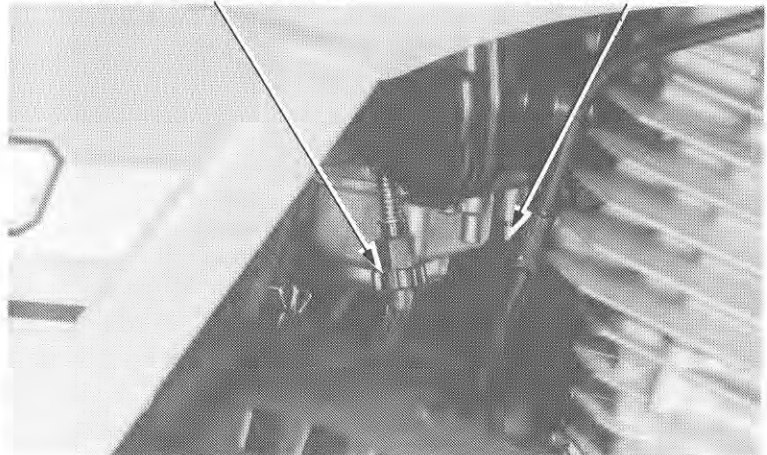

SPECIFICATIONS

	Below 6,000 ft (1,800 m)	Above 5,000 ft (1,500 m)
Main jet	#130	#125
Pilot screw opening	Factory preset	1/2 Screw in

FUEL SYSTEM

Remove the carburetor (page 4-6) and float chamber (page 4-10).

Replace the standard main jet with the high altitude type (#125).

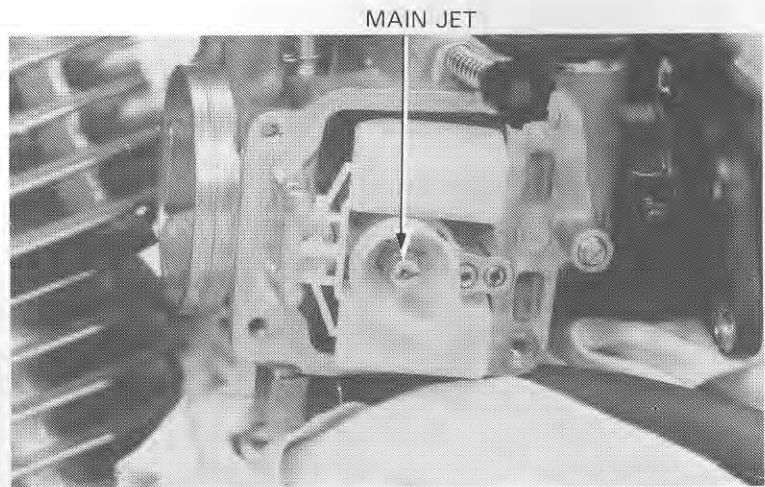

Assemble and install the carburetor.

Start the engine and adjust the idle speed at high altitude to ensure proper high altitude operation.

CAUTION

Sustained operation below 5,000 feet (1,500 m) with the high altitude settings may cause engine overheating and engine damage. Install the #130 main jet and turn out the pilot screw 1/2 turn, when riding below 5,000 feet (1,500 m).

MEMO



ENGINE REMOVAL/ INSTALLATION

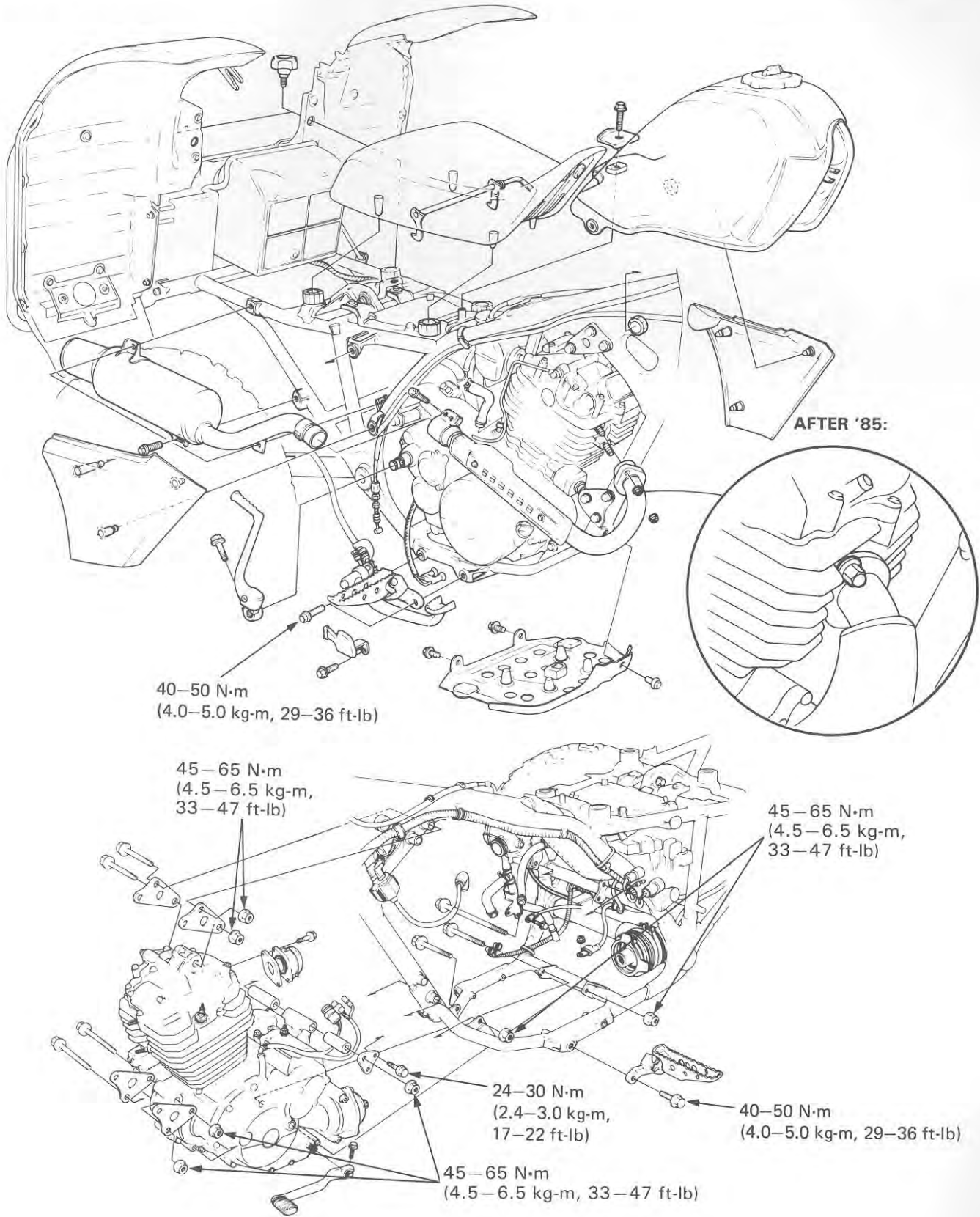

5. ENGINE REMOVAL/ INSTALLATION

SERVICE INFORMATION	5-1
ENGINE REMOVAL	5-2
ENGINE INSTALLATION	5-4

SERVICE INFORMATION

GENERAL

- A floor jack or other adjustable support is required to support and maneuver the engine.
- The following parts or components can be serviced with the engine installed in the frame:
 - Carburetor
 - Oil pump
 - Alternator
 - Starter motor
 - Cylinder and piston
 - Clutch
 - Kick starter
 - Gearshift linkage
 - Cylinder head
 - Cam chain tensioner

SPECIFICATIONS

Engine dry weight	46.3 kg (102 lbs)
Engine oil capacity	2.5 lit. (2.6 US qt, 2.2 Imp qt) after disassembly 2.1 lit. (2.2 US qt, 1.8 Imp qt) after draining

TORQUE VALUES

Engine hanger bolt

8 mm bolt	24–30 N·m (2.4–3.0 kg-m, 17–22 ft-lb)
10 mm bolt	45–65 N·m (4.5–6.5 kg-m, 33–47 ft-lb)
Foot peg bracket bolt	40–50 N·m (4.0–5.0 kg-m, 29–36 ft-lb)

ENGINE REMOVAL/ INSTALLATION

ENGINE REMOVAL

Remove the exhaust pipe and muffler (page 13-3).
Drain the engine oil (page 2-2).
Remove the seat, frame side covers and fuel tank.
Raise the rear fender.

Remove the right foot peg/rear brake pedal from the frame by removing two bolts.

Remove the bolt attaching the reverse lock cable holder and disconnect the cable from the lock lever.
Remove the neutral and reverse switch wire cover.
Disconnect the neutral and reverse switch wires from the switches.

Remove the reverse lock lever by removing the bolt.

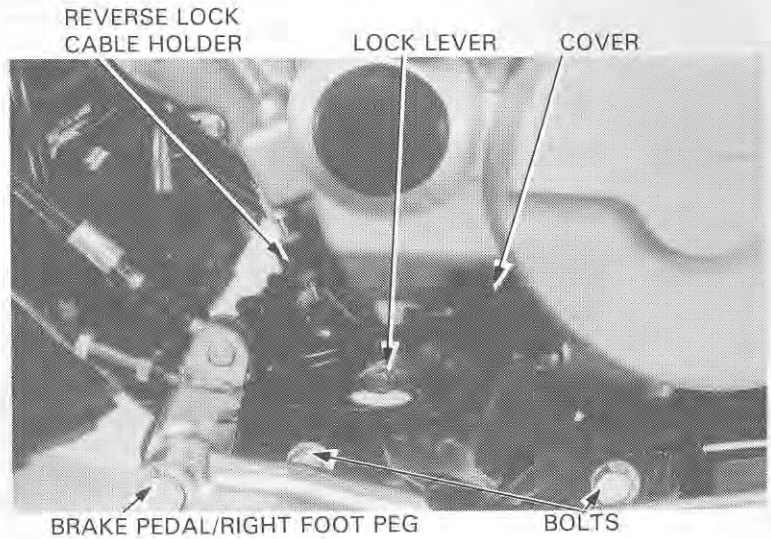

Disconnect the spark plug cap, crankcase breather tube, and the starter motor cable.

Remove the gearshift pedal.

Loosen the drive shaft boot band.

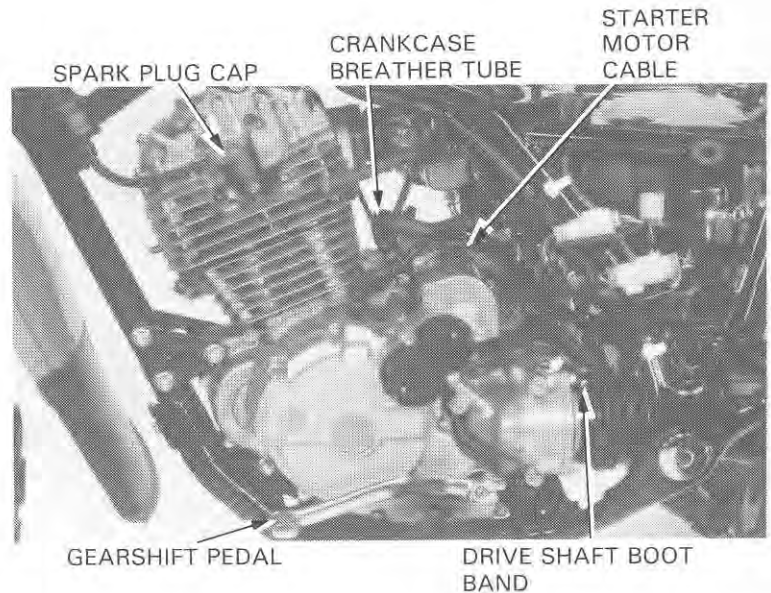

Disconnect the engine ground cable and tube clamp.

Remove the carburetor (page 4-6).

Disconnect the alternator and pluse generator couplers and wire.

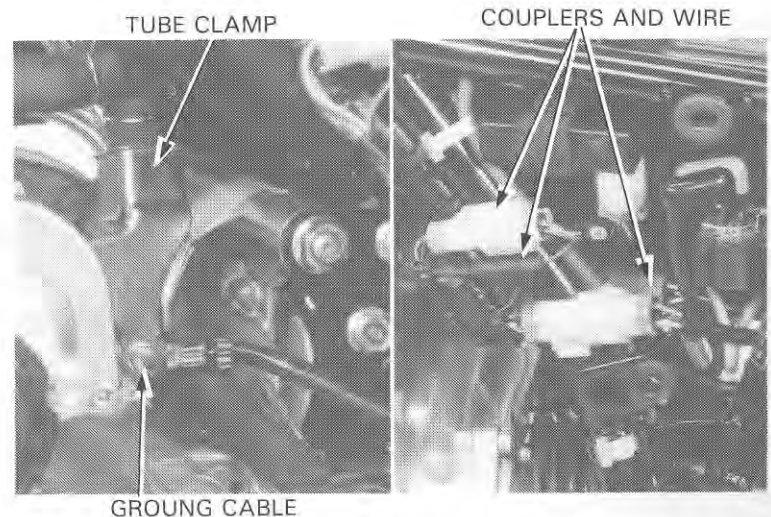

Remove the three skid plate bolts and plate.

Place a floor jack or other adjustable support under the engine.

NOTE

The jack height must be continuously adjusted so that the mounting bolts can be removed, and so stress is relieved from other bolts until they are removed.

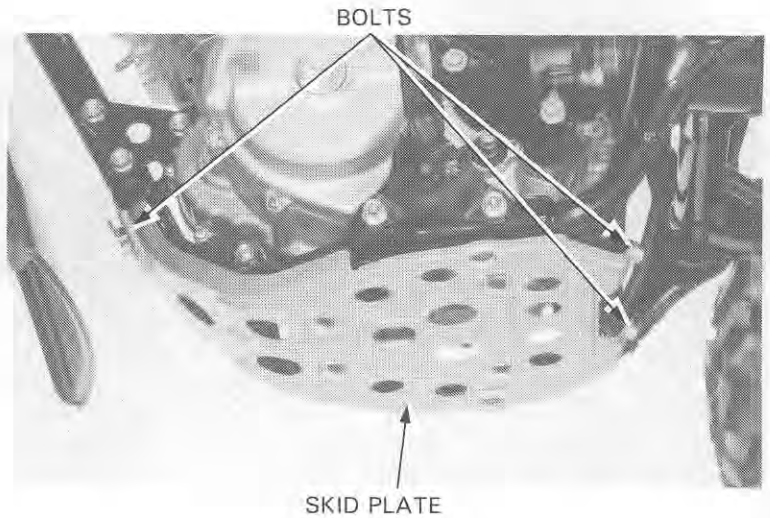

Remove the upper hanger plate bolts and plates.

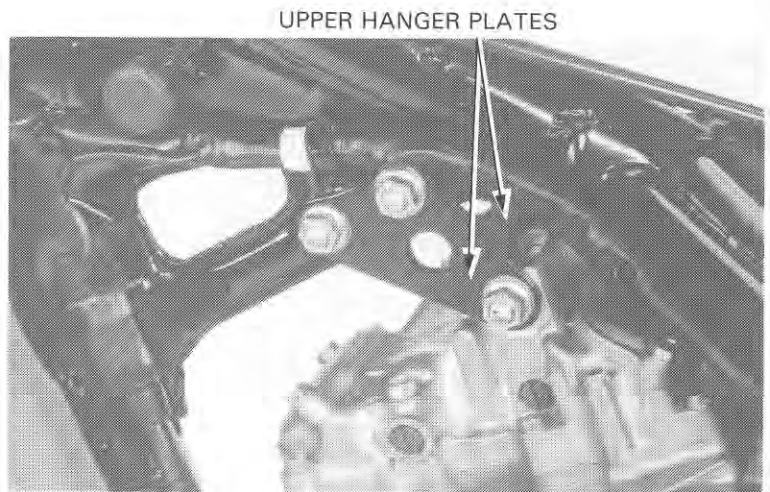

Remove the front hanger plate bolts and plate.

Remove the front lower hanger bolt.

Remove the left foot peg bolts and foot peg.

Remove the engine rear lower hanger bolt.

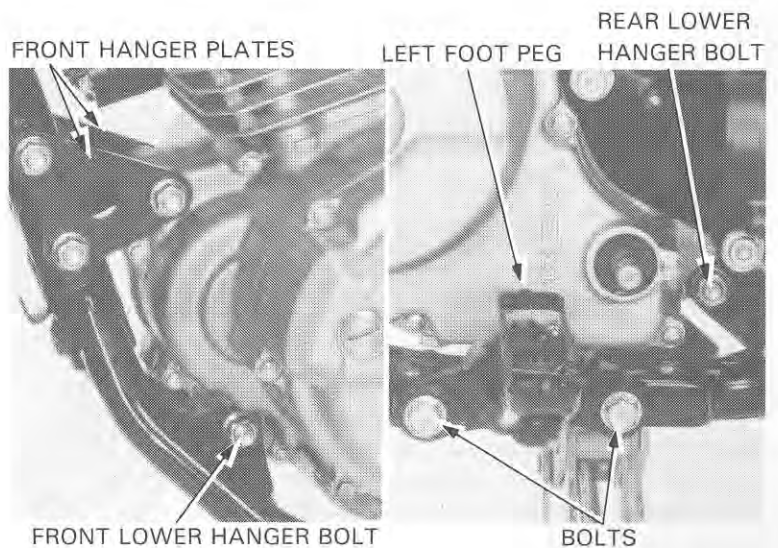

ENGINE REMOVAL/ INSTALLATION

Remove the rear engine hanger plate bolts, plate and collars.

Remove the engine from the left side while disconnecting the drive shaft universal joint from the engine.

ENGINE INSTALLATION

Engine installation is essentially the reverse of removal.

Apply molybdenum disulfide grease to the output gear shaft splines.

Use a floor jack or other adjustable support to carefully maneuver the engine into place.

CAUTION

Carefully align the mounting points with the jack to prevent damage to mounting bolt threads and wire harness and cables.

Tighten all fasteners to the specified torque.

TORQUE:

Engine mounting bolts

10 mm bolts 45–65 N·m
(4.5–6.5 kg·m, 33–47 ft·lb)

8 mm bolts 24–30 N·m
(2.4–3.0 kg·m, 17–22 ft·lb)

NOTE

- Route the wires and cables properly (page 1-11).
- Fill the crankcase to the proper level with the recommended oil (page 2-1).
- Perform the following inspection and adjustment:
 - Throttle operation (page 3-8).
 - Clutch (page 3-11).
 - Reverse lock cable (page 3-13).

WARNING

Connect the neutral and reverse switch wires properly. If these wire connections are interchanged, the neutral indicator will come on with the transmission in reverse and the ATC will reverse suddenly.

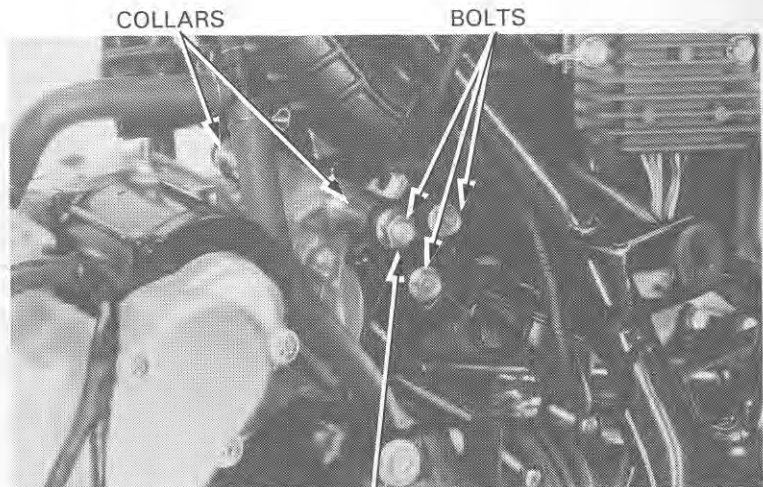

REAR ENGINE HANGER PLATE

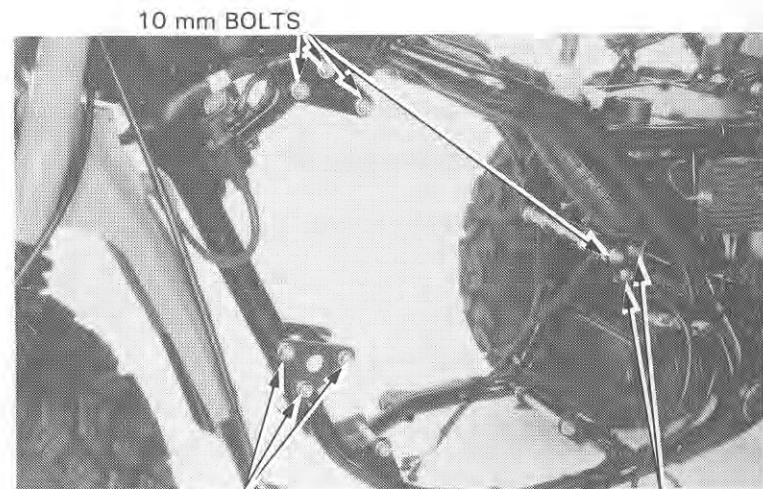
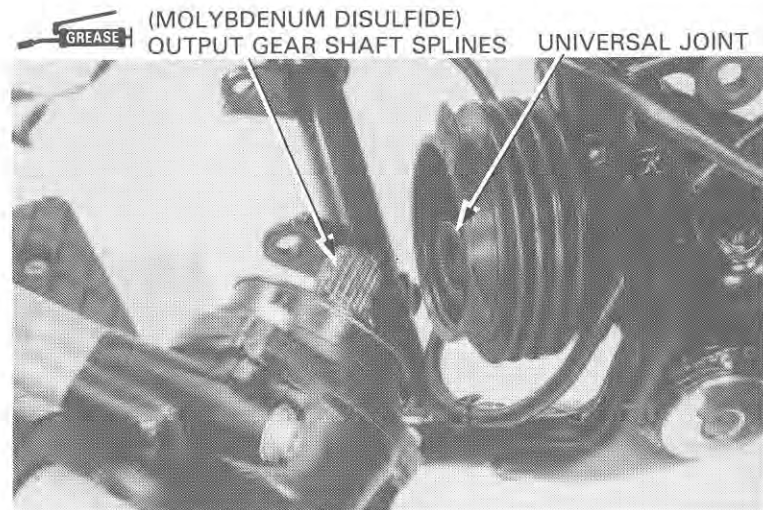

10 mm BOLTS

8 mm BOLTS

MEMO

CYLINDER HEAD/VALVES

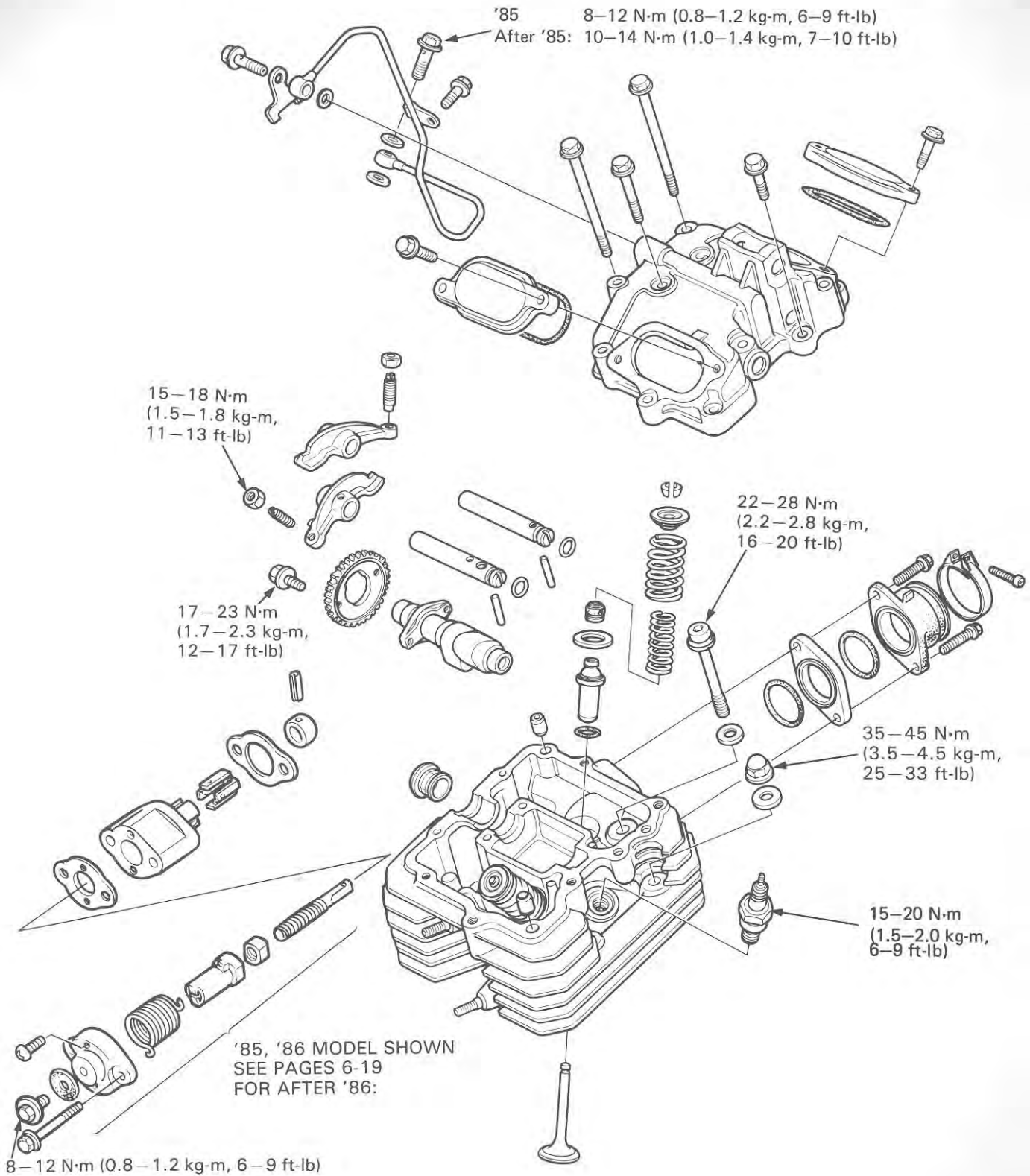

6. CYLINDER HEAD/VALVES

SERVICE INFORMATION	6-1	VALVE SEAT INSPECTION/REFACING	6-11
TROUBLESHOOTING	6-2	CYLINDER HEAD ASSEMBLY	6-14
CYLINDER HEAD COVER REMOVAL/ DISASSEMBLY	6-3	CYLINDER HEAD INSTALLATION	6-15
CAM CHAIN TENSIONER LIFTER	6-4	CAMSHAFT INSTALLATION	6-16
CAMSHAFT REMOVAL	6-5	CAM CHAIN TENSIONER LIFTER ASSEMBLY	6-18
CYLINDER HEAD REMOVAL	6-7	CYLINDER HEAD COVER ASSEMBLY/INSTALLATION	6-19
CYLINDER HEAD DISASSEMBLY	6-8		

SERVICE INFORMATION

GENERAL

- This section covers cylinder head, valves, camshaft, rocker arm and cam chain tensioner lifter services. These services can be performed with the engine in the frame.
- Camshaft lubrication oil is fed to the cylinder head through an oil pipe. Be sure this pipe is not clogged before installation.
- Before assembly, apply molybdenum disulfide grease to the camshaft bearings to provide initial lubrication.
- Pour clean engine oil into the oil pockets in the cylinder head during assembly to lubricate the camshaft lobes.

SPECIFICATIONS

ITEM			STANDARD	SERVICE LIMIT
Cylinder compression			12–13 kg/cm ² (170–185 psi)	
Camshaft	Cam height	IN	36.206 mm (1.4254 in)	36.026 mm (1.4183 in)
		EX	36.077 mm (1.4204 in)	35.897 mm (1.4133 in)
	Journal O.D.	R.C.	23.954–23.975 mm (0.9431–0.9439 in)	23.90 mm (0.941 in)
		After '85 C	23.934–23.955 mm (0.9423–0.9431 in)	23.88 mm (0.940 in)
		L	19.954–19.975 mm (0.7856–0.7864 in)	19.90 mm (0.784 in)
	Bearing I.D.	R, C	24.000–24.021 mm (0.9449–0.9457 in)	24.05 mm (0.947 in)
		L	20.000–20.021 mm (0.7874–0.7882 in)	20.05 mm (0.789 in)
Oil clearance			0.025 – 0.067 mm (0.0010–0.0026 in)	0.10 mm (0.004 in)
Cylinder head warpage			—————	0.10 mm (0.004 in)
Rocker arm	I.D.		12.000–12.018 mm (0.4724–0.4730 in)	12.05 mm (0.474 in)
	Shaft O.D.		11.966–11.984 mm (0.4711–0.4718 in)	11.92 mm (0.469 in)
	Arm-to-shaft clearance		0.016– 0.052 mm (0.0006–0.0020 in)	0.08 mm (0.003 in)
Valve spring	Free length	Inner	38.17 mm (1.503 in)	35.2 mm (1.39 in)
		Outer	41.04 mm (1.616 in)	38.0 mm (1.50 in)
	Preload	Inner	7.0±0.7 kg/31.6 mm (15.4±1.5 lb/1.24 in)	—————
		Outer	17.0±1.7 kg/35.1 mm (37.5±3.7 lb/1.38 in)	—————
Vale, valve guide	Stem O.D.	IN	5.475– 5.490 mm (0.2156–0.2161 in)	5.45 mm (0.215 in)
		EX	5.455– 5.470 mm (0.2148–0.2154 in)	5.43 mm (0.214 in)
	Guide I.D.	IN	5.500– 5.512 mm (0.2165–0.2170 in)	5.525 mm (0.2175 in)
		EX	5.500– 5.512 mm (0.2165–0.2170 in)	5.525 mm (0.2175 in)
	Stem-to-guide clearance	IN	0.010– 0.037 mm (0.0004–0.0015 in)	0.12 mm (0.005 in)
		EX	0.030– 0.057 mm (0.0012–0.0022 in)	0.14 mm (0.006 in)
Valve seat width			1.2 mm (0.05 in)	1.5 mm (0.06 in)

CYLINDER HEAD/VALVES

TORQUE VALUES

Cylinder head cap nut	35–45 N·m (3.5–4.5 kg-m, 25–33 ft-lb)
Cylinder head socket bolt	22–28 N·m (2.2–2.8 kg-m, 16–20 ft-lb)
Cam sprocket bolt	17–23 N·m (1.7–2.3 kg-m, 12–17 ft-lb)
Valve adjusting screw lock nut	15–18 N·m (1.5–1.8 kg-m, 11–13 ft-lb)
Oil bolt	8–12 N·m (0.8–1.2 kg-m, 6–9 ft-lb)
Spark plug	15–20 N·m (1.5–2.0 kg-m, 11–14 ft-lb)
Cam chain tensioner lifter sealing bolt	8–12 N·m (0.8–1.2 kg-m, 6–9 ft-lb)

After '85

Oil bolt	10–14 N·m (1.0–1.4 kg-m, 7–10 ft-lb)
----------	--------------------------------------

TOOLS

Special

Valve guide reamer, 5.5 mm	07984–0980000
----------------------------	---------------

Common

Valve guide remover, 5.5 mm	07742–0010100 or 07942–3290100
Valve spring compressor	07757–0010000 or 07957–3290001

TROUBLESHOOTING

Engine top-end problems usually affect engine performance. These problems can be diagnosed by a compression test, or by tracing engine noises to the top-end with a sounding rod or stethoscope.

Low compression

1. Valves:
 - Incorrect valve adjustment
 - Burned or bent valve
 - Incorrect valve timing
 - Weak valve spring
2. Cylinder head:
 - Leaking or damaged head gasket
 - Warped or cracked cylinder head
3. Cylinder and piston (Section 7)

High compression

- Excessive carbon build-up on piston crown or on combustion chamber

Excessive noise

1. Incorrect valve adjustment
2. Sticking valve or broken valve spring
3. Damaged or worn rocker arm or camshaft
4. Worn or damaged cam chain
5. Worn or damaged cam chain tensioner

Poor idling

- Compression too low

CYLINDER HEAD COVER REMOVAL/DISASSEMBLY

REMOVAL

Remove the fuel tank (page 4-3).

Remove the upper engine hanger plate bolts and the plates.

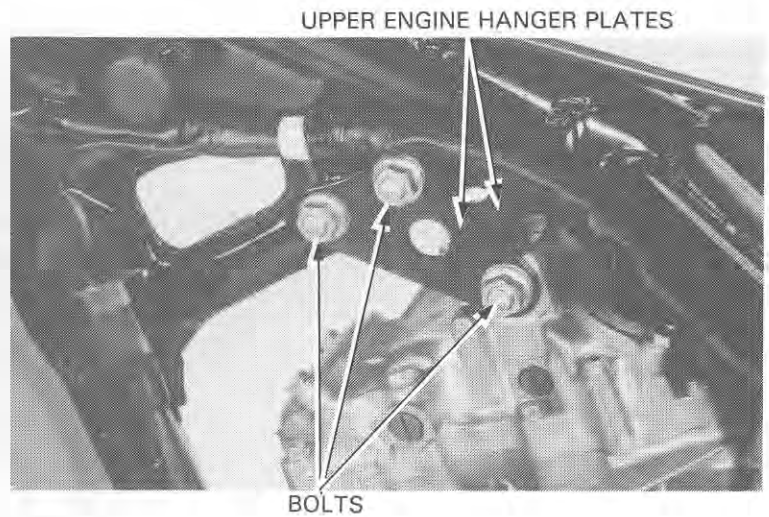

Remove the following:

- oil bolt and two sealing washers.
- valve adjusting hole covers.
- cylinder head cover bolts.

NOTE

Loosen the bolts in 2-3 steps in a crisscross pattern, starting with the center bolt.

- cylinder head cover.
- dowel pins.

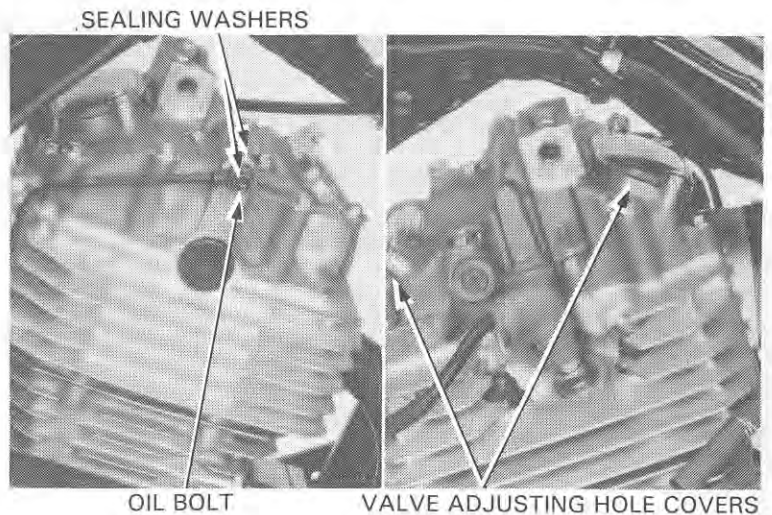

Disassembly

Groove each rocker arm shaft dowel pin with a grinder and drive the dowel pins out using a screwdriver as shown.

Remove the rocker arm shafts and rocker arms from the cylinder head cover.

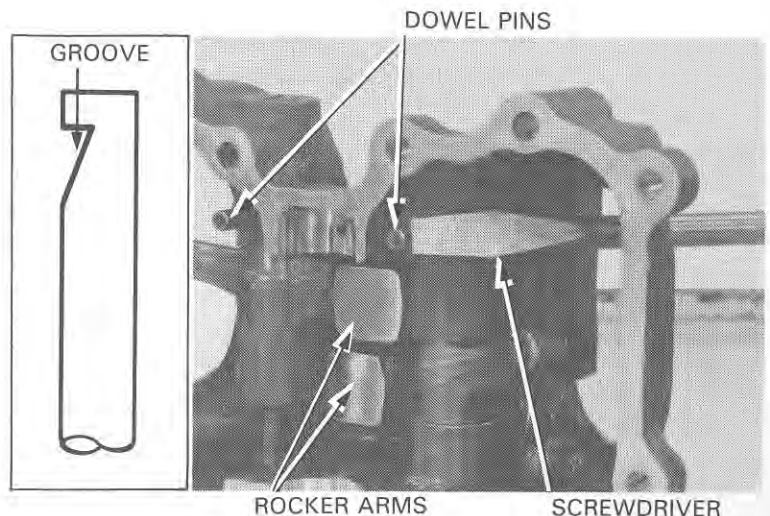

CYLINDER HEAD/VALVES

ROCKER ARM/SHAFT INSPECTION

Inspect the rocker arms and shafts for wear or damage.

NOTE

If any rocker arms require servicing or replacement, inspect the cam lobes for scoring, chipping or flat spots.

Measure the I.D. of each rocker arm.

SERVICE LIMIT: 12.05 mm (0.474 in)

Measure the O.D. of each rocker arm shaft.

SERVICE LIMIT: 11.92 mm (0.469 in)

Calculate rocker arm-to-shaft clearance.

SERVICE LIMIT: 0.08 mm (0.003 in)

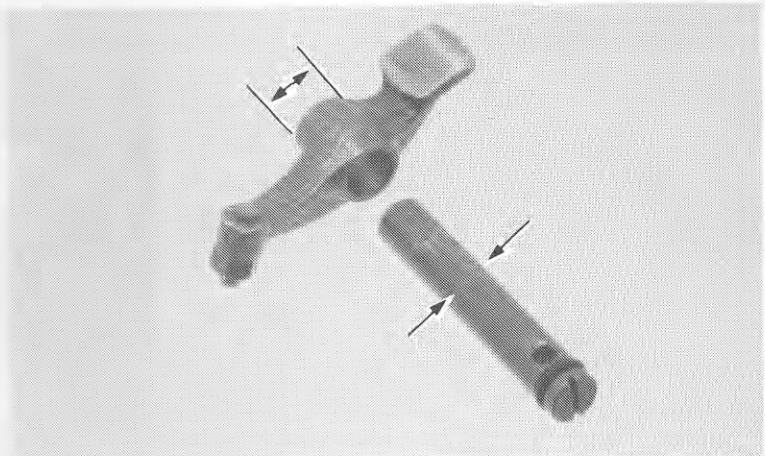

CAM CHAIN TENSIONER LIFTER

REMOVAL/DISASSEMBLY

Remove the two bolts attaching the cam chain tensioner lifter and the lifter

'85: '86:

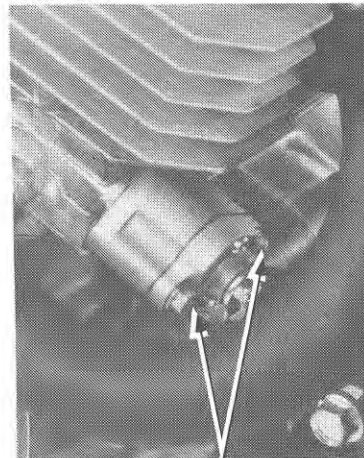

BOLTS

AFTER '86:

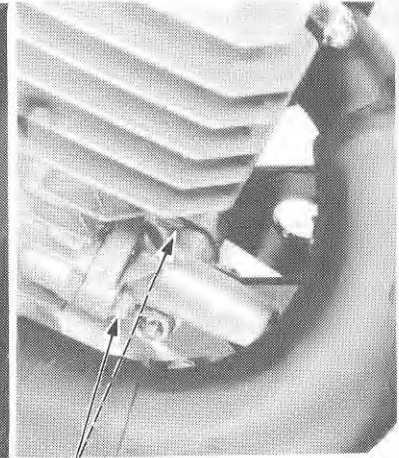

BOLTS

'85, '86:

Remove the two screws holding the cam chain tensioner lifter and disassemble.

AFTER '86:

Remove the snapping and disassemble the cam chain tensioner.

'85: '86: SCREWS

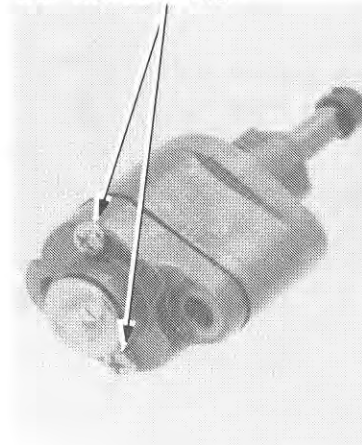

AFTER '86: SNAPRING

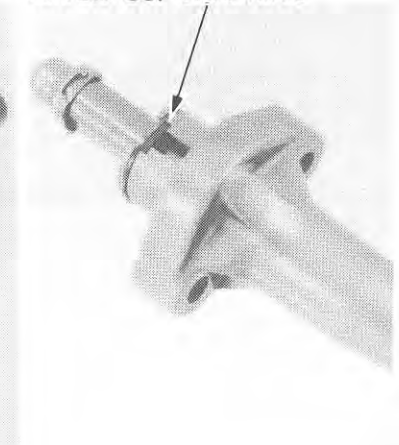

INSPECTION

Check all tensioner lifter parts for wear or damage and replace if necessary.

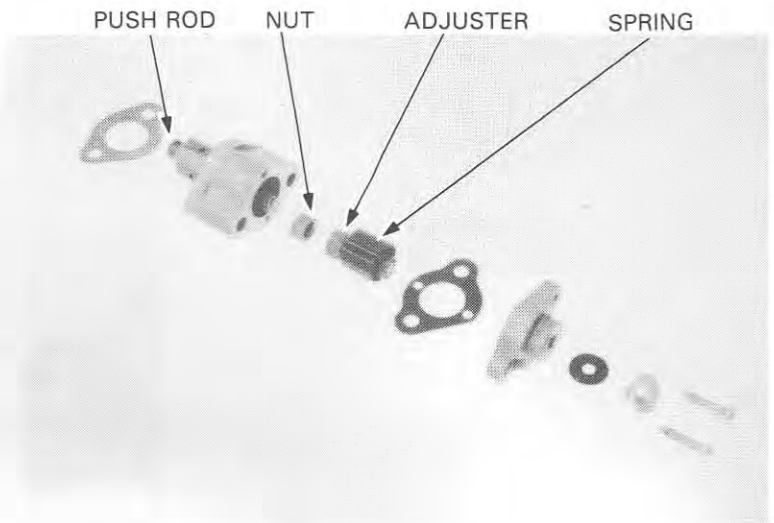

AFTER '86:

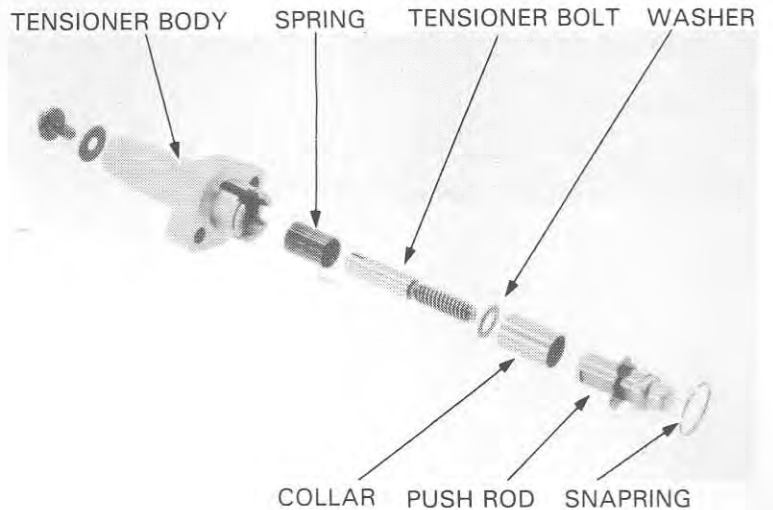

CAMSHAFT REMOVAL

REMOVAL

Remove the timing and flywheel bolt hole caps.

Turn the flywheel clockwise and remove the cam sprocket bolts and cam sprocket.

Remove the camshaft.

Suspend the cam chain with a piece of wire to prevent it from falling into the crankcase.

Remove the camshaft end cap.

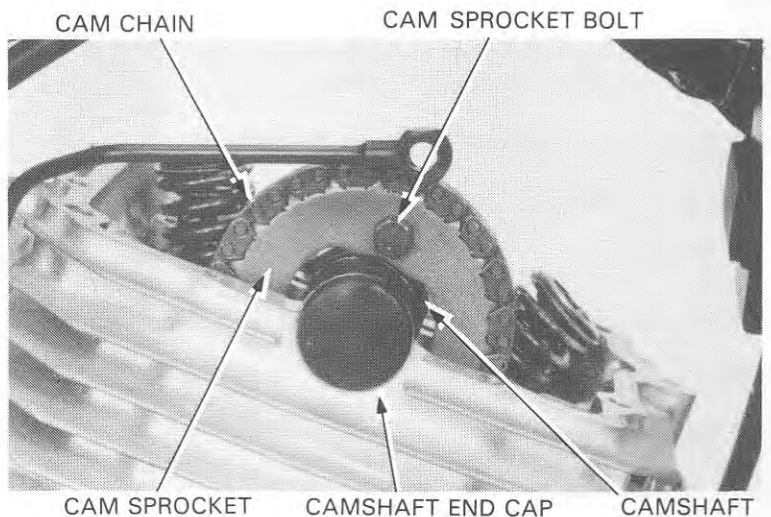

CYLINDER HEAD/VALVES

INSPECTION

Using a micrometer, measure the height of each cam lobe and inspect it for wear or damage.

SERVICE LIMITS:

INTAKE: 36.026 mm (1.4183 in)
EXHAUST: 35.897 mm (1.4133 in)

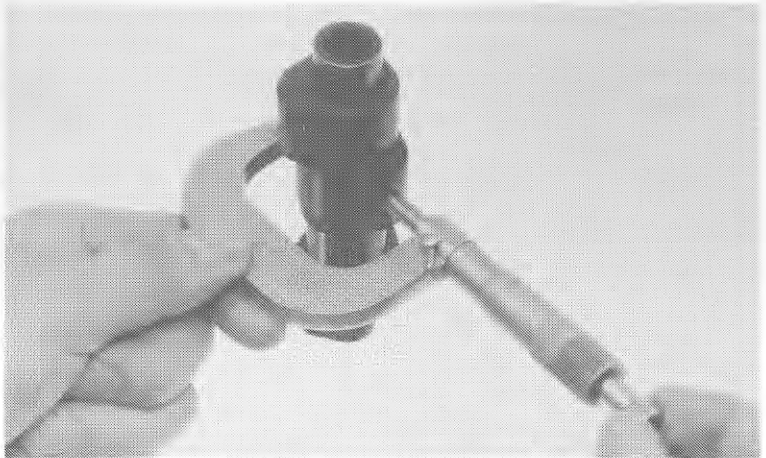

Measure the camshaft journal O.D.

SERVICE LIMITS:

Left: 19.90 mm (0.784 in)
Right: 23.90 mm (0.941 in)
Center: 23.88 mm (0.940 in)

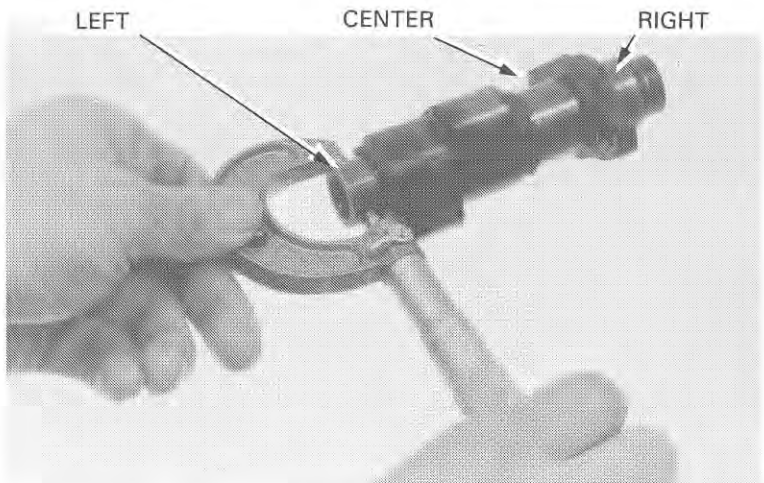

Install the cylinder head cover and tighten the cover bolts in a crisscross pattern in 2–3 steps.

TORQUE: 8–12 N·m (0.8–1.2 kg–m, 6–9 ft–lb)

Measure the camshaft journal bearing I.D.

SERVICE LIMITS:

Left: 20.05 mm (0.789 in)
Right and center: 24.05 mm (0.947 in)

Calculate camshaft-to-bearing clearance.

SERVICE LIMITS:

Left: 0.10 mm (0.004 in)
Right and center: 0.10 mm (0.004 in)

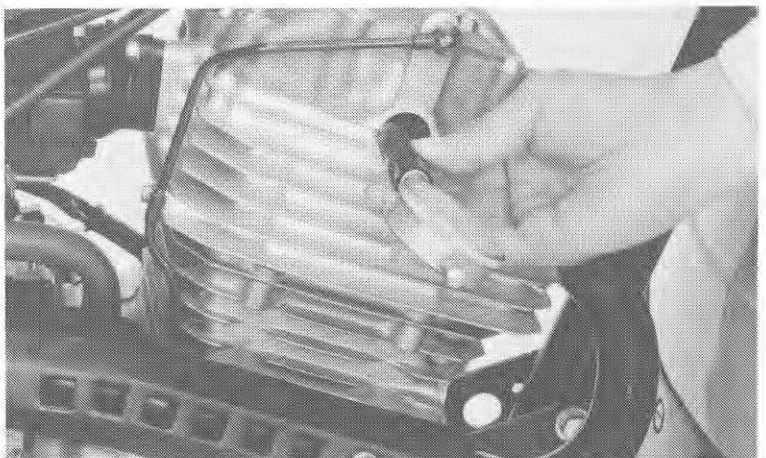

CYLINDER HEAD REMOVAL

Remove the carburetor (page 4-6) and exhaust pipe (page 13-3).

Remove the oil pipe mount bolt, oil bolt, two sealing washers and oil pipe.

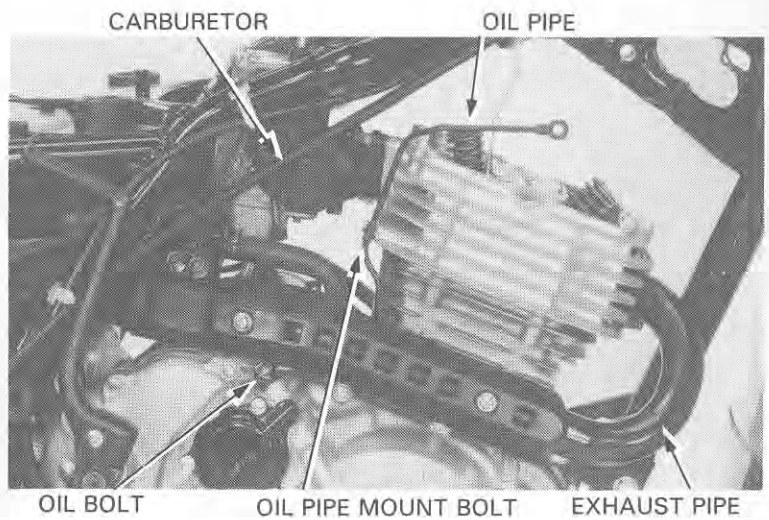

Remove the cylinder head cap nuts and socket bolts in a crisscross pattern in 2–3 steps.

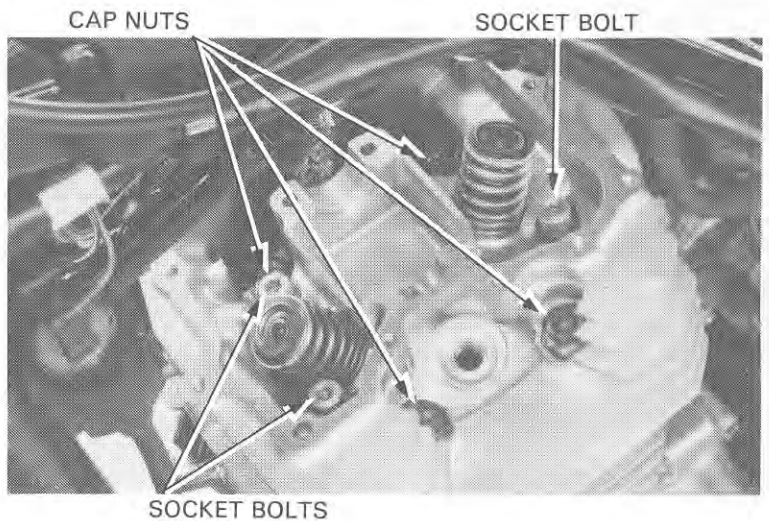

Raise and rotate the cylinder head clockwise and remove it from the right side as shown.

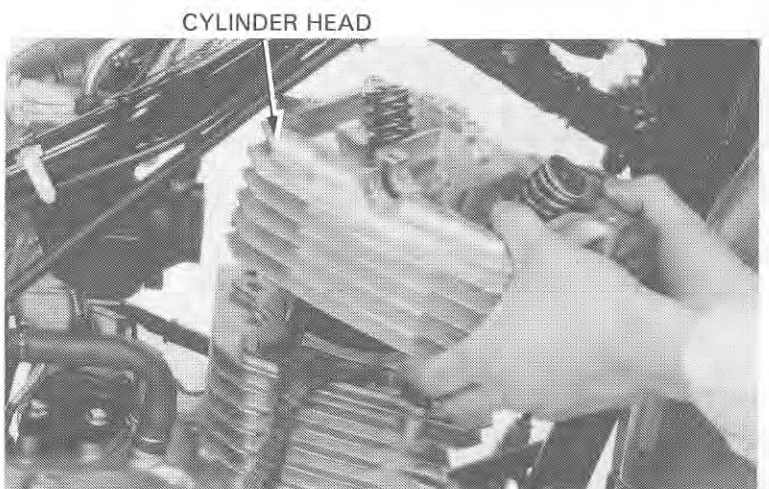

CYLINDER HEAD/VALVES

Remove the cylinder head gasket, dowel pins and cam chain guide.

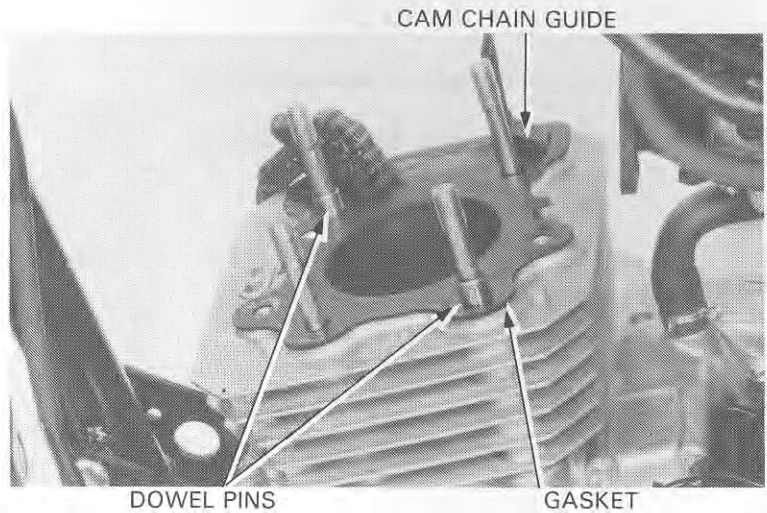

CYLINDER HEAD DISASSEMBLY

Remove the valve spring cotters, retainers, springs and valves with the Valve Spring Compressor.

CAUTION

- *To prevent loss of tension, do not compress the valve springs more than necessary to remove the cotters.*

NOTE

- Mark all parts during disassembly so they can be placed back in their original locations.

Remove the valve stem seals and valve spring seats.

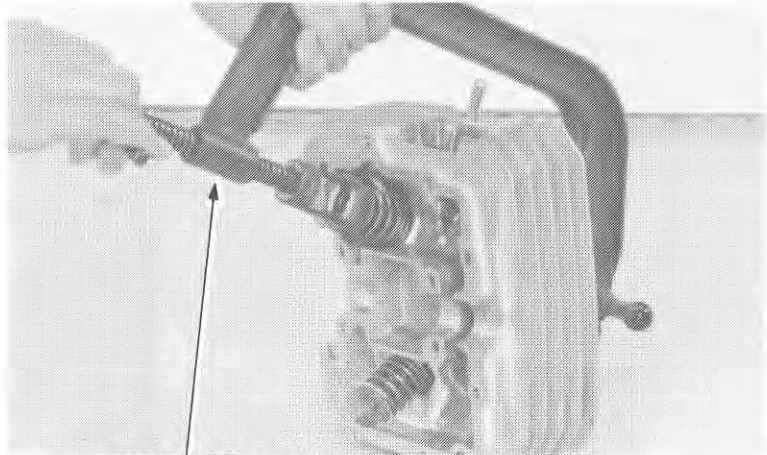

07757-0010000 OR 07959-3290001

INSPECTION

Remove carbon deposits from the combustion chamber.

Check the spark plug hole and valve areas for cracks.

Check the cylinder head for warpage with a straight edge and feeler gauge.

SERVICE LIMIT: 0.10 mm (0.004 in)

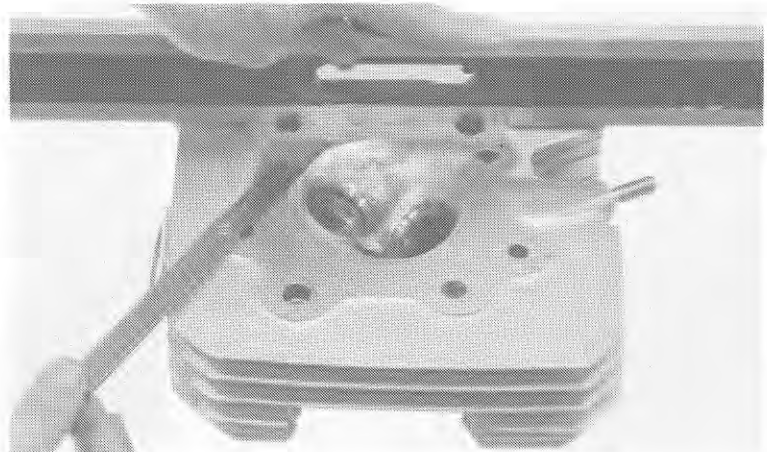

VALVE SPRINGS

Measure the free length of the inner and outer valve springs.

SERVICE LIMITS:

Inner (IN): 35.2 mm (1.39 in)

(EX): 35.2 mm (1.39 in)

Outer (IN): 38.0 mm (1.50 in)

(EX): 38.0 mm (1.50 in)

Replace the springs if they are shorter than the service limits.

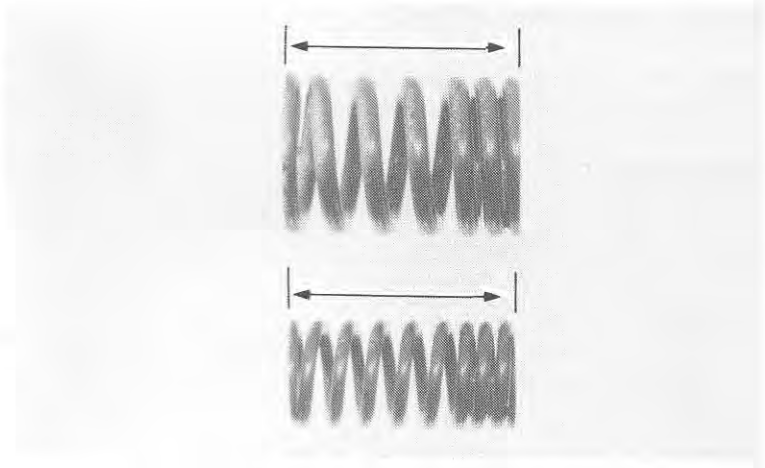

VALVE STEM-TO-GUIDE CLEARANCE

Inspect each valve for bending, burning or abnormal stem wear.

Check valve movement in the guide and measure and record each valve stem O.D.

SERVICE LIMITS: IN: 5.45 mm (0.215 in)

EX: 5.43 mm (0.214 in)

NOTE

Ream the guides to remove any carbon deposits before checking clearances.

Measure and record each valve guide I.D.

SERVICE LIMIT: 5.525 mm (0.2175 in)

Subtract each valve stem O.D. from the corresponding guide I.D. to obtain the stem to guide clearance.

SERVICE LIMITS: IN: 0.12 mm (0.005 in)

EX: 0.14 mm (0.006 in)

If the stem-to-guide clearance exceeds the service limits, determine if a new guide with standard dimensions would bring the clearance within tolerance. If so, replace any guides as necessary and ream to fit.

If the stem-to-guide clearance exceeds the service limits with new guides, also replace the valves.

NOTE

Reface the valve seats whenever the valve guides are replaced.

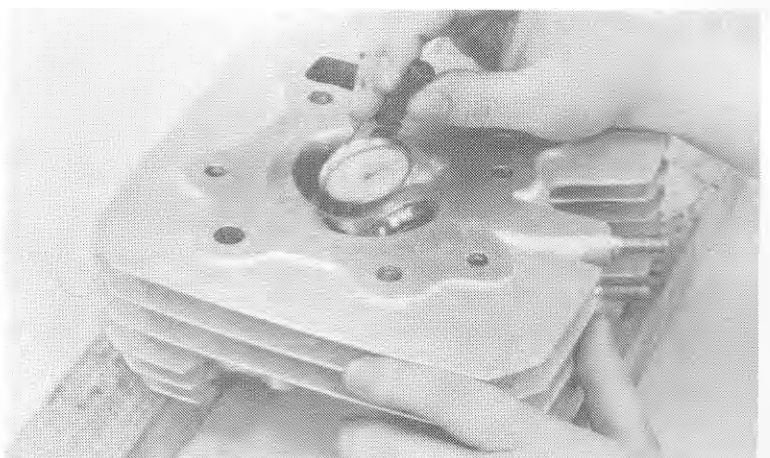

CYLINDER HEAD/VALVES

VALVE GUIDE REPLACEMENT

Heat the cylinder head to 100–150°C (212–300°F) with a hot plate or oven.

WARNING

To avoid burns, wear heavy gloves when handling the heated cylinder head.

CAUTION

Do not use a torch to heat the cylinder head; it may cause warping.

Support the cylinder head and drive out the old guides from the combustion chamber side of the cylinder head.

CAUTION

Avoid damaging the cylinder head.

Place a new O-ring on the new valve guide. Drive in the guide from the top of the head.

NOTE

Inspect the valve guide for damage.

VALVE GUIDE REMOVER
07742-0010100 OR 07942-3290100

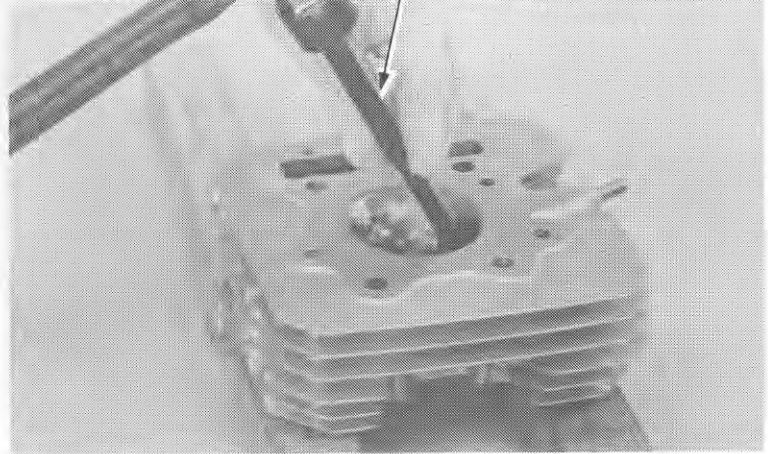

VALVE GUIDE REMOVER
07742-0010100 OR 07942-3290100

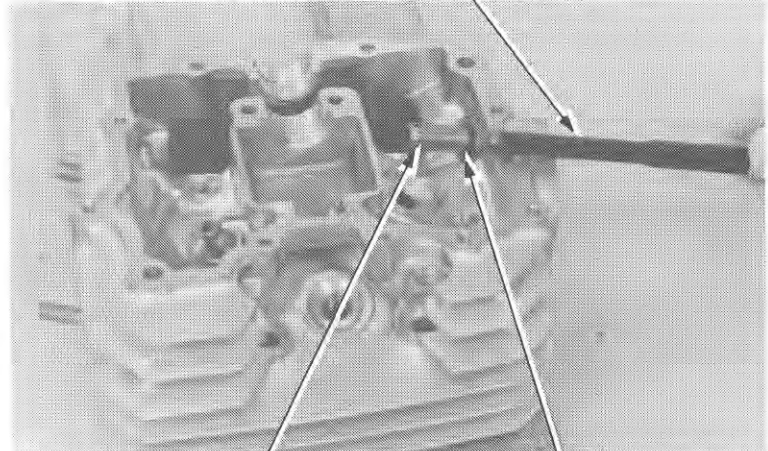

VALVE GUIDE

O-RING

Ream the new valve guide after installation.

NOTE

- Use cutting oil on the reamer during this operation.
- Always rotate the reamer in the same direction.

Clean the cylinder head thoroughly to remove any metal particles.
Reface the valve seat (page 6-11).

VALVE GUIDE REAMER
07984-0980000

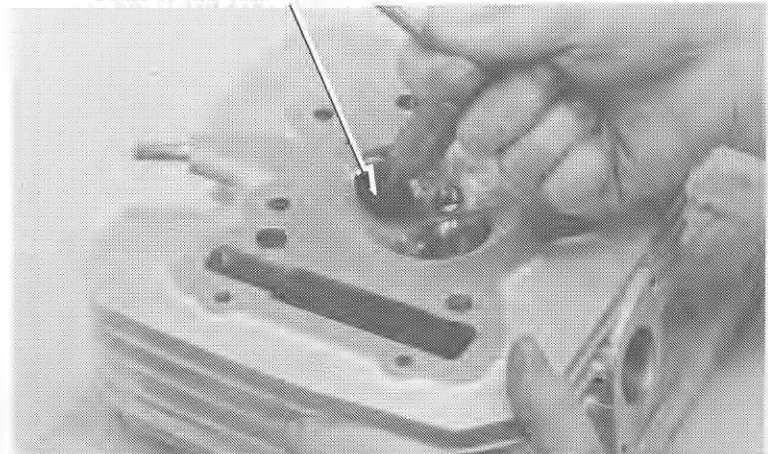

VALVE SEAT INSPECTION/ REFACING

Clean all intake and exhaust valves thoroughly to remove carbon deposits.

Apply a light coating of Prussian Blue to each valve seat. Lap each valve and seat using a rubber hose or other hand-lapping tool.

Remove and inspect each valve.

CAUTION

The valve cannot be ground. If the valve face is burned or badly worn or if it contacts the seat unevenly, replace the valve.

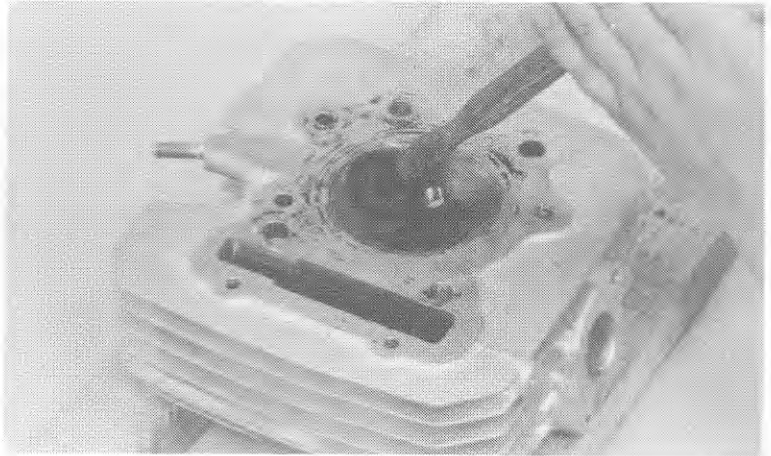

Inspect the width of each valve seat.

STANDARD: 1.2 mm (0.05 in)

SERVICE LIMIT: 1.5 mm (0.06 in)

If the seat is too wide, too narrow or has low spots, the seat must be ground.

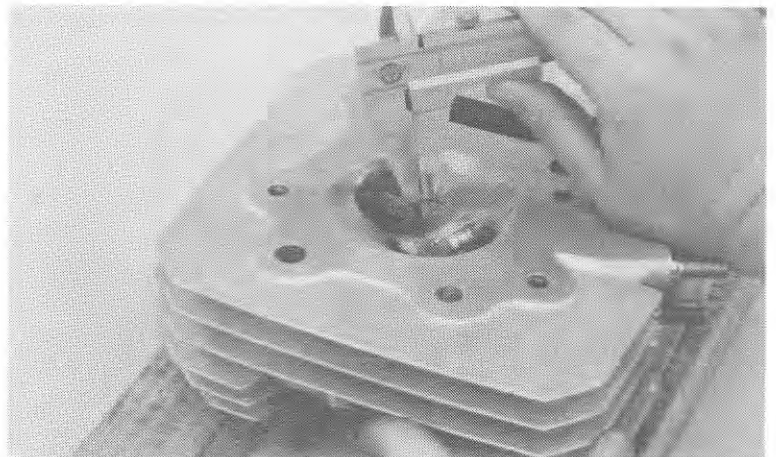

VALVE SEAT CUTTERS

Honda Valve Seat Cutters, grinder or equivalent valve seat refacing equipment are recommended to correct a worn valve seat.

NOTE

Follow the refacer manufacturer's operating instructions.

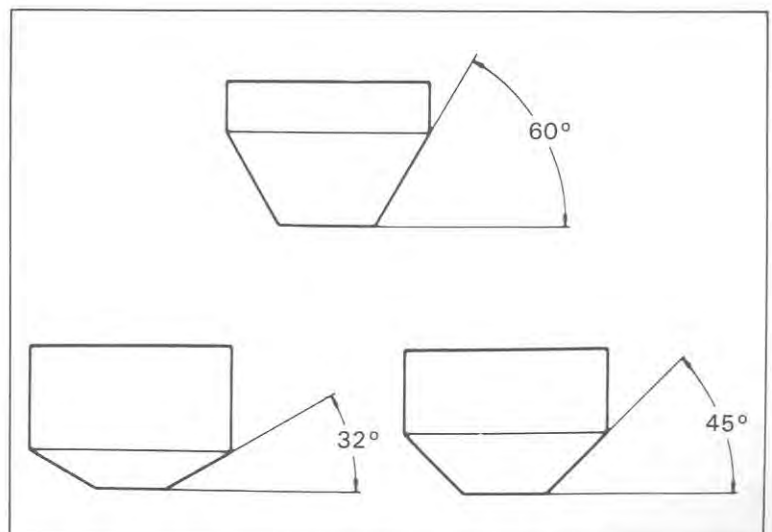

CYLINDER HEAD/VALVES

VALVE SEAT REFACING

Use a 45 degree cutter to remove any roughness or irregularities from the seat.

NOTE

Reface the seat with a 45 degree cutter when a valve guide is replaced.

Use a 32 degree cutter to remove the top 1/4 of the existing valve seat material.

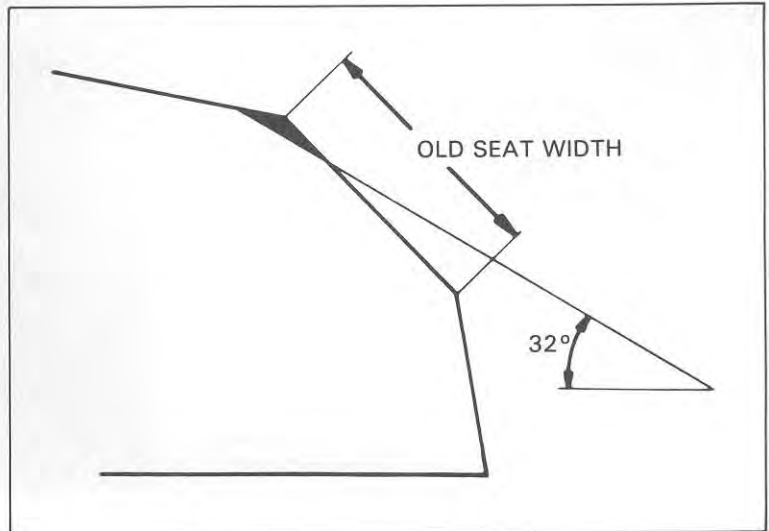

Use a 60 degree cutter to remove the bottom 1/4 of the old seat. Remove the cutter and inspect the area you have refaced.

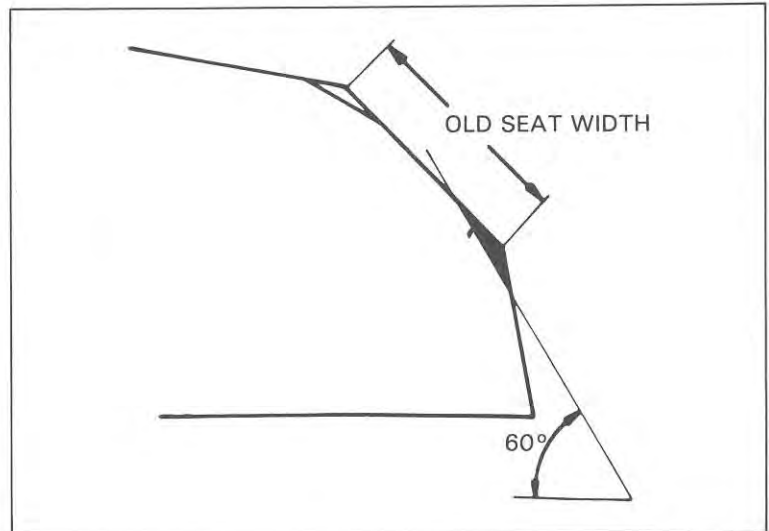

Install a 45 degree finish cutter and cut the seat to the proper width. Make sure that all pitting and irregularities are removed. Refinish if necessary.

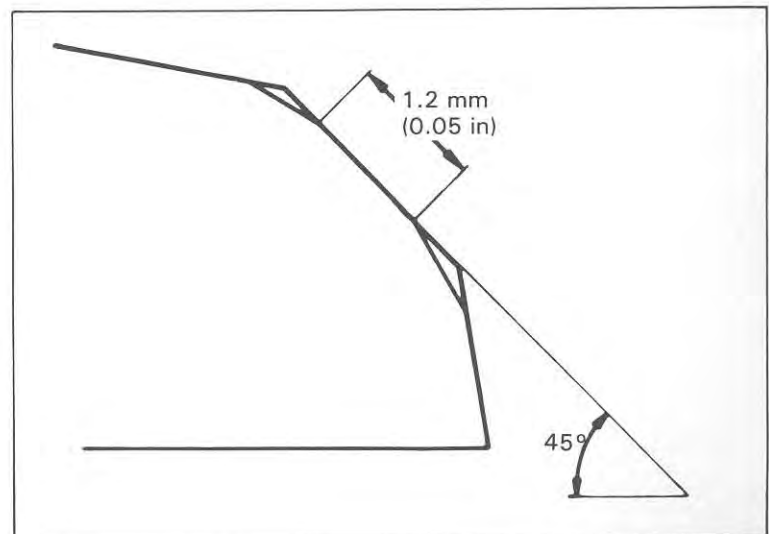

Apply a thin coating of Prussian Blue to the valve seat. Press the valve through the valve guide and onto the seat to make a clear pattern.

NOTE

The location of the valve seat in relation to the valve face is very important for good sealing.

If the contact area is too high on the valve, the seat must be lowered using a 32 degree flat cutter.

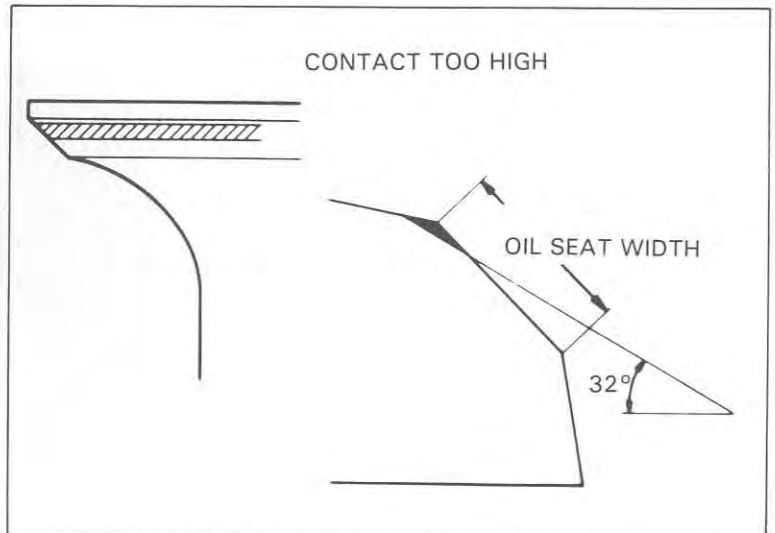

If the contact area is too low on the valve, the seat must be raised using a 60 degree inner cutter.

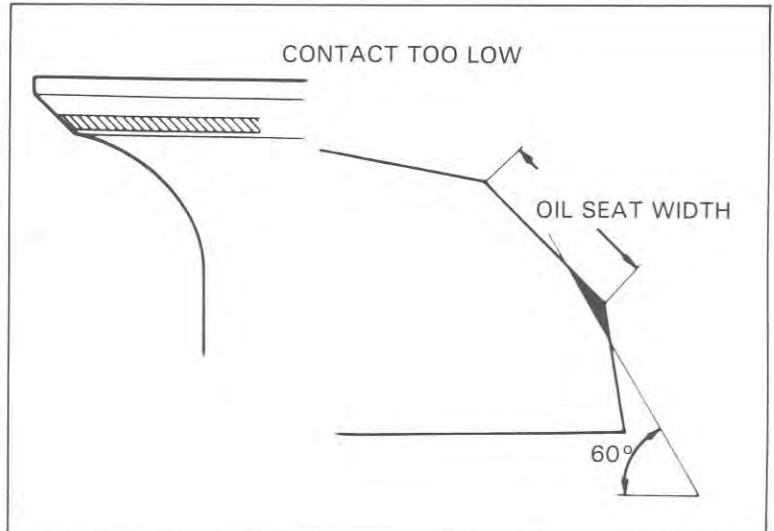

Refinish the seat to specifications, using a 45 degree finish cutter.

After cutting the seat, apply lapping compound to the valve face, and lap the valve using light pressure.

After lapping, wash all residual compound off the cylinder head and valve.

NOTE

Do not allow lapping compound to enter the guides.

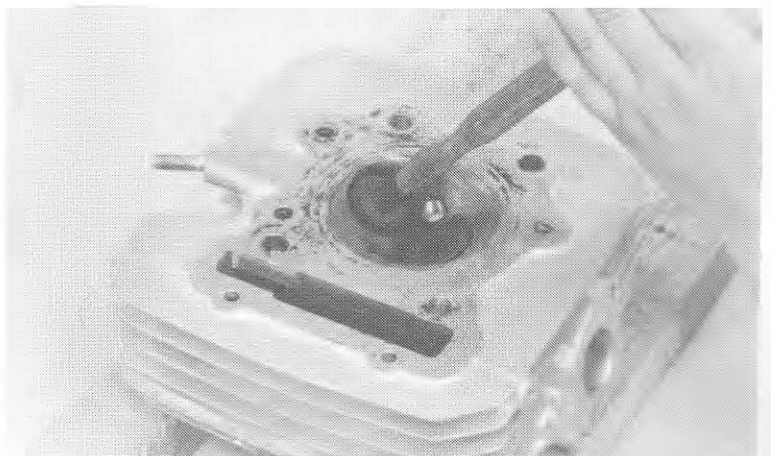

CYLINDER HEAD ASSEMBLY

Install the valve spring seat and a new stem seal. Lubricate each valve stem with molybdenum disulfide grease and insert the valve into the valve guide.

To avoid damage to the stem seal, turn the valve slowly when inserting.

Install the valve springs with the tightly wound coils facing the cylinder head.

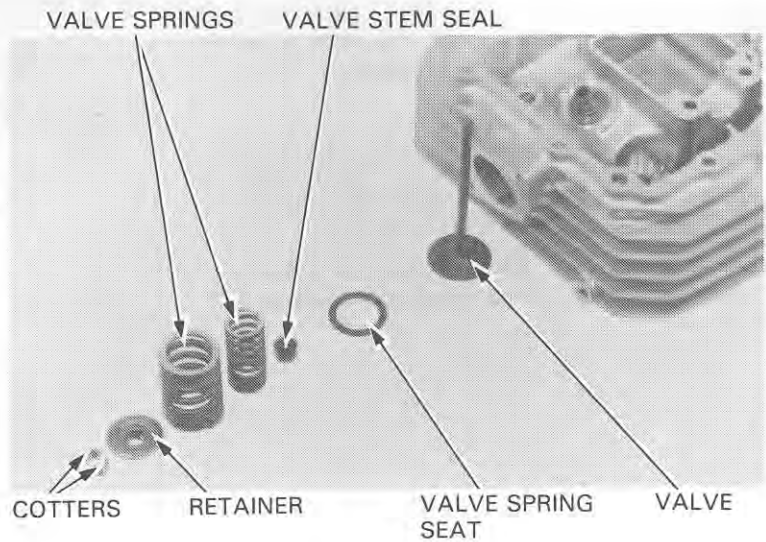

Install the valve spring retainers and install the valve cotters.

CAUTION

To prevent loss of tension, do not compress the valve spring more than necessary.

VALVE SPRING COMPRESSOR
07757-0010000 OR 07957-3290001

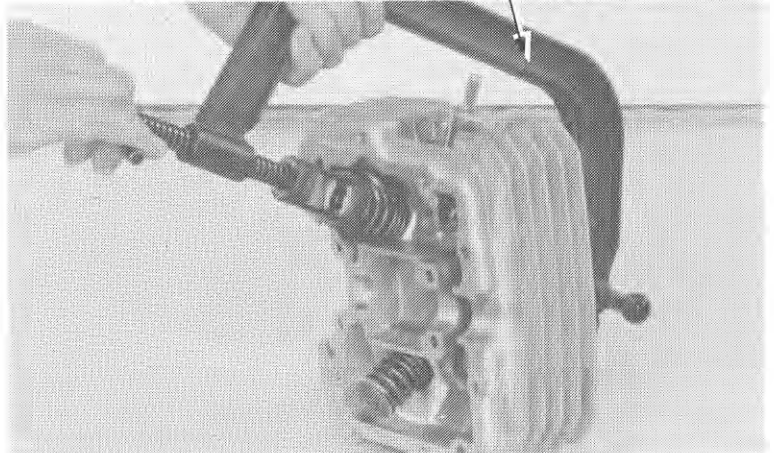

Tap the valve stems gently with a plastic hammer to firmly seat the cotters.

CAUTION

Support the cylinder head above the work bench surface to prevent possible valve damage.

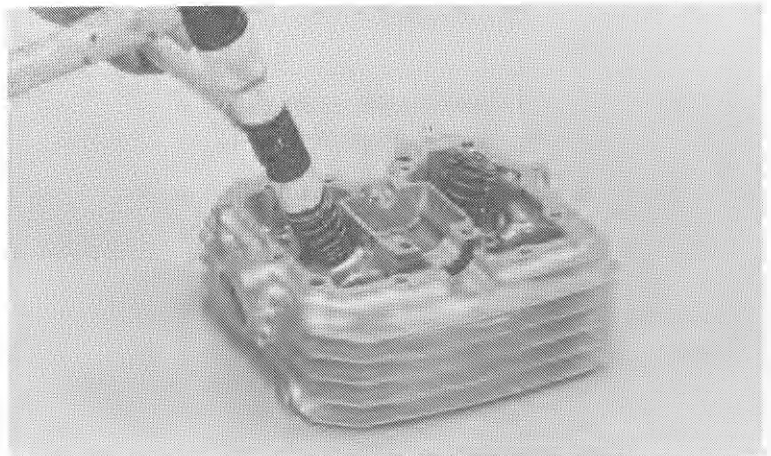

CYLINDER HEAD INSTALLATION

Clean off any gasket material from the cylinder surface.

Place the bottom end of the cam chain guide into the groove in the right crankcase, and its bosses with the grooves in the cylinder upper surface. Install the dowel pins and a new cylinder head gasket.

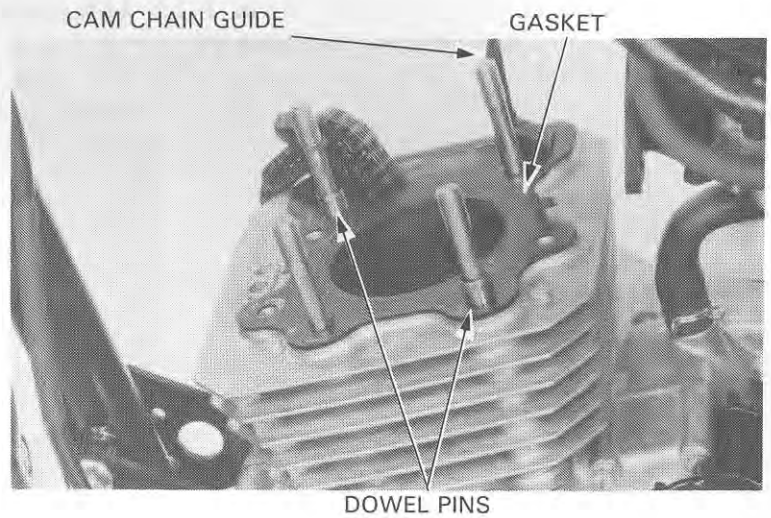

Install the cylinder head, cylinder head cap nuts and socket bolts in the sequence shown in 2-3 steps.

TORQUE VALUES:

CAP NUT: 35–45 N·m
(3.5–4.5 kg·m, 25–33 ft·lb)

SOCKET BOLT: 22–28 N·m
(2.2–2.8 kg·m, 16–20 ft·lb)

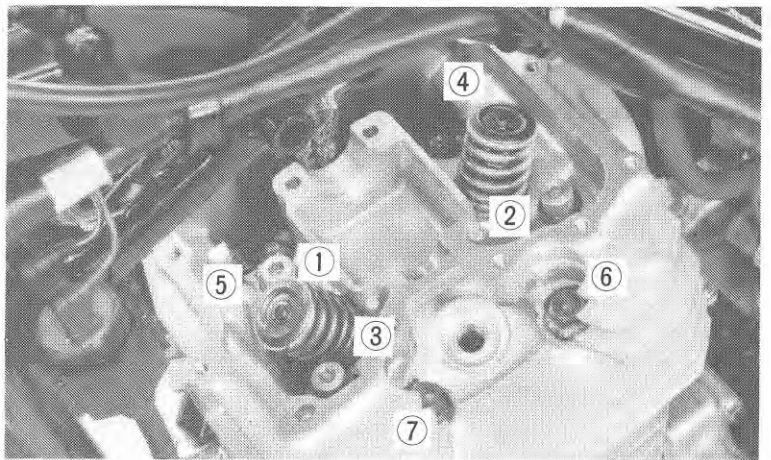

Make sure that the oil pipe and oil bolts are not clogged and the sealing washers are in good condition.

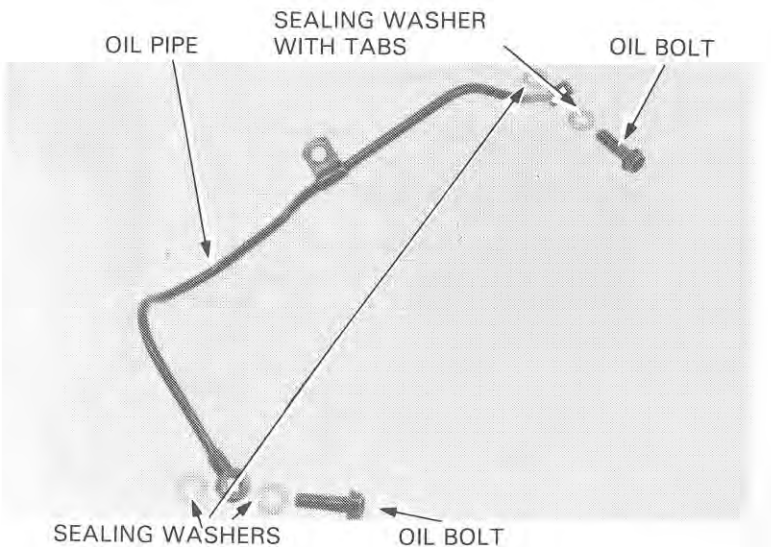

CYLINDER HEAD/VALVES

Install the oil pipe, oil bolt and 6 mm bolt using the two sealing washers.

TORQUE:

Oil bolt: 8–12 N·m
(0.8–1.2 kg-m, 6–9 ft-lb)

After '85: 10–14 N·m
(1.0–1.4 kg-m, 7–10 ft-lb)

Install the exhaust pipe (page 13-3) and carburetor (page 4-15).

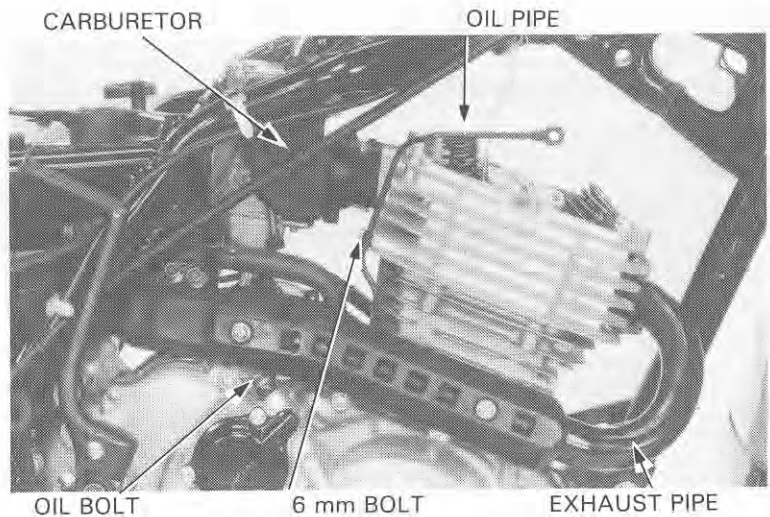

CAMSHAFT INSTALLATION

Align the "T" mark on the flywheel with the index mark on the alternator cover by turning the flywheel clockwise.

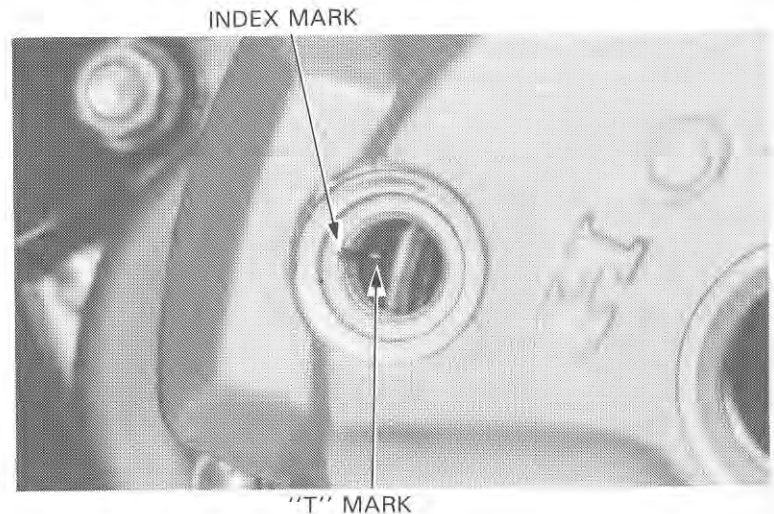

Apply molybdenum disulfide grease to the camshaft journals.

Install the cam sprocket, camshaft and end cap. Position the cam lobes down and align the timing marks on the cam sprocket with the cylinder head upper surface.

Install the cam chain over the cam sprocket and the cam sprocket onto the shoulder of the camshaft.

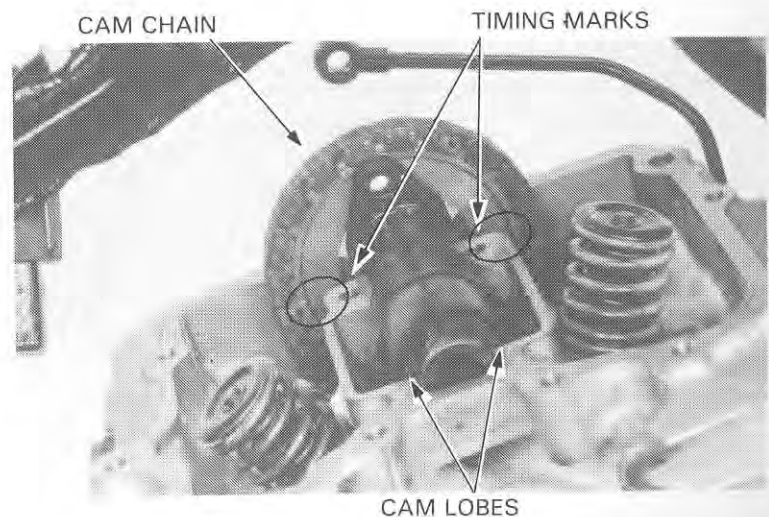

Tighten the cam sprocket bolt.
Turn the crankshaft clockwise one turn and tighten
the remaining cam sprocket bolt to the same torque.

TORQUE: 17–23 N·m
(1.7–2.3 kg-m, 12–17 ft-lb)

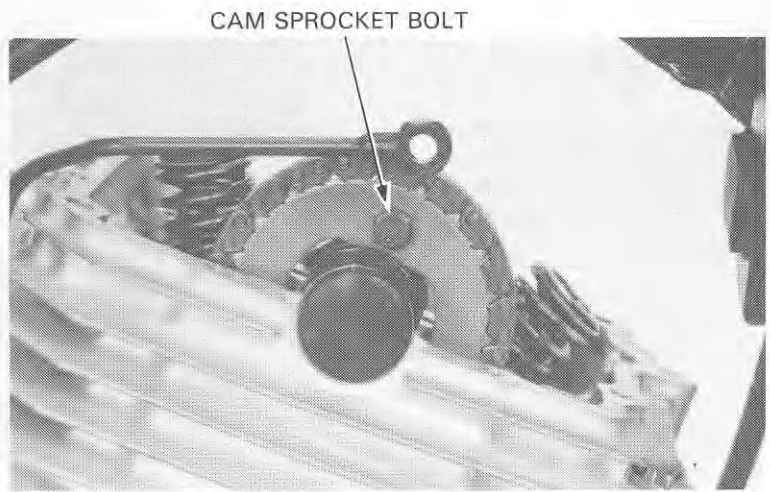

Realign the "T" mark with index mark and recheck
the cam sprocket timing marks.

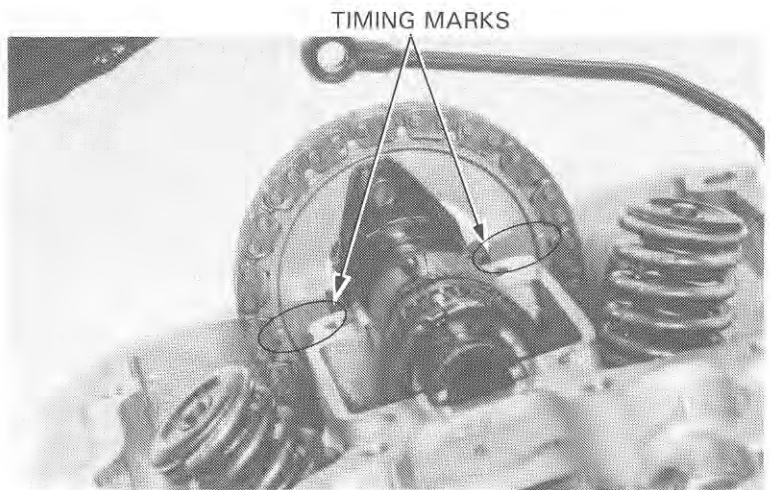

Fill the oil pocket in the cylinder head with fresh oil.

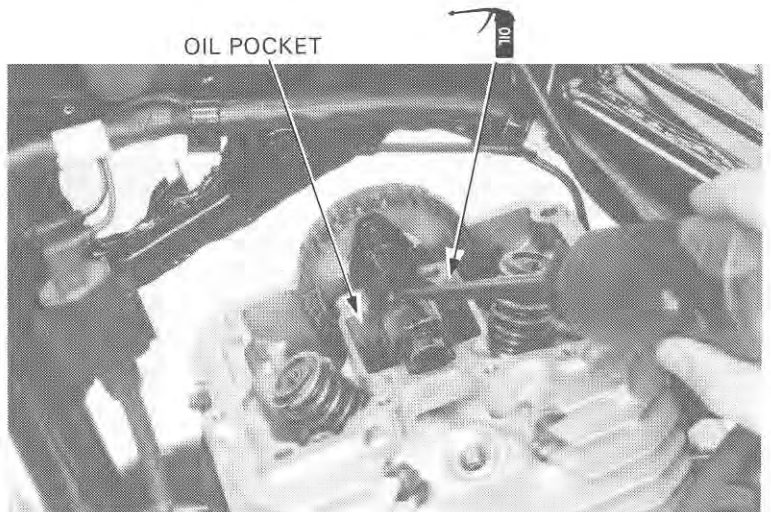

CAM CHAIN, TENSIONER LIFTER ASSEMBLY

Thread the nut on the push rod so its outside face is flush with the end of the push rod. Hook one end of the spring into the hole in the adjuster and place the adjuster over the nut.

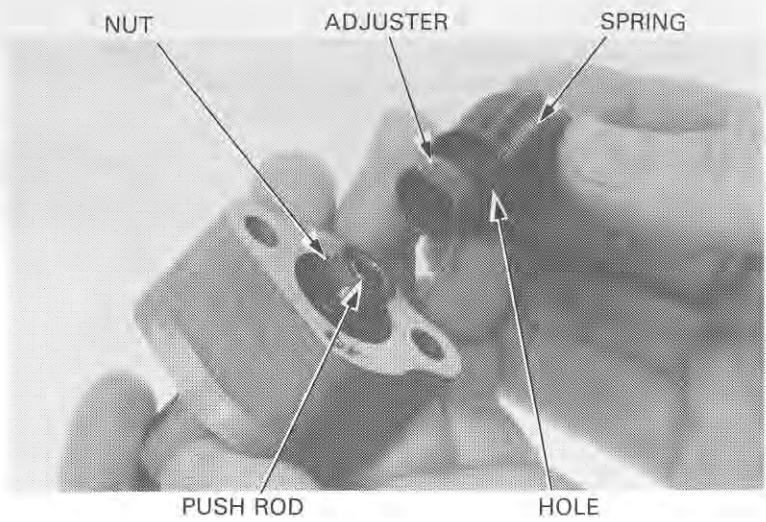

Align the spring hook with the groove in the cover and install.

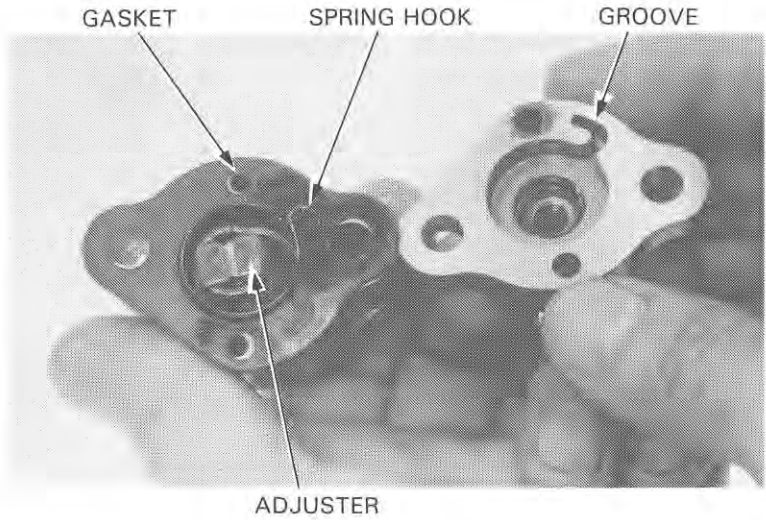

Screw in the adjuster all the way through the hole in the cover and install the tensioner lifter onto the cylinder. Tighten the two tensioner lifter mount bolts and release the adjuster. Install the sealing bolt.

TORQUE: 8–12 N·m (0.8–1.2 kg-m, 6–9 ft-lb)

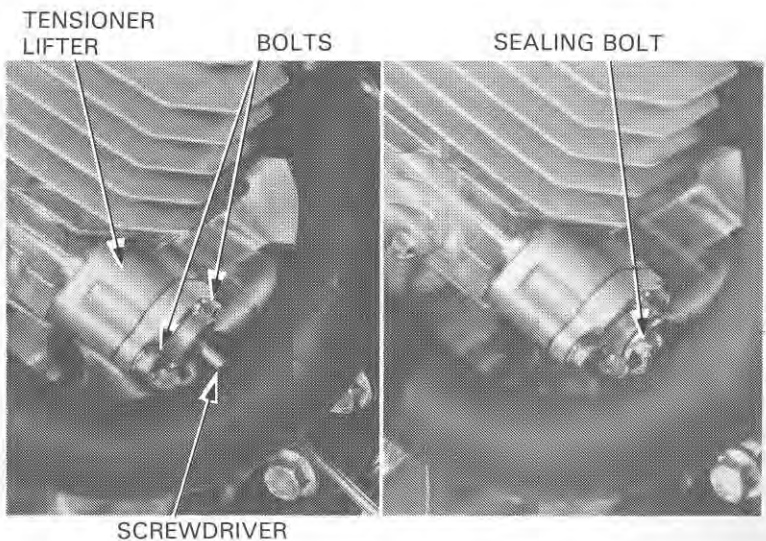

After '86:

Remove the cam chain tensioner sealing bolt and gasket from the tensioner. Turn the tensioner shaft clockwise with a small screwdriver to retract the tensioner, and hold it in the fully retracted position.

NOTE

The tensioner will be forced out by the spring when it is released.

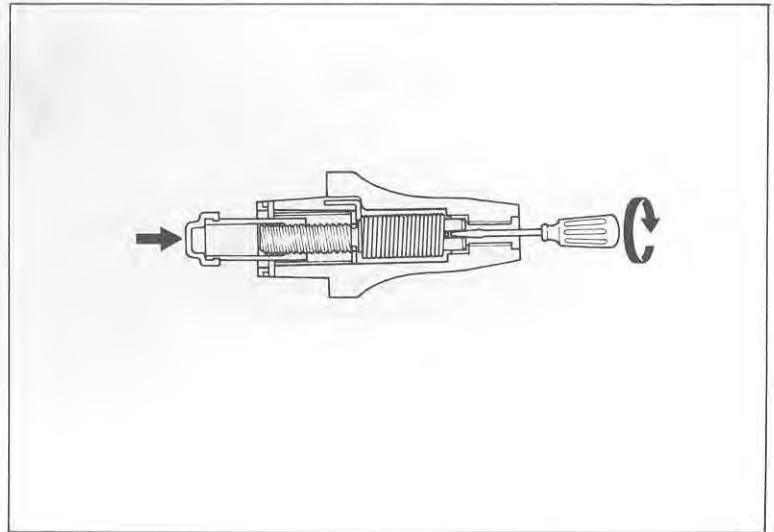

Wedge the tensioner shaft with a piece of hard wire as shown to hold the tensioner.

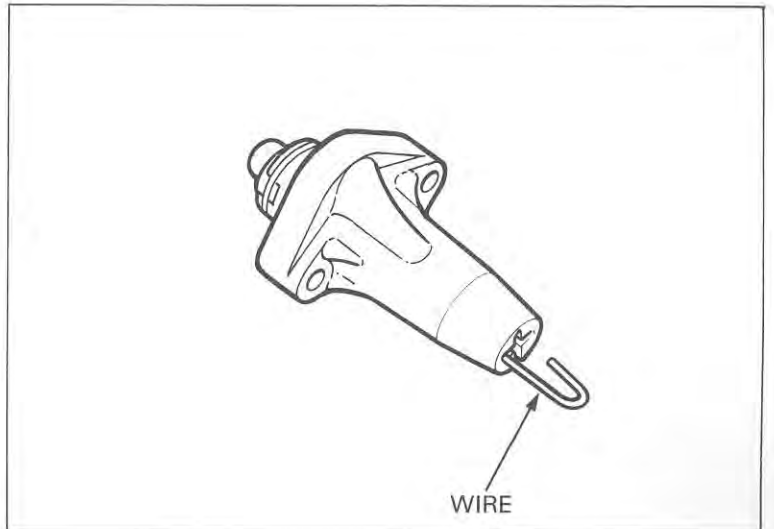

Install the cam chain tensioner gasket.

Install the cam chain tensioner and tighten the attaching bolts securely.

Remove the holder piece from the cam chain tensioner.

Install the gasket and searing bolt, and tighten the bolt securely.

TORQUE: 8–12 N·m (0.8–1.2 kg-m, 6–9 ft-lb)

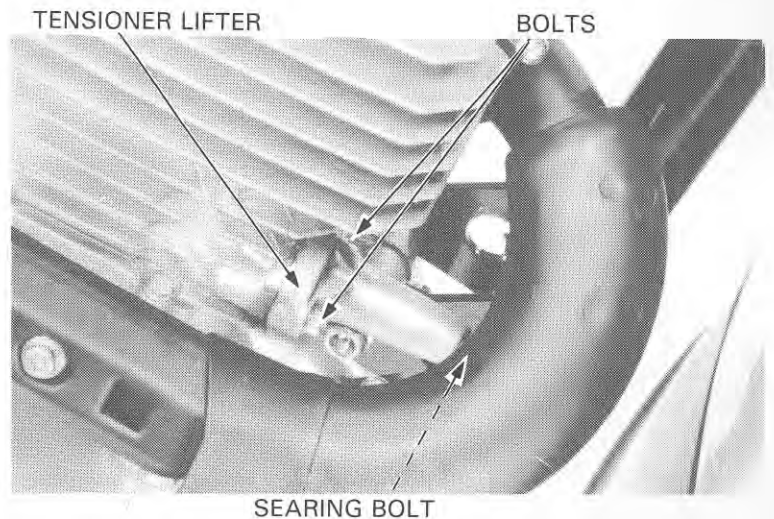

CYLINDER HEAD COVER ASSEMBLY/INSTALLATION

ASSEMBLY

Oil the rocker arm shafts and arms. Install new O-rings into the grooves of the rocker arm shafts and install the rocker arms and shafts. Align the dowel pin holes in the cylinder head cover and rocker arm shaft and install new dowel pins.

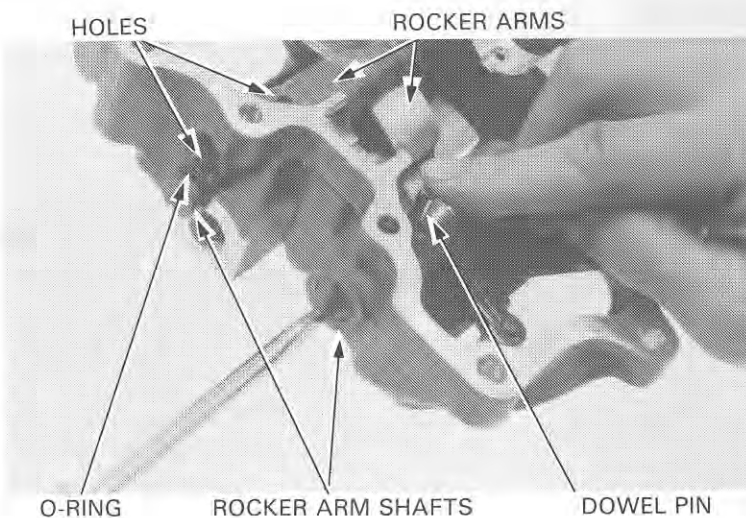

INSTALLATION

Apply liquid sealant to the mating surfaces of the cylinder head cover as shown.

NOTE

Do not apply sealant to the camshaft bearing surfaces.

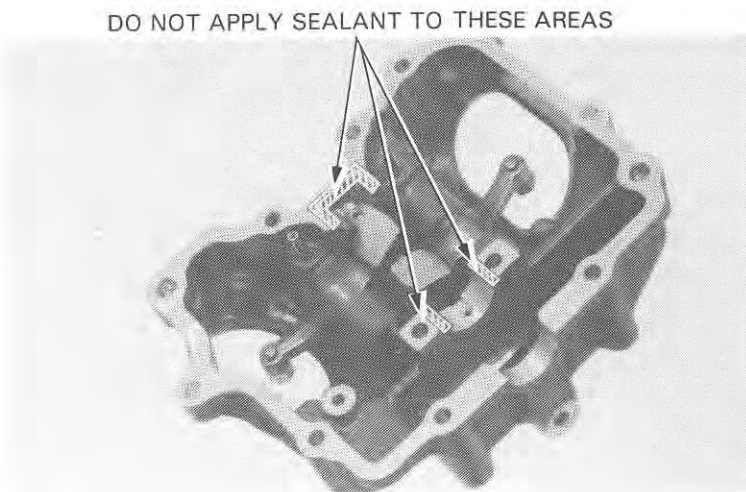

Install the two dowel pins onto the cylinder head and install the cylinder head cover.

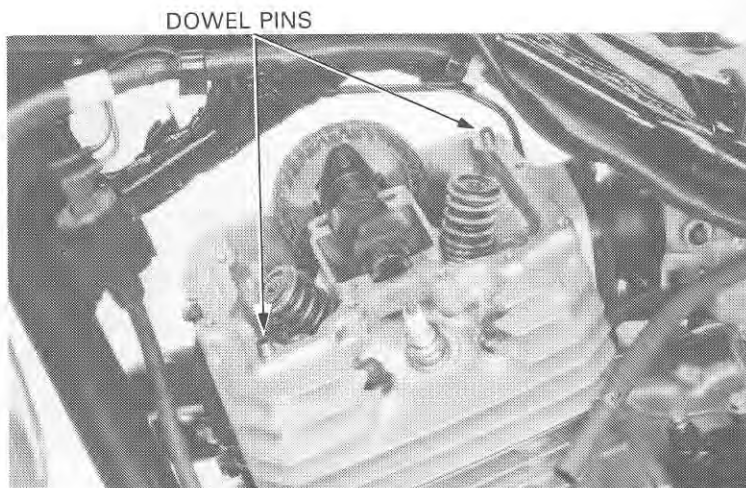

Tighten the cylinder head cover bolts in a crisscross pattern in 2-3 steps starting with the center bolt.

TORQUE: 8–12 N·m (0.8–1.2 kg·m, 6–9 ft·lb)

Connect the oil pipe to the cylinder head cover using the two sealing washers and oil bolt.

TORQUE: 8–12 N·m (0.8–1.2 kg·m, 6–9 ft·lb)

After '85 **10–14 N·m (1.0–1.4 kg·m, 7–10 ft·lb)**

Make sure the sealing washers are in good condition.

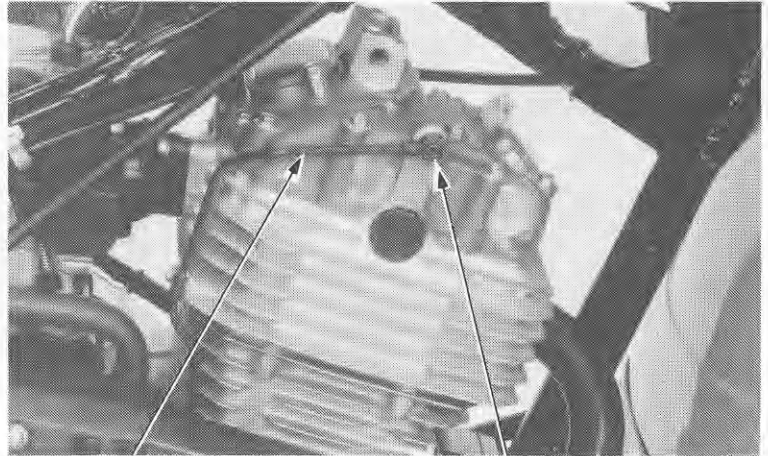

OIL PIPE

OIL BOLT

Adjust valve clearance (page 3-5).
Test cylinder compression (page 3-8).
Connect the spark plug cap to the plug.

SPARK PLUG CAP

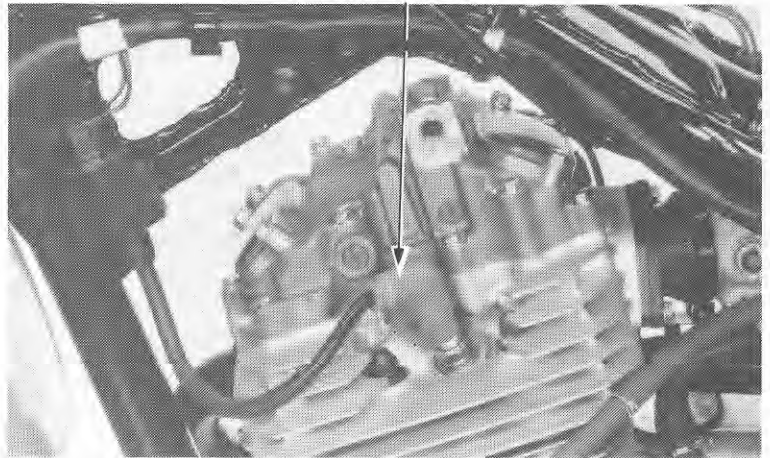

Install the upper engine hanger plates using the three bolts and nuts.

TORQUE: 40–50 N·m

(4.0–5.0 kg·m, 29–36 ft·lb)

Install the fuel tank, seat and both frame side covers.

UPPER ENGINE HANGER PLATES

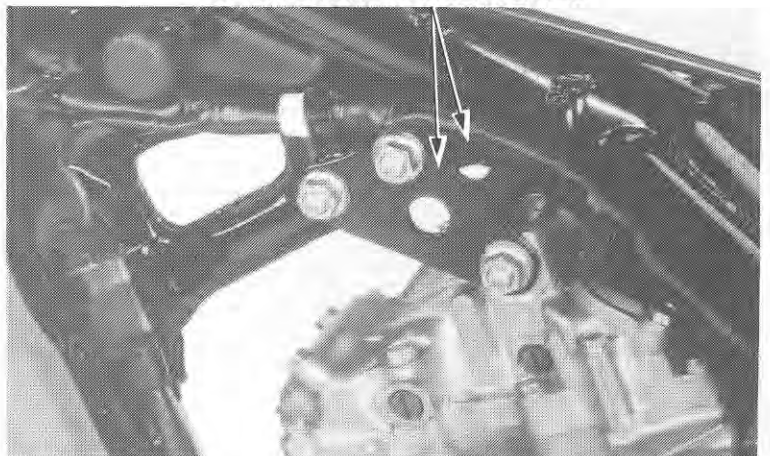

CYLINDER/PISTON

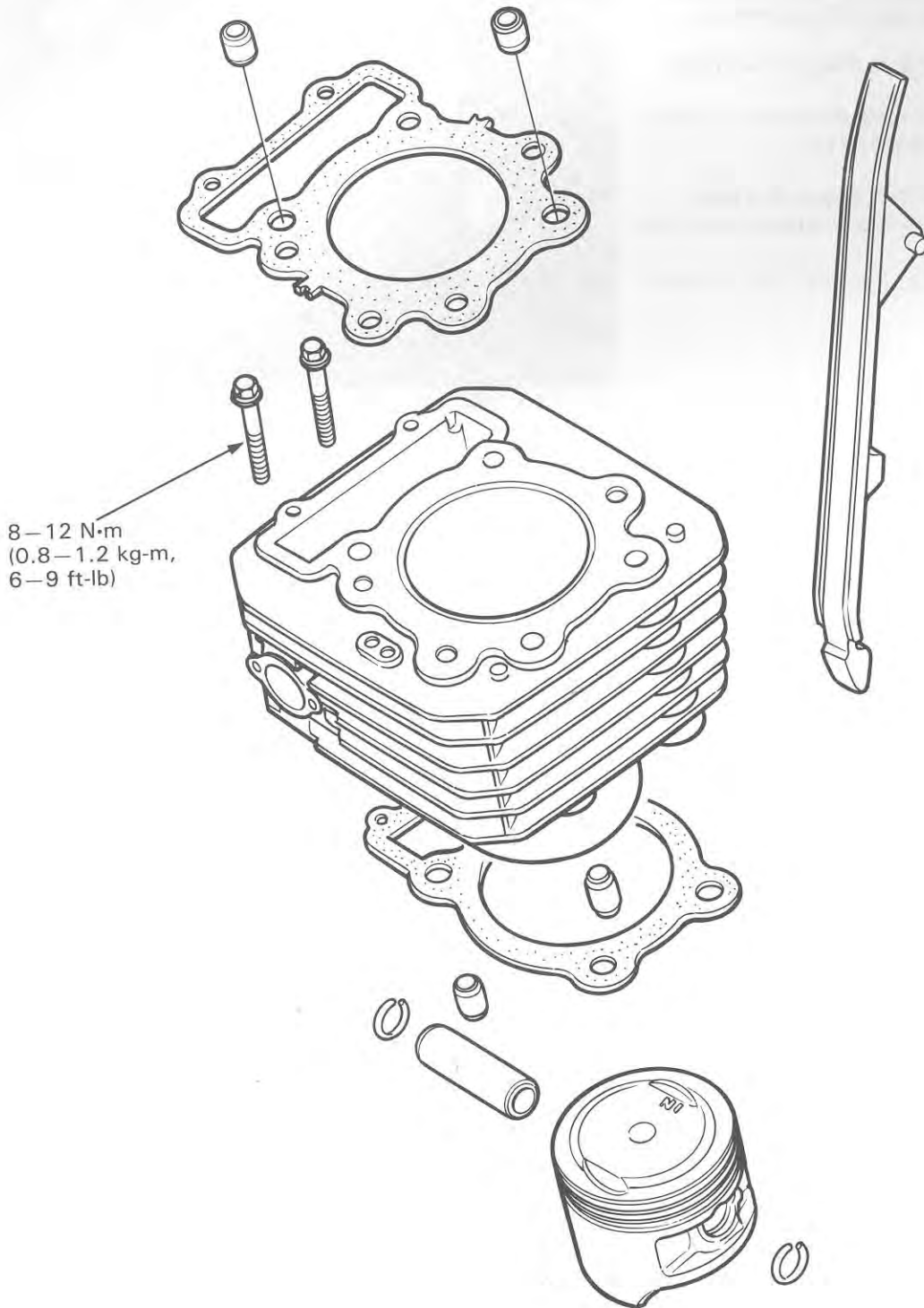

7. CYLINDER/PISTON

SERVICE INFORMATION	7-1
TROUBLESHOOTING	7-1
CYLINDER REMOVAL	7-2
PISTON REMOVAL	7-4
CAM CHAIN GUIDE	7-6
PISTON/CYLINDER INSTALLATION	7-7

SERVICE INFORMATION

GENERAL

- Camshaft lubrication oil is fed to the cylinder head through an orifice in the cylinder and crankcase. Be sure this orifice is not clogged and that the dowel pins are in place before installing the cylinder head.
- The cylinder can be removed with the engine in the frame.

SPECIFICATIONS

ITEM		STANDARD	SERVICE LIMIT	
Cylinder	I.D.	74.00–74.01 mm (2.913–2.914 in)	74.10 mm (2.917 in)	
	Taper	—————	0.10 mm (0.004 in)	
	Out of round	—————	0.10 mm (0.004 in)	
	Warping across top	—————	0.10 mm (0.004 in)	
Piston,	Piston O.D.	73.965–73.985 mm (2.9120–2.9128 in)	73.90 mm (2.909 in)	
Piston pin,	Piston pin bore	19.002–19.008 mm (0.7481–0.7483 in)	19.04 mm (0.750 in)	
Piston rings	Piston pin O.D.	18.994–19.000 mm (0.7478–0.7480 in)	18.96 mm (0.747 in)	
	Piston-to-pin clearance		0.002–0.014 mm (0.0001–0.0006 in)	
	Piston ring-to-ring groove clearance	TOP	0.015–0.045 mm (0.0006–0.0018 in)	0.09 mm (0.004 in)
		SECOND	0.015–0.045 mm (0.0006–0.0018 in)	0.09 mm (0.004 in)
	Piston ring end gap	TOP/SECOND	0.15–0.30 mm (0.006–0.012 in)	0.50 mm (0.020 in)
		OIL	0.20–0.70 mm (0.008–0.028 in)	—————
Cylinder-to-piston clearance		0.015–0.045 mm (0.0006–0.0018 in)	0.10 mm (0.004 in)	
Crankshaft	Connecting rod small end I.D.	19.020–19.041 mm (0.7488–0.7496 in)	19.10 mm (0.752 in)	

TORQUE VALUE

Cylinder mount bolt 8–12 N·m (0.8–1.2 kg-m, 6–9 ft-lb)

TROUBLESHOOTING

Low or unstable compression

1. Worn cylinder or piston rings
2. Cylinder head and valves (Section 6)

Excessive smoke

1. Worn cylinder, piston, or piston rings
2. Improper installation of piston rings
3. Scored or scratched piston or cylinder wall

Overheating

—Excessive carbon build-up on piston or combustion chamber wall

Knocking or abnormal noise

1. Worn piston and cylinder
1. Excessive carbon build-up

CYLINDER REMOVAL

Remove the cylinder head (Section 6).
Remove the gasket, dowel pins, and cam chain guide.

NOTE

Keep the cam chain from falling into the crankcase when removing the cylinder.

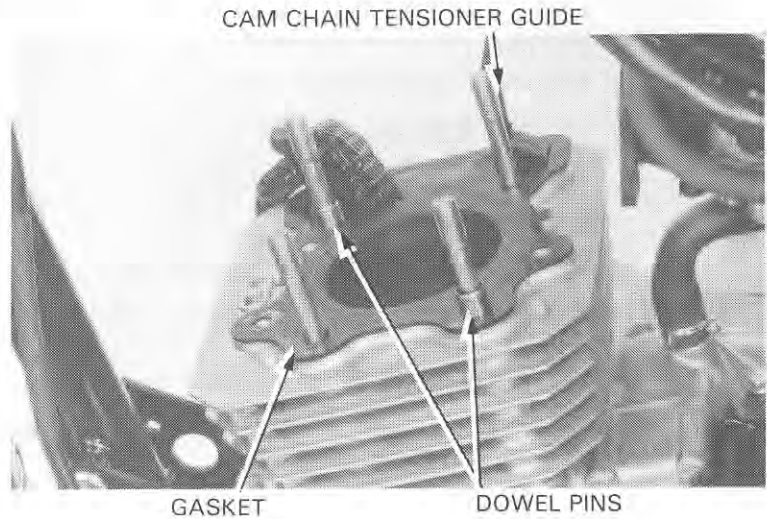

Remove the cylinder mount bolts.

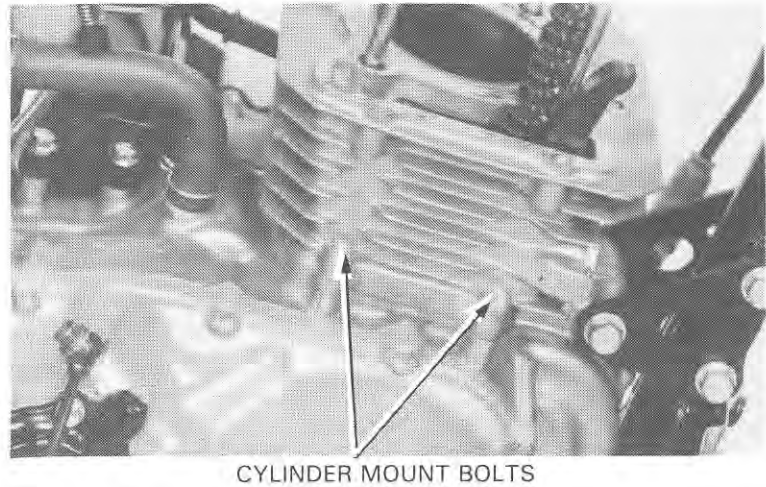

Remove the cylinder, gasket and dowel pins.

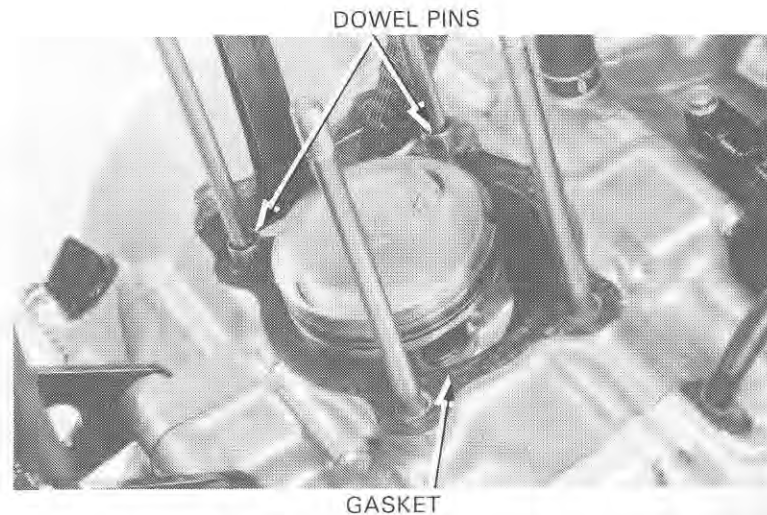

Clean off any gasket material from the cylinder surface.

NOTE

Be careful not to damage the gasket surface.

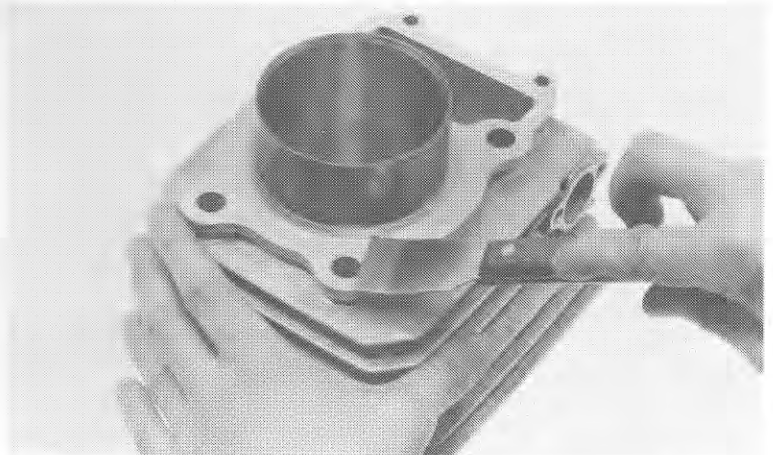

CYLINDER INSPECTION

Inspect the cylinder bore for wear or damage.
 Measure the cylinder I.D.
 Check the cylinder I.D. at X and Y axis at three locations.

SERVICE LIMIT: 74.10 mm (2.917 in)

Calculate the taper and out of round.

SERVICE LIMITS:

Taper: 0.10 mm (0.004 in)
 Out of round: 0.10 mm (0.004 in)

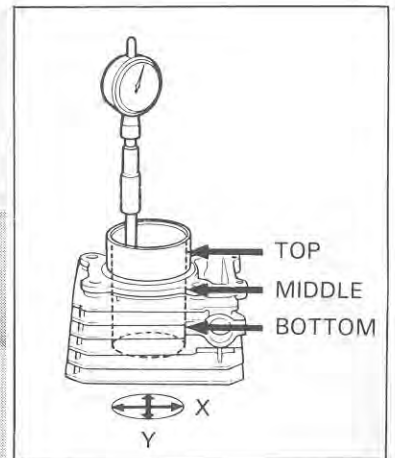
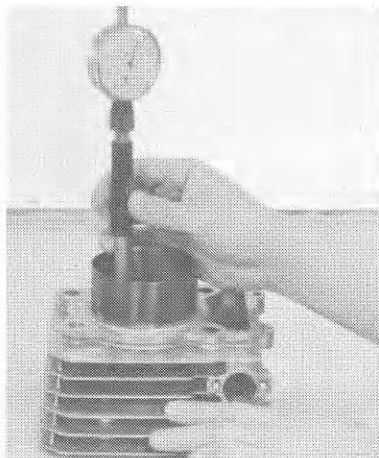

Inspect the top of the cylinder for warpage.

SERVICE LIMIT: 0.10 mm (0.004 in)

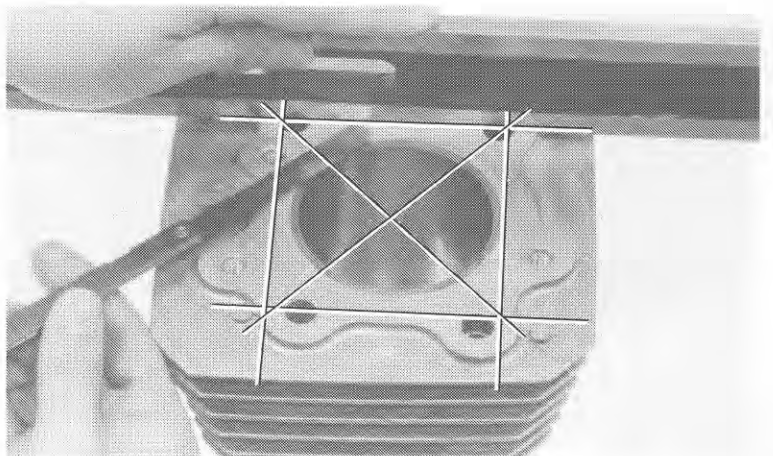

CYLINDER/PISTON

PISTON REMOVAL

Remove the piston pin clip with pliers

NOTE

Do not let the clips fall into the crankcase.

Press the piston pin out of the piston and remove the piston.

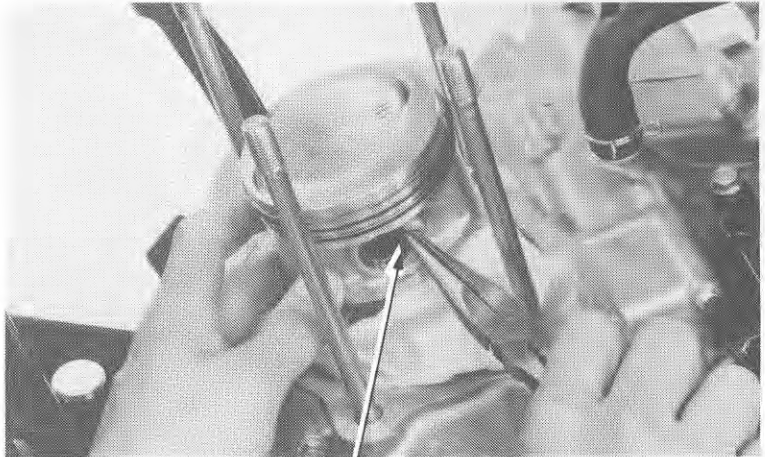

PISTON PIN CLIP

PISTON/PISTON RING INSPECTION

Measure the piston ring-to-groove clearance.

SERVICE LIMITS:

TOP: 0.09 mm (0.004 in)

SECOND: 0.09 mm (0.004 in)

Remove the piston rings.

NOTE

Do not damage the piston rings during removal.

Inspect the piston for wear or damage.

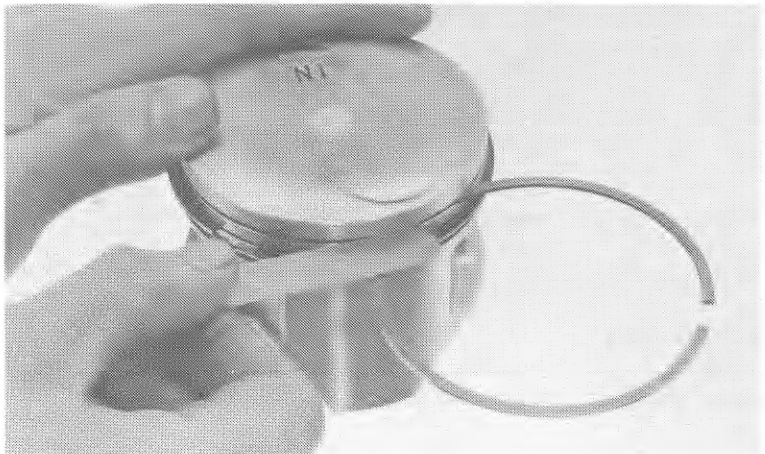

Insert each piston ring squarely into the cylinder and measure the ring end gap.

NOTE

Push the rings into the cylinder with the top of the piston to be sure they are squarely in the cylinder.

SERVICE LIMIT:

TOP/SECOND: 0.50 mm (0.020 in)

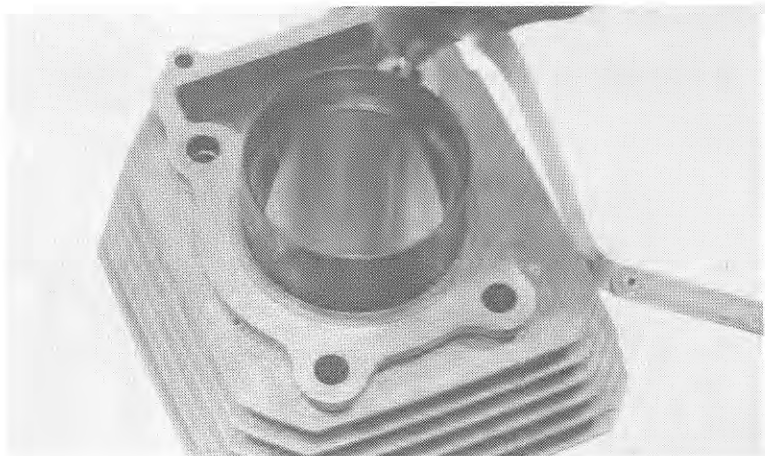

Measure the diameter of the piston 10 mm from the bottom and 90° to the piston pin hole.
Calculate the piston-to-cylinder clearance.
Refer to page 7-2 for cylinder bore inspection.

SERVICE LIMIT: 73.90 mm (2.909 in)

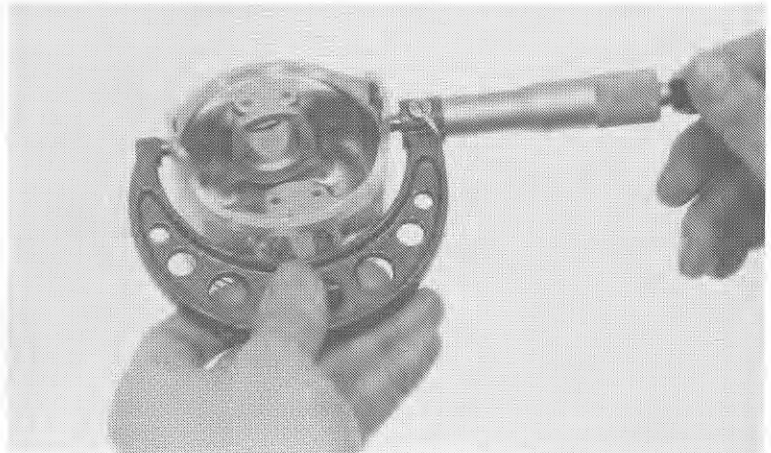

Measure the piston pin hole I.D.

SERVICE LIMIT: 19.04 mm (0.750 in)

Measure the O.D. of the piston pin.

SERVICE LIMIT: 18.96 mm (0.747 in)

Calculate the piston-to-piston pin clearance.

SERVICE LIMIT: 0.02 mm (0.001 in)

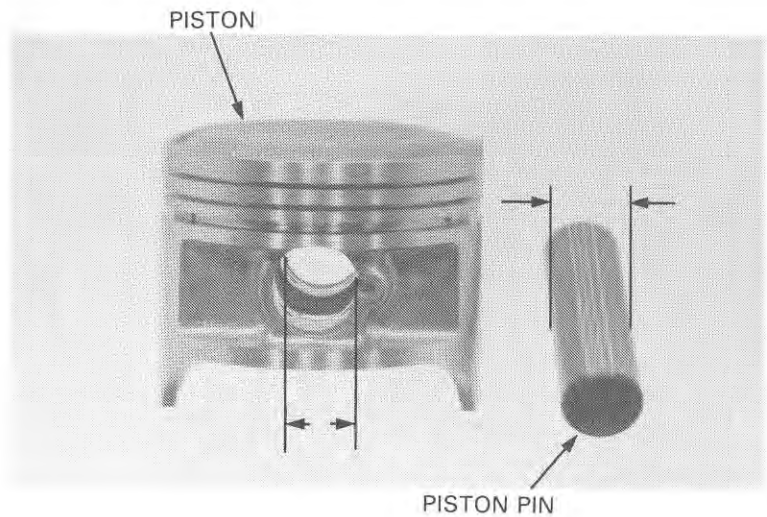

Measure the connecting rod small end I.D.

SERVICE LIMIT: 19.10 mm (0.752 in)

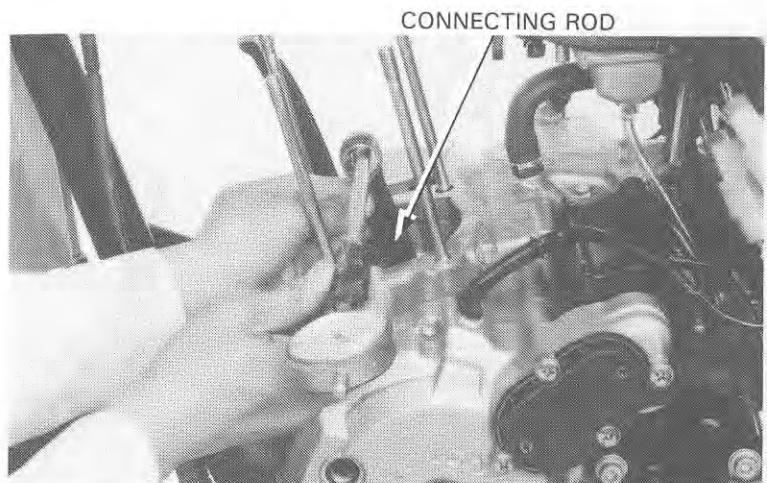

CYLINDER/PISTON

PISTON RING INSTALLATION

Clean the piston ring grooves thoroughly and install the piston rings.

NOTE

- Avoid piston and piston ring damage during installation.
- Install the piston rings with the marking facing up.
- Do not mix the top and second rings.

Space the piston ring end gaps 120 degrees apart. Do not align the gaps in the oil rings (side rails).

After installation, the rings should be free to rotate in the ring grooves.

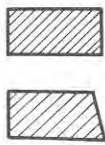

TOP RING

SECOND RING

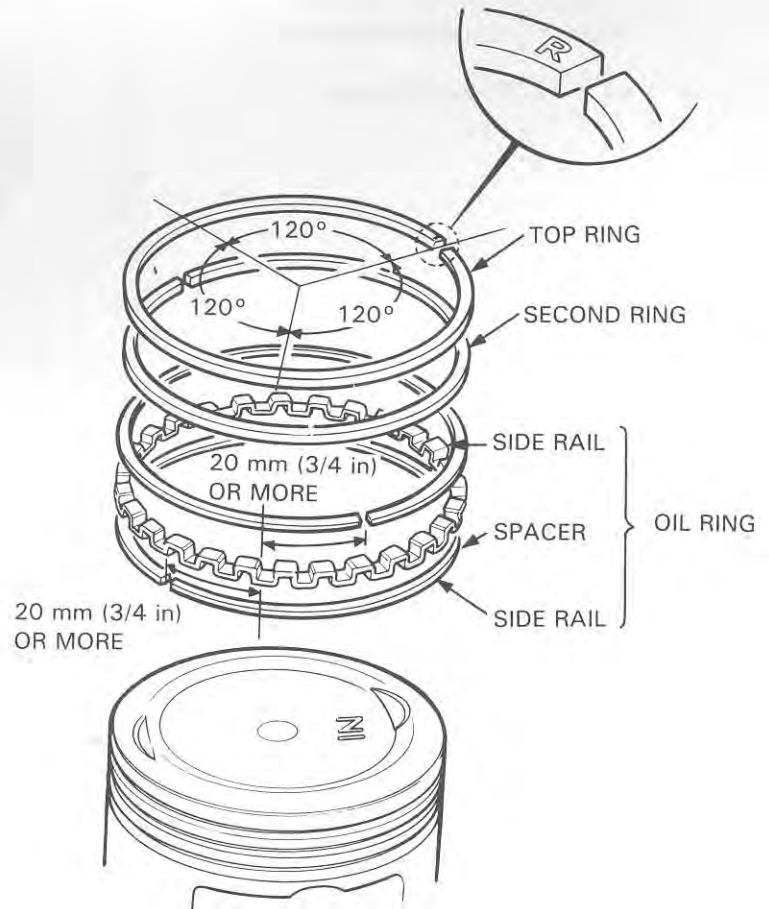

CAM CHAIN GUIDE

REMOVAL

Remove the following:

- cylinder head cover (page 6-3).
- cylinder head (page 6-7).
- tensioner lifter (page 6-4).
- tensioner guide.

CAM CHAIN TENSIONER GUIDE

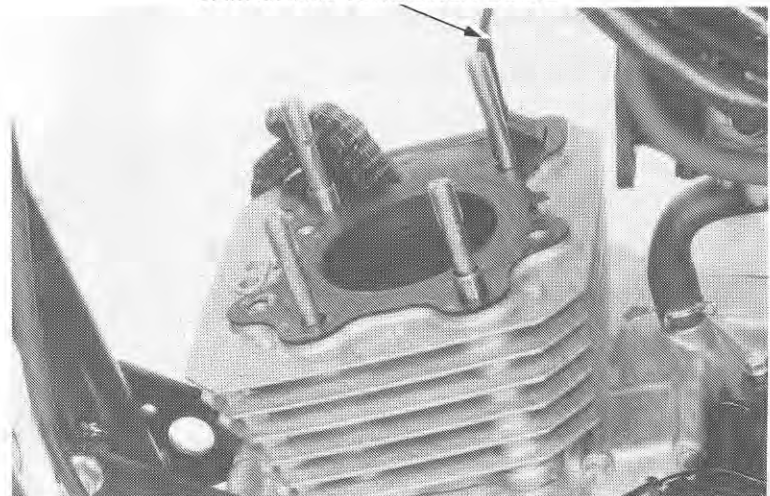

Remove the following:

- right crankcase cover (page 8-3).
- centrifugal clutch (page 8-10).
- separator plate.
- tensioner bolt, tensioner and washer.

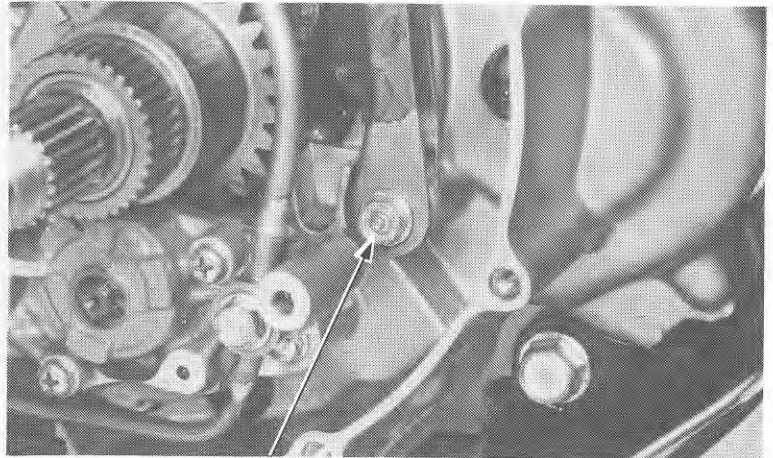

TENSIONER BOLT

INSPECTION

Inspect the cam chain guide and tensioner for wear or damage.

Inspect the tensioner lifter for good tension, replace if necessary (page 6-18).

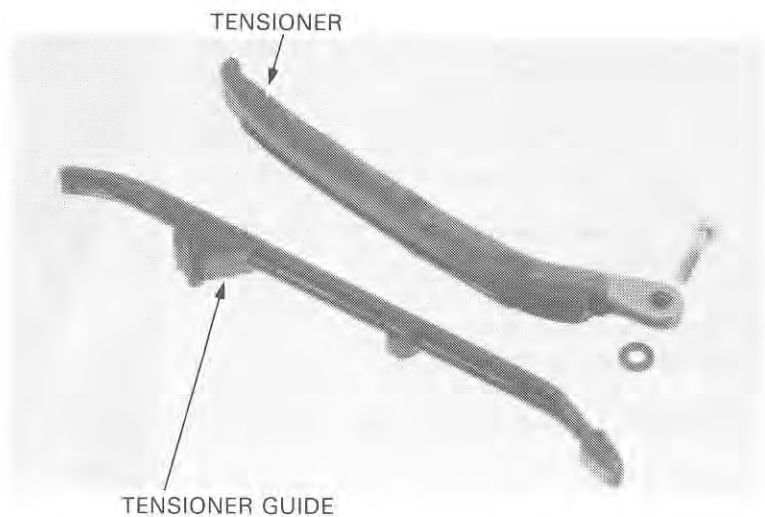

PISTON/CYLINDER INSTALLATION

Clean off any gasket material from the crankcase surface.

NOTE

Be careful not to damage the gasket surface.



CYLINDER/PISTON

Install the piston and piston pin, using new piston pin clips.

NOTE

- Position the piston "IN" mark on the intake valve side.
- Do not align the piston pin clip end gap with the piston cutout.
- Do not let the clip fall into the crankcase.

Install a new gasket and dowel pins.

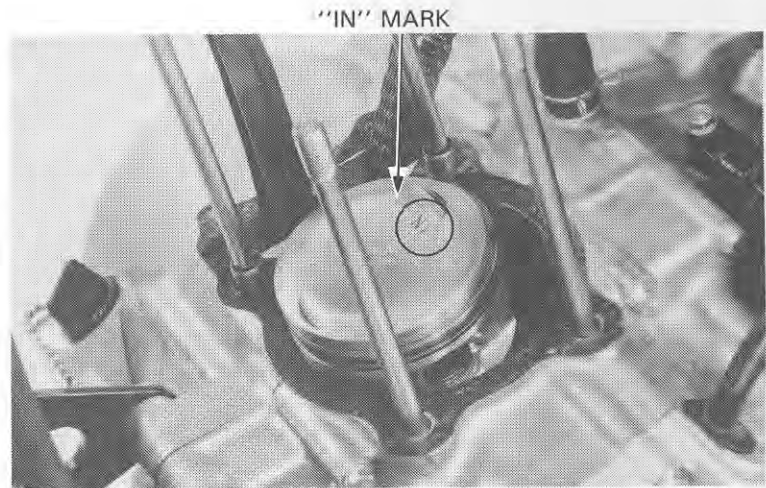

Coat the cylinder bore and piston rings with engine oil and install the cylinder.

NOTE

- Avoid piston ring damage during installation.
- Do not let the cam chain fall into the crankcase.

Install the cam chain guide.
Tighten the cylinder mount bolts.

TORQUE: 8–12 N·m (0.8–1.2 kg·m, 6–9 ft·lb)

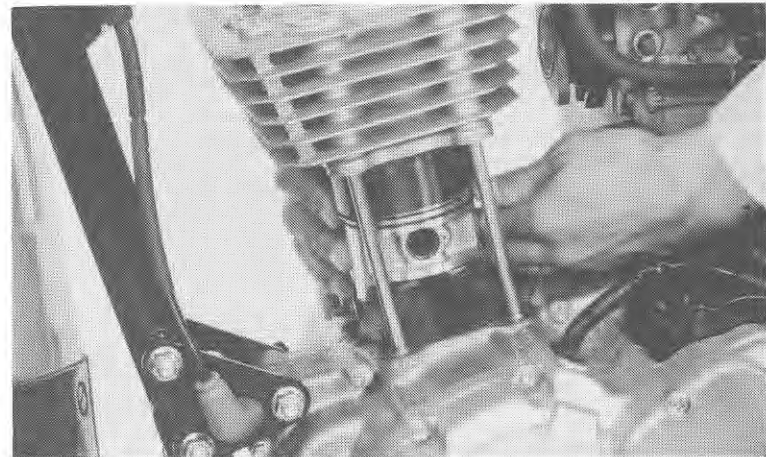

MEMO

CLUTCH/OIL PUMP/KICK STARTER

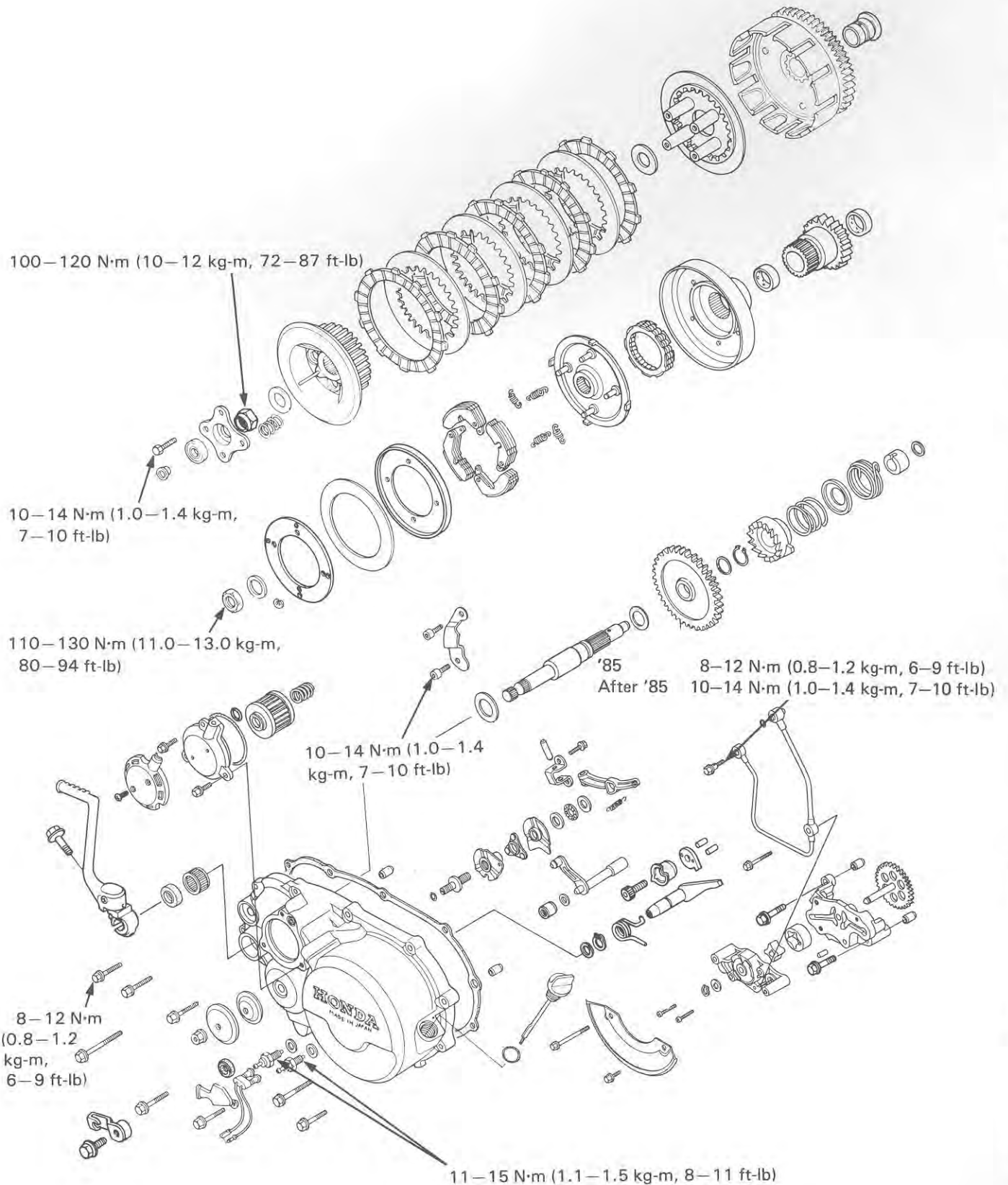

8. CLUTCH/OIL PUMP/ KICK STARTER

SERVICE INFORMATION	8-1	MANUAL CLUTCH	8-14
TROUBLESHOOTING	8-2	OIL PUMP/PRIMARY DRIVE GEAR	8-19
RIGHT CRANKCASE COVER REMOVAL	8-3	KICK STARTER	8-23
OIL FILTER SCREEN	8-8	RIGHT CRANKCASE COVER INSTALLATION	8-27
CLUTCH LEVER/REVERSE SHAFT ARM/ NEUTRAL AND REVERSE ROTOR/ REVERSE LOCK PLATE REPLACEMENT	8-9		
CENTRIFUGAL CLUTCH	8-10		

SERVICE INFORMATION

GENERAL

This section covers removal and installation of the centrifugal clutch, manual clutch, oil pump and kick starter. The clutches, oil pump and kick starter can be serviced with the engine installed in the frame.

SPECIFICATIONS

ITEM		STANDARD	SERVICE LIMIT
Manual clutch	Spring free length	34.98 mm (1.377 in)	34.0 mm (1.34 in)
	Spring preload	18 kg (30.68 lb)	—————
	Disc thickness	2.62–2.78 mm (0.103–0.109 in)	2.3 mm (0.09 in)
	Disc warp	—————	0.20 mm (0.008 in)
	Plate warp	—————	0.20 mm (0.008 in)
	Clutch outer guide O.D.	27.959–27.980 mm (1.1007–1.1016 in)	27.92 mm (1.099 in)
Centrifugal clutch	Drum I.D.	140 mm (5.5 in)	140.2 mm (5.52 in)
	Weight lining thickness	2.95–3.05 mm (0.116–0.120 in)	2.0 mm (0.08 in)
	Clutch spring free height	3.7 mm (0.15 in)	3.55 mm (0.140 in)
Kick starter	Spindle O.D.	21.959–21.980 mm (0.8645–0.8654 in)	21.90 mm (0.862 in)
	Pinion gear I.D.	22.020–22.041 mm (0.8669–0.8678 in)	22.10 mm (0.870 in)
	Idler gear I.D.	23.020–23.041 mm (0.9063–0.9071 in)	23.07 mm (0.908 in)
	Idler gear bushing O.D.	22.959–22.980 mm (0.9039–0.9047 in)	22.93 mm (0.903 in)
	Countershaft O.D.	19.980–19.993 mm (0.7866–0.7871 in)	19.95 mm (0.785 in)
	Idler gear bushing I.D.	20.000–20.021 mm (0.7874–0.7882 in)	20.05 mm (0.789 in)
Primary driver gear	Crankshaft O.D.	23.959–23.980 mm (0.9433–0.9441 in)	23.93 mm (0.942 in)
	Gear I.D.	24.000–24.021 mm (0.9449–0.9457 in)	24.05 mm (0.947 in)
Oil pump	Pump end clearance	0.02–0.08 mm (0.0008–0.0031 in)	0.10 mm (0.004 in)
	Rotor tip clearance	0.15 mm (0.006 in)	0.20 mm (0.008 in)
	Rotor-to-body clearance	0.15–0.21 mm (0.006–0.008 in)	0.25 mm (0.010 in)

TORQUE VALUES

Oil pipe bolt	8–12 N·m (0.8–1.2 kg·m, 6–9 ft·lb)
Kick starter stopper plate socket bolt	10–14 N·m (1.0–1.4 kg·m, 7–10 ft·lb)
Manual clutch lock nut	100–120 N·m (10–12 kg·m, 72–87 ft·lb) Apply thread locking agent
Centrifugal clutch lock nut	110–130 N·m (11.0–13.0 kg·m, 80–94 ft·lb) Apply thread locking agent
Neutral and reverse switch	11–15 N·m (1.1–1.5 kg·m, 8–11 ft·lb)
Clutch lifter bolt	10–14 N·m (1.0–1.4 kg·m, 7–10 ft·lb)
Right crankcase cover SH bolt	8–12 N·m (0.8–1.2 kg·m, 6–9 ft·lb)
After '85	
Oil pipe bolt	10–14 N·m (1.0–1.4 kg·m, 7–10 ft·lb)

CLUTCH/OIL PUMP/KICK STARTER

TOOLS

Special

Remover handle	07946-3710100
Remover weight	07741-0010201 or 07936-3710200
Bearing remover, 17 mm	07936-3710300
Attachment, 28 x 30 mm	07946-1870100
Clutch center holder	07923-KE10001
Bearing remover, 20 mm	07936-3710600
Clutch holder	07923-HA80000 or 07923-HB3000A—USA ONLY
Clutch puller	07933-HA80000 or 07933-HB3000A—USA ONLY
Bearing remover set, 20 mm	07936-3710001

Common

Driver	07749-0010000
Attachment, 42 x 47 mm	07746-0010300
Pilot, 17 mm	07746-0040400
Pilot, 20 mm	07746-0040500
Extension bar	07716-0020500 or commercially available in U.S.A.
Lock nut wrench, 17 x 27 mm	07716-0020300 or commercially available in U.S.A.

TROUBLESHOOTING

Faulty clutch operation can usually be corrected by adjusting the clutch.

Clutch slips when accelerating

1. Faulty clutch lifter
2. Discs worn
3. Weak spring

Clutch will not disengage

1. Faulty clutch lifter
2. Plates warped

Motorcycle creeps with clutch disengaged

1. Faulty centrifugal clutch
2. Plates warped

Clutch operation feels rough

—Outer drum slots rough

Hard to shift

1. Incorrect clutch adjustment
2. Faulty clutch lifter

Low oil pressure

1. Faulty oil pump
2. Oil pump drive gear broken

RIGHT CRANKCASE COVER REMOVAL

Shift the transmission into neutral.

Drain the oil from the engine.
Remove the right side cover.

Remove the following:

- kick pedal.
- right foot peg.
- oil pipe bolt and two sealing washers from the right crankcase cover.
- neutral/reverse switch wire cover.

Disconnect the following:

- reverse cable from the cable holder and holder arm.
- neutral and reverse switch wires.

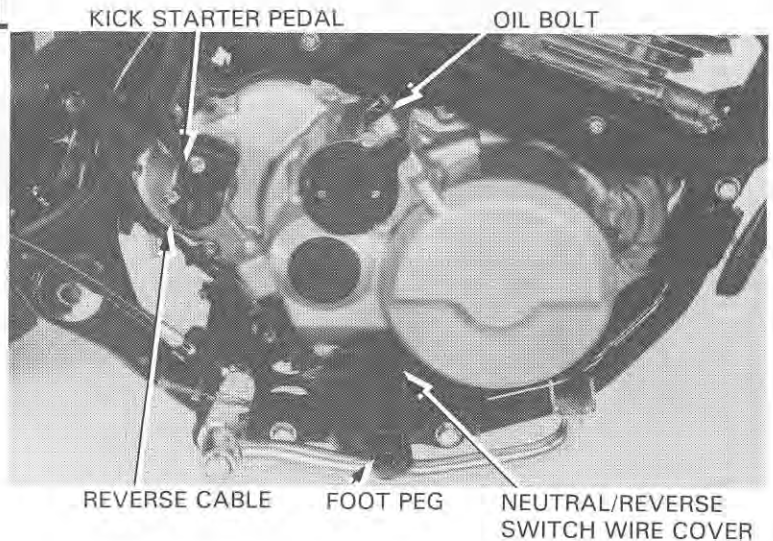

Remove the reverse cable holder arm by removing bolt from the reverse shift shaft.

Remove the oil filler cap/dipstick.

Remove the reverse cable holder and neutral and reverse wire clamps.

Remove the right crankcase cover bolts and cover.

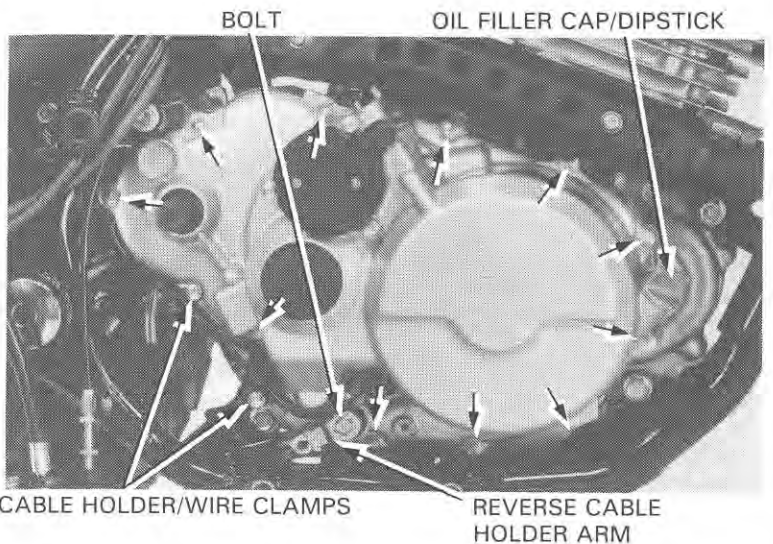

Remove the gasket and dowel pins.

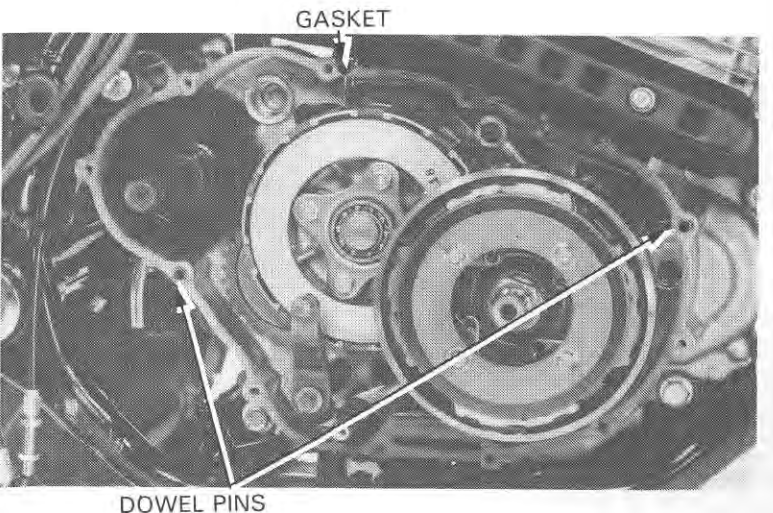

CLUTCH/OIL PUMP/KICK STARTER

CLUTCH LIFTER DISASSEMBLY

Remove the clutch adjuster rubber cap.
Remove the clutch adjusting screw lock nut and washer.

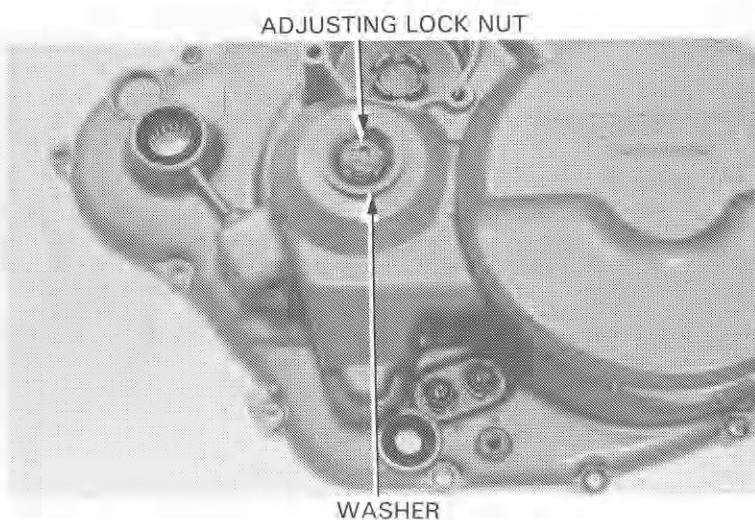

Remove the clutch lifter lever stay mount bolts, lifter lever and spring.

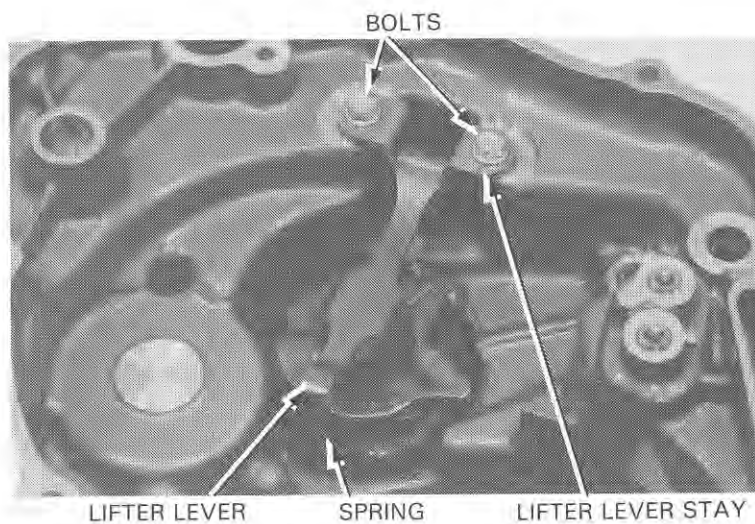

Remove the washers, bearing and clutch lifter cam.

Remove the ball retainer and clutch lifter with adjusting screw.

Check the disassembled parts for damage or wear, replace the parts if necessary.

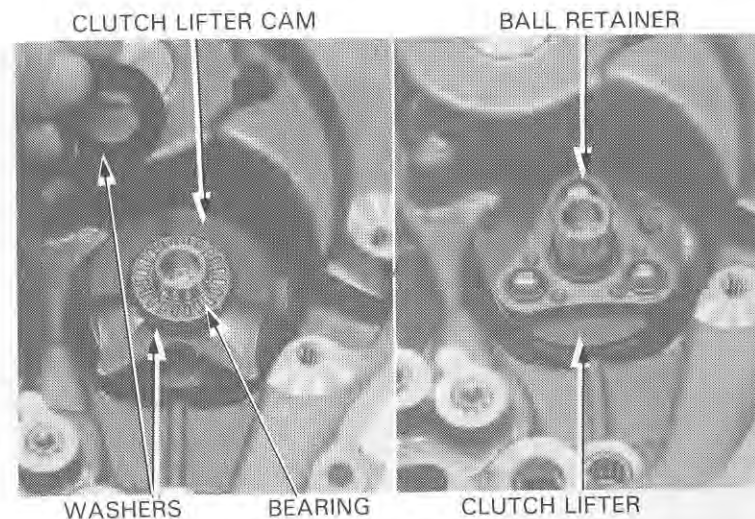

CLUTCH LIFTER ASSEMBLY/INSTALLATION

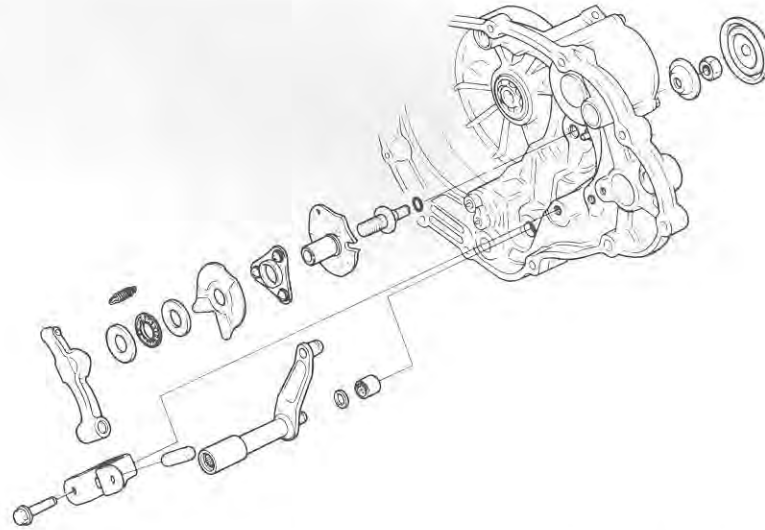

Install the following:

- adjusting screw into the clutch lifter.
- O-ring onto the adjusting screw.
- clutch lifter by aligning its groove with the stop pin on the right crankcase cover,

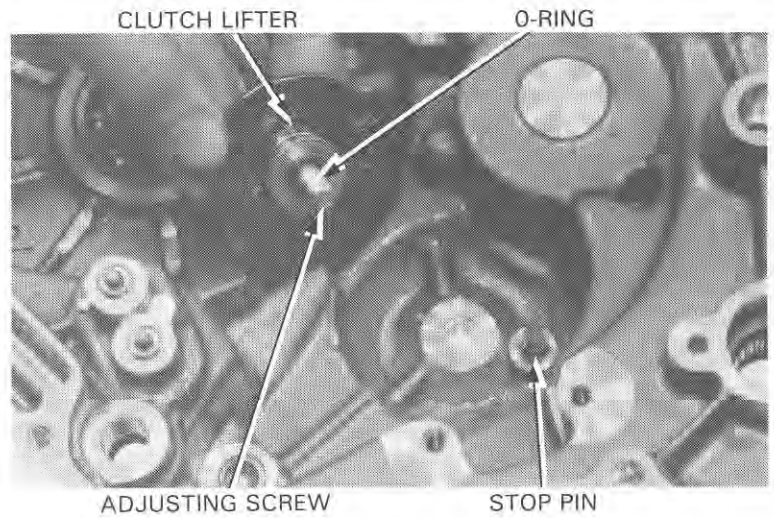

Install the ball retainer onto the clutch lifter.

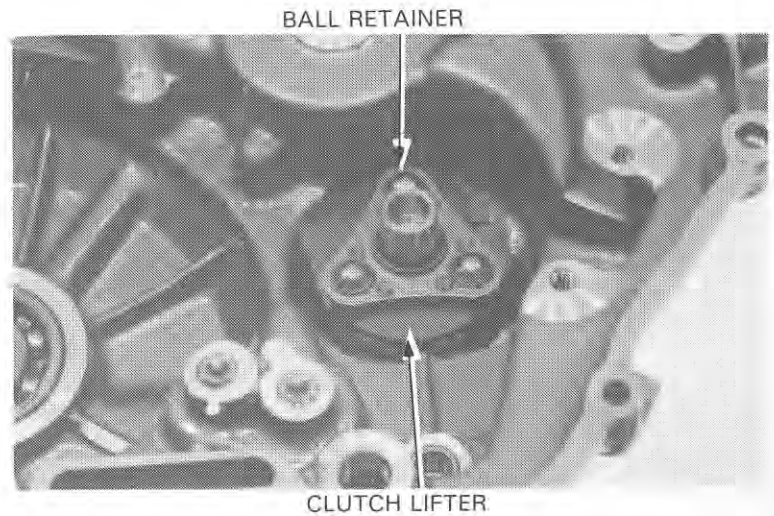

CLUTCH/OIL PUMP/KICK STARTER

Install the clutch lifter cam.

NOTE

Install the clutch lifter cam aligning its groove with the clutch lever bearing hole on the right crankcase cover.

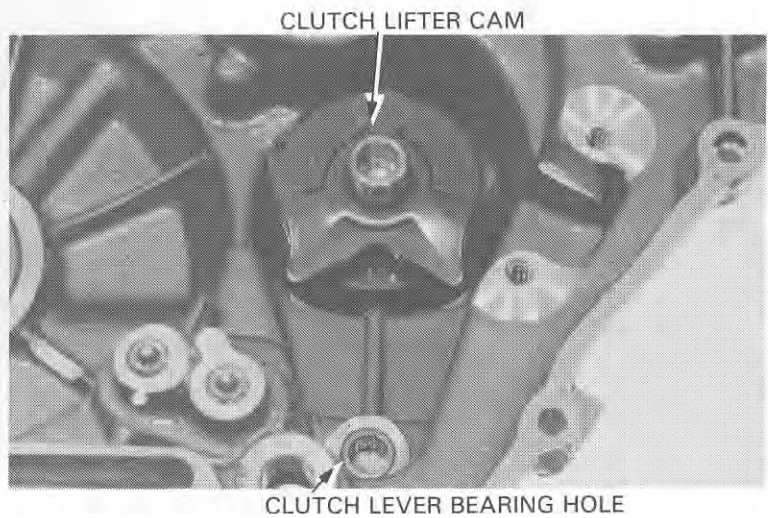

Install the washer, bearing and thrust washer onto the clutch lifter cam.

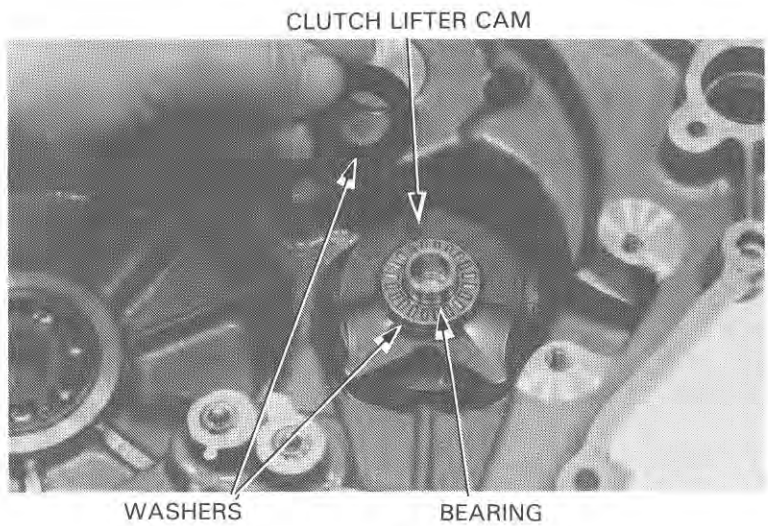

Install the lifter lever in the reverse order of removal.

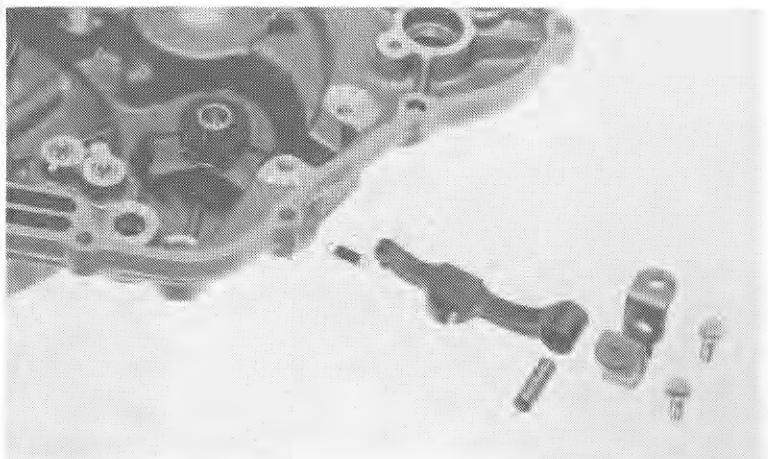

BEARING/OIL SEAL INSPECTION

Check the kick shaft, clutch lever and crankshaft bearings on the right crankcase cover for wear or damage.

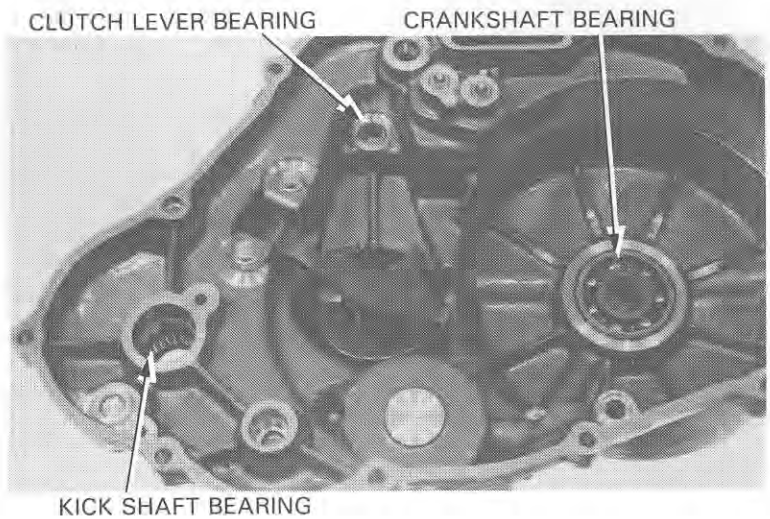

Check the oil seals for wear or damage.

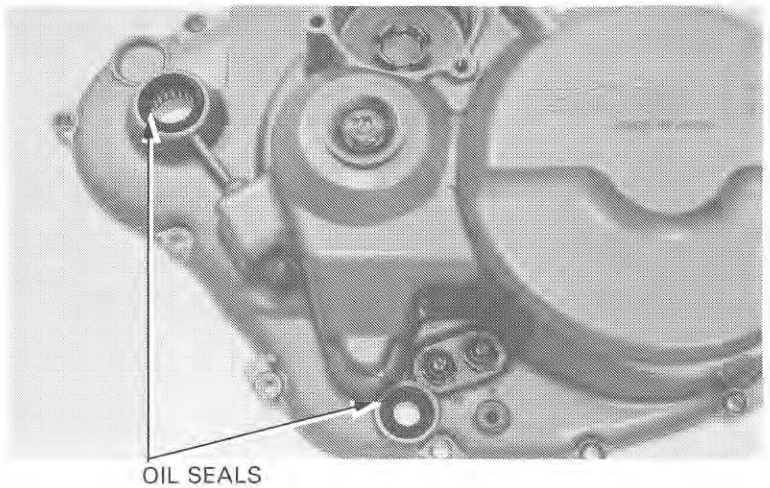

BEARING REPLACEMENT

Remove the bearings from the right crankcase cover with the special tools.

Crankshaft bearing

- Remover handle 07936-3710100
- Remover weight 07936-3710200 or 07741-0010201
- Bearing remover, 17 mm 07936-3710300

Kick shaft bearing

- Bearing remover set, 20 mm 07936-3710001
 - Remover handle 07936-3710100
 - Remover weight 07936-3710200 or 07741-0010201
 - Bearing remover, 20 mm 07936-3710600

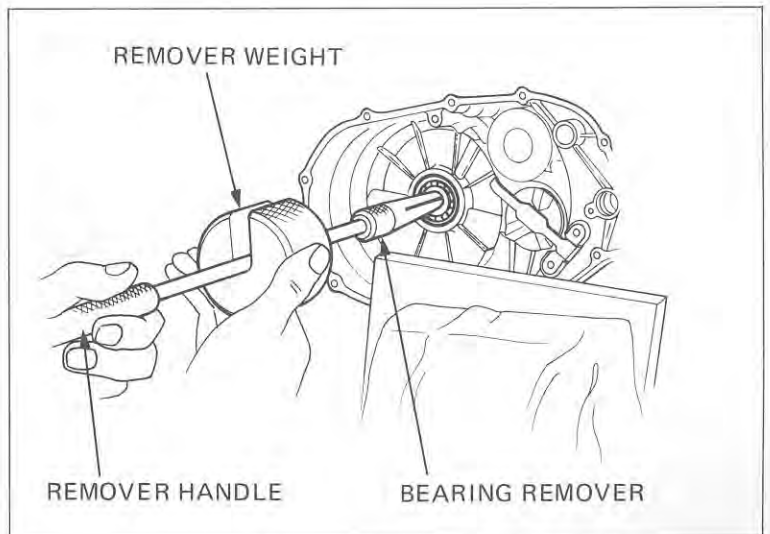

CLUTCH/OIL PUMP/KICK STARTER

Drive a new crankshaft bearing into the cover using the special tools.

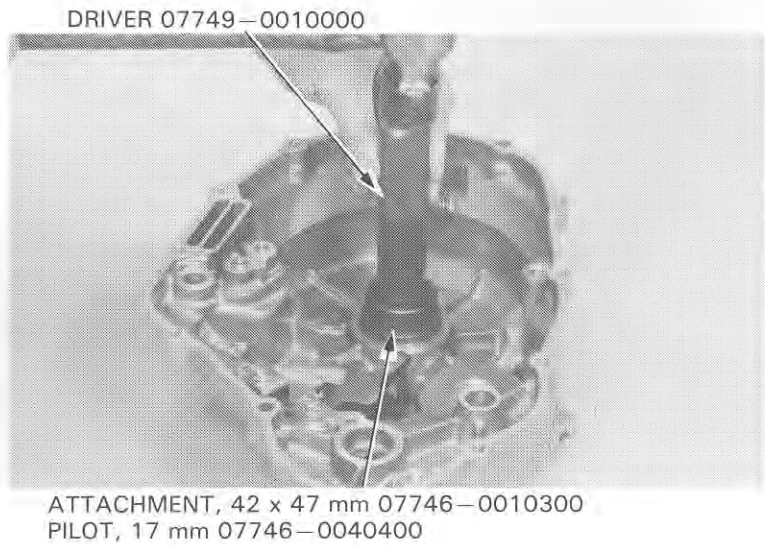

Drive a new kick shaft bearing into the cover using the special tools.



OIL FILTER SCREEN

Drain the engine oil.
Remove the right crankcase cover, gasket and dowel pins (page 8-3).
Remove the oil filter screen from the crankcase and clean.
Replace if necessary.
Install the oil filter screen and right crankcase cover in the reverse order of removal (page 8-3).

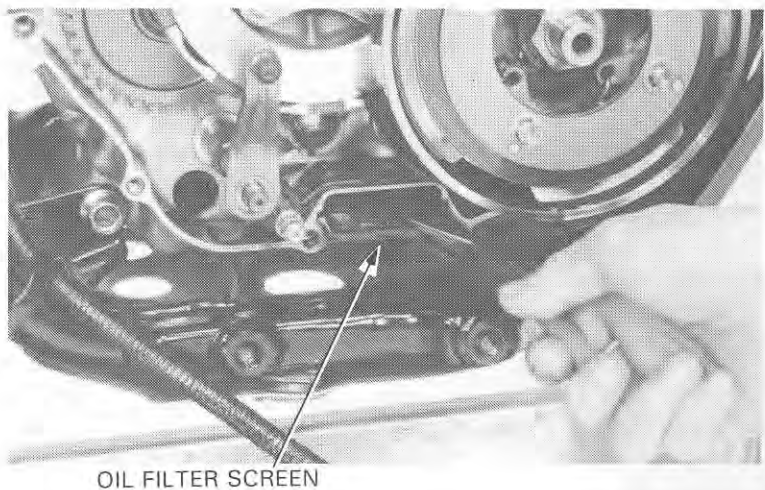

CLUTCH LEVER/REVERSE SHAFT ARM/NEUTRAL AND REVERSE ROTOR/REVERSE LOCK PLATE REPLACEMENT

Remove the washer and clutch lever.

Remove the reverse shaft arm from the right crankcase.

Remove the washer and spring from the reverse shaft arm.

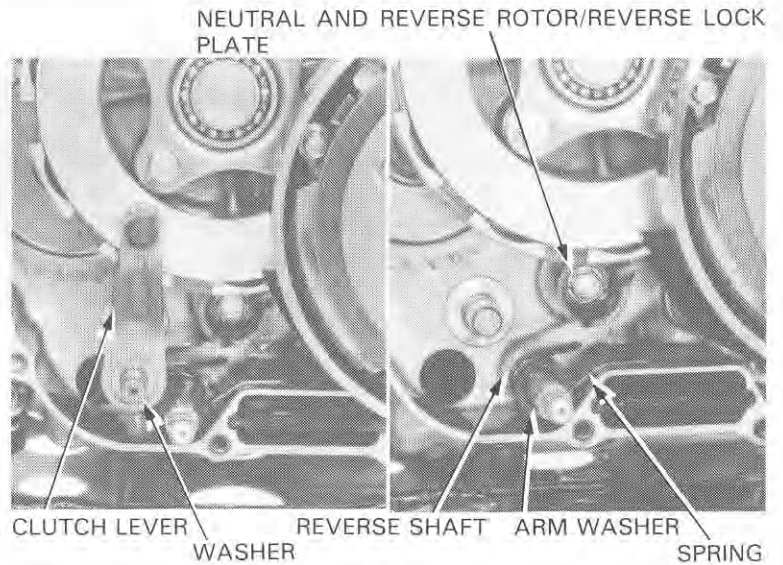

Align the reverse lock plate holes with the holes in the shift drum pin and install the reverse lock plate. Align the neutral and reverse rotor holes with the reverse lock plate pins and install the neutral and reverse rotor using the bolt.

Rotate the neutral and reverse rotor and check for smooth operation.

Install the reverse shaft arm.

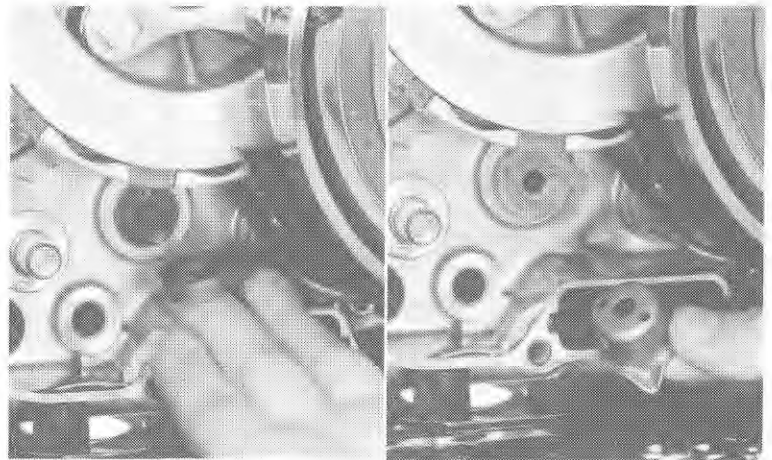

Align the index mark on the case with the punch mark on the clutch lever and install the clutch lever.

Install the thrust washer.

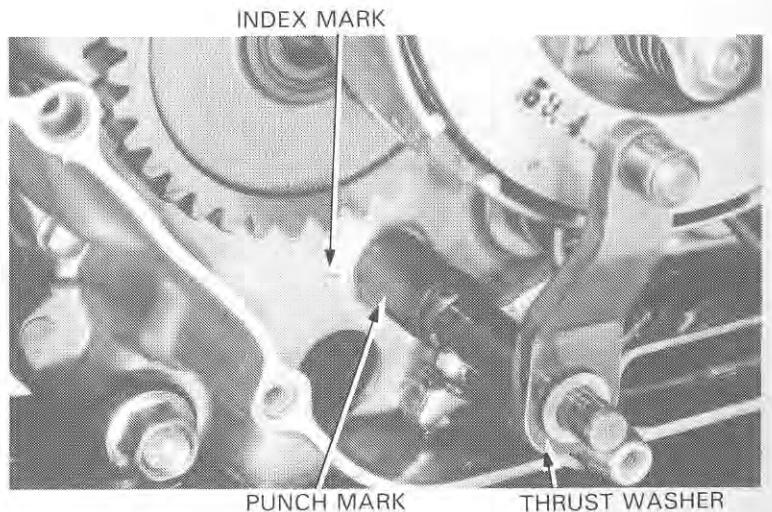

CENTRIFUGAL CLUTCH

REMOVAL

Remove the right crankcase cover.

Hold the centrifugal clutch weight assembly with a clutch holder and remove the lock nut by turning it clockwise.

NOTE

The lock nut has left hand threads.

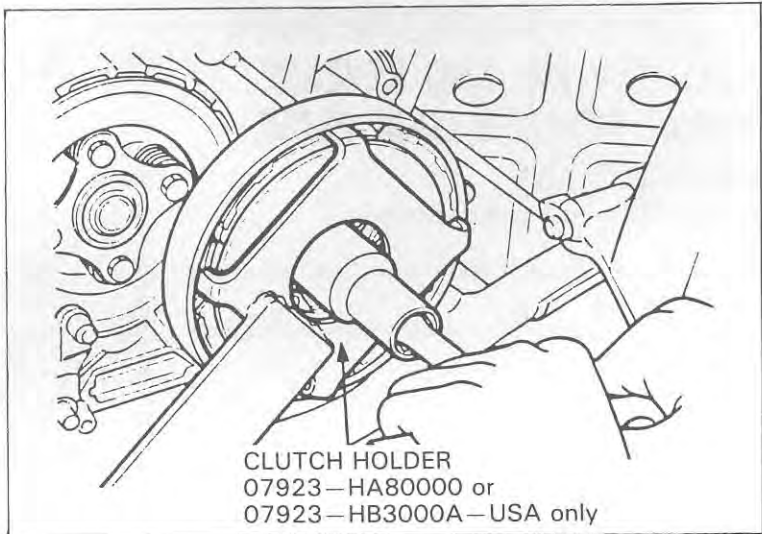

Remove the centrifugal clutch weight assembly and drum with a clamping two jaw puller or clutch puller 07933-HA80000.

NOTE

Jaws must be clamping type to ensure fit on clutch drum.

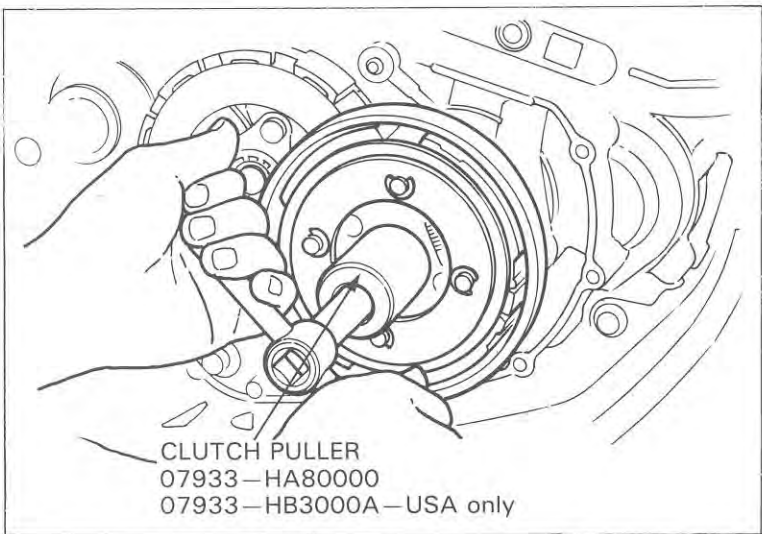

WEIGHT DISASSEMBLY/INSPECTION

Measure the weight lining thickness.

SERVICE LIMIT: 2.0 mm (0.08 in)

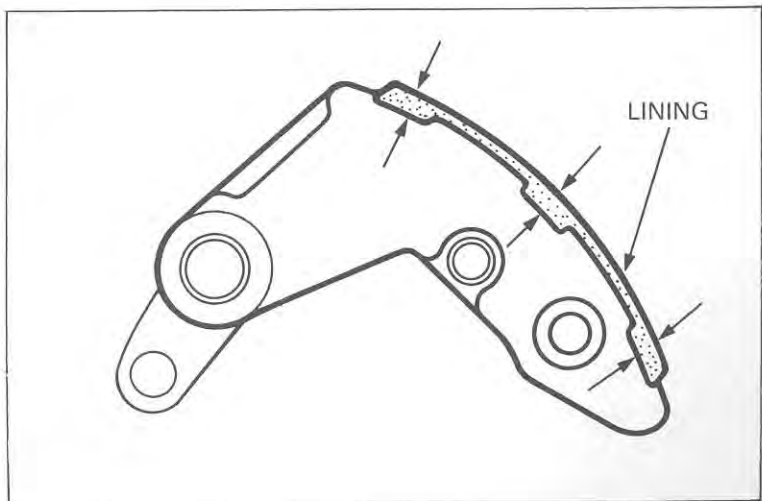

Remove the E-clips, washer, clutch spring and washer.

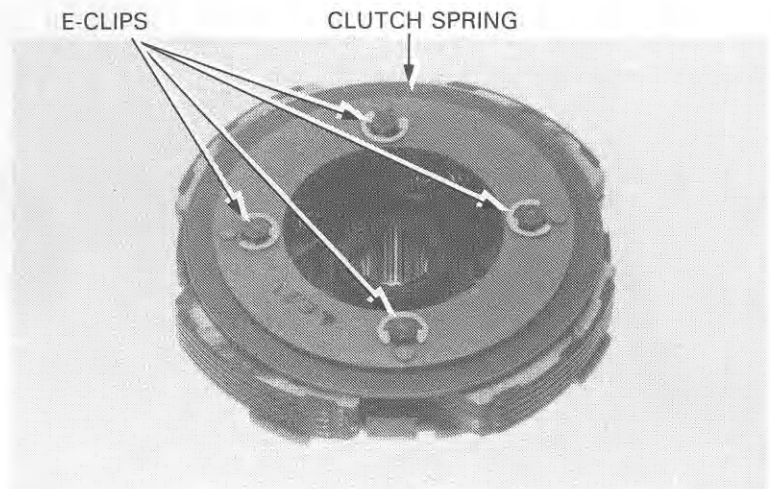

Check the weight springs for wear or damage. Replace if necessary.

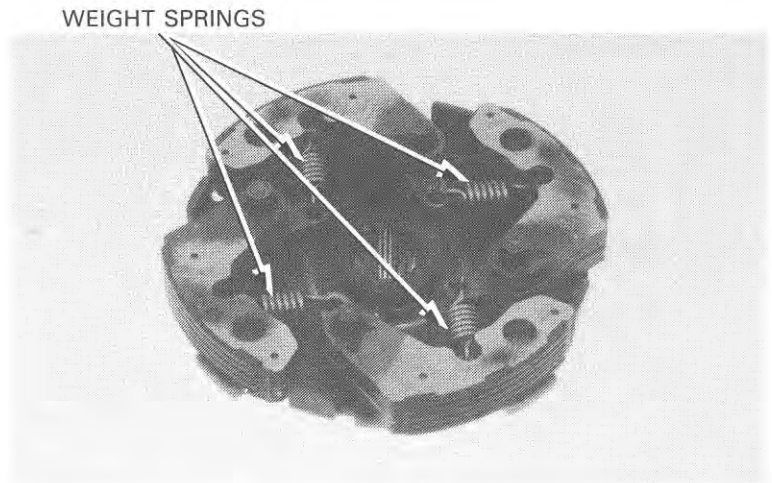

Measure the height of the clutch spring.

SERVICE LIMIT: 3.55 mm (0.140 in)

Replace the spring if it is shorter than the service limit.

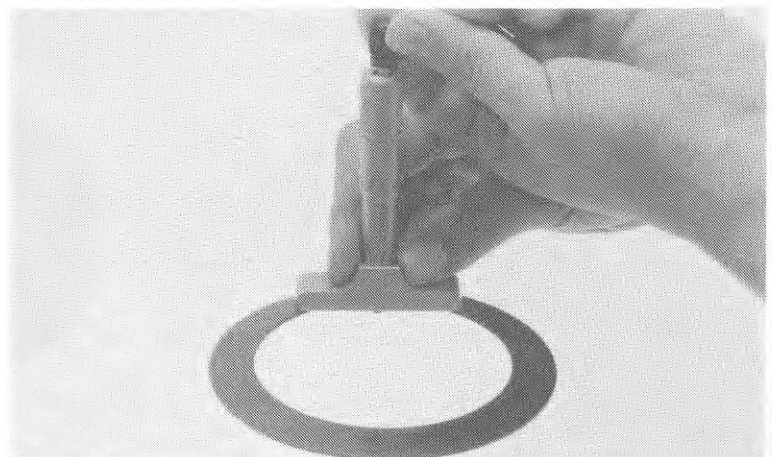

CLUTCH/OIL PUMP/KICK STARTER

WEIGHT ASSEMBLY

Install the washer.

NOTE

Install the clutch spring with the dished face towards the inside.

Install the outside washer with the locating pins facing out.

Install the E-clips aligning their gaps with the locating pins on the washer.

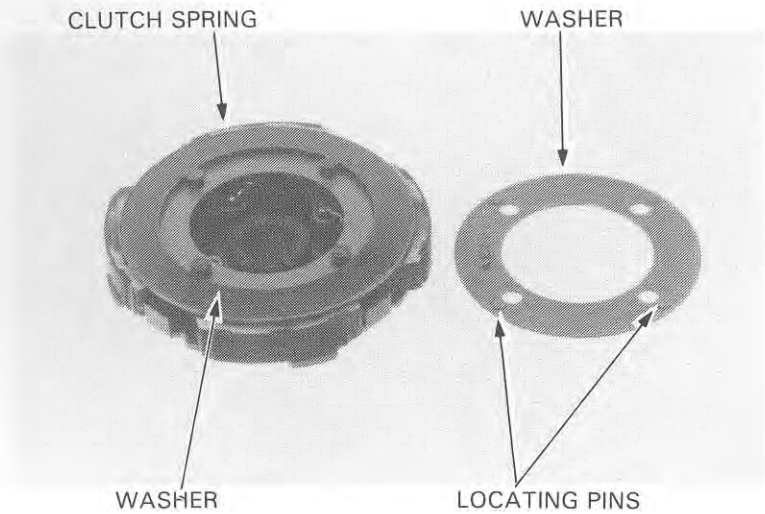

CLUTCH DRUM/ONE-WAY CLUTCH SPRING

Check the inside of the centrifugal clutch drum for scratches or excessive wear. Replace if necessary. Measure the I.D. of the clutch drum.

SERVICE LIMIT: 140.2 mm (5.25 in)

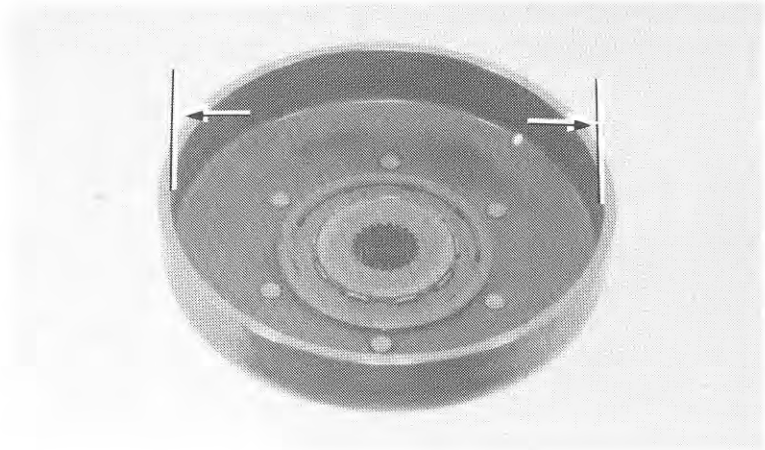

Inspect the one-way clutch for smooth operation. Check the rollers for excessive wear.

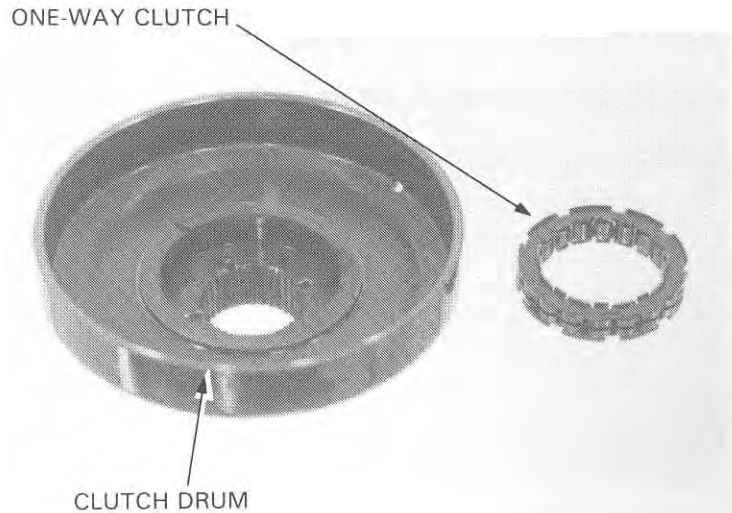

Install the one-way clutch into the clutch drum with its "OUTSIDE" mark facing out.

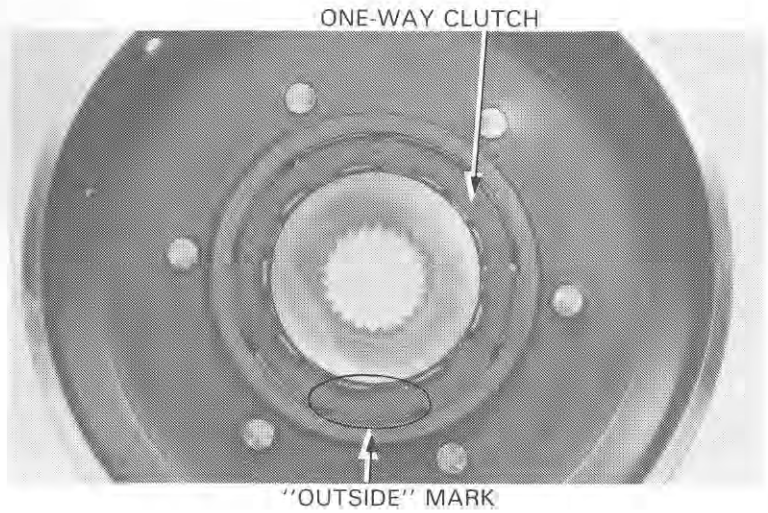

INSTALLATION

Install the centrifugal clutch drum with the one-way clutch onto the crankshaft.

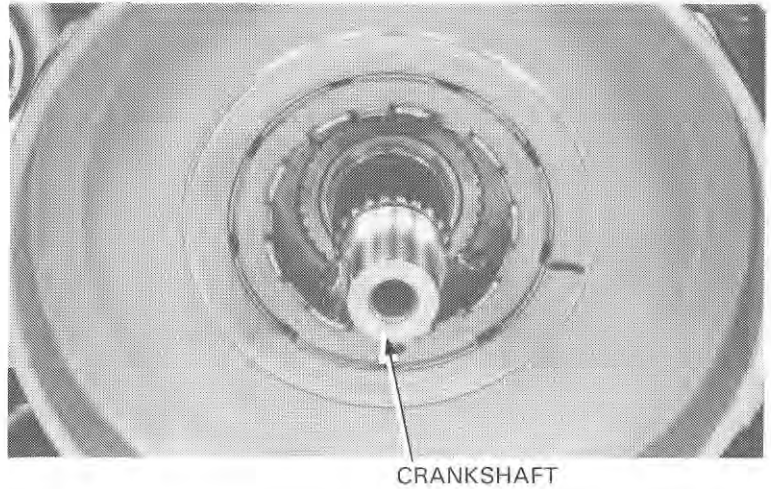

Install the centrifugal clutch weight assembly onto the clutch drum without the lock washer and tighten the lock nut. But do not tighten it securely. Remove the lock nut and install the lock washer.

NOTE

Install the lock washer with the word "OUTSIDE" facing out.

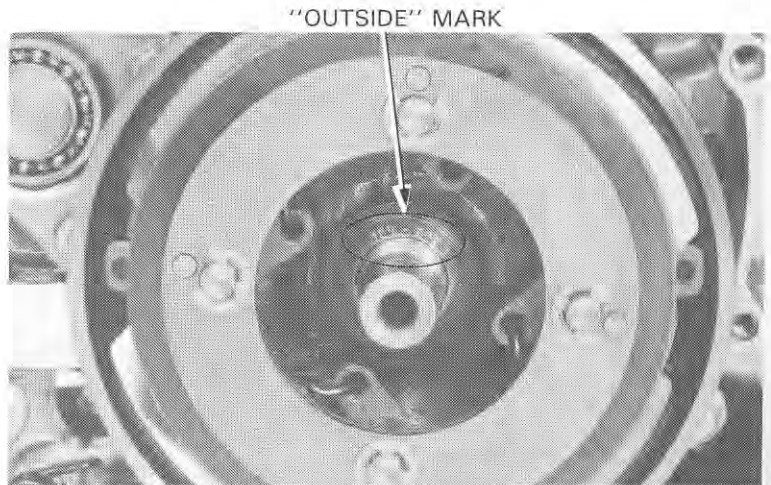

CLUTCH/OIL PUMP/KICK STARTER

Apply thread locking agent to the lock nut and tighten it.

TORQUE: 110–130 N·m
(11.0–13.0 kg-m, 80–94 ft-lb)

NOTE

- The lock nut has left hand threads.
- Hold the flywheel with the flywheel holder or strap wrench.

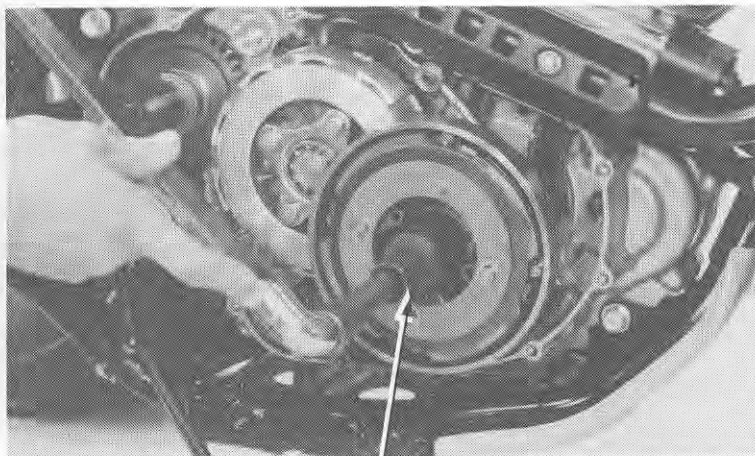

LOCK NUT WRENCH,
17 x 27 mm 07716–0020300
OR COMMERCIALLY AVAILABLE IN U.S.A.

MANUAL CLUTCH

REMOVAL

Remove the following:

- right crankcase cover (page 8-3).
- centrifugal clutch (page 8-10).
- separator plate.
- clutch lever.
- clutch bolts.
- lifter plate.
- clutch springs.

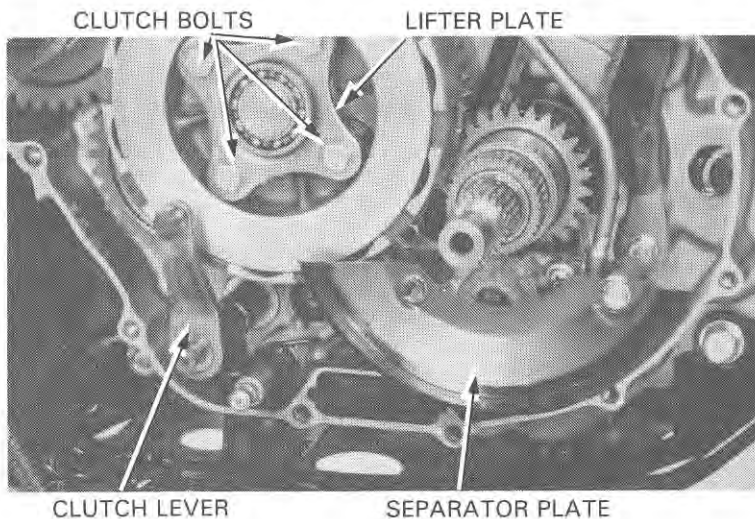

Install the clutch center holder as shown, and remove the clutch lock nut.

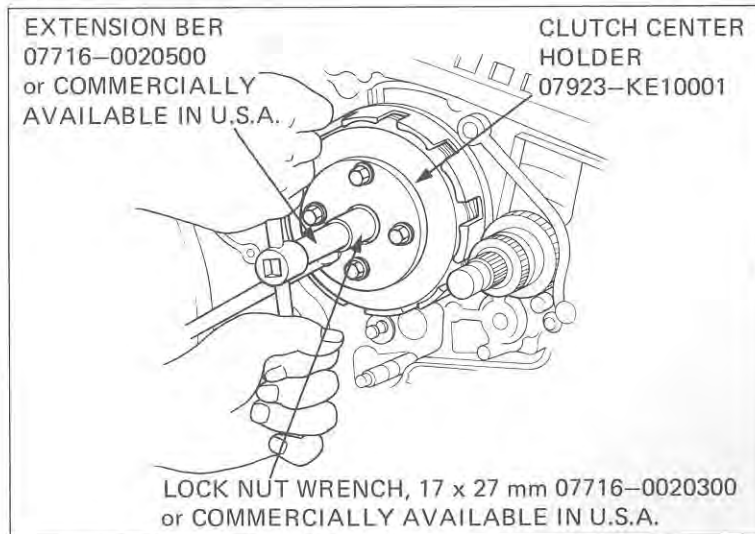

CLUTCH/OIL PUMP/KICK STARTER

Remove the lock washer, clutch center, discs, plates and pressure plates.

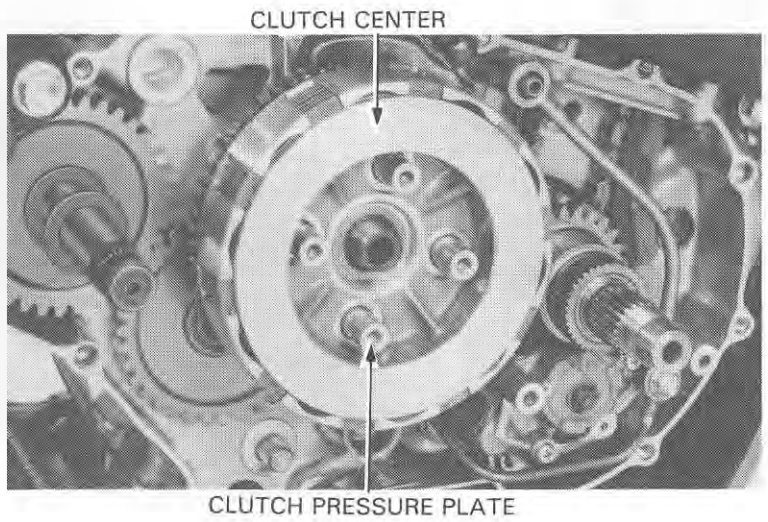

Remove the thrust washer and clutch outer.

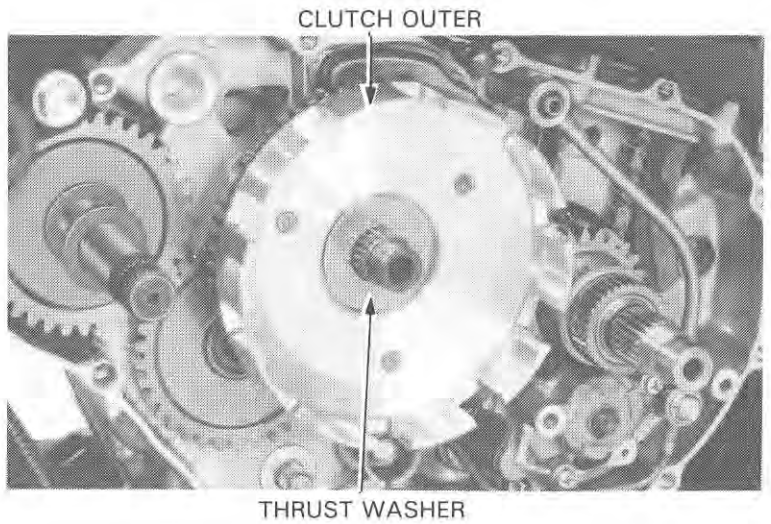

Remove the clutch outer guide from the mainshaft.

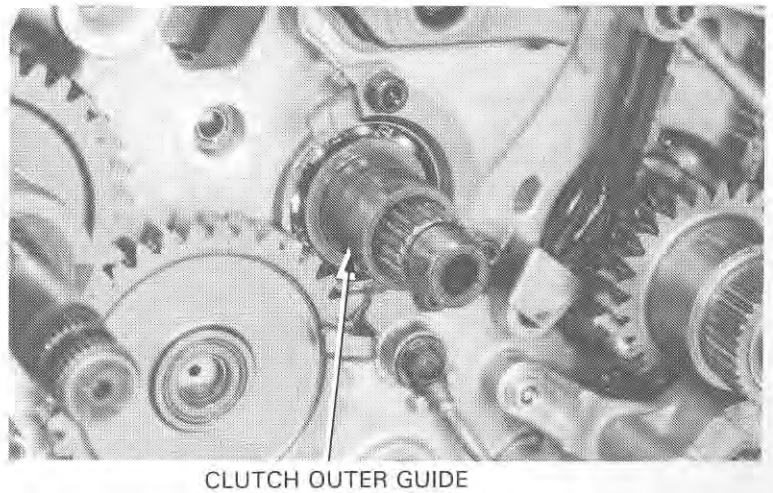

CLUTCH/OIL PUMP/KICK STARTER

INSPECTION

Check the slots of the clutch outer for damage or wear made by the clutch discs. Replace if necessary.

Measure the O.D. of the clutch outer guide.

SERVICE LIMIT: 27.92 mm (1.099 in)

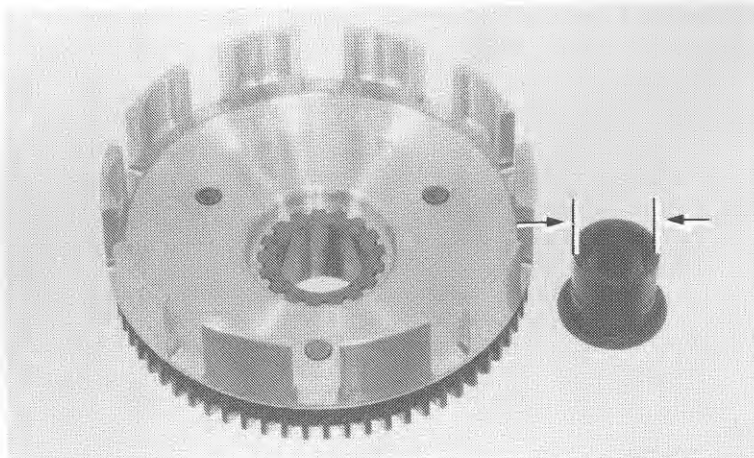

Measure the spring free length.

SERVICE LIMIT: 34.0 mm (1.34 in)

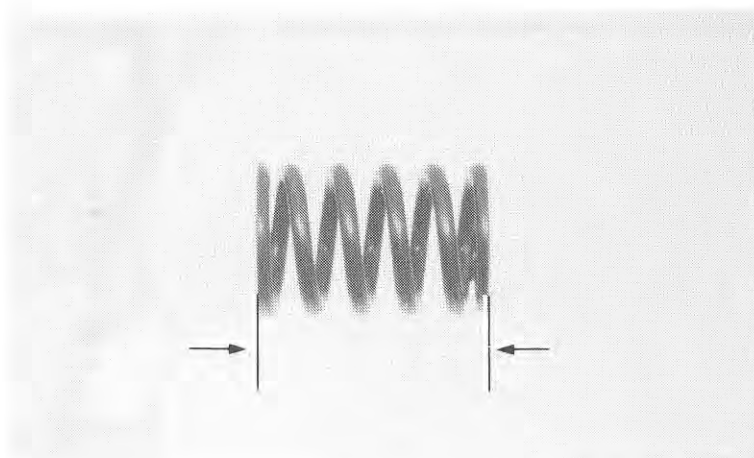

Replace the clutch discs if they show signs of scoring or discoloration.

Measure the disc thickness.

SERVICE LIMIT: 2.3 mm (0.09 in)

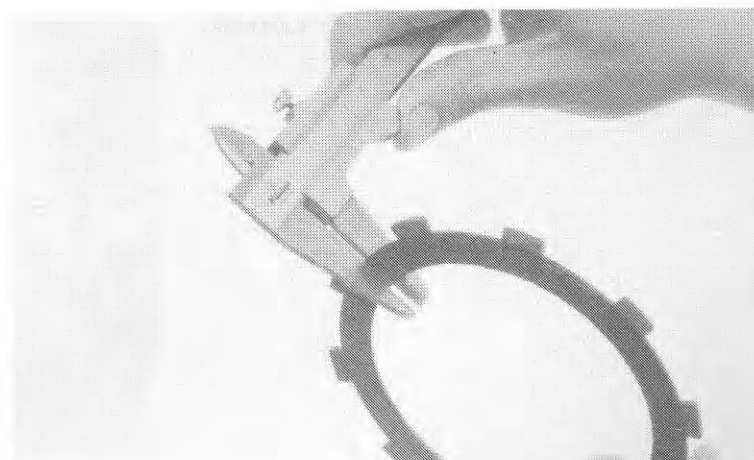

Check for plate and disc warpage on a surface plate using a feeler gauge.

SERVICE LIMIT: 0.20 mm (0.008 in)

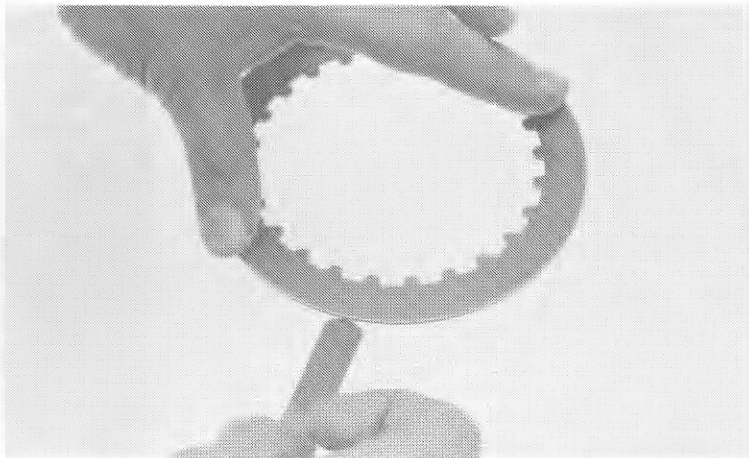

INSTALLATION

Install the clutch outer guide, clutch outer and thrust washer.

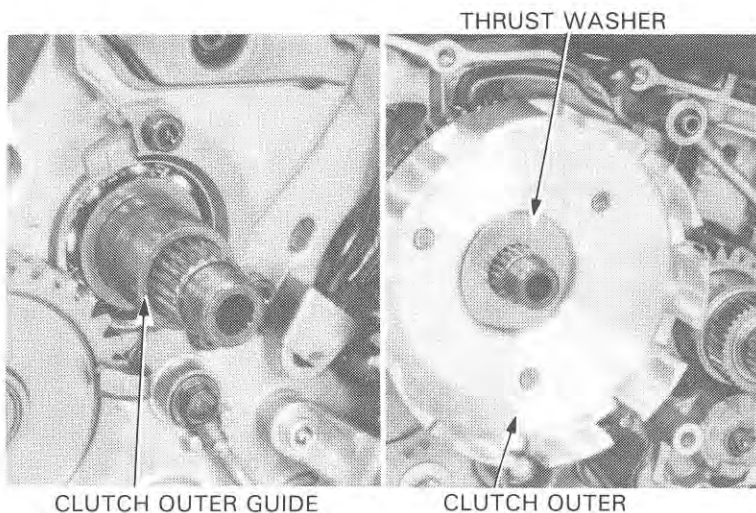

Assemble the clutch pressure plate, discs, plates and clutch center.

NOTE

- Stack the discs and plates alternately.
- Coat new clutch discs with engine oil.

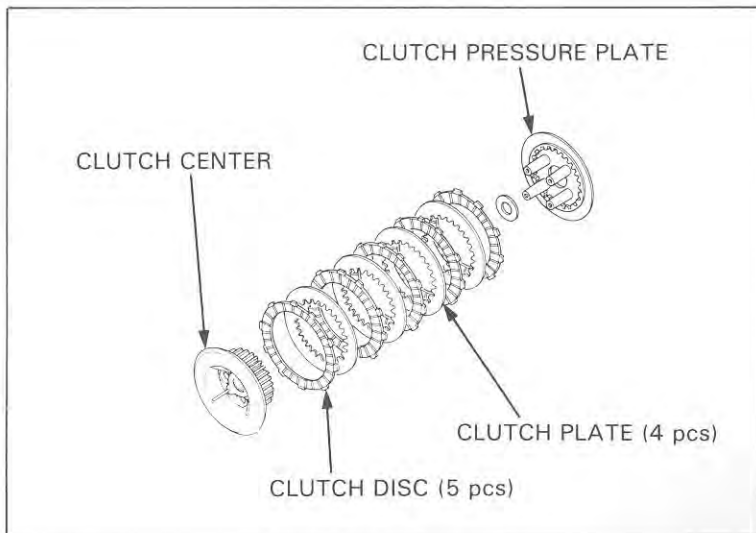

CLUTCH/OIL PUMP/KICK STARTER

Install the lock washer with the word "OUTSIDE" facing out.

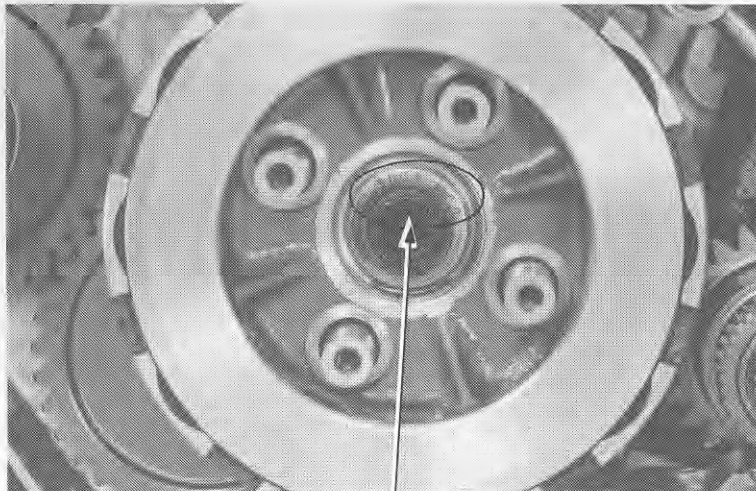

"OUTSIDE" MARK

LOCK NUT WRENCH,
17 x 27 mm 07716-0020300 OR
COMMERCIALY AVAILABLE IN U.S.A.

Clean any grease or dirt off the shaft and apply thread locking agent to the lock nut. Tighten the lock nut.

TORQUE: 100-120 N·m
(10-12 kg-m, 72-87 ft-lb)

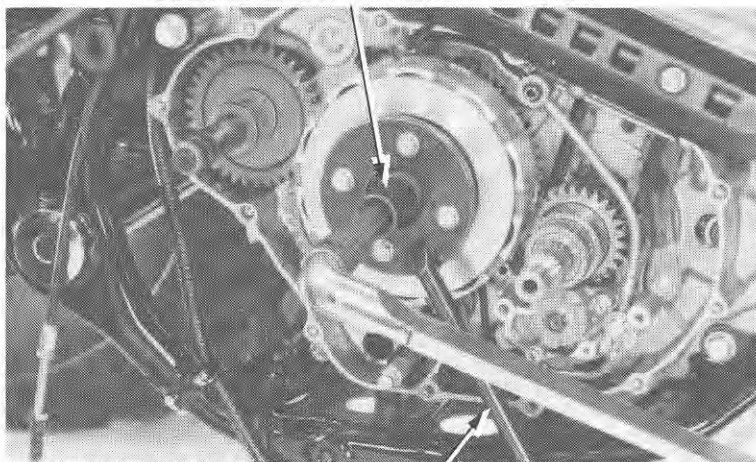

CLUTCH CENTER HOLDER 07923-KE10001

Install the following:

- clutch springs and lifter plate and tighten the clutch lifter bolts.
- bearing and lifter piece
- centrifugal clutch (page 8-13).
- separator plate and clutch lever.
- right and left crankcase cover.

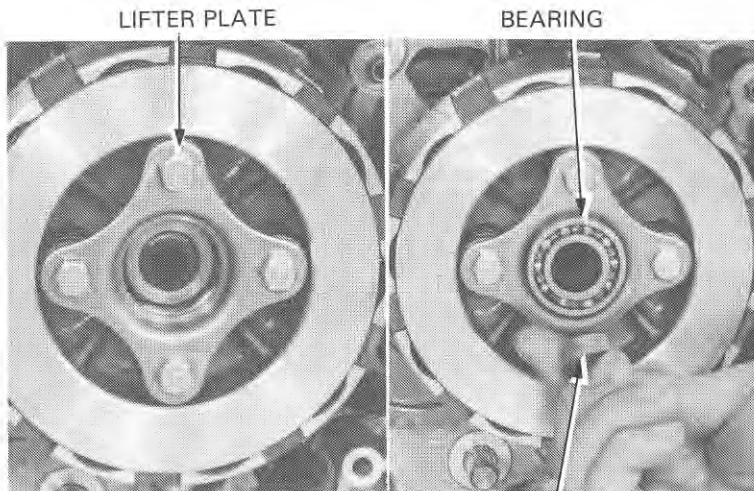

LIFTER PIECE

OIL PUMP/PRIMARY DRIVE GEAR

REMOVAL

Remove the following:

- centrifugal clutch (page 8-10)
- manual clutch (page 8-14)
- bolts and oil pipe

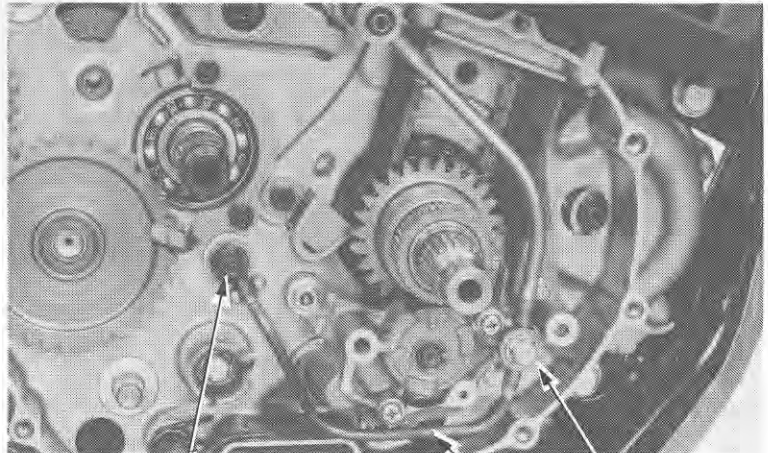

OIL BOLTS

OIL PIPE

BOLT

Remove the oil pump mounting bolts.

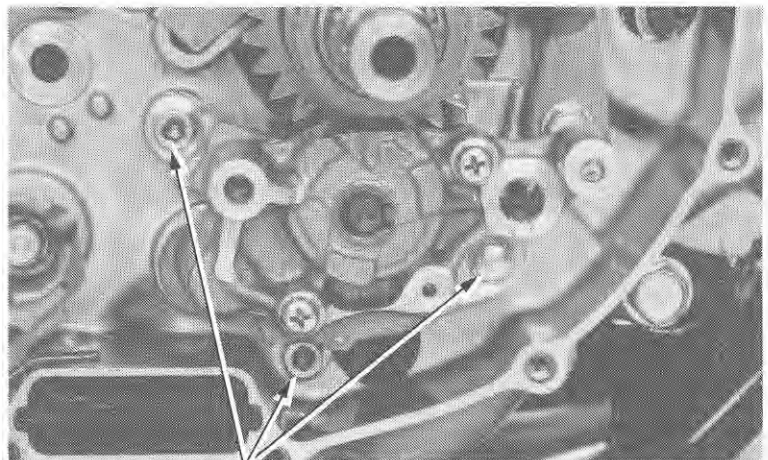

OIL PUMP MOUNTING BOLTS

Remove the oil pump, primary drive gear and thrust washer.
Remove the O-ring and two dowel pins.

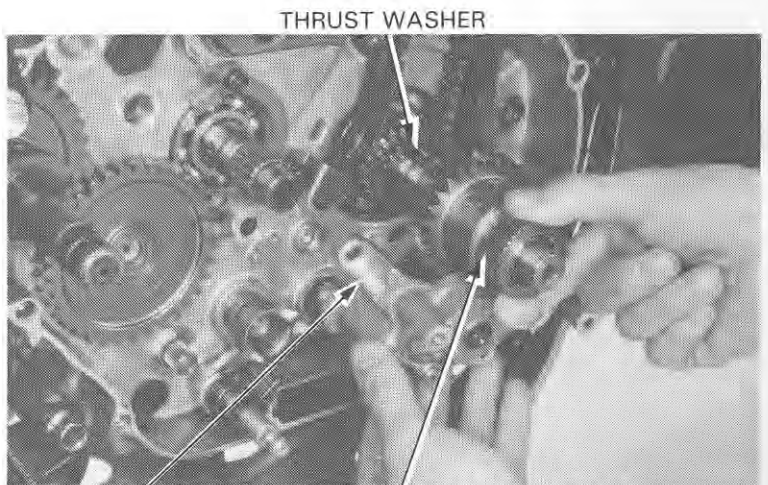

THRUST WASHER

OIL PUMP

PRIMARY DRIVE GEAR

CLUTCH/OIL PUMP/KICK STARTER

PRIMARY DRIVE GEAR INSPECTION

Inspect the primary drive gear for damage or excessive wear.

Measure the primary drive gear I.D.

SERVICE LIMIT: 24.05 mm (0.947 in)

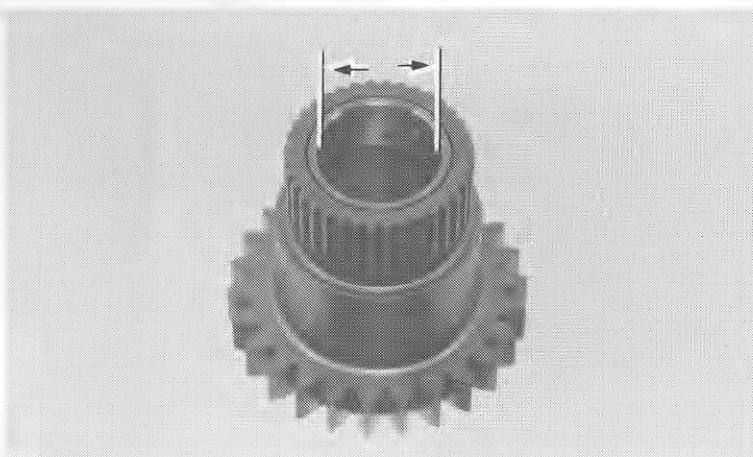

Measure the crankshaft O.D.

SERVICE LIMIT: 23.93 mm (0.942 in)

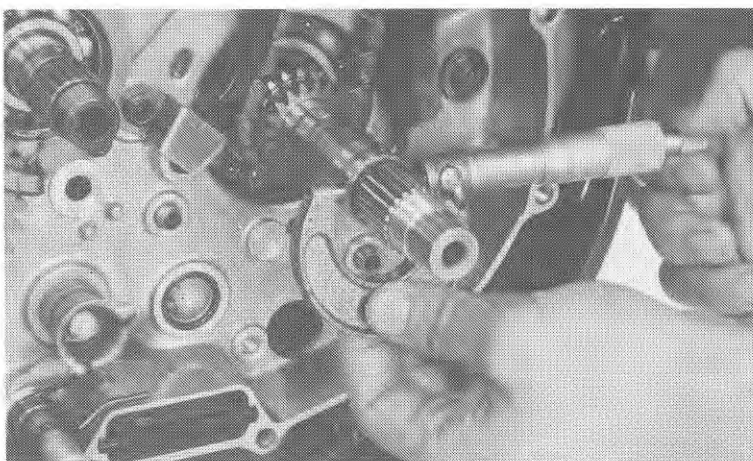

OIL PUMP DISASSEMBLY

Remove the E-clip from the oil pump driven gear.
Remove the oil pump body mounting screws.

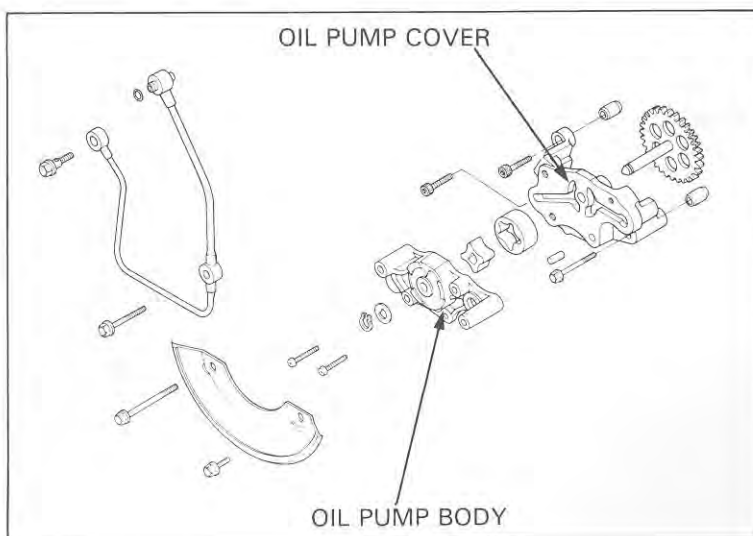

OIL PUMP INSPECTION

Install the outer and inner rotors into the body and insert the oil pump driven gear shaft.

Measure the pump body-to-rotor clearance.

SERVICE LIMIT: 0.25 mm (0.010 in)

Clean the oil pass pipe.

OIL PUMP DRIVEN GEAR SHAFT

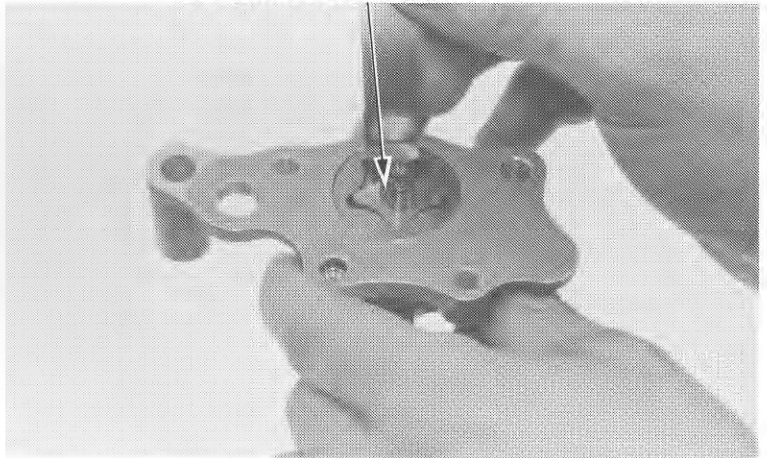

Measure the pump rotor tip clearance.

SERVICE LIMIT: 0.20 mm (0.008 in)

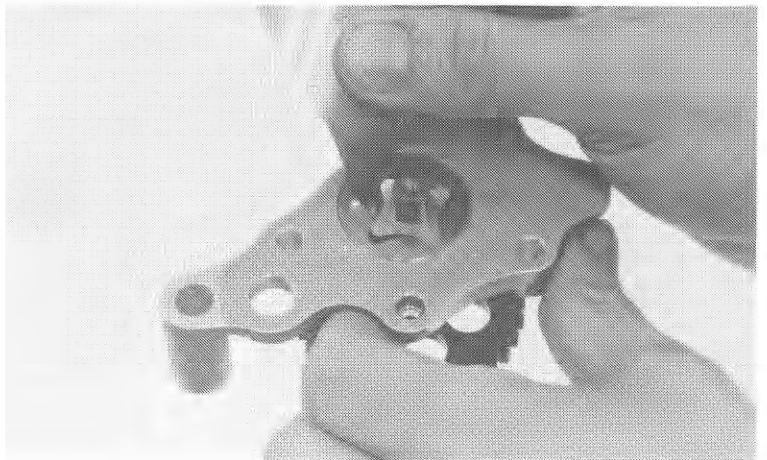

Remove the oil pump driven gear shaft from the oil pump body.

Measure the pump end clearance.

SERVICE LIMIT: 0.10 mm (0.004 in)

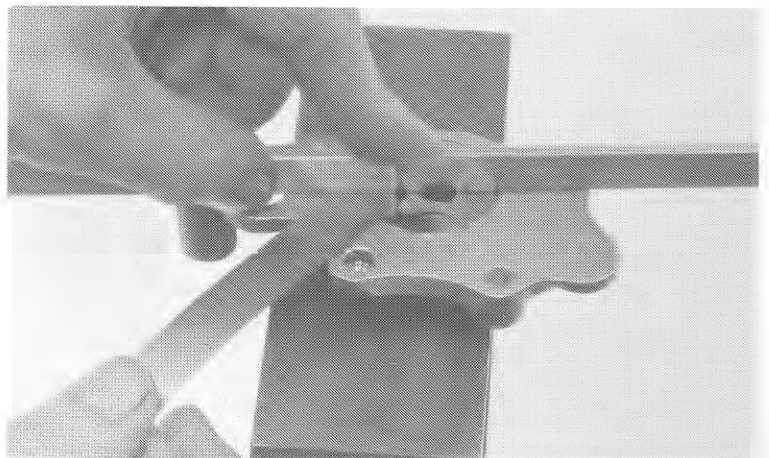

CLUTCH/OIL PUMP/KICK STARTER

OIL PUMP ASSEMBLY/INSTALLATION

Assemble the oil pump body with outer and inner rotors onto the oil pump cover with the driven gear.

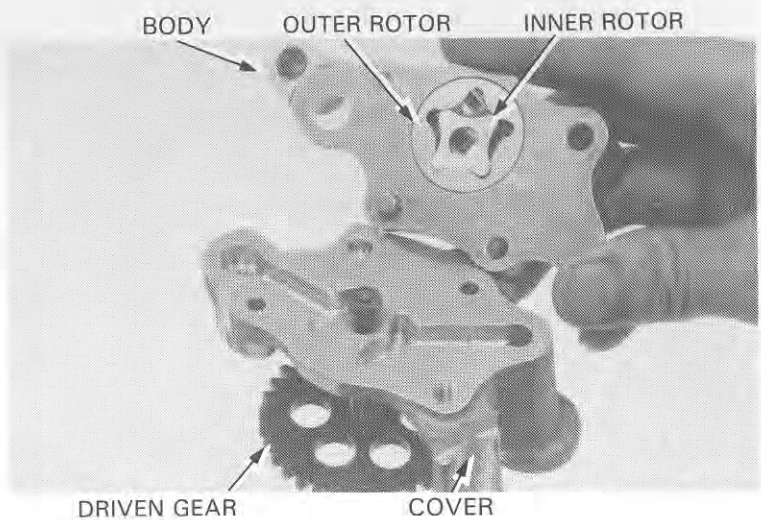

Install the washer, E-clip and oil pump body mounting screws as shown.

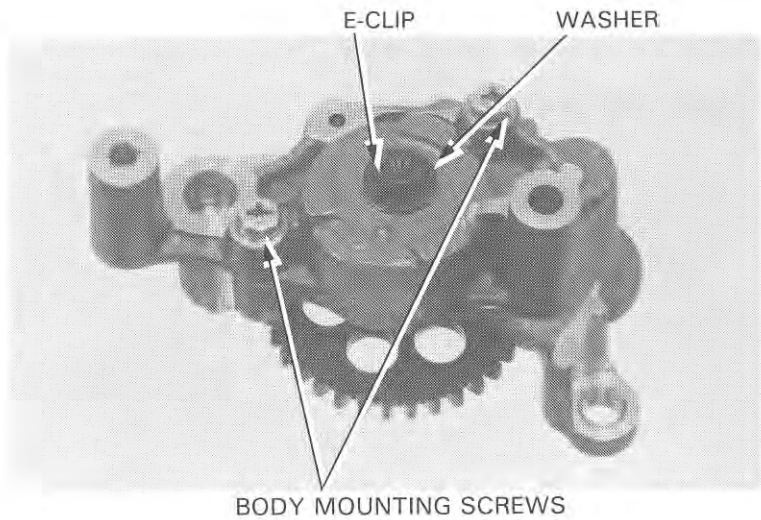

Install the thrust washer on the crankshaft and O-ring, dowel pins into the right crankcase.

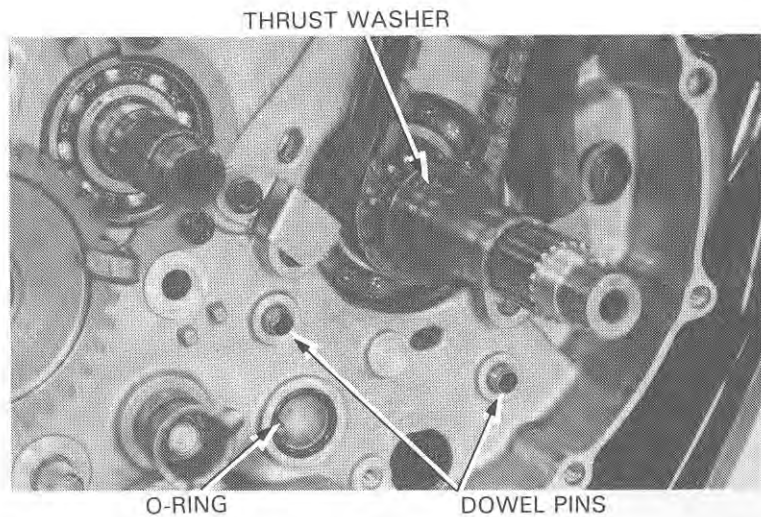

Install the oil pump and primary drive gear together and tighten the pump bolts.

Install the oil pipe with oil bolt, bolt and O-ring.

Tighten the oil bolt.

TORQUE: '85: 8–12 N·m (0.8–1.2 kg-m, 6–9 ft-lb)
After '85: 10–14 N·m (1.0–1.4 kg-m, 7–10 ft-lb)

Install the removed parts in the reverse order of removal.

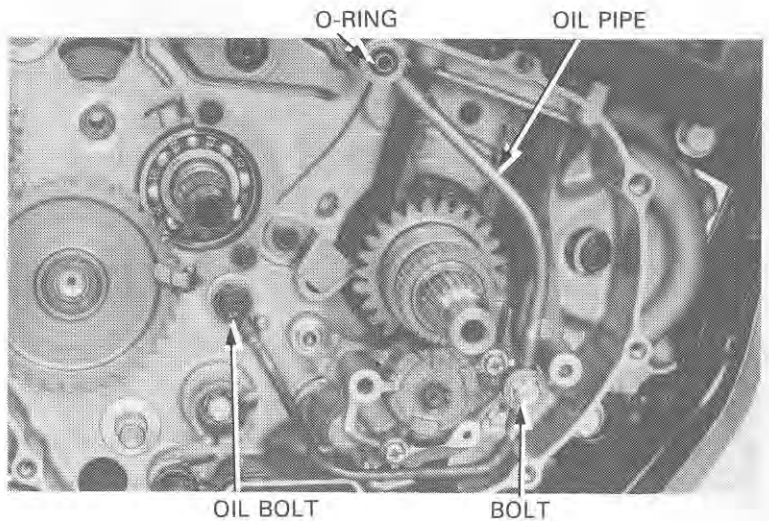

KICK STARTER

REMOVAL

Remove the following:

- right crankcase cover (page 8-3).
- manual clutch (page 8-14).
- holder plate mount bolts and plate.
- starter idler gear and bushing.
- thrust washer.

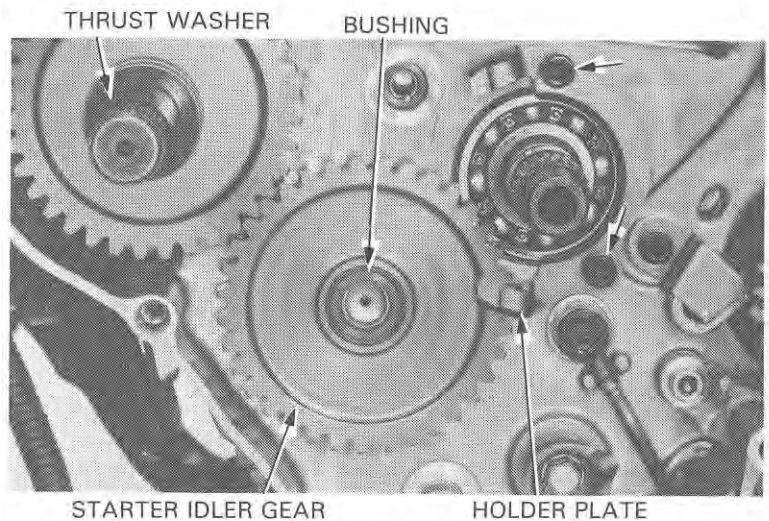

Turn the kick starter spindle clockwise to free the ratchet from the ratchet guide and remove it.

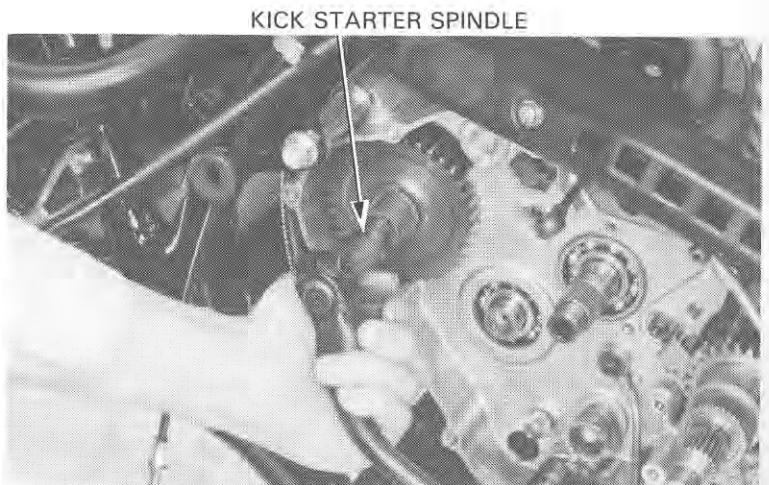

CLUTCH/OIL PUMP/KICK STARTER

Remove the washer, collar, starter return spring, spring retainer, ratchet and ratchet spring.

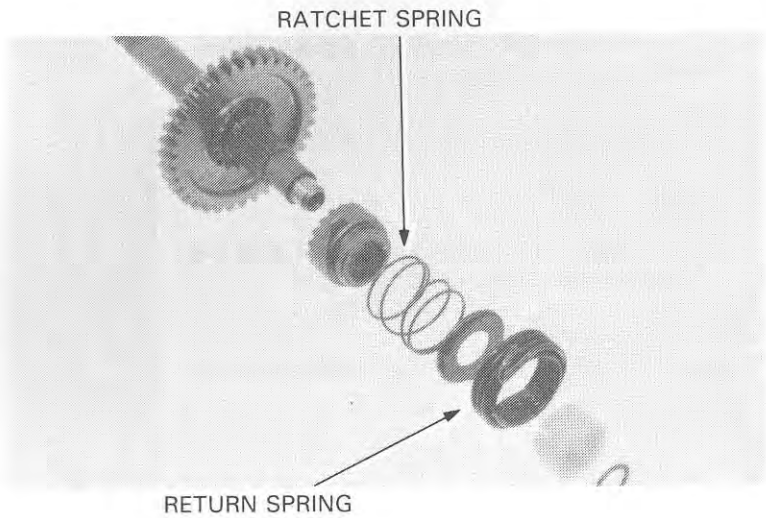

Remove the circlip and disassemble the pinion gear and washers.

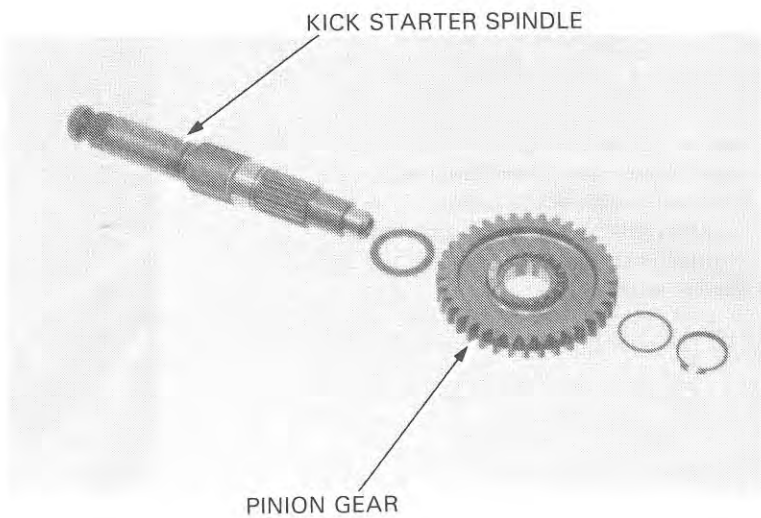

INSPECTION

Measure the kick starter spindle O.D.

SERVICE LIMIT: 21.90 mm (0.862 in)

Inspect the pinion for damaged ratchet teeth.

Measure the kick starter pinion I.D.

SERVICE LIMIT: 22.10 mm (0.870 in)

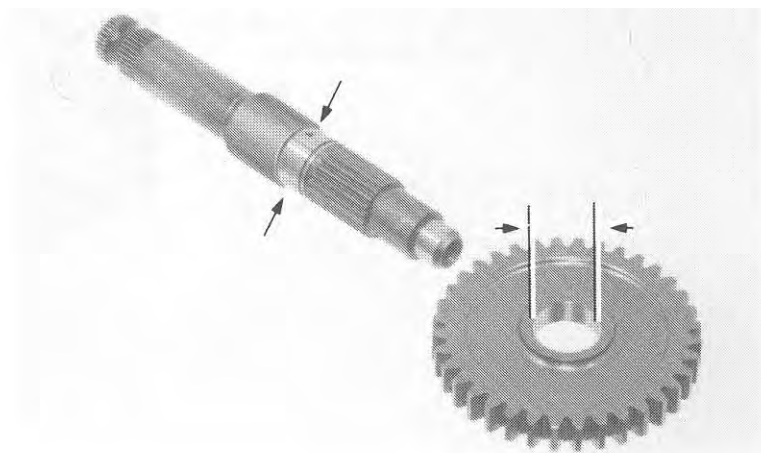

Measure the kick starter idler gear I.D.

SERVICE LIMIT: 23.07 mm (0.908 in)

Measure the kick starter idler gear bushing I.D.

SERVICE LIMIT: 20.05 mm (0.789 in)

Measure the kick starter idler gear bushing O.D.

SERVICE LIMIT: 22.93 mm (0.903 in)

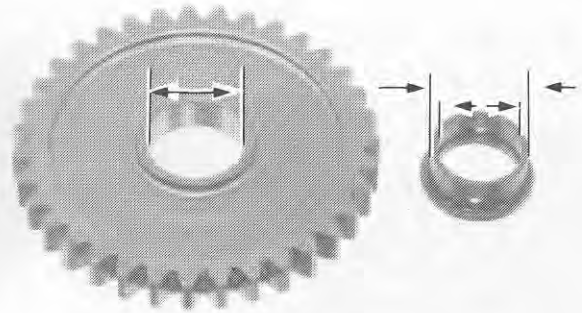

Measure the countershaft O.D.

SERVICE LIMIT: 19.95 mm (0.785 in)

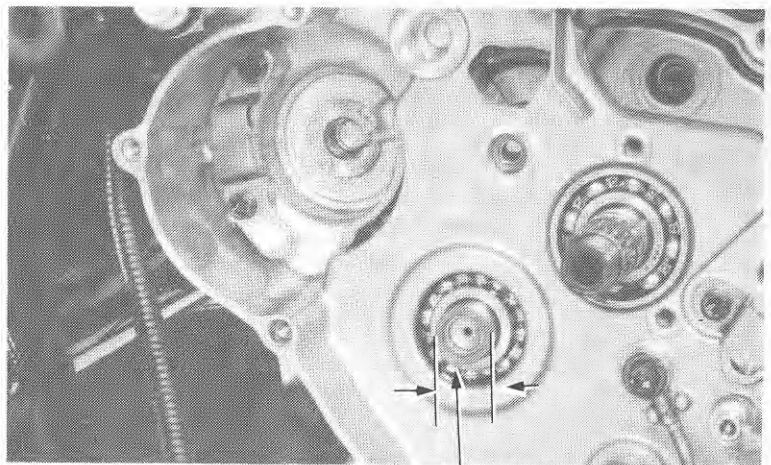

COUNTERSHAFT

INSTALLATION

Install the inner thrust washer and pinion gear on the kick starter spindle.

Install the outer thrust washer and circlip.

Install the starter ratchet on the spindle while aligning their punch marks.

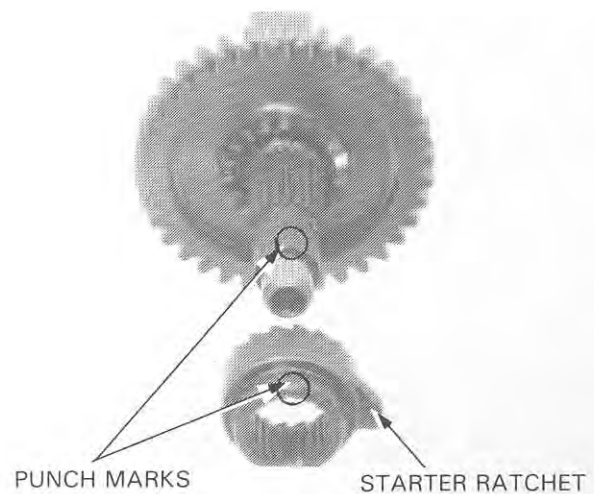

CLUTCH/OIL PUMP/KICK STARTER

Assemble the ratchet spring, spring retainer, return spring, collar and washer.

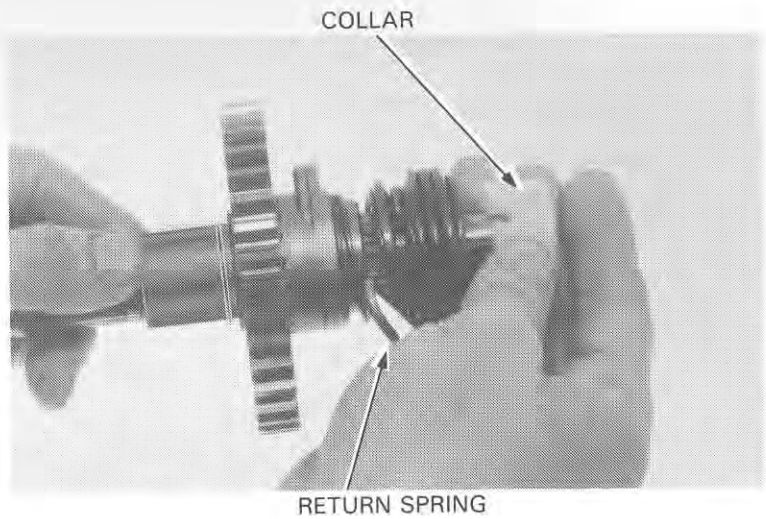

Hook the return spring onto the crankcase.

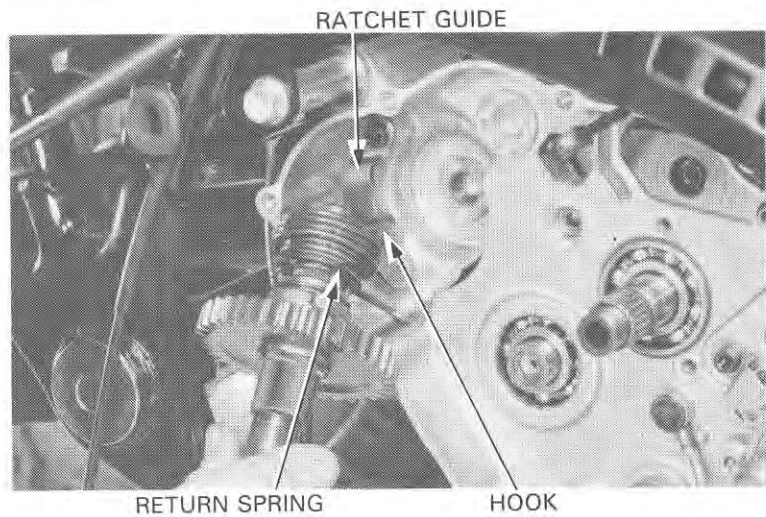

Install the kick starter assembly by turning it clockwise and aligning the ratchet with the ratchet guide.

Make sure that the punch mark on the end of the spindle is facing up.

Install the removed parts in the reverse order of removal.

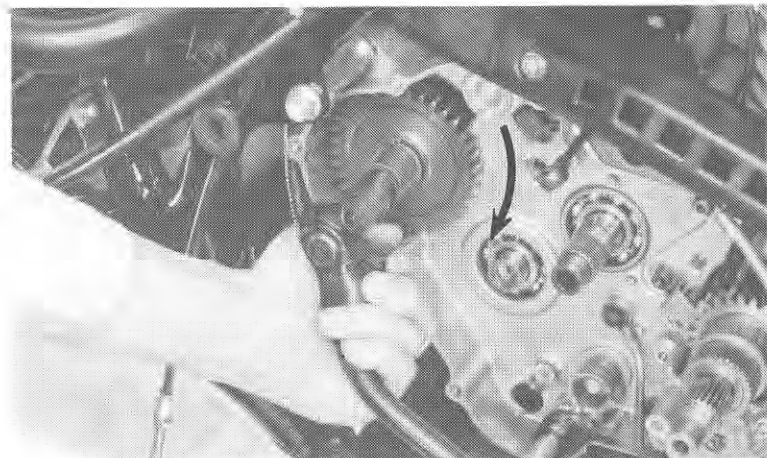

RIGHT CRANKCASE COVER INSTALLATION

Install the dowel pins and gasket.

Install the right crankcase cover and bolts.
Tighten the cover mounting bolts.
Install the oil bolt with two sealing washers.

TORQUE:

8–12 N·m (0.8–1.2 kg-m, 6–9 ft-lb)
After '85: 10–14 N·m (1.0–1.4 kg-m,
7–10 ft-lb)

Install the reverse cable holder arm onto the reverse shaft. Be sure the punch mark aligns with the index mark.

Connect the neutral and reverse wires to the switches.

WARNING

Connect the light green/red wire to the neutral switch and the grey wire to the reverse switch

Install the following:

- reverse cable.
- neutral and reverse switch cover.
- kick starter pedal by aligning the punch marks.
- foot peg with bolts.
- right frame side cover.

Adjust the clutch (page 3-11).

Adjust the reverse cable (page 3-13).

Fill the engine with oil. Check the clutch and reverse gear for smooth operation.

Check for oil leaks.

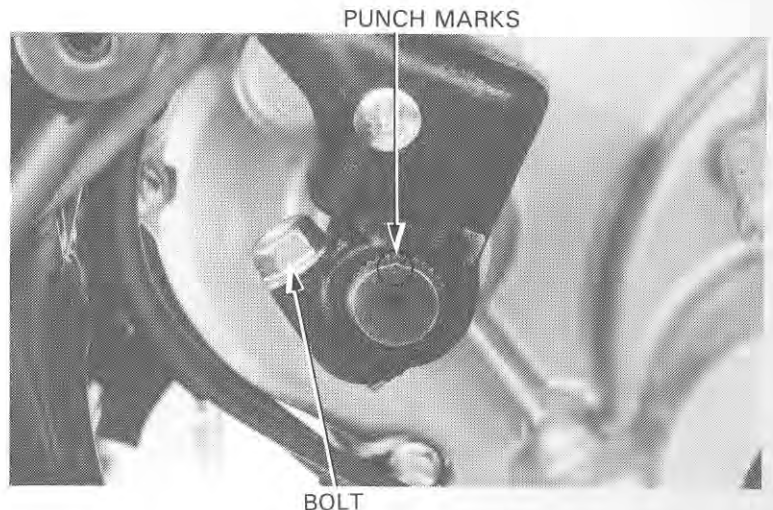
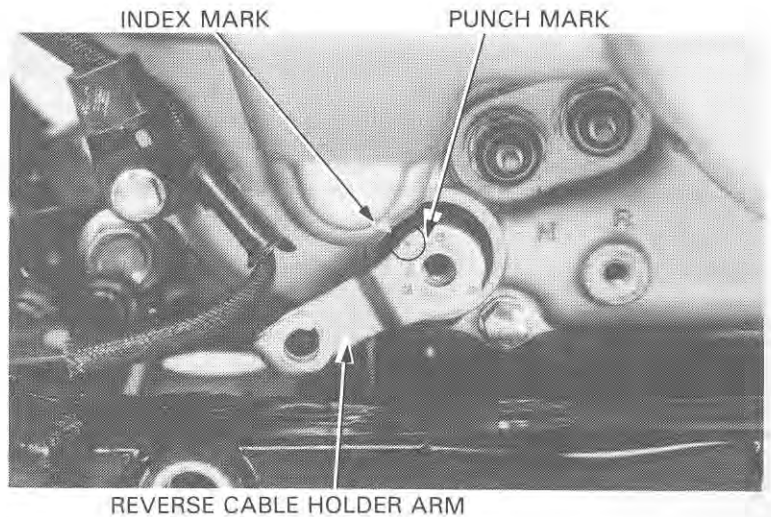
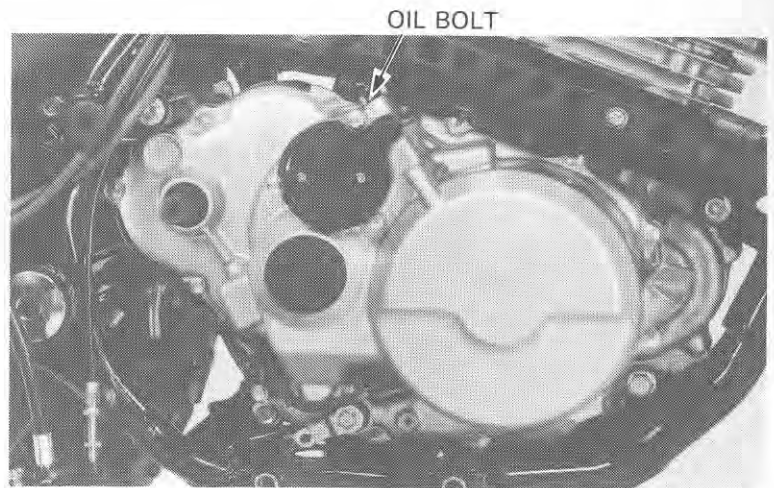

**ALTERNATOR/STARTER CLUTCH/
GEARSHIFT LINKAGE**

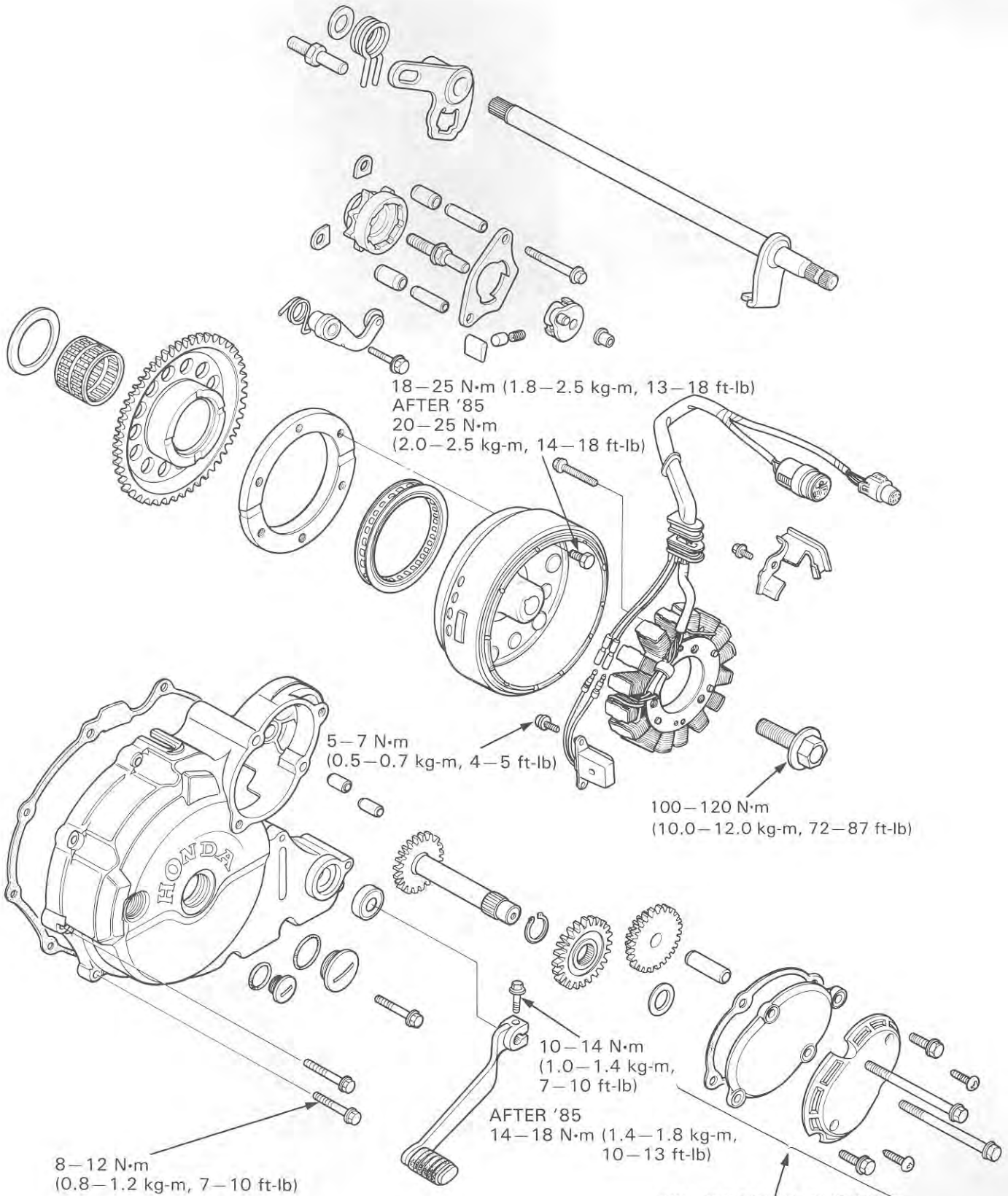

'85, '86 MODEL SHOWN
SEE PAGES 9-3 FOR AFTER '86.

9. ALTERNATOR/STARTER CLUTCH/ GEARSHIFT LINKAGE

SERVICE INFORMATION	9-1	STARTER CLUTCH	9-7
TROUBLESHOOTING	9-1	GEARSHIFT LINKAGE	9-9
STARTER REDUCTION GEAR	9-2	LEFT CRANKCASE COVER INSTALLATION	9-13
LEFT CRANKCASE COVER REMOVAL	9-5		
ALTERNATOR	9-5		

SERVICE INFORMATION

GENERAL

This section covers removal and installation of the starter reduction gear, alternator, stater clutch and gearshift linkage. Refer to Section 15 for alternator inspection.

TORQUE VALUES

Flywheel bolt		100–120 N·m (10.0–12.0 kg-m, 72–87 ft-lb)
Starter clutch torx bolt		18–25 N·m (1.8–2.5 kg-m, 13–18 ft-lb)
	After '85:	20–25 N·m (2.0–2.5 kg-m, 14–18 ft-lb)
Foot peg bolt		40–50 N·m (4.0–5.0 kg-m, 29–36 ft-lb)
Left crankcase cover SH bolt		8–12 N·m (0.8–1.2 kg-m, 6–9 ft-lb)
Gear shift pedal bolt		10–14 N·m (1.0–1.4 kg-m, 7–10 ft-lb)
	After '85:	14–18 N·m (1.4–1.8 kg-m, 10–13 ft-lb)
Alternator stator SH bolt		8–12 N·m (0.8–1.2 kg-m, 6–9 ft-lb)
Pulse generator screw		5–7 N·m (0.5–0.7 kg-m, 4–5 ft-lb)

TOOLS

Special

Bearing remover set, 10 mm	07936–GE00000
Remover weight	07741–0010201 or 07936–3710200

Common

Flywheel holder	07725–0040000 or strap wrench, commercially available in U.S.A.
Rotor puller	07733–0020001 or 07933–3950000
Driver	07749–0010000
Attachment, 24 x 26 mm	07746–0010700

TROUBLESHOOTING

Engine does not turn

– Faulty one-way starter clutch

Transmission jumps out of gear

– Shift drum stopper broken

Hard to shift

– Shift drum cam plate damage

Gearshift pedal will not return

1. Weak or broken shift return spring
2. Shift spindle binding with case

STARTER REDUCTION GEAR

REMOVAL

Remove the starter reduction gear cover bolts, cover, gasket and dowel pins.

STARTER REDUCTION GEAR COVER

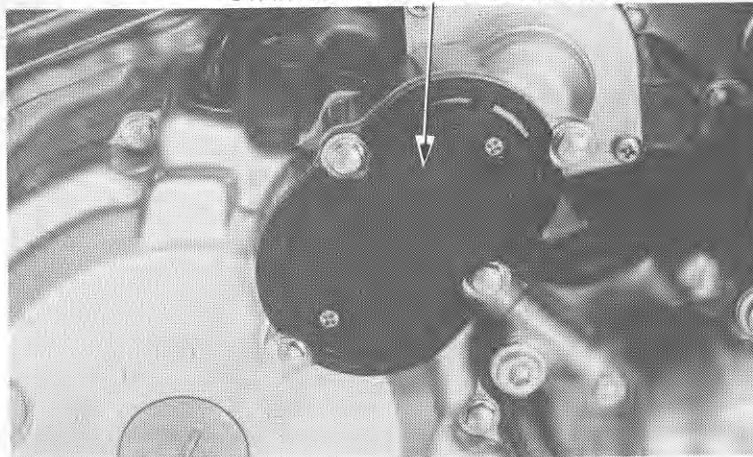

Remove the reduction gear A/B and shaft, starter reduction gear C and shaft.

'85., '86

REDUCTION GEAR A/B

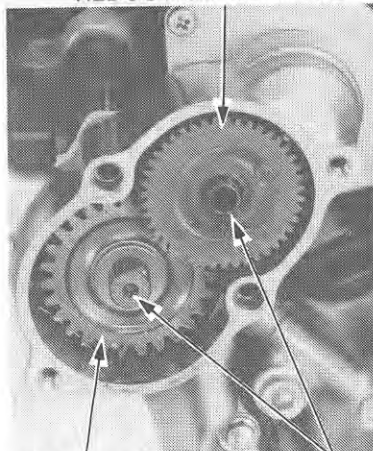

REDUCTION GEAR C

SHAFT

AFTER '86:

REDUCTION GEAR A/B

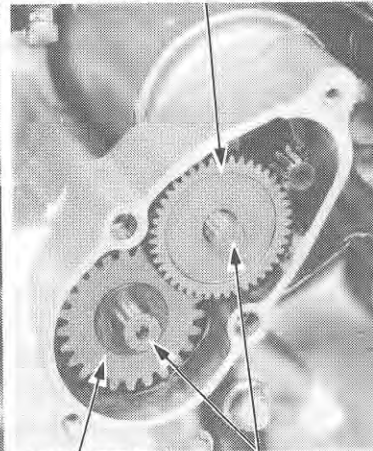

REDUCTION GEAR C

SHAFT

INSPECTION

'85., '86:

Inspect the starter reduction gear teeth for wear or damage.

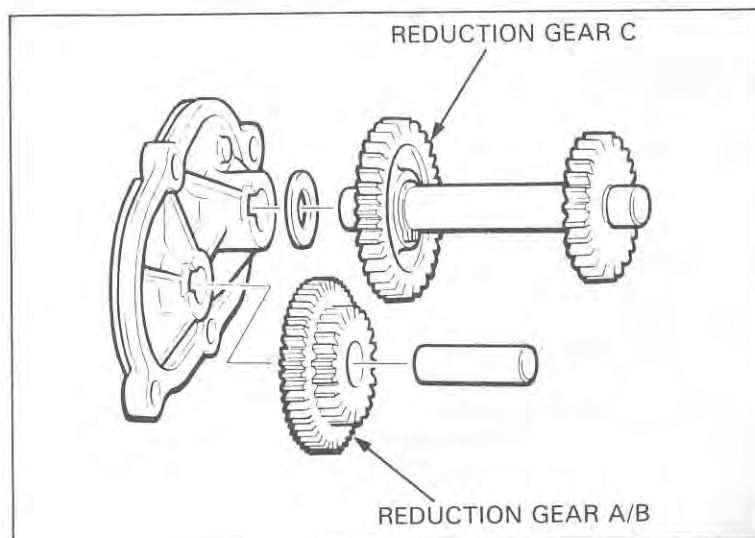

REDUCTION GEAR C

REDUCTION GEAR A/B

ALTERNATOR/STARTER CLUTCH/ GEARSHIFT LINKAGE

After '86:

Inspect the starter reduction gear teeth for wear or damage.
Check the reduction gear bearing for excessive play or damage and replace if necessary.

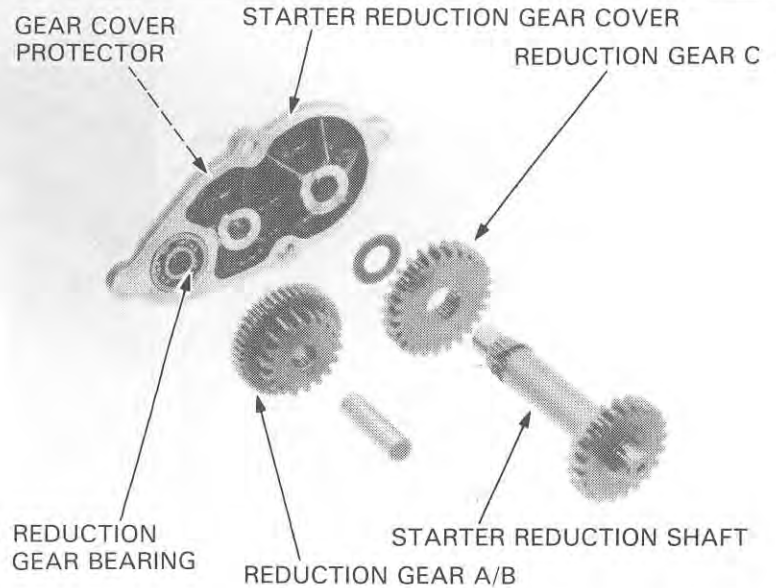

BEARING REPLACEMENT

After '86:

Remove the gear cover protector by removing the screws.
Remove the reduction gear bearing using the bearing remover tool.

TOOLS:

Bearing remover set, 10 mm	07936-GE00000
Remover wight	07741-0010201 or 07936-3710200

Drive the reduction gear bearing out from the starter reduction gear cover.

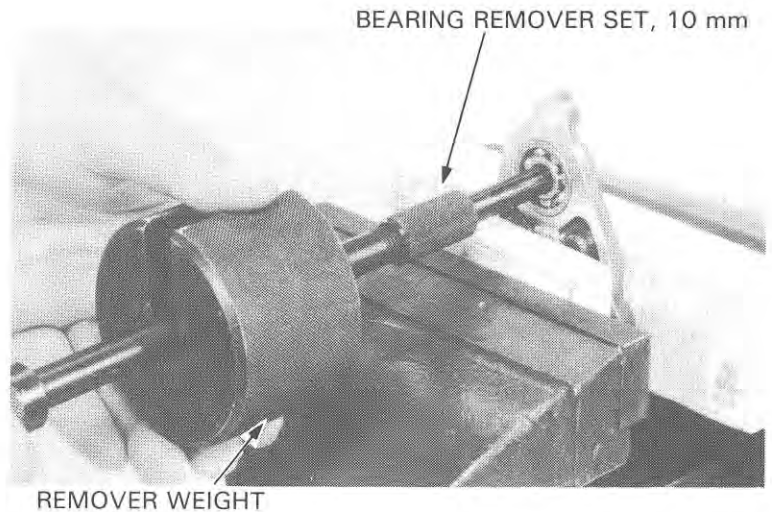

Drive the new bearing into the starter reduction gear cover.

TOOLS:

Driver	07749-0010000
Attachment, 24 x 26 mm	07746-0010700

Install the gear cover protector with screws.

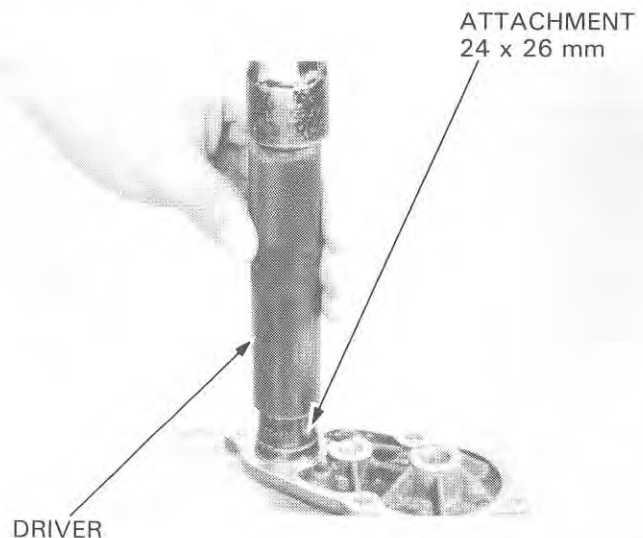

ALTERNATOR/STARTER CLUTCH/ GEARSHIFT LINKAGE

INSTALLATION

Install the starter reduction C shaft into the left crankcase.

'85, '86 MODEL SHOWN

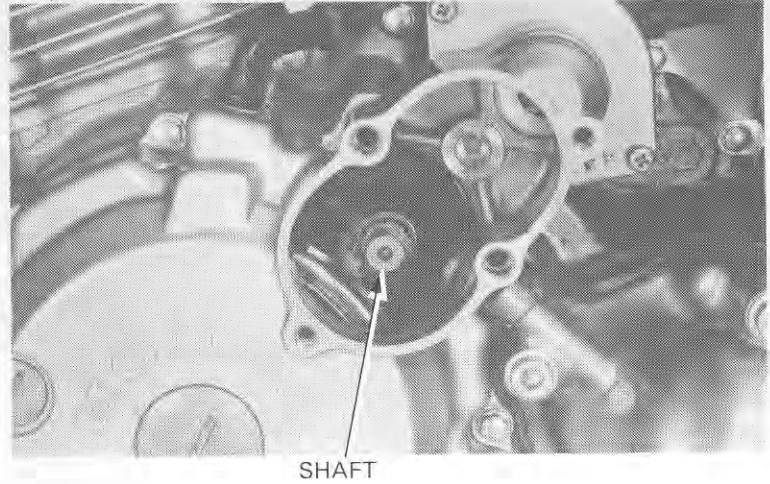

Install the starter reduction gear C, starter reduction gear A/B shaft and gear.

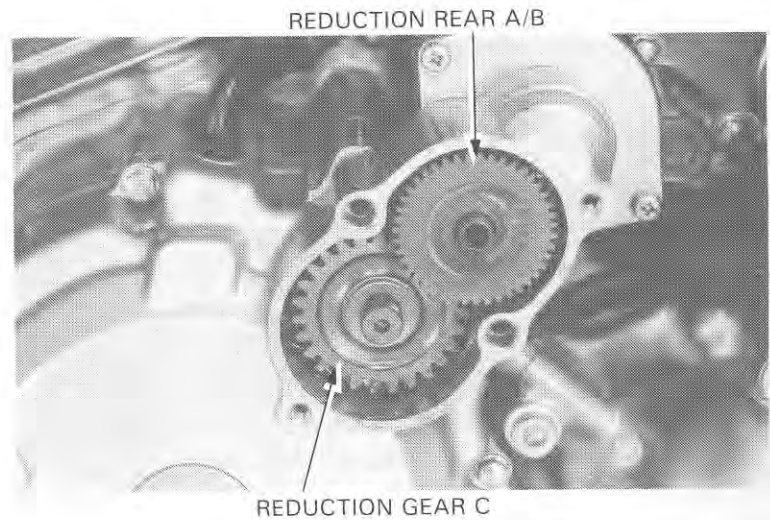

Install the gasket, dowel pins, and starter reduction gear cover with four bolts.

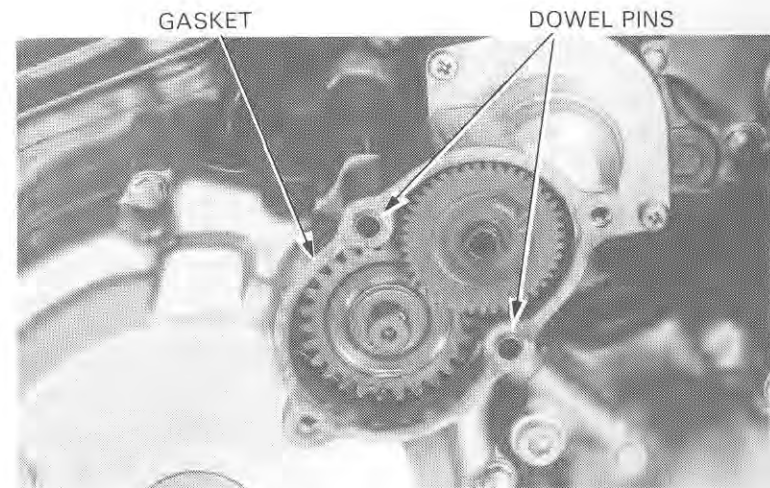

LEFT CRANKCASE COVER REMOVAL

Drain the oil from the engine.
Remove the left frame side cover, seat, gearshift pedal and left foot peg assembly.
Disconnect the alternator/pulse generator couplers.

ALTERNATOR/PULSE GENERATOR COUPLERS

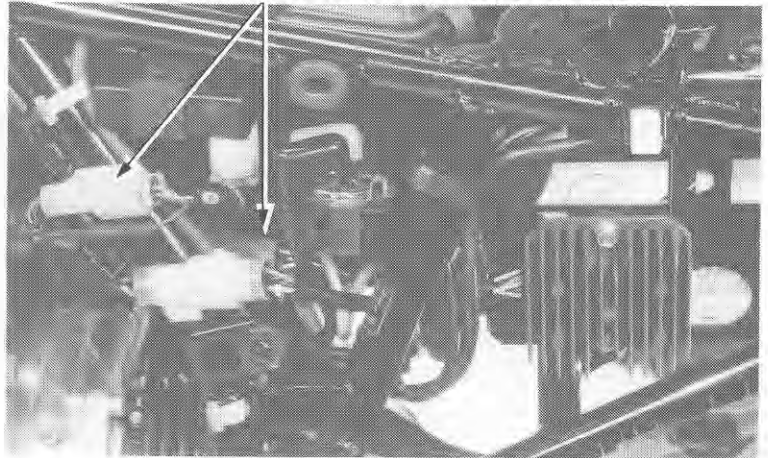

Remove the starter reduction cover and gears (page 9-2).
Remove the left crankcase cover mounting bolts and cover.

CAUTION

*Do not force removal of the cover or the shift shaft seal will be damaged.
If the cover is difficult to remove, loosen the engine mount bolts and raise the engine to provide the necessary clearance to remove the cover.*

Check the oil seal on the left crankcase cover for wear or damage.
Replace if necessary.

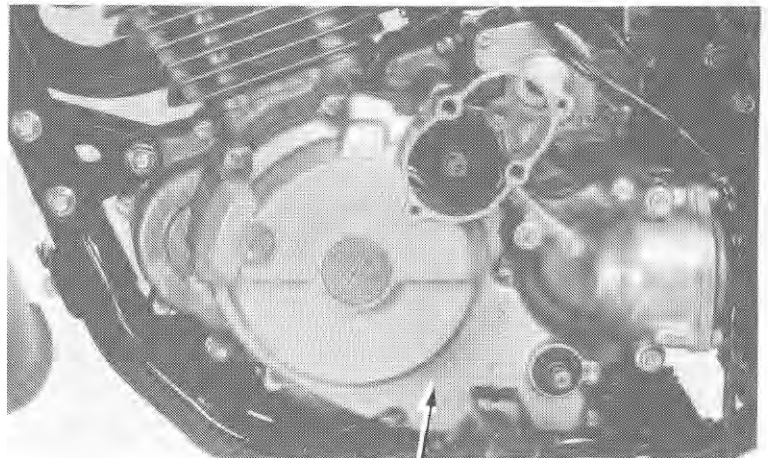

LEFT CRANKCASE COVER

ALTERNATOR

STATOR/PULSE GENERATOR REMOVAL

Remove the wire clamp by removing the bolt.
Remove the pulse generator mounting screws, disconnect the wire connector and remove the pulse generator.
Remove the three stator bolts and stator.

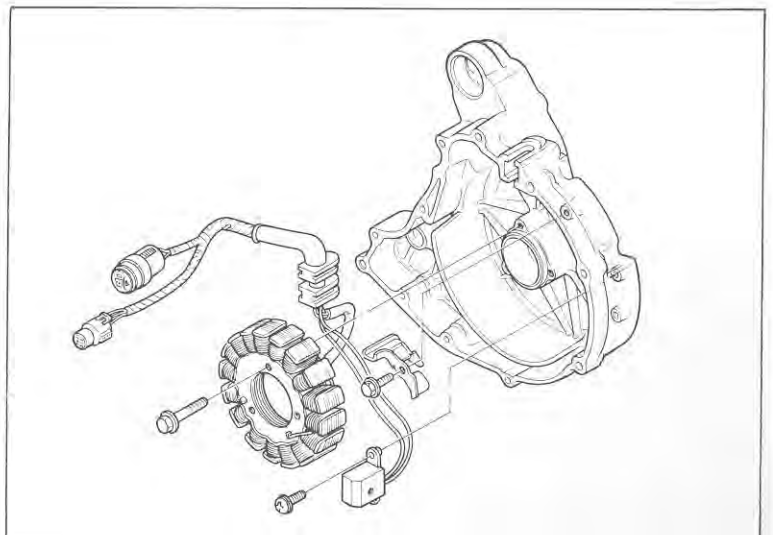

ALTERNATOR/STARTER CLUTCH/ GEARSHIFT LINKAGE

STATOR/PULSE GENERATOR INSTALLATION

Insert the wire grommet into the groove in the left crankcase cover and install the stator, pulse generator and wire clamp.

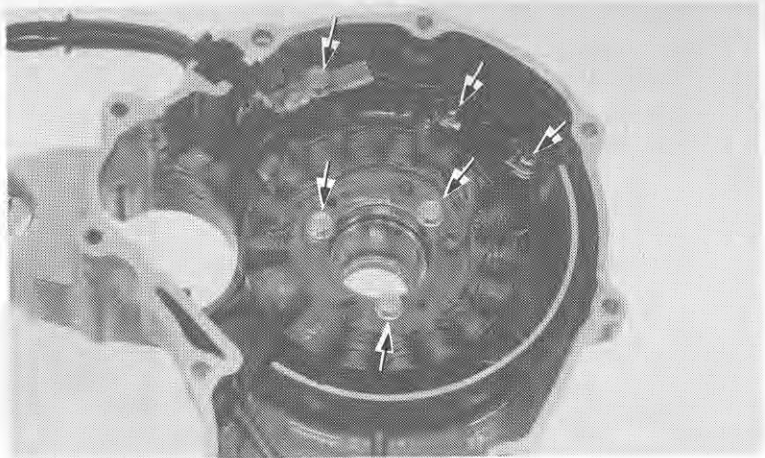

FLYWHEEL REMOVAL

Hold the flywheel with the flywheel holder and remove the flywheel bolt.

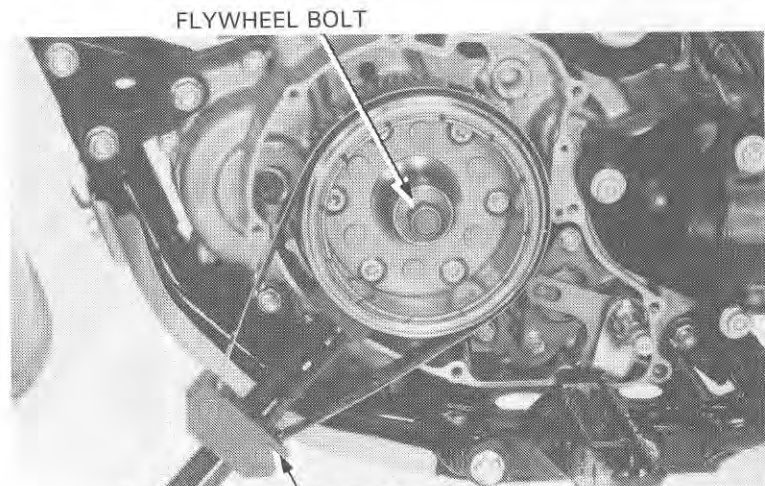

FLYWHEEL BOLT
FLYWHEEL HOLDER 07725-0040000 OR STRAP
WRENCH COMMERCIALY AVAICABLE IN U.S.A.

Remove the flywheel with the rotor puller.

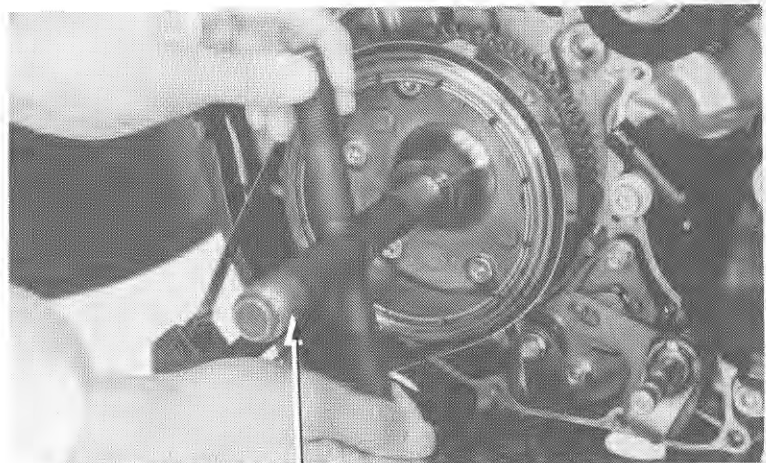

ROTOR PULLER
07733-0020001 OR 07933-3950000

FLYWHEEL INSTALLATION

Install the starter driven gear onto the flywheel.

Align the key way in the flywheel with the key on the crankshaft.

Hold the flywheel with the flywheel holder and tighten the bolt.

TORQUE: 100–120 N·m
(10.0–12.0 kg-m, 72–87 ft-lb)

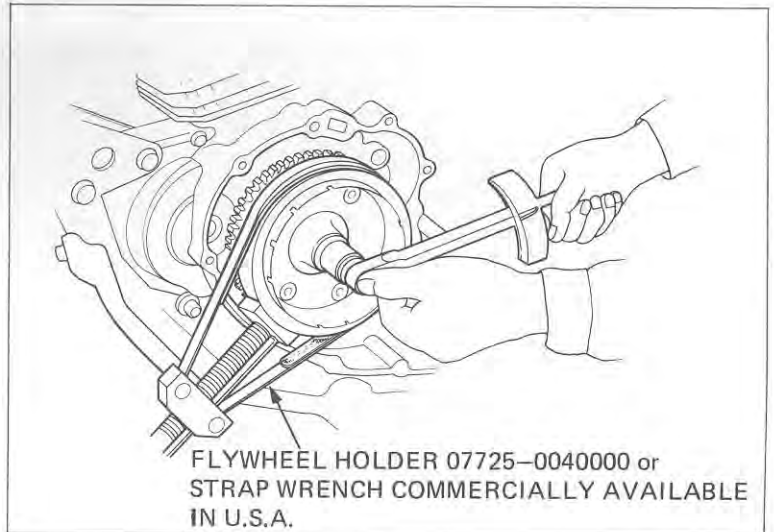

STARTER CLUTCH

REMOVAL

Remove the left crankcase cover (page 9-5).

Remove the flywheel (page 9-6).

Remove the starter driven gear.

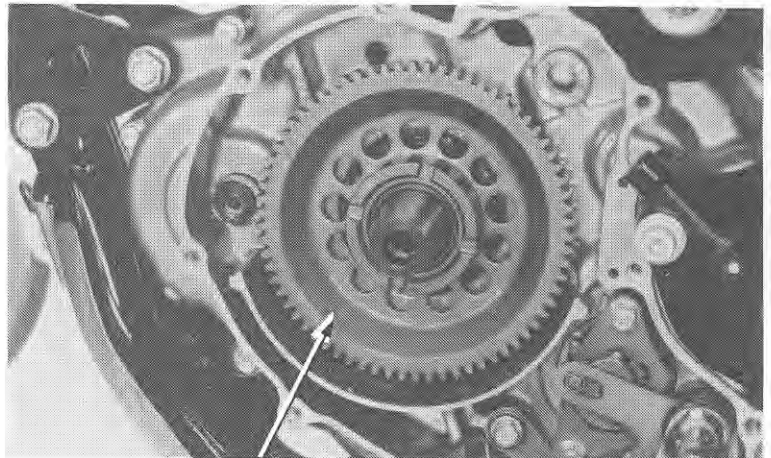

STARTER DRIVEN GEAR

Remove the needle bearing and washer.

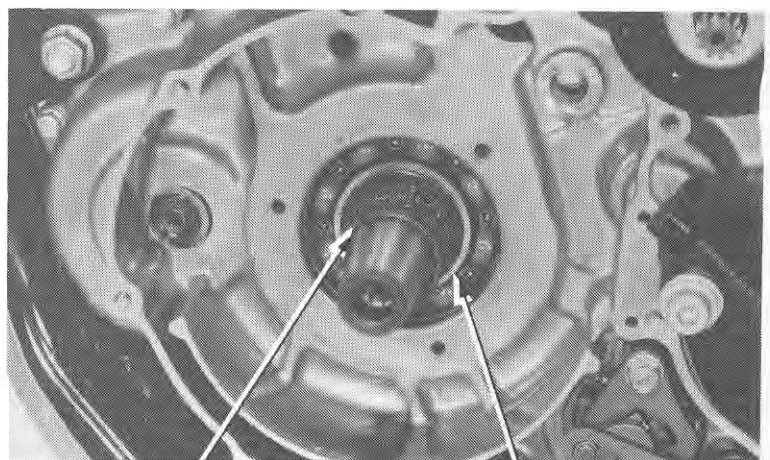

NEEDLE BEARING

WASHER

ALTERNATOR/STARTER CLUTCH/ GEARSHIFT LINKAGE

Remove the one-way clutch from the flywheel.

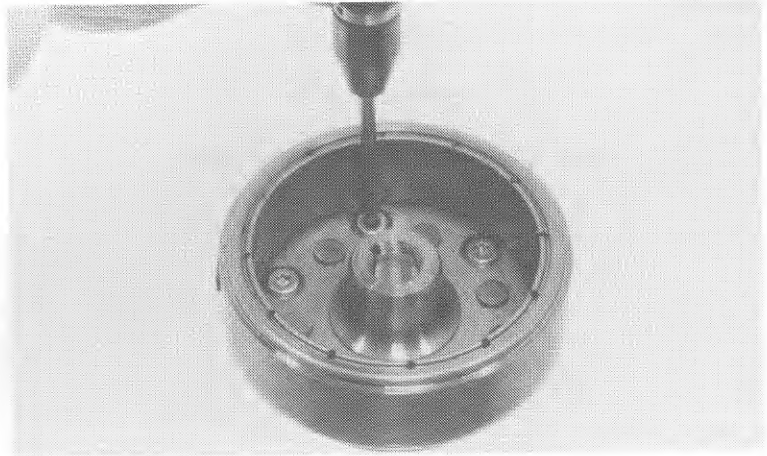

INSPECTION

Inspect the starter driven gear teeth for damage or abnormal wear.

Check the needle bearing for damage.

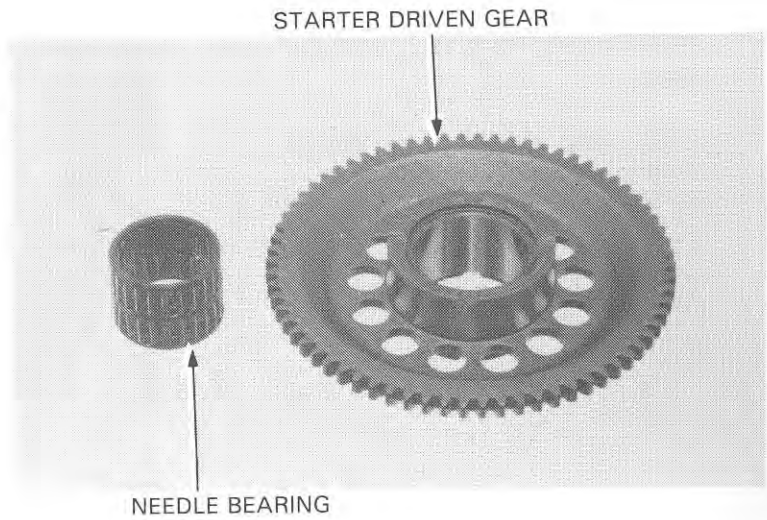

Check the rollers of the one-way starter clutch for wear or damage.

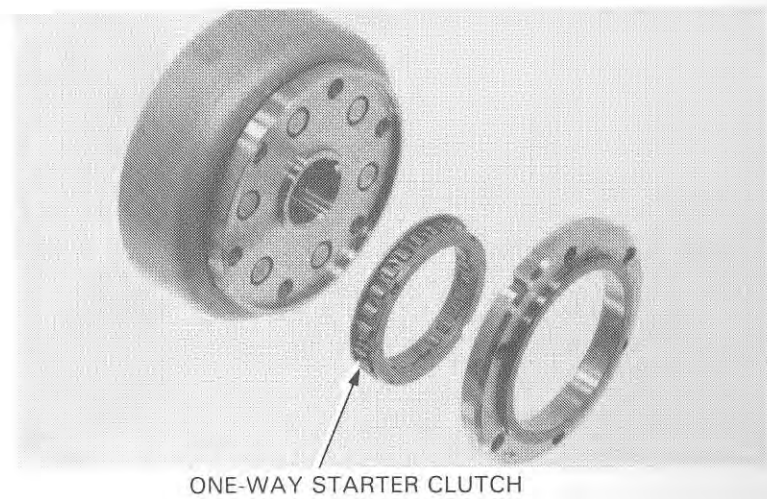

INSTALLATION

Install the one-way clutch onto the flywheel and tighten the torx bolts.

TORQUE: 18–25 N·m (1.8–2.5 kg·m, 13–18 ft·lb)
After '85: 20–25 N·m (2.0–2.5 kg·m, 14–18 ft·lb)

Refer to flywheel installation (page 9-7).

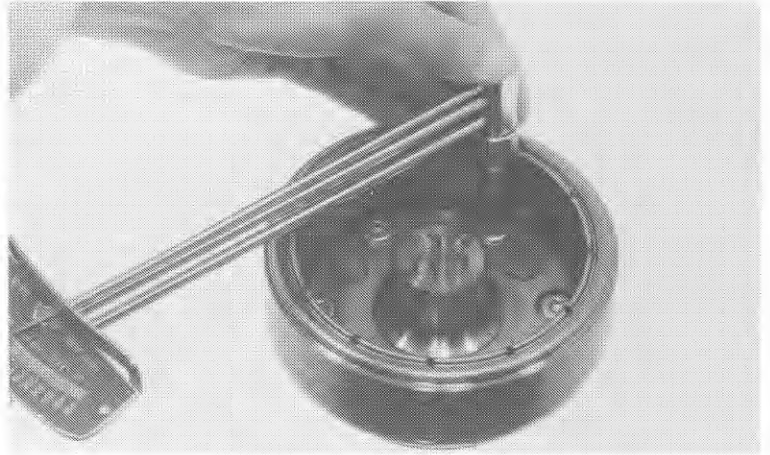

Install the starter driven gear into the one-way clutch by turning it clockwise.

Check the operation of the one-way clutch by turning the driven gear. You should be able to turn the driven gear clockwise smoothly, but not be able to turn it counterclockwise.

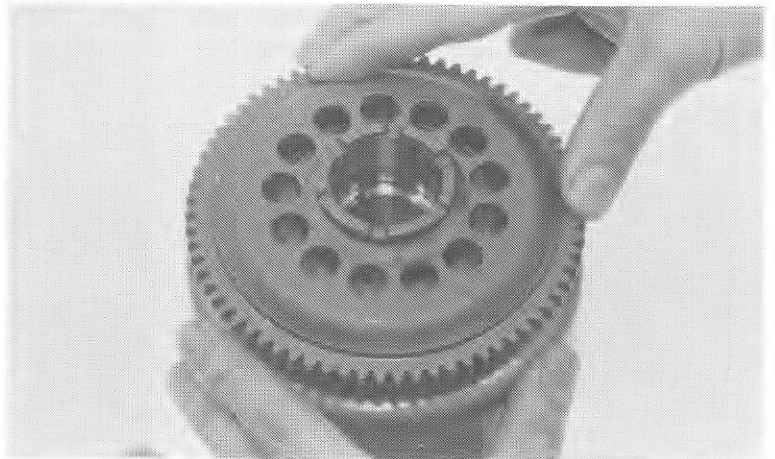

GEARSHIFT LINKAGE

REMOVAL

Remove the following:

- left crankcase cover (page 9-13).
- right crankcase cover (page 8-3).
- clutch lever.

Pull the gearshift spindle out of the crankcase.

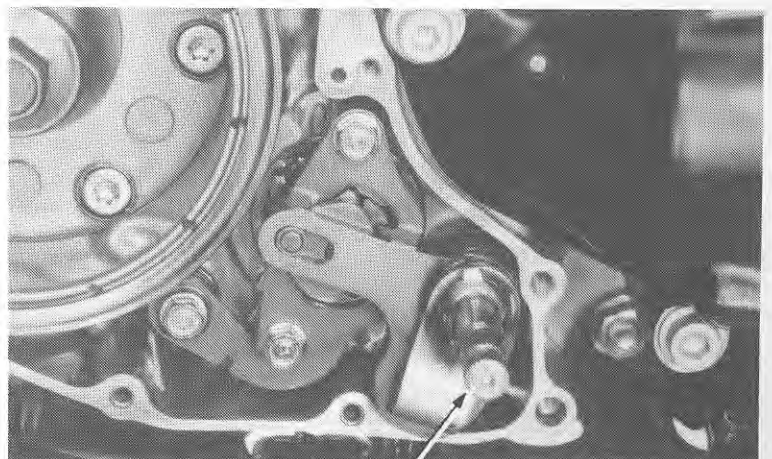

GEARSHIFT SPINDLE

ALTERNATOR/STARTER CLUTCH/ GEARSHIFT LINKAGE

Remove the washer, and return spring.

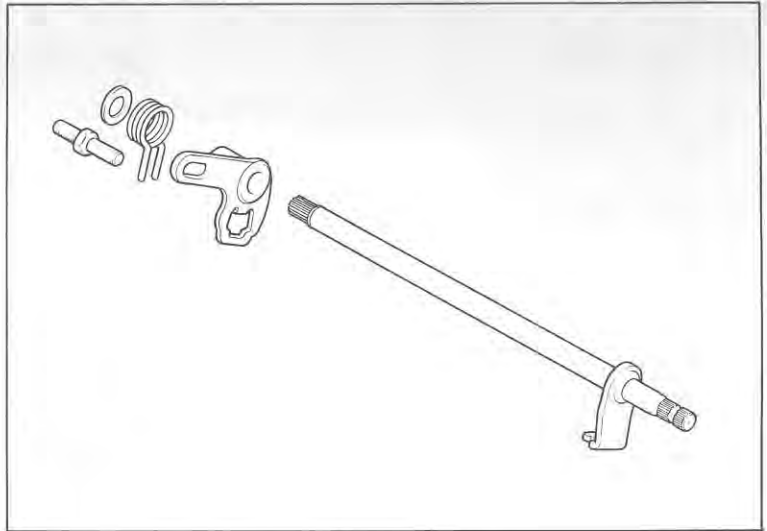

Remove the guide plate bolts, drum shifter, with guide plate, dowel pins, bearing stopper plates and collars.

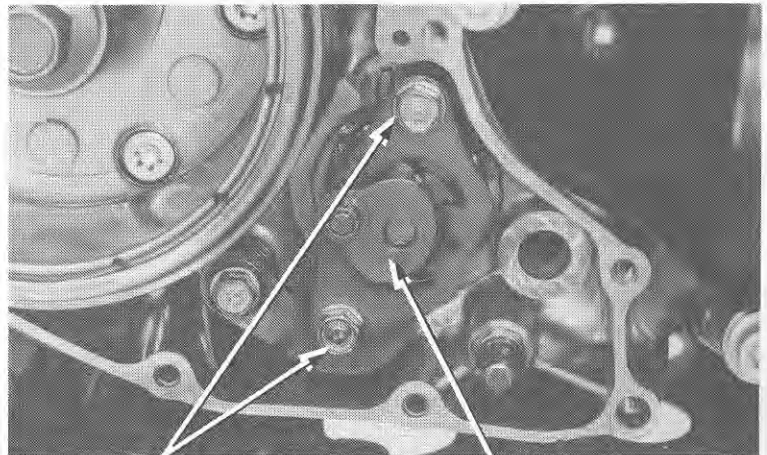

GUIDE PLATE BOLTS.

DRUM SHIFTER

Remove the stopper arm and shift drum center.

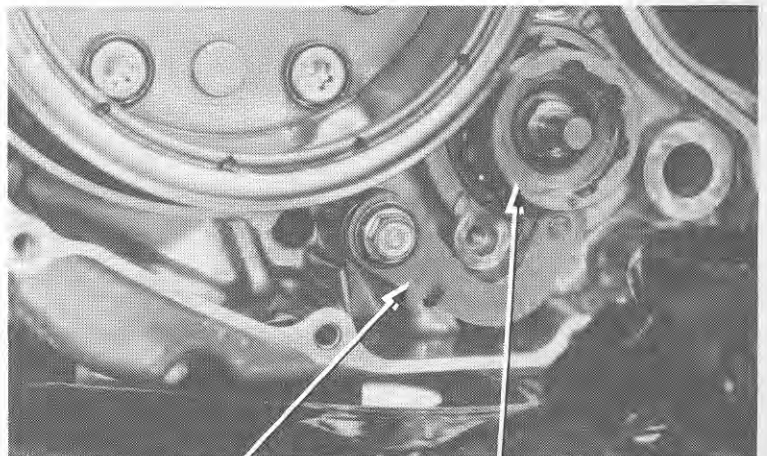

STOPPER ARM

SHIFT DRUM CENTER

INSTALLATION

Apply clean engine oil to the ratchet pawls, springs and drum shifter.

Assemble ratchet pawls, springs and plungers onto the drum shifter, then install them in the guide plate.

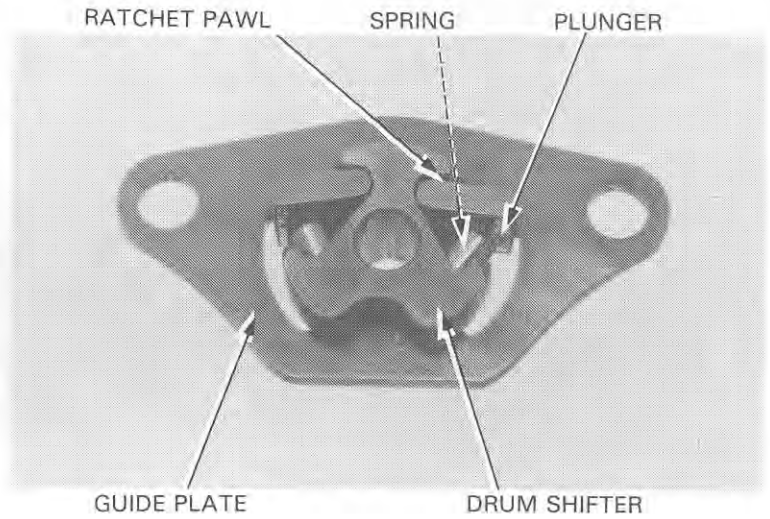

Install the stopper arm and spring.

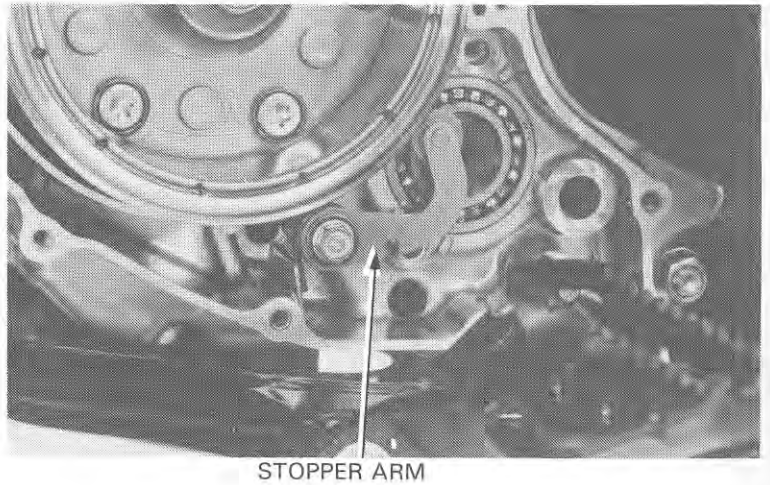

Align the drum center hole with the dowel pin on the shift drum and install the drum center.

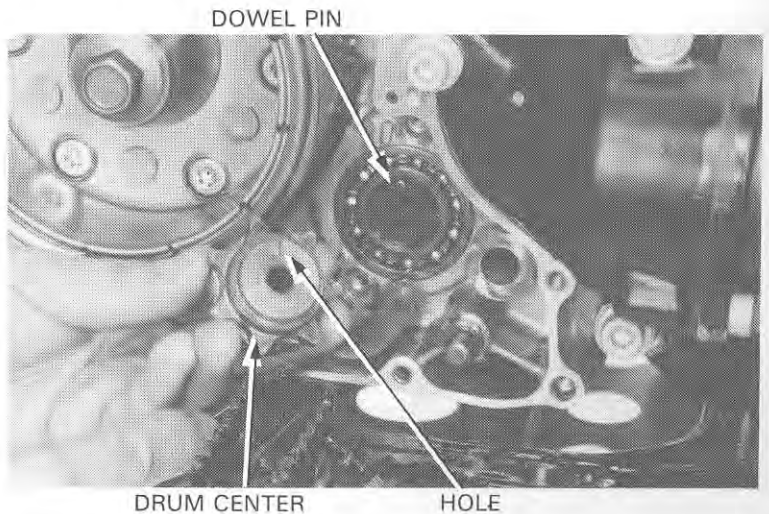

ALTERNATOR/STARTER CLUTCH/ GEARSHIFT LINKAGE

Tighten the drum center pin.
Install the bearing stopper plates, dowel pins and collars onto the crankcase.

Compress the drum shifter ratchet pawls and install into the guide plate.

Install the guide plate and drum shifter assembly.

Assemble the gearshift spindle, gearshift arm and shift return spring.

Install the shift collar onto the drum shifter pin.

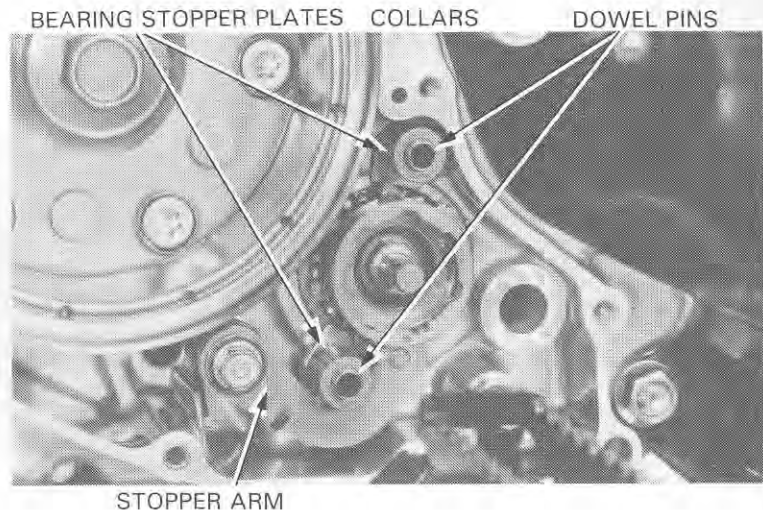

Align the end of the return spring with the shift return spring pin, and the hole of the gearshift spindle with the shift collar and install the gearshift spindle.

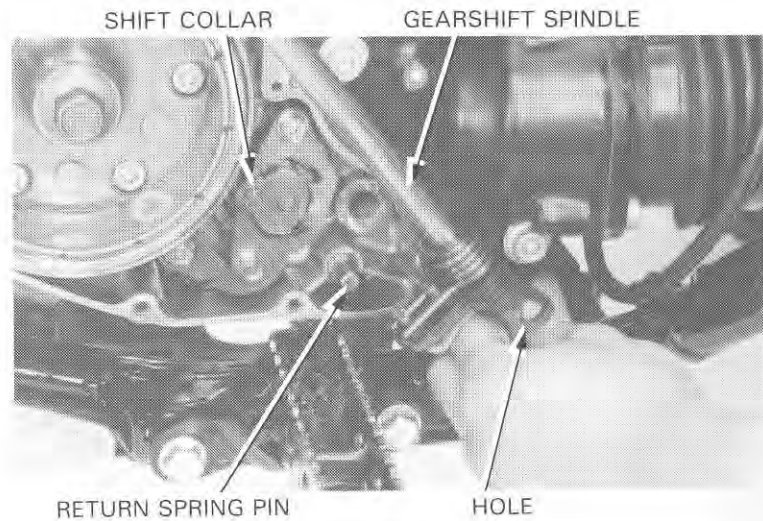

Install the following:

- left crankcase cover (page 9-13).
- gearshift pedal on the spindle while aligning the punch marks.
- clutch lever aligning the punch mark with the index mark.
- right crankcase cover (page 8-27).

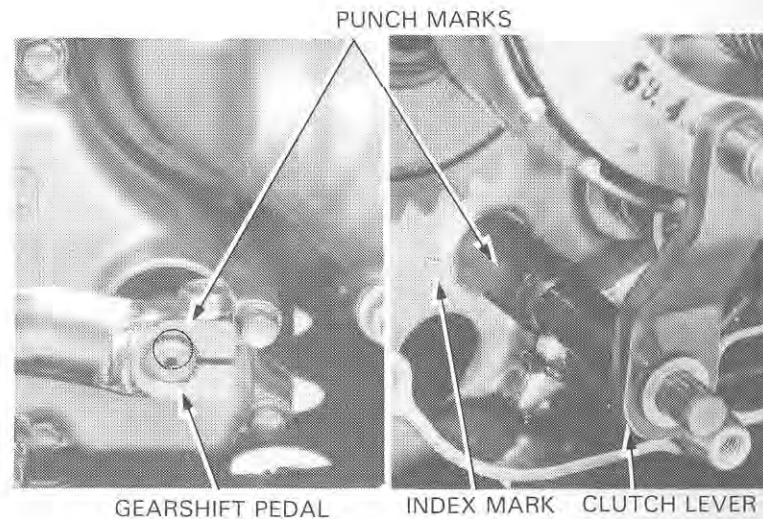

LEFT CRANKCASE COVER INSTALLATION

Install a new gasket, the dowel pins, left crankcase cover and bolts.

'85, '86 MODEL SHOWN

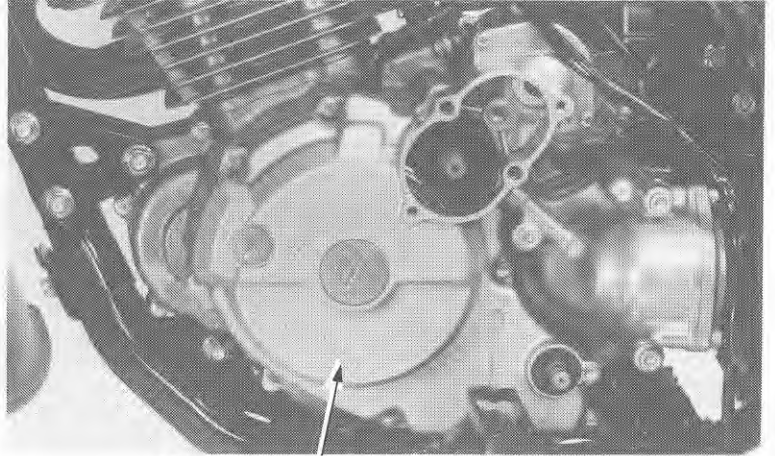

LEFT CRANKCASE COVER

Install the starter reduction gears and cover (page 9-4).

Connect the alternator/pulse generator couplers.

Install the left frame side cover.

Align the punch marks on the gearshift pedal and gearshift spindle and install.

Check the operation of the gearshift mechanism.

Install the left foot peg assembly.

Fill the engine with oil.

Check the oil leaks.

TORQUE VALUES:

Gearshift pedal bolt

10–14 N·m (1.0–1.4 kg-m, 7–10 ft-lb)

After '85: 14–18 N·m (1.4–1.8 kg-m,
10–13 ft-lb)

Foot peg bolt

40–50 N·m (4.0–5.0 kg-m, 29–36 ft-lb)

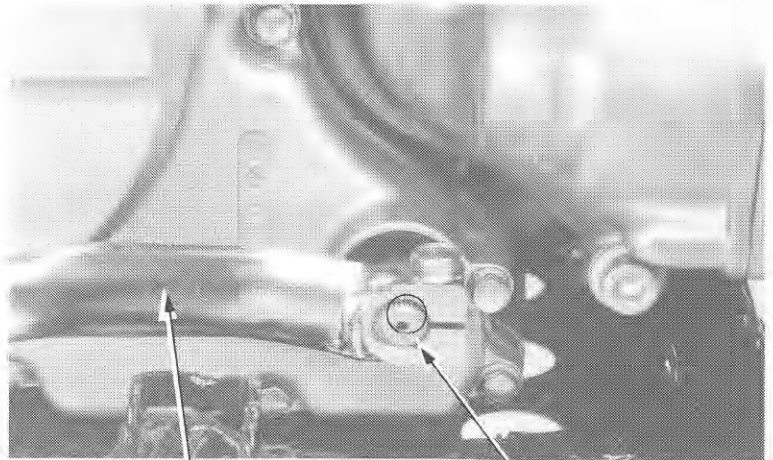

GEARSHIFT PEDAL

PUNCH MARKS

**CRANKCASE/CRANKSHAFT/
TRANSMISSION**

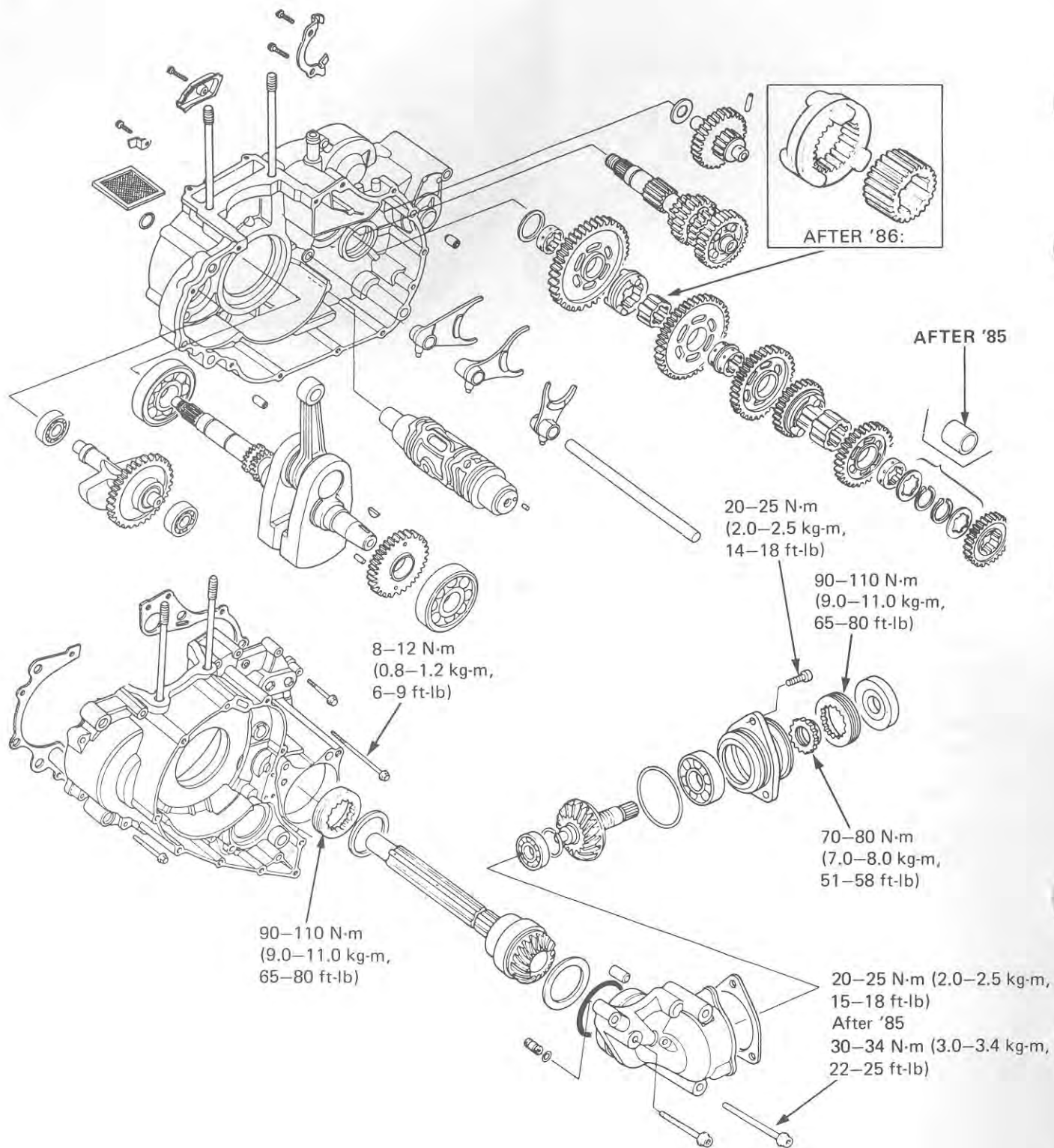

10. CRANKCASE/CRANKSHAFT/ TRANSMISSION

SERVICE INFORMATION	10-1	TRANSMISSION	10-9
TROUBLESHOOTING	10-3	OUTPUT GEAR	10-17
CRANKCASE SEPARATION	10-4	CRANKCASE ASSEMBLY	10-27
CRANKSHAFT	10-5		

SERVICE INFORMATION

GENERAL

- Remove the following parts before separating the crankcase.
 - Cylinder head (section 6)
 - Clutch, oil pump and kick starter (section 8)
 - Alternator and gearshift linkage (section 9)
 - Cylinder and piston (section 7).
 - Starter system (section 16).
- For crankshaft and transmission repair, the crankcase must be separated.
- Use soft jaws to prevent damage to the output gear case when placing the case in a vise.
- When replacing the following output gear components, a new adjustment shim must be selected.
 - Output gear case.
 - Output gear assembly.
 - Output gear bearing.
 - Output gear bearing holder.
- Replace the output drive and driven gear as a set.
- When using the lock nut wrench, use a deflecting beam type torque wrench 14-20 inches long. The lock nut wrench increases the torque wrench's leverage, so the torque wrench reading will be less than the torque actually applied to the lock nut. The specification given is the actual torque applied to the lock nut, not the reading on the torque wrench when used with the lock nut wrench. The torque scale reading is given with the actual torque specifications.

SPECIFICATIONS

ITEM		STANDARD	SERVICE LIMIT	
Crankshaft	Connecting rod small end I.D.	19.020–19.041 mm (0.7488–0.7496 in)	19.07 mm (0.751 in)	
	Connecting rod big end axial clearance	0.05 – 0.65 mm (0.0020–0.0256 in)	0.80 mm (0.031 in)	
	Connecting rod big end radial clearance	0.006– 0.018 mm (0.0002–0.0007 in)	0.05 mm (0.002 in)	
	Runout	—————	0.05 mm (0.002 in)	
Shift fork, shaft	Fork	I.D.	13.000–13.021 mm (0.5118–0.5126 in)	13.04 mm (0.513 in)
		Claw thickness	4.93 – 5.00 mm (0.1941–0.1969 in)	4.50 mm (0.177 in)
	Shaft O.D.	12.966–12.984 mm (0.5105–0.5112 in)	12.96 mm (0.510 in)	
Trans- mission	Gear I.D.	M4	25.000–25.021 mm (0.9843–0.9851 in)	25.05 mm (0.986 in)
		M5	20.020–20.041 mm (0.7882–0.7890 in)	20.07 mm (0.790 in)
		C1, C2, C3, CR	28.020–28.041 mm (1.1031–1.1040 in)	28.07 mm (1.105 in)
		R idler	18.000–18.021 mm (0.7087–0.7095 in)	18.05 mm (0.711 in)
	Shaft O.D.	M4	21.959–21.980 mm (0.8645–0.8654 in)	21.93 mm (0.863 in)
		M5	16.983–16.994 mm (0.6686–0.6691 in)	16.95 mm (0.667 in)
		R idler	13.966–13.984 mm (0.5498–0.5506 in)	13.93 mm (0.548 in)

CRANKCASE/CRANKSHAFT/ TRANSMISSION

ITEM		STANDARD	SERVICE LIMIT	
Trans- mission	Gear bushing	C1 O.D.	27.984–28.005 mm (1.1017–1.1026 in)	27.93 mm (1.100 in)
		C2 CR O.D.	27.979–28.000 mm (1.1015–1.1024 in)	27.93 mm (1.100 in)
		C3 O.D.	27.959–27.980 mm (1.1017–1.1026 in)	27.93 mm (1.100 in)
		M4 O.D.	24.959–24.980 mm (0.9826–0.9835 in)	24.93 mm (0.981 in)
		M4 I.D.	22.000–22.021 mm (0.8661–0.8670 in)	22.05 mm (0.868 in)
		M5 O.D.	19.959–19.980 mm (0.7858–0.7866 in)	19.93 mm (0.785 in)
		M5 I.D.	17.016–17.034 mm (0.6699–0.6706 in)	17.06 mm (0.672 in)
		R O.D.	17.966–17.984 mm (0.7073–0.7080 in)	17.93 mm (0.706 in)
		R I.D.	14.000–14.025 mm (0.5512–0.5522 in)	14.05 mm (0.553 in)
	Gear-to- bushing clearance	M4	0.020– 0.062 mm (0.0008–0.0024 in)	0.10 mm (0.004 in)
		M5	0.040– 0.082 mm (0.0016–0.0032 in)	0.10 mm (0.004 in)
		C1	0.015– 0.057 mm (0.0006–0.0022 in)	0.10 mm (0.004 in)
		C2, CR	0.020– 0.062 mm (0.0008–0.0024 in)	0.10 mm (0.004 in)
		C3	0.040– 0.082 mm (0.0016–0.0032 in)	0.10 mm (0.004 in)
	Bushing-to- shaft clearance	M4	0.020– 0.062 mm (0.0008–0.0024 in)	0.10 mm (0.004 in)
		M5	0.022– 0.051 mm (0.0009–0.0020 in)	0.10 mm (0.004 in)
		R	0.016–0.059 mm (0.0006–0.0023 in)	0.10 mm (0.004 in)
	Output gear backlash		0.080– 0.180 mm (0.0031–0.0071 in)	0.25 mm (0.010 in)

TORQUE VALUES

Crankcase SH bolt	8–12 N·m (0.8–1.2 kg-m, 6–9 ft-lb)
Output gear case bolt '85	20–25 N·m (2.0–2.5 kg-m, 15–18 ft-lb)
After '85	30–34 N·m (3.0–3.4 kg-m, 22–25 ft-lb)
Output gear bearing lock nut (Outer)	90–110 N·m (9.0–11.0 kg-m, 65–80 ft-lb)
(Inner)	70–80 N·m (7.0–8.0 kg-m, 51–58 ft-lb)
Output gear bearing holder socket bolt	20–25 N·m (2.0–2.5 kg-m, 14–18 ft-lb)
Output gear bearing lock nut	90–110 N·m (9.0–11.0 kg-m, 65–80 ft-lb)