

Slot diffusers

Slot diffusers LD-13, LD-14

Application

LD-13 and LD-14 slot diffusers are designed for the supply of air in rooms with floor to ceiling heights of 2.5 to 4 m for supplying either cold or warm air, in particular in applications where air conditioning comfort demands are stringent. Due to their high induction rate and rapid decrease of temperature difference, these diffusers are also suitable for variable systems.



Description

LD-13 and LD-14 slot diffusers are designed in 1, 2, 3 and 4-slot versions. Diffuser face plate consists of anodised aluminium sections with built-in cylindrical deflectors made of plastics. Deflectors allow continuous adjustment of discharged air direction within the 360° range as well as control of supply air flow rate. The cylindrical deflectors also allow full shutting of the diffuser. The slot diffuser plenum box is made of galvanised sheet steel and has a flow rate control damper built in its inlet spigot, to allow fine adjustment of the desired air flow rate.

Control schematic of the spigot volume control damper

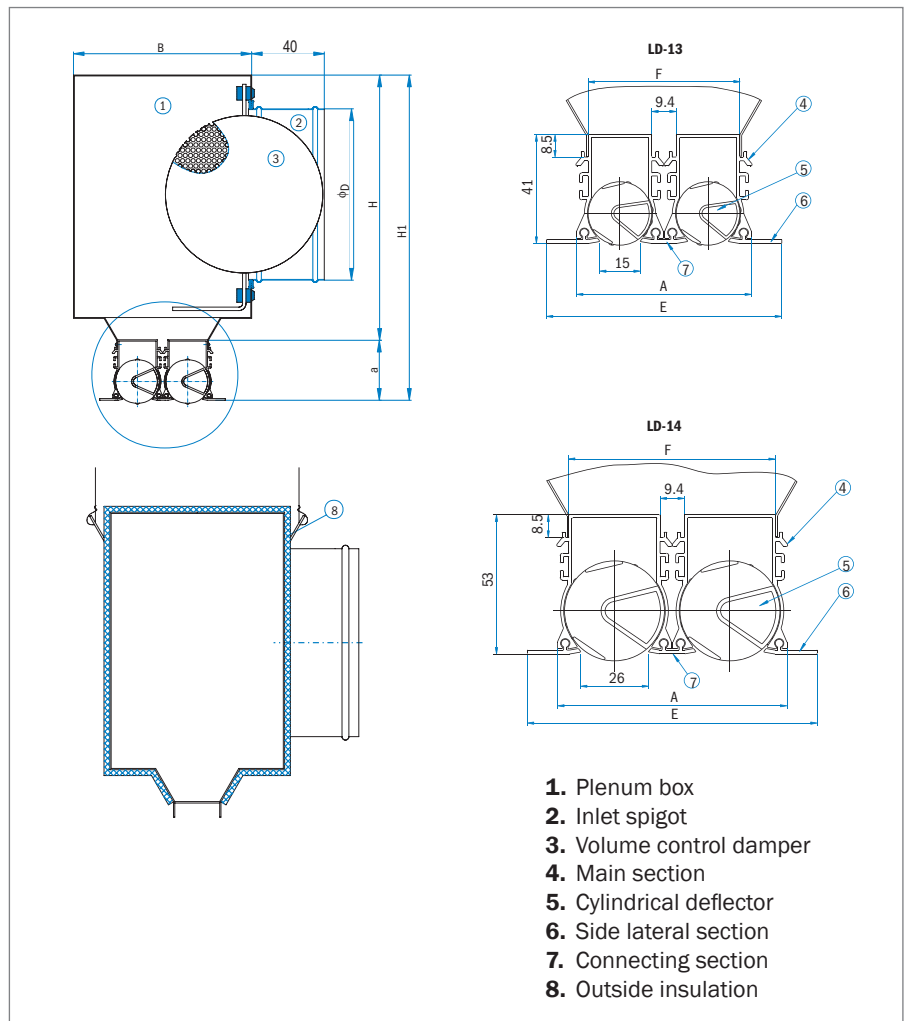
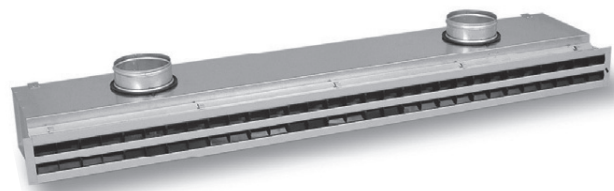
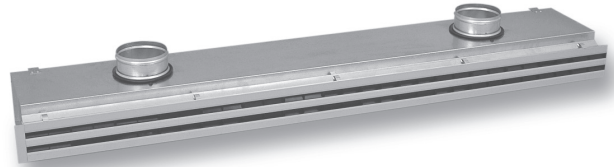
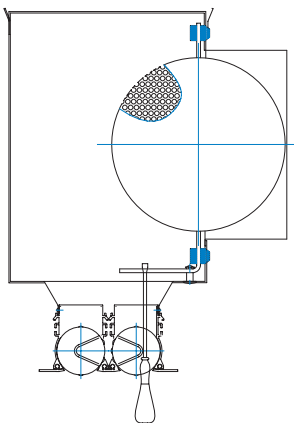

Slot diffuser types

- Single-slot (designation LD-13,14/1)
- Two slots (designation LD-13,14/2)
- Three-slots (designation LD-13,14/3)
- Four-slots (designation LD-13,14/4)

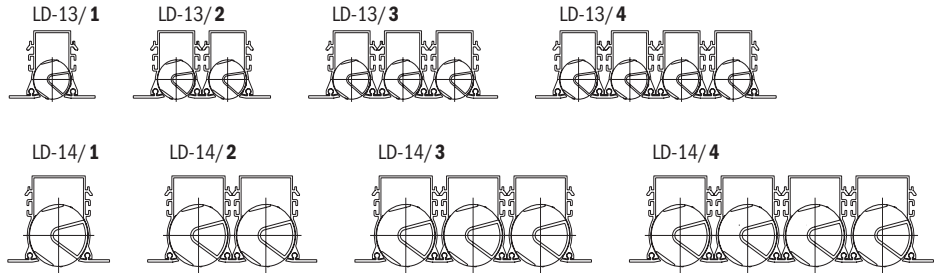

**Slot diffusers
LD-13 O, LD-14 O**

Narrow version

The narrow slot diffuser differs from the conventional slot diffuser construction as regards its mounting to the ceiling or wall. The conventional slot diffuser has a L-cross-section mounting sleeve which remains visible and may, in certain applications, interfere with aesthetic requirements. The narrow design has eliminated this deficiency as well as introduced improved structural rigidity due to its reinforced sleeve. The product is thus suitable for installation in cooling suspended ceilings as well.

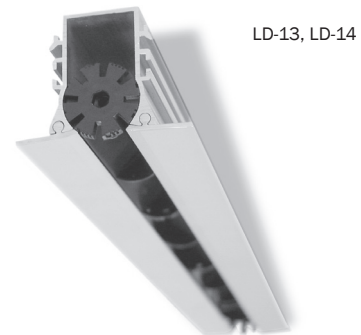
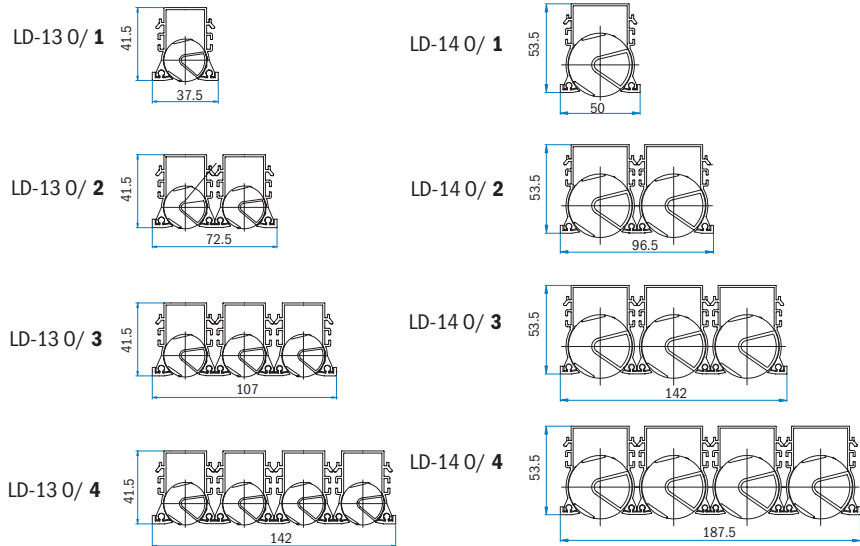

Standard lengths L

LD-13 and LD-14 slot diffusers are available in standard lengths ranging from L=300 to L=2000 mm, with a 100 mm step. In cases where longer diffusers are required, they can be joint together by means of (rail-type) connecting plates. Plenum boxes are also available in standard lengths ranging from 300 mm to 2000 mm.

Special orders

On customer's request slot diffusers can be made in other dimensions. End seals and longitudinal sections are painted in any RAL scale colour according to the customer's request. As standard, cylindrical deflectors are black or white, on the customer's request, they can be coloured in any RAL scale colour. Non-standard colours and extra components are to be ordered separately.

LD-13

No. of slots	H	H1	B	A	E	F
1	220	261	95	33	57.5	24.4
2	230	271	129	67	92	58.2
3	250	291	162	101	126.5	92.0
4	290	331	196	135	161.5	125.8

LD-14

No. of slots	H	H1	B	A	E	F
1	233.5	287	106	44	69	35.3
2	253.5	307	150	89	115	80
3	293.5	347	195	133	161.5	124.7
4	318.5	372	240	178	206.5	169.4

VENTILATING GRILLES,
VENTILATING VALVES

CIRCULAR DIFFUSERS,
SQUARE DIFFUSERS

SWIRL DIFFUSERS,
VARIABLE SWIRL
DIFFUSERS

SLOT DIFFUSERS,
ROUND DUCT DIFFUSERS

AIR DISPLACEMENT
UNITS

SUPPLY AIR NOZZLES

EXTERNAL ELEMENTS

AIR FLOW
CONTROL UNITS

SOUND ATTENUATORS,
SOUND ATTENUATING
LOUVERES

Number and diameter of inlet spigots

L	300 do 1000		1100 do 1500		1600 do 2000	
	Number and diameter of inlet spigots					
No. of slots	LD-13	LD-14	LD-13	LD-14	LD-13	LD-14
1	1 x 98	1 x 123	2 x 98	2 x 123	2 x 123	2 x 138
2	1 x 138	1 x 158	2 x 123	2 x 138	2 x 138	2 x 158
3	1 x 158	1 x 198	2 x 138	2 x 158	2 x 158	2 x 198
4	1 x 198	1 x 223	2 x 158	2 x 198	2 x 198	2 x 223

Position of inlet spigots

Number of inlet spigots	Standard length	Position of spigots
1	300 - 1000	L/2
2	1100 - 1500	J = 300
2	1600 - 2000	J = 400

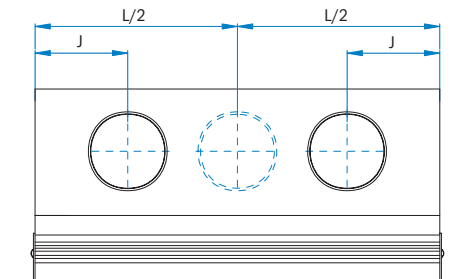

Slot diffuser face plate designs

Slot diffuser face plates are made of linear or angular ended sections, which allow the diffusers to be joined at different angles. Angular ended sections are not fitted with air direction controls.

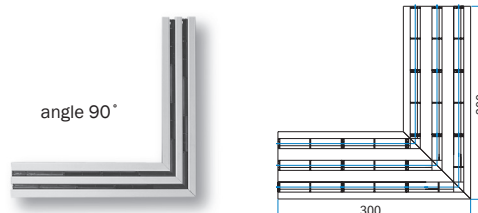

Cylindrical deflectors

Cylindrical deflectors are an important components of a slot diffuser. They allow adjustment of both air flow rate and direction. Cylindrical deflectors are made of plastics. As standard, they are black or white.



End seals

End seals are components of the diffuser face plate. They are available in two designs:

- as an angle piece (**E** – on both ends, **ET** – on one end only) or
- plates (**F** – on both ends, **FT** – on one end only).

The connecting strip-section has no end angle pieces or plates seals (designation T).

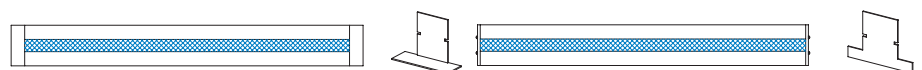

Joining diffusers together in length and width

Joining in width (into diffusers with multiple slots) requires special strip sections, while joining in length requires connecting plates (the total length of combined diffusers is not limited).

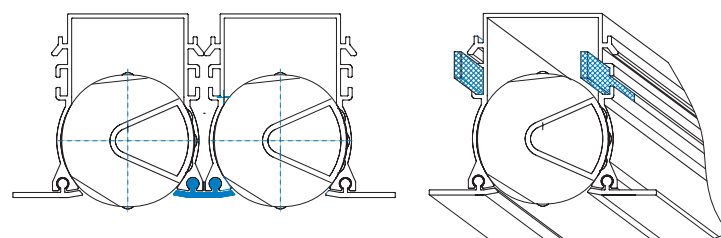

Fixing of the plenum box onto LD-13, LD-14 diffusers

- With self-tapping screws (designation **U**)
- With spring clamps (designation **S**)
- With a cross-member (designation **Z**)

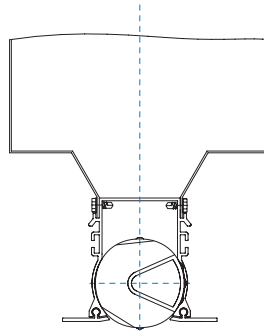

Fixing with self-tapping screws (U)

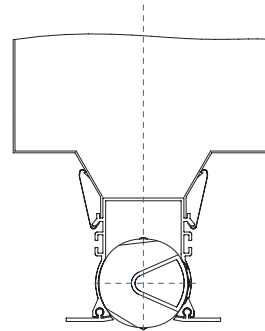

Fixing with spring clamps (S)

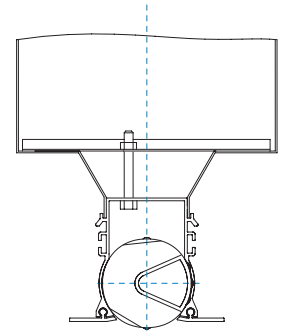

Fixing with a cross-member (Z)

Installation methods

- With a threaded bar (designation **R**)
- With a wire (designation **R**)
- With suspension brackets on the plenum box (designation **P**)
- With special fixing elements (designation **R**)
- With springs (designation **N**)

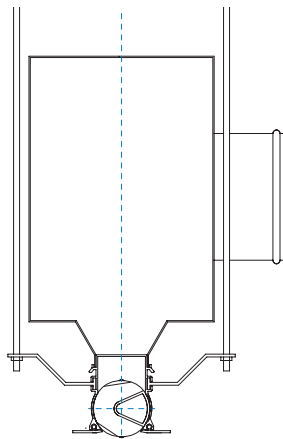

Installation with a threaded bar (R)

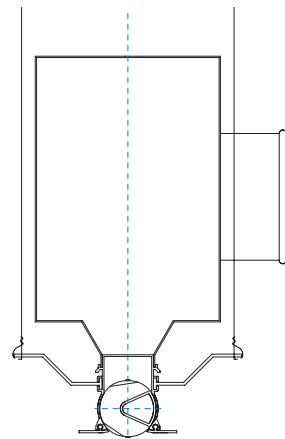

Installation with wire (R)

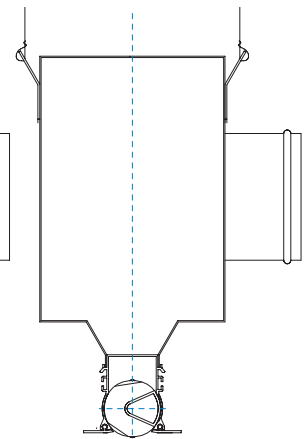

Installation with suspension bracket (P)

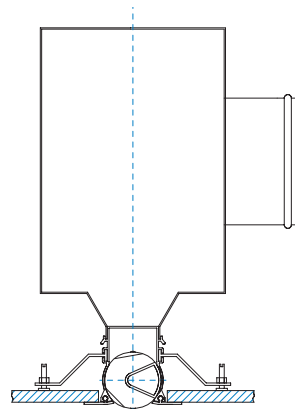

Installation with special fastening elements (R)

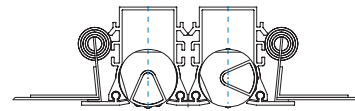

Installation with springs into ducts (N)

Types of air discharge

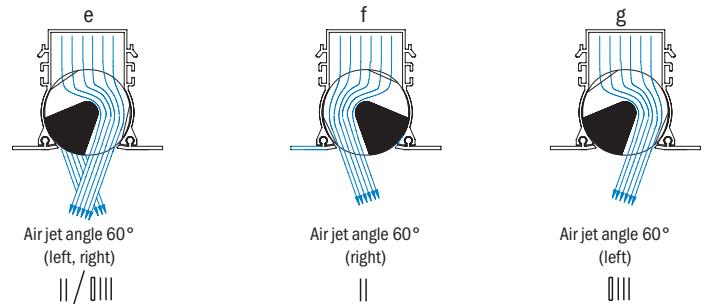
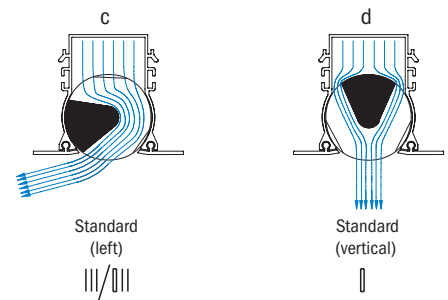
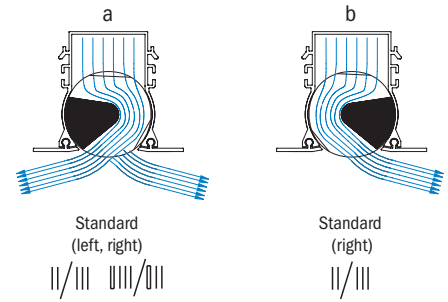
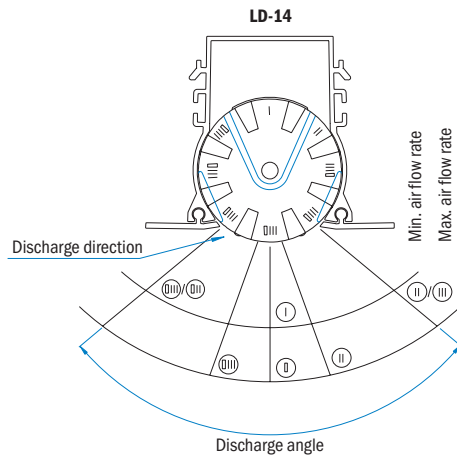
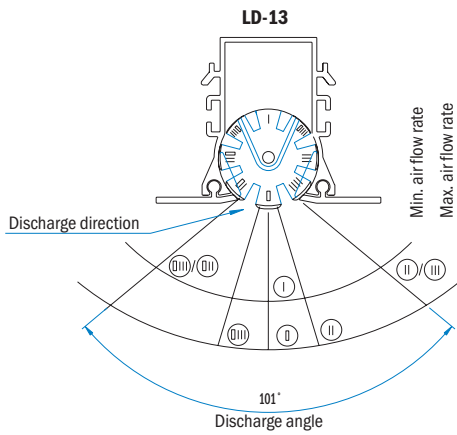

Slot diffuser with actuator controlled discharge direction

Slot diffusers with actuator controlled discharge direction are suitable for summer-winter air supply applications. The desired direction of air jet is achieved by means of an electric actuator which moves a slider. Manual adjustment is therefore not necessary. Compared with standard slot diffusers, air flow rate is reduced by 50 %. There are two options for the Belimo electric motors:

LH 24A-SR100 and LH-24A-MP100. The first operates at 24V AC/DC, the second within the range of 0-10V or 0-32V. Their travel distance is 100 mm, for which 150 s is required.

Component parts

1. Slot diffuser
2. Deflector
3. Electric actuator

In case the discharge angle is to be adjustable by means of an electric actuator (winter-summer application), this requirement shall be specified in the ordering form.

* Motor version on customer's request.

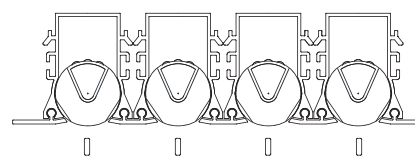
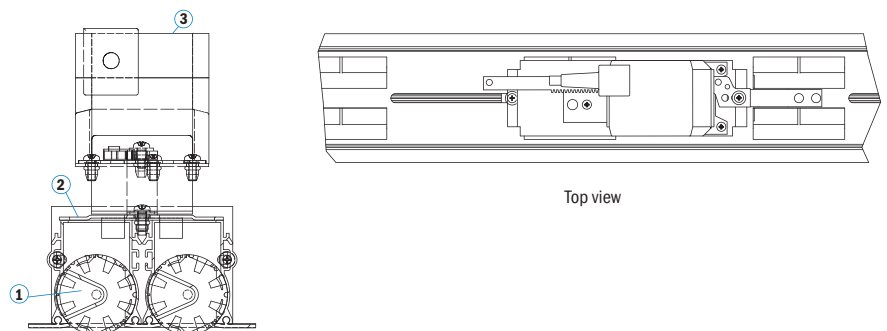

Every second row
1. Adjustment of deflectors for warm air supply

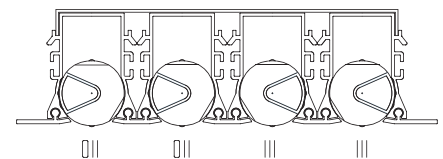

Every second row
2. Adjustment of deflectors for cold air supply

Ordering key

LD-13/1/B/E/K/M/S/P/I/g L=1700

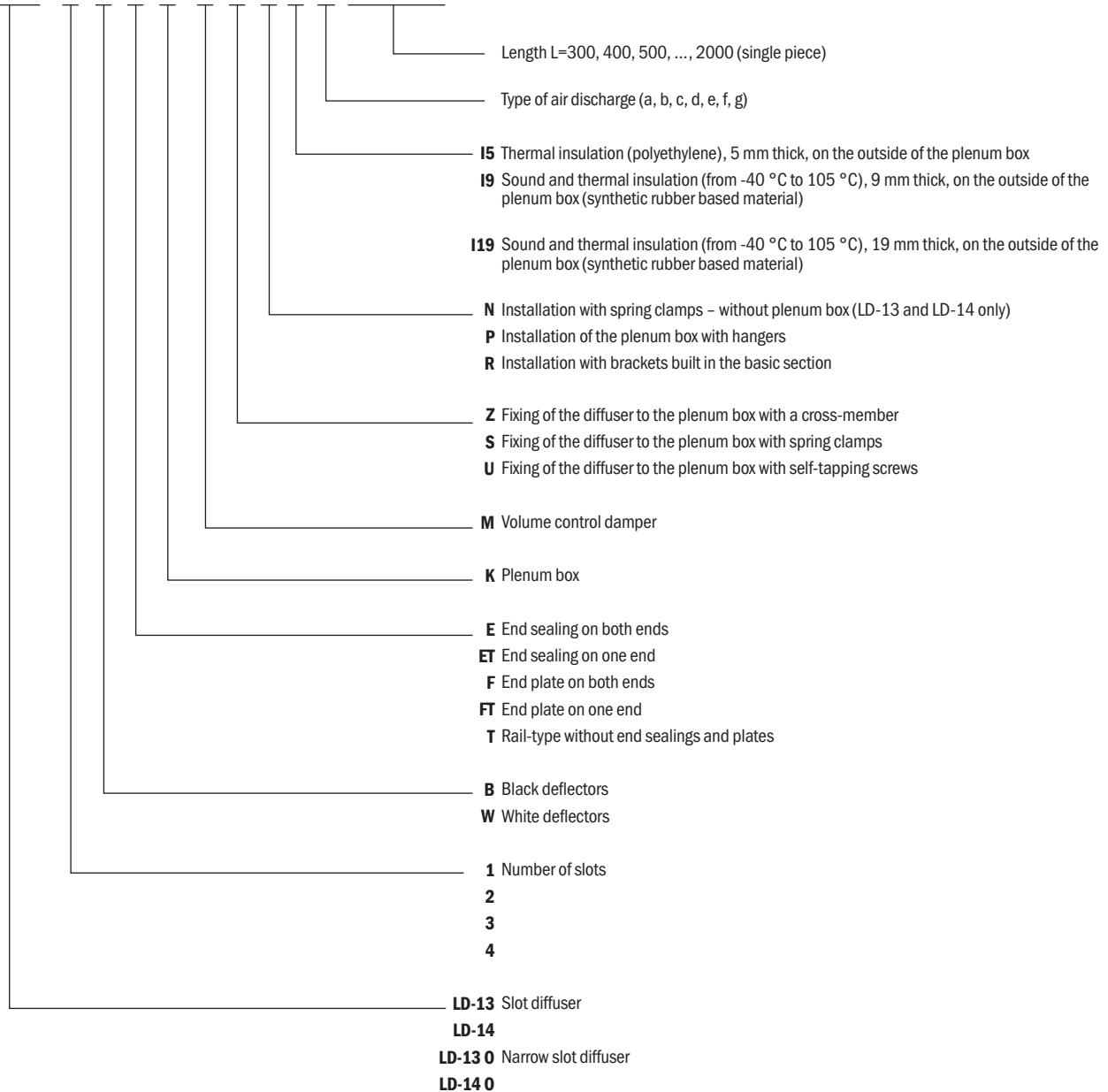

Note:

- Please specify the deflector colour in your order.
- Standard eloxal colour of the aluminium section is the original aluminium colour. Other colours shall be specified in the order.
- For the LD-13 0 and LD-14 0 type, the following end seals are available: F, FT and T.
- When installing in cooling ceilings, consult the manufacturer.
- In the case the slot diffuser is ordered complete with plenum box, the air jet configuration is set as shown on the drawing on page 184.
- Versions with insulation on the inside of the plenum box are also available.

Fast selection diagram:
 $L_{WA} < 35 \text{ dB(A)}$

Technical specifications for one-slot diffuser, per meter of length, at horizontal discharge

	A(m ²)	Q(m ³ /h)	L _{WA} (dB)
LD-13	0.0092	135	34
LD-14	0.0136	210	28

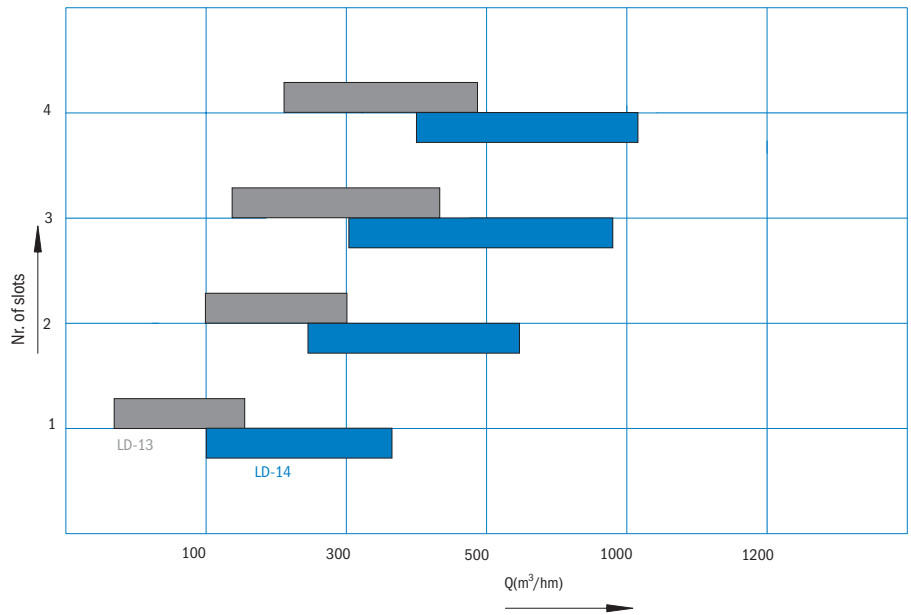

Definition of symbols

- Q (m³/hm)** Air flow rate to length
- x (m)** Horizontal distance to the wall
- H (m)** Room height
- L (m)** Throw distance (L=H1+x)
- VL (m/s)** Air velocity at the throw distance L
- Δt_s (K)** Temperature difference between the supply and room air
- Δt_c (K)** Difference between the core and room air temperature
- Δp (Pa)** Pressure drop
- L_{WA} (dB(A))** Sound power level
- v_{H1} (m/s)** Air velocity at the distance H1
- A, B (m)** Distance between diffusers, in length and in width
- H1 (m)** Throw distance

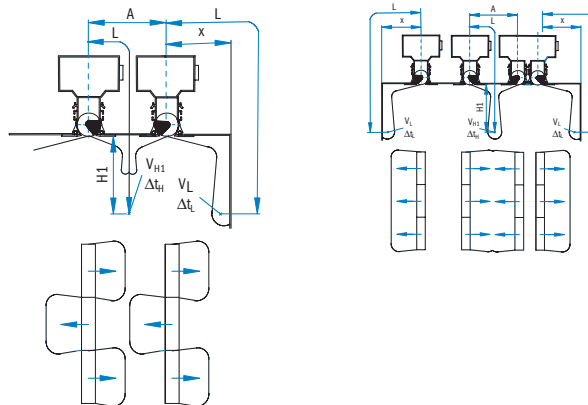

Air velocity diagrams for LD-13, at different throw distances

One or two sided horizontal discharge

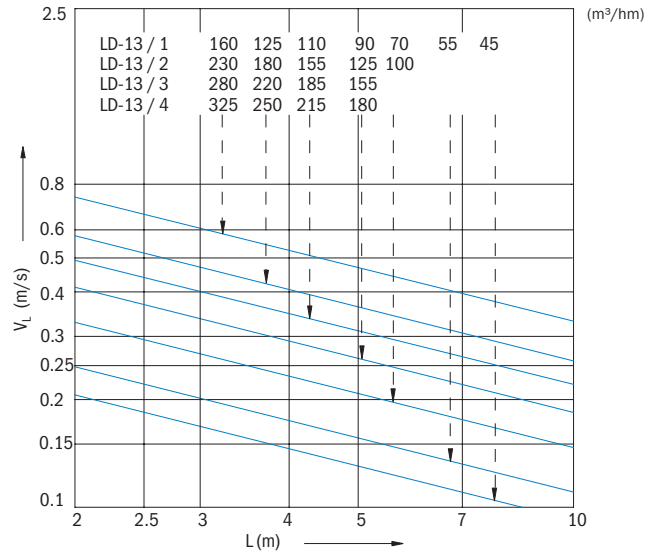
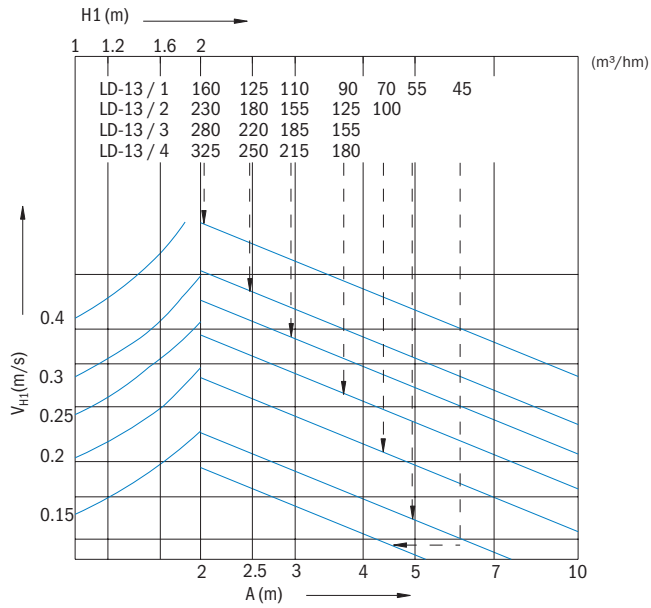

Alternate sided horizontal discharge

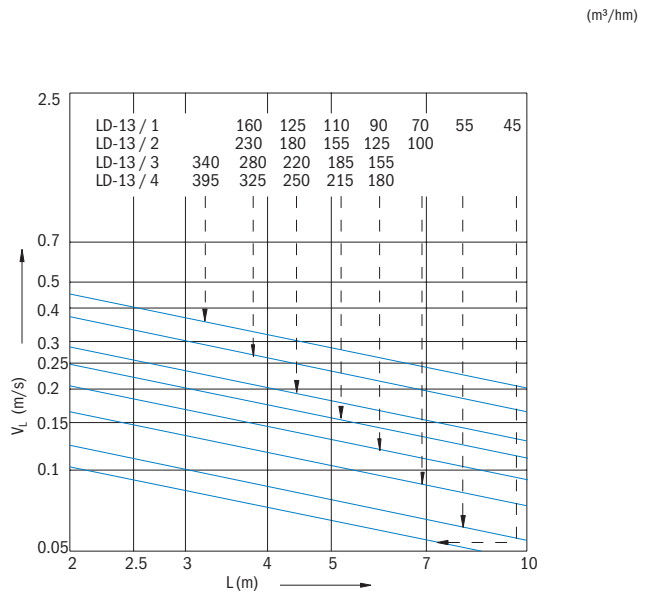
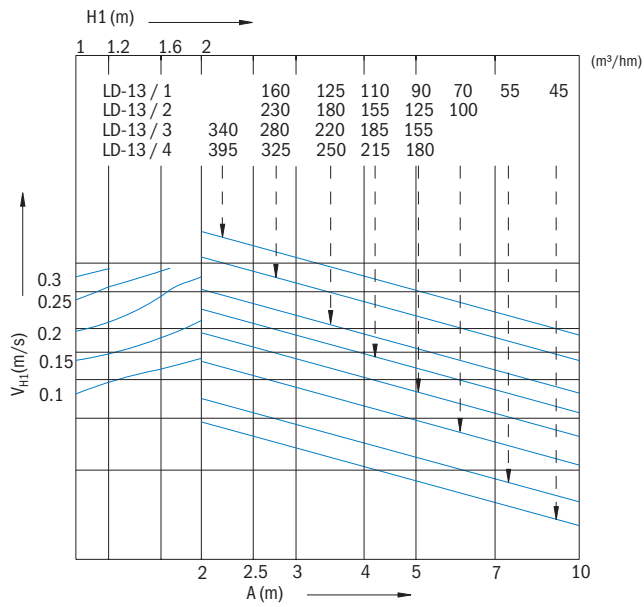

VENTILATING GRILLES,
VENTILATING VALVES

CIRCULAR DIFFUSERS,
SQUARE DIFFUSERS

SWIRL DIFFUSERS,
VARIABLE SWIRL
DIFFUSERS

SLOT DIFFUSERS,
ROUND DUCT DIFFUSERS

AIR DISPLACEMENT
UNITS

SUPPLY AIR NOZZLES

EXTERNAL ELEMENTS

AIR FLOW
CONTROL UNITS

SOUND ATTENUATORS,
SOUND ATTENUATING
LOUVRES

Air velocity diagrams for LD-14, at different throw distances

One or two sided horizontal discharge

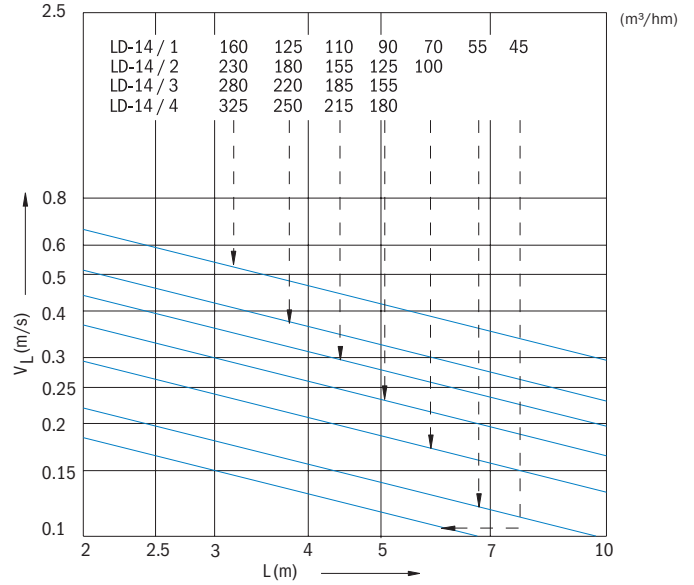
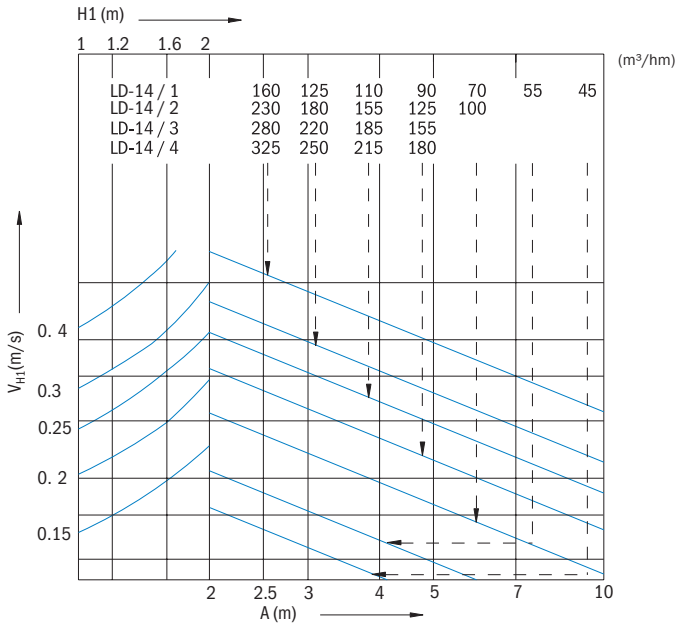

Alternate sided horizontal discharge

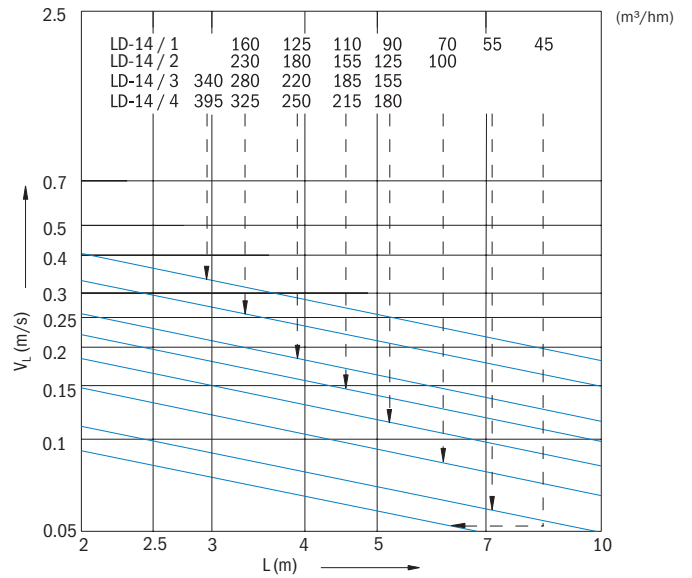
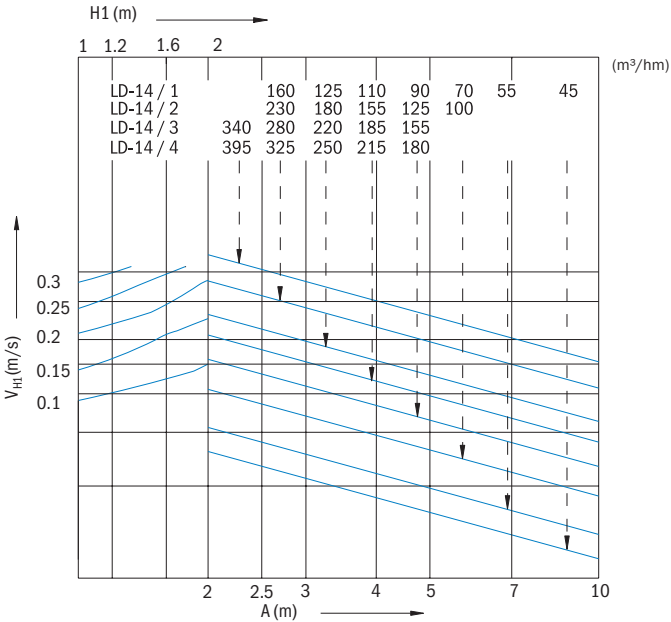

Sound power level and pressure drop

LD 13/1

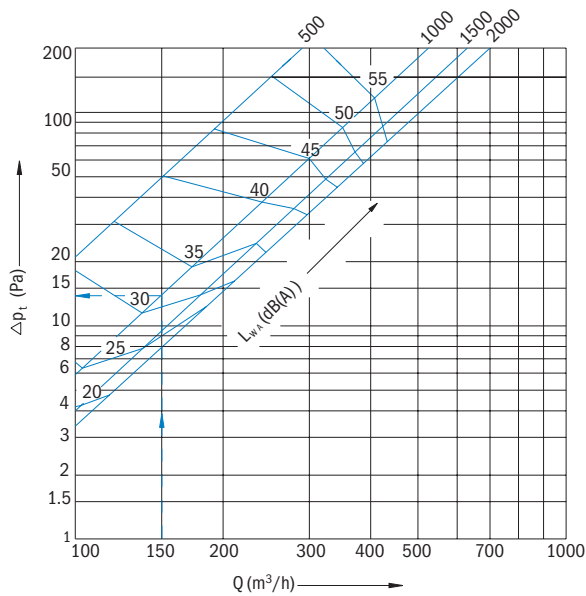

LD 13/2

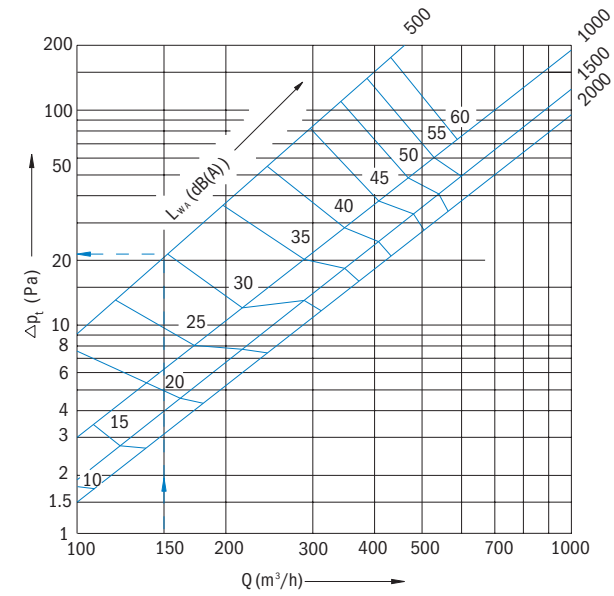

Correction factors applicable to LD-13/1

Type of discharge	Vertical		Horizontal	
	Open	Closed	Open	Closed
Flow rate control damper				
L=500	x 1	x 1.44	x 0.87	x 1.34
L=1000	x 1	x 3.30	x 0.85	x 3.02
L=1500	x 1	x 5.26	x 0.84	x 4.47
L=2000	x 1	x 7.37	x 0.81	x 5.68

Correction factors applicable to LD-13/2

Type of discharge	Vertical		Horizontal	
	Open	Closed	Open	Closed
Flow rate control damper				
L=500	x 1	x 1.91	x 0.86	x 1.79
L=1000	x 1	x 5.91	x 0.70	x 5.31
L=1500	x 1	x 9.88	x 0.58	x 8.67
L=2000	x 1	x 14.10	x 0.47	x 11.99

Example

Q = 150 m³/h
 L = 1000 mm
 Δp_t = 14 Pa (vertical; damper opened)
 Δp_t = 14 x 3.30 = 46.2 Pa (vertical; damper closed)
 Δp_t = 14 x 0.85 = 11.9 Pa (horizontal; damper opened)
 Δp_t = 14 x 3.02 = 42.3 Pa (horizontal; damper closed)
 L_{WA} = 32 dB(A)

Example

Q = 150 m³/h
 L = 500 mm
 Δp_t = 22 Pa (vertical; damper opened)
 Δp_t = 22 x 1.91 = 42.0 Pa (vertical; damper closed)
 Δp_t = 22 x 0.86 = 18.9 Pa (horizontal; damper opened)
 Δp_t = 22 x 1.79 = 39.4 Pa (horizontal; damper closed)
 L_{WA} = 30 dB(A)

VENTILATING GRILLES,
VENTILATING VALVES
 CIRCULAR DIFFUSERS,
SQUARE DIFFUSERS
 SWIRL DIFFUSERS,
VARIABLE SWIRL
DIFFUSERS
 SLOT DIFFUSERS,
ROUND DUCT DIFFUSERS
 AIR DISPLACEMENT
UNITS
 SUPPLY AIR NOZZLES
 EXTERNAL ELEMENTS
 AIR FLOW
CONTROL UNITS
 SOUND ATTENUATORS,
SOUND ATTENUATING
LOUVRES

Sound power level and pressure drop

LD 13/3

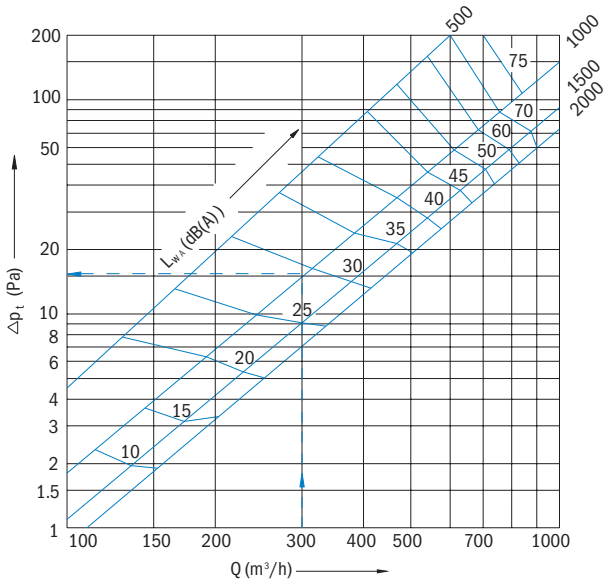

LD 13/4

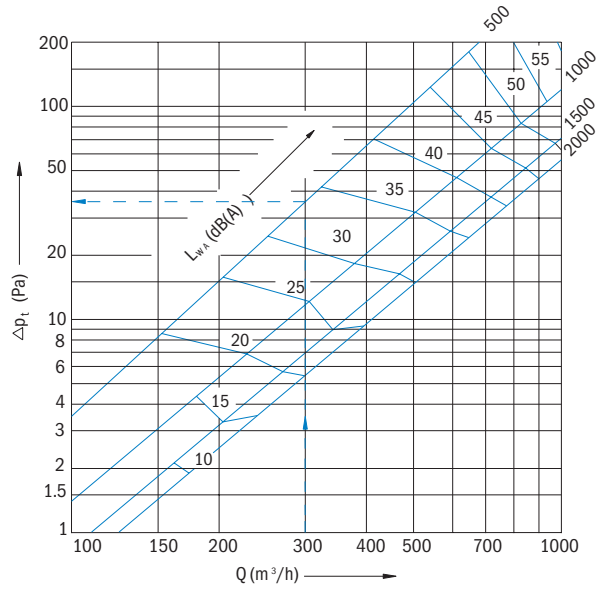

Correction factors applicable to LD-13/3

Type of discharge	Vertical		Horizontal	
	Open	Closed	Open	Closed
Flow rate control damper				
L=500	x 1	x 2.37	x 0.84	x 2.24
L=1000	x 1	x 8.52	x 0.56	x 7.59
L=1500	x 1	x 14.50	x 0.32	x 12.86
L=2000	x 1	x 20.82	x 0.18	x 18.29

Correction factors applicable to LD-13/4

Type of discharge	Vertical		Horizontal	
	Open	Closed	Open	Closed
Flow rate control damper				
L=500	x 1	x 3.08	x 0.70	x 2.91
L=1000	x 1	x 11.07	x 0.47	x 9.87
L=1500	x 1	x 18.85	x 0.27	x 16.72
L=2000	x 1	x 27.07	x 0.15	x 23.78

Example

$Q = 300 \text{ m}^3/\text{h}$
 $L = 1000 \text{ mm}$
 $\Delta p_t = 15 \text{ Pa}$ (vertical; damper opened)
 $\Delta p_t = 15 \times 8.52 = 127.8 \text{ Pa}$ (vertical; damper closed)
 $\Delta p_t = 15 \times 0.56 = 8.4 \text{ Pa}$ (horizontal; damper opened)
 $\Delta p_t = 15 \times 7.59 = 113.8 \text{ Pa}$ (horizontal; damper closed)
 $L_{WA} = 29 \text{ dB(A)}$

Example

$Q = 300 \text{ m}^3/\text{h}$
 $L = 500 \text{ mm}$
 $\Delta p_t = 35 \text{ Pa}$ (vertical; damper opened)
 $\Delta p_t = 35 \times 3.08 = 107.8 \text{ Pa}$ (vertical; damper closed)
 $\Delta p_t = 35 \times 0.70 = 24.5 \text{ Pa}$ (horizontal; damper opened)
 $\Delta p_t = 35 \times 2.91 = 101.8 \text{ Pa}$ (horizontal; damper closed)
 $L_{WA} = 33 \text{ dB(A)}$

Sound power level and pressure drop

LD 14/1

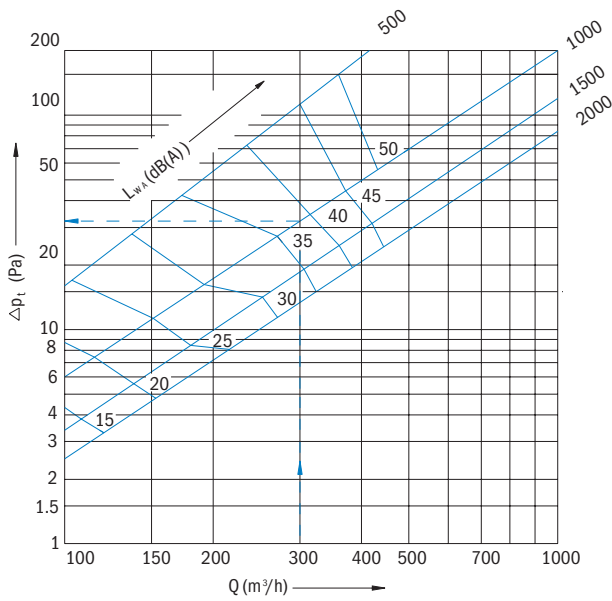

LD 14/2

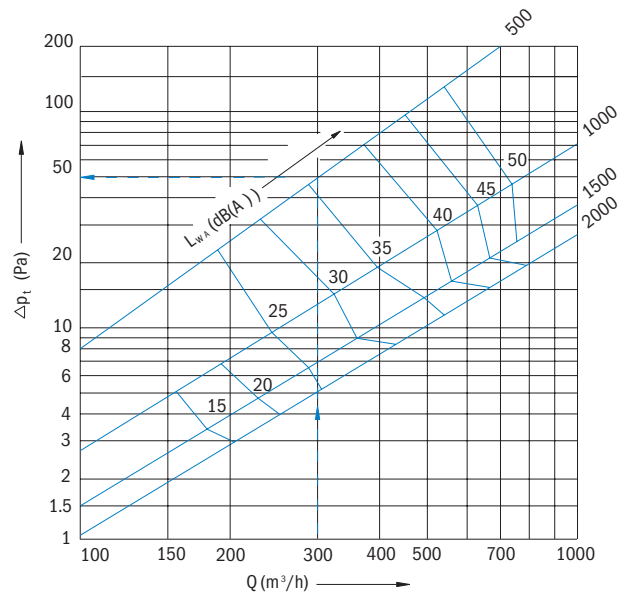

Correction factors applicable to LD-14/1

Type of discharge	Vertical		Horizontal	
	Open	Closed	Open	Closed
Flow rate control damper				
L=500	x 1	x 1.81	x 0.76	x 1.31
L=1000	x 1	x 3.83	x 0.42	x 3.23
L=1500	x 1	x 5.80	x 0.28	x 5.11
L=2000	x 1	x 7.87	x 0.19	x 7.07

Correction factors applicable to LD-14/2

Type of discharge	Vertical		Horizontal	
	Open	Closed	Open	Closed
Flow rate control damper				
L=500	x 1	x 2.11	x 0.53	x 1.59
L=1000	x 1	x 8.84	x 0.29	x 7.96
L=1500	x 1	x 15.36	x 0.20	x 14.14
L=2000	x 1	x 22.32	x 0.14	x 20.70

Example

$Q = 300 \text{ m}^3/\text{h}$
 $L = 1000 \text{ mm}$
 $\Delta p_t = 33 \text{ Pa}$ (vertical; damper opened)
 $\Delta p_t = 33 \times 3.83 = 126.4 \text{ Pa}$ (vertical; damper closed)
 $\Delta p_t = 33 \times 0.42 = 14.0 \text{ Pa}$ (horizontal; damper opened)
 $\Delta p_t = 33 \times 3.23 = 107.0 \text{ Pa}$ (horizontal; damper closed)
 $L_{WA} = 38 \text{ dB(A)}$

Example

$Q = 300 \text{ m}^3/\text{h}$
 $L = 500 \text{ mm}$
 $\Delta p_t = 47 \text{ Pa}$ (vertical; damper opened)
 $\Delta p_t = 47 \times 2.11 = 99.2 \text{ Pa}$ (vertical; damper closed)
 $\Delta p_t = 47 \times 0.53 = 24.9 \text{ Pa}$ (horizontal; damper opened)
 $\Delta p_t = 47 \times 1.59 = 74.7 \text{ Pa}$ (horizontal; damper closed)
 $L_{WA} = 36 \text{ dB(A)}$

Sound power level and pressure drop

LD 14/3

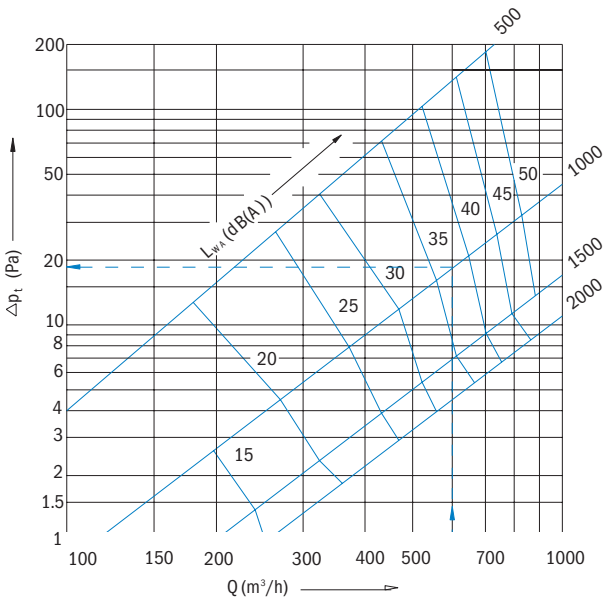

LD 14/4

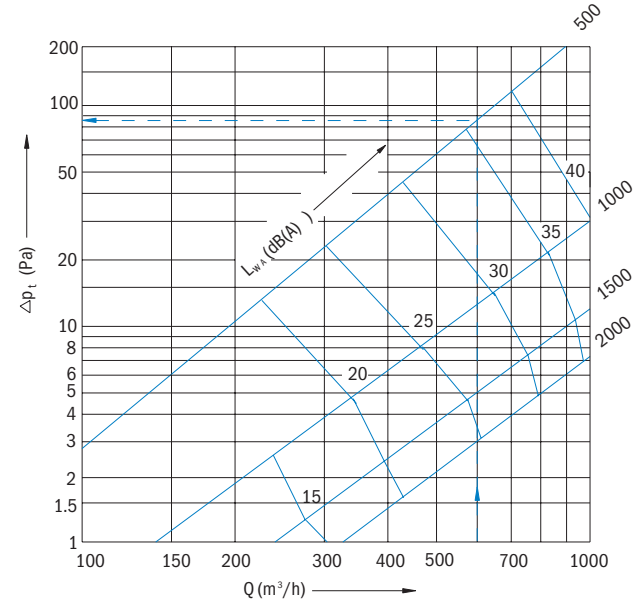

Correction factors applicable to LD-14/3

Type of discharge	Vertical		Horizontal	
	Open	Closed	Open	Closed
Flow rate control damper				
L=500	x 1	x 2.41	x 0.33	x 1.87
L=1000	x 1	x 13.86	x 0.19	x 12.69
L=1500	x 1	x 24.92	x 0.16	x 23.17
L=2000	x 1	x 36.76	x 0.13	x 31.33

Correction factors applicable to LD-14/4

Type of discharge	Vertical		Horizontal	
	Open	Closed	Open	Closed
Flow rate control damper				
L=500	x 1	x 3.14	x 0.28	x 2.43
L=1000	x 1	x 18.02	x 0.15	x 16.50
L=1500	x 1	x 32.34	x 0.13	x 28.12
L=2000	x 1	x 47.79	x 0.10	x 39.63

Example

Q = 600 m³/h
 L = 1000 mm
 Δp_t = 18 Pa (vertical; damper opened)
 Δp_t = 18 x 13.86 = 249.5 Pa (vertical; damper closed)
 Δp_t = 18 x 0.19 = 3.4 Pa (horizontal; damper opened)
 Δp_t = 18 x 12.69 = 228.4 Pa (horizontal; damper closed)
 L_{WA} = 38 dB(A)

Example

Q = 600 m³/h
 L = 500 mm
 Δp_t = 70 Pa (vertical; damper opened)
 Δp_t = 70 x 3.14 = 219.8 Pa (vertical; damper closed)
 Δp_t = 70 x 0.28 = 19.6 Pa (horizontal; damper opened)
 Δp_t = 70 x 2.43 = 170.1 Pa (horizontal; damper closed)
 L_{WA} = 36 dB(A)