

EVERLAST®

Advanced Composite Siding

GENERAL INFORMATION

- Check local building codes before installation.
- Before proceeding, read all instructions for both Everlast siding and appropriate pocketed trim products.
- Everlast siding is for horizontal application only. Do NOT install vertically.
- All pocketed trim must have a minimum pocket width of 3/4" and pocket depth of 5/8". The trim must be installed prior to installing Everlast siding.
- Do NOT install Everlast siding in temperatures below 0° F.
- Inspect siding for any breakage, foreign objects, surface defects, color consistency and correctness. Do NOT install questionable product.

JOB SITE STORAGE

- Do NOT stack siding more than 3 skids high.
- Do NOT store bundles in a vertical position.

BEST PRACTICE

- Siding should be stored inside when possible.
- Always avoid storing in direct sunlight, product should be covered and protected prior to installation using a tarp and/or supplied shroud. Keep siding away from heat sources.
- When product is stored outside use wood (or equivalent) supports to avoid direct contact with the ground in conjunction with covering.

PREPARING WALLS

- Everlast siding must be installed over flat and level exterior walls with either 16" or 24" on-center framing.
- Everlast siding serves as a rain screen, not a weather-resistant barrier. Therefore, it must be installed over a weather-resistant barrier.
- Properly flash around all windows, doors, rake boards, chimneys, and areas of transition between dissimilar materials.
- If installing over concrete block, poured concrete, or brick, siding must be installed over 1" x 3" furring strips.

BEST PRACTICE

If exterior walls are not flat or level, a quality underlayment should be installed first to create a flat and level surface.

STARTING THE INSTALLATION

- Install pocketed trim at inside and outside corners, and around all windows and doors.
- Measure & chalk a level line 3-1/8" up from the lowest point of the wall (Figure 1).

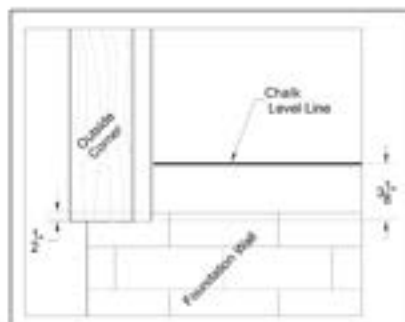

Figure 1

- Align the top of the Everlast starter strip on the level line, leave a 1" to 4" gap from the end of the starter strip & accessory nailing flange. Fasten starter strip to the wall assuring it is tightly fastened (Figure 2).

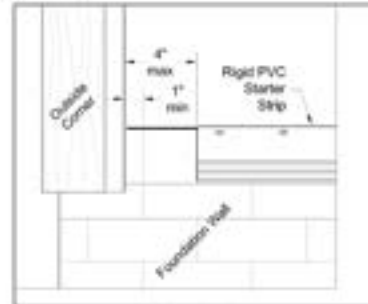

Figure 2

- Leave a 1/2" Gap between sections of starter strip.
- Lock the siding plank onto the starter strip and slide the plank into the corner pocket. Be certain the plank is fully seated onto the starter strip.
- To accommodate lateral expansion and contraction, always leave a 1/4" gap between the end of the siding plank and the inner wall of the pocketed trim (Figure 3).

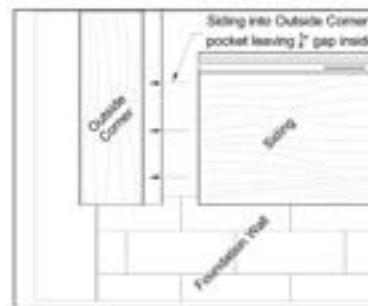

Figure 3

BEST PRACTICE

Prior to installation, mark stud locations to facilitate and speed installation. Nailing slots are provided every 8" on-center to also assist in stud location.

CUTTING PLANKS

- For vertical cuts, use a power saw with a fine tooth or plywood blade.
- An option for horizontal cuts only is to use a straight edge or metal brake with a utility knife or a scoring tool. Score across the face of the plank and then snap the plank on the score line.

REQUIRED FASTENERS

- Fasten planks only with aluminum, stainless steel, galvanized or other corrosion-resistant nails or screws.
- Nail/screw head diameter must be 3/8" to 7/16" with a maximum shank diameter of .160".
- If installing into metal framing, use self-tapping corrosion-resistant screws.

PROPER FASTENING

- Everlast is a floating siding system that accommodates lateral expansion and contraction within pocketed trim. Therefore, never hard nail siding planks tightly to the wall (Figure 4).

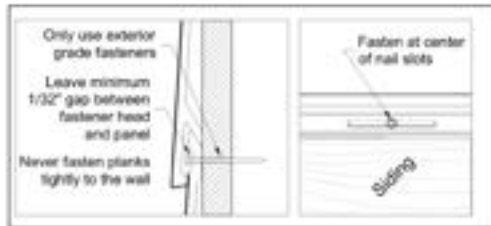

Figure 4

- Always fasten siding planks through the center of the pre-punched nailing slots (Figure 4).
- Always leave a minimum 1/32" gap between the nail head and the nailing hem (Figure 4).
- For stud walls only with no wood substrate, fasteners must penetrate the studs a minimum 1-1/8".
- Fastening into OSB or plywood sheathing is acceptable. Be sure the fasteners are long enough to penetrate a minimum 3/4" beyond the sheathing. Note: Fasten into studs when possible (Figure 4).
- Avoid fastening siding in a manner where it will conform to dips or bumps in the wall. On wavy walls, float the siding accordingly and shim where necessary to achieve visual flatness.
- To ensure a level installation, prior to fastening, be sure each plank is fully seated onto the starter strip or course below.
- Courses of siding measuring 60' or longer must be pinned at the center of the course. Pin the course by placing fasteners at both edges of a single nailing slot. This will ensure that a course expands and contracts in both directions (Figure 5).

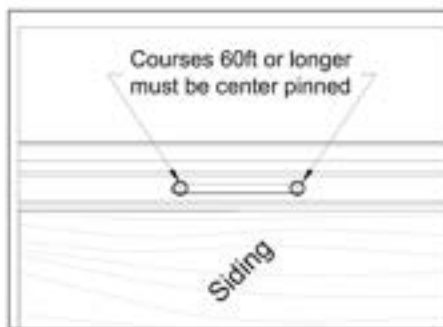

Figure 5

- When installing on walls with long continuous runs over 70', plan to add an expansion joint. Expansion joints can be incorporated in conjunction with center pinning, especially on walls with runs over 100'.

SEAMING PLANKS TOGETHER

- All plank-to-plank butt joints must be securely seamed using Everlast seam brackets and screws.

BEST PRACTICE

- Use factory end cuts at seam whenever possible. When using field cuts, be certain cuts are square.
- Check every 3 to 4 courses up the wall for levelness.

- Proper installation of seam brackets ensures all planks in a course are securely tied together and will be able to expand and contract freely as a single unit within pocketed trim (Figure 6).

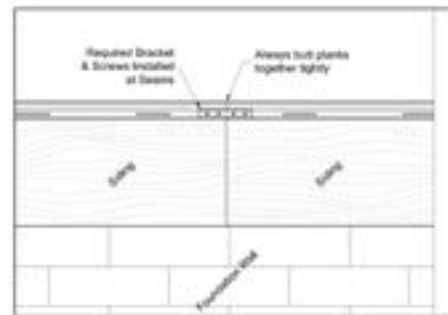

Figure 6

- Butt planks together tightly at seams before installing the seam bracket (Figure 6).
- Always make sure the bottom of panels align before installing the bracket (Figure 7).

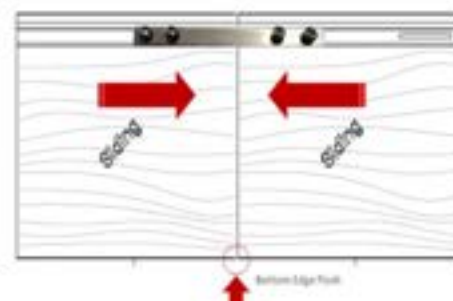

Figure 7

- Install each seam bracket with 4 seam bracket screws to hold planks firmly together. NOTE: The screws provided in the seam bracket kit are of proper length that will NOT penetrate through the planks. WARNING: Only use 5/16" stainless steel screws. Do not use screws that will penetrate into the wall, preventing planks from floating. Doing so voids the warranty.
- Center the seam bracket on the nailing hem of adjacent planks and fasten with 4 seam bracket screws, 2 per plank.
- When possible, avoid seams under and over windows and over doors.

BUTT JOINT SEAM GAPPING IS NOT A MANUFACTURE PRODUCT DEFECT

Seam Gap Potential Causes:

- Seam Bracket not installed/used.
- Seam Bracket not installed properly (screws strip out, missing screws).
- Butt joint initial install was incorrect (Not butted tight when bracket was fastened).
- Panels pinned/hard fastened along the course, not allowed panels/course to float properly.
- Long runs not pinned properly (60 ft).
- Long runs require proper pinning and Expansion joints (over 60ft).
- Improper gaps around utilities, windows, and doorways.

SEAM BRACKET KIT CALCULATOR

- Each kit contains 25 brackets and 115 screws
- 3 squares per kit for 6-7/8" reveal Everlast planks
- 2 squares per kit for 4-1/2" reveal Everlast planks

EAVES AND GABLES

- To maintain the proper pitch of the top course, use a furring strip behind the cut edge and at all seams. This furring strip also functions as a compression strip holding the planks tightly against the front of the top trim piece.
- Trim 1/8" off of the interlock located on the back of the last plank. For gables, where it can be especially tight, cut off the ends of the interlock diagonally. Face nail the last piece of siding with a color matched fastener or trim nail. This is the only instance when you should fasten through an Everlast plank (Figure 8).

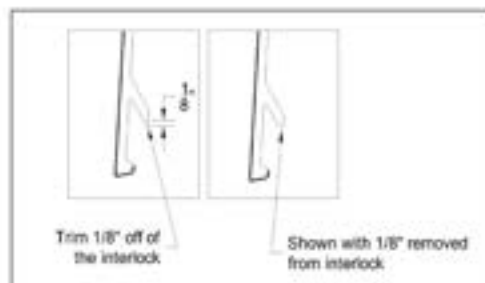

Figure 8

BEST PRACTICE

At eaves, when siding is installed prior to the soffit, use brackets at all seams.

INSTALLING SHUTTERS

- Pre-drill a 1/2" hole through the siding where the shutter screw will penetrate the siding.



For a video installation tutorial, visit EverlastSiding.com/ProResources.



REMOVING AND REPLACING A DAMAGED PLANK

- Carefully cut the damaged plank horizontally, 1" from the top and remove the lower section (Figure 9).

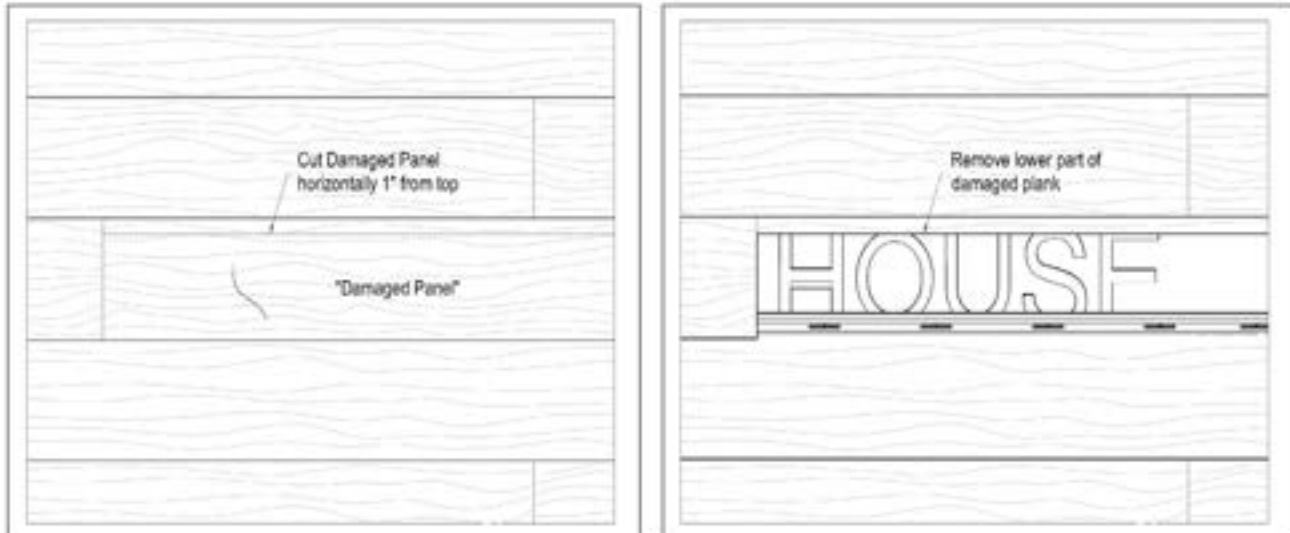

Figure 9

- Using a flathead screwdriver, pry loose the seam brackets connecting the damaged plank to the adjacent planks (Figure 10).
- Use a sawzall or oscillating tool to cut off the fasteners from the damaged plank and remove the top portion (Figure 10).

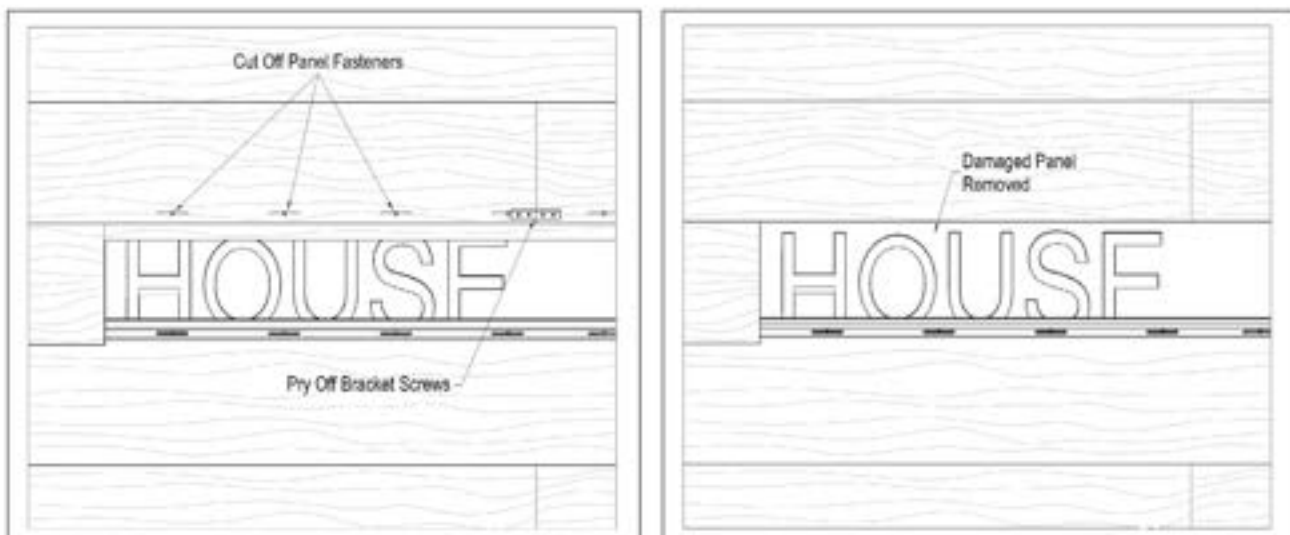

Figure 10

- Trim 1/8" off the inter-lock of the replacement plank (Figure 11).

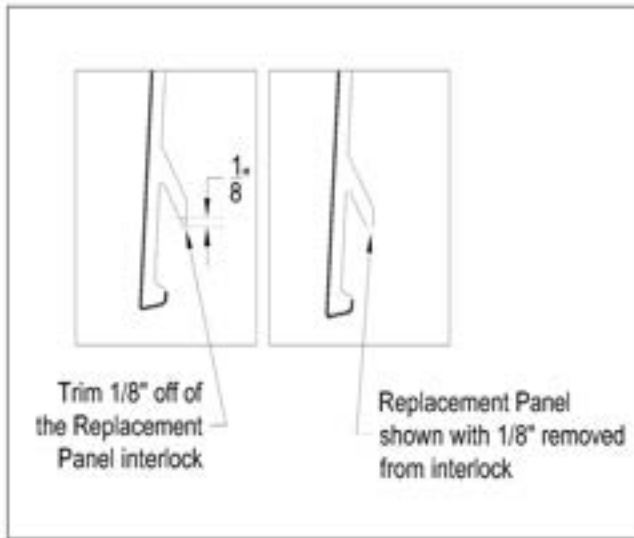

Figure 11

- Insert the plank, pre-drill holes along the top of the panel. The holes should be at least 1/16" larger in diameter than the trim nails (Figure 12).
- Insert the plank with pre-drilled holes & face nail every 16"-24" along the top of the panel using color matched trim nails. Or you can paint the head of the fastener (Refer to the Everlast website for Sherwin Williams color-match paint codes) (Figure 12).

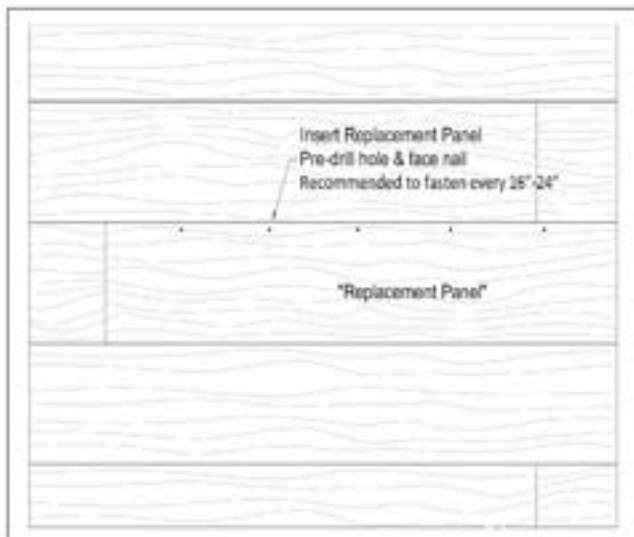

Figure 12



For a video installation tutorial, visit [EverlastSiding.com/ProResources](https://www.EverlastSiding.com/ProResources).



GENERAL INFORMATION

- Check local building codes before installation.
- Before proceeding, read all instructions for both Everlast siding and appropriate pocket trim products.
- Everlast Board & Batten siding is for vertical application only. Do NOT install horizontally.
- Do NOT install Everlast siding in temperatures below 0° F.
- Inspect siding for any breakage, foreign objects, surface defects, color consistency and correctness. Do NOT install questionable product.

JOB SITE STORAGE

- Do NOT stack siding more than 3 skids high.
- Do NOT store bundles in a vertical position.

BEST PRACTICE

- Siding should be stored inside when possible.
- Always avoid storing in direct sunlight, product should be covered and protected prior to installation using a tarp and/or supplied shroud. Keep siding away from heat sources.
- When product is stored outside use wood (or equivalent) supports to avoid direct contact with the ground in conjunction with covering.

PREPARING WALL SURFACES

- Everlast siding must be installed over flat and level exterior walls.
- Fastening into studs is not required, but Board & Batten must be installed into a minimum 7/16" of wood sheathing. The fasteners must penetrate beyond the wood sheathing a minimum of 3/4".
- For stud walls only with no wood substrate, apply 1" x 3" furring strips horizontally every 14" on center, or apply an OSB or plywood substrate over the studs.
- Everlast siding serves as a rain screen, not a weather-resistant barrier. Therefore, it must be installed over a weather-resistant barrier to eliminate any water penetration.
- Properly flash around all windows, doors, rake boards, chimneys, and areas of transition between dissimilar materials.
- If installing over concrete block, poured concrete, or brick, siding must be installed over 1" x 3" furring strips. Apply 1" x 3" wood furring strips horizontally 14" on center to create a level surface. If additional insulation is required, then apply rigid foam or fiber sheathing.

CREATING A BALANCED WALL

- It is not required to do so, but to create a balanced appearance on the the wall, use the following calculation.
- *Divide wall in inches by 10.875 (round down to whole number) = # of full panels needed. Multiply # of full panels needed by 10.875 = total coverage of full panels. Subtract total length of wall by total coverage of full panels = uncovered length. Divide uncovered length by 2 = each side piece reveal.*

Example (125" wall)
 $125 / 10.875 = 11.49$ (round to 11)
 $11 \times 10.875 = 119.625$
 $125 - 119.625 = 5.375$
 $5.375 / 2 = 2.69$

Note: Total wall length must be measured after the trim has been installed.

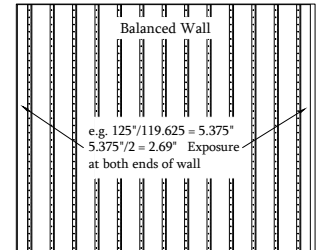
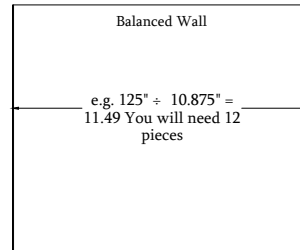

BEST PRACTICE

If exterior walls are not flat or level, a quality underlayment should be installed first to create a flat and level surface.

TRIM & ACCESSORIES

- Everlast Board & Batten requires the use of pocketed trim accessories. The siding cannot be butted up against trim.
- All current Everlast trim accessories are recommended for installation but not required. Everlast two-piece trim is recommended for ease of installation of the Board & Batten siding.
- The pocket or rabbeted trim accessories must be a minimum pocket width of 3/4" and depth of 5/8" to accommodate the panel interlock, as well as expansion and contraction.

CUTTING PANELS

- For horizontal cuts, use a power saw with a fine tooth (80T) finish plywood blade.
- An option for vertical cuts only, is to use a straight edge or metal brake with a utility knife or scoring tool. Score the face of the panel and then snap the panel on the score line.
- A circular saw can be used for vertical cuts as well.

REQUIRED FASTENERS

- Fasten panels only with aluminum, stainless steel, galvanized or other corrosion-resistant nails or screws.
- Nail/screw head diameter must be 3/8" to 7/16" with a maximum shank diameter of .160".
- If installing into metal framing, use self-tapping corrosion-resistant screws.
- Note: In high wind areas, screws or ring shank nails are recommended. Always consult with local building codes.

STARTING THE INSTALLATION

- Install pocketed trim at all inside and outside corners, around all windows and doors, and at the top termination of the Board & Batten siding. Make sure trim is installed level.
- The bottom can be flush with trim.
- Pocketed trim must have a minimum width of 3/4" to accommodate the batten of the panel.
- Everlast 2-piece perimeter trim requires the trim receiver to be installed prior to the Board & Batten siding. The 1-1/2" perimeter trim cover will be installed after siding installation is complete.
- If using rabbeted trim accessories, please follow manufacturers instructions for use. Properly measure and chalk a level line. Leave proper allowance for installation of the trim after the siding is installed.

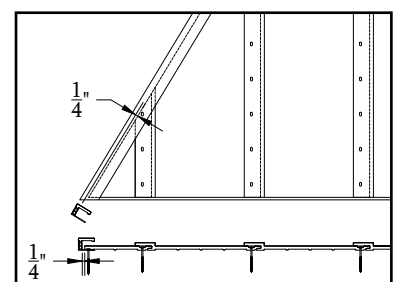
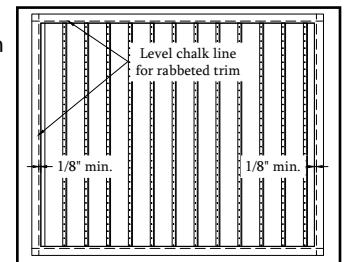

- If installing pocketed trim at the bottom of the course, it is recommended to drill 3/16" weep holes in the bottom of the channel every 18"-24" to allow for moisture to escape.
- To accommodate expansion and contraction, always leave a 1/4" gap between the siding panel and the inner wall of the top pocketed trim.

PROPER FASTENING

- Everlast is a floating siding system that accommodates vertical expansion and contraction within pocketed trim. Therefore, never hard nail siding panels tightly to the wall.
- The first fastener should be placed at the top of the bottom-most nail slot.
- Continue fastening at the top of the nail slot at intervals of every 3rd slot.
- Always fasten siding panels through the top of the pre-punched nailing slots.
- Always leave a minimum 1/32" gap between the fastener head and the nailing hem.
- Avoid fastening siding in a manner where it will conform to dips or bumps in the wall. On wavy walls, float the siding panels accordingly and shim where necessary to achieve visual flatness.

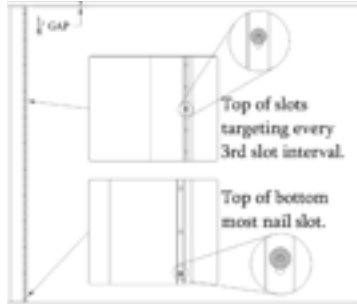

EXPANSION AND CONTRACTION

- With Everlast Board & Batten siding, allow for 1/4" of movement at the top of the panel when measuring.
- Position the first nail at the top of the bottom-most nail slot. This will help with letting the siding hang in place and allow the panels to rest at the bottom of trim.
- Center the remaining fasteners in the slots.

PANEL INSTALLATION

- Board & Batten panels can be installed in a left to right or right to left orientation.
- The nail hem will always be in the direction of installation.
- On each panel there is an **installation line guide** to ensure the panel is fully seated within the interlock. Always make sure this line is completely covered by the edge of the batten strip.
- The first panel will act as a starter strip for the entire course. This panel must be checked for perfect level prior to continuing the installation.

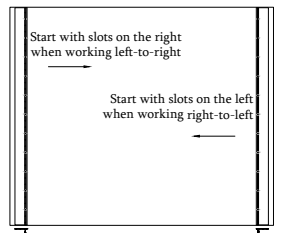

INSTALLING AROUND WINDOWS/DOORS/CUT OUTS

- When measuring Board & Batten panels to be cut and installed around windows, doors, and other cut outs, it is important to leave 1/4" gap on the top, bottom, and sides. This will maintain enough room for vertical expansion and contraction and ease of installation.

- It may be necessary to remove 1/8" from the interlock on the panel to be installed to allow the panel to slide into the trim, clear the existing panel, and have proper engagement. Use a utility blade to complete this task.

TRANSITIONING TO COURSES

- Board & Batten panels cannot be stacked on top of one another. *This is not a butt joint system.*
- If the wall is taller than one course (more than 12') it is important to separate the courses by a transition piece.
- The transition piece must be "Z flashed" prior to applying the second course of Board & Batten.
- When transitioning from horizontal siding to Board & Batten follow the same steps.
- Refer to "Starting the Installation" for second course installations.

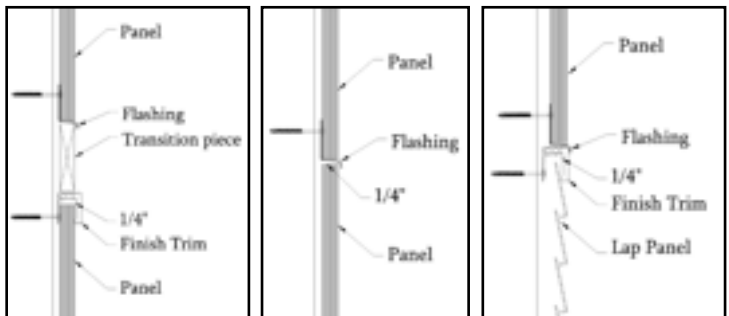

FINISHING THE LAST COURSE

- Finishing the last course may require you to remove part of the panel.
- Cut off 1/8" of the interlock to allow the panel to slide into the trim accessory and engage on the previous panel.
- Use a color-matched trim nail to fasten the last piece.
- Pre-drill a hole slightly larger than the shank of the fastener. Fasten every 16"-24" close to the end of the panel to hold in place.
- This is the only instance where the panels will need face fastened.
- If you choose to not face fasten the final panel, use a silicon adhesive on the inside of the interlock. Insert the last piece to lock the two panels together. The last two courses will move as one.

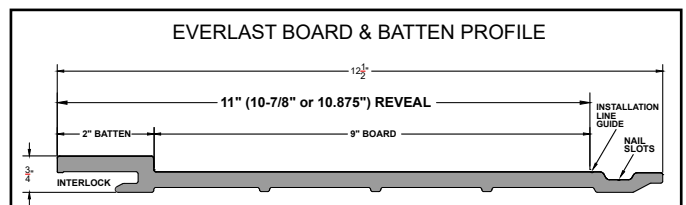
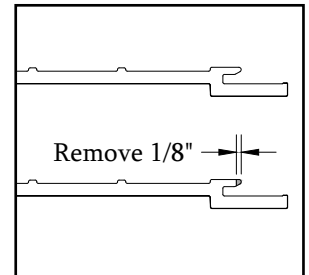

Water Table Trim (7917EV Cellular) Installation Instructions

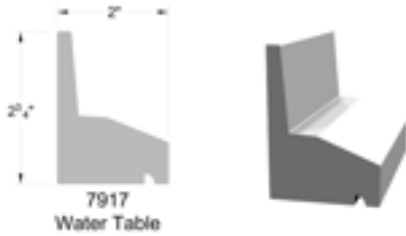

GENERAL INFORMATION

- Check local building codes before installation.
- Before proceeding, read all instructions for both Everlast siding and appropriate pocketed trim products.
- All pocketed trim used with Everlast siding must have a minimum pocket width of 3/4" and pocket depth of 5/8". The trim must be installed prior to installing Everlast siding.
- Do NOT install Everlast siding or Everlast trim in temperatures below 0° F.
- Inspect siding and trim for any breakage, foreign objects, surface defects, color consistency and correctness. Do NOT install questionable product.
- Use a fine tooth or vinyl saw blade to cut all material.
- Fasten material using an exterior grade nail or screw. (Recommended: galvanized/stainless/non-corrosive roofing nail or screw).
- Fasten trim through every other or every third nail hole, making sure the trim aesthetically looks good on the wall. Do not over drive the fastener--fastening too tight may cause distortion in the trim.
- To keep miter and butt joint ends tight, it is recommended to use a PVC glue or plastic weld to bond together.
- Use a glue accelerator to speed up the cure time.

JOB SITE STORAGE

- Do NOT stack siding or trim more than 3 skids high.
- Do NOT store bundles in a vertical position.

BEST PRACTICE

- Siding or trim should be stored inside when possible.
- Always avoid storing in direct sunlight, product should be covered and protected prior to installation using a tarp and/or supplied shroud. Keep siding away from heat sources.
- When product is stored outside use wood (or equivalent) supports to avoid direct contact with the ground in conjunction with covering.

PREPARING WALLS

- Everlast siding and trim must be installed over flat and level exterior walls with either 16" or 24" on-center framing.
- Everlast siding serves as a rain screen, not a weather-resistant barrier. Therefore, it must be installed over a weather-resistant barrier.
- Properly flash around all windows, doors, rake boards, chimneys, and areas of transition between dissimilar materials.
- If installing over concrete block, poured concrete, or brick, siding must be installed over 1" x 3" furring strips.

BEST PRACTICE

If exterior walls are not flat or level, a quality underlayment should be installed first to create a flat and level surface.

COMMON APPLICATIONS

- Water Table is typically used for Bottom of the Wall, Above a Stone/Brick Ledge

LENGTHS

- 18'

COLOR

- Matte White

INSTRUCTIONS

1. Measure the desired length to be cut.
2. Cut the water table with a power saw using a fine tooth or PVC blade.
3. On a table saw, remove top of water table to achieve desired gap from the bottom of the siding to the surface of the water table (Fig. 1, 2, 3).
4. Install the water table at the desired location making sure it remains level every 8" to 12" using galvanized, stainless, or corrosion resistant nails or screws through the top portion.
5. Butt adjoining pieces of water table together when exceeding 18'.
6. If installing Everlast lap siding, rest the required starter strip at the top of the water table and fasten to the wall.
7. Install Everlast siding according to the installation instructions.

Water Table Trim (7917EV Cellular) Installation Instructions

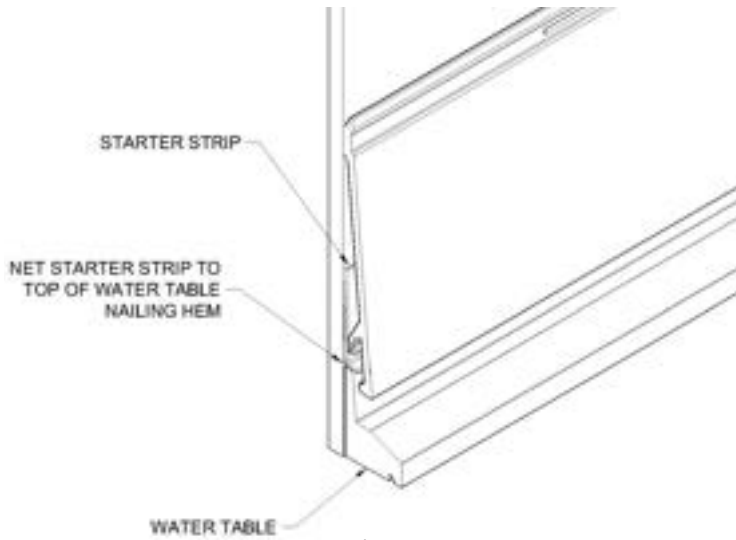

Fig. 1

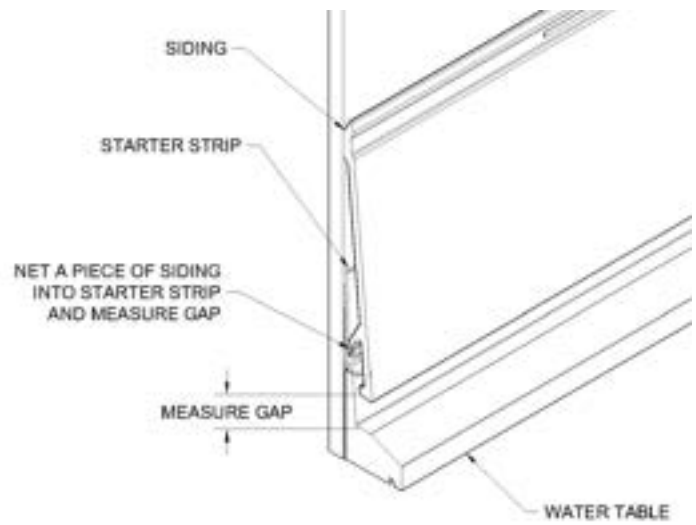

Fig. 2

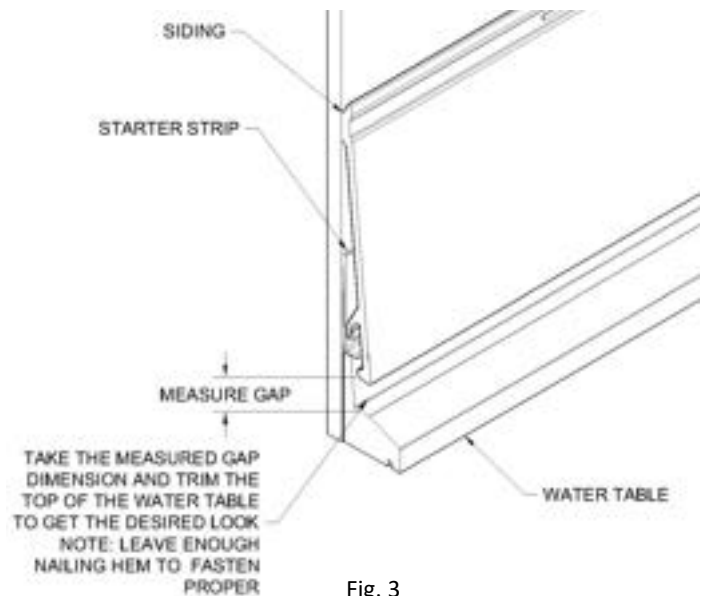
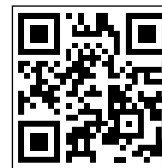

Fig. 3



For a video installation tutorial, visit EverlastSiding.com/ProResources.



1-1/2" Perimeter (6914 Color-Matched) with Receiver (6915) Trim Installation Instructions



GENERAL INFORMATION

- Check local building codes before installation.
- Before proceeding, read all instructions for both Everlast siding and appropriate pocketed trim products.
- All pocketed trim used with Everlast siding must have a minimum pocket width of 3/4" and pocket depth of 5/8". The trim must be installed prior to installing Everlast siding.
- Do NOT install Everlast siding or Everlast trim in temperatures below 0° F.
- Inspect siding and trim for any breakage, foreign objects, surface defects, color consistency and correctness. Do NOT install questionable product.
- Use a fine tooth or vinyl saw blade to cut all material.
- Fasten material using an exterior grade nail or screw. (Recommended: galvanized/stainless/non-corrosive roofing nail or screw).
- Fasten trim through every other or every third nail hole, making sure the trim aesthetically looks good on the wall. Do not over drive the fastener--fastening too tight may cause distortion in the trim.
- To keep miter and butt joint ends tight, it is recommended to use a PVC glue or plastic weld to bond together.
- Use a glue accelerator to speed up the cure time.

JOB SITE STORAGE

- Do NOT stack siding or trim more than 3 skids high.
- Do NOT store bundles in a vertical position.

BEST PRACTICE

- Siding or trim should be stored inside when possible.
- Always avoid storing in direct sunlight, product should be covered and protected prior to installation using a tarp and/or supplied shroud. Keep siding away from heat sources.
- When product is stored outside use wood (or equivalent) supports to avoid direct contact with the ground in conjunction with covering.



PREPARING WALLS

- Everlast siding and trim must be installed over flat and level exterior walls with either 16" or 24" on-center framing.
- Everlast siding serves as a rain screen, not a weather-resistant barrier. Therefore, it must be installed over a weather-resistant barrier.
- Properly flash around all windows, doors, rake boards, chimneys, and areas of transition between dissimilar materials.
- If installing over concrete block, poured concrete, or brick, siding must be installed over 1" x 3" furring strips.

BEST PRACTICE

If exterior walls are not flat or level, a quality underlayment should be installed first to create a flat and level surface.

COMMON APPLICATIONS

- Perimeter Trim is typically used for Board and Batten Install, Inside Corners, Soffit/Eave Terminations, Transitions

LENGTHS

- 12'6"

COLOR

- 15 standard Everlast colors

1-1/2" Perimeter (6914 Color-Matched) with Receiver (6915) Trim Installation Instructions

INSTRUCTIONS (Inside Corners)

1. Measure the height of the inside corner wall.
2. Cut two trim receivers using a power saw with a fine tooth or PVC blade.
3. To achieve a uniform inside corner, install a 1" x 1" block along the height of the wall (Fig. 1).
4. Place the trim receiver against the block and on the wall. Fasten every 8" to 12" along the nail hem making sure the receiver is securely fastened using galvanized, stainless, or corrosion resistant nails or screws (Fig. 2).
5. Install Everlast lap or board and batten siding per the siding installation instructions.
6. Measure and cut the perimeter trim and snap into the receiver.
7. For additional detail, please visit <https://www.everlastsiding.com/quick-guide-installation-videos>

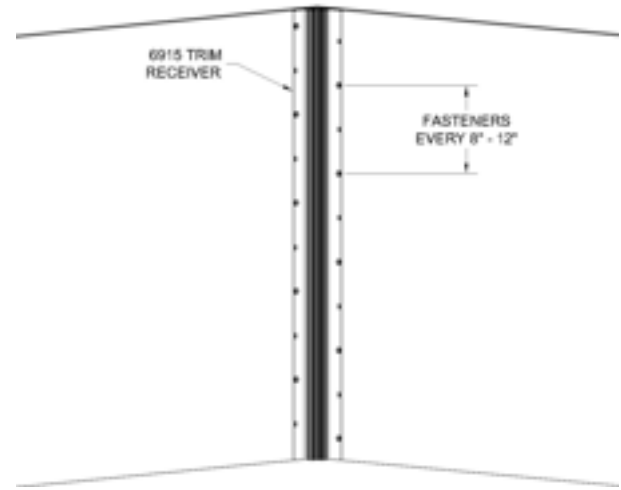

Fig. 2

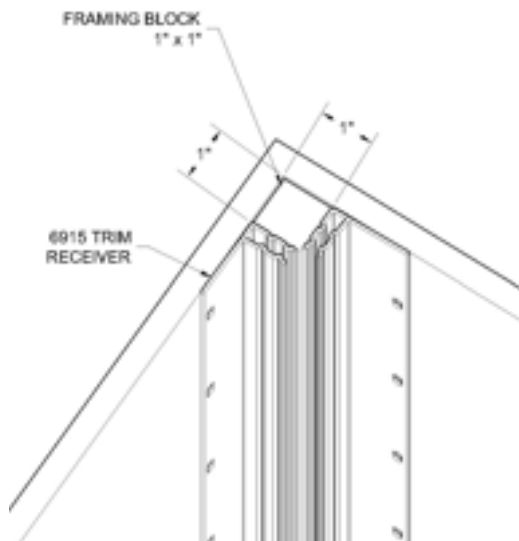

Fig. 1

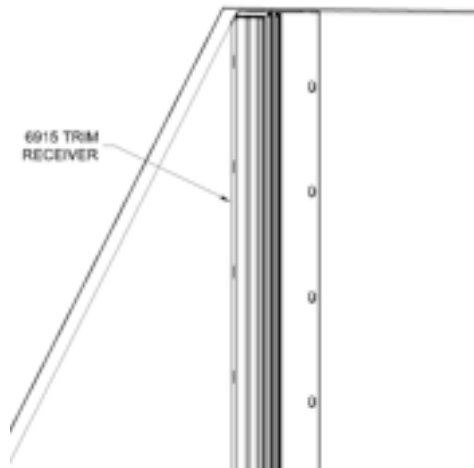

Fig. 3

INSTRUCTIONS

(Soffit/Eave Terminations and Transitions)

1. Before the last piece of Everlast siding is installed, measure the length of the termination or transition area
2. Cut the trim receiver using a power saw with a fine tooth or PVC blade
- 2a. In situations where the termination or transition exceeds 12', the conjoining trim receivers can be straight miter cut and butted together
3. Fasten the trim receiver to the wall approximately every 8" to 12" along the nail hem making sure the receiver is securely fastened using galvanized, stainless, or corrosion resistant nails or screws (Fig. 1)
4. Install the last piece/course of siding per the installation instructions. Use required seam brackets on courses exceeding 12'. No face nailing is required; panel fasteners will net at the top of the panel. (Fig. 2)
5. Measure and cut the perimeter trim and snap into the receiver (Fig. 3)
6. For additional detail, please visit <https://www.everlastsiding.com/quick-guide-installation-videos>

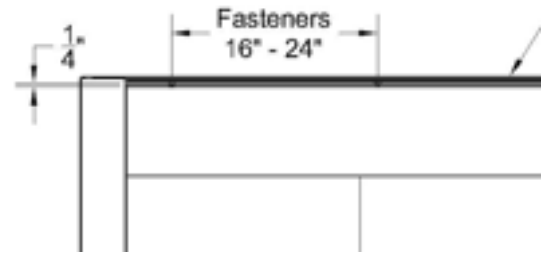

Fig. 2

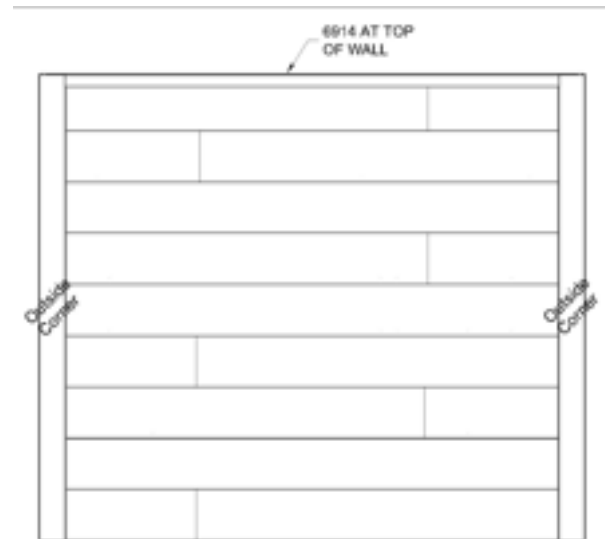

Fig. 3

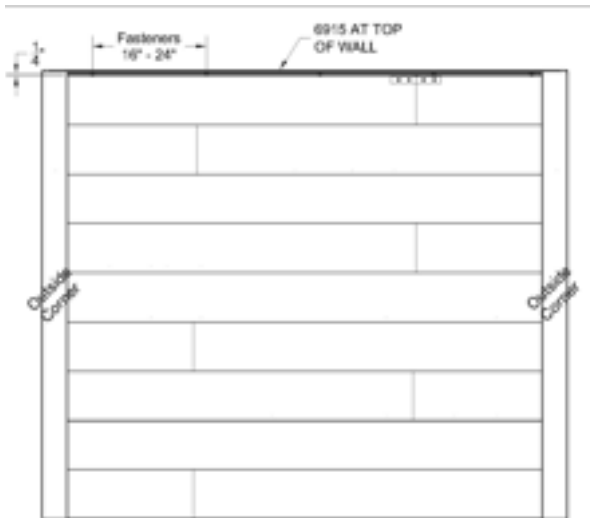
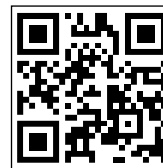

Fig. 1



For a video installation tutorial, visit [EverlastSiding.com/ProResources](https://www.everlastsiding.com/ProResources).



1-1/2" J Channel (6947 Color-Matched) Trim Installation Instructions



GENERAL INFORMATION

- Check local building codes before installation.
- Before proceeding, read all instructions for both Everlast siding and appropriate pocketed trim products.
- All pocketed trim used with Everlast siding must have a minimum pocket width of 3/4" and pocket depth of 5/8". The trim must be installed prior to installing Everlast siding.
- Do NOT install Everlast siding or Everlast trim in temperatures below 0° F.
- Inspect siding and trim for any breakage, foreign objects, surface defects, color consistency and correctness. Do NOT install questionable product.
- Use a fine tooth or vinyl saw blade to cut all material.
- Fasten material using an exterior grade nail or screw. (Recommended: galvanized/stainless/non-corrosive roofing nail or screw).
- Fasten trim through every other or every third nail hole, making sure the trim aesthetically looks good on the wall. Do not over drive the fastener--fastening too tight may cause distortion in the trim.
- To keep miter and butt joint ends tight, it is recommended to use a PVC glue or plastic weld to bond together.
- Use a glue accelerator to speed up the cure time.

JOB SITE STORAGE

- Do NOT stack siding or trim more than 3 skids high.
- Do NOT store bundles in a vertical position.

BEST PRACTICE

- Siding or trim should be stored inside when possible.
- Always avoid storing in direct sunlight, product should be covered and protected prior to installation using a tarp and/or supplied shroud. Keep siding away from heat sources.
- When product is stored outside use wood (or equivalent) supports to avoid direct contact with the ground in conjunction with covering.



PREPARING WALLS

- Everlast siding and trim must be installed over flat and level exterior walls with either 16" or 24" on-center framing.
- Everlast siding serves as a rain screen, not a weather-resistant barrier. Therefore, it must be installed over a weather-resistant barrier.
- Properly flash around all windows, doors, rake boards, chimneys, and areas of transition between dissimilar materials.
- If installing over concrete block, poured concrete, or brick, siding must be installed over 1" x 3" furring strips.

BEST PRACTICE

If exterior walls are not flat or level, a quality underlayment should be installed first to create a flat and level surface.

COMMON APPLICATIONS

- J Channel Trim is typically used for Window/Door Surround, Inside Corner, Soffit/Eave Terminations, Transitions

LENGTHS

- 12'6"

COLORS

- 15 standard Everlast colors

1-1/2" J Channel (6947 Color-Matched) Trim Installation Instructions

INSTRUCTIONS (Window and Doors)

- 1) Measure the height and width of the window/door.
- 2) 45° miter cut with a fine tooth or PVC blade.
 - a) Optional square cut J-channel can be achieved by running the trim long 1-1/2" on both ends (top/bottom or sides).
 - b) Use an oscillating tool and notch out channel of the trim 1-1/4" for the siding to be accepted within both trim J-channels (Fig. 1 and 2).
- 3) Fasten the J-channel pieces to the wall around the window/door every 8" to 12" along the nail hem making sure the profiles are securely fastened using galvanized, stainless, or corrosion resistant nails or screws (Fig. 3).
- 4) Optional PVC adhesive can be used to join the mitered ends.

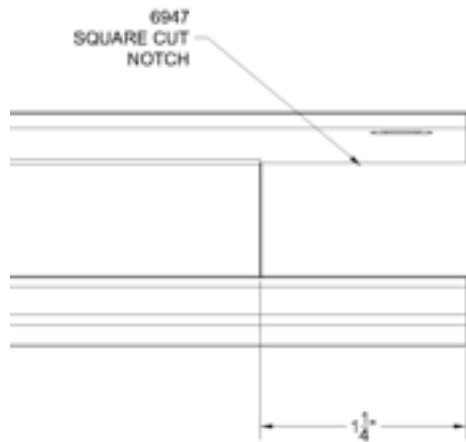

Fig. 1

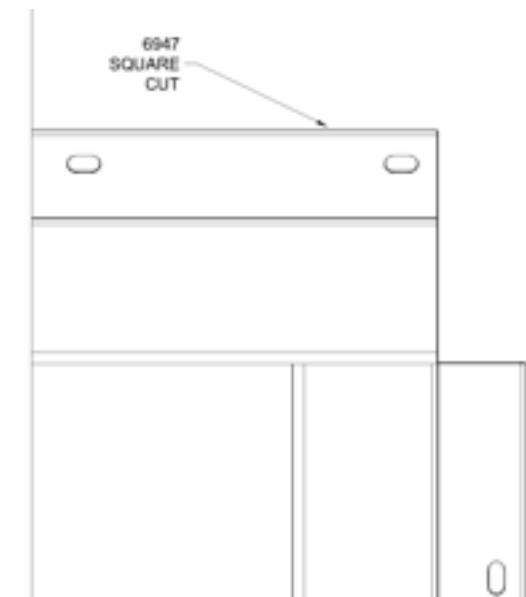

Fig. 2



Fig. 3

INSTRUCTIONS (Terminations and Transitions)

- 1) Before the last piece of Everlast siding is installed, measure the length of the termination or transition area.
- 2) Cut the J-channel using a power saw with a fine tooth or PVC blade.
 - (a) 2a. In situations where the termination or transition exceeds 12' 6", the conjoining J-channels can be straight miter cut and butted together.
- 3) Fasten the J-channel to the wall approximately every 8" to 12" along the nail hem making sure the profile is securely fastened using galvanized, stainless, or corrosion resistant nails or screws.
- 4) Install the last piece/course of Everlast siding per the installation instructions.

1-1/2" J Channel (6947 Color-Matched) Trim Installation Instructions

INSTRUCTIONS (Inside Corners)

- 1) Measure the height of the inside corner wall.
- 2) Cut two J-channels using a power saw with a fine tooth or PVC blade.
- 3) To achieve a uniform inside corner, install a 1" x 1" block along the height of the wall (Fig. 1).
- 4) Install the J-channels against the block in the direction of the inside walls. Fasten every 8" to 12" along the nail hem making sure the profiles are securely fastened using galvanized, stainless, or corrosion resistant nails or screws (Fig. 2).
- 5) Screws can be attached inside the pocket into the blocking to keep tight (Fig. 3).
- 6) For additional detail, please visit <https://www.everlastsiding.com/quick-guide-installation-videos>

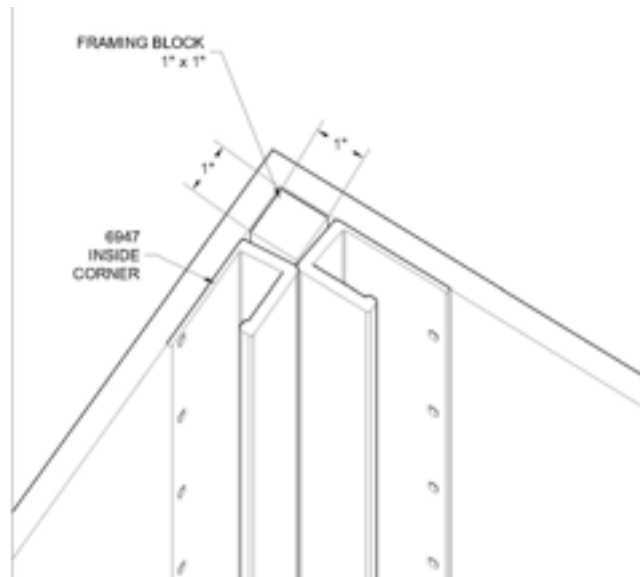

Fig. 1

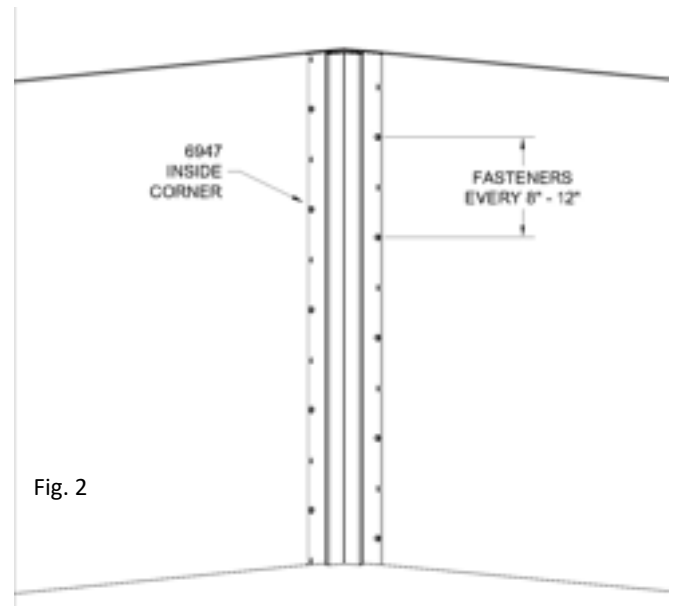

Fig. 2

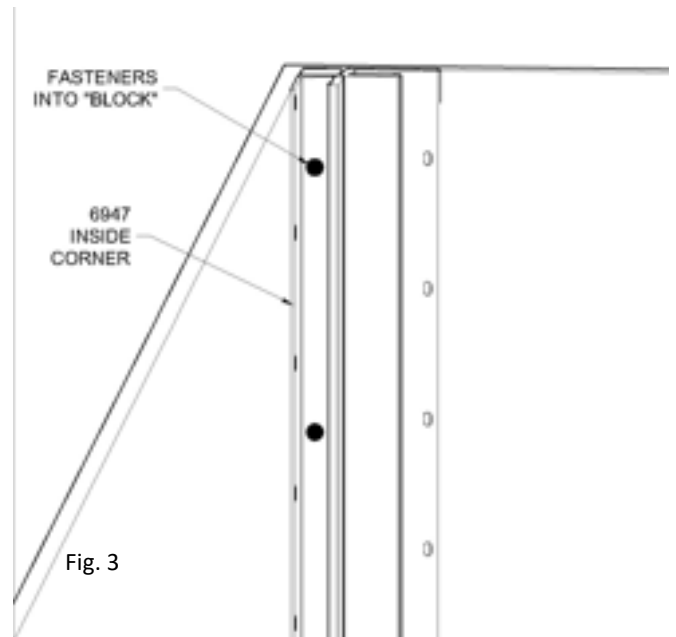
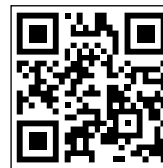

Fig. 3



For a video installation tutorial, visit [EverlastSiding.com/ProResources](https://www.everlastsiding.com/ProResources).



2" Brickmould Trim (7967EV Cellular) Installation Instructions

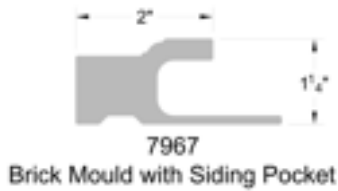

GENERAL INFORMATION

- Check local building codes before installation.
- Before proceeding, read all instructions for both Everlast siding and appropriate pocketed trim products.
- All pocketed trim used with Everlast siding must have a minimum pocket width of 3/4" and pocket depth of 5/8". The trim must be installed prior to installing Everlast siding.
- Do NOT install Everlast siding or Everlast trim in temperatures below 0° F.
- Inspect siding and trim for any breakage, foreign objects, surface defects, color consistency and correctness. Do NOT install questionable product.
- Use a fine tooth or vinyl saw blade to cut all material.
- Fasten material using an exterior grade nail or screw. (Recommended: galvanized/stainless/non-corrosive roofing nail or screw).
- Fasten trim through every other or every third nail hole, making sure the trim aesthetically looks good on the wall. Do not over drive the fastener--fastening too tight may cause distortion in the trim.
- To keep miter and butt joint ends tight, it is recommended to use a PVC glue or plastic weld to bond together.
- Use a glue accelerator to speed up the cure time.

JOB SITE STORAGE

- Do NOT stack siding or trim more than 3 skids high.
- Do NOT store bundles in a vertical position.

BEST PRACTICE

- Siding or trim should be stored inside when possible.
- Always avoid storing in direct sunlight, product should be covered and protected prior to installation using a tarp and/or supplied shroud. Keep siding away from heat sources.
- When product is stored outside use wood (or equivalent) supports to avoid direct contact with the ground in conjunction with covering.

PREPARING WALLS

- Everlast siding and trim must be installed over flat and level exterior walls with either 16" or 24" on-center framing.
- Everlast siding serves as a rain screen, not a weather-resistant barrier. Therefore, it must be installed over a weather-resistant barrier.
- Properly flash around all windows, doors, rake boards, chimneys, and areas of transition between dissimilar materials.
- If installing over concrete block, poured concrete, or brick, siding must be installed over 1" x 3" furring strips.

BEST PRACTICE

If exterior walls are not flat or level, a quality underlayment should be installed first to create a flat and level surface.

COMMON APPLICATIONS

- Brickmould is typically used for Window and Door Surround

LENGTHS

- 18'

COLOR

- Matte White

2" Brickmould Trim (7967EV Cellular)

Installation Instructions

INSTRUCTIONS

1. Measure the height and width of the window/door.
2. 45° miter cut using a miter saw with a fine tooth or PVC blade to achieve the cleanest cut.
3. Fasten the casing pieces to the wall around the window/door approximately every 8" to 12" along the nail hem using galvanized, stainless, or corrosion resistant nails or screws.
4. Optional face nailing: use 8d nails or 3" galvanized finishing nails, space nails 8" to 12" apart. Counter sink nails 1/16" below the surface of the casing. Nails should penetrate the structural frame at least 1". To conceal nail holes, use a sealant or epoxy. Cortex screws and plugs can also be used.
5. To join the miter ends, use a PVC adhesive or "toenail" a screw inside the pocket of the brickmould to pull the miters together.



For a video installation tutorial, visit EverlastSiding.com/ProResources.

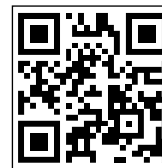

3-1/2" Casing (7968AEV Cellular) Trim Installation Instructions

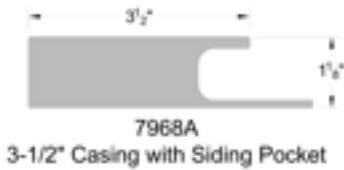

GENERAL INFORMATION

- Check local building codes before installation.
- Before proceeding, read all instructions for both Everlast siding and appropriate pocketed trim products.
- All pocketed trim used with Everlast siding must have a minimum pocket width of 3/4" and pocket depth of 5/8". The trim must be installed prior to installing Everlast siding.
- Do NOT install Everlast siding or Everlast trim in temperatures below 0° F.
- Inspect siding and trim for any breakage, foreign objects, surface defects, color consistency and correctness. Do NOT install questionable product.
- Use a fine tooth or vinyl saw blade to cut all material.
- Fasten material using an exterior grade nail or screw. (Recommended: galvanized/stainless/non-corrosive roofing nail or screw).
- Fasten trim through every other or every third nail hole, making sure the trim aesthetically looks good on the wall. Do not over drive the fastener--fastening too tight may cause distortion in the trim.
- To keep miter and butt joint ends tight, it is recommended to use a PVC glue or plastic weld to bond together.
- Use a glue accelerator to speed up the cure time.

JOB SITE STORAGE

- Do NOT stack siding or trim more than 3 skids high.
- Do NOT store bundles in a vertical position.

BEST PRACTICE

- Siding or trim should be stored inside when possible.
- Always avoid storing in direct sunlight, product should be covered and protected prior to installation using a tarp and/or supplied shroud. Keep siding away from heat sources.
- When product is stored outside use wood (or equivalent) supports to avoid direct contact with the ground in conjunction with covering.

PREPARING WALLS

- Everlast siding and trim must be installed over flat and level exterior walls with either 16" or 24" on-center framing.
- Everlast siding serves as a rain screen, not a weather-resistant barrier. Therefore, it must be installed over a weather-resistant barrier.
- Properly flash around all windows, doors, rake boards, chimneys, and areas of transition between dissimilar materials.
- If installing over concrete block, poured concrete, or brick, siding must be installed over 1" x 3" furring strips.

BEST PRACTICE

If exterior walls are not flat or level, a quality underlayment should be installed first to create a flat and level surface.

COMMON APPLICATIONS

- Casing trim is typically used for Window/Door Surround, Inside Corners, Soffit/Eave Terminations, Transitions

LENGTHS

- 12'

COLOR

- Matte White

3-1/2" Casing (7968AEV Cellular) Trim Installation Instructions

INSTRUCTIONS - WINDOW & DOORS

1. Measure the height and width of the window/door.
2. 45° miter cut with a fine tooth or PVC blade.
3. Fasten the casing pieces to the wall around the window/door approximately every 8" to 12" along the nail hem using galvanized, stainless, or corrosion resistant nails or screws (See Fig. 1).
4. To join the miter ends, use a PVC adhesive to hold the miters together.
5. Optional face nailing: use 8d nails or 3" galvanized finishing nails, space nails 8" to 12" apart. Counter sink nails 1/16" below the surface of the casing. Nails should penetrate the structural frame at least 1". To conceal nail holes, use a sealant or epoxy. Cortex screws and plugs can also be used.



Fig. 1



INSTRUCTIONS - INSIDE CORNERS

1. Measure the height of the inside corner wall.
2. Cut two casings using a power saw with a fine tooth or PVC blade.
3. In situations to achieve a low profile inside corner, measure and rip cut to the desired width on a table saw.
4. Fasten one casing to one inside wall approximately every 8" to 12" along the nail hem making sure to keep plumb.
5. Fasten the second casing the second inside wall approximately every 8" to 12" along the nail hem making sure to keep plumb.

INSTRUCTIONS - TERMINATIONS & TRANSITIONS

1. Before the last piece of Everlast siding is installed, measure the length of the termination or transition area.
2. Cut the casings using a power saw with a fine tooth or vinyl blade.
 - 2a. For best results on long runs, use a scarf joint with two fasteners on each side in place of butt joints.
 - 2b. Fasten the casings to the wall approximately every 8" to 12" along the nail hem making sure the casing is securely fastened using galvanized, stainless, or corrosion resistant nails or screws.
3. When face nailing use 8d nails or 3" galvanized finishing nails, space nails 8" to 12" apart. Counter sink nails 1/16" below the surface of the brickmould. Nails should penetrate the structural frame at least 1". To conceal nail holes, use a sealant or epoxy. Cortex screws and plugs can also be used.



For a video installation tutorial, visit EverlastSiding.com/ProResources



3-1/2" Outside Corner (7910EV Cellular) Trim Installation Instructions



GENERAL INFORMATION

- Check local building codes before installation.
- Before proceeding, read all instructions for both Everlast siding and appropriate pocketed trim products.
- All pocketed trim used with Everlast siding must have a minimum pocket width of 3/4" and pocket depth of 5/8". The trim must be installed prior to installing Everlast siding.
- Do NOT install Everlast siding or Everlast trim in temperatures below 0° F.
- Inspect siding and trim for any breakage, foreign objects, surface defects, color consistency and correctness. Do NOT install questionable product.
- Use a fine tooth or vinyl saw blade to cut all material.
- Fasten material using an exterior grade nail or screw. (Recommended: galvanized/stainless/non-corrosive roofing nail or screw).
- Fasten trim through every other or every third nail hole, making sure the trim aesthetically looks good on the wall. Do not over drive the fastener--fastening too tight may cause distortion in the trim.
- To keep joints tight, it is recommended to use a PVC glue or plastic weld to bond together.
- Use a glue accelerator to speed up the cure time.

JOB SITE STORAGE

- Do NOT stack siding or trim more than 3 skids high.
- Do NOT store bundles in a vertical position.

BEST PRACTICE

- Siding or trim should be stored inside when possible.
- Always avoid storing in direct sunlight, product should be covered and protected prior to installation using a tarp and/or supplied shroud. Keep siding away from heat sources.
- When product is stored outside use wood (or equivalent) supports to avoid direct contact with the ground in conjunction with covering.

PREPARING WALLS

- Everlast siding and trim must be installed over flat and level exterior walls with either 16" or 24" on-center framing.
- Everlast siding serves as a rain screen, not a weather-resistant barrier. Therefore, it must be installed over a weather-resistant barrier.
- Properly flash around all windows, doors, rake boards, chimneys, and areas of transition between dissimilar materials.
- If installing over concrete block, poured concrete, or brick, siding must be installed over 1" x 3" furring strips.

BEST PRACTICE

If exterior walls are not flat or level, a quality underlayment should be installed first to create a flat and level surface.

COMMON APPLICATIONS

- Outside Corner Trim is typically used for 90° outside corners of the structure

LENGTHS

- 10' and 20'

COLOR

- Matte White

3-1/2" Outside Corner (7910EV Cellular)

Trim Installation Instructions

INSTRUCTIONS

1. Measure the height of the outside corner.
2. Cut the profile using a power saw with a fine tooth or PVC blade.
3. Fasten the outside corner to the wall using galvanized or corrosion resistant nails or screws approximately every 8" to 12" along the nail hem making sure the profiles are securely fastened using galvanized, stainless, or corrosion resistant nails or screws (Fig. 1).
4. While fastening, make sure the profile stays plumb by using a level or by line of sight.
5. In instances when the wall exceeds 10' or 20' and a second outside corner section must be installed, stack and butt the second piece to the first.
6. Recommended to use a PVC adhesive to join the two pieces or install 2 seam brackets and bracket screws inside the pocket of the outside corners to tie together (Fig. 2).

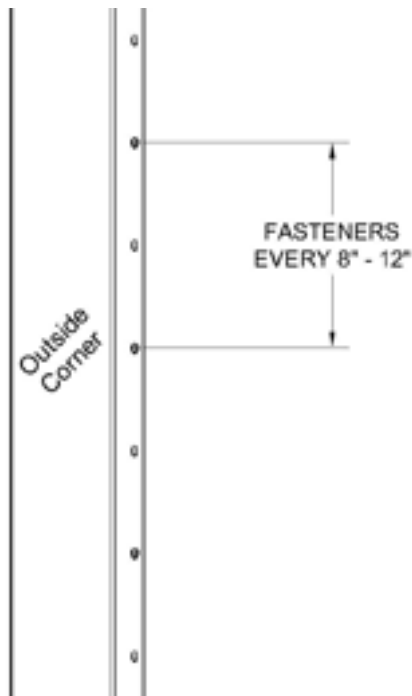

Fig. 1

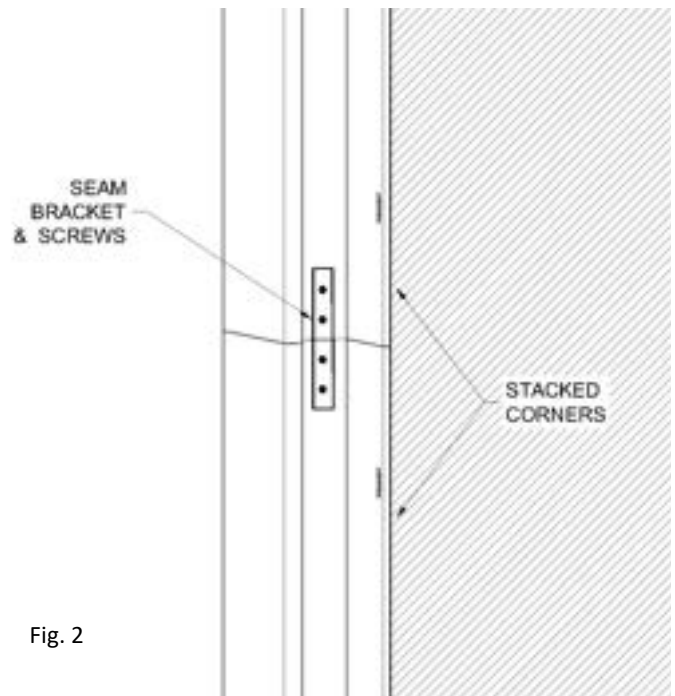
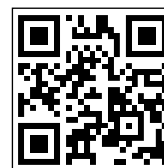

Fig. 2



For a video installation tutorial, visit EverlastSiding.com/ProResources.



3-1/2" Outside Corner (6948 Color-Matched) Trim Installation Instructions

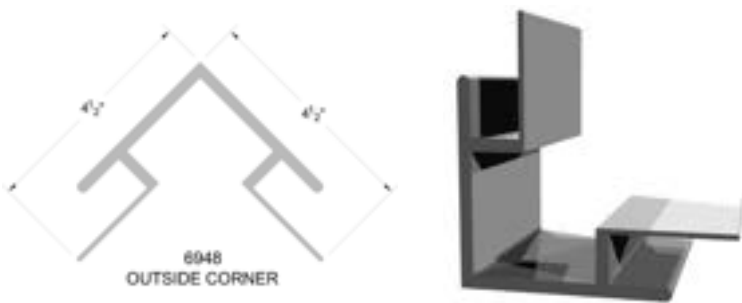

GENERAL INFORMATION

- Check local building codes before installation.
- Before proceeding, read all instructions for both Everlast siding and appropriate pocketed trim products.
- All pocketed trim used with Everlast siding must have a minimum pocket width of 3/4" and pocket depth of 5/8". The trim must be installed prior to installing Everlast siding.
- Do NOT install Everlast siding or Everlast trim in temperatures below 0° F.
- Inspect siding and trim for any breakage, foreign objects, surface defects, color consistency and correctness. Do NOT install questionable product.
- Use a fine tooth or vinyl saw blade to cut all material.
- Fasten material using an exterior grade nail or screw. (Recommended: galvanized/stainless/non-corrosive roofing nail or screw).
- Fasten trim through every other or every third nail hole, making sure the trim aesthetically looks good on the wall. Do not over drive the fastener--fastening too tight may cause distortion in the trim.
- To keep joints tight, it is recommended to use a PVC glue or plastic weld to bond together.
- Use a glue accelerator to speed up the cure time.

JOB SITE STORAGE

- Do NOT stack siding or trim more than 3 skids high.
- Do NOT store bundles in a vertical position.

BEST PRACTICE

- Siding or trim should be stored inside when possible.
- Always avoid storing in direct sunlight, product should be covered and protected prior to installation using a tarp and/or supplied shroud. Keep siding away from heat sources.
- When product is stored outside use wood (or equivalent) supports to avoid direct contact with the ground in conjunction with covering.

PREPARING WALLS

- Everlast siding and trim must be installed over flat and level exterior walls with either 16" or 24" on-center framing.
- Everlast siding serves as a rain screen, not a weather-resistant barrier. Therefore, it must be installed over a weather-resistant barrier.
- Properly flash around all windows, doors, rake boards, chimneys, and areas of transition between dissimilar materials.
- If installing over concrete block, poured concrete, or brick, siding must be installed over 1" x 3" furring strips.

BEST PRACTICE

If exterior walls are not flat or level, a quality underlayment should be installed first to create a flat and level surface.

COMMON APPLICATIONS

- Outside Corner Trim is typically used for 90° outside corners of the structure

LENGTHS

- 10' and 20'

COLORS

- 15 standard Everlast colors

INSTRUCTIONS

1. Measure the height of the outside corner.
2. Cut the profile using a power saw with a fine tooth or PVC blade.
3. Fasten the outside corner to the wall using galvanized, stainless, or corrosion resistant nails or screws approximately every 8" to 12" along the nail hem (Fig. 1).
4. While fastening, make sure the profile stays plumb by using a level or by line of sight.
5. In instances when the wall exceeds 10' or 20' and a second outside corner section must be installed, stack and butt the second piece to the first (Fig. 2).
6. Recommended to use a PVC adhesive to join the two pieces or install 2 seam brackets and bracket screws inside the pocket of the outside corners to tie together.

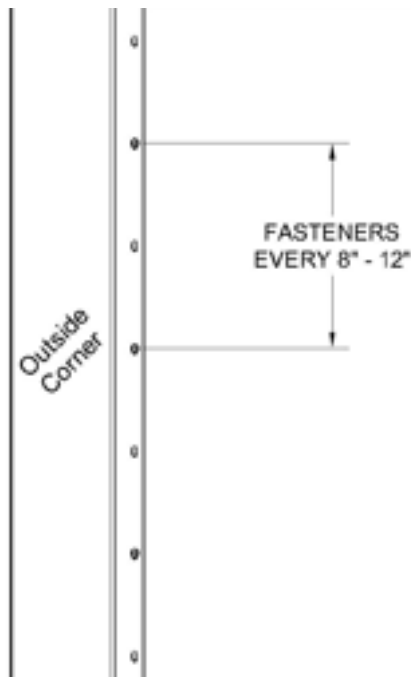

Fig. 1

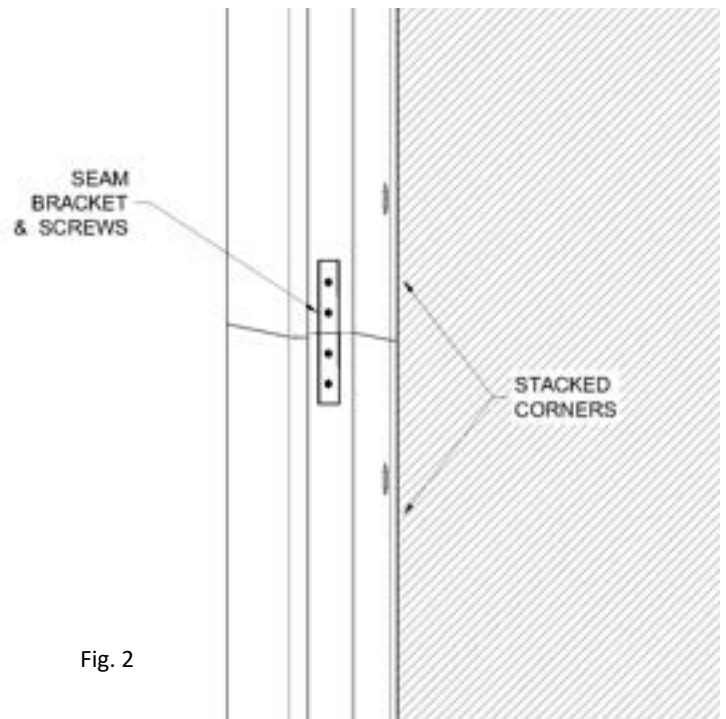
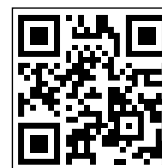

Fig. 2



For a video installation tutorial, visit EverlastSiding.com/ProResources.



3-1/2" Lineal Trim (6949 Color-Matched) Installation Instructions

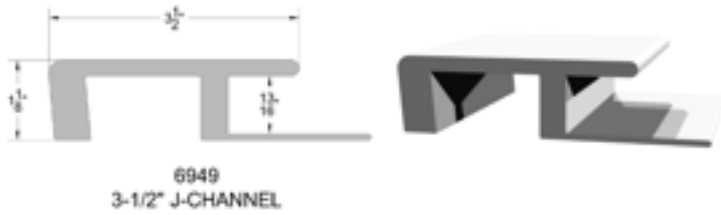

GENERAL INFORMATION

- Check local building codes before installation.
- Before proceeding, read all instructions for both Everlast siding and appropriate pocketed trim products.
- All pocketed trim used with Everlast siding must have a minimum pocket width of 3/4" and pocket depth of 5/8". The trim must be installed prior to installing Everlast siding.
- Do NOT install Everlast siding or Everlast trim in temperatures below 0° F.
- Inspect siding and trim for any breakage, foreign objects, surface defects, color consistency and correctness. Do NOT install questionable product.
- Use a fine tooth or vinyl saw blade to cut all material.
- Fasten material using an exterior grade nail or screw. (Recommended: galvanized/stainless/non-corrosive roofing nail or screw).
- Fasten trim through every other or every third nail hole, making sure the trim aesthetically looks good on the wall. Do not over drive the fastener--fastening too tight may cause distortion in the trim.
- To keep miter and butt joint ends tight, it is recommended to use a PVC glue or plastic weld to bond together.
- Use a glue accelerator to speed up the cure time.

JOB SITE STORAGE

- Do NOT stack siding or trim more than 3 skids high.
- Do NOT store bundles in a vertical position.

BEST PRACTICE

- Siding or trim should be stored inside when possible.
- Always avoid storing in direct sunlight, product should be covered and protected prior to installation using a tarp and/or supplied shroud. Keep siding away from heat sources.
- When product is stored outside use wood (or equivalent) supports to avoid direct contact with the ground in conjunction with covering.



PREPARING WALLS

- Everlast siding and trim must be installed over flat and level exterior walls with either 16" or 24" on-center framing.
- Everlast siding serves as a rain screen, not a weather-resistant barrier. Therefore, it must be installed over a weather-resistant barrier.
- Properly flash around all windows, doors, rake boards, chimneys, and areas of transition between dissimilar materials.
- If installing over concrete block, poured concrete, or brick, siding must be installed over 1" x 3" furring strips.

BEST PRACTICE

If exterior walls are not flat or level, a quality underlayment should be installed first to create a flat and level surface.

COMMON APPLICATIONS

- Lineal Trim is typically used for Window and Door Surround

LENGTHS

- 12'6"

COLOR

- 15 standard Everlast colors

3-1/2" Lineal Trim (6949 Color-Matched) Installation Instructions

INSTRUCTIONS

1. Installing the Everlast 3.5" window lineal will require the installer to "block" the mitered corners by following the steps below.
2. This blocking method can be done piece by piece on the wall or cut and constructed on the ground prior to installing the trim on the wall.
3. Use a 1" x 2" (actual dimension 3/4" thick, 1-1/2" wide) pressure treated board or PVC moulding to complete the blocking method.
4. If necessary, rip cut material to 3/4" thick and 1-1/2" wide.
5. Cut enough 6" pieces to complete each corner of the window and/or door.
6. Place the cut piece into the back cavity of the lineal trim.

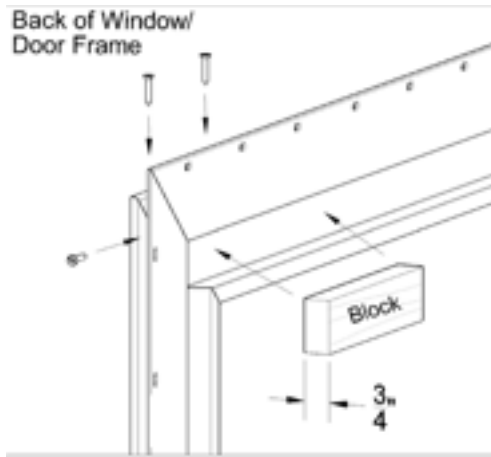

7. Connect the mitered corners and blocking together by fastening a screw into the pocket of the lineal being sure to catch the short end of the blocking. Fasten two screws into the second lineal pocket being sure to catch the long end of the blocking.

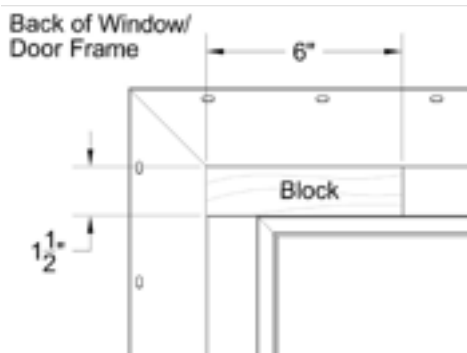

8. Lineal trim should be fastened on the wall through the nail hem every 3 nail slots.

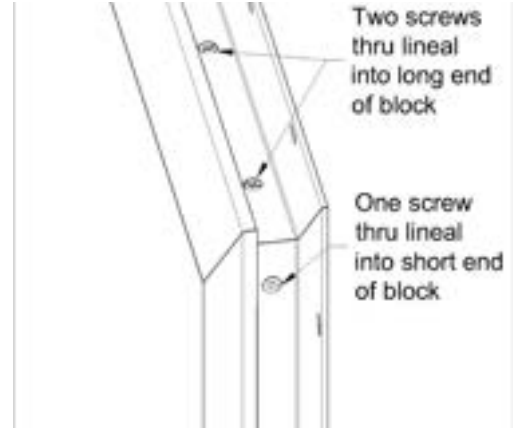

9. For additional detail, please visit:
<https://www.everlastsiding.com/quick-guide-installation-videos>



For a video installation tutorial,
visit [EverlastSiding.com/ProResources](https://www.everlastsiding.com/ProResources)

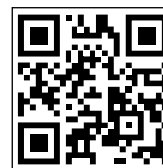

5-1/2" Casing Trim (7966AEV Cellular)

Installation Instructions



GENERAL INFORMATION

- Check local building codes before installation.
- Before proceeding, read all instructions for both Everlast siding and appropriate pocketed trim products.
- All pocketed trim used with Everlast siding must have a minimum pocket width of 3/4" and pocket depth of 5/8". The trim must be installed prior to installing Everlast siding.
- Do NOT install Everlast siding or Everlast trim in temperatures below 0° F.
- Inspect siding and trim for any breakage, foreign objects, surface defects, color consistency and correctness. Do NOT install questionable product.
- Use a fine tooth or vinyl saw blade to cut all material.
- Fasten material using an exterior grade nail or screw. (Recommended: galvanized/stainless/non-corrosive roofing nail or screw).
- Fasten trim through every other or every third nail hole, making sure the trim aesthetically looks good on the wall. Do not over drive the fastener--fastening too tight may cause distortion in the trim.
- To keep miter and butt joint ends tight, it is recommended to use a PVC glue or plastic weld to bond together.
- Use a glue accelerator to speed up the cure time.

JOB SITE STORAGE

- Do NOT stack siding or trim more than 3 skids high.
- Do NOT store bundles in a vertical position.

BEST PRACTICE

- Siding or trim should be stored inside when possible.
- Always avoid storing in direct sunlight, product should be covered and protected prior to installation using a tarp and/or supplied shroud. Keep siding away from heat sources.
- When product is stored outside use wood (or equivalent) supports to avoid direct contact with the ground in conjunction with covering.

PREPARING WALLS

- Everlast siding and trim must be installed over flat and level exterior walls with either 16" or 24" on-center framing.
- Everlast siding serves as a rain screen, not a weather-resistant barrier. Therefore, it must be installed over a weather-resistant barrier.
- Properly flash around all windows, doors, rake boards, chimneys, and areas of transition between dissimilar materials.
- If installing over concrete block, poured concrete, or brick, siding must be installed over 1" x 3" furring strips.

BEST PRACTICE

If exterior walls are not flat or level, a quality underlayment should be installed first to create a flat and level surface.

COMMON APPLICATIONS

- Casing trim is typically used for Window/Door Surround, Inside Corners, Soffit/Eave Terminations, Transitions

LENGTHS

- 12'

COLOR

- Matte White

5-1/2" Casing Trim (7966AEV Cellular)

Installation Instructions

INSTRUCTIONS - WINDOW & DOORS

1. Measure the height and width of the window/door.
2. 45° miter cut with a fine tooth or PVC blade.
3. Fasten the casing pieces to the wall around the window/door approximately every 8" to 12" along the nail hem using galvanized, stainless, or corrosion resistant nails or screws (See Fig. 1).
4. To join the miter ends, use a PVC adhesive to hold the miters together.
5. Optional face nailing: use 8d nails or 3" galvanized finishing nails, space nails 8" to 12" apart. Counter sink nails 1/16" below the surface of the casing. Nails should penetrate the structural frame at least 1". To conceal nail holes, use a sealant or epoxy. Cortex screws and plugs can also be used.

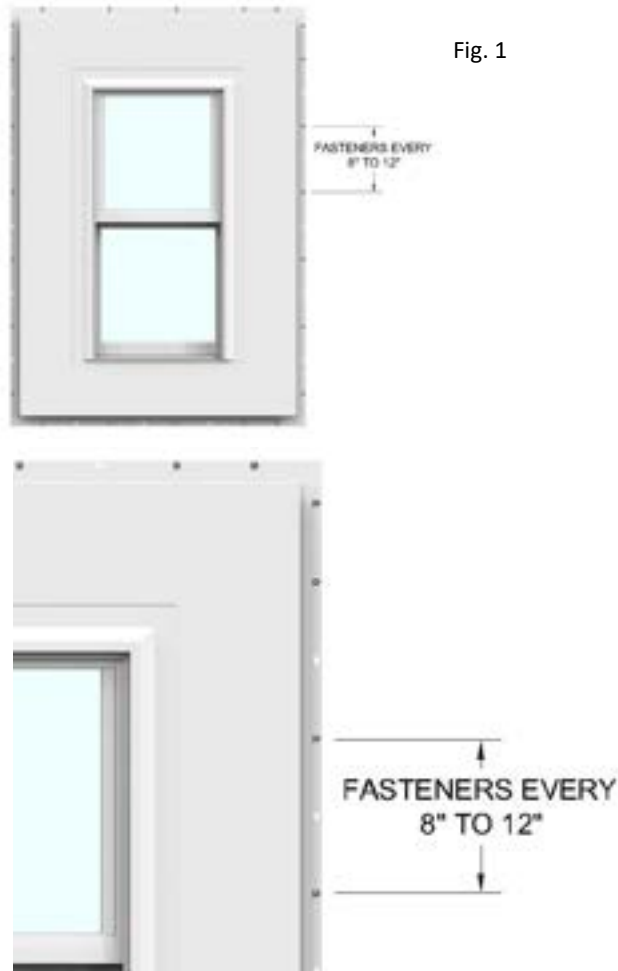

Fig. 1

INSTRUCTIONS - INSIDE CORNERS

1. Measure the height of the inside corner wall.
2. Cut two casings using a power saw with a fine tooth or PVC blade.
3. In situations to achieve a low profile inside corner, measure and rip cut to the desired width on a table saw.
4. Fasten one casing to one inside wall approximately every 8" to 12" along the nail hem making sure to keep plumb.
5. Fasten the second casing the second inside wall approximately every 8" to 12" along the nail hem making sure to keep plumb.

INSTRUCTIONS - TERMINATIONS & TRANSITIONS

1. Before the last piece of Everlast siding is installed, measure the length of the termination or transition area.
2. Cut the casings using a power saw with a fine tooth or vinyl blade.
 - 2a. For best results on long runs, use a scarf joint with two fasteners on each side in place of butt joints.
 - 2b. Fasten the casings to the wall approximately every 8" to 12" along the nail hem making sure the casing is securely fastened using galvanized, stainless, or corrosion resistant nails or screws.
3. When face nailing use 8d nails or 3" galvanized finishing nails, space nails 8" to 12" apart. Counter sink nails 1/16" below the surface of the **brickmould**. Nails should penetrate the structural frame at least 1". To conceal nail holes, use a



For a video installation tutorial, visit EverlastSiding.com/ProResources.

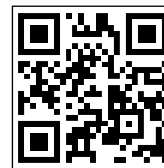

5-1/2" Outside Corner (7977EV Cellular) Trim Installation Instructions

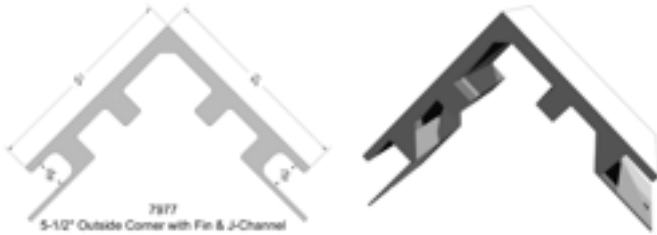

GENERAL INFORMATION

- Check local building codes before installation.
- Before proceeding, read all instructions for both Everlast siding and appropriate pocketed trim products.
- All pocketed trim used with Everlast siding must have a minimum pocket width of 3/4" and pocket depth of 5/8". The trim must be installed prior to installing Everlast siding.
- Do NOT install Everlast siding or Everlast trim in temperatures below 0° F.
- Inspect siding and trim for any breakage, foreign objects, surface defects, color consistency and correctness. Do NOT install questionable product.
- Use a fine tooth or vinyl saw blade to cut all material.
- Fasten material using an exterior grade nail or screw. (Recommended: galvanized/stainless/non-corrosive roofing nail or screw).
- Fasten trim through every other or every third nail hole, making sure the trim aesthetically looks good on the wall. Do not over drive the fastener--fastening too tight may cause distortion in the trim.
- To keep joints tight, it is recommended to use a PVC glue or plastic weld to bond together.
- Use a glue accelerator to speed up the cure time.

JOB SITE STORAGE

- Do NOT stack siding or trim more than 3 skids high.
- Do NOT store bundles in a vertical position.

BEST PRACTICE

- Siding or trim should be stored inside when possible.
- Always avoid storing in direct sunlight, product should be covered and protected prior to installation using a tarp and/or supplied shroud. Keep siding away from heat sources.
- When product is stored outside use wood (or equivalent) supports to avoid direct contact with the ground in conjunction with covering.

PREPARING WALLS

- Everlast siding and trim must be installed over flat and level exterior walls with either 16" or 24" on-center framing.
- Everlast siding serves as a rain screen, not a weather-resistant barrier. Therefore, it must be installed over a weather-resistant barrier.
- Properly flash around all windows, doors, rake boards, chimneys, and areas of transition between dissimilar materials.
- If installing over concrete block, poured concrete, or brick, siding must be installed over 1" x 3" furring strips.

BEST PRACTICE

If exterior walls are not flat or level, a quality underlayment should be installed first to create a flat and level surface.

COMMON APPLICATIONS

- Outside Corner Trim is typically used for 90° outside corners of the structure

LENGTHS

- 10' and 20'

COLOR

- Matte White

INSTRUCTIONS

1. Measure the height of the outside corner.
2. Cut the profile using a power saw with a fine tooth or PVC blade.
3. Fasten the outside corner to the wall using galvanized or corrosion resistant nails or screws approximately every 8" to 12" along the nail hem making sure the profiles are securely fastened using galvanized, stainless, or corrosion resistant nails or screws (Fig. 1).
4. While fastening, make sure the profile stays plumb by using a level or by line of sight.
5. In instances when the wall exceeds 10' or 20' and a second outside corner section must be installed, stack and butt the second piece to the first.
6. Recommended to use a PVC adhesive to join the two pieces or install 2 seam brackets and bracket screws inside the pocket of the outside corners to tie together (Fig. 2).

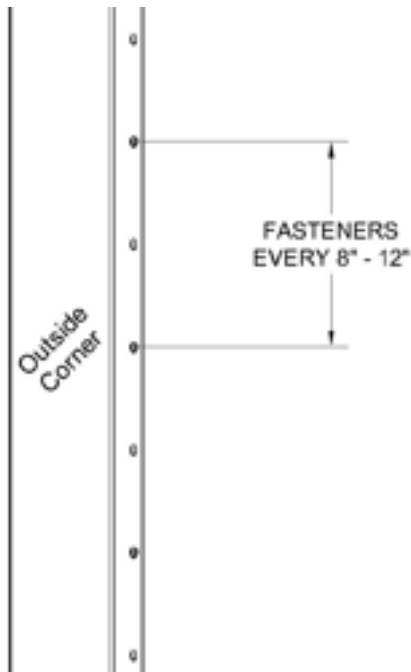

Fig. 1

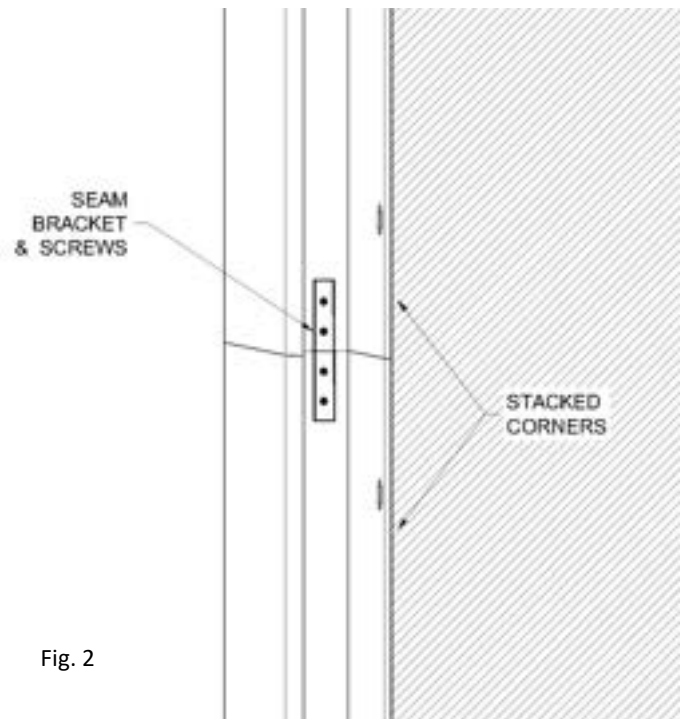
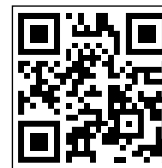

Fig. 2



For a video installation tutorial,
visit EverlastSiding.com/ProResources.



"T"-Moulding 6916 Options & Instruction Guide

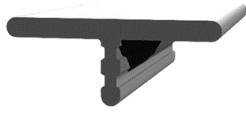

"T"-Moulding Part Number: 6916
2-3/4" Reveal



Trim Receiver Part Number: 6915

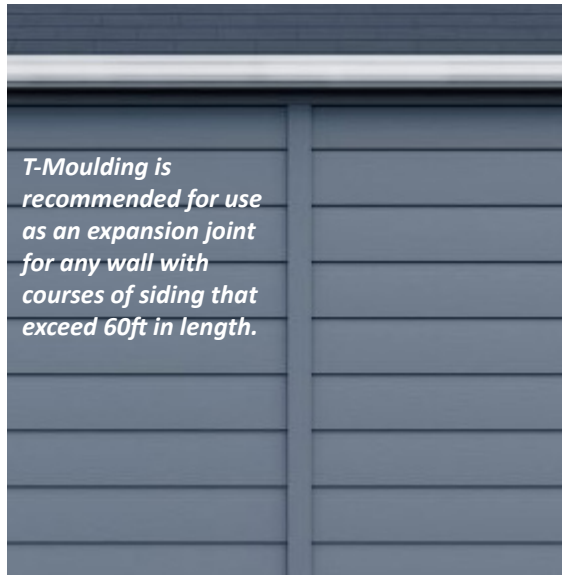

T-Moulding is recommended for use as an expansion joint for any wall with courses of siding that exceed 60ft in length.

Expansion Joint



Transition

GENERAL INFORMATION

- Check local building codes before installation.
- Before proceeding, read all instructions for both Everlast siding and appropriate pocketed trim products.
- Do NOT install Everlast siding or Everlast trim in temperatures below 0° F.
- Inspect siding and trim for any breakage, foreign objects, surface defects, color consistency and correctness. Do NOT install questionable product.
- Use a fine tooth or vinyl saw blade to cut all material.
- Fasten material using an exterior grade nail or screw. (Recommended: galvanized/stainless/non-corrosive roofing nail or screw).
- Fasten trim through every other or every third nail hole, making sure the trim aesthetically looks good on the wall. Do not over drive the fastener--fastening too tight may cause distortion in the trim.
- To keep miter and butt joint ends tight, it is recommended to use a PVC glue or plastic weld to bond together.
- Use a glue accelerator to speed up the cure time.

JOB SITE STORAGE

- Do NOT stack siding or trim more than 3 skids high.
- Do NOT store bundles in a vertical position.

BEST PRACTICE

- Siding or trim should be stored inside when possible.
- Always avoid storing in direct sunlight, product should be covered and protected prior to installation using a tarp and/or supplied shroud. Keep siding away from heat sources.
- When product is stored outside use wood (or equivalent) supports to avoid direct contact with the ground in conjunction with covering.

PREPARING WALLS

- Everlast siding and trim must be installed over flat and level exterior walls with either 16" or 24" on-center framing.
- Everlast siding serves as a rain screen, not a weather-resistant barrier. Therefore, it must be installed over a weather-resistant barrier.
- Properly flash around all windows, doors, rake boards, chimneys, and areas of transition between dissimilar materials.
- If installing over concrete block, poured concrete, or brick, siding must be installed over 1" x 3" furring strips.

BEST PRACTICE

If exterior walls are not flat or level, a quality underlayment should be installed first to create a flat and level surface.

COMMON APPLICATIONS

- "T"-Moulding 6916 is designed as a 2 piece system and must be used in conjunction with Everlast existing 6915 Trim Receiver (available length 12'-6", in all 15 Everlast colors).
- "T"-Moulding 6916 can be used in two applications, as follows:
 - Expansion Joint - for walls with continuous runs exceeding 60 ft. The "T"-Moulding would be used as a break on walls with long, continuous runs as an aid in managing expansion and contraction.
 - Transition - "T"-Moulding 6916 can also be used to transition from one profile to another on the same wall surface (example: Everlast horizontal panel to Board & Batten).

INSTRUCTIONS (EXPANSION JOINT)

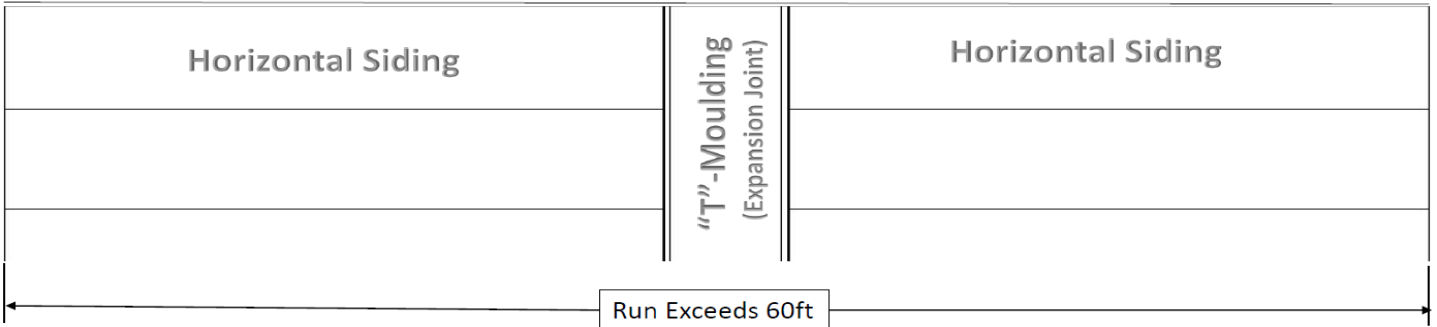

1. Install 6915 Trim Receiver 1st, prior to installing the siding (as you would with all trim).
2. Locate Trim Receiver 6915 near the center of the wall, square and fasten (Figure 2).
3. Install siding panels per installation guide.
 - *Always plan 1/4" gap between the end of the siding panel and termination points.
 - * Create a "T"-Moulding stop at the bottom of the "T"-Moulding (Figure 2).
4. Once siding panels are installed (both sides of the expansion joint), install the 6916 "T"-Moulding by snapping it into the Trim Receiver (Figure 1).

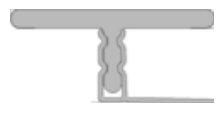

6915-6916 Figure 1

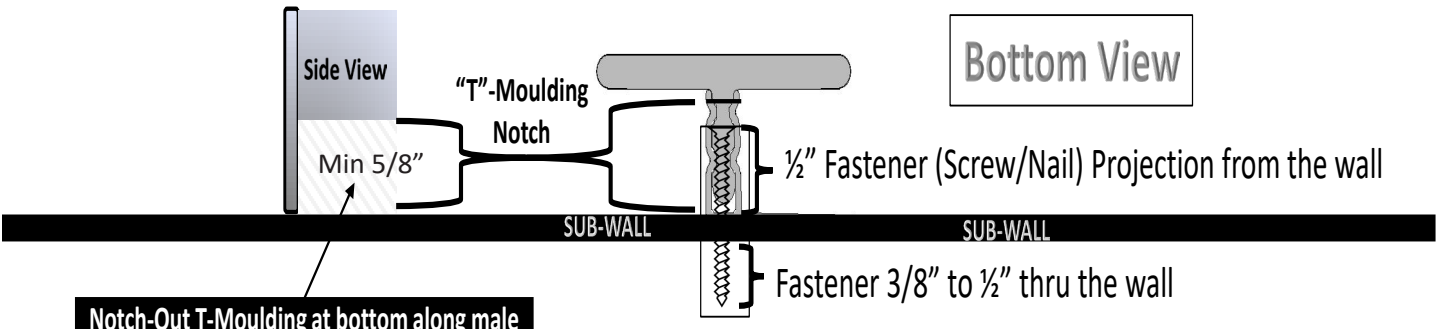
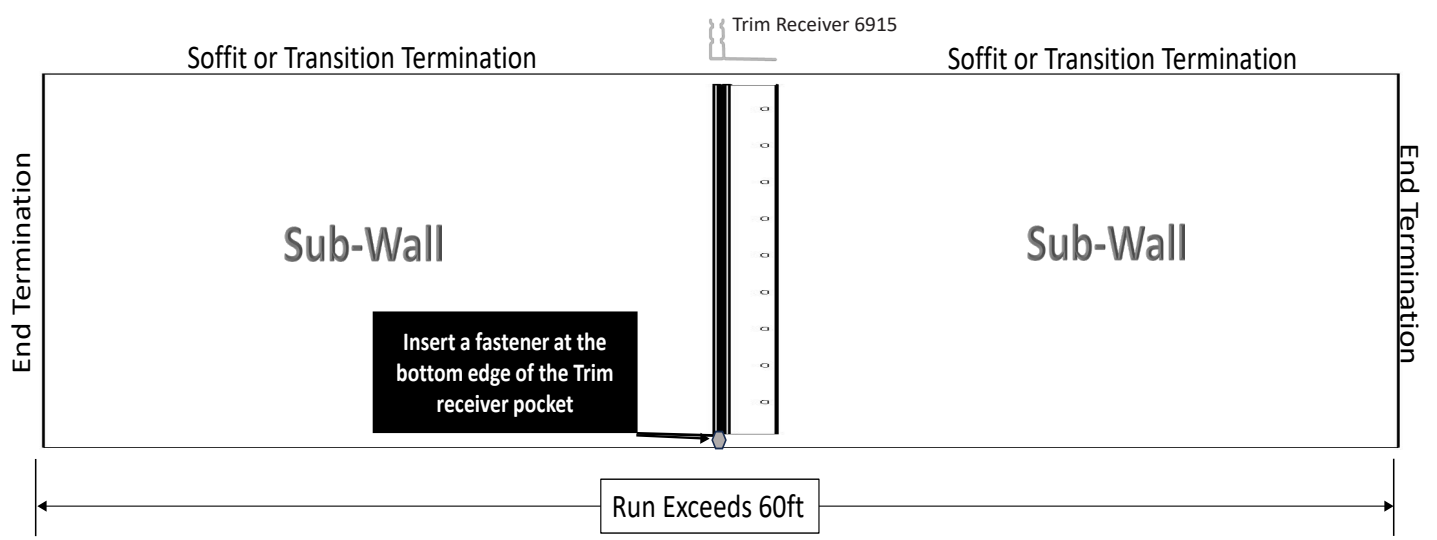

Notch-Out T-Moulding at bottom along male leg for stop fastener. Notch depth is based on preferred location of bottom edge

This will prevent the "T"-Moulding from moving downward.

Figure 2

INSTRUCTIONS (TRANSITION)

1. Install 6915 Trim Receiver 1st, prior to installing the siding (as you would with all trim).
 2. Locate Trim Receiver 6915 at the transition point of the wall with the nailing hem up, level, and fastened (Figure 4).
 3. Flash along Trim Receiver nailing hem for water management (as you would around Doors & Windows) (Figure 4). *For additional water management, you can add weep holes by drilling 3/16" - 1/8" holes along the inside channel of the "T"-Moulding ever 24"-36" apart (Figure 5).
 3. Install siding panels per installation guide.
- *Always refer to installation guide for proper gapping at all termination points.
4. Once siding panels are installed (both sides of the transition), install the 6916 "T"-Moulding by snapping it into the Trim Receiver (Figure 3).

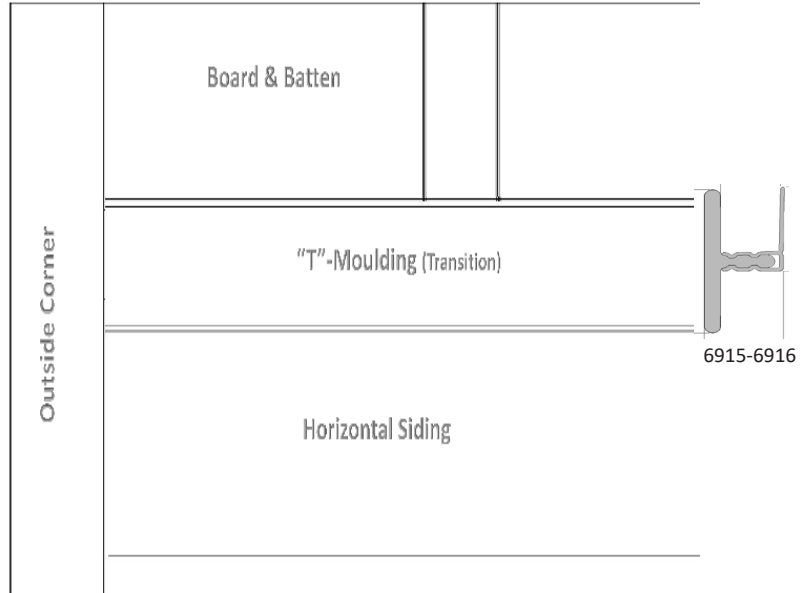

Figure 3

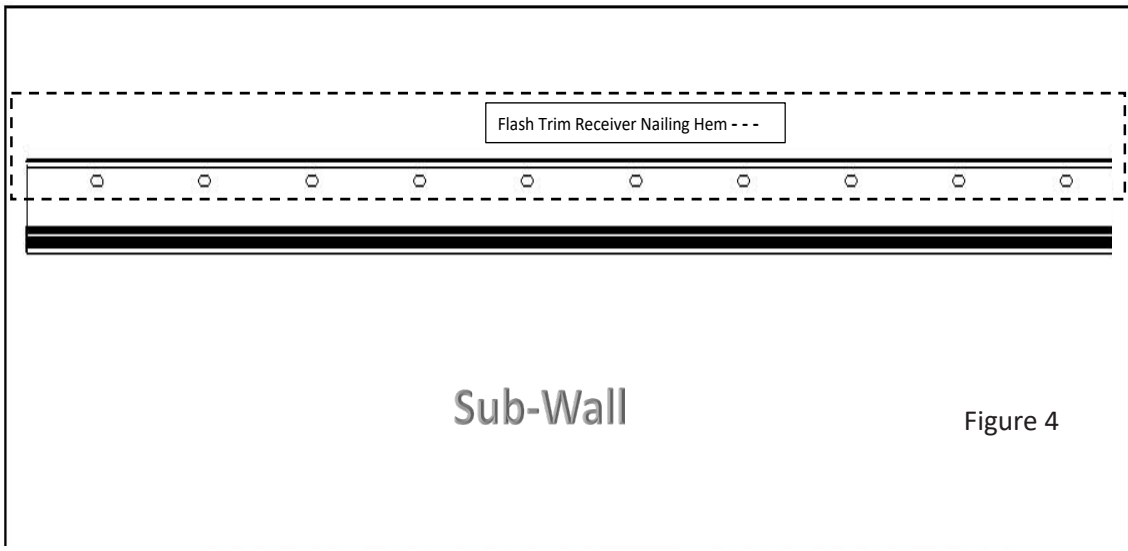

Figure 4

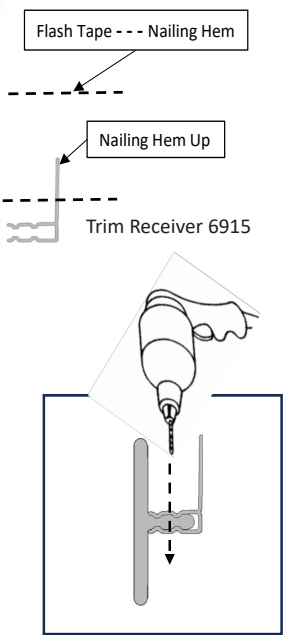



Figure 5

 For a video installation tutorial, visit EverlastSiding.com/ProResources.

