

OLIVER "Cletrac"

Model



GASOLINE
OR DIESEL
POWER



OLIVER "Cletrac" Model "A" WILL...

CUT COSTS. The Model A Oliver "Cletrac" incorporates a balanced design that eliminates dead weight and increases actual capacity. This saves fuel, decreases wear and tear and so cuts maintenance costs. Yet, the large track area and many grousers provide positive traction in mud, sand, rock, clay—uphill and down! With higher protected clearance and Tru-Traction you get your work done when you want it done, and put more money in your pocket.

SAVE TIME. Developing better than 80 per cent of its weight in drawbar pull, the Model A Oliver "Cletrac" does more work in less time. It keeps work up to schedule, eliminates overtime and extra crews, saves labor costs and gives you a larger profit. With ground pressure of approximately 5 pounds to the square inch—less than that of a man walking—the Model A is always ready to go . . . ready to handle your jobs in mud and soft fills . . . ready to put more money in your pocket.

OLIVER "Cletrac" *Tru-Traction** TRACTORS

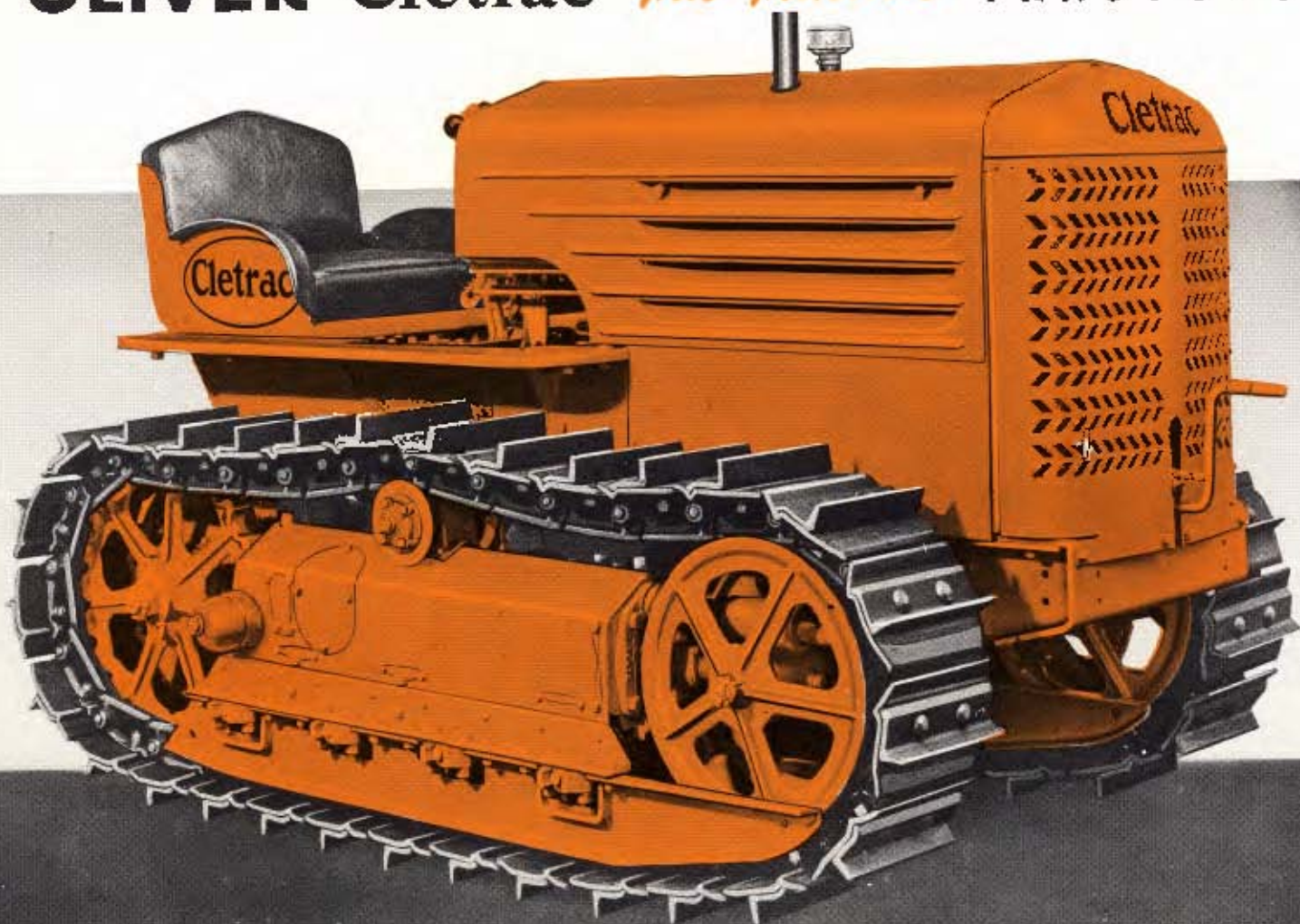

MODEL "A" GASOLINE - 30.6 D. B. HP. - 38.8 BELT HP.

MODEL "A" DIESEL - 30.5 D. B. HP. - 38 BELT HP.

* *Tru-Traction* IS POWER ON BOTH

INCREASE CAPACITY. Tru-Traction Steering, an exclusive Oliver "Cletrac" feature, makes the Model A easy to handle, extremely maneuverable. Both tracks pull *all the time*, whether on turns or straight-aways. Oliver "Cletracs" *roll* around curves instead of twisting, thus consuming less power to turn and applying more power at the drawbar.

Oliver "Cletracs" handle "off center" loads, such as ditching, trail building, widening the cut in snow removal, without twisting and whipping. Your operator has perfect control at all times and does a better all-around job. Only Oliver "Cletrac" offers Tru-Traction steering.

- Thousands of farmers, orchardists, contractors, highway officials know the economy, the dependability, the "built to take it" construction of the Model A Oliver "Cletrac".
- The Model A has the capacity to pull a four-bottom plow in many soils, three-bottoms in practically any condition, a 10' double-action disc, a 16-foot combine.
- On the industrial job, this same horsepower handles trail-building and bulldozing jobs, a 7- or 8-foot blade in light road construction and maintenance, pulls tubing, or bales medium depth oil and gas wells.
- Check the Model A yourself... its sturdy main frame and track frame construction... the sound engineering of its exclusive steering... its perfectly balanced design... its V-Groove drop-forged track shoes with replaceable grousers or cleats.
- Get up on the seat and drive it... experience for yourself its remarkable ease of operation... its finger tip control... its responsiveness to every operating requirement... the ample leg room... the visibility... the comfort of its upholstered seat.
- There's good reason why an ever-increasing amount of the world's work is done with Oliver "Cletracs".

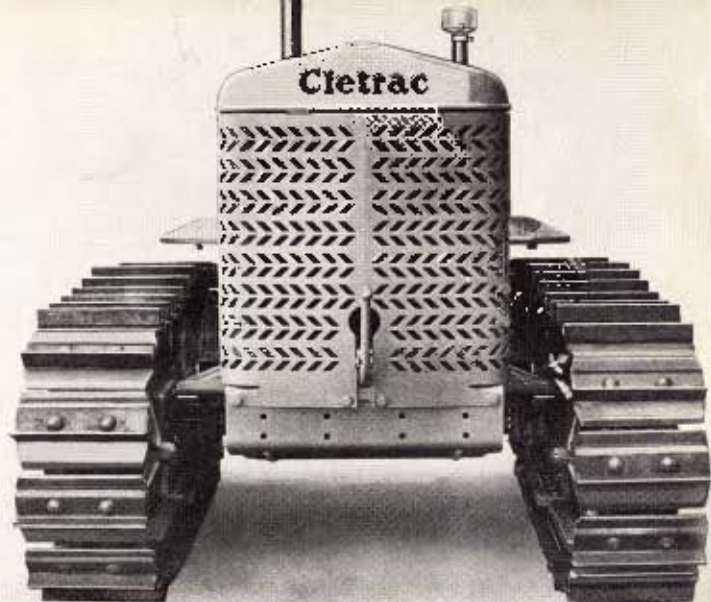

WIDE GAUGE MODEL Both the standard model and wide model are fully equipped ready for your toughest job. There are no extras to buy—hood panels, steel radiator guard and crankcase guard—all standard equipment on the Model A Oliver "Cletrac."

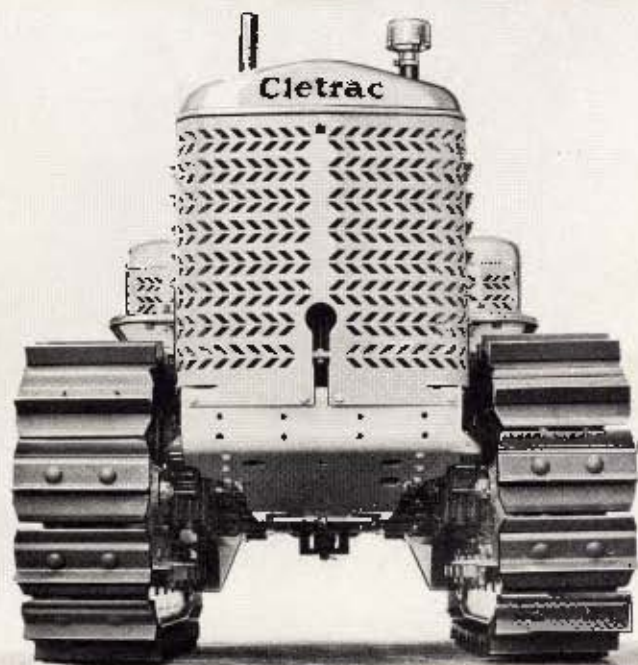

STANDARD MODEL Oliver "Cletrac" is known the world over for economy, dependability and the ability to "take it", regardless of operating conditions. Made in two widths, the standard model (AG and AD) has 42-inch track centers and the hillside model (AGH and ADH) has 50-inch track centers.

LOGGERS SPECIAL The Model A is also built for heavy duty use in the woods. The Model A Loggers Special is equipped with a detachable crank, integral combination crankcase and bellhousing guard, heavy duty lower track wheels, track wheel rock guards, special rear drive sprockets, 48-inch heavy duty forestry type bumper, front pull hook and heavy duty springs.

TRACKS AT ALL TIMES

"Satisfied Users"



THE WORLD OVER!"



Modern Design

THE ROLLER CHAIN

Shown at left is a section of a roller chain—the easiest running chain that has ever been developed and perfected. The roller chain incorporates rollers. That's why it is easier running and wears longer. The roller is free to turn on the bushing and more bearing area gives longer life. Oliver uses this principle in the Model A "Cletrac" tracks.



OLIVER "Cletrac"
TRACKS ARE BUILT LIKE
A ROLLER CHAIN

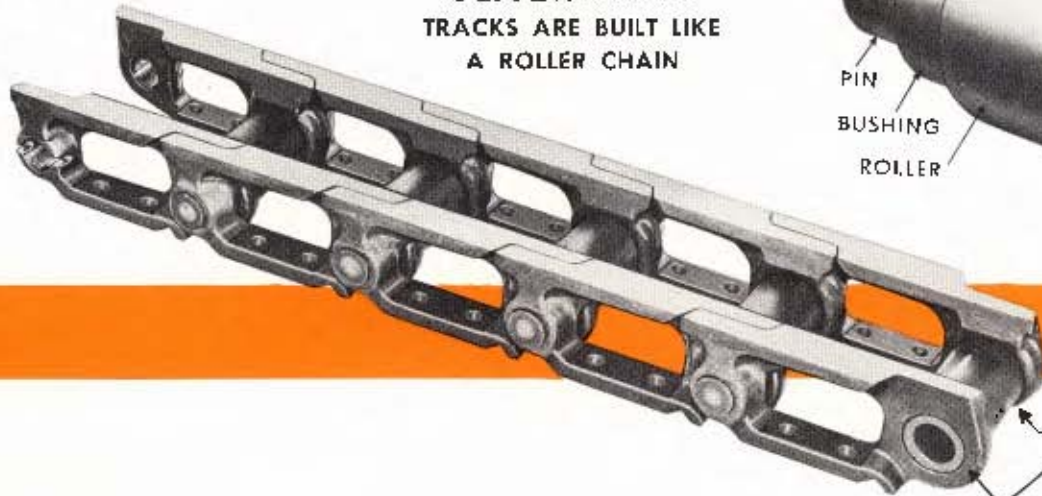

OLIVER "Cletrac" TRACKS

The Model A track is made up of 29 V-groove forged shoes, assembled with pins, bushings and rollers just like a roller chain. This type of construction provides greater bearing surface, greatly reduces wear and increases operating life.

The track shoes are forged from metal especially heat-treated for long life. Side rails, where they contact the track wheels, are hardened to resist wear; they are machined both top and bottom to provide a flat surface for bolting grouser plates on top, and to provide a continuous smooth surface for the lower track wheels on the bottom. The face of the shoes is toughened to resist shocks and strains. This toughening treatment is carried out in especially designed furnace equipment under precise control. The track pin holes in track rails, and the grouser bolt holes are drilled while the shoe is rigidly held

in a jig fixture. This assures perfect alignment of track parts when assembling the tracks.

The accurate machining of Oliver "Cletrac" tracks results in a sturdier track, more positive traction, less weaving between parts and much longer life for both track and track wheels. Any suitable grouser may be attached directly to the track shoe. The grousers bolt securely into a deep V-groove which is machined in each track shoe; strains on the grousers are transmitted directly to the track shoe by the V-groove feature, thus eliminating shearing strains on the bolts.

Track shoe pins, bushings and rollers are Tocco hardened . . . a form of heat treatment which gives uniformly hard, long-wearing surfaces backed up by a tough shock-resistant core. The track pins have a shoulder at one end which insures a perfect fit into the track shoe and simplifies replacements.

V-GROOVE

Track Shoe

Sturdy construction and accurate machining of V-groove track shoes used in the Oliver Model A "Cletrac" tracks is typical of advanced engineering used throughout the tractor.

Side rails are forged from alloy steel, heat-treated for strength. Surfaces which contact the track wheels are especially hardened to resist wear. Side rails of the track are machined, both top and bottom, to give a perfectly flat surface for bolting on grouser plates and to provide a continuous smooth surface for the lower track wheels.

A deep V-groove is machined in the top of each side rail and each grouser plate is formed to lock securely into this V-groove, fitting perfectly. Grouser plates are held securely to the track by four heat-treated alloy steel bolts, but strain of traction is taken by the V-groove in the track shoe. The grousers are designed to give a spring lock when bolted in place.



GROUSERS BUILT FOR *Traction!*

- No. 1. Square Corner Dirt Grouser, 12 inches wide. Standard equipment. Also available 14 and 16 inches wide.*
- No. 2. Ice Grouser (Used with or without plate.)
- No. 3. Pressed Steel Pavement Grouser, 12 inches wide. (Used with or without plate.)
- No. 4. Pressed Steel Street Plate, used with Dirt Grouser (Fits over Dirt Grouser.) Furnished for alternate shoes or all shoes.
- No. 5. Cast Steel Pavement Grouser, 11 inches wide.
- No. 6. Beveled Corner Dirt Grouser, 12 inches wide. Also available 14 and 16 inches wide.*
- No. 7. Rubber Block.
- No. 8. Standard Grouser Plate, 12 inches wide. Also available 14-16 and 18 inches wide.*
- No. 9. Cut-out Plate (Used with Ice or Dirt Grouser) 12 inches wide. Also available 14 inches wide.*
- No. 10. Combination Grouser and Plate, 20 inches wide.* Also available 18 inches wide.*

*Plates and grousers over 14 inches available for hillside models only.

Wood blocks and special grousers not shown here can be furnished as special equipment. See price list for full details on plates and grousers.



A CRAWLER DESIGN

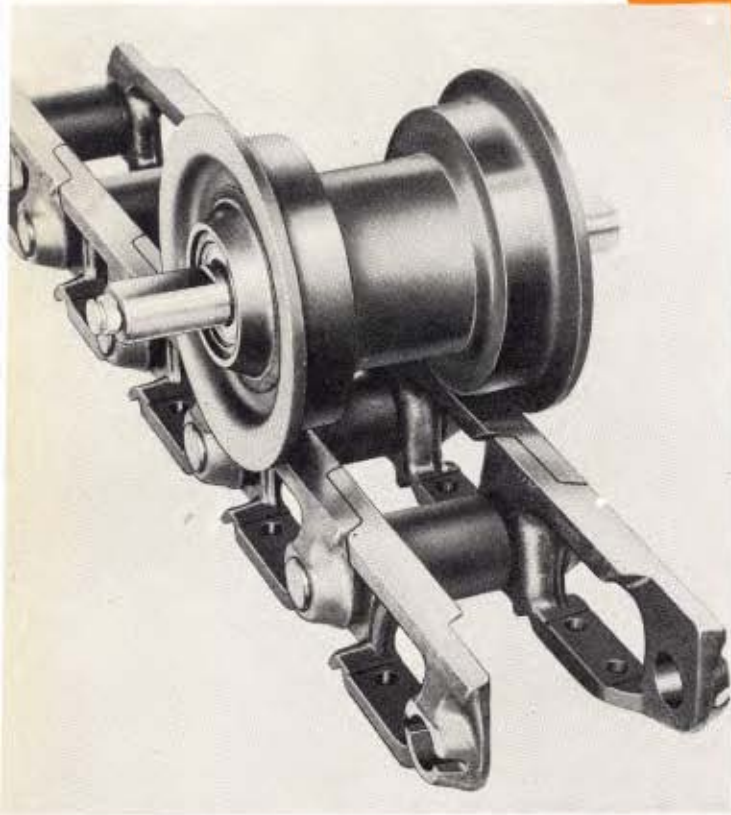

Track rails are wide apart for maximum traction from SIDE to SIDE

Track rails are wide apart so that the weight of the tractor is spread over a wider area from side to side. The Oliver "Cletrac" is solidly supported— not balanced— on the track. The front idler wheels are also wide-spread so that the track is accurately guided and cannot weave or twist. A minimum part of the track projects beyond the rails, so that twisting strains produced by running over rocks or uneven ground are minimized. This is one reason why the Oliver "Cletrac" is able to step lightly over soft soils . . . to give a maximum of positive traction when the ground is hard and the load heavy . . . to combine positive traction with lightness in weight and so develop better than 80 per cent of its weight in drawbar pull.

Every GROUSER PENETRATES FOR PERFECT TRACTION

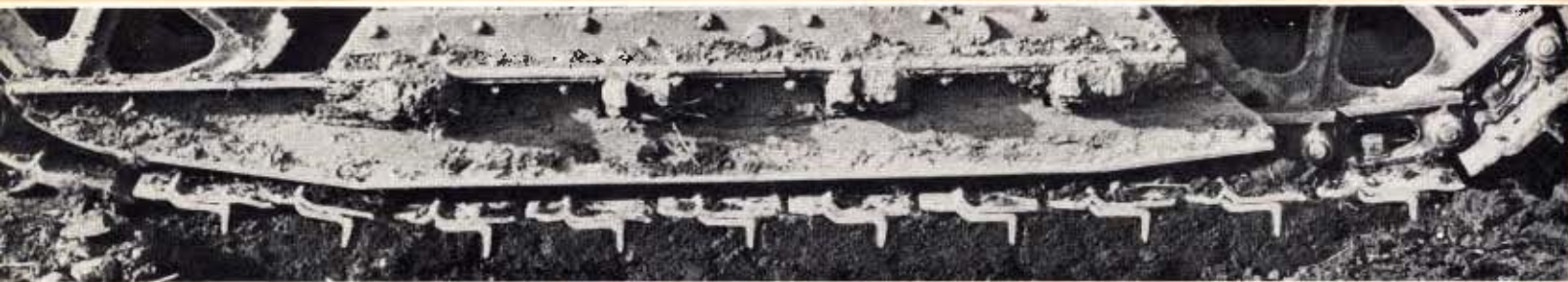

This photograph shows how the Oliver "Cletrac" digs in to deliver extra horsepower at the drawbar! The correct number of lower track wheels and the proper length of track shoes hold the entire track in contact with the ground from front to rear. The result is that the Oliver "Cletrac" has the positive traction you need in getting in and out of tough spots . . . traction to pull maximum loads on hills . . . traction to get the production that keeps difficult jobs up to schedule.

There are no leading grousers on the bottom of an Oliver "Cletrac." Every grouser bites into the soil and hangs on! The grousers are so designed and spaced that they penetrate without "working" the soil. There is no tendency to decrease the shearing resistance of the soil. Every grouser digs into the ground, to use every possible ounce of engine power—without depending upon extra or "dead weight" for traction.

THAT'S BUILT FOR *Traction*

Lower track wheels that really take the side thrust

*DIRT stays out
OIL stays in*

Keeping dirt out and lubrication in is the secret of long life in crawler tractor lower track wheels. The construction of the Oliver "Cletrac" lower track wheels really keeps dirt out, keeps oil in and greatly increases the life of the wheels. Each end of the wheel bearing is fitted with a *double* Dirt-Oil Seal, an exclusive feature on the Oliver "Cletrac." One part of this seal is a barrel-flanged leather packing with a contracting phosphor-bronze coil spring which fits on the curve of the flange. The tension of this spring holds the taper edge of the leather packing in snug contact with the shaft. Then there is an additional leather seal. This *Double Seal* is built as a special unit with the outer cover crimped over, thus enclosing the entire assembly in a fixed unit for a close press-fit into the retainer. It is a permanent, more positive way of keeping dirt out and

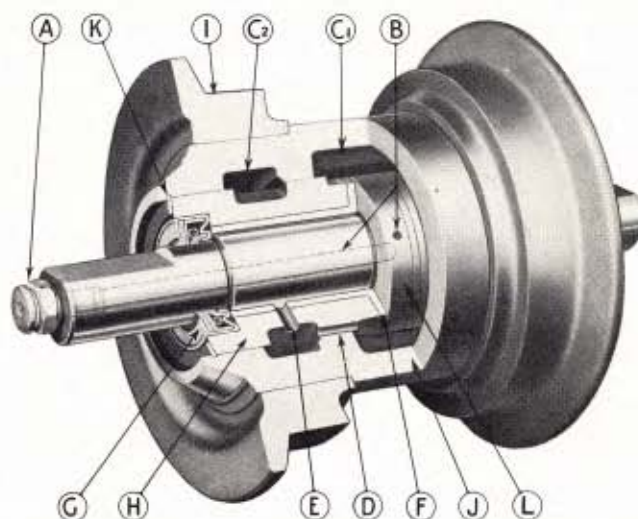

- A Oil Filling
- B Oil passage from filling "A" to reservoirs "C1" and "C2"
- C "C1", "C2" Oil Reservoirs
- D Oil passage from "C1" to "C2"
- E Oil passages to the bronze bushings and shaft
- F Bronze bushing
- G Dirt and oil seal
- H Bearing retainer
- I Lower track wheel
- J Lower track wheel hub
- K Oil seal retainer ring
- L Center end thrust control flange

oil in, than the customary less expensive, single, flat or split cork seals.

There is no end thrust against the oil-seal bearing retainer or against any portion of the bearing. Protecting these seals from end thrust when working on side hills and when turning is the Oliver "Cletrac" center end thrust control . . . a heavy flange in the center of the wheel shaft which operates against two flanged, removable bronze bushings and prevents end play.

Cletrac lower track wheels are drop-forged steel, hardened and shrunk on the hub. Each track wheel is individually lubricated.

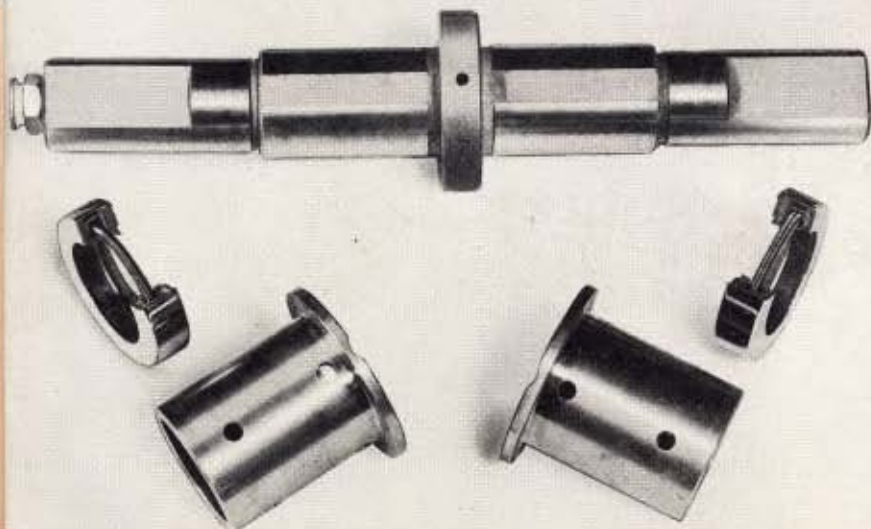

LOWER TRACK WHEEL SHAFT

The lower wheel shaft is especially selected steel, carburized, hardened and ground. The upper, or the low pressure side, is milled flat. This provides for proper distribution of the oil along the entire length of the shaft and bearing.

The bushings are of special alloy bronze, wear resistant and with carefully controlled bearing qualities. These bushings are individually replaceable so that when wear occurs they may be easily and inexpensively replaced.

THERE'S *Strength * Ruggedness* IN OLIVER "Cletrac" MAIN FRAME

OLIVER "Cletracs" are designed and built to withstand these severe

SHOCKS

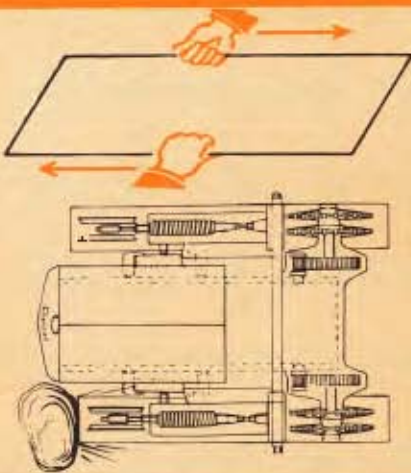

Shocks and wracking caused by an Oliver "Cletrac" hitting obstructions or making a short turn is not transmitted to the final drive sprocket or to any of the gears or shafts. This is because there is no connection between the drive sprocket and the track frame.

The track frame of the Oliver "Cletrac" facilitates on a heavy, fixed track frame shaft. Shocks caused by hitting an obstruction are cushioned by an enclosed, protected buffer spring which encircles the front wheel shaft and works against the stationary track frame shaft. It absorbs shocks, prevents damage.



STRAINS

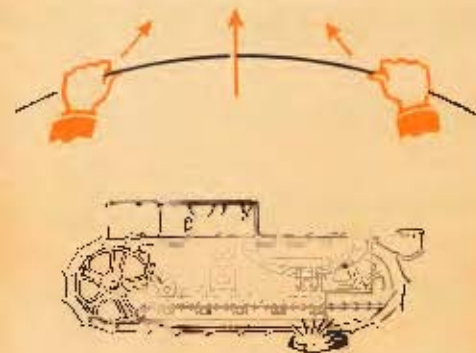

Strains of operation never reach the transmission case or engine of the Oliver "Cletrac." The engine is carried by a heavy, rolled one-piece steel frame which rests on two longitudinal springs properly tapered and free moving in spring brackets one on each side of the frame. The engine is set down in this frame, which is supported and carried on springs at four points. This general design relieves the engine and transmission case of harmful, damaging strain caused by operating the tractor over uneven ground.

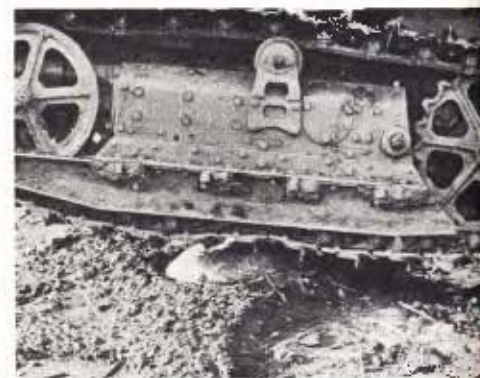

TWISTS

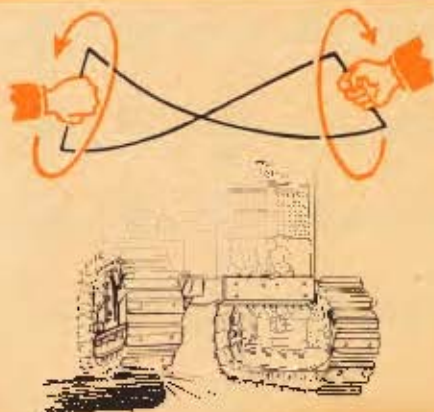

Any twists that may be set up by the up-and-down oscillating motion of the tractor when in operation are minimized in the Oliver "Cletrac" by the two heavy horizontal springs. The engine bell housing is bolted to the transmission case, and the front end of the engine is mounted in a transom. Should any twists or strains reach the frame, they are not passed on to the engine. This safeguards the alignment of main bearings, crankshaft, pistons and connecting rods.



★ Long Life

and TRACK FRAME CONSTRUCTION

The Main Frame

The main frame on an Oliver "Cletrac" - shaped and riveted into one piece - forms a sturdy backbone for the entire tractor. The motor rests in the forward part of the frame, while the rear part of the frame extends well back on the transmission

case to which it is attached by heavy heat-treated cap-screws. Engine and transmission case are thus held solidly in perfect alignment.

The main frame is supported in front by two heavy longitudinal springs - one on each side - attached to trunnions mounted on the track frames. Construction of the Oliver "Cletrac" main frame provides a guard for

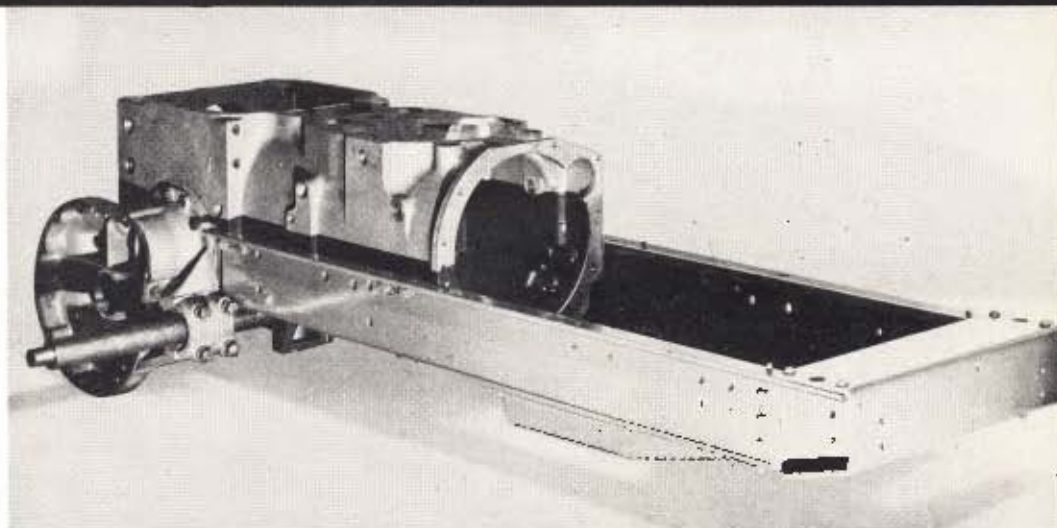

the engine crankcase, protecting it against breakage. This guard is readily removed when necessary. The front end of the frame provides an excellent flat surface and support for mounting equipment. Construction of the main frame also makes it possible for equipment to be mounted on Oliver "Cletracs" in such a way that undue strains are not placed on any part of the tractor.

The Track Frame

The track frames of the Oliver "Cletrac," like the main frame, are of unusually strong construction. They are built of heavy U-shaped rolled steel into which the ends are welded, giving *one-piece* construction. A heavy channel at the base of the track frame provides a strong and rigid foundation for mounting the lower track wheels and guards. Drop-forged steel brackets are inserted between these channels; bolts extend completely through the brackets, channels and track frames, giving an exceptionally stiff, rigid and well-braced track frame.

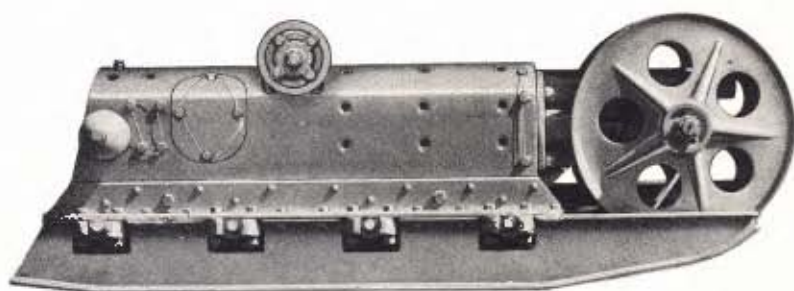

Cletrac
Tru-Traction Tractors

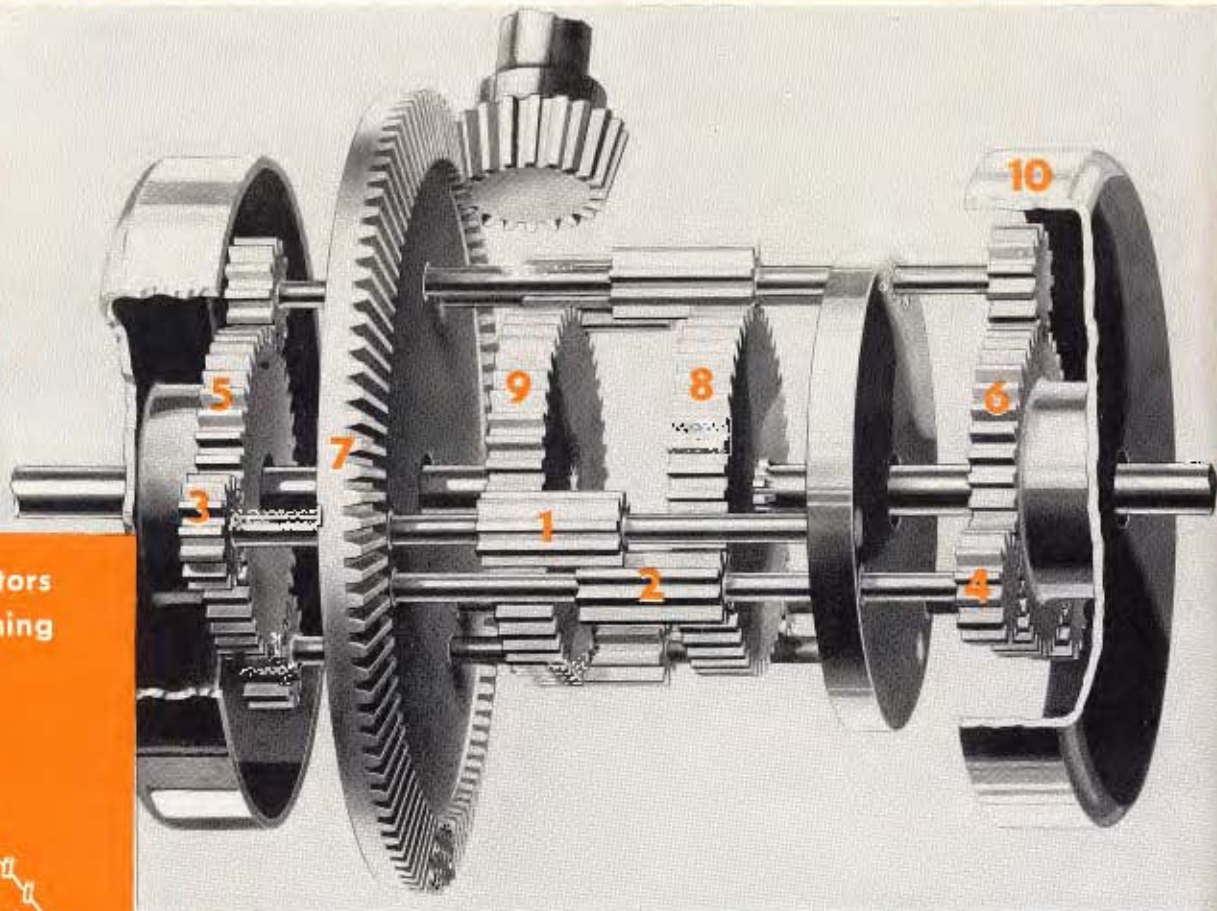

Clutch Steering Tractors
Zig-Zag when turning

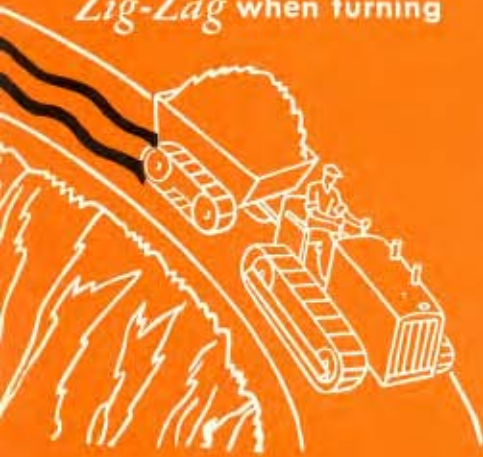

Oliver "Cletracs" are safer traveling downhill with a heavy load pushing the tractor. They always steer the same. With ordinary crawler construction and with a heavy load going downhill, it is necessary to steer in the opposite direction--to pull on the left lever to turn right and on the right lever to turn left. The reason is that the engaged track acts as a brake. The load tends to swing the tractor in the easiest direction against the disengaged track. Because Oliver "Cletracs" have Tru-Traction (power on both tracks at all times), they steer the same going downhill under a heavy load as going uphill.

OLIVER "Cletracs" pull on both tracks when turning . . . and turn on a true course under *Control*



**HERE IS WHY
ONLY OLIVER "Cletracs"
HAVE TRU-TRACTION**

Both Tracks Pull at All Times

The diagrammatic view of the differential assembly above illustrates the fundamental principles of Oliver "Cletracs" Controlled Differential Steering which effects Tru-Traction.

When the tractor is going straight ahead, the whole differential assembly driven by the bevel gear No. 7 rotates as a unit without any internal motion. Now let's see what happens when we wish to make a turn to the right. A pull on the right control lever holds stationary the right steering drum No. 10 and the drum gear No. 6 which are fastened together and which rotate on a bronze bushing on their shaft. As a consequence, pinion gear No. 4 and differential gear No. 2, which are connected to bevel gear No. 7 by means of shafts, begin to turn forward. Final drive gear No. 8 is slowed down because No. 2 gear is turning and rotating in the same direction. At the same time, differential gear No. 1, rotating around the final drive gear No. 9 in the opposite direction, is speeded up.

In turning an Oliver "Cletrac" there is no disconnection of power to either track . . . no jerking, no twisting, but smooth, even turning with power delivered to both tracks at all times. This is an exclusive feature used in all Oliver "Cletrac" tractors.

The entire differential assembly runs in a bath of oil at all times to keep wear at an absolute minimum.

OLIVER "Cletrac"

Tru-Traction

STEERING

GIVES » »

● POWER ON BOTH TRACKS ON TURNS

Controlled differential steering is an exclusive Oliver "Cletrac" feature and is used in all Oliver "Cletrac" models. It is the secret of the remarkable ease of handling . . . the positive control . . . and the greater safety on hills and grades which the Oliver "Cletrac" possesses. With this form of steering, there is no "declutching" or "braking." Instead, the tractor turns in much the same way as a team of horses. On a turn the inside track slows down; in effect, drops into a lower gear. The outside track speeds up, or slips into a higher gear. The result is that both tracks are under power at all times, and bigger loads are handled and turned with ease.

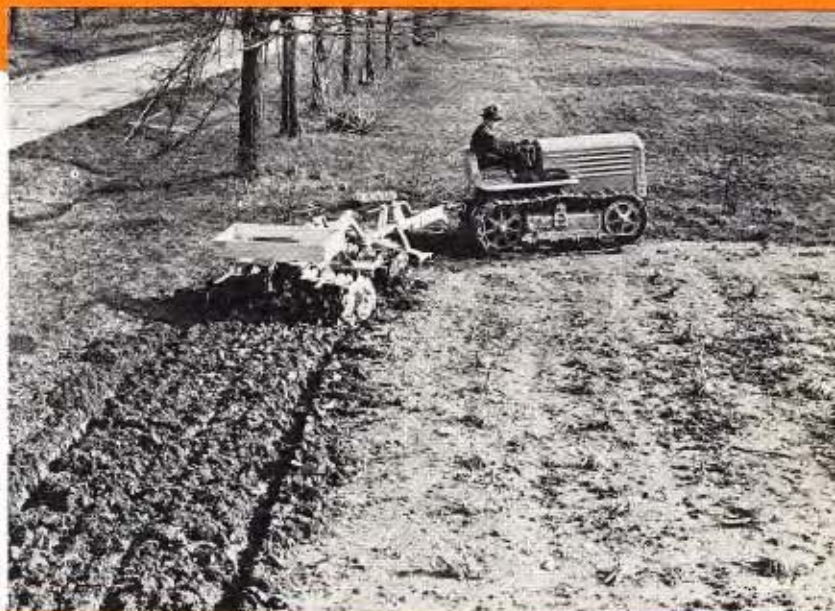

● SMOOTH, EVEN STEERING

Oliver "Cletracs" roll around on a turn, not jerk around. They roll over rocks, stumps, roots and other obstructions instead of twisting and sliding the tracks under and against obstructions. Consequently, Oliver "Cletracs" consume less power in turning and there is more power available to handle the load. Easier turning also reduces strain on the track frames; this means longer operating life, less trouble, fewer shocks and strains and less difficulty with track alignment.



● SHORTER STEERING RADIUS

Oliver "Cletracs" move gradually around the curve when turning instead of zig-zagging in a series of stops and starts. The result is shorter turns with larger loads. The shortness of an Oliver "Cletrac" turn is limited only by the drawn equipment. The illustration at right shows how short the Oliver "Cletrac" can turn. Notice how smooth and even the turn is. Of course, drawn equipment would obstruct the track if turned this short.



HERE'S THE FINAL DRIVE That gives **OLIVER "Cletrac" UNSURPASSED DURABILITY**

More Years of Trouble-Free Service

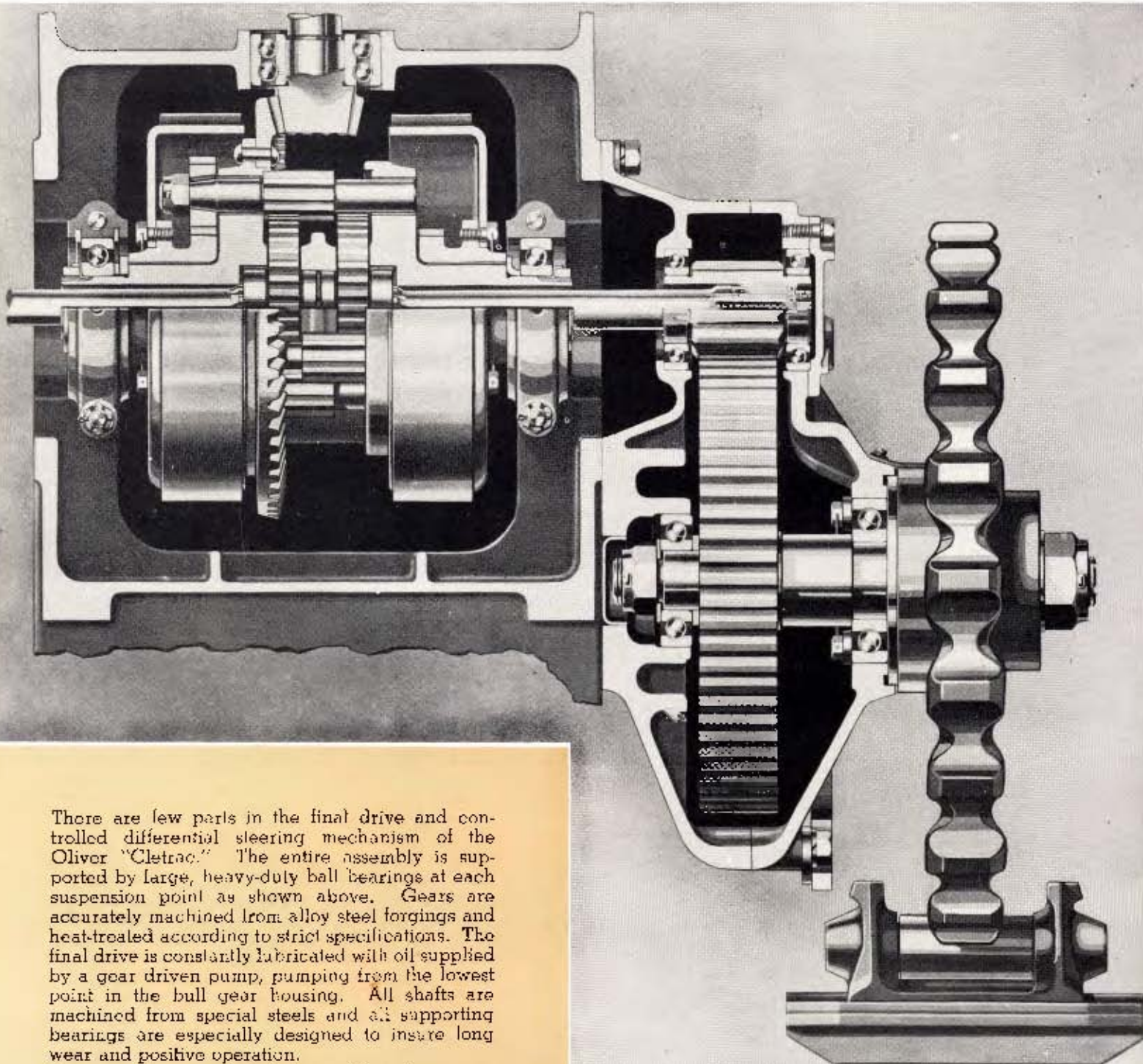

There are few parts in the final drive and controlled differential steering mechanism of the Oliver "Cletrac." The entire assembly is supported by large, heavy-duty ball bearings at each suspension point as shown above. Gears are accurately machined from alloy steel forgings and heat-treated according to strict specifications. The final drive is constantly lubricated with oil supplied by a gear driven pump, pumping from the lowest point in the bull gear housing. All shafts are machined from special steels and all supporting bearings are especially designed to insure long wear and positive operation.

The assembly is perfectly balanced, free from overhanging shafts or gears. In short, it is built for long life.

There's strength, ruggedness and long life in the final drive of an Oliver "Cletrac" crawler. Transmission, differential, and final drives all work in a common bath of oil.

THE OLIVER "Cletrac" GASOLINE 6-CYLINDER ENGINE

STURDY
SMOOTH
INCREASED
POWER

The 6-cylinder engine in the Model AG has a $3\frac{1}{16}$ inch bore and a $4\frac{3}{4}$ inch stroke, with force-feed lubrication, and is triple-sealed against harmful dust and dirt. An auxiliary air cleaner and an oil-wash air cleaner are used on the air intake system. An oil-saturated breather cap is used on the crankcase oil filler pipe in the crankcase breather.

A large capacity oil filter insures clean oil in the crankcase. Water pump is belt driven and the fan belt is accessible and easily adjusted. A thermostat aids in warm-up and then keeps the engine at its most efficient operating temperature. The carburetor is designed for economy and uniform performance. An efficient fuel pump insures a constant flow of fuel at all working angles. This eliminates the necessity of fuel pumps. The governor control is sensitive to all load changes, and gives you smooth, even power. Crankcase ventilation is provided by a copper tube leading from the valve tappet cage to the intake manifold, thus removing gases and vapor from the crankcase and assuring a clean crankcase at all times.

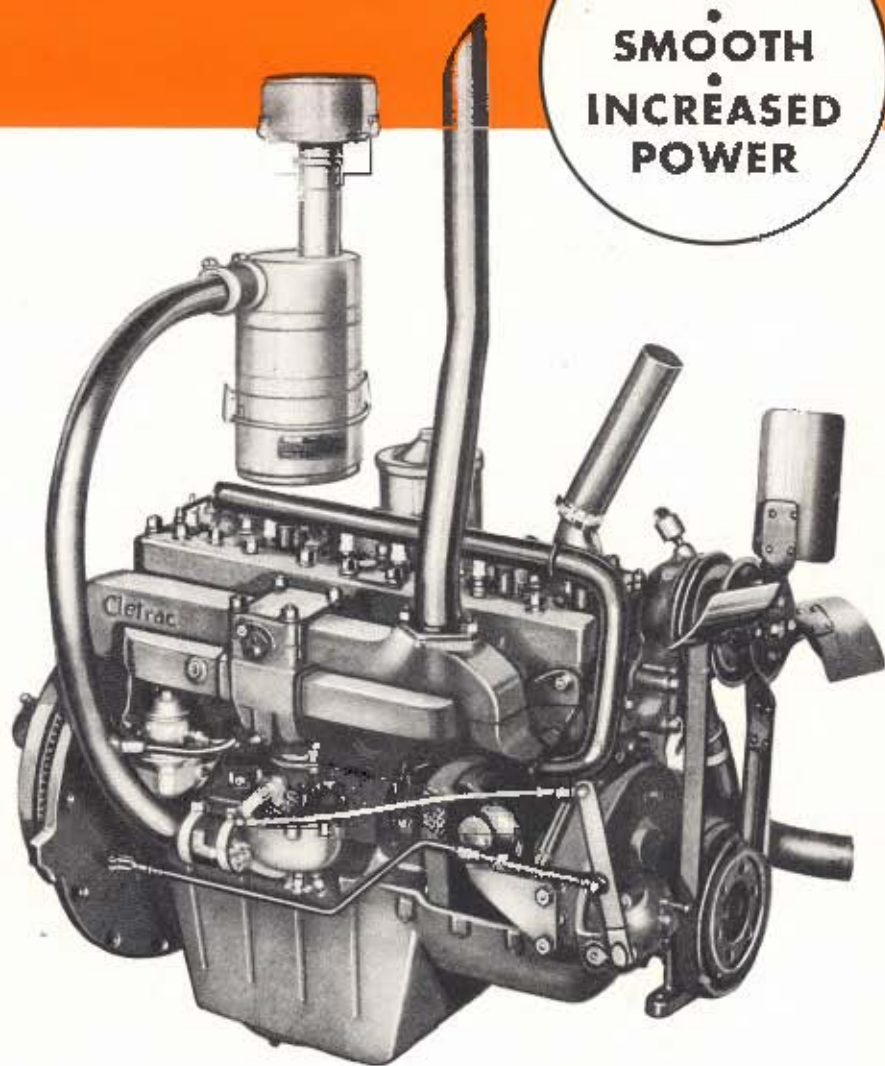

CRANKSHAFT The crankshaft in the Model AG is accurately machined, heat-treated and partially balanced, both dynamically and statically, on a Gisholt balancing machine. It is supported by four main bearings with a total bearing area of almost 45 square inches. End thrust is taken at the front main bearing. The ruggedness of the crankshaft combined with force-feed lubrication insures long life.

GOVERNOR The governor on the Cletrac engine is of the fly-ball type, completely enclosed and automatically lubricated. It is extremely sensitive and responds instantly to any variation in the engine speed.

VALVES The valves are forged in one piece from special alloy steel which offers unusual resistance to burning and oxidation. Both exhaust and intake valves are provided with removable guides. The valve seats are completely surrounded with water, assuring uniform cooling of the valves and longer valve life.

CYLINDER BLOCK Crankcase and cylinder blocks are cast in one piece of special iron for long wear. Unified construction provides the necessary support to the crankshaft, prevents whipping and vibration and assures permanent alignment between the cylinder bores and crankshaft. Water jackets extend full length of cylinder barrels.

Here's the **OLIVER**

STURDY • ECONOMICAL

With its four cylinders, five main bearings, full pressure lubricating system, removable cylinder sleeves, fuel filters, electric starting, progressive turbulence, controlled combustion and reasonable maximum pressures, the engine in the Model AD Oliver "Cletrac" is a highly efficient, economical unit.

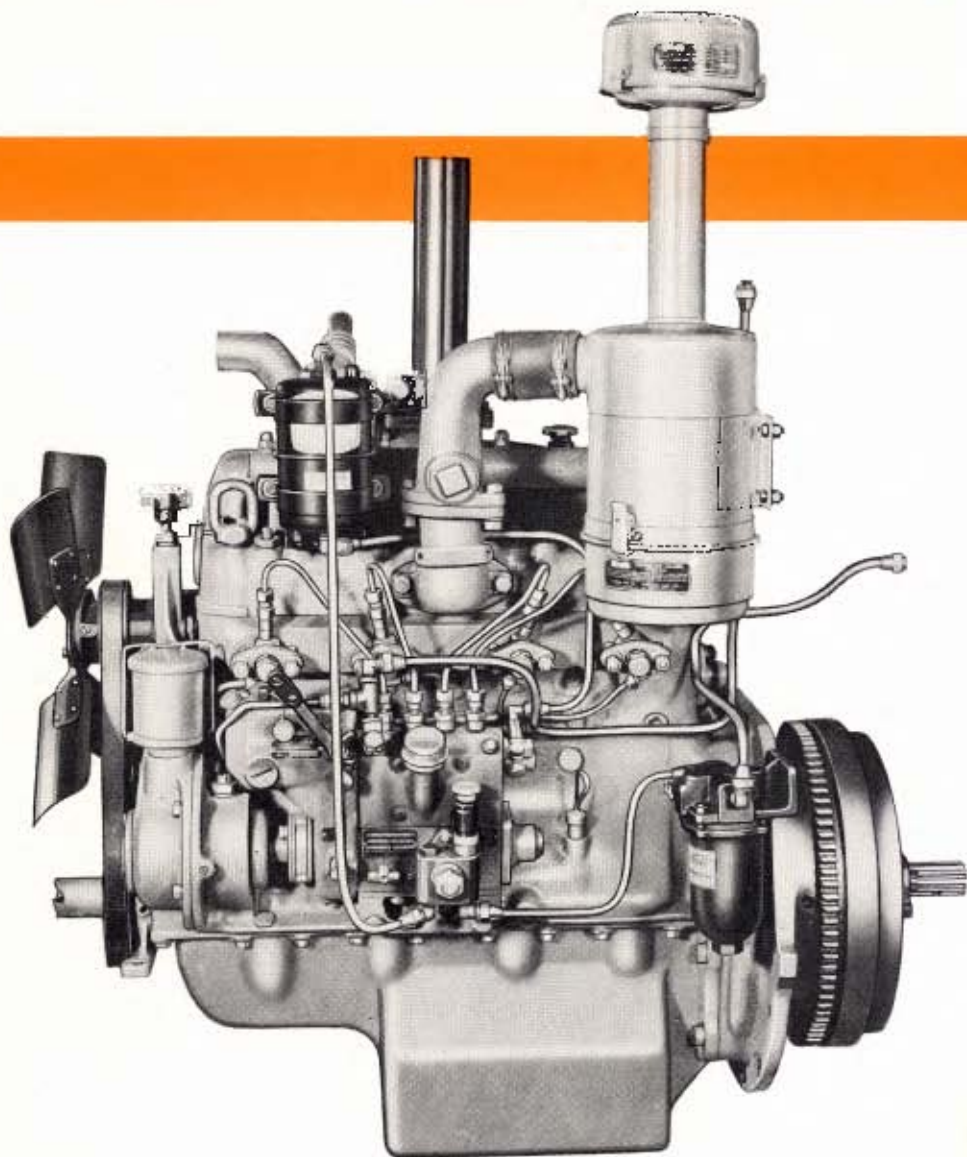

The Model AD Cletrac has a four-cylinder Diesel engine with a 4-inch bore and 4 $\frac{1}{2}$ -inch stroke, with a complete force-foed lubrication system to all connecting rods, main bearings, piston pins and rocker arm bearings. It is triple sealed against harmful dust and dirt by an auxiliary air cleaner and an oil bath air cleaner on the air intake and an oil saturated air

cleaner in the crankcase breather. Large capacity dual oil filters insure clean oil in the crankcase. Four different fuel filters assure clean fuel for the fuel injection system. Water pump is gear driven and the fan belt is accessible and easily adjusted. The governor control is sensitive to all load changes, and gives you smooth, even power.

"Cletrac" Diesel Engine

• DEPENDABLE

TURBULENCE. "A cyclone in a cylinder head" is an apt description of the turbulence which takes place in the Oliver "Cletrac" Diesel at the time of fuel injection. The cylinder head is so designed that when the air velocity would tend to slow up due to decreasing piston speed it is actually increased. Consequently, ignition takes place at the point where the maximum velocity is attained. This, in large measure, accounts for Oliver "Cletrac's" phenomenal power and exceedingly low fuel consumption. Oliver "Cletrac's" high turbulence gives the power stroke the important "carry through" that makes for greater, smoother, cleaner burning and good fuel economy.

FILTERS In Diesel engines, where tolerances are figured in hundred-thousandths of an inch, keeping out dust and dirt is a major problem. Typical of the care used in building the Oliver "Cletrac" Diesel is the provision for keeping the fuel clean—it is equipped with the best of fuel filters and strainers. As a result Oliver "Cletrac" Diesels are able to go where the job is and operate efficiently in dust, dirt, mud, water or sand.

CRANKSHAFT. The crankshaft in the Oliver "Cletrac" Diesel is a thing of beauty—it's made of special steel, accurately machined, electrically hardened, heat-treated and carefully balanced both statically and dynamically. It is carried on five main bearings—surface hardened for long life. Total main bearing area is more than 76 square inches. End thrust is taken at the rear main bearing. The ruggedness of the crankshaft combines with full force-feed lubrication... an assurance of long life.

FUEL INJECTION. The fuel injection system of the Oliver "Cletrac" Diesel is designed for—and achieves—maximum efficiency. The fuel injector pump is designed as a unit... each cylinder receives a uniform charge of fuel, develops uniform power and power flows more smoothly. The Oliver "Cletrac" fuel system can be timed to compensate for the characteristics of different fuels and for different altitudes, which makes the Oliver "Cletrac" Diesel a more efficient outfit.

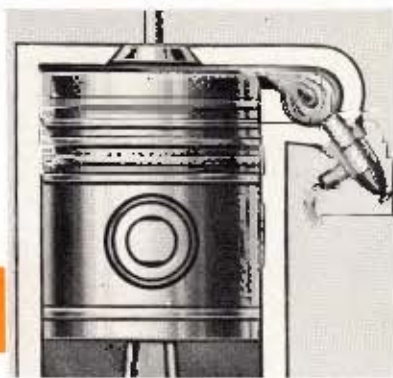

These are tolerances to fine in Oliver "Cletrac" Diesel engines that they can be measured only by a light gauge in terms of millionths of an inch.

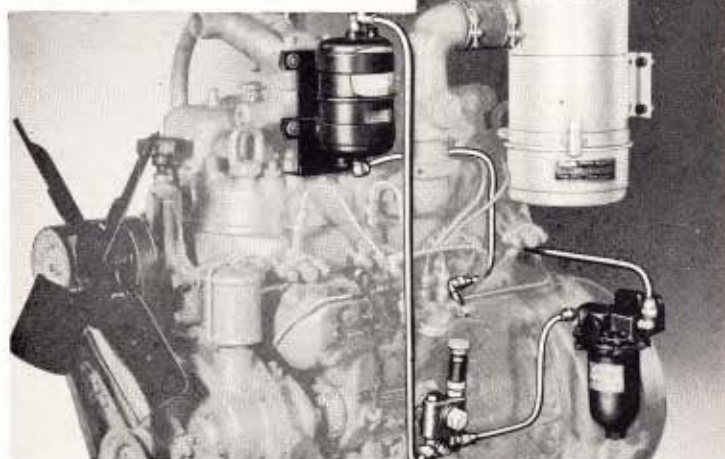

Fuel and oil filters on the Oliver "Cletrac" Diesel are not only highly efficient—they are placed where they are easily accessible.

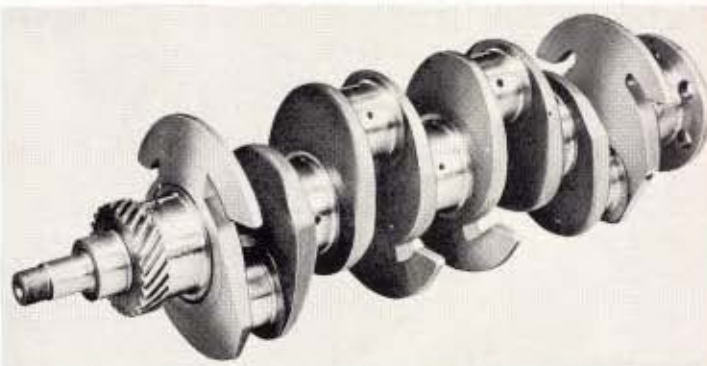

The crankshaft is balanced both statically and dynamically. Pistons and connecting rods are weighed in sets and must balance to within a fraction of an ounce.

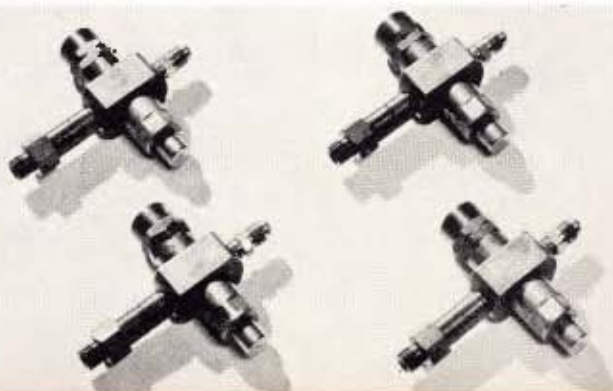

OLIVER "Cletrac" GIVES LONG LIFE

POSITIVE FORCE-FEED LUBRICATION

Lubrication is the lifeblood of any tractor. The first function of a thorough lubrication system is to prevent metal-to-metal contact between the moving parts. The second is to eliminate or minimize the human element and make lubrication as automatic as possible. Engines in all Oliver "Cletracs" have an efficient force-feed lubrication system. A positive gear driven pump draws the oil through the strainer at the bottom

of the crankcase, then forces it through the oil filter; from the oil filter it is pumped to the main bearings from which it runs through the drilled crankshaft to the connecting rod bearings.

The oil pan in Oliver "Cletracs" is unusually short and deep so that the pump is always primed. This assures positive lubrication regardless of the angle at which the tractor is working.

OIL-BATH AIR CLEANER

Clean air is second only to good lubrication in promoting long life in a tractor. Sand and dust getting inside an engine can cause more wear in an hour's time than months of operation with dust-free air. The oil-bath air cleaner used on the Oliver "Cletrac" Model A thoroughly cleans air before it enters the carburetor and engine—an important factor in increasing life of the engine.

Incoming air swirls down through an auxiliary cleaner on top of the hood before entering the main cleaner shown at right. The auxiliary cleaner removes the heavier particles of dust and dirt. Then, as the air is drawn down the stack and through the cleaner by suction of the engine, it passes through a mist of oil which is formed above the oil well in bottom of the cleaner. Air is sucked upward and passes first through coarse crimped wire in a removable air filter; then it continues upward through a larger air filter of very fine crimped wire, which removes any impurities. Air which reaches the carburetor and engine is much cleaner than the air you breathe in an average home.

Dirty oil drains back into the oil well in the bottom of the cleaner, where the dirt settles and is easily removed. Both auxiliary cleaner on top of the hood and removable air filter at bottom of the cleaner may be quickly, easily cleaned by washing in gasoline. This feature increases the life of the oil-bath air cleaner many times.



and ECONOMICAL PERFORMANCE

FUEL FILTERS. Oliver "Cletrac" Model A has two fuel filters. There are filter screens in the carburetor and there is a second fuel filter on the feed line between the fuel tank and the carburetor. This second filter removes any water or dirt which may have gotten into the fuel, assuring smooth, dependable performance in the engine. This filter is readily accessible and easily removed for cleaning. This feature is only one of the many safeguards which add to the value of the Oliver "Cletrac."



OIL FILTER. Thorough lubrication is the secret of long tractor life . . . Oliver "Cletracs" are equipped with an oil filter which operates continuously to keep oil clean. Before oil reaches the pistons, bearings and other parts of the engine, it is forced through a filter unit especially designed for the Oliver "Cletrac" tractor. This filter unit removes dirt and other impurities from the oil; the unit is easily cleaned in just a few minutes' time. The unit has a by-pass valve which allows the oil to go directly into the oil lines if the filtering unit becomes clogged for any reason.



ANTI-FRICTION BEARINGS. Bearings are used generously in Oliver "Cletrac" engines, and the various types of bearings are used where they are best adapted to overcome friction and wear. Ball, roller and taper roller bearings are used at every point where friction might be reduced, wear eliminated, or the transmission of power increased. These bearings are always in perfect alignment and require no adjustment. Also, bearings used are of extra large size for the work they are designed to accomplish. Proper and generous use of bearings demonstrate that Oliver "Cletracs" have real "Built to Endure" construction.



COOLING SYSTEM. There are Oliver "Cletracs" that work in Death Valley where the temperature often reaches 140 degrees, and Admiral Byrd took them to the South Pole where they operated successfully at 75 degrees below zero, for the Oliver "Cletrac" cooling system properly cools the engine at all times. The water pump is gear driven, and the fan is belt driven with easy adjustment by means of a hand screw. A fan shield directs the cooling blast of the fan against the engine to aid in positive cooling.

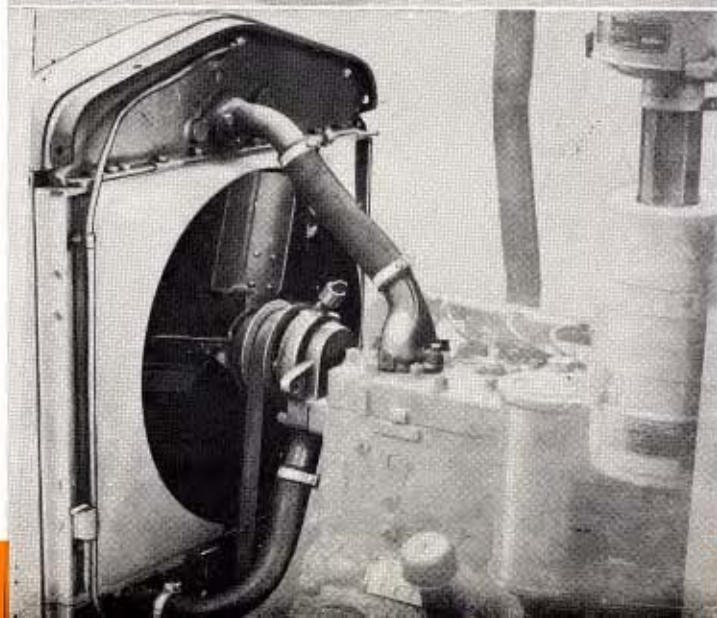

When you buy an **OLIVER** "Cletrac" you get a Complete Tractor!

All Necessary Equipment is Standard

CRANKCASE GUARD

Oliver "Cletracs" are built to take conditions as they find them . . . to go where the job is, over rocks, through fields dotted with boulders and stumps which test tractors' toughness. Hence, the Model A comes equipped with a heavy steel crankcase guard, designed to protect the crankcase from damage, no matter how tough the going! It is built of heavy steel plate, securely bolted to the underside of the one-piece tractor frame. This crankcase guard is included as standard equipment on the Oliver "Cletrac." You buy the Oliver "Cletrac" complete.



RADIATOR GUARD

This radiator guard of heavy sheet steel is securely fastened to the front of the tractor. It provides protection for the radiator from overhanging material in rough work, land clearing, and around industrial plants. This guard is standard equipment . . . another of the extra values in the Oliver "Cletrac." You get your Oliver "Cletrac" complete—no extras to buy.

All of these "extras" are standard on the Oliver "Cletrac." There are no extras to buy in order to get a complete tractor.

- Radiator Guard
- Crankcase Guard
- Hood Panels
- Upholstered Leather Seat
- Interchangeable Grousers
- Protective Motor Frame Ahead of Engine
- Transmission Oil Pump
- Ventilated Clutch Through Dual Air Cleaners
- Transmission Air Cleaner and Breather
- Oil-Bath Air Cleaner on Engine
- Oil Filter Unit

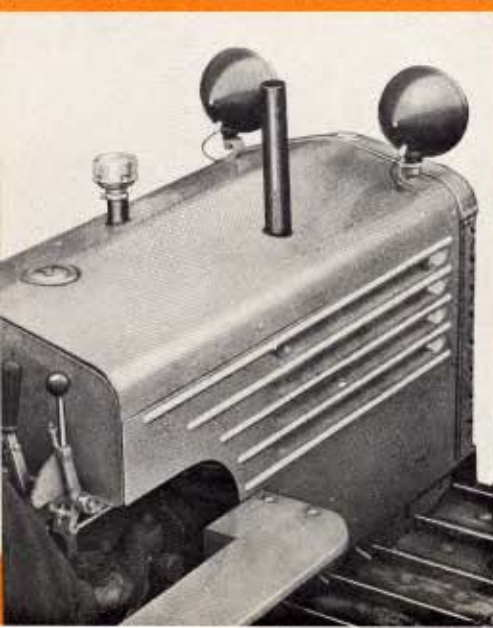

STEEL HOOD PANELS

Oliver "Cletracs" are regularly equipped with steel hood panels of the same color and material as the rest of the hood. Spring latches hold them securely in place, yet they are easily removed. Hood panels help to keep the engine warm in winter, making for more efficient operation. The panels also protect the engine from dust and dirt.

Good engineering design foresees all of the conditions which an Oliver "Cletrac" may have to meet in service . . . and builds into it the ability to meet twists and strains with such safeguards as ample clearance, a swinging drawbar suspended from a track frame shaft, a heavy one-piece frame, buffer springs, crankcase guards, etc., which prevent damage in use. Oliver "Cletrac" design also provides easy accessibility for lubrication and inspection, for adjustment of track assembly, clutch and other parts.

HERE IS EASY CONTROL WITH COMFORT...

AMPLE LEG ROOM. Every operator who has to stick to the job eight or more hours a day appreciates the ample leg room an Oliver "Cletrac" gives the driver. There is room for comfort! This means more efficient operation, less fatigue... a small point perhaps, yet a point that is very important to the driver and one too often neglected.

PERFECT VISIBILITY. From a natural position on the seat of the Oliver "Cletrac" you have a full unobstructed view at either side. There is no twisting and turning of the head to see what you're doing or where you're going when you operate this tractor. This is a big comfort feature you'll appreciate when you must operate your tractor eight to ten or twelve hours a day.

HANDY CONTROLS. Steering levers, throttle, gear shift, belt pulley lever, clutch, ignition switch... in short *all* controls are within convenient, easy reach on the Oliver "Cletrac." Right before you on the dash is the oil pressure gauge. You use only your hands in steering and controlling an Oliver "Cletrac." You can shift your sitting position; you can move your feet— you can keep yourself comfortable.

UPHOLSTERED SEAT. Both the seat and the back rest on the Oliver "Cletrac" are built over heavy coil springs, well padded, and covered with substantial leather... deep, wide cushions that provide all-day working comfort... cushions like those in your arm chair at home. Arms of the seat are also covered with leather.



EASY ADJUSTMENTS

Reduce Repair Costs and "Lay-ups"

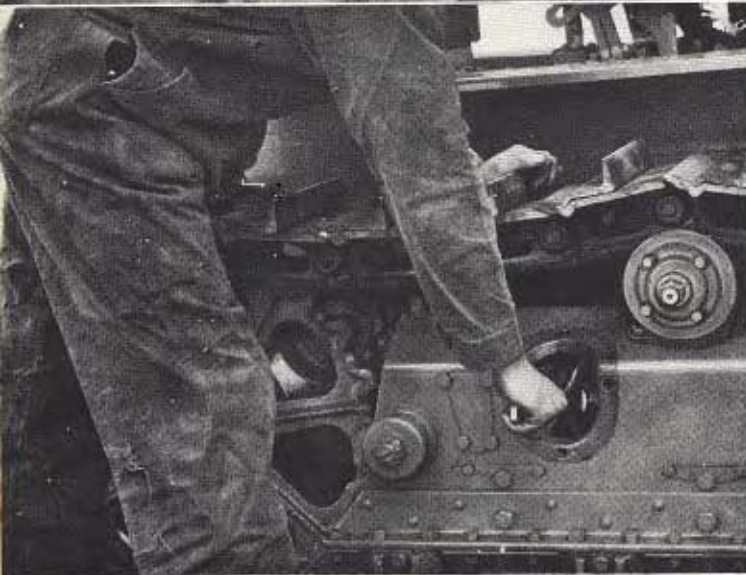

STEERING BANDS. You will realize the operating advantages of Oliver "Cletrac" Controlled Differential Steering the first time you drive the tractor, for the easy steering, the smoother turning, and the extra power it delivers on turns is readily apparent. Ease of maintaining the steering mechanism is equally valuable.

The only parts to maintain are the two steering bands, and because the only function of these bands is to control the balance and action of the differential, their life is exceptionally long. When finally they must be replaced it is only necessary to remove the large transmission case cover and lift them out . . . no need to disturb or disconnect any driving shaft in the tractor. Periodical adjustments are quickly made as illustrated.

TRACKS. The track on a crawler tractor is much like a chain—it must be properly adjusted. The track must operate in a straight line between the front idler wheel and the rear driving sprocket so that every track shoe digs in and works; to accomplish this the Oliver "Cletrac" track frame has a single pre-compressed spring which holds the track in proper adjustment without subjecting it to spring tension. This spring also cushions shocks caused by idler wheels hitting obstructions, before they reach other parts of the tractor. This spring is fully enclosed in the track frame, protected from dirt, mud, water and ice, yet can be adjusted easily and quickly.

To adjust the tracks, simply remove the locking plate and turn the adjusting mechanism to the proper position. Because the spring circles around the plunger shaft the front shaft is always in perfect alignment. Track adjustments can be made from outside the tractor, in any easy standing position. It is not necessary to crawl under the tractor.

CLUTCH. The Oliver "Cletrac" Crawler has a double-disc clutch, with four wearing faces . . . its advantages are many. It has double the ordinary number of surfaces to absorb wear; this postpones to the ultimate the time when replacement must be made, and reduces frequency of adjustment.

To replace the clutch you simply remove the clutch cover plate and lift out the clutch as a unit without disturbing the engine or transmission.

To adjust the clutch, simply remove the clevis from the clutch pedal and turn the clevis to allow for the proper amount of free travel. Adjusting the clutch of an Oliver "Cletrac" requires only a few minutes and is done from an easy standing position.

Wear and tear on the clutch is greatly reduced because Controlled Differential Steering keeps both tracks under power at all times and there is little or no inertia to overcome in steering.

OLIVER "Cletrac" ELECTRIC STARTING

Provides Power at the Touch of a Button



STARTING *Was* A PROBLEM

Before the days of electric starting it was a real job to start a Diesel tractor in extremely cold weather . . . you literally had to "build a fire under them" when the temperature hit the skids! Electric starting plus the use of a hot water heater has licked that problem.

In extremely cold weather, where the cold metal would absorb the heat of compression too rapidly, heat is first built up in the water of the cooling system. The heated water, circulating as a result of thermo-siphon, warms the cylinder walls, pistons, valves and other internal parts. The result is that when the engine starts all parts are moving freely and thoroughly lubricated. This is just another advantage of Oliver "Cletrac" Diesels.



ELECTRIC STARTING CUTS WASTE OF FUEL . . . WASTE OF TIME

In the early fall of 1933 the first "Cletrac" Electric Starting Diesel Tractor was built in the crawler tractor plant in Cleveland. It was the first electric starting Diesel tractor of its kind. Today thousands of Oliver "Cletrac" owners know the advantages of electric starting . . . instant starting at the touch of a button . . . MODERN starting.

Because of electric starting, Oliver "Cletrac" Diesels are on the job more quickly in the morning. There's only one engine to start, one fuel to supply and it starts as easily as your automobile. The result is more productive hours of tractor operation and decreased job costs.

Electric starting saves money for you after it's on the job, too. There is less idling time with an Oliver "Cletrac" Diesel. When you stop to measure a grade, or for any reason at all, you can turn off the engine. It will start again at a touch of the button.

Because of electric starting, there is no need for a "sky hook" . . . no need to get another tractor to pull you out of an impossible place should your engine stall. You don't even get down off the seat to start an Oliver "Cletrac" Diesel—just press a button.

Because of electric starting, there is current available for lights no additional batteries or electric generator to buy for these are already there. The only additional cost is for the lights themselves. *Because of electric starting,* Oliver "Cletrac" Diesels need no auxiliary engine. There is only one engine, only one engine to service and only one engine to oil, grease and maintain.

ONLY OLIVER "Cletrac" HAS *Tru-Traction!*

VALUE IS BUILT INTO THE



When an Oliver "Cletrac" starts at one end of this modern assembly line it is just a frame mounted on a dolly. It leaves the assembly line as a complete tractor, driven off under its own power. This assembly line is one of the most modern in the tractor industry . . . the same kind of continuous production that is used in the great automobile factories. This

modern streamlined production reduces production costs. It enables Oliver to deliver to you a Cletrac Crawler Tractor complete even to crankcase guards, radiator guards and side hood panels at a price which would not be possible under less efficient production methods.



This multiple drilling machine drills 44 holes in one operation. It not only cuts costs of production but it also assures perfect alignment of the holes.



Another machine that reduces manufacturing costs and improves tractor performance. Oliver "Cletrac" sprockets, cut on this machine, are alike as peas in a pod.



This giant machine cuts several tractor bull gears in a single operation. It is typical of the equipment used throughout the entire Oliver "Cletrac" factory.

OLIVER "Cletrac"

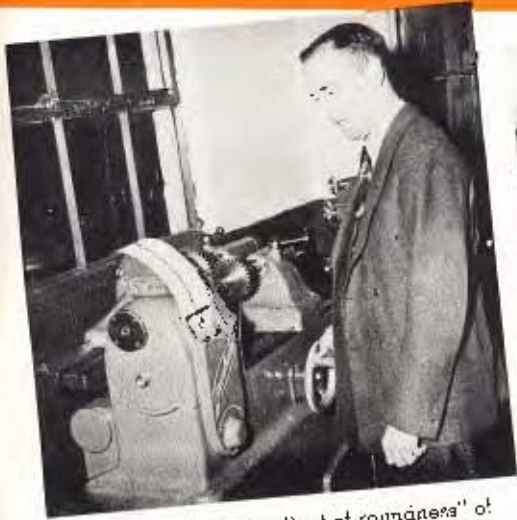

The concentricity or "out-of-roundness" of gears is checked against master gears, before and after heat treatment, to eliminate high points and insure smooth operation, better transmission of power.



Finished gears are also tested for proper hardness on this Rockwell testing equipment. Properly hardened gears assure long gear life, freedom from break-downs in tractor operations.



Nothing is left to chance in building Oliver "Cletracs." After heat treatment, track pins and bushings are Rockwell tested for proper hardness.



All machined and operating parts are checked by the highest standard gauges known. But to insure accuracy of fit of all parts, templates and thread contours are magnified $E2\frac{1}{2}$ times.



Correct "back lash," or clearance on making gears is constantly checked on the finest of precision equipment. The result is smooth, efficient power transmission.

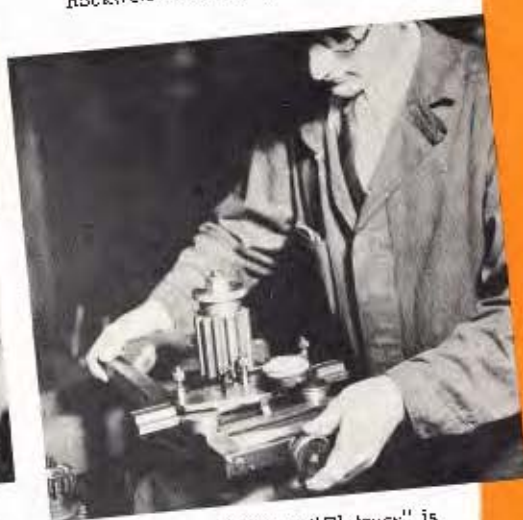

The building of Oliver "Cletracs" is a constant check, check and double check. This gear testing instrument registers in ten-thousandths of an inch.

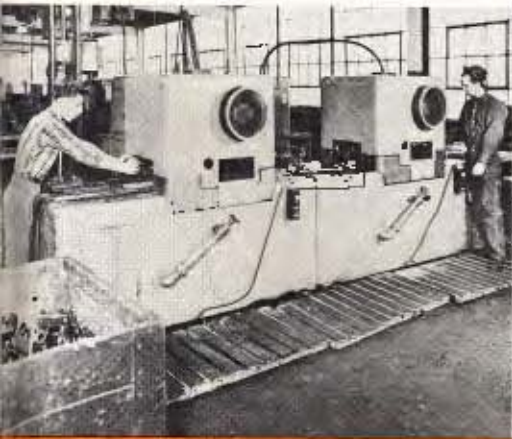

Track rails are induction hardened by the latest Tocco process to insure long, even wear. Surfaces are machined to provide true alignment of all matching parts.

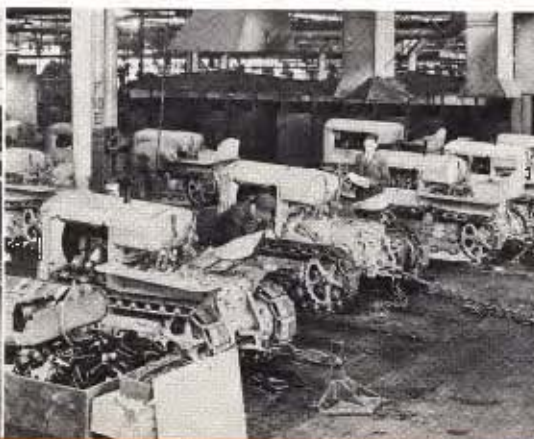

Each Oliver "Cletrac" is run under load for two or three hours and constantly checked. Only then does it get the final Okay for shipment from factory to owner.



In this die storage department are more than 8,000,000 pounds of dies used in building Oliver "Cletrac" tractors. Dies are handled and stored electrically.

★ *Special* ATTACHMENTS ★



← FRONT LIGHTS

Your Oliver "Cletrac" can be wired for lighting and fitted with two front head lamps and white or red tail light for night operation.

REAR POWER REDUCTION →

This power reduction conforms to the power take-off standards of the American Society of Agricultural Engineers.

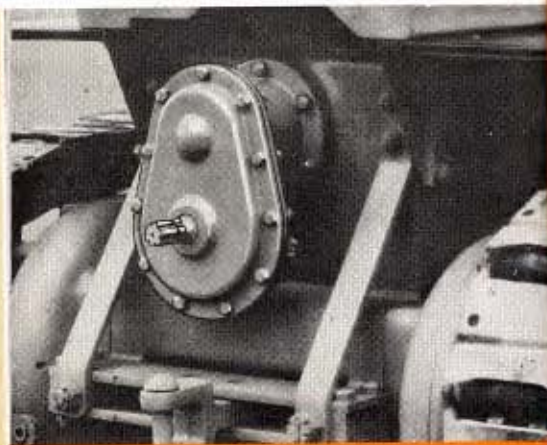

← SPOT LIGHTS

Spot lights for mounting on either front or rear, or both, are available. Light can be thrown in all directions.

FRONT PULL HOOK →

This pull hook is an extra heavy steel forging and is rigidly bolted to the front member of the one-piece Oliver "Cletrac" frame.



← FRONT BUMPER

Where extra protection is desired in addition to the standard heavy steel radiator guard, this bumper is available. It is of heavy steel construction with an extra wide face so it can be used as a buffer in pushing loads. It is rigidly bolted to the front member of the one-piece Oliver "Cletrac" frame.

COMBINATION PULLEY → AND TAKE-OFF

Mounted on the rear, this bell pulley and take-off is convenient and makes it a simple matter to line up the tractor with the driven machine. Also available with pulley only.

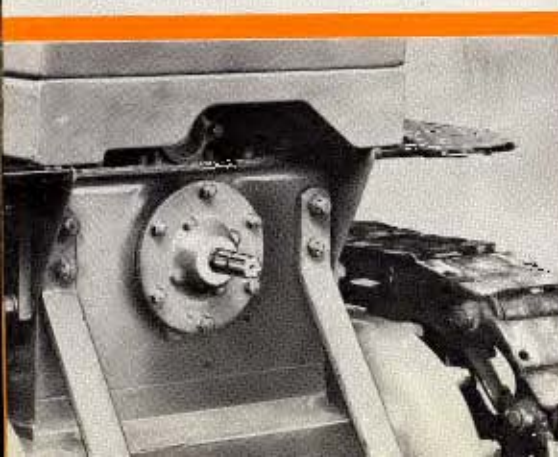
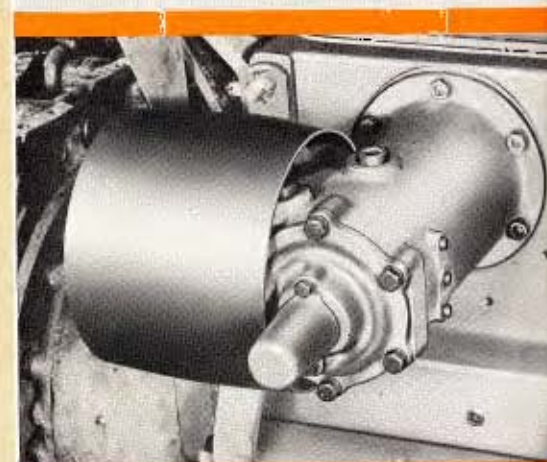

← REAR POWER TAKE-OFF

Valuable for adapting the Oliver "Cletrac's" abundant power to operate industrial equipment which requires higher speeds and close mounting . . . such as winches, hydraulic pumps, air compressors, welders, etc. A front power take-off is also available.

Other Special Equipment

Other equipment not illustrated here but which is available and can be supplied as extra equipment on Oliver "Cletracs" includes Winter Cabs, Summer Cabs, Malters, Side Seat Mounting, Bucket Seat, Spoke Arrestor, Detachable Rear Starting Crank and Front Power Take-off.

A variety of cylinder heads for all altitudes and various conditions are available.

A SIZE FOR EVERY JOB!

In Industry and Agriculture

No matter what your job is, whether it is hauling scrapers, bulldozing, trail building, handling elevator graders, blade grading, ripping, shoveling, moving dirt economically there is an Oliver "Cletrac" built to fit your industrial job.

In agriculture, Oliver "Cletracs" reduce costs in plowing, planting, spraying, cultivating, harvesting... in practically every farm operation where power is required.

Because of its greater speed... greater capacity... greater economy... greater dependability... the Oliver "Cletrac" should be your first choice if your job requires a crawler type tractor.

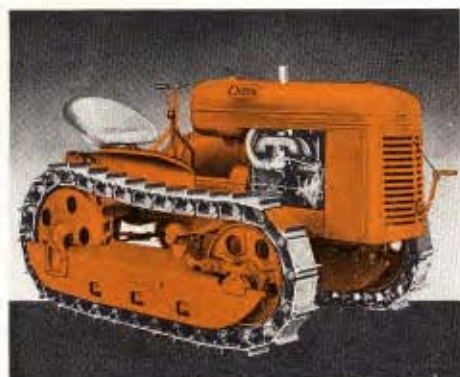

MODEL "HG" -- Gas

Track Centers—42, 58 Inches

	Gas
Drawbar H.P. Corrected to Sea Level...	16.00
N.A.C.C. Rating.....	19.62
Speeds: 2.02, 3.19 and 5.25 M.P.H. 2.35 M.P.H. in Reverse	
Drawbar Pounds Pull Corrected to Sea Level	
1st Gear.....	3,080
2nd Gear.....	2,170
3rd Gear.....	1,080
Belt H.P. Corrected to Sea Level.....	22
Approximate Weight (Depending on width).....	2,270 to 3,340



MODEL "A" SERIES -- Gas and Diesel

Gas Diesel

	Gas	Diesel
Drawbar H.P. Corrected to Sea Level.....	30.6	30.5
N.A.C.C. Rating.....	29.34	28.8
Speeds: Gasoline 1.78, 2.61 and 3.74 M.P.H. 1.36 M.P.H. in Reverse		
Speeds: Diesel 1.78, 2.62 and 3.74 M.P.H. 1.36 M.P.H. in Reverse		
Drawbar Pounds Pull Corrected to Sea Level		
1st Gear.....	6,020	6,900
2nd Gear.....	4,180	4,520
3rd Gear.....	2,640	2,600
Belt H.P. Corrected to Sea Level.....	38.8	39.0
Approximate Weight.....	7,325	7,950



MODEL "B" SERIES -- Gas and Diesel

Gas Diesel

	Gas	Diesel
Drawbar H.P. Corrected to Sea Level.....	38	38.05
N.A.C.C. Rating.....	33.75	33.75
Speeds: Gasoline— 1.81, 2.64, 3.46 and 5.4 M.P.H. 1.8 and 3.4 M.P.H. in Reverse		
Speeds: Diesel 1.81, 2.64, 3.46 and 5.4 M.P.H. 1.8 and 3.4 M.P.H. in Reverse		
Drawbar Pounds Pull Corrected to Sea Level		
1st Gear.....	7,680	8,042
2nd Gear.....	5,700	5,996
3rd Gear.....	4,200	4,127
4th Gear.....	2,000	2,000
Belt H.P. Corrected to Sea Level.....	50	48.09
Approximate Weight.....	8,775	9,400



MODEL "D" SERIES -- Gas and Diesel

Gas Diesel

	Gas	Diesel
Drawbar H.P. Corrected to Sea Level.....	61.2	61.10
N.A.C.C. Rating.....	51.34	45.9
Speeds: Gasoline 1.94, 2.5, 3.3, 5.3; 2.2 and 3.9 in Reverse		
Speeds: Diesel 1.7, 2.3, 3.1, 4.9; 2.0 and 3.65 in Reverse		
Drawbar Pounds Pull Corrected to Sea Level		
1st Gear.....	11,000	11,816
2nd Gear.....	8,360	8,833
3rd Gear.....	7,000	7,696
4th Gear.....	4,156	4,568
Belt H.P. Corrected to Sea Level.....	69	67.7
Approximate Weight.....	12,920	13,600



MODEL "FDE" -- Diesel

Diesel

	Diesel
Drawbar H.P. Corrected to Sea Level.....	129.5
Speeds: 1.61, 2.75, 3.66, 5; 1.98 and 2.82 in Reverse	
Drawbar Pounds Pull Corrected to Sea Level	
1st Gear.....	28,600
2nd Gear.....	18,230
3rd Gear.....	11,500
4th Gear.....	7,120
Belt H.P. Corrected to Sea Level.....	146.00
Approximate Weight.....	29,760

*In this modern plant there is every research and manufacturing facility for building the famous **OLIVER 'Cletrac'** Crawler Tractors*

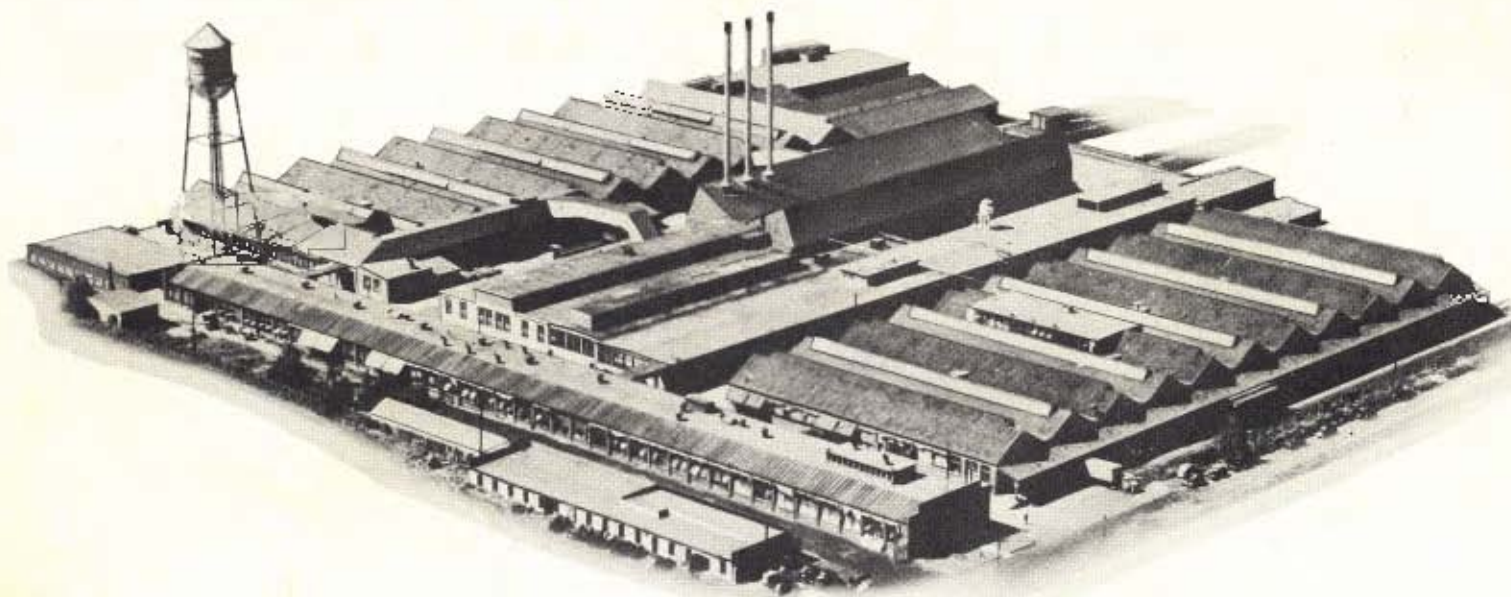

The **OLIVER** Corporation

AGRICULTURAL DIVISION
400 West Madison Street
Chicago 6, Illinois

INDUSTRIAL DIVISION
19300 Euclid Avenue
Cleveland 17, Ohio

EXPORT DIVISION
400 West Madison Street
Chicago 6, Illinois