

TYPICAL TRENCH INLET GRATE

(1 TOTAL FOR EACH INLET)

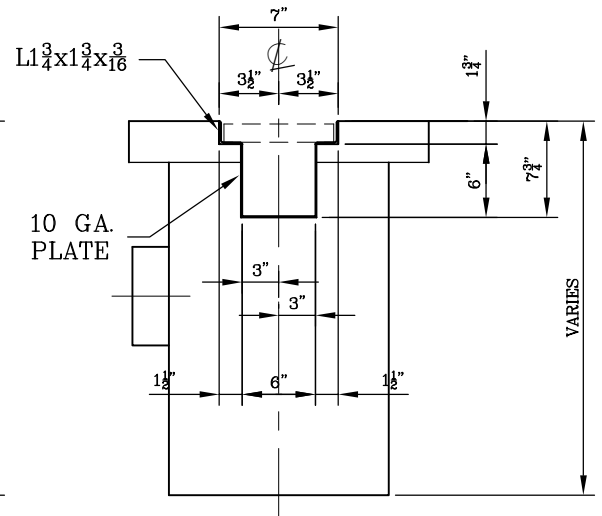
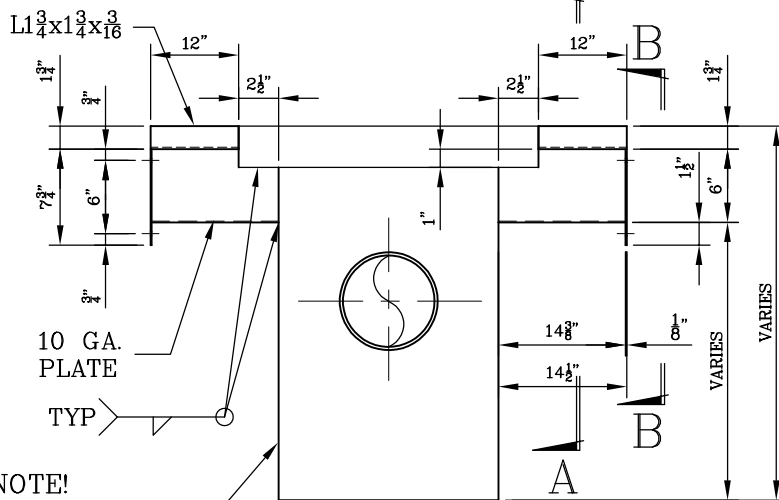
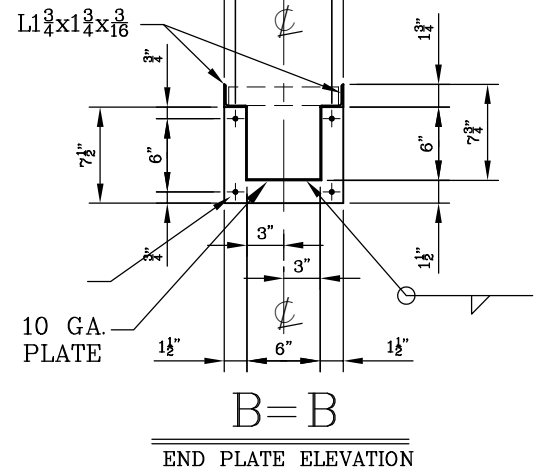
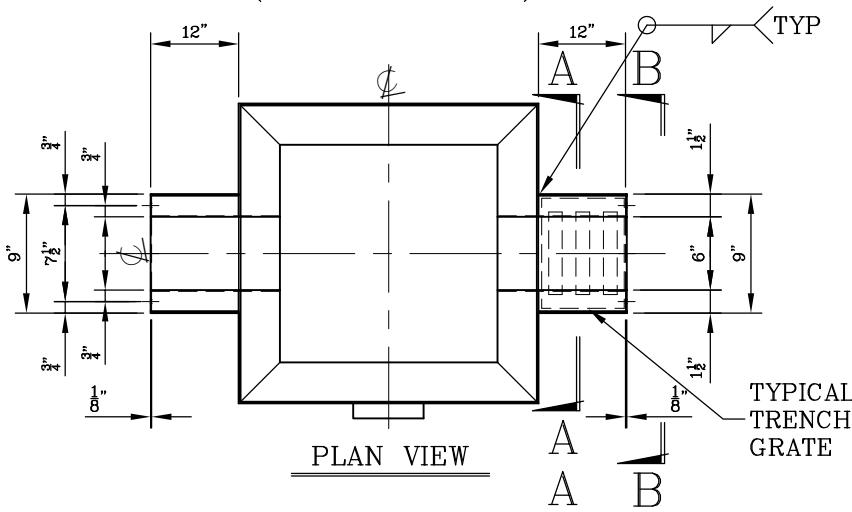
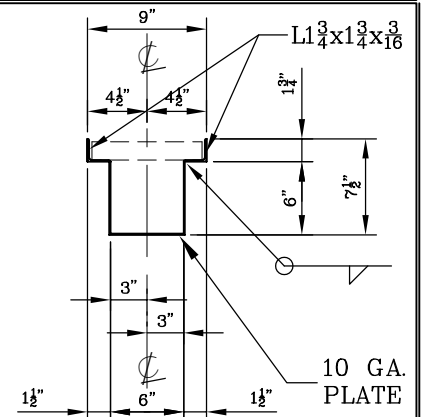

NOTE!
24" SQUARE
STORM SEWER
CATCH BASIN
(DEPTHS VARY)

TYPICAL TRENCH DRAIN INLET

6" WIDE x 6" DEEP INLET
TRENCH DRAIN INLET (STORM SEWER CATCH BASIN)

MODEL: GTDB-66D

DATE: 11/19/2020

SCALE: NONE

DWG #
TDB
6D

Gibson Steel Basins, Inc.

1040 Arrowsmith St. Eugene Or. 97402
(541) 484-7200 or (800) 574-8096

Visit us at: www.gibsonsteelbasins.com

Email us at: sales@gibsonsteelbasins.com

EST. 1996

CCB 150089