

**FM 3-3-1**  
**FMFM 11-18**

---

# **Nuclear Contamination Avoidance**

---

**Pub Date 09-94**  
**PCN 139 001194 00**

**FM 3-3-1**  
**FMFM 11-18**  
**9 SEPTEMBER 1994**

By Order of the Secretary of the Army:

Official:

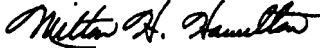
  
**MILTON H. HAMILTON**  
*Administrative Assistant to the*  
*Secretary of the Army*  
07093

**GORDON R. SULLIVAN**  
*General, United States Army*  
*Chief of Staff*

By Order of the Marine Corps:

**Carl E. Mundy, Jr.**  
**Commandant**  
**United States Marine Corps**

**DISTRIBUTION:**

**Active Army, USAR, and ARNG: To be distributed in accordance with DA Form 12-11E, requirements for FM 3-3-1, *Nuclear Contamination Avoidance* (Qty rqr block no. 5227)**

# Preface

**This publication supercedes the nuclear/radiological portions of FM 3-3, dated 30 September 1986.**

The mission of the Chemical Corps is to prepare the Army to survive and win in a nuclear environment by—

- Developing doctrine, organizations, training products, and equipment for nuclear defense, and nuclear retaliation.
- Minimizing the impact of nuclear weapons through contamination avoidance, protection, and decontamination.
- Employing smoke.
- Employing flame.

This manual is one of four that explain the fundamentals of NBC defense—

- **FM 3-3, *Chemical and Biological Contamination Avoidance.***
- **FM 3-3-1, *Nuclear Contamination Avoidance.***
- **FM 3-4, *NBC Protection.***
- **FM 3-5, *NBC Decontamination.***

A general overview of these fundamentals is given in FM 3-100, NBC Operations. This manual, FM 3-3-1, defines and clarifies the entire process of nuclear contamination avoidance. It details the NBC Warning and Reporting System (NBCWRS), how to locate and identify nuclear contamination, and how to operate in and around nuclear contamination. This manual is designed and intended to be an easy-to-read, step-by-step manual depicting the manual method of calculating nuclear contamination avoidance procedures for chemical officers and NCOs at brigade level and higher organizations. However, subject matter discussed in Chapters 1 and 2 and appendices A and C are of general use for all branches and MOS. Unless otherwise stated, whenever the masculine gender is used, both men and women are included.

Chapter 1 defines the nuclear threat and how to reduce unit vulnerability.

Chapter 2 defines how we warn our troops of an enemy nuclear attack and how we warn of a friendly nuclear attack.

Chapters 3, 4, and 5 detail procedures for detecting, identifying, evaluating and plotting hazards while operating in a nuclear environment. These chapters are essential for brigade, division, and corps chemical personnel.

Chapter 6 details the mathematical procedures required for evaluating nuclear information.

Chapter 7 details procedures required to operate in and around neutron induced radiation areas.

Chapter 8 discusses procedures for tactical units confronted with radiation hazards emanating from civilian facilities.

Appendices A through F detail specialized information often required in a nuclear environment.

Appendix G provides operational employment guidelines for the principles of contamination avoidance in the form of a checklist.

Chemical personnel must be familiar with and be able to apply the information in this manual.

**DA Forms for which this publication is the prescribing directive are for Army use only.**

The proponent of this manual is the US Army Chemical School. Submit changes for improving this publication on DA Form 2028 (Recommended Changes to Publications and Blank Forms) and forward to:

Commander  
USACML&MPCEN&FM  
ATTN: ATZN-CM-FNB  
Fort McClellan, AL 36205-5020.

# Nuclear Contamination Avoidance

Preface v

Introduction vi

## Chapter 1. Vulnerability Analysis 1-0

- The IPB Process 1-0
- Nuclear Threat Status (STANAG 2984) 1-2
- Nuclear Vulnerability Analysis 1-4
  - Casualty and Damage Assessment 1-5
  - Safety Distance Assessment 1-5
  - Nuclear Radiation Safety 1-7
  - Primary Targets 1-7
  - Targeting Terms and Criteria 1-7
- Analysis of Friendly Unit Vulnerability 1-8
  - Vulnerability Analysis 1-8
  - Visual Technique 1-8
- Vulnerability Reduction 1-9
- Active Measures 1-9
- Passive Measures 1-9
  - Plan Ahead 1-9
  - Avoid Detection 1-9
  - Provide Warning 1-10
  - Maintain Discipline 1-10
  - Seek Protection 1-10
  - Disperse 1-10
  - Remain Mobile 1-10
  - Cover Supplies and Equipment 1-10

Limit Exposure 1-10

Prevent Spread of Contamination 1-11

## Chapter 2. NBC Warning and Reporting System 2-0

- Standard NBC Reports 2-0
  - NBC 1 Report 2-1
  - NBC 2 Report 2-2
  - NBC 3 Report 2-3
  - NBC 4 Report 2-3
  - NBC 5 Report 2-3
- Managing the NBC Warning and Reporting System 2-4
  - Collecting Nuclear Information 2-4
  - Monitoring, Survey, and Reconnaissance Data 2-4
  - Evaluating Nuclear Information 2-4
  - Unit Procedures 2-4
  - NBCC Procedures 2-5
  - Transmitting Nuclear Information 2-5
    - Unit Level 2-5
    - Battalion Level 2-6
    - Brigade or Task Force Level 2-6
    - NBCC Level 2-6
  - Designated Observer System 2-6
    - Designated Ground-Based Observers 2-6
    - Designated Aerial Observers 2-7

**DISTRIBUTION RESTRICTION:** Distribution is authorized to US government agencies only to protect technical or operational information, as well as unclassified, controlled, nuclear information (UCN) material from automatic dissemination under the International Exchange Program or by other means. This determination was made 29 November 1991. Other requests for this document will be referred to Commandant, US Army Chemical School, ATTN: ATZN-CM-FNB, Fort McClellan, AL 36205-5020.

**DESTRUCTION NOTICE:** Destroy by any method that will prevent disclosure of contents or reconstruction of the document.

U.S. MARINE CORPS PCN: 139 001194 00

- Nondesigned Observers 2-7
- Friendly Nuclear Attack Warnings 2-7
  - Responsibility 2-7
- STRIKWARN Messages 2-7
- Automated Nuclear, Biological, and Chemical Information System (ANBACIS) 2-10

### **Chapter 3. Introduction to Nuclear Operations 3-0**

- Nuclear Weapons Effects 3-0
- Initial Radiation Effects 3-1
- Residual Radiation Effects 3-1
  - Unused Fissionable Material 3-1
  - Fission Products 3-1
  - Neutron-Induced Activity 3-2
- Effects of Fallout on Ships at Sea 3-2
- Nuclear Clouds 3-2
  - Detecting the Attack 3-2
  - Angular Cloud Width 3-4
  - Stabilized Cloud-Bottom or Cloud-Top Angle 3-4
  - Cloud-Top or Cloud-Bottom Height 3-5
  - Observer Position 3-5
  - Location of Ground Zero/Azimuth to the Attack 3-5
  - Unit Level Procedures 3-5
- Location of Ground Zero 3-5
- Yield Estimation 3-6
  - On Shore 3-6
  - Onboard Ships 3-7
- Significance of Fallout Ashore versus at Sea 3-7
- Flash-to-Bang Time 3-7
- Type of Burst and Time of Attack 3-9
- Recording and Reporting
  - Nuclear Burst Data 3-9
- Evaluating Data 3-9
- NBCC Procedures 3-9
  - Date and Time of Attack 3-9
  - Ground Zero Location 3-10
  - Yield Estimation 3-11
  - Nuclear Burst Angular Cloud Width 3-11
  - Stabilized Cloud-Top or Cloud-Bottom Height 3-11
  - Stabilized Cloud-Top or Cloud-Bottom Angle 3-12
- Yield Estimation From Radar Data 3-12
- Illumination Time 3-12
- Resolved Yield 3-12

- NBC 2 Nuclear Report 3-13
  - Strike Serial Number 3-15
  - Simplified Fallout Prediction 3-15
  - Wind Data 3-15
- Effective Downwind Message 3-16
  - Preparation of a Message 3-16
  - Special Cases (Wind Data) 3-18
- Naval Effective Downwind Message 3-19
  - Preparation of a Message (Constant Pressure Data) 3-19
- M5A2 Fallout Predictor 3-21
  - Procedures for Using Simplified Method 3-21
  - Constructing a Simplified Predictor 3-23
- Simplified Fallout Prediction (Normal Case) 3-24
- Simplified Fallout Prediction (Expanded Case) 3-24
- Simplified Fallout Prediction (Circular Case) 3-24
- Ship's Fallout Template 3-24
  - Safety Distance 3-27
  - Fallout Plotting from NAV EDM and Observations 3-27
  - Fallout Plotting from NAV EDM and NAV NBC 2 Nuclear Report 3-29

### **Chapter 4. Detailed Fallout Prediction—NBC 3 Report 4-0**

- Overview 4-0
  - Significance of Predicted Fallout Zones 4-0
    - Inside the Predicted Area 4-0
    - Outside the Predicted Area 4-1
  - Reliability 4-1
  - Arrival of Fallout 4-1
- NBCC Procedures 4-3
- Unit Procedures 4-11
- Fallout Plotting From
  - NAV NBC 3 Nuclear Report 4-13
  - Actual Fallout Direction 4-14

### **Chapter 5. Monitoring, Survey, and Reconnaissance 5-1**

- Planning, Conducting, Recording, and Reporting 5-1
- Monitoring 5-1
  - Direct Monitoring 5-2
  - Indirect Monitoring 5-2
  - Recording and Reporting Monitoring Data 5-4

- Surveys **5-8**
  - Control of Surveys **5-9**
  - Survey Planning at the NBC Center **5-9**
  - Personnel and Equipment
    - Requirements **5-12**
    - Coordination **5-12**
    - Survey Team Briefing **5-13**
  - Aerial Survey **5-13**
  - Determination of Overall Correction Factors **5-15**
  - Airborne Radioactivity **5-17**
  - Contour Line Plotting **5-17**
  - Aerial Survey Team Actions **5-20**
  - Recording and Reporting **5-25**
  - Ground Survey **5-26**
  - Reconnaissance **5-27**
    - Contamination Marking **5-28**
    - Vehicle Correlation Factor **5-30**
    - Unit Procedures **5-30**
    - Ground Radiological Recon **5-30**
    - Aerial Recon **5-33**
    - NBCC Actions **5-34**
- Chapter 6. Nuclear Defense 6-1**
  - Optimum Time of Exit for Fallout Areas **6-1**
    - Special Considerations **6-1**
    - Sample Problem **6-3**
  - Transmission Factors **6-3**
  - Calculation of H-Hour **6-4**
    - Use of ABC-M1 Radiac Calculator **6-4**
    - Rainout and Washout **6-6**
    - Tactical Implications **6-7**
  - Period of Validity and Decay Rate **6-8**
    - Determination of Decay Rate **6-9**
  - Normalizing Readings to H + 1 **6-9**
  - Normalizing Factor **6-14**
  - Total Dose Procedures **6-14**
  - Multiple Burst Procedures **6-18**
    - Dose Rate Calculation Methods **6-18**
    - Dose Rate Calculations
      - for Overlapping Fallout **6-21**
  - Crossing a Fallout Area **6-23**
  - Application of Avoidance Principles **6-31**
  - ANBACIS System **6-31**
- Chapter 7. Neutron-Induced Radiation Areas 7-0**
  - Plotting NIGA Areas **7-1**
  - Decay of Induced Radiation **7-1**
  - Dose-Rate Calculations **7-2**
  - Total Dose Calculations for NIGA **7-3**
  - Crossing an Induced-Radiation Area **7-4**
  - Transmission Factors
    - for Neutron-Induced Areas **7-6**
  - Determination of Decay Rate
    - for Induced Radiation **7-6**
  - Determination of Dose Rate
    - for an Arbitrary Time **7-7**
  - Determination of Dose Accumulated in an NIGA Area **7-8**
  - Determination of Time of Exit from an NIGA Area Given a Maximum Dosage **7-7**
- Chapter 8. Civilian Radiation Hazards 8-0**
- Appendix A. Operational Exposure Guidance A-0**
  - Categories of Exposure **A-0**
  - Risk Criteria **A-2**
  - Negligible Risk **A-2**
  - Moderate Risk **A-2**
  - Emergency Risk **A-2**
  - Radiation Exposure Records **A-2**
    - Processing Data **A-3**
    - Individual Dosimetry **A-7**
- Appendix B. Shielding B-0**
  - Principles **B-0**
  - Materials **B-0**
  - Effectiveness **B-0**
  - Transmission Factors **B-3**
  - Determination of Transmission Factors **B-3**
  - Sample Problems **B-3**
  - Exercise Problems **B-3**
- Appendix C. Nuclear Burst Effects on Electronics C-1**
  - Types of EMP **C-1**
    - Surface-Burst EMP **C-1**
    - High-Altitude EMP **C-2**
    - The HEMP Threat **C-2**
  - Tactical Equipment **C-3**
  - Personnel **C-4**
  - Collectors and Antennas **C-4**
  - Basic Planning **C-4**
  - Mitigation Techniques **C-6**
    - Administrative and Training Situations **C-6**
    - Rules of Thumb **C-6**
    - Training with Back-Up Systems **C-7**

Preattack and During-Attack Operations C-7  
Collectors and Antennas C-7  
Cables and Grounds C-9  
Command, Control, Communications  
and Intelligence C-9  
Shelters and Shielding c-10  
Power Sources C-11  
Postattack REcovery and  
Continued Operations C-12

**Appendix D. Wind Vector Plotting D-1**

Upper-Air Wind Data D-1  
Procedures D-2  
Field Artillery Wind Data—  
Manual Method D-2  
Field Artillery Wind Data—  
Plotting Scale Method D-5  
Ballistic MET Message D-7  
Computer MET Message D-9  
Octant Codes and Locations D-9  
Air Weather Service Wind Data—  
Plotting Scale Method D-9  
Air Weather Service Constant Pressure Data—  
Plotting Scale Method D-11  
Other Wind Data—Manual Method D-11

**Appendix E. Nomograms and Tables E-1**

**Appendix F. Additional Calculations F-0**

Determining Decay Rate F-0  
Pocket Calculator Method F-0  
Graphical Method F-0  
Determining Dose Rates F-1  
Normalizing Factors F-3  
Mathematical Method F-3  
Graphical Method F-3  
Multiple Burst Procedures F-3  
Calculating Fallout of One Burst F-3  
Calculator Method F-3  
Graphical Method F-5

Calculating Overlapping Fallout F-6

**Appendix G. Nuclear Operations  
Checklists G-1**

Prepare for Operations  
in an NBC Environment G-1  
Prepare for a Nuclear Attack G-1  
Respond to a Nuclear Attack G-2  
Conduct Post Attack Operations G-3  
Respond to a Nuclear Fallout Prediction G-3  
Operate in a Nuclear-Contaminated Area G-3  
Cross a Nuclear-Contaminated Area G-4  
Conduct or Supervise  
a Radiological Survey G-5  
Conduct or Supervise Decontamination G-5  
Evacuate Radiologically Contaminated  
Casualties G-6  
Respond to a STRIKWARN Message G-7  
Respond to an Unexpected  
Contaminated Area G-7  
Respond to a Civilian Nuclear Accident  
or Incident G-8

**References References-1**

**Glossary Glossary-1**

**Index Index-1**

**Reproducible Forms**

DA Form 1971-R, Radiological Data Sheet—  
Monitoring or Point Technique  
DA Form 1971-1-R, Radiological Data Sheet—  
Route or Course Leg Technique  
DA Form 1971-3-R, Effective Downwind  
Message Worksheet  
DA Form 1971-4-R, Fallout Prediction  
Worksheet—Surface Burst  
DA Form 1971-5-R Fallout Prediction  
Worksheet—ADM Subsurface Burst

# Introduction

Contamination avoidance is the best defense against enemy use of nuclear weapons. Avoidance reduces the risk of being targeted by nuclear weapons and minimizes the effects of nuclear contamination hazards. Knowing where contamination exists or how long the hazard may persist is essential to avoiding the hazard.

Enemy use of nuclear weapons makes battlefield operations more difficult and time consuming. Combat, combat support, and combat service support operations may be more difficult to perform in a nuclear environment. Tasks/missions may take more time because of the problems created by nuclear contamination. Nuclear attacks may cause casualties, materiel losses, and creation of obstacles. Training will reduce the problems caused by nuclear attacks on the unit. Units must locate clean areas as well as locate contamination in a nuclear environment. Contaminated units will have to perform decontamination (decon) operations.

To survive and accomplish the mission, individuals and units must take precautions to avoid or minimize effects of initial and residual nuclear hazards. The threat of contamination may force individuals and units into collective protection. Using collective protection requires special procedures that are time consuming. See FM 3-4 for information on what measures or steps an enemy nuclear attack may affect friendly forces. FM 3-3 outlines how to anticipate an enemy chemical or biological attack and minimize the effects on friendly forces.

## Contamination Avoidance

There are four steps to contamination avoidance—implement passive defensive measures, warn and report nuclear attacks, locate, identify, track and predict hazards, and limit exposure to nuclear hazards. If the mission permits, avoiding nuclear hazards completely is the best course of action. This is not always possible. The mission may force you to occupy or cross a contaminated area. This manual outlines procedures to use when working or training to work in a contaminated environment. Using these procedures, which are summarized by the four steps of contamination avoidance, units can minimize performance degradation.

### Implement Passive Defensive Measures

Passive defensive measures are those measures taken to reduce the probability of being hit by a nuclear attack or, if hit, to reduce the effects of the attack. Operational security measures such as good communication procedures, light discipline, and good camouflage reduce the chances of a

unit being targeted. Dispersion, hardening of positions and equipment, and using overhead cover reduces the effectiveness of an attack. Passive measures are discussed in more detail in Chapter 1.

## Warn and Report

Once a nuclear attack has occurred everyone who might be affected by the hazard must be warned. This gives units time to protect themselves against a possible hazard. NBCWRS is used for warning and reporting nuclear hazards. These messages and their use are standardized and kept simple so they can be passed rapidly and be easily understood. The NBCWRS is discussed in Chapter 2. The Automated NBC Information System (ANBACIS) will assist in speeding this process.

## Locate, Identify, Track, and Predict Nuclear Hazards

By locating, identifying, tracking, and/or predicting nuclear hazards, commanders can make informed decisions for operating in or around nuclear hazards. Planning nuclear reconnaissance is discussed in Chapter 5. Tactics and techniques of NBC reconnaissance are contained in FM 3-19, *NBC Reconnaissance*. Techniques for predicting nuclear hazards are given in Chapters 3, 4, and 6. A portion of ANBACIS provides for the automatic calculation of hazard areas due to nuclear weapons using or creating all NBC 1 through NBC 5 Reports.

## Limit Exposure

If operation in a contaminated area is necessary, take steps to limit the amount of troop exposure. Chapter 5 discusses crossing contaminated areas. FM 3-4, *NBC Protection*, gives guidance on protective measures for such crossings and FM 3-19, *NBC Reconnaissance*, describes the techniques for finding the best crossing route.

## Protection and Decontamination

If a unit is unable to avoid nuclear hazards, the individual soldier and unit must take protective measures. Actions that minimize equipment losses and limit the spread of contamination are discussed in this manual. Measures taken to aid in protection are covered in detail in FM 3-4.

If a unit is unable to avoid contamination, then some form of decon may be necessary. Decon reduces the immediate NBC hazard.



## Tactical Considerations

If nuclear weapons are used, individual and collective protective measures must be taken. Time-consuming and manpower-intensive tasks such as nuclear reporting, radiological recon, surveys, and decon may be necessary.

### Mission

Radioactive contamination forces the commander to reconsider how best to accomplish the mission with the available resources. The commander has three options. In order of preference, these are—

- First, do the mission in a clean area. The commander must decide whether the mission can be accomplished while staying out of contaminated areas.
- Second, do the mission in a contaminated area using a higher risk level, and use more soldiers, to do the mission faster.
- Third, do the mission in the same amount of time with the same number of soldiers, but wait for a longer period of time to start to allow for natural decay.

### Enemy

In addition to trying to determine what the enemy plans to do, the commander also must determine how and where the enemy is most likely to use nuclear weapons. For example, if the enemy is attacking, expect nuclear weapons to be used to open gaps along avenues of advance or to destroy forces.

### Terrain

Terrain modifies nuclear weapons' effects. Hills restrict the area affected by the initial effects of nuclear weapons

and disrupt the normal dispersion of fallout. Valleys and low areas provide defense against initial nuclear effects, but residual hazards may accumulate and linger.

### Troops

The physical condition of troops is very important. Tactical decisions must consider how troops will be affected.

### Time

Tasks may take longer in a nuclear environment. Adding nuclear requirements to conventional recon adds time to the mission. Decon operations are also time-consuming.

Anticipating the timing of nuclear attacks is important. Chemical and biological attacks are most likely to occur during the night and early morning or evening hours and may be employed to enhance nuclear weapons effects. Employment of nuclear weapons causes severe problems, especially among pilots and crewmen, due to dazzle and flash blindness.

### Training

Commanders must understand the importance that training has on a soldier and the unit's ability to complete the mission. When troops are well trained, they can survive and fight on a contaminated battlefield. Poorly trained troops may not be able to recognize a nuclear attack. Well-trained troops can do their jobs, while in a nuclear environment. They know tasks take longer, but are able to adjust their procedures and/or work rate accordingly.

## Chapter 1

**Vulnerability Analysis**

The focus of this field manual is nuclear contamination avoidance. Like most concepts in the Army, contamination avoidance is a process. This process involves:

- Identifying the threat facing friendly forces.
- Identifying whether friendly units are a target.
- Understanding the operational concerns and impact of nuclear contamination.
- Locating nuclear hazards on the battlefield.

By identifying and locating nuclear hazards on the battlefield, units will be able to either avoid the hazard or implement the protective procedures outlined in FM 3-4 to minimize the affects. It should be emphasized, at this point, that if threat forces posses nuclear weapons, they also probably possess chemical and/or biological weapons as well. Therefore, US forces must be prepared to operate in an NBC environment. But, for the purpose of this manual, contamination avoidance principles will center only on nuclear operations.

Before we begin the discussion of contamination avoidance, we must first discuss two critical, often overlooked, aspects of successful operations on the contaminated battlefield. These two aspects are nuclear threat assessment and vulnerability analysis. Both are described in this chapter.

With the current trend in nuclear proliferation, the nuclear threat now and in the future will be global. The proliferation of nuclear-capable nations in all contingency regions increases the likelihood of US forces being targets of nuclear attack. The extensive development worldwide of nuclear power plants presents an additional nuclear hazard condition if these facilities are damaged deliberately, inadvertently, or by industrial accident.

As Chapter 1 to FM 3-100 points out, nuclear weapons technology proliferation is increasing. Deploying US forces must be capable of accurately assessing the nuclear threat imposed by the opposing force and be capable of addressing unit vulnerability to attack. Chapter 2 in FM 3-100 describes in detail how nuclear weapons may be used and how their use may shape the battle.

When planning operations, commanders must consider the potential effects of nuclear weapons on personnel and equipment. In conventional operations, concentration of forces increases the chance for success, but this same

concentration increases the effects of nuclear attacks and the likelihood of their occurrence. Commanders must decide what size of force to use and when they should be concentrated.

To assess a unit's vulnerability to nuclear attack, the commander determines how well protected the unit is and the type and size of weapon likely to be used against it. The commander then weighs various courses of action and determines which presents an acceptable risk to allow accomplishment of the mission. This whole process starts with the Intelligence Preparation of the Battlefield (IPB) and an initial assessment of the nuclear threat.

**The IPB Process**

The IPB process is a staff tool that helps identify and answer the commander's priority intelligence requirements (PIR). It's part of the operational planning that is necessary for battle management.

IPB is initiated and coordinated by the S2 and used to predict battlefield events and synchronize courses of action. IPB is designed to reduce the commander's uncertainties concerning weather, enemy, and terrain for a specific geographic area in a graphic format. It enables the commander to see the battlefield: where friendly and enemy forces can move, shoot, and communicate; where critical areas lie; and where enemy forces (and his own) are most vulnerable. IPB guides the S2 in determining where and when to employ collection assets to detect or deny enemy activities. These assets, working collectively, fulfill intelligence requirements and answer the PIR. IPB is the key for preparing for battle. It analyzes the intelligence data base in detail to determine the impact of enemy, weather, and terrain on the operation and presents this information graphically. It is a continuous process which supports planning and execution for all operations. IPB consists of a systematic five-function process:

- Evaluation of the battlefield (areas of operation and influence).
- Terrain analysis.
- Weather analysis.
- Threat evaluation.
- Threat integration.

On the battlefield, units will have incomplete intelligence concerning enemy nuclear capabilities and/or intentions. Commanders must ensure that the IPB becomes an integrated process through which key members of the staff contribute. IPB is a process involving intelligence and operations personnel. It must also be integrated with input from chemical officers.

Chemical officers and NCOs, in coordination with the S2/3, must address nuclear warfare during all phases of the battle. This is accomplished only by direct participation in the IPB process. Working with the S2, the chemical staff accomplishes the following:

- Generate template(s) of potential nuclear targets or areas of contamination.
- Designate templated areas that influence the scheme of maneuver as named areas of interest (NAIs).
- Include NAIs in the collection plan, and identify indicators.
- Include designated NAIs in the reconnaissance and surveillance (R&S) plan, and designate responsibility for confirming or denying the template.

Using the IPB process, the chemical officer or NCO provides the commander updates on the nuclear situation.

Based on the time periods of interest, the chemical staff will provide the battle commander the following:

- Detailed information on enemy nuclear capabilities, based on the type of units and weapons the enemy has available in the area of operations/area of influence (AO/AI) during a selected period.
- How the enemy would employ nuclear weapons to support his battle plan.
- Areas of likely employment based on threat employment doctrine.
- Detailed analysis of terrain and weather in the unit's AO during each period of interest, and how they could impact on nuclear weapons.
- Templates of predicted fallout data which are updated as conditions change.
- Alternative actions the commander can initiate prior to the phase time line in question so as to minimize degradation of forces.
- Continuous monitoring of intelligence messages and radio traffic for any nuclear related information that could be important to the unit's mission.

It is important that the chemical officer/NCO be succinct during the commander's briefing or have his information presented by the S3 during his portion of the briefing. Therefore, for input to be addressed, chemical personnel must be players in the IPB process. Although it is developed under the direction of the S2, once completed, the decision support template (DST) becomes an operational document and is briefed to the commander by the S3. If the chemical staff is an active participant in the IPB process, and is determined to serve the commander, then they must work within that process in developing the DST and R&S plan. Through this participation, the

chemical staff best serves the commander as special staff warfare experts. The DST must include nuclear concerns and visually present them to the commander.

During battle management activities, the chemical staff advisor works with the S2 on the IPB. He or she coordinates with the intelligence officer to analyze and identify nuclear targets based on threat, terrain, and the AO. Potential threat nuclear targets could be key terrain, choke points, command and control facilities, counterattack routes, mobility corridors, troop concentrations and/or rear area assembly points.

A nuclear vulnerability assessment constitutes an important part of battlefield assessment and risk analysis and is a primary means through which the chemical staff advisor participates in the battlefield assessment process. In this assessment, the chemical officer must develop information for integration into the various staff estimates. From the S2, the chemical officer or NCO obtains—

- Time of interest.
  - Threat probable courses of action and intent.
  - NAIs and target areas of interest (TAIs).
  - Summary of enemy activity, including any nuclear attacks, movement of nuclear equipment or material, presence and level of training of threat forces, and indicators of enemy nuclear warfare comments, such as queuing up weather radar.
- Specific items of interest from the S2 would be—
- Direction and speed of winds between 0 and 30,000 meters above the surface.
  - How weather conditions may affect fallout patterns.
  - Terrain.
  - Transportation assets (railways, airfields, road networks) available for shipment of nuclear munitions.
  - Availability and location of industrial assets capable of producing and/or weaponizing nuclear warfare material.
  - Availability of nuclear weapons, delivery systems, and location of stockpiles.

From the fire support officer (FSO), the chemical officer obtains information on casualty percentages from friendly and threat conventional munitions. Examples of information obtained include casualty percentages based on target size and casualty percentages based on weapon systems.

The chemical staff also should prepare a list, general in nature, of information compiled from various sources (such as news bulletins, spot reports, and intelligence summaries (INSUMs)). This information, when viewed as single events, may appear to be meaningless. However, when added to other pieces of information it may provide the key that connects the information and present the best view of the enemy's intent. Items of general information include, but are not limited to, the following:

- Availability of nuclear defense equipment to enemy forces.
- Amount of overhead cover or collective protection shelters or systems. If enemy forces seek overhead cover or move into

collective protection shelters, it may indicate that the enemy intends to use nuclear weapons.

- The enemy's stated national policy or philosophy on the use of nuclear weapons: Has the enemy declared a no-use, first-use, or limited-use only-for-retaliation-in-kind policy? Does the enemy consider the use of flame or smoke as NBC agents?
- Leadership. Is the enemy's national or military leadership willing to use nuclear weapons on their own territory or expose their own populations to the hazards generated by nuclear munitions?

- If the enemy does not possess munitions, the capability to deploy such munitions or expertise to employ them, have attempts been made to gain this ability? Reports indicating the presence of advisors from other nations working with enemy forces, international trade agreements or shipments of equipment (such as, fuzes, weapons-grade uranium) may provide insight to the enemy's intent.

Once information is gathered, it will provide input to the formulation of the nuclear threat status.

## Nuclear Threat Status (STANAG 2984)

US forces may not have to carry nuclear defense equipment (radiac equipment) based on the initial threat estimate. If the threat condition changes and indicators suggest the possible use of nuclear weapons by threat forces, this equipment would be deployed forward (to the division support area or to the brigade support area). These weapon stocks may be pre-palletized for immediate deployment by aircraft to the affected unit if required. However, this decision must be made based on available aircraft or other transportation systems. This could be done so that the forces would not have to carry the radiac equipment or dosimeters in their field packs or ruck sacks.

The minimum nuclear threat status is set at division or separate brigade level and is a flexible system determined by the most current enemy situation, as depicted by the continuously updated IPB process. This allows local commanders to increase the threat status if conditions change in their areas of operation. Threat status governs the initial deployment of nuclear defense assets (equipment or units) and the positioning of those assets on the battlefield or in the operational area. The nuclear threat status serial numbers are for planning purposes according to STANAG 2984. These numbers, however, may be substituted for a color code (Serial 0 = white; Serial 1 = green, etc.). It does, however, require chemical personnel at brigade and division level to stay abreast of the intelligence picture. The nuclear threat status is outlined in the following paragraphs:

### Serial 0 (none).

The opposing force does not possess nuclear defense equipment, is not trained in nuclear defense or employment, and do not possess the capability to employ nuclear weapons or systems. Further, the opposing force is not expected to gain access to such weapons; and if they were able to gain these weapons, it is considered highly unlikely that the weapons would be employed against US forces.

Under this status, a deploying force would not have to carry nuclear defense equipment. However, protective masks should be carried. Chemical personnel should

possibly concentrate efforts in chemical or biological operations, smoke, herbicides, flame field expedients (FFE), and monitoring threat communication channels for nuclear threat indicators.

### Serial 1 (low).

The opposing force has an offensive nuclear capability, has received training in defense and employment techniques; but, there is no indication of the use of nuclear weapons in the immediate future. This indication may be based on whether nuclear munitions are dispersed or deployed, or the stated objectives and intent of opposing forces.

Given this threat status, all personnel carry their personal defense equipment, or nuclear defense equipment stockpiles are identified and would be readily available for deployment to the operational area if the threat status should increase. NBC reconnaissance systems deploy to the operational area of interest to continue to provide a monitoring capability of the opposing force. Chemical personnel continue to concentrate their efforts in the areas listed under Serial 0.

### Serial 2 (medium).

The opposing force is equipped and trained in nuclear weapons defense and employment techniques. Nuclear weapons and employment systems are readily available. Nuclear weapons have been employed in other areas of the theater. Continued employment of nuclear weapons is considered probable in the immediate future. Indicators would be—

- Nuclear munitions deployed to either field storage sites or firing units.
- Enemy troops carrying protective equipment.
- Nuclear recon elements observed with conventional recon units.
- Decon elements moved forward.

Unit nuclear defense equipment should be either pre-palletized and located forward for easy access or issued to the soldiers responsible for use within the unit. Personnel and equipment should be kept under cover as much as possible to protect them from contamination.

Effective downwind messages (EDMs) should be sent out to subordinate units. Decontamination assets, NBC recon assets and smoke support should be deployed as part of the force structure. Detection and monitoring equipment should be issued to the operators. Unit should improve fighting positions and harden shelters if mission permits.

**Serial 3 (high).**

The opposing force possesses nuclear weapons and delivery systems. Nuclear defense equipment is available and training status is considered at par or better than that of the United States. Nuclear weapons have already been employed in the theater and attack is considered imminent. Indicators are—

- Nuclear attack in progress; but not in your area of operation.
- Nuclear warnings/signals to enemy troops.
- Nuclear munitions delivered to firing units within range of friendly forces.
- Movement of surface-to-surface missiles to launch sites.

US forces should deploy with nuclear defense equipment in the unit load. This will depend on the nuclear threat to the airfield or port at which they land. Soldiers should

ensure radiac equipment is serviceable prior to deployment. Decontamination and nuclear recon assets should be task organized and moved forward. Contingency stocks of nuclear defense equipment may be moved forward to the battalion trains. EDMs are initiated. Place collective protection systems into a state of readiness, including those systems in combat vehicles.

A threat status number can be used to represent a combined status for NBC, or it can be several numbers used to represent each category. It is possible to have a Chemical/Biological (CB) status of three and a nuclear status of zero. This threat status provides the commander with guidance for deployment and operational purposes. It allows the commander to tailor chemical units to fit any situation.

It also must be understood that the threat status can change rapidly. Although a nuclear status of zero may exist during deployment, the opposing force may seize industrial products or obtain nuclear weapons from a sponsoring nation. Therefore, the ground commander must be capable of upgrading the NBC defense posture quickly.

To assist in the formulation of the threat status, the chemical staff, (in conjunction with the S2) must analyze all information received. A tool in this

analysis is the Threat Status Matrix in Figure 1-1.

More than one matrix may be necessary to determine the threat status for nuclear, biological, and chemical attack.

To use the matrix, place an "X" in the appropriate block. Add each column; and whichever column has the most X's provides a means to identify what threat status serial number could be used to indicate the enemy force intent. If an overall threat status cannot be determined due to an informational shortfall, collection assets should be reallocated or positioned to gain the needed information.

Once the threat status estimate has been assessed, the chemical staff must analyze the protection level required for friendly forces. This is accomplished by modifying the MOPP analysis process contained in FM 3-4. Key factors include analyzing mission, environment, and soldier factors. These key factors are discussed in FM 3-4 and listed below:

- Understanding the mission and commander's intent for friendly forces.
- Capabilities and level of training of friendly forces.

Condition	Serial Number			
	0	1	2	3
<b>A. Enemy force information:</b> <ul style="list-style-type: none"> <li>• Training status</li> <li>• NBC equipment availability.</li> <li>• In collective protection shelters, in Positions with overhead cover, or exposed</li> </ul>				
<b>B. Nuclear weapon systems:</b> <ul style="list-style-type: none"> <li>• Availability of nuclear weapons.</li> <li>• Nuclear weapons moved forward to firing units or launch sites?</li> <li>• Weather radars queued?</li> <li>• Decon/recon assets forward?</li> </ul>				
<b>C. Enemy CB Policy and Capabilities:</b> <ul style="list-style-type: none"> <li>• What is enemy's stated policy on nuclear weapons employment?</li> <li>• Can enemy produce nuclear weapons?</li> <li>• Has industrial output increased or changed for production of nuclear munitions or protective equipment?</li> </ul>				
<b>D. Current Situation:</b> <ul style="list-style-type: none"> <li>• Have nuclear weapons been used in theater?</li> <li>• Is weather favorable for nuclear attack?</li> <li>• Is terrain favorable for nuclear attack?</li> </ul>				
<b>E. Totals (circle current status).</b>				

Figure 1-1. NBC threat status matrix.

## FM 3-3-1

- Availability of nuclear defense equipment and decon assets. In this regard, information may be obtained from the S2 or G5.
  - Other factors include—
- Location and availability of additional building materials to harden shelters.
- Location of civilian chemical manufacturing and storage facilities. In the event of a nuclear attack, these areas may be targeted or damaged, multiplying the hazard to friendly forces. Also, chemicals or hazardous materials stored in these facilities may produce areas of contamination if storage containers leak (either intentional or unintentional). To assess these hazards and how such a leak may impact on operations, refer to DOT Regulation 5300.3 and DOD Regulation 4145.19-R-1.
- Availability of civilian contracted labor and water transport for decon operations.
- For urban areas, location of car washes. These car washes may be used in lieu of operational decon stations. Obtain data on local fire hydrants (location, type of connections, etc.). Hydrants may be used to provide water for decon operations.
  - The chemical staff must properly prepare the threat status and identify the protection level required for friendly forces to withstand a nuclear attack. This information is vital to the commander and for the successful accomplishment of the mission. The commander may be required to reallocate or position units on the battlefield to reduce vulnerability to an attack.

## Nuclear Vulnerability Analysis

A unit's vulnerability to nuclear attack depends on the yield of the warhead likely to be used, the protection available to the unit, and how well dispersed the unit is. Tables 1-1 through 1-3 help estimate the damage caused by a nuclear detonation. This information will help the commander determine unit vulnerability to nuclear attack. These tables are simplified and safesided. They assume that the worst case of a nuclear burst will occur at ground zero (GZ) (see FM 101-31-1) and that all target elements will be dispersed uniformly throughout the target area.

**Immediate Permanent Ineffectiveness (IP)**—Personnel become ineffective within 3 minutes of exposure and remain ineffective until death. Death usually occurs within one day.

**Immediate Transient Ineffectiveness (IT)**—Personnel become ineffective for any task within 3 minutes of exposure and remain so for approximately 7 minutes. Personnel recover to greater than 75 percent of their pre-exposure performance levels after about 10 minutes and remain so for about 30 minutes. Then their performance degrades for around 5 hours, for undemanding tasks or 2 hours for demanding tasks, when radiation sickness becomes so severe that they are

ineffective. They remain ineffective until death, which usually occurs in 5 to 6 days.

**Latent Lethality (LL)**—is the physiological response from a dose of 650 cGy (RADs). For physically undemanding tasks, performance degrades about 3 hours after exposure and remains so for approximately 2 days, when personnel will recover combat effectiveness for 6 days or so. Then they relapse into degraded performance and remain so for 4 weeks after exposure when radiation sickness becomes so severe that they are ineffective. They will remain ineffective until death approximately 6 weeks after exposure. For physically demanding tasks, personnel performance degrades about 2 hours after exposure and remains so for three weeks, when radiation sickness becomes severe enough to render the personnel ineffective. They remain ineffective until death approximately 6 weeks after exposure.

**Physically Demanding Tasks**—Personnel become less than 25 percent effective within 2 hours of exposure and remain so for 3 weeks, at which time radiation sickness symptoms will be present in sufficient severity to render them ineffective. Personnel will remain ineffective until death in approximately 6 weeks.

Radiation casualties, with these three categories in mind,

become performance-based. Recent studies by the Defense Nuclear Agency and the Ballistic Research Laboratory reveal that lethal dosage varies from subject to subject and according to the physical demands of the task to be performed. Thus, dosage is expressed in terms of LD 50/30: the dose that will prove to be lethal to 50 percent of the exposed population within 30 days.

In an active nuclear environment, the more concentrated a unit is, the more lucrative the target becomes. If the unit itself is not the target,

**Table 1-1. Radiation casualty criteria (performance-based).**

Response	Criteria Initial Dose in Centigray (cGy)
Immediate Permanent Ineffectiveness	8,000
Immediate Transient Ineffectiveness	3,800
Latent Lethality	650

but falls within the fallout pattern, unit monitors will be capable of providing the commander with essential information regarding the hazard. Nuclear hazard prediction is covered in more detail in Chapter 3.

Based on vulnerability radius and unit size, commanders may determine the risk to the unit from a nuclear attack and whether or not to adjust unit dispersion. However, personnel may not be the target. Often, a unit's equipment, due to sensitivity and vulnerability, may be the target.

Additional information concerning planning factors and operational exposure guidance may be obtained in Appendix A to this FM. Additional information concerning shielding afforded by particular vehicles and structures, commonly referred to as transmission factors, can be found in Chapter 3 and Appendix B.

A more detailed discussion of nuclear vulnerability analysis can be found in FM 101-31-1. The information

presented in Tables 1-2 and 1-3 (below and next page) are for planning purposes only. See FM 101-31-2 (S) for actual vulnerability radii.

### Casualty and Damage Assessment

When assessing casualties or damage, the coverage tables consider only blast and nuclear radiation effects. The combined coverage of the two effects is listed. Thermal casualty data are included in the effects tables.

### Safety Distance Assessment

Blast, thermal radiation, and nuclear radiation were considered for assessing safety distances, and the largest radius of safety is listed. For calculations, friendly troops

**Table 1-2. Radii of vulnerability (distance in meters).**

Category	Personnel In—(LL) (Based on governing effect)					Moderate Damage				Severe Damage		
						Wheeled Vehicles		Tanks	Towed Arty	Supply Depot	Randomly Parked Helicopters	
	Open	Open Foxholes	Exp	Shld	Cargo Trans	Light Observ						
Yield (KT)	Open	Open Foxholes	APC	Tanks	Earth Shelter	Exp	Shld	Tanks	Towed Arty	Supply Depot	Cargo Trans	Light Observ
0.1	700	600	600	500	300	200	150	100	100	100	400	500
0.5	900	800	800	700	450	300	250	200	200	200	500	800
1	1,200	900	900	800	500	400	350	300	250	250	700	1,100
2	1,700	1,000	1,100	900	600	500	450	400	300	300	850	1,300
3	2,000	1,100	1,200	1,000	700	600	500	500	400	450	1,000	1,600
5	2,500	1,200	1,250	1,100	800	700	600	600	500	500	1,200	1,900
10	3,200	1,300	1,300	1,250	900	800	700	700	600	600	1,500	2,500
15	3,700	1,400	1,400	1,300	950	900	800	800	700	700	1,800	2,800
20	4,000	1,500	1,450	1,400	1,000	1,000	900	900	800	800	1,900	3,400
30	5,000	1,600	1,500	1,500	1,100	1,200	1,100	1,000	900	950	2,200	3,700
40	5,500	1,700	1,600	1,600	1,200	1,400	1,250	1,100	1,000	1,200	2,500	4,100
50	6,000	1,800	1,700	1,700	1,300	1,700	1,500	1,200	1,200	1,400	2,700	4,500
100	8,000	1,900	1,800	1,800	1,400	2,200	1,900	1,300	1,300	1,700	3,200	5,700
200	12,000	2,000	1,900	1,900	1,500	2,500	2,000	1,500	1,500	1,900	3,700	6,200
300	14,000	2,100	1,950	1,50	1,600	3,000	2,100	1,600	1,600	2,000	3,800	7,100

**Note:** 1. Radii listed are distances at which a 5 percent incidence of effect occurs.  
 2. Height of Burst (HOB) used is 60W<sup>1/3</sup> meters.

To obtain a radius of vulnerability, enter the Yield column at the nearest listed yield. If your yield is exactly halfway between listed yields, enter with the larger yield. Data listed in Table 1-2 is for training use only. Use the data in FM 101-31-2 (S) whenever possible.

Table 1-3. Comparable target table.

Secondary Targets (from Effective Tables)			Primary Targets in Coverage Tables					
			Exposed Personnel	Personnel in Open Foxholes	Personnel in Tanks	Moderate Damage to Tanks	Moderate Damage to Towed Artillery	Moderate Damage to Wheeled Vehicles
			LL	IT	IT			
Factories (25-50 ton Crane Capacity)	All Yields	Severe Damage				●		
Fixed Bridges	≤55 KT	Severe Damage					●	
Floating Bridges	≤55 KT	Severe Damage					●	
Missile/Rockets In Open	≤100 KT	Severe Damage						●
Railroad Boxcars and Flat Cars (loaded)	All Yields	Severe Damage						●
Tracked Vehicles (not tanks)	All Yields	Severe Damage					●	
Heavy Towed and Self-Propelled Artillery	All Yields	Moderate Damage				●		
Personnel in Brick Apartment Buildings	≤55 KT	LL	●					
	≤10 KT	IP			●			
Personnel in APCs	≤100 KT	IP		●				
Personnel in Earth Shelters	All Yields	LL		●				

**Methodology for Obtaining Comparable Target Coverage from Covered Tables**

1. The radius of damage for the listed secondary targets will equal the radius of damage for the primary target. Therefore the coverage for the secondary target will be at least that shown for the corresponding primary target in the appropriate coverage table.
2. For other secondary targets that have not been tabulated above, there is no general relationship between the secondary target response function and a primary response function. However, there is a methodology with which an approximate coverage can be obtained from the coverage tables for some of these targets. If more accurate target analysis is required, the numerical method should be used.

**The procedure is outlined below:**

- a. From a coverage table of the weapons system and yield being analyzed, determine the height of burst for the gun/launcher-target range.
- b. Use the effects tables to determine the desired radius of damage for the secondary target using the height of burst just selected.
- c. Find the radius of damage for a primary target that comes closest to the secondary radius of damage. (Stay at the same height of burst, yield and system.) For radiation sensitive secondary targets use only radiation primary targets and for blast sensitive targets, use only blast primary targets.
- d. Enter the coverage table for the primary target category selected and for the radius of target in question, read the appropriate coverage (if the primary target radius of damage used is less than that of the secondary target, then the coverage to the secondary target will be at least that of the primary target. If the primary target radius of damage used is greater than that of the secondary target, then the coverage to the secondary target will be at most that of the primary target.)



are assumed to be in one of three vulnerability categories and exposed to one of three levels of risk.

### Vulnerability Categories

**Unwarned, Exposed—Personnel** standing in the open at time of burst, but drop to prone position before the blast wave arrives. They may have areas of bare skin exposed to direct thermal radiation and may suffer temporary loss of vision. This category also applies to civilian personnel in open areas.

**Warned, Exposed—Personnel** prone on open ground, with all skin areas covered, and with an overall thermal protection at least equal to that provided by a two-layer, summer uniform. Troops have been warned, but do not have time to dig foxholes.

**Warned, Protected—Personnel** have some protection against heat, blast, and radiation. Protected categories include tanks, armored personnel carriers, foxholes, weapons emplacements, and command posts and shelters.

### Risk Criteria

**Negligible Risk** —Largest radius corresponding to 1 percent casualties or 2.5 percent nuisance effects.

**Moderate Risk** —Largest radius corresponding to 2.5 percent casualties or 5 percent nuisance effects.

**Emergency Risk** —5 percent casualties (nuisance effects not specified).

### Nuclear Radiation Safety

**Negligible Risk** —50 cGy for previously unexposed troops.

**Moderate Risk** —70 cGy for previously unexposed troops.

**Emergency Risk** —150 cGy for previously unexposed troops.

### Primary Targets

For personnel primary targets, the combined effects of blast casualties and radiation casualties are considered in coverage and effects tables. For materiel primary targets, only blast is considered.

**Exposed Personnel.** Unless otherwise stated, this term refers to personnel in the open, regardless of physical posture or uniform. Radiation casualties are determined based on free-in-air doses sufficient to cause IP (8,000 cGy), IT (3,000 cGy), or LL (650 cGy), as identified in Table 1-1. Blast casualties are determined from

overpressures sufficient to cause severe injury from decelerative tumbling or lung damage.

**Personnel in Foxholes.** This term refers to personnel in 1.8-meter-deep open foxholes, each with a 0.3-meter-firing step. Blast overpressures of 296 kilopascals (kPa) (43 psi) cause lung hemorrhage, which is the blast injury mechanism for producing casualties to personnel in foxholes. Nuclear radiation radii is computed, using foxhole transmission factors. Foxhole collapse is no longer considered the governing casualty producing effect.

**Personnel in Tanks.** Severe damage to tanks was used to find blast radii for casualties to personnel in tanks. Nuclear radiation radii were computed, using transmission factors for medium tanks with radiation liners.

**Moderate Damage to Wheeled Vehicles.** Although the term "wheeled vehicles" originally referred to 2-1/2-ton trucks and 1/4-ton vehicles other than WWII jeeps, it also applies to HMMWV and other vehicles smaller than 2 tons.

### Targeting Terms and Criteria

#### Definitions for Structures

**Severe Damage (Sev).** A degree of structural damage that precludes further use of a structure for the purpose for which it was intended, without essentially complete reconstruction. Generally, collapse of the structure is implied.

**Moderate Damage (Mod).** A degree of structural damage to principal load-carrying members (trusses, columns, beams) and walls that precludes effective use of a structure for the purpose for which it was intended, until major repairs are made.

**Light Damage (Lit).** A degree of damage that results in broken windows, slight damage to roofing and siding, blowing down of light interior partitions, and slight cracking of curtain walls in buildings. Generally, structures receiving light damage can be used as intended, with only minor repairs and removal of debris.

#### Definitions for Vehicles

**Severe Damage (Sev).** Damaged, nonfunctional, very difficult to repair. At least one subsystem is nonfunctional and not repairable.

**Moderate Damage (Mod).** Damaged, nonfunctional, repairable with special tools, skills, and parts. At least half of all subsystems (engine, power-train, tracks, etc.) are not functional, but are repairable.

## Analysis of Friendly Unit Vulnerability

Two techniques to evaluate friendly unit vulnerability to nuclear detonations are (1) a technical approach (unit dispositions are compared with the effects of an expected weapon yield), and (2) an operational approach (unit dispositions are compared with targeting criteria used by the threat target analyst).

### Vulnerability Analysis

The primary tool for analysing friendly dispositions is the radius of vulnerability (RV). RV is the radius of the circle within which friendly troops will be exposed to a risk equal to, or greater than, the emergency risk criterion (5-percent combat ineffectiveness) and/or within which material will be subjected to a 5-percent probability of the specified degree of damage. See Table 1-2 or 1-3 version of the RV table in FM 101-31-2, Chapter 15. The GZ for the RV is always assumed to be the point where detonation will do the greatest damage to the friendly unit or installation. Delivery errors are not considered.

Analyzing the vulnerability of friendly dispositions and installations consists of—

- Determining the appropriate threat yields based on current intelligence.
- Determining the disposition of personnel in friendly units.
- Obtaining the appropriate vulnerability radii from the RV table.
- Estimating fractional coverage for each target category, using the visual, numerical, or index technique. For the purposes of this discussion, the visual technique will be used. Although this technique is considered the least accurate, it is the easiest method to use for the field commander. For additional information concerning the visual, numerical, or index, refer to FM 101-31-1, Chapter 4.

- Recommending ways to decrease vulnerability or increase protection if the estimated damage exceeds the acceptable loss criteria established by the commander.

### Visual Technique

Outline the unit battle position on the tactical map. Using a compass, a piece of plastic with the radius of vulnerability drawn to scale on it, or a circular map scale. Superimpose the radius of vulnerability chosen from Table 1-2 or 1-3 over the target area.

The GZ used for the analysis is the location that would result in the highest fractional coverage of the target.

From this worst-case GZ and the appropriate RV, an estimation of the percentage of casualties or materiel damage that might result from an enemy nuclear strike may be determined.

Using the center point of the compass, template, or circular map scale as the GZ, choose the GZ that would result in the highest fractional coverage of the target area. Visually estimate the percent of the unit covered by the RV.

If this fractional coverage yields unacceptable losses of personnel or equipment, the commander must then make a decision on how to best reduce this casualty rate. This may be done by adding shielding as outlined in Appendix B, erecting the vulnerability reduction measures outlined in FM 3-4, or highlighted later in this chapter. A tactical decision may also be made to reduce vulnerability.

If a mechanized battalion occupies a battle position 5 km wide, and 2.5 km deep, it could be positioned as in Figure 1-2. Target elements are uniformly dispersed in the area. In this example, the RV or personnel in APCs to a 5-kt weapon is shown with GZ at worst case. Since 50 percent

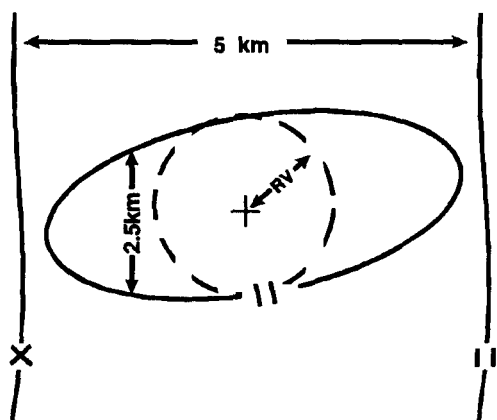

Figure 1-2.

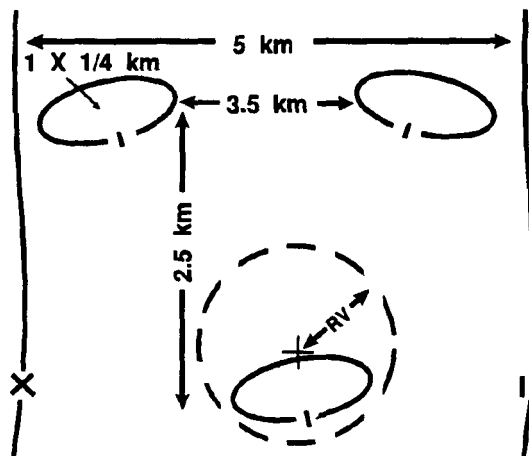

Figure 1-3.

of the battalion is covered by the RV of the 5-kt weapon, then up to 50 percent of the battalion's personnel in APCs could become casualties. Obviously, the risk to a unit in this particular battle position is extremely high.

When the same battalion deploys in three company or team battle positions in depth, the distances between positions significantly reduce the damage, even assuming the weapon detonates at the optimum GZ. In Figure 1-3 although one company is 100 percent vulnerable, the battalion is only 33 percent vulnerable. Thus, one company may have up to 100 percent casualties, but the battalion may only have 33 percent casualties.

When the estimated fractional coverage exceeds acceptable loss criteria, develop alternate courses of action (COAs) to reduce the nuclear vulnerability of the friendly unit or facilities by—

- Dispersal
- Increased protection
- Maintaining positions in close proximity to enemy forces
- Using passive measures such as operational security (OPSEC), deception, and/or camouflage.

When mitigation actions are taken, reanalyze, using adjusted data.

## Vulnerability Reduction

Active measures prevent the enemy from using nuclear weapons. Passive measures increase survivability.

Individual and unit collective measures are only discussed briefly here. See FM 3-4 for detailed information.

### Active Measures

Active measures are those taken to find and destroy either the munitions or the delivery systems. Destruction of delivery systems and munitions is the best method of reducing the chances of being attacked.

The destruction of stockpiles of nuclear munitions and production facilities is usually beyond the capabilities of lower level commanders. Echelons above corps (EAC)

have the responsibility and sufficient assets for finding and destroying these targets.

Corps and divisions do not have the capability to locate and destroy stockpiles or production facilities; but they do have the capability to find and destroy delivery systems. Recon flights, counterbattery radar, and other intelligence collection assets are used to find delivery systems, such as long-range cannons and missile systems.

### Passive Measures

It is not possible to destroy all threat nuclear munitions and/or delivery systems. Units must always take precautions to avoid being targeted or to reduce the effects of an attack if one does occur. These are passive measures. All units must use passive measures as part of normal operations to reduce the effects of operating under nuclear conditions. These measures include—

- Plan ahead.
- Avoid detection.
- Provide warning.
- Maintain discipline.
- H Seek protection.
- Disperse.
- Remain mobile.
- Cover supplies and equipment.
- Limit exposure.
- Prevent spread of fallout.
- Follow unit SOPs.
- Camouflage.

#### Plan Ahead

Tasks take longer to perform in a nuclear environment. Again, FM 3-4 contains tables to help commanders estimate how long it takes to accomplish missions in a nuclear environment. Commanders must take time to carefully think out courses of action and allow for the additional time requirement. This is commonly referred to as wargaming. A bad decision could cause the unit to become needlessly contaminated or suffer casualties. Use the nuclear threat status for planning and stocking nuclear defense equipment. Units must prepare to continue the mission after a nuclear attack. Following an enemy nuclear strike, commanders must quickly assess the damage and reconstitute lost or weakened units.

#### Avoid Detection

Avoiding detection is the best way to prevent nuclear attacks. Do this by employing good OPSEC measures. These include camouflage, light discipline, and especially,

## FM 3-3-1

signal security. Both active and passive measures must be used to prevent the enemy from gaining target information. Use defensive electronic warfare; electronic countermeasures (ECM) and electronic counter-countermeasures (ECCM) to reduce the chances of identification and location. In the nuclear environment, it is even more important that commanders consider displacing if detection and/or identification is suspected.

### Provide Warning

If the unit is unable to avoid a nuclear attack, early warning of battlefield hazards is very important. The NBCWRS notifies units that adjacent units have been attacked or that a downwind hazard is present. When no NBCWRS warning is received, periodic monitoring, discussed later in this manual, is essential. Troops must be able to identify nuclear attacks and take appropriate actions. NBC recon teams, using the NBC Reconnaissance System (NBCRS), alert moving units before they enter contaminated areas.

### Maintain Discipline

The unit must maintain discipline and confidence in its ability to survive and operate if it is to overcome the shock of a nuclear attack and continue the mission. Commanders must be able to rely on their troops not to give up hope or lose the sense of duty. Again, plan ahead. Use these plans whenever possible during unit training. Use the information contained in FM 3-4 to assist in developing unit plans.

### Seek Protection

Natural terrain may provide shelter from the effects of nuclear weapons. Ditches, ravines, and natural depressions reduce initial nuclear effects.

Foxholes with solid overhead cover and shelters offer good protection against nuclear weapons. However, any overhead cover such as tents, tarpaulins, and ponchos offer at least some protection from fallout. Use NBC protective covers (NBC-PCs) to protect equipment whenever possible.

### Disperse

Combat service support (CSS) installations and troops in compact assembly areas are vulnerable to nuclear weapons. Commanders must determine how much dispersion is needed. Dispersion must reduce vulnerability but not hinder operations or prevent the unit from concentrating when necessary. Supplies, especially food, POL, and ammunition, must be dispersed so they will not all be destroyed at once. The more dispersed a unit is, the longer it will take to do even routine tasks. The degree of

acceptable dispersion depends upon mission, enemy, terrain, troops, and time available (METT-T).

### Remain Mobile

Tactical mobility gives the commander the best chance for avoidance. Constant movement prevents the enemy from pinpointing locations and accurately employing nuclear weapons. However, the battlefield will be a difficult place in which to maneuver. Contaminated areas, tree blowdown, urban rubble, fires, flooding, fallout, and craters are obstacles that must be dealt with. NBC recon teams and the serving S2/G2 can provide useful information. The best source of information on mobility routes, however, is the movement control center (MCC).

### Cover Supplies and Equipment

Store supplies and equipment under cover to prevent contamination. Buildings offer excellent protection from fallout. Field expedient methods are abundant.

NBC protective covers, tarpaulins, pallets, packing materials, dunnage, and plastic (sheets, bags, and rolls) all can be used. Field expedient covers, especially canvas and cardboard, provide protection from fallout for a short period. Contamination seeps through all such covers; however, NBC-PCs provide protection for up to 24 hours. Units must replace covers as soon as possible after heavy contamination. Although these covers may provide protection against fallout, a contact hazard will remain until the dust on the ground and on the protective cover has decayed.

### Limit Exposure

All plans should include postattack procedures for limiting exposure to radiological hazards. Amount of exposure is important. Every minute spent in a radiologically contaminated environment increases a person's total radiation dose. Only personnel required to accomplish a mission are sent into a contaminated area.

Limit exposure with time. By waiting to enter a contaminated area, the contamination level will decay and with it the chance of exposure. Exposure can also be accidental. Personnel may not know that equipment is contaminated. Usually, this can be prevented by always marking contaminated equipment. But there are places where nuclear contamination hazards can accumulate, such as air filters. All engines have air filters that trap nuclear contaminants. These contaminants accumulate. So even if the hazard area is small, it can be deadly. Persons working around equipment should be aware of hidden hazards. Always dispose of contaminated collectors, such as air filters, as contaminated waste.

## Prevent Spread of Contamination

Limiting the number of personnel and amount of equipment in the area helps prevent the spread of contamination. Make every effort to confine nuclear contamination to as small an area as possible. This begins with monitoring to determine the amount and extent of contamination. It also reduces the amount of decon required. Units moving from a contaminated area into a clean area should decontaminate at or near the edge of contamination. Mark all contaminated areas, and report them to other units to keep them from entering the contaminated area unknowingly.

Contaminated material presents additional problems to limiting the spread of contamination. If the situation permits, material can be left and allowed to decay. If the equipment is mission essential, it must be decontaminated on the spot or brought back to the rear and decontaminated.

If the situation permits, decontaminate as far forward as possible. If this is not possible, then material may have to be transported to the rear for decontamination. If contaminated material must be moved, keep in mind that the amount of contamination transferred to the road network or ground surface is directly proportional to the amount of contamination on the material, location of the contamination, and type of surface on which the

contamination is present. Precautions or safety measures to take, when moving this equipment are—

- Notify the MCC of contaminated vehicles or contaminated routes.
- Use as few transport vehicles as possible.
- Use one route (especially around congested areas).
- Monitor the route periodically for contamination.
- Cover the material to keep contamination from being blown onto the road. (Weigh the risk of ground contamination with the additional burden of decontamination/disposing of potentially contaminated covering material).
- Warn personnel downwind if a vapor hazard is present.
- Monitor and decontaminate transport vehicles before transporting noncontaminated material.
- Ensure transport crews wear protective masks to reduce the hazard from airborne radioactive particles.

There may be instances in which contaminated material or waste material must be disposed of or destroyed. Bury the contaminated material. Burial is effective for all types of contamination. Mark and avoid the area where contaminated waste is buried. Procedures for marking contaminated waste burial sites is outlined in FM 3-5. This consists of submitting an NBC 5 nuclear report, outlining the contaminated waste burial site. However, this report must be sent by the NBCC, so that line item Alpha, (strike serial number) may be assigned. The unit, therefore, that closes the decontamination site must notify the NBCC.

Chapter 2

# NBC Warning and Reporting System

The primary means of warning units of an actual or predicted nuclear hazard is the NBCWRS. It is a key in limiting the effects of nuclear attacks. The NBCWRS allows units to determine required protective measures and plan operations. Units take action depending on the mission

and type of hazard present. If the mission allows, affected units alter plans to avoid the hazard. Otherwise, the units upgrade protective measures and occupy or cross the hazard area. Units use the NBCWRS as battlefield intelligence.

## Standard NBC Reports

The NBCWRS, to support radiological defense, consists of five reports. Each is standardized by ATP 45/STANAG 2103 and the US Message Text Format (USMTF). The United States and its NATO, British, Canadian, and Australian (ABCA) allies use the same message formats.

This improves the accuracy, comprehension, and interoperability of the system. It also increases the speed of dissemination and submission. The five standard reports used to exchange information are—

- NBC 1—initial report, giving basic data compiled at unit level.
- NBC 2—Report used for passing evaluated data.
- NBC 3—Report used for immediate warning of predicted contamination and hazard areas.
- NBC 4—Report used for passing monitoring and survey results.
- NBC 5—Report used for passing information on areas of actual contamination.

The reports use standard formats to shorten the message being passed. The warning and reporting system is based on a code letter system. The meaning and use of each letter used to transmit an NBC message is described in Table 2-1. The following paragraphs describe each report. Specific instructions

**Table 2-1. Meaning of line items in NBC reports.**

Line	Nuclear	Remarks
A	Strike serial number	Assigned by NBC center
B	Position of observer	Use coordinates Universe transverse mercator (UTM or place)
C	Direction of attack from observer, to include unit of measure	Deg magnetic north (DGM) or mils (MLM) Deg true north (DGT) or mils (MLT) Deg grid north (DGG) or mils (MLG)
D	Date-time of detonation	Use Zulu time.
E	NA	
F	Location of area attacked	Use grid coordinates (or place). State whether the location is actual or estimated.
G	Suspected or observed event and means of delivery or kind of attack	State whether attack was by artillery, mortars, rockets, missiles, or bombs.
H	Type of burst	Specify air, surface, subsurface or unknown.
I	NA	
J	Flash-to-bang time	Use seconds.

—Continued

## NBC 1 Report

The NBC 1 report is the most widely used report. The observing unit uses this report to provide nuclear attack

data. All units must be completely familiar with the NBC 1 report format and its information. The unit must prepare this report quickly and accurately, and send it to the next higher-headquarters.

**Table 2-1 continued.**

Line	Nuclear	Remarks
K	Presence or absence of crater and diameter.	Send in meters.
L	Cloud width at H + 5 minutes	State whether measured in degrees or mils.
M	Stabilized cloud top or cloud bottom angle or cloud top or bottom height at H + 10 minutes.	State whether angle is cloud top or cloud bottom and whether measured in degrees or mils. State whether height is cloud top or cloud bottom and whether measured in meters or feet.
N	Estimated yield	Send as KT.
O	Reference date-time for estimated contour line when not H + 1 minute.	Used when contours are plotted at other than at H + 1 minute.
P	Radar purposes only. PA—Coordinates of points to outline external contours of cloud. PB—Downwind direction of radioactive cloud in degrees or mils.	
PAR	Coordinates of external contours of radioactive cloud.	Six-digit coordinates. Letter R identifies RADAR set.
PBR	Downwind direction of radioactive cloud and unit of measure.	Deg magnetic north (DGM) or mils (MLM) Deg true north (DGT) or mils (MLT) Deg grid north (DGG) or mils (MLG). Letter R identifies RADAR set.
Q	Location of reading	UTM or place
R	Dose rate or actual value of decay exponent.	State dose rate in cGyph. See sample NBC 4 for terms associated with this line.
S	Date-time group of reading	State time initial identification test sample or reading was taken.
T	H + 1 date-time group	NBC 5
U	1,000-cGyph contour line	Plot in red.
V	300-cGyph contour line	Plot in green.
W	100-cGyph contour line	Plot in blue.

—Continued

Battalion and higher elements decide which NBC 1 reports to forward to the next higher headquarters. If several reports are received on the same nuclear attack, then a consolidated NBC 1 report is forwarded, instead of separate reports. This reduces the number of reports to a manageable level. NBC 1 reports are not routinely passed to corps or higher NBC centers (NBCC) except for the initial use report. Precedence of the NBC 1 report depends on whether or not it is an initial report. The initial use report is FLASH precedence, all others are IMMEDIATE precedence.

Individuals identified by unit SOP submit raw data to the unit NBC defense team at company/battery or troop level. NBC 1 format should be used. However a Size, Activity, Location, Unit, Time, Equipment (SALUTE) or Spot report may also be used. And should be submitted to the unit's NBC defense team. The unit NBC defense team normally consists of the unit chemical NBC NCO (54B20) or an NCO that has been school trained at an area NBC defense two-week school, an officer and an enlisted soldier (corporal or above) who has attended the same two-week school. These soldiers will have the special duties at unit level of advising the commander on NBC defense matters and formatting NBC reports.

Normally, the unit NBC defense team checks NBC 1 reports. This ensures that the content of the report is known to the commander or his or her representative. It also ensures that the report is in the proper format and is as correct as possible.

All data observations are sent in a single, complete NBC 1 report. Do not divide data into two parts to create a subsequent report. NBC 1 reports are not used as attack notification. They simply pass data. Separate procedures must be developed for attack notification and are beyond the scope of this manual. Attack notification may take the form of a SALUTE, Spot, or Situation Report (SITREP) report and should be addressed in detail in unit standing operating procedures (SOPs.)

The first time a nuclear weapon is used against US forces, the designated unit will send the NBC 1 report with a FLASH precedence. Each intermediate headquarters will forward the report with a FLASH precedence (or IMMEDIATE precedence, if a previous NBC 1 report has been forwarded). For the first NBC 1 nuclear report in the brigade, use FLASH precedence. If the report is of a second attack within the division, use IMMEDIATE.

The observer determines the date-time of attack, flash-to-bang time, illumination time, type of burst, location of (GZ) or azimuth to attack, and stabilized nuclear cloud measurements. Under conditions of limited visibility, the observer determines illumination time. Chapter 3 lists equipment needed to make necessary observer calculations.

Personnel qualified to operate this equipment gather data, such as azimuth to the attack from the observer, observer location, and cloud width at H+ 5 minutes, or cloud top/bottom angle at H+ 10 minutes. Aerial observers report cloud top/bottom height at H+ 10 minutes. If such equipment is not available to the unit, use the lensatic compass to take measurements as accurately as possible.

If the unit is a designated observer unit, it may submit a subsequent NBC 1 nuclear report if new data concerning actual GZ location or the presence or absence of a crater is obtained. Nondesignated observer units should not submit subsequent reports unless requested. By choosing designated observer units, the NBCC can limit the number of reports and ensure the accuracy of the reports received.

Electromagnetic puke (EMP), transient radiation effects on electronics (TREE), blackout, and an active enemy electronic warfare threat will also take their toll on our communications systems. NBC 1 reports will have to compete with urgent requests for status and damage information from the affected and nearby areas.

All reports from ground observers must contain line items Bravo (position of observer), Delta (date-time group), Hotel (type of burst), and either Charlie (direction of attack) or Foxtrot (actual or estimated location of attack). If line item Lima (cloud width) is reported, the report must contain line items Bravo and either Charlie or Foxtrot.

All reports from aerial observers must contain line items Bravo (position of observer) and Charlie (direction of attack) or Bravo (position of observer) and Foxtrot (actual location of attack) if cloud width (line item Lima) is reported.

Transmit only those line items of the format for which data are available. Use the word "Unknown" only with line item Hotel (type of attack).

Transmit line item Mike (cloud top/bottom angle at H + 10) only when data for line item Lima (cloud width) cannot be obtained.

### NBC 2 report

The NBC 2 report is based on one or more NBC 1 reports. It is used to pass evaluated data to higher, subordinate, and adjacent units. Division NBCC is usually the lowest level that prepares NBC 2 reports. However, brigade and battalion NBC personnel may prepare the NBC 2 report if they have sufficient

Table 2-1 continued.

Line	Nuclear	Remarks
X	20-cGyph contour line (30 cGyph contour line is used by other NATO forces).	Plot in black.
Y	Direction of left and right radial lines.	Direction measured clockwise from grid north (GN) to the left and then to the right radial lines (degrees or mils, state which), 4 digits each.
Z	Effective wind speed Downwind distance of Zone I Cloud radius  (Include unit of measure for each category.)	3 digits—effective wind speed (kmph or knots). 3 digits—downwind distance of Zone I (km or nautical miles). 2 digits—cloud radius (km or nautical miles). If wind speed is less than 8 kmph, this line contains only the 3-digit radius of Zone I (km).
ZI	Used only for friendly bursts	3 digits—Effective downwind speed: 4 digits—Effective downwind Zone 1 distance in 100s of meters. 4 digits—Effective downwind Zone 2 distance in 100s of meters. 3 digits—Cloud radius in 100s of meters.



data. However, these units will not assign a strike serial number.

Division NBCC prepares the NBC 2 nuclear report, assigns it a strike serial number, and disseminates it to the appropriate units. Each subordinate unit then decides whether to disseminate the report further. Subsequent data may be received after the NBC 2 nuclear report is sent. If this data changes the yield or GZ location, send this data in an NBC 2 nuclear update report. Use the same strike serial number and date-time of attack. Line items Alfa (strike serial number), Delta (date/time group), Foxtrot (location of attack), Golf (means of delivery), Hotel (type of burst), and November (yield) are always contained in the NBC 2 nuclear report.

### NBC 3 Report

Division NBCC uses the NBC 2 reports and the current wind information to predict the fallout area. This is sent as an NBC 3 report. It is sent to all units that could be affected by the hazard. Each unit plots the NBC 3 report and determines which of its subordinate units are affected and warns those units accordingly.

The NBC 3 report is a prediction of the fallout area. This prediction is safesided to ensure that a militarily significant hazard will not exist outside of the predicted hazard area. In other words, Zone I will represent areas where the dose rate will exceed 150 centigray per hour (cGyph) within 4 hours; and Zone II is no more than 50 cGyph in 4 hours and less than 150 cGyph in 24 hours. Commanders should use the report as battlefield intelligence when planning missions.

When a unit is in a fallout area, the commander must decide whether to stay or move. This decision is based on the mission, exposure status of the unit, and higher headquarters guidance. As the ANBACIS is improved, the commander will be able to view the modeled hazard area on a computer screen instead of basing his decision on the safe-sided STANAG plots. This will provide a more realistic depiction of the hazard area. ANBACIS is addressed in more detail later in this chapter.

The NBC 3 nuclear report (fallout prediction) is used to plan recon and survey operations. If time is critical, units may also use it to plan operations. Lines Alfa (strike serial number), Delta (date/time group), Foxtrot (location of attack), Yankee (left and right radial lines), and Zulu (effective wind speed, downwind distance of Zone I, and cloud radius) are used for a nuclear hazard.

### NBC 4 Report

When any unit detects NBC hazards through monitoring, survey or reconnaissance, this information is reported using an NBC 4 report. Separate NBC 4 reports are consolidated and then plotted on the tactical map to show

where the hazard exists. If monitoring information is incomplete, a survey may be directed. Line items Quebec (date-time group of reading), Romeo (dose rate), and Sierra (location of reading) are reported for a nuclear hazard. These items are used as often as necessary to complete the report. Other items may be included if available and necessary to complete the report.

NBC 4 nuclear reports are normalized to H + 1 readings, as necessary, and plotted on the map. From this data a contamination plot overlay is created. This overlay is sent to all units. Methods used to send the overlay to the field are, in descending order, computer data base update, electrical facsimile, messenger, liaison officer, and the NBC 5 report. Chapter 5 contains examples of NBC 4 reports. In any case, NBC 4 reports will contain only correlated data. The raw readings must be correlated and reflect the true hazard (outside) for that time.

### NBC 5 Report

The NBC 5 report is prepared from the contamination plot. This report is last in order because it consists of a series of grid coordinates. Often this message must be sent on FM radio nets. This requires lengthy transmission. The recipient is required to plot each coordinate and redraw the plot. Line items Alfa (strike serial number), Delta (date/time group), Foxtrot (location), Tango (H+ 1 date-time group), or Oscar (reference time), Romeo (dose rate), Uniform (1,000 cGyph), Victor (300 cGyph), Whiskey (100 cGyph), and X-Ray (20 cGyph) may be reported for radiologically contaminated areas.

For most avoidance situations, only the outer boundary of the area is necessary. Complete details can follow later on the facsimile or messenger-delivered plot. Some contamination situations cannot be reported through use of the NBC 5. These are areas of neutron-induced contamination. These areas must be reported via the overlay.

With the exception of line item Alfa, when a user has previously received data through other NBC reports, the data need not be repeated on the NBC 5.

For example, a unit receives an NBC 3 showing GZ location (line item Foxtrot). The GZ location does not have to be reported on the NBC 5.

The NBC 5 nuclear report is also used to transmit the decay rate of fallout to field units. All units assume decay rate of fallout to be  $n = 1.2$  until informed otherwise. The NBCC determines the decay rate and sends a report such as the one below:

```
NBC 5 Nuclear
A 52N002
R 1.6
```

This message may be sent before or after a contamination plot has been received. Since decay rate of fallout will decrease with time, the report could be sent

several times during the period of interest for a contaminated area. The NBC 5 report is also used to report the closure of a decontamination site. The NBC 5 report

should include coordinates for the site and sump, so as to notify other units of the contamination area.

## **Managing the NBC Warning and Reporting System**

Managing the NBCWRS is crucial for the success of a command. To be useful, nuclear information must be collected, reported, and evaluated. Once evaluated, it can be used as battlefield intelligence. Obtaining and converting nuclear information into usable nuclear intelligence does not just happen. The volume of information that needs to be collected and reported could easily disrupt both communications and tactical operations if not properly managed. This section describes what information is available and how that information gets to the person or unit needing it.

### **Collecting Nuclear Information**

The first step in managing the NBCWRS is to determine what information is available and who is available to collect it. Two types of data must be collected. Observer data provides information that a nuclear attack has occurred. Monitoring, survey, and recon data provide information on where the hazard is located.

Every unit is responsible for observing and recording nuclear attacks. But every unit does not automatically forward NBC 1 reports.

Many units may observe a nuclear burst. But if every unit forwarded a report, nothing would get through. For this reason, selected units with equipment to make accurate measurements submit NBC 1 nuclear reports. These units are called designated observers. The division NBCC selects designated observers and lists them in the FSOP/OPORD/OPLAN.

Additional units are selected during tactical operations based on their physical locations. They are listed in the operations order. The designated observer unit is discussed later in this chapter. Only selected units automatically submit NBC 1 nuclear reports to the NBCC.

### **Monitoring, Survey, and Reconnaissance Data**

NBC 1 reports allow the NBCC to predict where the hazards will be. This prediction (NBC 3 report) is only an estimation of the hazard area. Feedback is needed from units to determine exactly where the contamination is located.

This feedback comes from monitoring, survey, and recon (NBC 4 reports). Monitoring and recon operations give the initial location of NBC hazards to the NBCC. Initial monitoring and recon reports are generally forward through intelligence channels to the NBCC. This information may also be sent to the NBCC by ANBACIS. ANBACIS is the automated NBC information system and is described later in this chapter.

The NBCC then plots the information on the situation map. If more information is needed, the NBCC directs a unit (picked because of its location and/or capability) to collect and forward the necessary data. This unit may be an organic company NBC defense team or an NBC reconnaissance platoon from the divisional chemical defense company.

Special operations forces will depend on special forces operational detachments (SFOD) with attached LB teams, special forces group (SFG) Chemical detachments, or organic company NBC defense teams. The reconnaissance platoon may be tasked organized to support a maneuver brigade in NBC reconnaissance collection efforts. This information could be from additional monitoring reports or a survey of the area in question.

Collecting nuclear information is a joint effort of units and the NBCC. The unit does the actual collecting of information. The NBCC plans for and directs the collection effort. The division FSOP/OPORD/OPLAN should describe who collects and forwards nuclear information for evaluation. More detailed information concerning this collection effort is addressed in Chapter 5 and in FM 3-19.

## **Evaluating Nuclear Information**

After nuclear data has been collected, it is evaluated. It is then used as battlefield intelligence. The NBCC is the primary evaluation center. Units and intermediate headquarters use the raw data to develop nuclear

intelligence for their own use until detailed results are available from the NBCC.

## Unit Procedures

The outer perimeter of militarily significant contamination is the important information for the unit. Unit procedures are simplified and less accurate than NBCC procedures. Emphasis is on speed rather than accuracy. Fallout predictions are estimated quickly using simplified predictions. NBC 4 reports are plotted, but minimal effort is spent in analyzing the degree of contamination.

With exception of designated observer reporting units, intermediate headquarters (such as battalion and brigade)

consolidate and screen NBC reports. By doing this, they reduce the number of reports sent to the NBCC.

## NBCC Procedures

Procedures used at NBCCs are more detailed and complex than those at unit level. They are based on information from the entire division area and are more accurate than unit procedures. NBCC procedures also take more time to complete. This is why units use a simplified procedure while waiting for the NBCC analysis.

NBC 2, NBC 3, and NBC 5 reports from division NBCC always supersede those done by subordinate units.

## Transmitting Nuclear Information

Procedures used to transmit nuclear information to and from the NBCC are an important part of the NBC information system. Figure 2-1 shows the direction that various NBC reports travel. Usually the flow is through the chain of command: from company to battalion to brigade to division. There are exceptions to this:

- The NBCC may request information such as survey information. The unit doing the survey may report directly back to division. This is especially true for aerial surveys. The monitoring unit must also send an information copy back to the parent unit for command and control (C<sup>2</sup>) and for recording of radiation exposure, if necessary.
- Designated observers send reports simultaneously to the NBCC, and parent organization.

- Attached or OPCON units may have no direct contact with a parent unit. In these cases the headquarters to which they are OPCON passes nuclear information.
- Units that operate independently (such as Military Police or Engineers) that are operating in an area will report through the headquarters controlling that area of operation, normally a brigade tactical operations center (TOC).

The method of transmitting information depends on the tactical situation and mission of the unit. Methods are specified in FSOP/OPLAN/OPORD and unit SOP. At brigade and higher headquarters, NBC reports usually are passed on the intelligence net rather than the command net. At battalion level and lower, there is generally only one FM net available. This net is required to communicate command information. Therefore, NBC reports should be formatted ahead of time and be as short and concise as possible. In this case, wire communications are best.

Support units use admin-log nets. However, these units need to also inform the brigade TOC or division TOC when operating in that unit's area of operations. Wire communications are excellent, if available. There are numerous methods to communicate nuclear information. One is ANBACIS, which accesses information from the maneuver control system (MCS). The NBCC should evaluate all possible methods and select those that best suit the purpose. Again, this information should be contained in the unit SOP or current operations order.

Each unit and command element has a specific function in a nuclear environment. This function is in addition to normal combat functions. The exception to this is the NBCC whose primary function is NBC operations. The preceding pages described procedures and requirements for collecting, evaluating, and transmitting nuclear information. This section described responsibilities at each command level and is intended to be a guide only.

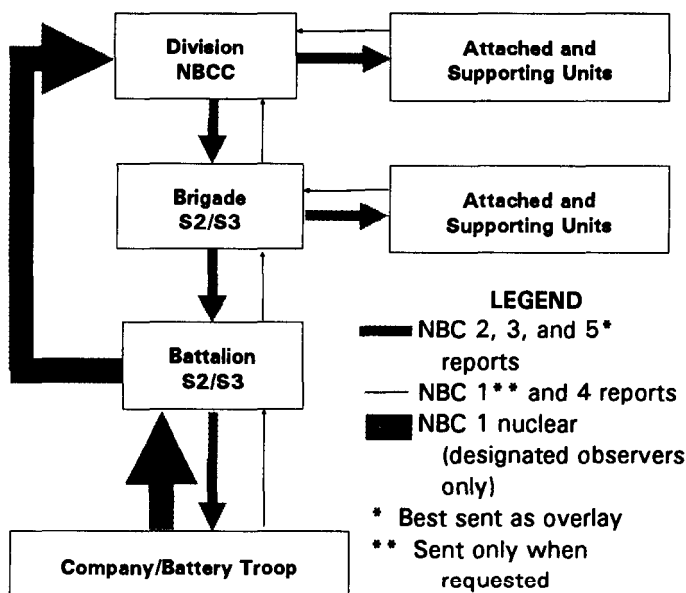

Figure 2-1. Flow of NBC reports.

## Unit Level

Unit level collection, processing, and analysis techniques are designed for rapid evaluation of nuclear data. The results are not as accurate as those obtained by the NBCC, but they are sufficient for planning until they can be replaced by those from the NBCC. Although analysis techniques are similar for company, battalion, and brigade, each level has specific responsibilities for collecting and processing nuclear information. The responsibilities are listed here (The major portion of nuclear information is collected and reported by company-, battery-, or troop-level units.):

- Report nuclear attack data, using the NBC warning and reporting system.
- Monitor for nuclear radiation.
- Plot simplified downwind hazards.
- Collect and forward soil and water samples.
- Conduct radiological surveys/reconnaissance.

Organization and training of personnel to perform these tasks must be according to AR 350-42.

## Battalion Level

The battalion level monitors the information gathering of subordinate units. Battalion chemical personnel ensure that each subordinate unit is trained. Battalion personnel also are trained to—

- Consolidate and forward nuclear reports.
- Estimate effects of nuclear hazards.
- Disseminate information on nuclear activities.
- Coordinate unit NBC recon activities with and through the battalion S2/S3 sections and with the chemical company platoon leader tasked to support the battalion.
- Coordinate with brigade to obtain additional smoke or decon assets, if required.
- Plan and supervise decentralized radiological surveys.
- Maintain a nuclear situation overlay.

## Brigade or Task Force Level

The chemical personnel at brigade must perform the same functions as battalion chemical personnel. Brigade personnel also must—

- Coordinate with other staff sections and advise them on nuclear matters.
- Plan and supervise decentralized radiological surveys.
- Collect information from and assist NBC personnel within the task force.

## NBCC Level

NBCC techniques involve more complicated procedures and are based upon the comparison of data from many sources. Much of this data is not available to a single unit. In addition to performing detailed analysis, the NBCC also—

- Receives, collates, evaluates, and disseminates reports of enemy nuclear attacks.
- Prepares and disseminates wind messages.
- Estimates the effects of enemy and friendly nuclear detonations and makes fallout predictions.
- Coordinates recon and survey activities with higher, lower, and adjacent units.
- Maintains an NBC situation map.
- Provides advise to G2 on nuclear intelligence matters.
- Provides technical assistance to all staff levels.
- Selects designated observers.
- Coordinates with other staff sections and advises those staff sections on nuclear matters.
- Provides technical assistance in the interrogation of POWs on nuclear matters. This technical assistance is generally in the form of providing the interrogator a list of questions to ask the prisoner. The questions may include employment tactics, NBC munitions, types of weapon systems available, and/or defence training status.

## Designated Observer System

Although all units have some information-gathering responsibilities, certain units, because of their capabilities and/or location, are chosen as designated observers for nuclear attacks. Designated observers must be as accurate as possible when providing data on nuclear bursts. Observers are selected to provide total coverage over the entire area of interest. This requires both ground and aerial observers. The designated observer system provides the essential data to prepare hazard location predictions and nuclear damage assessments. It provides raw observer data, using a standard report format. The NBCC specifies the primary and alternate means of communication.

### Designated Ground-Based Observers

Ground units are selected for the designated observer system based on the following factors:

- Battlefield location.
- Communication nets available.
- Mission (current and future) interference due to enemy action.
- Training and experience.
- Anticipated reliability of data.
- Possession of organic angle-measuring equipment.

Field artillery and air defense artillery units are best suited as designated observer units. These units have

organic optical equipment ideal for sighting measurements. See FM 101-10-1 for more information about which divisional units have this equipment. These items, in order of preference, are—

- M2 aiming circle.\*
- M65 or M43 battery command periscope.
- T16 or T2 theodolite.
- M2 pocket transit.

Any other unit (for example, a mortar platoon) having this or similar equipment may be designated an observer. Radar should also be considered. Many radars can define the nuclear cloud. Field artillery and air defense artillery radars are positioned in the division and corps areas.

*\*This equipment is preferred because it is set to grid north (GN) and measures in mils.*

## Designated Aerial Observers

Aircraft provide excellent observer coverage for nuclear attacks. The NBCC coordinates with the appropriate

aviation officers to have several aircraft crews designated as observers. The aviation unit commander selects the crews. Designated aircrews are instructed to report data about the type of attack and when and where it occurred. If aviators measure cloud parameters, they must also provide the location from which it was measured.

Aviators have the advantage of height. They are able to see and report actual GZ locations. They also can see and estimate crater width. Such data is usually not obtainable from ground observer units.

## Nondesignated Observers

All units are required to record (in the prescribed format) their observations concerning nuclear strikes. Nondesignated observer units or any battalion or brigade units that have not been specifically tasked will transmit their reports only on request. However, these units must report a nuclear attack only to the next higher headquarters according to local SOP.

# Friendly Nuclear Attack Warning

Friendly troops close to an attack could be subjected to the same casualty-producing effects as the enemy. Advance warning of a friendly nuclear attack ensures that friendly forces can protect themselves from the effects of the attack. This warning is in the form of a STRIKWARN message. OPSEC and SIGSEC measures are taken to prevent the enemy from intercepting the warning message and taking protective measures.

## Responsibility

The executing commander is responsible for initiating the warning. Commanders authorized to release nuclear attacks must ensure that attacks affecting the safety of adjacent or other commands are coordinated with those commands. Attack notification will normally be transmitted from the division NBCC or from DIVARTY. This gives adjacent commands enough time to warn their personnel, take protective measures, and prepare to exploit the weapons' effects.

STRIKWARN messages must be sent to—

- Subordinate headquarters whose units are likely to be affected by the attack.
- Adjacent land, air, and naval headquarters that may be affected by the attack.
- Next higher levels of command, when units not under the command of the executing commander may be affected by the attack.
- All aviation units and ground units that have aviation assets attached.

Warning of impending attacks is initiated no earlier than necessary to warn personnel. Use any means of communication (preferably secure) to ensure all affected personnel are warned. It is crucial that all friendly forces, down to the lowest level, have time to react to the warning and take appropriate precautions.

Warning messages should be classified according to current OPSEC instructions and the speed of dissemination required. If secure electronic means are not available, the message should be encoded. STRIKWARN messages may be sent in the clear if the issuing commander determines that safety warnings override security requirements. Do not send a warning message in the clear earlier than 60 minutes before the attack. Lines Delta and Foxtrot of the STRIKWARN should not be sent in the clear. The word "STRIKWARN" is never sent clear text.

Battalion is the lowest level to receive a STRIKWARN message. At no time will messages be transmitted below battalion level. Instead, subordinate units are given specific instructions on what actions to take. These instructions are brief and use the code words and formats described in unit SOP/FSOP/OPORD/OPLAN. They include—

- Code word indicating type of attack.
- A brevity code that describes the specific action to be taken.
- Expected timed attack.

When a nuclear attack is cancelled, units previously warned must be notified by the fastest means available. The cancellation message consists of line item Alfa from the STRIKWARN plus the word "cancelled." Line item Delta of the attack warning should be used also. Units

## FM 3-3-1

receiving cancellation messages must always request authentication from the sender.

### STRIKWARN Messages

As with the other NBC messages, STRIKWARN messages have been standardized. The United States and its NATO and ABCA allies use the same message formats. This speeds transmission of messages and improves accuracy and understanding. The meaning and use of each line item is described in Table 2-2, next page.

Alfa, Delta, Foxtrot, Hotel, and India are the only line items transmitted for a STRIKWARN. If fallout is produced and will be a hazard to friendly troops, send an NBC 3 nuclear report to all affected units. Figure 2-2, (page 2-9), shows examples of STRIKWARN messages in standard and USMTF formats.

The closer a unit is to a nuclear attack, the greater are the precautions it must take. That is why there are three minimum safe distances (MSDs) in the STRIKWARN. Each MSD corresponds to a degree of protection needed to remain in the area. Thus, if a unit cannot achieve the protection required, it must exit that zone. Table 2-3 (page

2-10) explains the relationship between MSD and protection.

The protection requirements in Table 2-3 are for negligible risk to all personnel—the preferred risk. If the commander decides additional risk is necessary, the protection can be modified. Appendix A describes the risk categories in greater detail. Refer to it before making any decisions. The protection requirements chart (Table 2-3) is set up primarily for ground troops. Aircraft are sufficiently protected if they remain outside MSD3. However, pilots are susceptible to dazzle and may be affected at much greater distances.

When a unit receives a STRIKWARN message, the first action is to plot it on the tactical map. This identifies ground zero and how far the effects will extend. The commander can then determine what action to take. Figure 2-3, (page 2-10), shows a plotted STRIKWARN for a single burst.

The Alfa team in Figure 2-3 will have to dismount and get in foxholes with overhead cover or evacuate the area. On the other hand, Bravo team must, as a minimum, assume a prone position. Battalion headquarters would only have to be concerned with dazzle and EMP.

(Text is continued on page 2-10)

**Table 2-2. Meaning and use of STRIKWARN line items.**

Line Item	Meaning
A	Target number, nickname, or code word
D	a. Multiple burst. Date-time attack (pulse) will start, followed by date-time attack (pulse) will end (Zulu time). b. Single burst. Date-time of attack, followed by date-time after which attack will be cancelled (Zulu time).
F1	a. Multiple. UTM grid coordinates of MSD 1 box. b. Single. MSD 1, in three digits, in hundreds of meters, followed by UTM grid coordinates of GZ or DGZ. (If more than one MSD is included, GZ or DGZ will be included only in the first Foxtrot line sent).
F2	a. Multiple. UTM grid coordinates of MSD 2 box. b. Single. MSD 2 in three digits, in hundreds of meters (followed by UTM grid coordinates of GZ or DGZ, if first Foxtrot line sent).
F3	a. Multiple. UTM grid coordinates of MSD 3 box. b. Single. MSD 3 in three digits, in hundreds of meters (followed by UTM grid coordinates of GZ or DGZ, if this is the only Foxtrot line sent).
H	If one or more bursts has less than 99 percent assurance of being an airburst, or if it is a scheduled surface or subsurface burst, indicate "surface", preceded by the total number of surface, and/or subsurface bursts. If only one burst is surface, number need not be sent. If all bursts are airbursts, do not transmit.
I	Number of bursts in multiple attack. If single burst, do not transmit.

**Single Airburst**

<b>Standard Format</b>	<b>USMTF Program Format</b>
STRIKWARN	STRIKWARN//
A AC 022	ALFA/AC022//
D 072220Z-072310Z	DELTA/072220Z/072310Z//
F1 011 NB706101	FXT ONE/011/32UNB706101//
F2 025	FXT TWO/025//

**Single Airburst (Only MSD 3 Transmitted)**

<b>Standard Format</b>	<b>USMTF Program Format</b>
STRIKWARN	STRIKWARN//
A AC016	ALFA/AC016///
D 061315Z-061325Z	DELTA/061315Z/061325Z//
F3 023NB669228	FXT THREE/023/32UNB669228//

**Multiple Bursts (All Airbursts)**

<b>Standard Format</b>	<b>USMTF Program Format</b>
STRIKWARN	STRIKWARN//
A Hot Candle	ALFA/HOT CANDLE//
D 130605Z-130715Z	DELTA/130605Z/130715Z//
F3 NB590167, NB521723, NB630350, NB600354	FXT THREE/32UNB590167/ 32UNB521723/ 32UNB630350/ 32UNB600354//
I 12	INDIA//12//

**Multiple Bursts (3 Surface Bursts)**

<b>Standard Format</b>	<b>USMTF Program Format</b>
STRIKWARN	STRIKWARN//
A Lamp Post	ALFA/LAMPPOST//
D 162025Z-162155Z	DELTA/162025Z/162155Z//
F3 PA490650, PA511671, PA537674, PA527650, PA515650, PA511656, PA505656, PA505650	FXT THREE/32UPA490650/32UPA511//671/ 32UPA537674/32UPA527650/ 32UPA515650/32UPA511656/ 32UPA505656/32UPA505650//
H 3 Surface	HOTEL/03/SURF//
I 22	INDIA/022//

*Figure 2-2. Examples of STRIKWARN messages.*

### FM 3-3-1

Nuclear weapons are often targeted as a group of weapons (package) to defeat a particular threat. It would be time consuming to send separate STRIKWARNs for every weapon in a package. For that reason, multiple bursts are grouped as a package, and the outer limits of the MSDs plotted as a box. The coordinates for the corners of the box are then transmitted. Plot the points nearest friendly troops first. Figure 2-4, (page 2-11), shows a plotted STRIKWARN for a multiple burst.

By drawing a box, large safe areas are included in the hazard area. If maneuver space is limited, additional coordinates could be added to the STRIKWARN. Figure 2-5, (page 2-11), shows a plotted STRIKWARN with additional coordinates added.

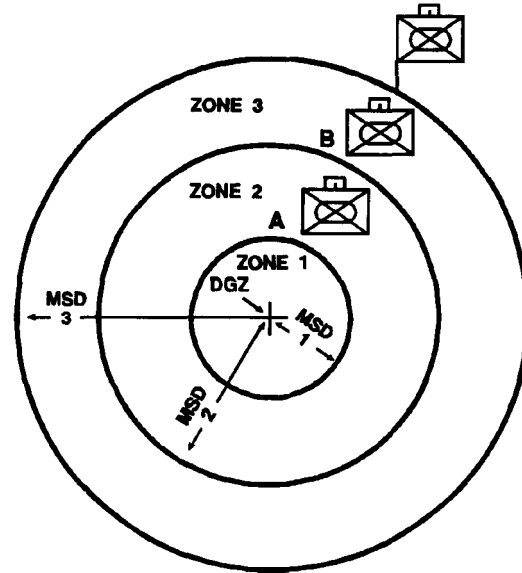

**Figure 2-3. Zones of warning for a single-burst friendly nuclear strike.**

**Table 2-3. Relationship between MSD and protection.**

Protection Requirements			
Radius	Corresponding To	Zone	Requirements
MSD 1	Limit of negligible risk to warned and protected personnel (See note 5)	1	Evacuation of all personnel (See note 4)
MSD 2	Limit of negligible risk to warned and exposed personnel	2	Maximum protection (See note 6)
MSD 3	Limit of negligible risk to unwarned and exposed personnel	3	Minimum protection (See note 7)
More Than MSD 3			No protective measures except against dazzle and EMP

**Note 1.** MSD means minimum safe distance.

**Note 2.** The MSD is equal to a radius of safety (RS) for the yield, plus a buffer distance (BD) related to the dispersion of the weapon system used. When surface bursts are used, or an intended airburst has less than a 99 percent assurance of no militarily significant fallout, the fallout hazard will be considered. Details will be transmitted in a subsequent NBC 3 Nuclear report if fallout will be a hazard to friendly units.

**Note 3.** Commanders will be guided to safety criteria as stated in FM 101-31-1.

**Note 4.** If a unit commander is unable to evacuate MSD 1, he will immediately require as much protection as possible and report through his next higher headquarters to the releasing/executing commander.

**Note 5.** Negligible risk should not normally be exceeded unless significant advantages will be gained.

**Note 6.** Maximum protection for ground forces denotes that personnel are in "buttoned up" tanks or sheltered in fox-holes with overhead protection.

**Note 7.** Minimum protection for ground forces denotes that personnel are prone on open ground with all skin areas covered and with an overall thermal protection at least equal to that provided by a two-layer uniform.

**Note 8.** Since the least separation distance (LSD) for light aircraft is exceeded by MSD 3, aircraft remaining beyond MSD 3 will avoid significant degradation of the airframe or pilot performance (except against dazzle) severe enough to prevent mission accomplishment.



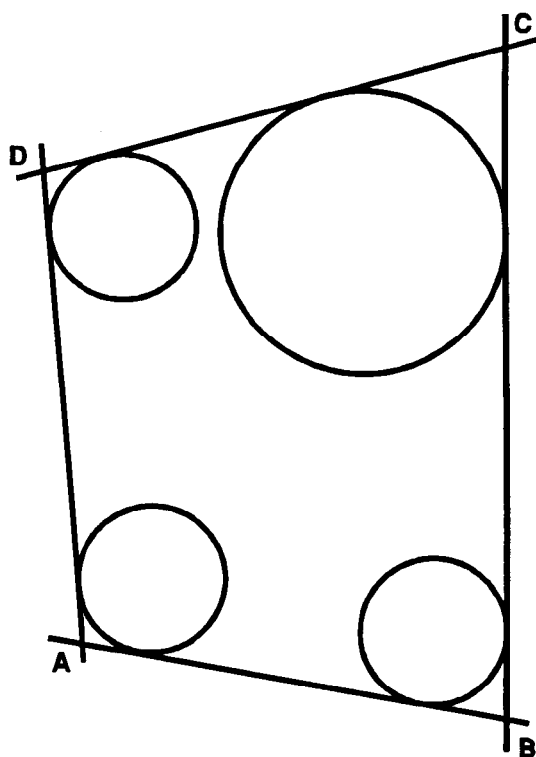

**Figure 2-4. Zones of warning for a multiple-burst friendly nuclear strike.**

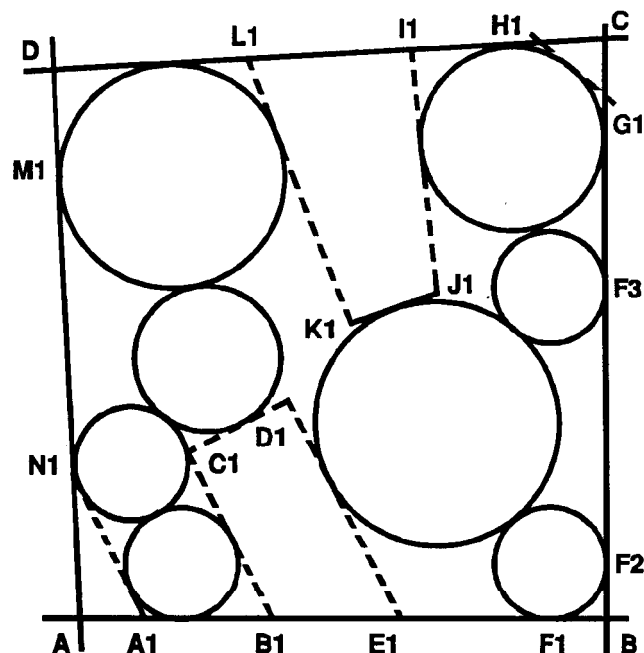

**Figure 2-5. Zones of warning for a friendly multiple nuclear attack when maneuver space is limited.**

## Automated Nuclear, Biological, and Chemical Information System (ANBACIS)

ANBACIS is a software information system that supports the chemical staff officer and NCOs, as well as chemical units (squad to brigade). It furnishes the communication, recordkeeping, and calculation of NBC warning and reports, tactical decision aids, and databases essential to accomplish their tasks. One module is the NBCWRS—an automation of the manual data processing described in this manual. ANBACIS was designed to operate on the Army Common Hardware and to operate in the stand-alone mode on any IBM compatible computer. ANBACIS is user friendly with drop-down windows.

It can receive any number of NBC 1 reports and create the correct number of NBC 2 reports. It will then convert

the NBC 2 reports to NBC 3 reports, using the correct weather information previously received electronically from the staff weather officer. It will take the basic wind report and create the effective downwind report in seconds. This is done without drawing the wind vector plots outlined in Chapter 3 and Appendix D.

It has other modules to create smoke plans and to calculate radiological/chemical problems and flamefield expedient operations.

For additional information on ANBACIS, refer to the ANBACIS user's guide.

## Chapter 3

# Introduction to Nuclear Operations

Under the threat of or in actual nuclear warfare, units in the field must continually evaluate the impact that enemy use of nuclear weapons could have on the conduct of operations. They must be prepared for contingency action to reduce the disruption caused by a nuclear attack.

Casualty-producing levels of fallout can extend to greater distances and cover greater areas than most other nuclear weapon effects. Such fallout levels can, therefore, influence actions on the battlefield for a considerable period. Knowledge and understanding of the radiological contamination aspects discussed in this chapter help the commander determine the advantages and disadvantages of each course of action open to him in the execution of assigned missions.

Fallout areas can be the largest contaminated area produced on the battlefield. There is one important aspect of fallout prediction: Winds aloft, as well as surface winds, determine where fallout will occur. Thus, the actual location of fallout can differ appreciably from that which might be expected from the direction of surface winds.

Fallout particles are often visible during hours of daylight. The arrival and settling of dustlike particles after a nuclear burst should be assumed to indicate the onset of fallout unless monitoring shows no radiation in the area. Any precipitation following a nuclear attack must be regarded as rainout from the nuclear cloud. Rainout will be discussed later in this chapter.

The neutron-induced area is small by comparison with the fallout area produced by the same yield nuclear weapon. It is often contained within the area of greatest destruction and collateral obstacles (tree blowdown, rubble, and fire). Frequently, there will be no need to enter the neutron-induced area. Units should move into neutron-induced areas only when necessary. If units are required to pass through GZ or occupy positions in the immediate vicinity of GZ, the induced radiation is operationally significant. Units will base their entry time and stay time on the radiation level present in the induced area. Induced radiation is discussed in more detail in Chapter 7.

The dose rate at any location within a contaminated area does not remain constant. The dose rate decreases with time. Thus, in time a radiation hazard will be of no military significance. The rate at which this decay takes place also varies with time, generally becoming slower as time passes. The decay rate for contamination in an area depends upon many factors. It generally cannot be determined until several series of dose-rate readings are taken for specific locations within the contaminated area. Standard decay conditions are therefore assumed by all units until actual conditions are determined or until higher headquarters directs otherwise.

## Nuclear Weapons Effects

To fully appreciate and understand the characteristics of radioactive contamination (fallout) from nuclear detonations, one must first have a basic working knowledge of the origin and nature of these radioactive materials. The overall effects of nuclear weapons depend on the type of weapon, the height of burst (HOB), the distance between the point of detonation and the target,

environment in which the weapon is detonated, and the vulnerability of the target.

The normal distribution of energy in a low air burst is depicted in Figure 3-1, next page. The primary focus of this chapter centers on only 15 percent of all energy released in a nuclear detonation. That energy is generally referred to as fallout (both initial and residual radiation) and electromagnetic pulse (EMP).

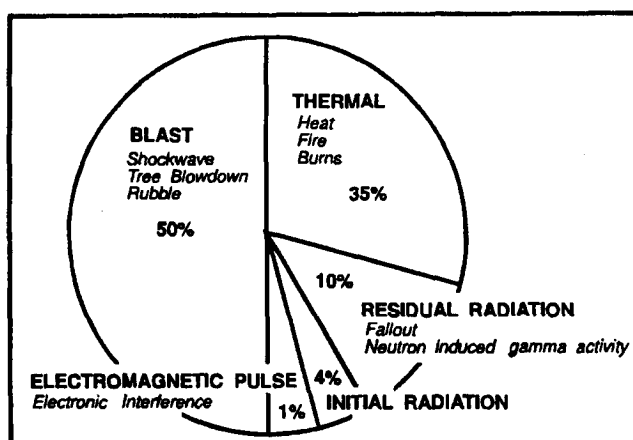

Figure 3-1. Distribution of nuclear burst energy.

## Initial Radiation Effects

Initial nuclear radiation is emitted within the first minute after detonation. For weapons with yields less than approximately 50 kiloton, initial nuclear radiation is usually the governing effect in target planning. It consists

primarily of neutrons and gamma rays. Both types of radiation, although different in character, travel considerable distances at the speed of light, and produce casualties.

## Residual Radiation Effects

Residual nuclear radiation is that emitted later than one minute after detonation. It consists of fallout, neutron-induced gamma activity (NIGA), and rainout. Residual radiation (fallout) comes from three basic sources: unused fissionable material, fission products, and neutron-induced activity. These three sources combined emit alpha, beta, and gamma radiation.

The most significant radiation is gamma radiation, which presents a serious personnel hazard because of its range and penetrating power.

Residual radiation is attenuated or scattered in the same manner as initial gamma radiation.

The biological response of humans to residual radiation is essentially the same as their response to initial radiation.

### Unused Fissionable Material

Despite the high technology used to produce a nuclear weapon, the weapon itself is still inefficient, to a certain extent, in that all of the fuel, or radioactive material, used to produce the weapon is not expended. This is, in effect, wasted fuel.

At the time of detonation, this wasted fuel is vaporized by the high temperatures of the fireball. As the fireball and subsequent cloud rises and cools, this wasted fuel, now in the form of a gas, condenses back to a solid state. These particles are carried by the wind and are scattered across the surface of the earth as fallout. These particles emit primarily alpha radiation. Considering, however, that alpha

only travels in the open air to 4 centimeters from the source and cannot penetrate one to two sheets of ordinary paper, it cannot penetrate the first layer of human skin. Alpha is considered an internal or inhalation hazard. In most situations this internal hazard would not affect the immediate military operation because its effects on the body would not be felt until many years later. Therefore, alpha is not considered to be tactically significant.

### Fission Products

In a fission reaction, the basic process that occurs is the splitting of relatively large atoms into much smaller atoms. These smaller atoms are the end result of the fission reaction; they are fission products. These smaller atoms formed in the reaction are atoms of elements in the middle of the table of elements, for example, atoms of mercury, tin, arsenic, iron, and lead. At the instant of the detonation, these fission products are formed as gas. Like the unfissioned bomb materials, they rise with the fireball and smoke cloud. As the cloud cools, they condense into solid particles, consisting of oxides of the elements mentioned above (and many others). These solid particles are carried along above the earth by winds. But, at the same time, they slowly settle toward the earth and appear as part of the fallout.

The isotopes of the elements formed in the fission reaction are radioactive and are, for the most part, beta and gamma emitters. As a result, they do represent a

significant contribution to the external hazard from fallout. They actually make the highest contribution, by far, to the gamma activity in fallout.

Beta radiation, emitted in this process has a general range in the open air up to 20 feet, from the source. Beta has the ability to penetrate 1/16 inch of aluminum and may penetrate the first few layers of skin. Beta radiation may also cause a burning of the skin similar to a first- or second-degree sunburn, or may cause extensive internal damage, similar to alpha, if inhaled. Therefore, like alpha, beta contamination is not considered tactically significant.

Gamma radiation, however, because of its range and penetrating power, is tactically significant and is the primary focus of the rest of this chapter.

Gamma radiation is not a particle or a dust, like alpha or beta. It does, however, penetrate material, but, does not make that material radioactive. Gamma radiation is pure energy traveling through space at the speed of light (186,000 miles per second). It is a form of electromagnetic radiation, differing only in frequency and source from more commonly known forms, such as X-rays, radio waves, and visible light.

Consider radio waves. The human senses cannot detect radio waves. We cannot see, taste, feel, hear, or smell them. The only way we can detect them and make them

audible is by the use of an instrument for detecting radio waves, namely, a radio. Similar statements apply to gamma radiation. The human senses are not capable of detecting it. We must have a special instrument for detecting it, an instrument called a RADIAC meter. Radiac meters measure gamma without regard to its source. The dose or dose rates of radiation measured may represent radiation from fallout, neutron-induced gamma activity, or a combination of these.

## **Neutron-Induced Activity**

The third form of radioactivity in fallout is neutron-induced gamma activity, commonly referred to as NIGA or induced radiation. When a nuclear weapon is detonated near enough to the ground to get significant damage or casualties, many of the neutrons released strike in the vicinity of ground zero and penetrate the soil up to a depth of one-half meter. As a result, some of the soil elements, such as sodium, aluminum, manganese, iron, and potassium, become radioactive when hit by neutrons, and produce fairly high dose rates of gamma and beta radiation. This type of residual radiation is called induced radiation. It appears immediately following the burst and can be tactically significant.

## **Effects of Fallout on Ships at Sea**

Ships out to several hundred miles from ground zero may be subject to fallout from surface and some sub-surface bursts. A forecast of the fallout pattern will enable them to take avoiding maneuvers or preventive measures.

Maneuvers to avoid fallout must be based on the naval effective downwind message (NAV EDM). Should it be necessary to pass through fallout, washdown or presetting systems (if available) should be activated, shelter stations assumed, and passage delayed as long as possible.

If these measures are taken, casualties from fallout should be negligible. Ships receiving no warning and remaining within this fallout zone longer than necessary without adopting these preventive measures may sustain serious casualties.

Fallout landing on the surface of the water is rapidly diffused, and there is very little danger to ships passing

through water where, for all practical purposes, deposition has ceased.

With the basic understanding of the energy distribution of a nuclear burst, coupled with the basic concepts of the origins of radiation, commanders can translate this information into usable data for tactical units. In determining where radioactive debris may fall on the battlefield, and thus affect those units operating in the area, one must also understand the characteristics of the nuclear cloud. This is important, because the presence or absence of a nuclear cloud will help in determining if the burst was a surface burst (which produces significant fallout). EMP is discussed in more detail in Appendix C.

The size of a nuclear cloud helps estimate yield. Yield estimation is essential in determining the extent of contamination, where the fallout will go on the battlefield, and the duration of tactically significant radiation.

## **Nuclear Clouds**

### **Detecting the Attack**

The development of nuclear clouds is divided into three stages: fireball, burst cloud, and stabilized cloud.

The fireball stage exists from the instant of the explosion until the generally spherical cloud of explosion products ceases to radiate a brilliant light. During this stage, do not

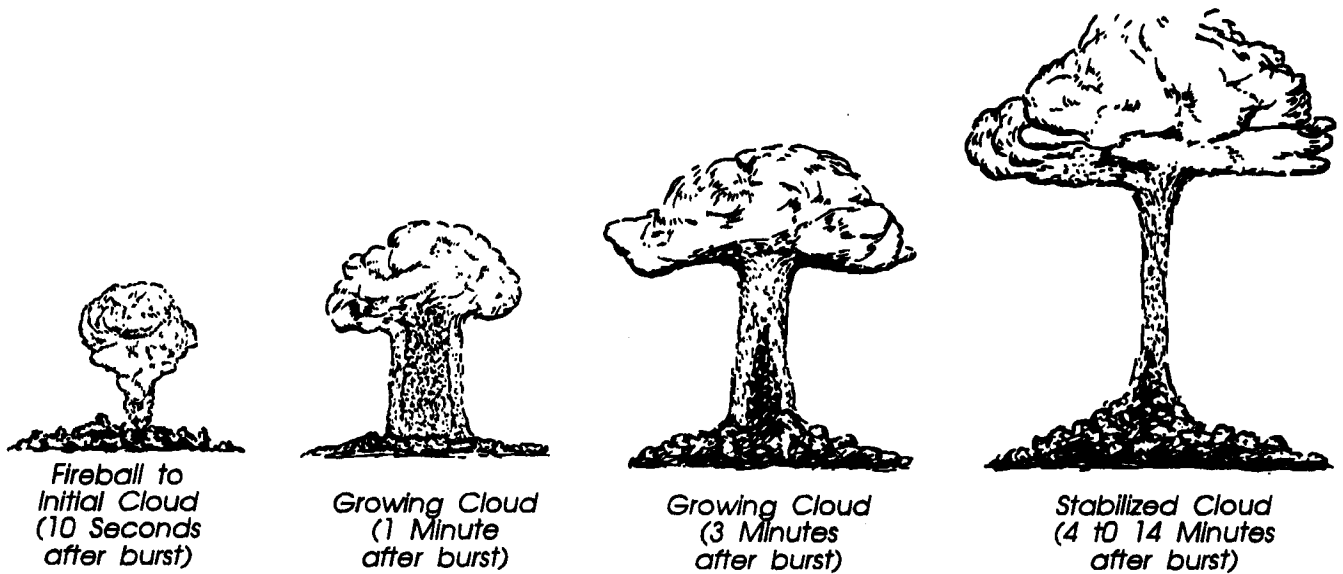

**Figure 3-2. Nuclear cloud development.**

look at the fireball. The brilliant light can cause permanent damage to your eyes.

As the brilliant light fades to a dull reddish glow, the fireball stage transforms into the nuclear burst cloud stage. At this point the cloud can be safely observed. The cloud may be either a spherical cloud (high airburst) or a mushroom-type cloud, with or without a stem (low air or surface burst). Relatively low-yield nuclear surface bursts have clouds similar to those produced by surface bursts of conventional explosives. Severe turbulence and rapid growth in cloud height and width are characteristic of this stage.

When the cloud ceases to grow in height, the stabilized cloud stage begins. Height stabilization occurs from about 4 to 14 minutes after the explosion, depending upon the

yield. Nuclear burst angular cloud width (line item Lima, as explained in Chapter 2, for an NBC 1 report), and stabilized cloud-top/bottom angle or height (line item Mike) are measured during this stage. Figure 3-2 illustrates the growth of a nuclear cloud. After height stabilization (4 to 14 minutes) the cloud continues to grow. This is due to wind, not nuclear energy. For this reason, cloud measurements are not taken after H+10 minutes.

Measurements of the nuclear burst cloud are taken at H+5 minutes (line item Lima) or at H+10 minutes (line item Mike).

Nuclear cloud measurements (parameters) have been correlated with yield. The results are in nomograms and on the ABC-M4A1 nuclear yield calculator. Use of the nomograms and the ABC-M4A1 is described later in this chapter.

Specifically appointed and trained individuals determine input data at unit level. They are the operators of the angle-measuring equipment listed in Figure 3-3.

Unit SOPs detail the duties and circumstances concerning when and how measurements are taken. For accuracy, the following list of measurements (in order of reliability) is provided to aid in SOP development

- Nuclear burst angular cloud width at H+5 minutes.
- Stabilized cloud-top or cloud-bottom height measured at H+10 minutes.
- Stabilized cloud-top or cloud-bottom angle measured at H+10 minutes.

**M2 aiming circle.\***  
**M65 or M43 battery command periscope.**  
**T16 or T2 theodolite.**  
**M2 pocket transit.**

\*This equipment is preferred because it is set to grid north (GN) and measures in mils.

**Figure 3-3. Angle-measuring equipment.**

## Angular Cloud Width

The width of the nuclear cloud is the angular dimension, in mils or degrees, of the cloud diameter. The optical equipment operator takes this measurement at H+5 minutes. This measurement is made for nuclear clouds resulting from both air and surface bursts (see Figure 3-4). All units have some ability to take this measurement. The lensatic compass should be used if the listed equipment is not available. Use of binoculars for width measurement is extremely inaccurate.

The angular width of the cloud is measured five minutes after the detonation. The equipment operator (of equipment listed in Figure 3-3) measures the azimuth by sighting an azimuth to the left side of the cloud and one to the right side of the cloud. The difference between the numerical values of these azimuths is the angular cloud width. This measurement is reported (in degrees or mils) on line item Lima. Measurement is usually sent in mils.

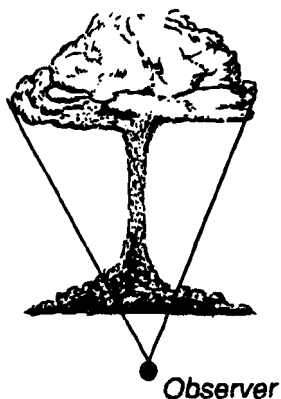

**Figure 3-4. Example of cloud-width measurement.**

## Stabilized Cloud-Bottom or Cloud-Top Angle

The cloud-bottom angle measurement is the vertical angle (in mils or degrees) measured from GZ level (on ground level, if GZ level is not discernible) to the point of intersection of the stabilized cloud and the stem. Measurement is made at H+10 minutes (see Figure 3-5). Cloud-bottom or cloud-top angle measurements are not taken for airbursts.

The cloud-top angle measurement is a vertical angle (in mils or degrees) measured from GZ level (or ground level) to the top of the stabilized cloud. This measurement is made at H+10 minutes (see Figure 3-5).

These measurements are less reliable than measurements made at H+5 minutes. Most units in the field cannot take cloud-bottom or cloud-top angle measurements. Therefore, they are not normally designated as observer units. These measurements cannot be made with a lensatic compass.

If the angular width of the cloud cannot be measured, the designated observer unit measures the cloud-bottom or cloud-top angle. Nondesignated observer units with angle-measuring equipment can also take this measurement. This measurement is made at H+10 minutes. It is the vertical angle in mils or degrees from ground level to the top or bottom of a stabilized nuclear cloud. This data is entered as line item Mike.

The individuals specifically tasked to take cloud measurements report this data and other data specified in the unit SOP to the unit NBC defense team. If the unit is a designated observer, the defense team will format the data

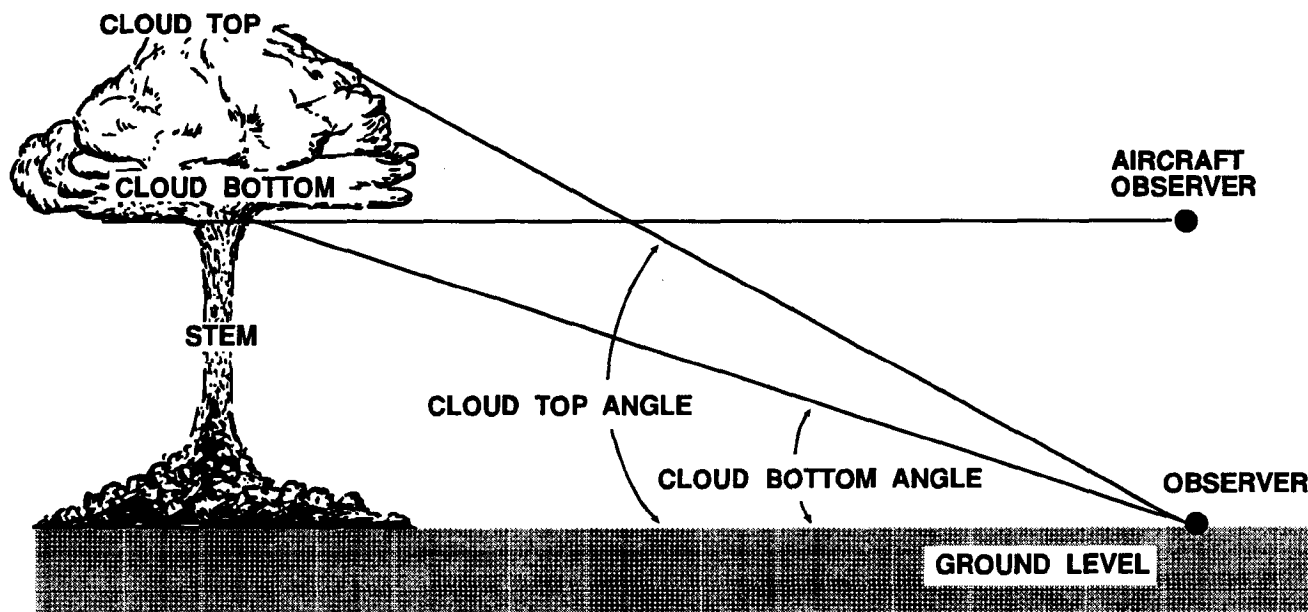

**Figure 3-5. Illustration of stabilized cloud-top, cloud-bottom angle, and height measurements.**

into an NBC 1 report. The report is transmitted per instructions in FSOP/OPLAN/OPORD or other written directions.

## Cloud-Top or Cloud-Bottom Height

Helicopters and most small fixed-wing aircraft have a limited capability to determine cloud height. Surface ceiling and enemy ADA threat are the principal reasons for this limited capability. This measurement can be made with high-performance USAF, USN, and USMC aircraft. NBCC must coordinate with other service liaison officers to make arrangements to measure cloud height.

Cloud height can be measured with radars. Again, NBCC coordination is required to establish this data source. Radar may also be helpful in resolving actual number of bursts, GZs, and yields.

## Observer Position

Use UTM coordinates or use a place name. Enter this location on line item Bravo of the NBC 1 nuclear report. Line item Bravo is required on all reports from ground observers and should be encoded. This is the location of the angle measuring equipment. It may or may not be the unit's location.

Another important factor in determining the extent and effect of nuclear detonations is the location of ground zero (GZ). This is reported as line Foxtrot on the NBC 1 report.

## Location of Ground Zero/Azimuth to the Attack

If the GZ cannot be observed, measure the azimuth from observer to the center of the stem (surface burst) or nuclear

burst cloud (air burst). Enter this data as line item Charlie of the NBC 1 nuclear report. If the GZ can be observed, determine the UTM coordinates or place name. Enter this data as line item Foxtrot (actual). Omit line item Charlie. (Aerial observers may provide estimated or actual GZ, depending on altitude, orientation, terrain, and visibility conditions). GZ must be observed to use line item Foxtrot (actual).

## Unit Level Procedures

Unit level is defined as any level that does not have an organic NBCC. Unit level procedures for locating GZ and estimating yield are much less complicated. The emphasis is placed on speed of the calculation, rather than on accuracy. The NBC 2 report depends heavily on radio nets. The integrated battlefield will pose serious communications problems to these nets.

Changing frequencies and call signs several times a day causes other problems. All these problems, coupled with an aggressive enemy electronic warfare program, will delay message traffic between higher and lower headquarters. Therefore, at the unit level, an independent means of calculation must be used until the NBC 2 report data reaches this level.

Any unit that is not part of the designated observer system is obligated to take cloud measurements to the best of its ability and record all observed burst data. These data are recorded in the NBC 1 nuclear report format. They are not reported to higher headquarters unless specifically requested. All units use this data to locate GZ and to estimate yield.

## Location of Ground Zero

At unit level, GZ is located in either of two ways. For small yield weapons, direct observation may provide actual GZ location. Units do not, however, reconnoiter for the GZ location. The other method used at unit level is called the polar plot (see Figure 3-6).

Unit commanders are interested in obtaining a gross fix on the GZ location. This enables rapid evaluation of the burst to estimate the situation. Polar plot techniques are based on flash-to-bang time and the speed of sound (350 meters per second or 0.35 kilometers per second). The NBC defense team makes an approximation of the distance between GZ and the observer, in kilometers. They multiply the flash-to-bang time (data on line item Juliet of the NBC 1 report) by 0.35 kilometers per second.

*Distance between GZ and observer = flash-to-bang time (sec) x 0.35 km/sec*

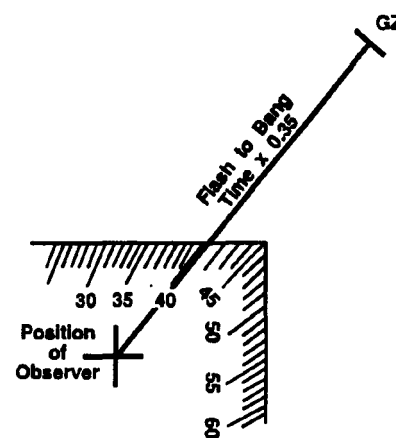

Figure 3-6. Example of polar plot.

Once this distance has been established, perform the following four steps:

**Step 1.** On the situation map, plot the observer location. This is line item Bravo on the NBC 1 nuclear report.

**Step 2.** Using a protractor, mark the azimuth from the observer position to the attack location. Convert magnetic

azimuth to grid azimuth. This information is found on line item Charlie of the NBC 1 report.

**Step 3.** Draw this azimuth to the length previously calculated as the distance between GZ and the observer.

**Step 4.** Read the grid coordinates of the place where the azimuth line in Step 3 ends. This is an approximate plot of the GZ location.

## Yield Estimation

### On Shore

Only higher headquarters will have classified intelligence data that can be used as a comparison tool for resolved yield. Also, unit-level work conditions will be so varied

that the use of nomograms will be difficult in most cases. Few, if any, units will have sufficient personnel to dedicate to an NBCC-type mission. Commanders at these levels need only an approximate yield value for entry into the broad yield groups of the effective downwind message.

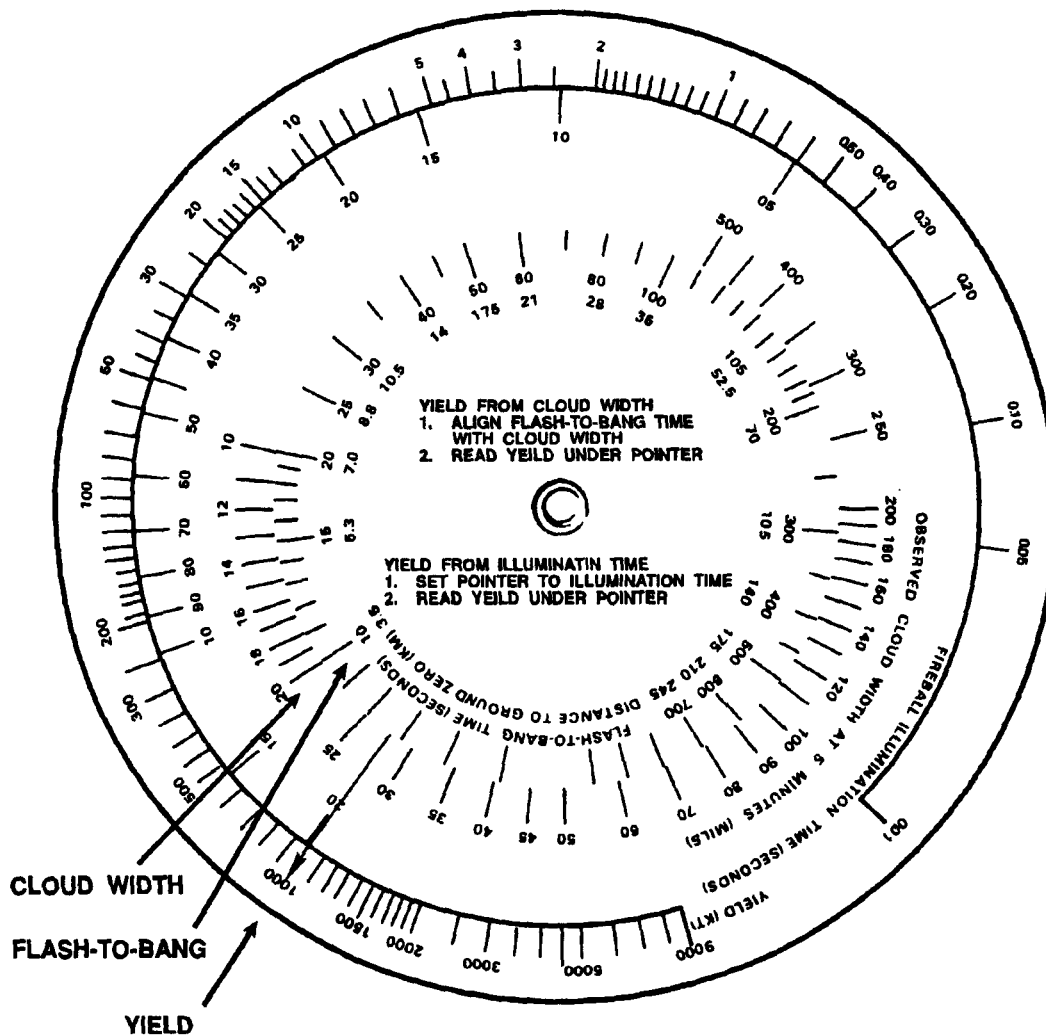

Figure 3-7. M4A1 nuclear yield calculator.



This message is used for the simplified fallout prediction, discussed in detail later in this chapter. In any case, the apparent accuracy of the yield estimation nomograms is unnecessary.

The M4A1 nuclear yield calculator (Figure 3-7) is designed to provide rapid yield estimation based on any parameter except cloud-top or cloud-bottom height. This calculator is a part of the M28A1 RADIAC calculator set, NSN 6665-01-130-3616. Instructions for use of the M4A1 calculator are on the instruction card in the set. This card also provides check problems. Upon receipt of the M4A1 calculator, the user should solve the example problem on the instruction card. If the calculator will not solve the example problem to within the specified tolerance, it must be destroyed and a new one obtained. Complete operating instructions for the M4A1 are in TM 3-6665-303-10.

There is one problem with the M4A1 calculator of which the unit NBC defense team must be aware. The calculator is a round nomogram with a fixed hairline. Because of this, there are situations in which the yield pointer may go off scale on the high or low ends of the yield scale. Additional burst information should clarify unexpected yield estimates not consistent with the use of tactical nuclear weapons. Familiarity with the calculator and an understanding of the size of a nuclear cloud in relation to the observer-GZ distance (flash-to-bang time) will eliminate these problems.

For example, a nuclear cloud is 20 roils wide. Flash-to-bang time was 10 seconds. This is a small cloud that is very close to the observer, indicating a small yield. The calculator shows a yield of 1,000 kilotons, but the actual yield is less than 0.02 kiloton. Conversely, a nuclear

cloud-top angle of 80 degrees with a flash-to-bang time of 120 seconds is a large cloud very far away. This time the calculator shows a yield of 0.02 kiloton, but the actual yield is greater than 10,000 kilotons.

The M4A1 calculator is a rapid yield-estimation method designated specifically for unit level use. Its durability, size, and ease of operation make it the most suitable method. All members of the unit NBC defense team are trained in its use. Nomograms are not used at unit level because of adverse conditions.

The GZ location and estimated yield calculated at unit level are used to create a simplified fallout prediction. Upon receipt of the NBC 2 report from the NBCC, the original simplified fallout prediction is revised, using the new data. When the NBC3 report is received, it supersedes the revised simplified fallout prediction. This approach allows the unit commander to make estimates and decisions based upon the best available information at that time.

## Onboard Ships

If stabilized cloud-top height or cloud-bottom height can be measured, then Figure 3-8, next page, maybe used to estimate the yield. Line up hairline with information given on line Mike, (convert from meters or feet to kilometers or thousands of feet.) Pin down where hairline crosses line in graph. Then plot so hairline is parallel. Read weapon yield on bottom of graph. When cloud-top or cloud-bottom parameters are not available, ships will have to use the methods described in the preceding paragraphs for ground forces.

## Significance of Fallout Ashore Versus at Sea

The detailed and simplified procedures for fallout prediction are intended for use by all three services. The predictions are based on assumed land surface bursts. It is recognized that the fallout from a sea surface burst may be different, but very little direct information is available on fallout from bursts on the surface of deep ocean water.

It also must be stressed that the sea acts as an absorbent of and shields against radioactive products. But, these products may remain a hazard on land until they have decayed.

Another important difference is that recipients of warnings ashore do not have the mobility of ships at sea, and in most cases must deal with the hazard. Therefore,

ships will be particularly interested in the determination of the approximate area where fallout will reach the surface at a given time after burst.

Ships with a meteorological capability maybe able to obtain the required meteorological data for computation of effective downwind, using standard pressure level winds. Basic wind data for this purpose are generally available also from meteorological sources (airbases, meteorological ships, or mobile weather stations).

Ships which do not have a meteorological capability will normally predict fallout areas by using the simplified procedure. Fallout prediction and plotting of fallout areas on board naval ships is discussed in this chapter.

## Flash-to-Bang Time

At the instant of the blue-white flash, cover eyes, hit the ground, and start counting slowly—1,000 and 1, 1,000 and 2, 1,000 and 3, and so on-until the arrival of the shock

wave or bang. Make a mental note of the count on which the shock wave arrives (for example, 1,000 and 4). If the observer has a watch and can note the exact time (in

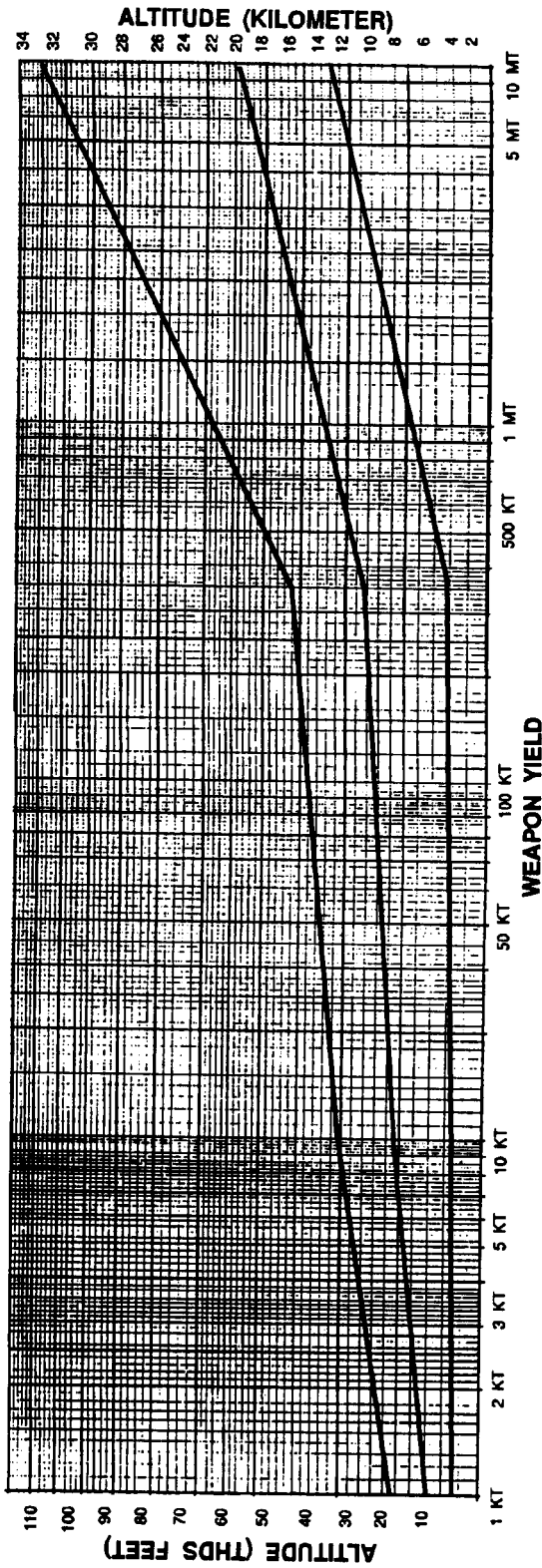

**STANDARD  
FORMAT**

NBC 1 Nuclear  
 B AY123456  
 C 190 Mils Grid  
 D 101145Z  
 H Surface  
 J 60  
 L 45 Mils Mag

**USMTF PROGRAM  
FORMAT**

MSGID/NBC1/NUC//  
 BRAVO/32UAY123456//  
 CHARLIE/0190MLG//  
 DELTA/101145Z//  
 HOTEL/SURF//  
 JULIET/060//  
 LIMA/045MLM//

*Figure 3-9. Examples of NBC 1 nuclear reports.*

*Figure 3-8. Stabilized cloud and stem parameters.*

seconds), the watch can be used to record the flash-to-bang time. This data is entered as line item Juliet on the NBC 1 nuclear report. Remain where you are until debris has stopped falling. It must be noted that there will be two

shock waves—one blowing in one direction, and the other blowing a few minutes later in the opposite direction. If the bang is not heard in five minutes (a count of 1,000 and 300), continue with other measurements.

## Type of Burst and Time of Attack

After the second shock wave has passed, uncover your eyes, and read the watch to the nearest minute. This data is entered as line item Delta of the NBC 1 nuclear report. Observe the developing cloud to see if the burst was an airburst by noting the shape and color of the cloud or the absence of a stem. If the cloud is lighter in color than the stem, or if the stem is ragged or broken (does not solidly connect with the cloud), record “air” as line item Hotel of the NBC 1 nuclear report. If the stem is thick and dark,

and it connects with the cloud, record “surface” as line item Hotel. When the cloud does not match any mental image for air or surface, record “unknown” as line item Hotel.

“Unknown” also may be recorded whenever the attack occurs at night. A subsurface burst is recorded as “surface,” only if the detonation ruptures the surface. This data also is recorded on line item Hotel.

## Recording and Reporting Nuclear Burst Data

Each unit, designated and nondesignated, uses the data to locate GZ and estimate the yield. Polar plot techniques are used to locate GZ. Yield is estimated with the M4A1 yield calculator. GZ and yield are used with the effective downwind message to make a simplified fallout prediction. Effective downwind messages and simplified fallout predictions will be explained later in this chapter. This prediction is used until the NBC 2 report is received. Then the simplified fallout prediction is revised and reevaluated.

The NBC 3 report will follow later. The NBC 3 report is more accurate and supersedes all simplified predictions.

Examples of nuclear burst reports are shown in Figure 3-9. These reports follow the standard NBC 1 nuclear report format. These examples in no way limit the variety of reports. Further, unit NBC defense teams are not confined solely to the use of the line items in these examples. Other line items may be added at the user’s discretion.

## Evaluating Data

Data evaluation consists of locating GZ, estimating the yield of the weapon, confirming the date-time group of the burst, and assigning a strike serial number. It is performed at the NBCC. If the unit level establishes a serial number, it will only be for that unit’s use and never transmitted higher.

All calculations of GZ locations and yields developed at unit level are estimates. These calculations are based on

data gathered by one unit. Methods of calculation are simple and abbreviated. These reports also contain other data. Unit-level estimations are never transmitted to higher headquarters.

The NBCC is responsible for the NBC 2 report. This report reflects the GZ location, yield, and other data that the entire command will use for fallout predictions. This ensures that all units will make the same fallout prediction.

## NBCC Procedures

NBCC techniques compare the data from many sources. Much of this data is not available to any one unit. Only the NBCC is authorized to assign strike serial numbers. This is generally from a block of numbers assigned to the division by corps. This block of serial numbers is usually listed in FSOP/OPLAN/OPORDs. The serial numbers usually identify the corps, division and/or brigade areas, and the number of the strike.

### Date and Time of Attack

The date and time of the attack are always reported. The time zone used is specified by FSOP/OPLAN/OPORD or is contained in other instructions. The NBCC conducts time checks with designated observers and converts all times to Zulu time.

## Ground Zero Location

At the NBCC, GZ location is always located before the yield is estimated. The NBCC uses several methods and data sources to locate GZ. Some of these methods are plots of intersecting azimuths, radar reports, and aviator reports. If line item Foxtrot (actual) data on the NBC 1 report is not available, other methods are used to confirm this data. When azimuth data are incomplete, arcs for radii of flash-to-bang distances from two or more observers can be used. The NBCC can request NBC 1 reports from nondesignated units to supplement data from designated units.

Combinations of azimuths and radii of flash-to-bang distances also can be used. This is done by multiplying flash-to-bang time submitted on NBC 1 reports by the speed of sound (0.35 kilometers per second) to determine a distance. Once the observer location has been plotted, the flash-to-bang time distance can be drawn as an arc. If several arcs can be drawn, a gross fix of GZ can be determined. This is the most accurate method to estimate the location of GZ. See Figure 3-10.

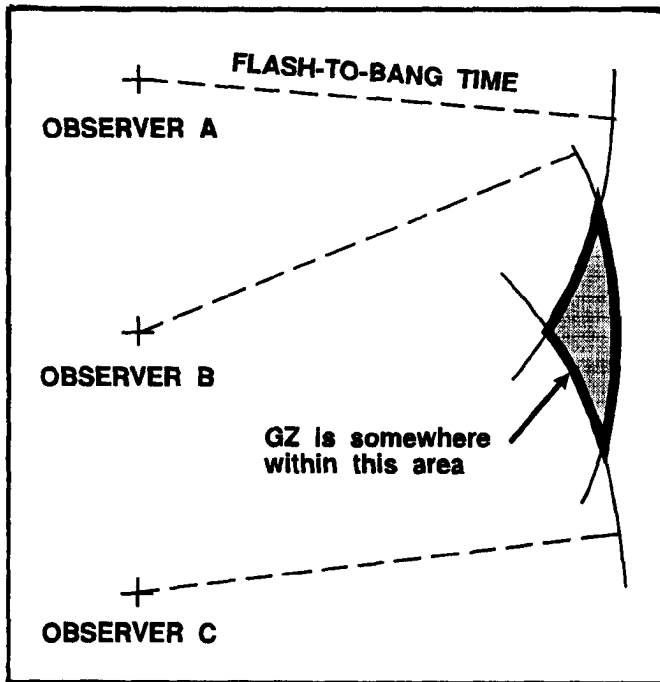

Figure 3-10. Location of GZ by intersection of arcs.

The principal GZ location method is a plot of intersecting azimuths sent by designated observers. (This information is found on line item Charlie of the NBC 1 reports.) To locate GZ using a plot of intersecting azimuths, follow these four steps:

**Step 1.** On the operations map overlay, locate and mark the position of each observer unit, using data at line item

Bravo. Line item Bravo must be encoded if using an unsecure radio net. Therefore, these observer locations may have to be decoded prior to actual plotting.

**Step 2.** Determine each azimuth to be plotted. (This information is at line item Charlie.) Convert all magnetic azimuths to grid azimuths. Using a protractor, mark each azimuth from each observer position. Draw each azimuth to the distance necessary for them to intersect.

**Step 3.** Post any data that assists in the determination of GZ location (such as, radar reports and pilot reports).

**Step 4.** Evaluate the data. The result of intersecting azimuths is an estimation of GZ location. GZ location is reported on the NBC 2 report at line item Foxtrot, qualified with the word "estimated," unless Foxtrot (actual) information is used in the determination. Line item Foxtrot must be encoded if using an unsecure radio net.

In using this summary, the NBCC compares the estimated yield with known enemy yields. The estimated yield and other intelligence sources, such as delivery means, depth of the attack from the front line of troops, type of burst, and other circumstances concerning the attack, will indicate which known enemy yield was actually used. Only this resolved yield is reported to field units. A simplified summary of enemy nuclear capabilities is shown in Figure 3-11.

Artillery	100 KT 10 KT 1 KT	Missiles	1,000 KT 750 KT 500 KT
Bombs	1,000 KT 500 KT 50 KT		

Figure 3-11. Sample summary of enemy nuclear capabilities.

Disregard azimuths that do not intersect with other azimuths. Whenever azimuths do not cross to form a clear GZ location, the center of the plot is taken as GZ location. The NBCC will request exact GZ coordinates from aviation assets when aviation missions permit. Figure 3-12 shows an intersection of azimuths for GZ location.

Another GZ location technique involves the use of line item Papa Alfa. Some air defense artillery radars have the ability to paint an outline of the nuclear cloud on radar scopes. The radar operator can determine coordinates of H+5 minutes after burst, which outline the stabilized nuclear cloud as if it were viewed from the top. These coordinates may be sent as UTM coordinates. Coordination between the NBCC and the unit that sends radar data is required. This coordination must establish precedence of the report and communication channels to be used.

Upon receipt of the data at the NBCC, the coordinates are plotted on the map, and the cloud contour is drawn.

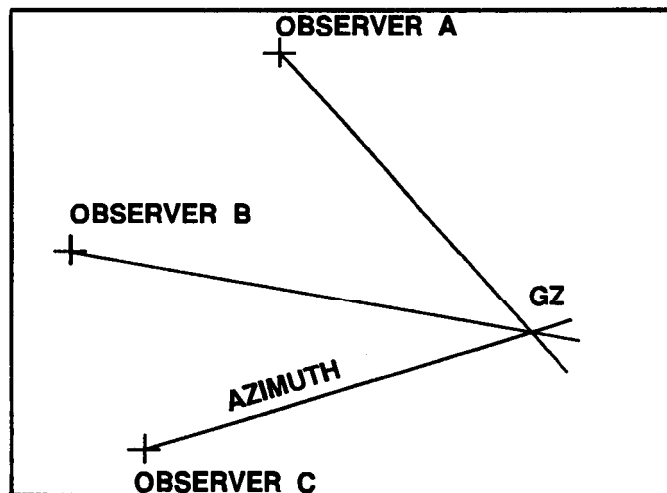

**Figure 3-12. Intersection of azimuths for GZ location.**

The center of the outline is the GZ location. If the measurements are taken at H+5 minutes after burst, there is a high assurance that GZ has been accurately fixed. This GZ location technique is most valuable at night or when observer data cannot fix GZ location with 90 percent or greater assurance.

## Yield Estimation

Before the yield can be estimated, you must know the location of GZ and the position of the observer when the cloud measurements were taken. Rather than require field personnel to solve complex formulas, the nuclear burst parameters are presented in nomograms. Each is an independent means of estimating yield. Emphasis is on estimating the yield. All nomograms are designed to provide approximate yields.

Flash-to-bang time (line item Juliet) is not used at NBCC level for yield estimation, except as a last resort. This information is usually regarded as unreliable because of the stress associated with slow counting immediately after an attack. Instead, the NBCC uses the distance (in kilometers) between GZ and the observer. Plotting this data (intersecting azimuths) represents the best method of determining the distance between GZ and observer location. Flash-to-bang time is used for yield estimation only when azimuth information is not reported or is incomplete.

## Nuclear Burst Angular Cloud Width

NBCC members use the nomograms in Appendix E (Figure E-5) to determine yield, based on the nuclear burst angular cloud width, and distance between GZ and the observer. The right-hand scale is the nuclear burst angular cloud width in roils and degrees. The center scale is the

distance in kilometers between GZ and the observer. The left-hand scale is the yield in kilotons (KT).

To use this nomogram, place a hairline from the point on the right-hand scale (representing the nuclear burst angular cloud width at H+5 minutes) through the point on the center scale (representing the distance between GZ and the observer). Read the yield where the hairline crosses the yield scale.

For example, a plot of designated observer positions and reported azimuths has been made. Observer A reported a nuclear burst angular cloud width on line item Lima of 280 mils. The distance between observer A and GZ is 21 kilometers. To estimate the corresponding yield by using the nomogram, use a hairline to connect 280 roils on the right-hand scale with 21 kilometers on the center scale. The point of intersection of the hairline and the left-hand scale, is a yield of about 50 kilotons.

## Stabilized Cloud-Top or Cloud-Bottom Height

Cloud-top or cloud-bottom height, when stabilized, can be closely measured by pilots in jet aircraft. The NBCC must coordinate with liaison officers to have airmail in the area determine this height. Height can also be measured by some ADA radars. Measurements, in meters or feet above the earth's surface, must be made at H+10 minutes. Data are reported on line item Mike.

NBCC members use the nomograms in Appendix E (Figure E-3) to correlate these measurements with yield. Distance between GZ and observer is not required.

The extreme left and right scales on the nomogram are yield in kilotons (KT) and megatons (MT). The scale second from the left is the cloud-top height at H+ 10 minutes in thousands (10<sup>3</sup>) of meters or feet. The scale third from the left is the cloud-bottom height, also at H+ 10 minutes. It, too, is graduated in thousands of meters or feet. The other scales on the nomogram (two-thirds stem height, cloud radius, and time of fall) are not used in yield estimation. These scales are used in detailed fallout prediction.

To use the nomogram, determine stabilized cloud-top or cloud-bottom height from line item Mike of NBC 1 reports or as reported by pilots through liaison officers. Place a hairline directly over the reported data and pin the hairline to the nomogram. Pivot the hairline until it crosses the outside yield scales at the same value. This value is the estimated yield.

For example, a cloud-bottom height of 21,000 feet has been reported. To estimate the corresponding yield, place a hairline on the mark representing 21,000 feet (21) on the third scale from the left. Pin the hairline and pivot it about this axis until equal values are read on the extreme left and right yield scales. Read a yield of 10 kilotons.

## Stabilized Cloud-Top or Cloud-Bottom Angle

The NBCC uses the nomogram in Figure E-4 in Appendix E to find yield, given the distance between GZ and the observer, and either the stabilized cloud-top angle or the cloud-bottom angle. The right-hand scale gives the distance in kilometers from GZ to the observer and the flash-to-bang time in seconds counted by the observer. The center scale is the cloud-top or cloud-bottom angle in roils or degrees. The left-hand scale is actually two scales. The left side of this scale lists the yields to be read when using the cloud-bottom angle; the right side of this scale lists the yields to be read when using the cloud-top angle.

To use this nomogram, place a hairline through the point on the right-hand scale representing distance between GZ and the observer and through the point on the center scale representing either the cloud-top or cloud-bottom angle. At

the point of intersection of the hairline and the left-hand scale, read the yield. If cloud-top angle was used on the center scale, read yield on the right side of the left-hand scale titled yield-cloud top (km). If a cloud-bottom angle is used, read the yield on the left side of the left-hand scale titled yield-loud bottom (KT).

For example, a designated observer reports an angle to cloud bottom (line item Mike) of 200 mils. Distance between GZ and this observer is 42 kilometers. Place a hairline from 42 kilometers on the right-hand scale through 200 roils on the left side of the middle scale. Read the yield as 55 kilotons on the left side (cloud bottom) of the left-hand scale. This yield calculation is only a field estimate.

If an observer reports cloud-top and cloud-bottom angles, use both in the yield estimate. Each angle will result in a different yield. Use the average of the two yields.

## Yield Estimation From Radar Data

When nuclear attacks occur at night, measurements of cloud parameters may be impossible. Under these conditions a good yield estimate can be made by the NBCC if data from radars are available at line item Papa Alfa of the NBC 1 nuclear report. A plot of this data will outline the nuclear cloud at its point of maximum lateral growth.

To estimate yield, the NBCC measures the radius of the outline of the cloud and consults Table 3IV-1 in Chapter 3 of FM 101-31-2 (S). This data is classified and beyond the scope of this manual. Yield can be confirmed by entering the nomogram in Figure E-3 with cloud radius, and check the yield, or vice versa.

## Illumination Time

During the hours of darkness or poor visibility, yield may be estimated from the measurement of illumination time. Use this method only when it is impossible to obtain cloud parameters as previously discussed. This yield estimation method only gives an estimate on the order of a factor-of-ten. In other words, a yield estimate of 20 KT could be as low as 2 KT or as high as 200 KT.

Under no circumstances should the observer look directly at the fireball. This will cause permanent damage to the eyes. Observers can sense, with eyes closed, when

the intense light has faded. An observer in a foxhole can look at the floor of the foxhole. Counting procedure is the same as that for flash-to-bang time. The person counting illumination time stops counting when the light begins to fade. The individuals specifically tasked by unit SOP to count illumination time must be trained to do so. Quick reflex action and presence of mind are required. Table 3-1, next page, shows rough estimates of yield, using illumination time.

## Resolved Yield

Each of the yield estimation techniques is presented in order of decreasing reliability, with results in approximate yields. There also will be occasions when the data from several observers, concerning a single attack, will not result in the same yield. Estimates for each strike are averaged. The yield determined from nomograms is the mid-point of the process. Again, this is an approximate yield.

The actual yield reported to the field units is called the resolved yield. To determine the resolved yield, the NBCC maintains a summary of enemy nuclear capabilities. This summary may reflect or&r-of-battle, delivery units, and known yields. This data is determined from G2 and other intelligence sources. FM 101-31-2(S) also offers data on enemy yields and delivery systems.

**Table 3-1. Yield estimates for illumination times.**

<b>Illumination Time (Seconds)</b>	<b>Approximate Yield (KTs)</b>
Less Than 1	2
1	2.5
2	10
3	22
4	40
5	60
6	90
7	125
8	160
9	200
10	250
11	285
12	325
13	400
14	475
15	550
16	700
17	750
18	800
19	900
20	980

If the resolved yield is less than the estimated yield and the estimated yield lies in a higher yield group on the effective downwind message, use this higher yield when reporting yields to field units. The higher yield will be used until data can be refined and monitoring reports are received.

## NBC 2 Nuclear Report

The NBC 2 report reflects the evaluated nuclear burst data. Raw data is automatically submitted by designated observer units each time the enemy attacks with nuclear weapons. It represents the detailed evaluation of all raw data.

The NBC 2 report has a precedence established in FSOP/OPLAN/OPORD or other written instructions. Precedence is based upon urgency. An NBC 2 report may have a different precedence for a unit in a danger zone compared to a unit not in an affected area.

NBC 2 reports are created for all bursts-air, surface, and unknown. When surface or unknown are reported as the type of burst, fallout predictions are made. Users of NBC 2 reports are not limited to the use of the line items shown in the example. Other line items, as appropriate, may be added. Figure 3-13 shows examples of NBC 2 reports.

Communication means for the NBC 2 report is established by FSOP/OPLAN/OPORD or other written instructions. Each NBC 2 report is sent to all affected subordinate units and higher and adjacent headquarters. This allows planning for future missions or boundary changes.

Subsequent data may be received after the NBC 2 report is sent. If this data changes the yield or GZ location, the newer data is sent in a new NBC 2 report. The same strike serial number and date-time of attack are used.

Once the NBCC staff determines the resolved yield, they formulate an NBC 2 report. In theory this is done only at division NBCC level. However, in practice the NBC 2 report may be done at battalion or brigade level. In some special cases, the NBC 2 report may be generated at unit level. Any command level that has access to two or more NBC 1 reports, upon which an accurate yield and exact location for ground zero may be determined, may produce

<b>Standard Format</b>	<b>USMTF Program Format</b>
NBC 2 Nuclear	MSGID/NBC2/NUC//
A NO08	ALFA/NO08//
D 140900Z	DELTA/140900Z//
F AY180364 Estimated	FOXTROT/E/32UAY180364//
H Surface	HOTEL/SURF//
N 13 KT	NOVEMBER/13//

**Figure 3-13. Examples of NBC 2 nuclear reports.**

STRIKE SERIAL NUMBER (A)	DATE/TIME OF ATK (ZULU) (D)	GZ COORDINATES (ACT/EST) (F)	TYPE OF BURST (H)	YIELD (KT) (N)	REMARKS
7008	140900Z	A4180364 Est.	Surface	13	
7009	111200Z	A4134741 Est.	Air	9	

SAMPLE

Figure 3-14. Suggested format for a nuclear strike serial number log.

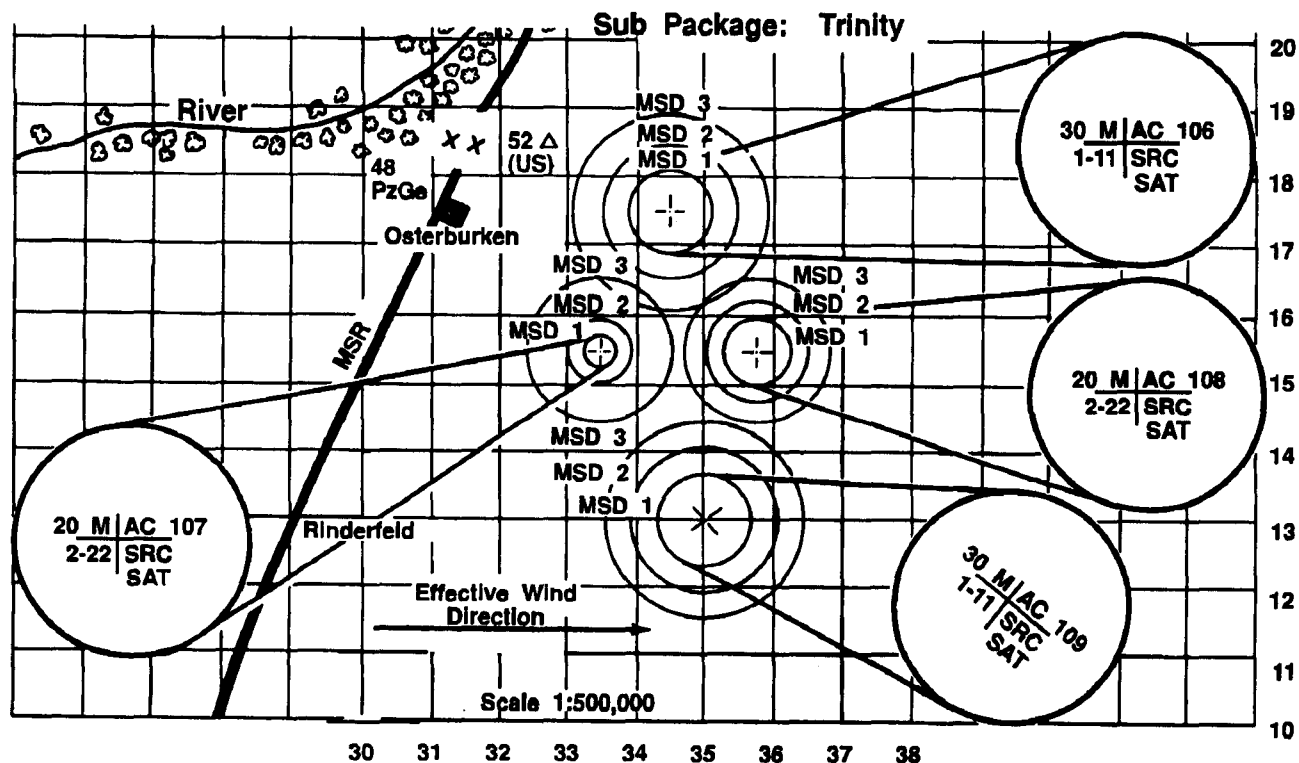

Figure 3-15. Strike serial number overlay.



an NBC 2 report. However, if NBC 2 reports are provided by higher headquarters, they must be used; because, generally, higher headquarters will have more accurate data.

prediction. Effective downwind messages will be explained later in this chapter.

### Strike Serial Number

The NBCC serves as a focal point for all requests for information concerning nuclear strikes. It is responsible for assigning a strike serial number to each nuclear attack, friendly or enemy, that occurs within its assigned area. A record of these numbers is kept in a log or on a map overlay. A suggested format for a log is shown at Figure 3-14 and a map overlay at Figure 3-15.

**Note:** The resolved yield is based on the information provided by the G2 on enemy nuclear capabilities by weapon type.

Any system of numbering nuclear strikes designated by SOP is permitted. The system maybe all numbers, all letters, or alphanumerical. Integration of the NBCC headquarters designation in the serial number is also permitted. The headquarters responsible for the area of operation should not assign blocks of strike serial numbers to subordinate units.

Once the unit receives the NBC 2 nuclear report, the unit NBC defense team takes the report and a current effective downwind message, and prepares a simplified fallout

### Simplified Fallout Prediction

The simplified fallout prediction system provides small unit commanders an immediate estimate of the fallout hazard. The commander uses the simplified fallout prediction in the decision-making process. A current effective downwind message, nuclear burst information (NBC 2 nuclear report), and a simplified fallout predictor (M5A2 or field expedient) are required to prepare a simplified fallout prediction. It is superceded upon receipt of an upgraded NBC 2 nuclear report only if there is a disparity between the initial NBC 2 report and the upgraded NBC 2 report. Otherwise, it is superceded by an NBC 3 nuclear report from higher headquarters.

To use the simplified fallout prediction system, a unit should—

- Train on the simplified fallout prediction system.
- Establish communications with the battalion to maintain current wind data.
- Have the necessary forms and overlays ready for use. These include NBC 2 nuclear report formats, effective downwind message formats, and the M5A2 fallout predictor. If the M5A2 fallout predictor is not available, a field-constructed predictor and the nomogram in Figure E-6 in Appendix E may be used.

Standard Format		USMTF Program Format	
Effective Downwind Message		Effective Downwind Message	
ZULU	DDtttt	ZULU or ZZZULU	DDtttt
ALFA	dddsss	ALFA or YGALFA	dddsss
BRAVO	dddsss	BRAVO or YGBRAVO	dddsss
CHARLIE	dddsss	CHARLIE or YGCHARLIE	dddsss
DELTA	dddsss	DELTA or YGDELTA	dddsss
ECHO	dddsss	ECHO or YGECHO	dddsss
FOXTROT	dddsss	FOXTROT or YGFOXTROT	dddsss
GOLF	dddsss	GOLF or YGGOLF	dddsss

ZULU DDtttt—This line is the date and time at which the winds were measured. The letters DD represent the day, and tttt the hour in Zulu time Greenwich Mean Time (GMT).

The remaining seven lines provide data for the seven preselected yield groups. The letters ddd represent the effective downwind direction in degrees from GN; and sss represents the effective wind speed to the nearest kilometer per hour.

ALFA dddsss—2-KT-or-less yield group.  
 BRAVO dddsss—more than 2-KT-through-5-KT yield group.  
 CHARLIE dddsss—more than 5-KT-through-30-KT yield group.  
 DELTA dddsss—more than 30-KT-through-100-KT yield group.  
 ECHO dddsss—more than 100-KT-through-300-KT yield group.  
 FOXTROT dddsss—more than 300-KT-through-1-MT yield group.

### Wind Data

To use the simplified fallout prediction, you need the effective wind speed and downwind direction. This information is prepared by the NBCC as an effective downwind message, and it is transmitted to subordinate and adjacent units each time new upper air wind data are received. Effective downwind messages should be received from the division NBCC every 12 hours. However, if one is not received within 12 hours, the latest message should always be used. Effective downwind messages more than 12 hours old, however, should not be used for fallout prediction.

The format for the effective downwind message is a series

Figure 3-16. Effective downwind message format and line content.

of eight lines preceded by the phrase "Effective Downwind Message." The significance of each line item is indicated in Figure 3-16.

For example, an effective downwind message reads Delta 090025. The individual using this information knows

that when the Delta line is used, the yield of the weapon is more than 30 KT but no more than 100 KT. Use of the Delta line indicates that the fallout prediction was determined from a downwind direction of 90 degrees and an effective wind speed of 25 kilometers per hour.

## Effective Downwind Message

Preparing an EDM is similar to preparing a detailed fallout prediction, which will be explained later in this chapter. The difference is the EDM is prepared for specific yields and it is used by a unit to prepare a simplified fallout prediction. The NBCC is responsible for preparing and disseminating the EDM. This normally is done once every twelve hours.

### Preparation of a Message (Wind Data)

**Step 1.** Obtain the cloud-top height, cloud-bottom height, and two-thirds stem height (from Figure E-3) for each of the following yields: 2 KT, 5 KT, 30 KT, 100 KT, 300 KT, 1 MT, and 3 MT. This information is also on DA Form 1971-3-R (Effective Downwind Message Worksheet). A blank DA Form 1971-3-R can be found in Appendix H.

**Step 2.** Place a sheet of overlay paper over the wind vector plot, and mark a GN reference line and GZ. Preparation of wind vector plots is outlined in Appendix D. Mark the cloud-top height, cloud-bottom height, and two-thirds stem height for the 2-KT yield (use the values obtained in step 1). Draw radial lines from GZ through these three points.

**Note:** It is important to understand that all military significant fallout is contained between 2/3 stem and cloud top height. In relation to this fact all of the wind vectors from where 2/3 stem is plotted up to cloud top height must fall between these two radial lines. If not the closest radial line must be moved to include these vectors. Some times it may be necessary to move only one, or both 2/3 stem and cloud top height, a radial line that has been moved will have the same nomenclature as the original line.

**Step 3.** To determine the effective wind speed, measure the distance along the cloud-bottom radial line from GZ to its intersection with the wind vector plot at the cloud-bottom height point. Divide this distance by the time of fall from the cloud bottom (Figure 3-17), or multiply by the reciprocal as shown on the EDM worksheet.

**Note:** A situation may arise when the effective wind speed for one or more yield groups is less than 8 kmph. In this case the downwind distance for Zone I is determined, using the nomogram in Figure E-6's (Appendix E) zone of immediate concern. Enter the nomogram with the effective wind speed of 8 kmph on the left-hand scale, and the highest yield for each yield group on the right-hand scale. Then, read the downwind distance for Zone I on the center scale.

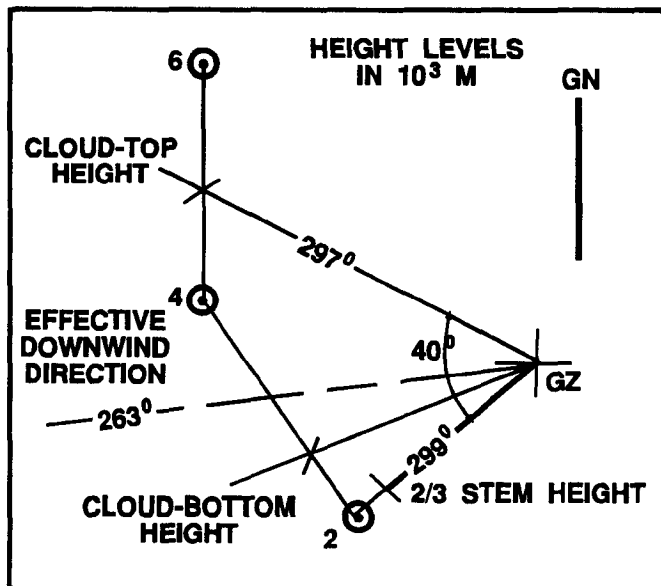

Figure 3-17. Angle determination.

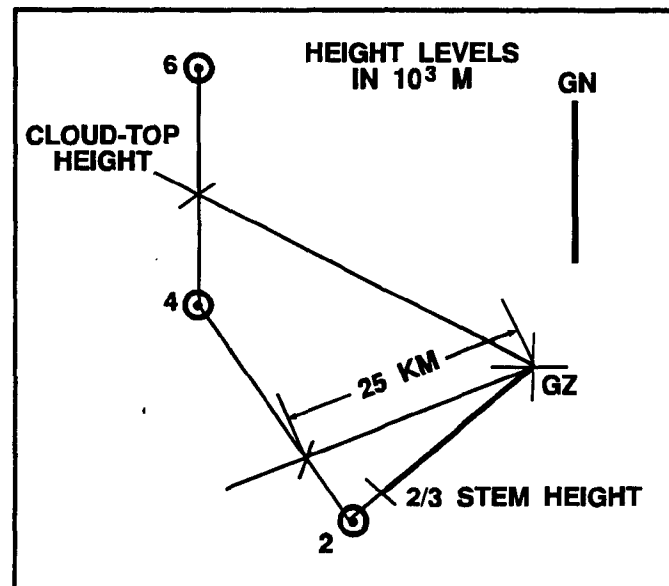

Figure 3-18. Effective wind speed and downwind direction.

**Step 4.** To determine the effective downwind direction, use a protractor to bisect the angle formed by the cloud-top height radial line and the two-thirds stem height radial line. Measure the azimuth of the bisector in degrees from GN. This is the effective downwind direction (Figure 3-18).

**Step 5.** Measure the angle between the cloud-top and two-thirds stem. In some cases the angle will be more than 40 degrees. In those cases if the angle is an odd number, round the angle to the next highest even number, and record it on the worksheet in the expanded angle column for the appropriate yield group.

**Step 6.** Repeat steps 2 through 5 for the remaining yield groups. Use a separate sheet of overlay paper for each yield group.

**Step 7.** Complete the EDM portion of the work sheet, based on the data and calculations.

Remember the 3-6-9-digit rule:

- 3 digits mean winds less than 8 kmph, and digits represent Zone I distance.
- 6 digits mean normal message.
- 9 digits mean expanded radial lines to a given number of degrees.

An example of a completed worksheet and an effective downwind message for normal winds is depicted in Figure 3-19.

A worksheet with the two types of special cases discussed is depicted in Figure 3-21, page 3-18.

Effective Downwind Message	
ZULU	DDtttt 2 7 2 4 0 0 (Z)
ALFA	dddsss 2 1 8 0 2 1 ( )
BRAVO	dddsss 2 2 6 0 2 2 ( )
CHARLIE	dddsss 0 1 6 ( )
DELTA	dddsss 0 2 9 ( )
ECHO	dddsss 0 5 0 ( )
FOXTROT	dddsss 0 8 9 ( )

Figure 3-20. Example of EDM with wind speeds less than 8 kmph.

Effective Downwind Message Worksheet										
For use of this form, see FM 3-3-1. Proponent of this form is TRADOC.										
Time of Wind Measurement (Date-Time Group) D D t t t t 2 7 2 4 0 0 zulu										
Data and Calculations										
Message Line	Yield (KT)	Cloud-Top Height (meters)	Cloud-Bottom Height (meters)	2/3 Stem Height (meters)	① Distance of GZ/CT Radial Line (KM)	① Effective Wind Speed (kmph) $\frac{1}{\text{Time of Fall}} = \text{sec}$ (Round to nearest kilometer per hour)	② Azimuth of GZ/CT Radial Line (degrees)	③ Azimuth of GZ/2/3 Stem Radial Line (degrees)	Effective Downwind Direction (degrees) $\frac{② + ③}{2} = \text{ddd}^{\circ}$	Warning Area Angle
A	2	4,900	2,600	1,700	18.5	18.5 x 1.136 = 21	227	209	$\frac{436}{2} = 218$	
B	5	7,100	4,400	2,800	28.5	28.5 x 0.758 = 22	237	215	$\frac{452}{2} = 226$	
C	30	11,600	7,700	5,100	51	51 x 0.455 = 23	256	228	$\frac{484}{2} = 242$	
D	100	14,400	9,300	6,200	63	63 x 0.385 = 24	271	232	$\frac{503}{2} = 252$	
E	300	18,700	11,000	7,400	70	70 x 0.333 = 23	282	242	$\frac{524}{2} = 262$	
F	1,000	21,600	13,500	8,000	75.2	75.2 x 0.286 = 22	302	272	$\frac{574}{2} = 287$	
G	3,000	28,250	15,800	10,500	77	77 x 0.250 = 19	251	220	$\frac{471}{2} = 236$	

Effective Downwind Message	
ZULU	DDttt 2 7 2 4 0 0
ALFA	dddsss 2 1 8 0 2 1
BRAVO	dddsss 2 2 6 0 2 2
CHARLIE	dddsss 2 4 2 0 2 3
DELTA	dddsss 2 5 2 0 2 4
ECHO	dddsss 2 6 2 0 2 3
FOXTROT	dddsss 2 8 7 0 2 2
GOLF	dddsss 2 3 6 0 1 9

\* When the azimuth of the ground zero/cloud-top radial line ② or the azimuth of the ground zero/2/3 stem radial line ③ falls in the first quadrant (0 to 90 degrees) and the other falls in the fourth quadrant (270 to 360 degrees), result of ② + ③ divided by 2 will be the back azimuth of the effective downwind direction. In this case, determine ddd by the following method: if result is greater than 180 degrees, subtract 180 degrees; if result is less than 180 degrees, add 180 degrees. Enter in the effective downwind message.

DA Form 1971-3-R

Figure 3-19. Completed DA Form 1971-3-R for normal winds.

### Special Cases

When the effective wind speed is less than 8 kmph for a given yield group, the applicable line will contain only three digits (Figure 3-20, page 3-17). These three digits will represent the radial line distance (obtained by entering the nomogram in Figure E-6 with the estimated yield and 8 kmph) of Zone I. In this case no wind speed is given, and the fallout pattern will be two concentric circles.

Another special case occurs when the fallout is not expected to fall within the normal 40-degree angle of the prediction. In this case the appropriate line on the effective downwind message has nine digits. The first six digits represent wind direction and wind speed. The last three digits show the angle in degrees between the left and right radial lines (see Figure 3-22).

Effective Downwind Message	
ZULU	DDtttt 2 7 2 4 0 0 (Z)
ALFA	dddsss 2 1 8 0 2 1
BRAVO	dddsss 2 2 6 0 2 2
CHARLIE	dddsss 2 4 2 0 2 3
DELTA	dddsss 2 5 2 0 2 4
ECHO	dddsss 2 6 0 0 2 3 (044)
FOXTROT	dddsss 2 7 3 0 2 2 (058)
GOLF	dddsss 2 8 0 0 2 6 (064)

Figure 3-22. Sample EDM reflecting expanded radial lines.

Effective Downwind Message Worksheet										
For use of this form, see FM 3-3-1. Proponent of this form is TRADOC.										
Time of Wind Measurement (Date-Time Group) D D t t t t <u>2 1 1 2 0 0</u> <u>2444</u>										
Data and Calculations										
Message Line	Yield (KTI)	Cloud-Top Height (meters)	Cloud-Bottom Height (meters)	2/3 Stem Height (meters)	① Distance of GZ/CS Radial Line (KM)	① Effective Wind Speed (kmph) $\frac{\text{Effective Wind Speed (kmph)}}{\text{Time of Fall}} = \text{sec}$ (Round to nearest kilometer per hour)	② Azimuth of GZ/CT Radial Line (degree)	③ Azimuth of GZ/2/3 Stem Radial Line (degree)	Effective Downwind Direction (degree) $\frac{\text{②} + \text{③}}{2} = \text{ddd}^\circ$	Warning Area Angle
A	2	4,900	2,600	1,700	5.5	$5.5 \times 1.136 = 6$			$\frac{2}{2} = 004$	
B	5	7,100	4,400	2,800	9.5	$9.5 \times 0.758 = 7$			$\frac{2}{2} = 007$	
C	30	11,600	7,700	5,100	17	$17 \times 0.455 = 8$	30	94	$\frac{124}{2} = 62$	64
D	100	14,400	9,300	6,200	23	$23 \times 0.385 = 9$	30	74	$\frac{104}{2} = 52$	44
E	300	18,700	11,000	7,400	34	$34 \times 0.333 = 11$	30	66	$\frac{96}{2} = 48$	
F	1,000	21,800	13,500	9,000	44	$44 \times 0.286 = 13$	30	70	$\frac{100}{2} = 50$	
G	3,000	28,250	15,800	10,500	35.5	$35.5 \times 0.250 = 9$	35	75	$\frac{110}{2} = 55$	

Effective Downwind Message	
ZULU	DDtttt <u>2 1 1 2 0 0</u> } 6 digits
ALFA	dddsss <u>0 0 4</u> - - - - - } 3 digits
BRAVO	dddsss <u>0 0 7</u> - - - - - } 3 digits
CHARLIE	dddsss <u>0 6 2 0 0 8 0 6 4</u> } 9 digits
DELTA	dddsss <u>0 5 3 0 0 9 0 4 4</u> } 9 digits
ECHO	dddsss <u>0 4 8 0 1 1</u> - - - - - } 6 digits
FOXTROT	dddsss <u>0 5 0 0 1 3</u> - - - - - } 6 digits
GOLF	dddsss <u>0 5 5 0 0 9</u> - - - - - } 6 digits

\* When the azimuth of the ground zero/cloud-top radial line ② or the azimuth of the ground zero/2/3 stem radial line ③ falls in the first quadrant (0 to 90 degrees) and the other falls in the fourth quadrant (270 to 360 degrees), result of ② + ③ divided by 2 will be the back azimuth of the effective downwind direction. In this case, determine ddd by the following method: if result is greater than 180 degree, subtract 180 degrees; if result is less than 180 degree, add 180 degrees. Enter in the effective downwind message.

DA Form 1971-3-R

Figure 3-21. Completed DA Form 1971-3-R, using the 3-6-9 rule.

## Naval Effective Downwind Message

Effective downwind speed and downwind direction (the direction towards which the wind is blowing) vary with the yield. Seven downwind speeds and downwind directions are transmitted in the Naval effective downwind message, corresponding to seven preselected yield groups. These groups are—

ALFA 2 KT and less  
 BRAVO more than 2 KT to 5 KT  
 CHARLIE more than 5 KT to 30 KT  
 DELTA more than 30 KT to 100 KT  
 ECHO more than 100 KT to 300 KT  
 FOXTROT more than 300 KT to 1 MT  
 GOLF more than 1 MT to 3 MT.

NAV EDMs can be produced at Naval NBC centers from actual wind data, or at designated meteorological centers from computer-originated forecast wind data.

A fallout prediction is prepared for the largest yield within each of the seven standard weapon yield groups—2 KT, 5 KT, 30 KT, etc. And, the calculated downwind directions and effective downwind speeds are transmitted to naval forces and ships in the NAV EDM.

The data will be transmitted in the following basic format:

### NAV Effective Downwind Message

ZULU	DDtttZ
ALFA	dddFFF
BRAVO	dddFFF
CHARLIE	dddFFF
DELTA	dddFFF
ECHO	dddFFF
FOXTROT	dddFFF
GOLF	dddFFF

In the NAV EDM, ZULU DDtttZ is the date (DD) and time (tttZ) in GMT, at which the actual wind conditions were measured (for example, 250600Z is the 25th day of the month at 0600 GMT).

The ddd digits reflect effective downwind direction in degrees, and FFF effective downwind speed in knots (ALFA 080025 is a downwind direction of 080 degrees and 025 an effective downwind speed of 25 knots) valid for yields of 2 KT or less.

Normally, a NAV EDM will be valid for six hours from the time the winds were measured (item ZULU in the

NAV EDM). Should the wind conditions change significantly within the six hours, a new NAV EDM will be transmitted.

An example of a NAV EDM is shown in Figure 3-23.

NAV Effective Downwind Message	
ZULU	201200Z
ALFA	095005
BRAVO	102012
CHARLIE	115014
DELTA	122016
ECHO	126015
FOXTROT	132015
GOLF	140017 (060)

**Figure 3-23. Example NAV EDM.**

**Note:** Naval ships receiving NBC reports from non-naval sources may have to convert metric units into maritime units of measurements.

Special cases exist with the NAV EDM. These cases occur when the effective wind speed is less than 5 knots and when the angle of the sector must be expanded.

When the effective downwind speed is less than 5 knots for a given yield group, the applicable line of the NAV EDM contains only three digits, giving the downwind distance of Zone I in nautical miles. An effective downwind direction is not transmitted in the NAV EDM, since in this case the downwind distance of Zone I describes the Zone I as a circle around GZ. Zone II will then be another circle around GZ, the radius of which is double the radius of the Zone I circle. Use 5 knots when estimating arrival time.

When, in the NAV EDM, a bracket containing a figure is added to the normal 6-digit figure, it means that the angle formed by the two radial lines must be expanded to form an angle of the number of degrees indicated in the bracket. In Figure 3-23, yield group GOLF, the increased angle is indicated to be 60 degrees-30 degrees to each side of the downwind axis. The angle expansion can also be given by adding a seventh digit to any of the yield groups.

## Preparation of a Message (Constant Pressure Data)

The procedure for preparing the effective downwind message from a constant pressure surface wind vector plot is modified in three steps:

**Step 1.** On the wind vector plot (Figure 3-24), draw radial lines from GZ through the points on the wind vector

plot representing the average cloud-bottom heights for the yields of interest. The average altitudes of cloud-bottom heights of the yields used in the simplified prediction method are also shown in Figure 3-24.

	YIELD (KT)	Average Altitude of Cloud-bottom Height (Feet)
A	2	9,000
B	5	14,000
C	30	25,000
D	100	30,000
E	300	36,000
F	1,000	44,000
G	3,000	52,000

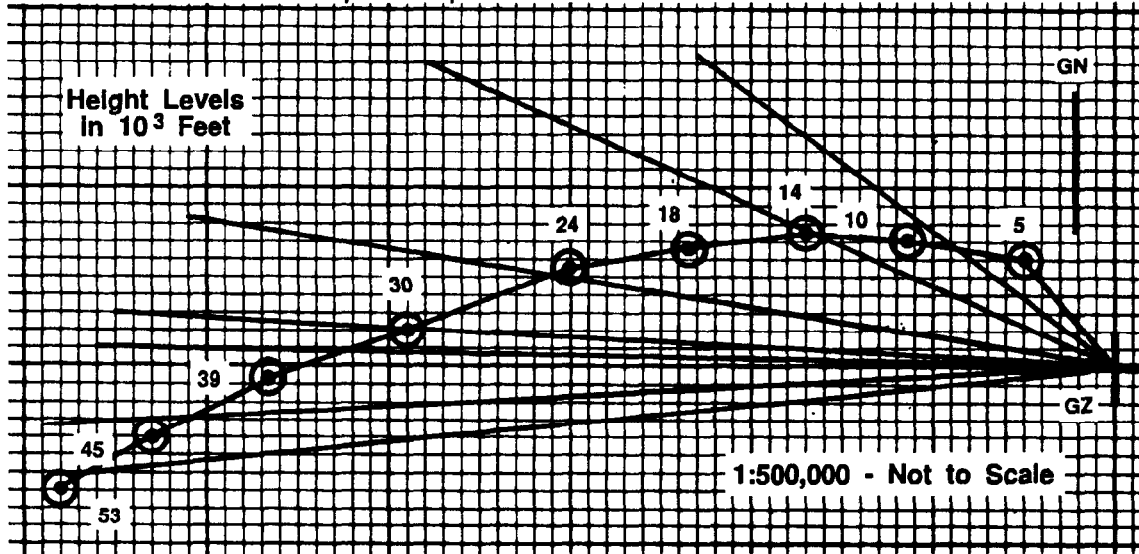

Figure 3-24. Constant pressure vector plot.

**Step 2.** Calculate the effective downwind directions and wind speeds:

a. Measure the azimuth of each radial line drawn which corresponds to the yield and altitude (Step 1). These azimuths (Table 3-2) are the effective downwind directions for each yield group in this example.

b. Measure the length in kilometers of each radial line, and divide these distances by the time of fall. The results are the effective wind speeds, as shown in Table 3-3.

**Step 3.** Prepare the EDM, using the data from steps 2a and 2b. Figure 3-25 shows the completed EDM.

Table 3-2. Effective downwind directions for yield groups.

	Yield Group	Azimuth (degrees)
A	2 KT or less	318
B	>2 to 5 KT	302
C	>5 to 30 KT	289
D	>30 to 100 KT	284
E	>100 to 300 KT	276
F	>300 to 1,000 KT	269
G	>1 MT to 3 MT	264

Table 3-3. Effective wind speeds for yield groups.

	Yield Group	Radial Distance from GZ to Cloud Bottom (km)	Time of Fall (hr) = Effective Wind Speed (kmph)*	
A	2 KT or less	24.0	0.88	27
B	>2 to 5 KT	35.6	1.32	27
C	>5 to 30 KT	56.0	2.20	25
D	>30 to 100 KT	64.8	2.60	25
E	>100 to 300 KT	76.3	3.00	25
F	>300 to 1,000 KT	92.8	3.50	27
G	>1 MT to 3 MT	104.1	4.00	26

\* Round off to nearest kilometer per hour.

Effective Downwind Message		
Standard Format	USMTF Program Format	
ZULU	301200Z	ZZZULU/301200Z//
ALFA	318027	YGALFA/318/027//
BRAVO	302027	YGBRAVO/302/027//
CHARLIE	289025	YGCHARLIE/289/025//
DELTA	284025	YGDELTA/284/025//
ECHO	276025	YGECHO/276/025//
FOXTROT	269027	YGFOX/269/027//
GOLF	264026	YGGOLF/264/026//

**Figure 3-25. Completed effective downwind message from steps 2a and 2b data.**

## M5A2 Fallout Predictor

The M5A2 radiological fallout predictor (Figure 3-26, page 3-22) is a transparent device used to outline the zones of hazard resulting from surface bursts for preselected yield groups. The M5A2 fallout predictor is composed of two simplified predictors and a nomogram for determining the downwind distance of Zone I. One simplified predictor is drawn to a scale of 1:50,000; the other predictor is drawn to a scale of 1:250,000. Each predictor contains six preselected yield groups (A, B, C, D, E, and F).

Each simplified predictor consists of four major parts:

**Part 1.** An azimuth dial for orientation.

**Part 2.** Semicircles depicting stabilized nuclear cloud radii drawn about GZ and showing the area of contamination for each of the preselected yield groups.

**Part 3.** A map scale calibrated in kilometers along two radial lines extending out from the center of the azimuth dial.

**Part 4.** Nomogram for determining the downwind distance of Zone I.

The nomogram from Figure E-6, consisting of three scales, is positioned between the radial lines of the M5A2. It is used to determine the downwind distance of Zone I. The left-hand scale is the effective wind speed in kilometers per hour. The center scale is the downwind distance of Zone I in kilometers. The right-hand scale is the yield in kilotons.

To convert the M5A2 to conform with STANAG 2103, draw a 28-kilometer semicircle around GZ, and label it with the letter G. This line is used for bursts greater than 1 megaton, but less than or equal to 3 megatons.

### Procedures for Using Simplified Method

Use of the M5A2 requires a current effective downwind message, an actual or estimated yield of the nuclear weapon detonated, and location of GZ. Normally, the user

of the M5A2 will obtain the yield and the location of GZ from measured data or from the NBC 2 nuclear report. Follow these six steps to prepare the prediction (See Figure 3-26, for fallout predictor.):

**Step 1.** Identify the prediction. Record the location of GZ and the date-time of burst on the predictor.

**Step 2.** Effective wind speed and downwind direction. Get this data from the appropriate line of the effective downwind message.

**Step 3.** Downwind distances of the zones. Determine the downwind distance of Zone I from the nomogram (Figure E-6) on the M5A2. Do this by connecting the effective wind speed and the point on the scale representing the yield with the straight edge or hairline.

**Note:** Use the actual or estimated yield, not the yield group.

Read the downwind distance of Zone I, in kilometers, at the point of intersection of the straight edge. The downwind distance of Zone II is twice that of Zone I. Draw arcs between the two radial lines, using GZ as center, with radii equal to the two downwind distances determined.

**Step 4.** Draw left and right tangents from the cloud radius line for the yield group (from Step 3) to the points of intersection of the radial lines and Zone I arcs of the predictor. This area represents the primary hazard.

**Step 5.** Label Zones I and II. Darken the remainder of the prediction perimeter with a grease pencil to emphasize the area of hazard.

**Step 6.** Time-of-arrival arcs. Draw in these arcs, using the effective wind speed.

Draw as many &shd time-of-arrival arcs between the radial lines or tangent lines as will fall within the zones. Label each time-of-arrival arc as hours after H-hour (for example, H+1, H+2). Estimate times of arrival by using the effective wind speed (procedure indicated in the next paragraph). If a time-of-arrival arc coincides with a zone

Area Predictor, Radiological Fallout, M5A2

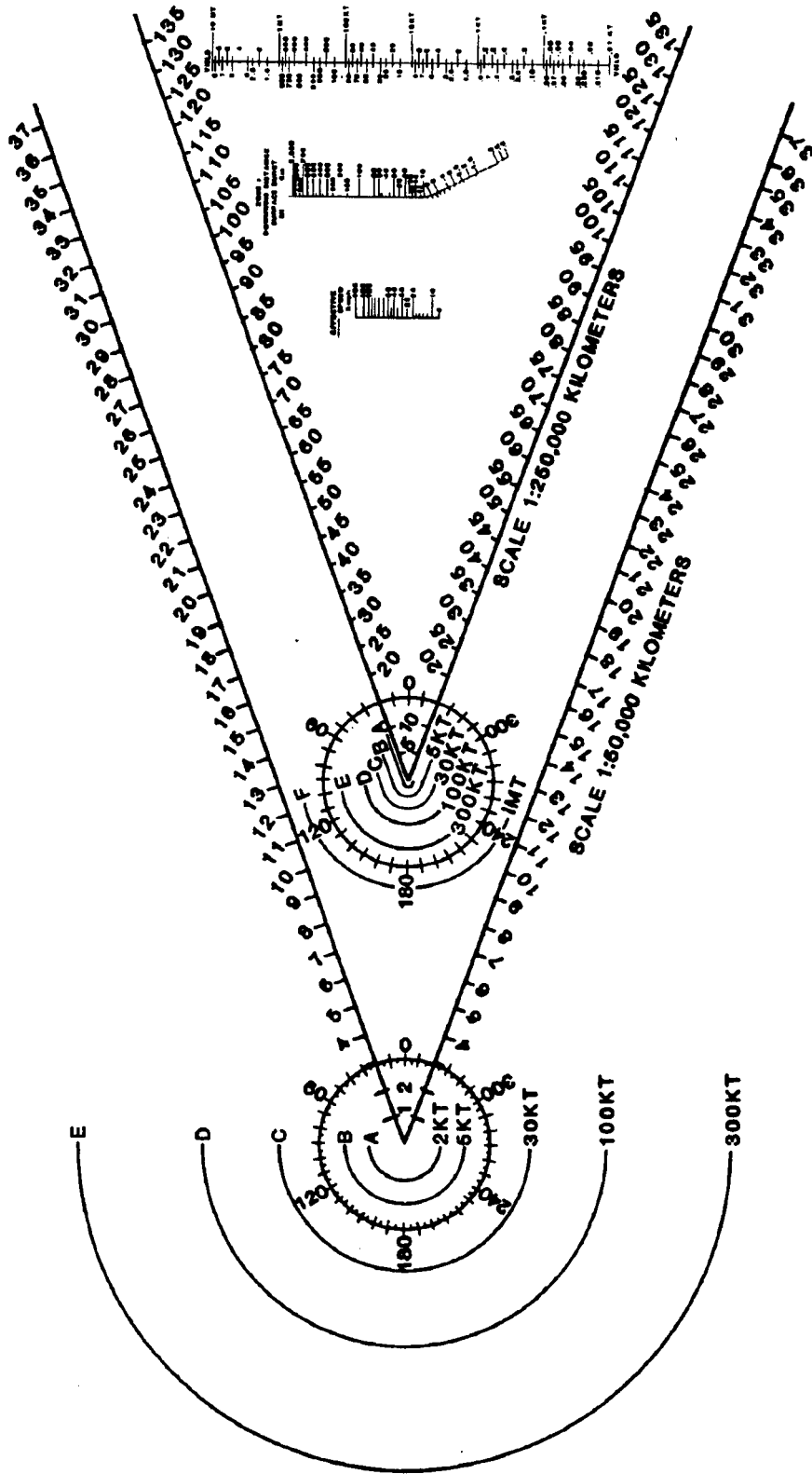

Figure 3-26. M5A2 simplified fallout predictor.



boundary, extend the zone boundary with a dashed line, and label with the appropriate time of arrival. Do not draw time-of-arrival arcs beyond Zone II.

Times of arrival can be estimated. Multiply the effective wind speed by the time of interest expressed in hours after the burst. Time-of-arrival arcs represent the expected downwind extent of fallout at specific times. These arcs are drawn as part of the fallout prediction. Estimate time of arrival of fallout at a specific distance from GZ by dividing the distance by the effective wind speed. The formula looks like this:

$$\text{Time of arrival (hr)} = \frac{\text{distance from GZ (km)}}{\text{effective wind speed (kmph)}}$$

For operational purposes, the following rules of thumb may be applied to the actual arrival of fallout:

- The actual arrival of fallout may occur as early as one-half of the estimated time of arrival. That is, if the estimated time of arrival of fallout is H+4 hours, actual arrival of fallout may occur as early as H+2 hours.
- If actual arrival of fallout has not occurred at twice the estimated arrival time (or 12 hours, whichever is earlier), it may be assumed that the area will not receive fallout. For example, if the estimated time of arrival of fallout in an area is H+5 hours and fallout has not occurred at H+10 hours, assume that the area will not receive fallout. Also, if a unit expects fallout to arrive at H+9, but it has not arrived by H+12, assume it will not arrive at all.

**Orientation.** Make sure the scale of the M5A2 and the map scale are the same. Next, place the fallout predictor GZ point over the actual or assumed GZ on the map. Rotate the entire fallout predictor until the effective downwind direction in degrees on the azimuth dial is pointing toward GN.

The simplified fallout prediction is now complete, and the operational aspects of the fallout hazard can be evaluated.

**Special Notes:** Infrequently, the fallout wind vector plot prepared by the NBCC may have a warning area angle greater than 40 degrees. In these cases, state the greater angle on the effective downwind message for the yield group affected. Using units will expand the warning area beyond the fixed 40-degree angle of the simplified fallout predictor to correspond with the angle given on the effective downwind message. Angles must be expanded equally on both sides of the predictor. The expanded case example discussed later in this chapter shows how this is done.

### Constructing a Simplified Predictor

If the fallout predictor shown in Figure 3-26 is not available, a predictor can be constructed from any pliable, transparent material to any desired map scale as follows:

**Step 1.** Select an appropriate map scale. On a piece of pliable, transparent material or overlay paper, draw a thin dotted line (reference line) to a scaled length of 50 kilometers from a point selected to represent GZ (Figure 3-27).

**Step 2.** Draw and graduate in kilometers two radial lines from GZ at angles of 20 degrees to the left and to the right of the dotted reference line (Figure 3-28).

**Step 3.** On the side of GZ opposite the reference line, draw a series of concentric semicircles (using the selected map scale) having radii of 1.2 kilometers, 1.9 kilometers, 4.2 kilometers, 6.8 kilometers, 11.2 kilometers, 18.0 kilometers, and 28 kilometers). These figures correspond to stabilized cloud radii from nuclear bursts with yields of 2 kilotons, 5 kilotons, 30 kilotons, 100 kilotons, and 3 megatons, respectively.

**Step 4.** Label the semicircles. Starting with the semicircle closest to GZ and moving up from GZ, label the semicircles A, B, C, D, E, F, and G. Moving down from GZ, label the semicircles 2 kilotons, 5 kilotons, 30 kilotons, 100 kilotons, 300 kilotons, 1 megaton, and 3 megatons.

To use the field-constructed predictor, complete the prediction by determining the downwind distance of the Zone I from Figure E-6, Appendix E, using the procedures described earlier. Place the protractor over an actual or assumed GZ on the map and draw a line to represent the effective downwind direction for the desired yield group. Place GZ of the predictor over GZ on the map, and rotate the predictor until reference lines coincide with the effective downwind direction.

The simplified fallout prediction is verified only from the standpoint of using the correct yield and GZ location. This is done upon receipt of the NBC 2 nuclear report from higher headquarters. Identify the simplified fallout

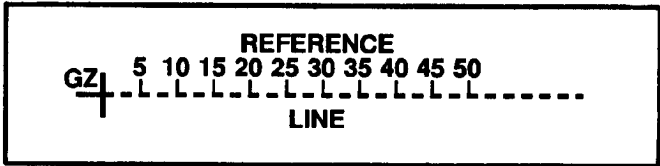

Figure 3-27. Reference line for expedient predictor.

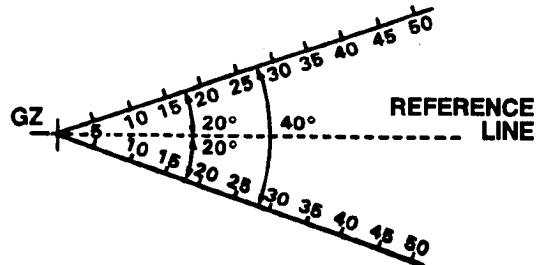

Figure 3-28. Radial lines extending from GZ on predictor.

prediction by entering the strike serial number (line Alfa of NBC 2), coordinates of GZ, and date-time group of detonation on the predictor. The following examples illustrate simplified fallout predictions.

### Simplified Fallout Prediction (Normal Case)

The S3, 2d Battalion, 62d Infantry, has the effective downwind message in Figure 3-29, based on the following situation scenario:

At about 240600Z a nuclear burst occurred at a point estimated to be MN553298. A measurement of the flash-to-bang time and nuclear-burst cloud width indicates an estimated yield of 16 kilotons.

Use the M5A2 fallout predictor to make a fallout prediction. The estimated yield (16 kilotons) lies within the yield group Charlie (more than 5, not more than 30 kilotons). So, use the effective downwind direction and effective wind speed from line Charlie of the EDM; and use semicircle C on the fallout predictor. Using a yield of 16 KT and an effective wind speed of 16 kilometers per hour, read the downwind distance of Zone I (18 kilometers) from the nomogram on the predictor. Draw an arc between the radial lines of the predictor at a distance of 18 kilometers downwind from GZ (Figure 3-30). Double this distance; and draw a second arc between the radial lines of the predictor at a distance of 36 kilometers downwind from ground zero.

Draw two straight lines tangent to the 30-kiloton cloud radius semicircle, and extend them to where the Zone I arc intersects the radial lines. The area enclosed by the two lines, the 30-kilotons semicircle (40° angle), and the 18-kilometer arc, is Zone I. The area enclosed by the 18-kilometer and 36-kilometer arcs and the radial lines is Zone II. Draw a series of dashed arcs at distances equal to

Effective Downwind Message	
ZULU	240600Z
ALFA	080015
BRAVO	085015
CHARLIE	090016
DELTA	100010
ECHO	110025
FOXTROT	120020

**Figure 3-29. Effective downwind message by 2d Bn, 62d Inf.**

the product of the effective wind speed (16 kilometers per hour) and the hours of interest after the burst to represent the estimated times of arrival of fallout (16 kilometers at H +1 and 32 kilometers at H+2) (Figure 3-30). Arcs that fall outside Zone II need not be drawn. Draw a straight line from the center of the azimuth dial through the effective downwind direction (90 degrees) on the azimuth dial, and label the line "GN."

Place the center of the azimuth dial on the predictor over the estimated GZ (MN553298) on the map (the scales of the map and predictor must correspond). Rotate the predictor around the GZ point until the GN line is pointing toward GN. The predictor is now oriented so that fallout is going toward 90 degrees. The area predicted to be covered by fallout can now be evaluated.

### Simplified Fallout Prediction (Expanded Case)

Assume that line Charlie is the same as in the preceding example, but it also has three more digits—total of nine digits. Line Charlie now reads 090016060. Follow the same procedure as for a normal case, but expand the left and right radial lines to 60 degrees. The prediction will look like that in Figure 3-30.

### Simplified Fallout Prediction (Circular Case)

The S3, 2d Battalion, 62d Infantry, has the effective downwind message shown in Figure 3-31.

At about 1300 a nuclear burst occurred at a point estimated to be MN423876. A measurement of the cloud width and distance to GZ indicates a yield of 4 kilotons.

The estimated yield of 4 kilotons falls into yield group Bravo of the effective downwind message. There are only three digits in line Bravo (007). This indicates a wind speed of less than 8 kmph. It also means the prediction will have a circular pattern. On a piece of overlay paper, clear plastic, or an M5A2 predictor drawn to scale, draw a circle with a 7-kilometer radius. Label it Zone I. For Zone II, double the distance of Zone I, and draw a circle, using the same center used for Zone I. Label it Zone II. Label the prediction with GZ and date-time of detonation. The prediction is now complete (see Figure 3-32). Now, it may be placed on the map.

## Ship's Fallout Template

A fallout template, particularly designed for use on ships, is shown in Figure 3-33.

The ship's fallout template is similar to the M5A2 fallout predictor (Figure 3-26) used by forces on land. The main

difference is that the semicircles upwind of GZ on the ship's fallout template do not refer to preselected weapon-yield cloud radii.

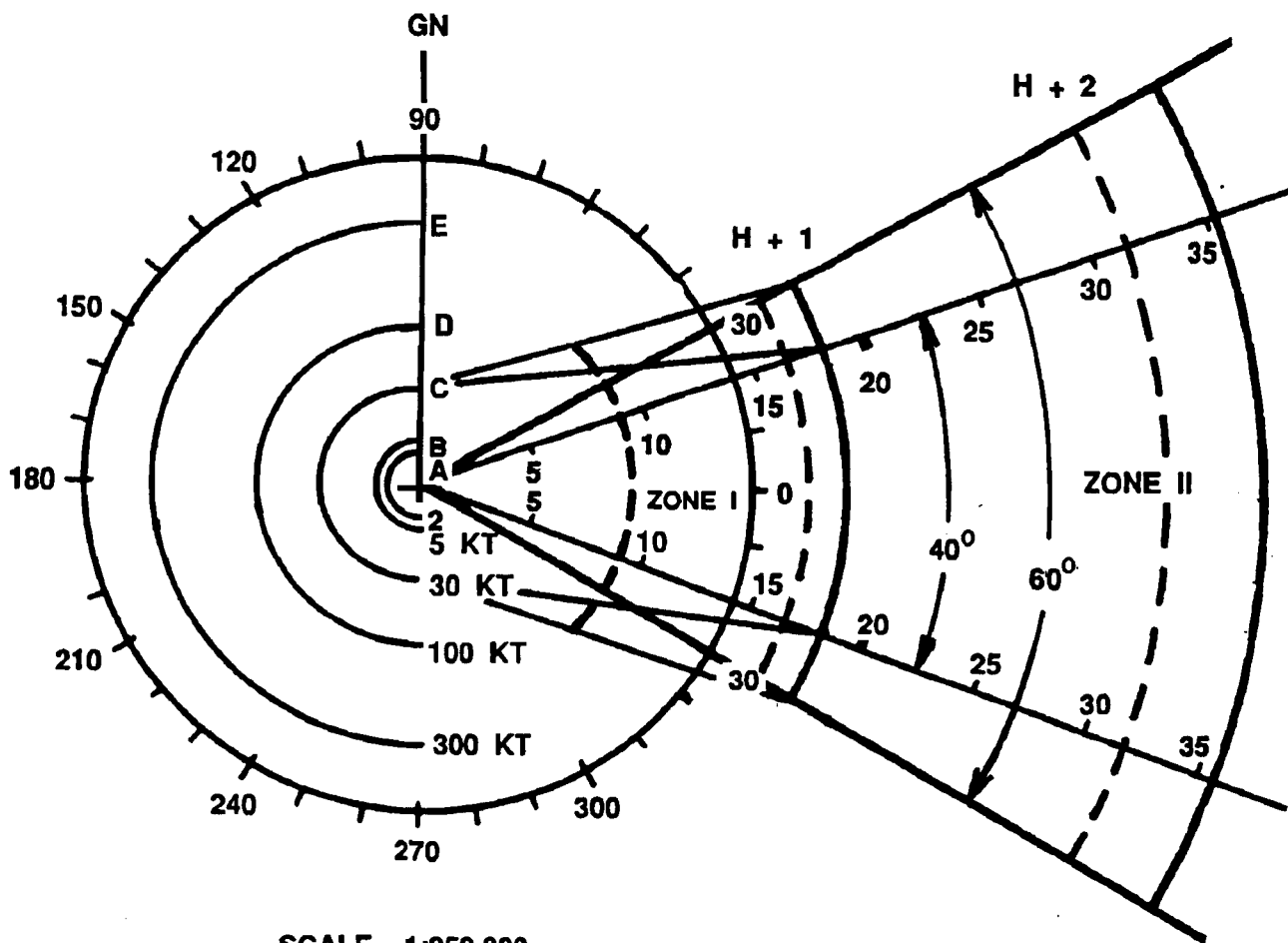

SCALE 1:250,000

Figure 3-30. Fallout prediction, using M5A2 (expanded case).

EFFECTIVE DOWNWIND MESSAGE

ZULU	241200Z	ZZZULU/241200Z//
ALFA	004	YGALFA/004//
BRAVO	007	YGBRAVO/007//
CHARLIE	021019	YGCHARLIE/021/019//
DELTA	029021	YGDELTA/029/021//
ECHO	040030	YGECHO/040/030//
FOXTROT	098050	YGFOXTROT/098/050//

Figure 3-31. Effective downwind message for 2d Battalion.

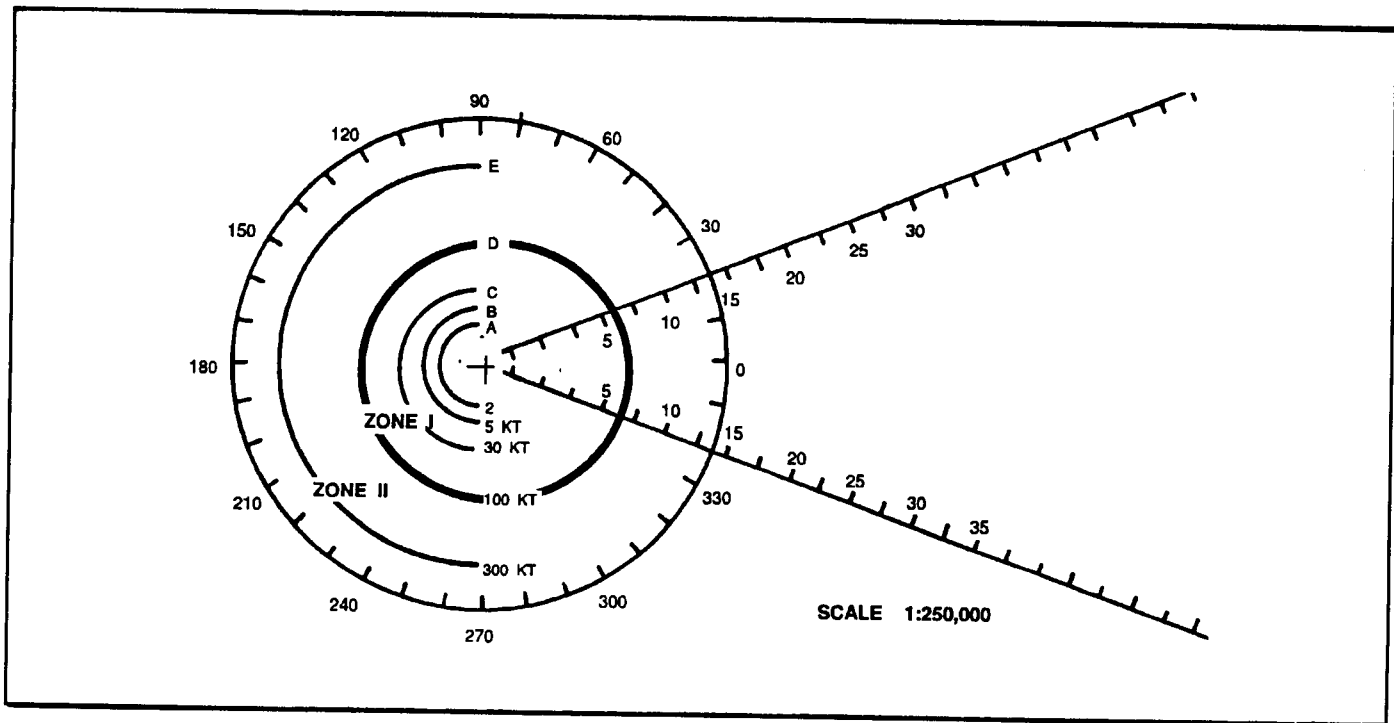

Figure 3-32. Fallout prediction, using M5A2 (circular case).

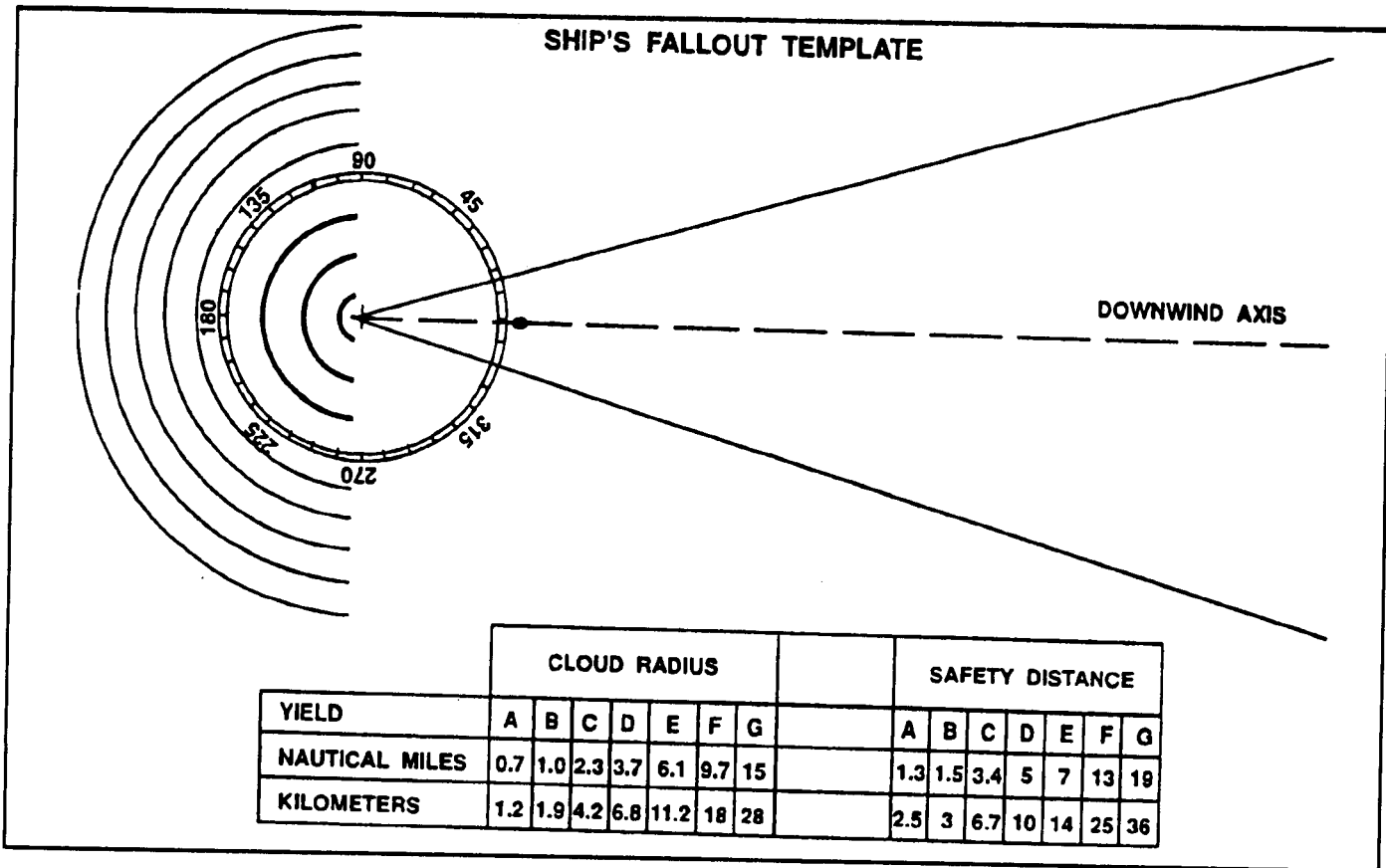

Figure 3-33. Ship's fallout template.

## Safety Distance

Determining the safety distance begins with determining the fallout area at a specific time after detonation. Fallout will not occur simultaneously within the predicted fallout area. It will commence in the vicinity of GZ and maybe expected to move down the fallout pattern (downwind direction) with approximately the speed of the effective wind.

The approximate zone in which deposition at the surface is taking place at a specific time after the detonation may be determined by use of the following procedures:

**Step 1.** Multiply the effective downwind speed by time (in hours) after the detonation.

**Step 2.** To the distance found in Step 1, add and subtract the safety distance obtained from the template (for the standard yield groups) or from the graph in Figure 3-34 (any yield), to allow for finite cloud size, diffusion, and wind fluctuations.

**Step 3.** On the plot (template), with GZ as center and the two distances obtained from 2, as radii, draw two arcs across the fallout pattern. The zone enclosed between these two arcs will, in most cases, contain the area of deposition at a specific time after the detonation.

## Fallout Plotting from NAV EDM and Observations

Worked example:

A ship has received the NAV EDM shown in Figure 3-23 (page 3-19). At 201332Z, a nuclear burst is observed from the ship, and based upon the observations taken from the ship, the yield is estimated to be 70 KT; estimated GZ is 56°00' N-12° 00' E. A NAV NBC 1 nuclear report is transmitted as required; and the ship will have to prepare a fallout prediction, using the simplified procedures:

**Step 1.** As the yield is estimated only on the basis of the ship's own observations, the yield estimation may not be accurate. So, to be on the safe side, the greatest yield of the yield group in which the estimated yield is contained should be used. Seventy KT is in yield group DELTA, and the largest yield in this group is 100 KT. Therefore, 100 KT will be used for the fallout prediction.

**Step 2.** Select the data contained in the DELTA yield group in the NAV EDM: DELTA 122016, meaning that the effective downwind direction is 122 degrees, and the effective downwind speed is 16 knots.

**Step 3.** On the template draw the GN line from GZ through 122 degrees on the compass rose see Figure 3-35.

**Step 4.** From the graph in Figure 3-36 (page 3-29) or the

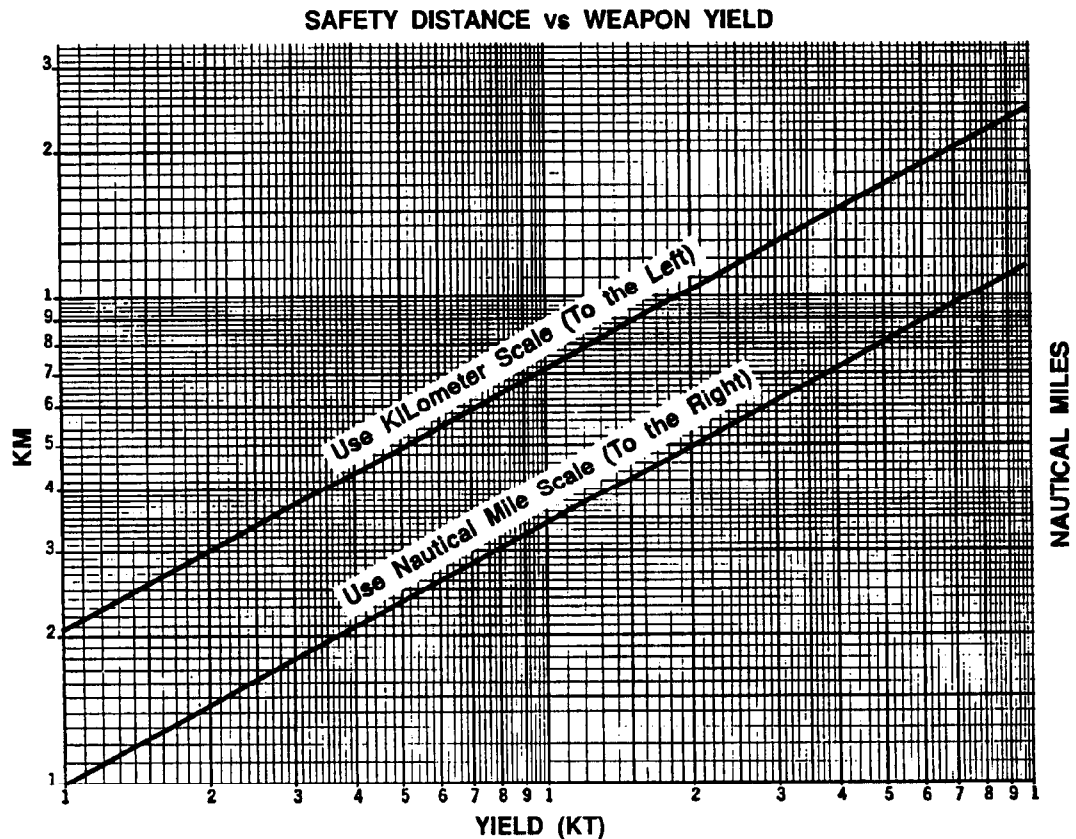

Figure 3-34. Safety distance as a function of weapon yield.

nomogram in Figure 3-37 (page 3-30), determine the downwind distance of Zone I to be 30 nautical miles. Zone II downwind distance is double this distance, or 60 nautical miles from GZ, in effective downwind direction.

**Step 5.** Using GZ as center and the two distances, the Zone I and Zone II distances as radii (to the appropriate chart scale), draw two arcs between the radial lines. From the template or from Figure 3-38 (page 3-31) read the cloud radius to be 3.7 nautical miles, and draw a semicircle upwind of GZ, using GZ as center and 3.7 nautical miles as radius. The preprinted semicircles may be helpful. From the intersections of the Zone I arc with the radial lines, draw lines to connect with the ends of the semicircle.

**Step 6.** Determine the area where deposit of fallout is estimated to take place at a specific time after the detonation. Multiply the effective downwind speed by the time (hours after detonation)—1.5 hours after the burst (H +1.5 hours): 16 knots x 1.5 hours = 24 nautical miles.

With GZ as center and 24 nautical miles as radius, draw a dotted arc across the fallout plot. This arc represents the middle of the area within which fallout may be expected to reach the surface at H+1.5 hours after the detonation. To

allow for finite cloud size, diffusion and wind fluctuations, a certain distance ahead of and behind this line must be added to determine the area within which, in most circumstances, the fallout will be deposited at the surface at H+1.5 hours. This is the safety distance. From the table printed on the template or from Figure 3-34, find the safety distance for yield group DELTA (100 KT) to be 5 nautical miles. Add and subtract 5 nautical miles to and from 24 nautical miles:

$$24 + 5 = 29 \text{ nautical miles,}$$

$$\text{and } 24 - 5 = 19 \text{ nautical miles.}$$

Using these two distances as radii and GZ as center, draw two arcs across the fallout pattern. The area confined by the two arcs and the cross wind boundaries of the fallout area defines the approximate area of fallout deposit at 1.5 hours after the detonation.

Complete the fallout prediction plot by indicating the following on the fallout template:

- NAV EDM used,
- Yield (estimated or actual),
- GZ, and
- Geographic chart number (scaling).

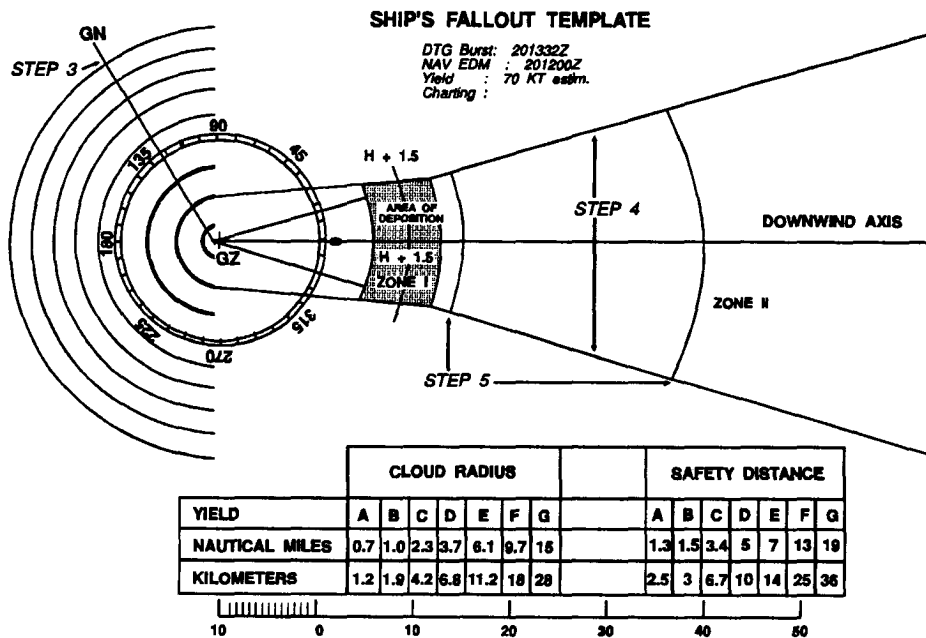

Figure 3-35. Fallout plotting, using ship's fallout template.

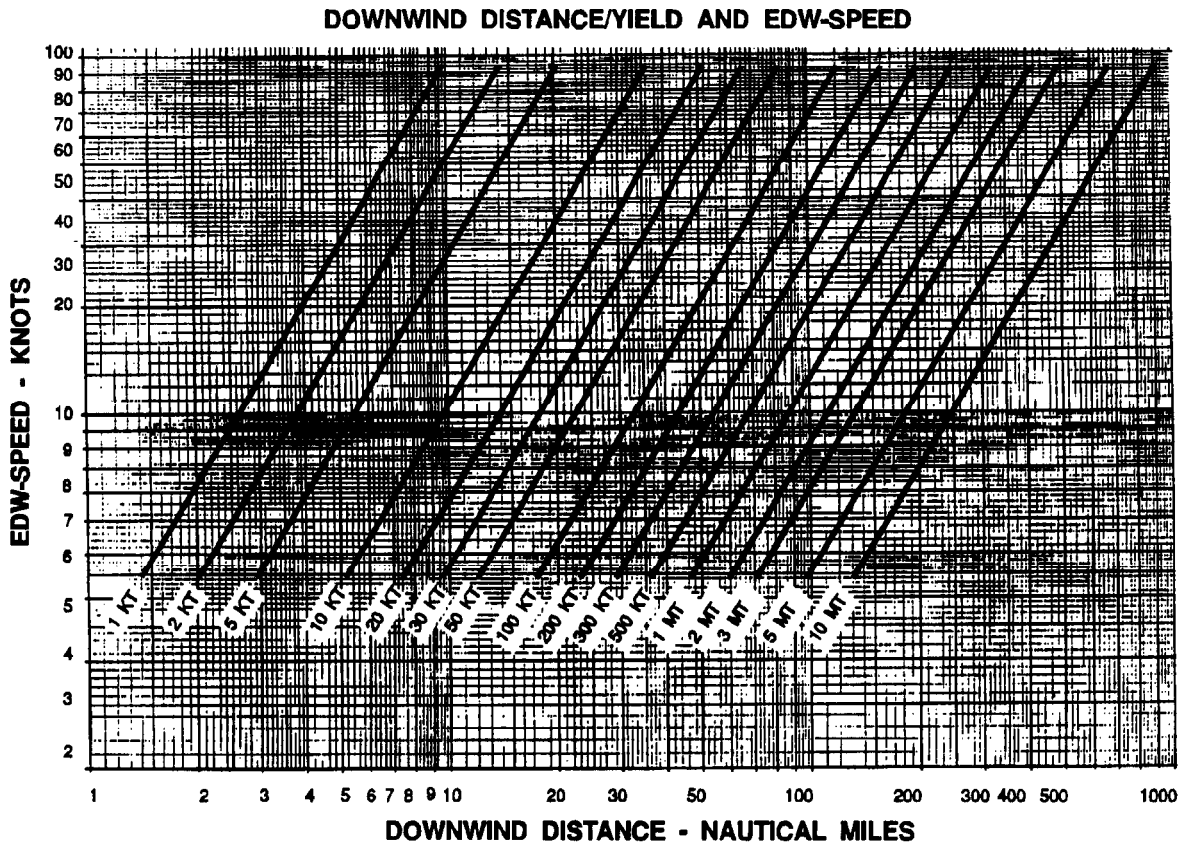

Figure 3-36. Downwind distance of Zone I (nautical miles) versus yield and effective wind speed (knots).

### Fallout Plotting from NAV EDM and NAV NBC 2 Nuclear Report

Based on a number of NAV NBC 1 nuclear reports, the NBC collection/subcollection center will calculate the weapon yield, GZ, and type of burst. These data will be transmitted to naval forces/ships in the format of a NAV NBC 2 nuclear report.

Example:

NAV NBC 2 Nuclear

A 24 (strike aerial number)  
 D 201405Z (date-time of detonation)  
 F 56°00'N-11° 15'E (location of detonation)  
 H SURFACE (type of burst)  
 N 10 KT (actual yield)

Based on the information from NAV NBC 2 nuclear report and NAV EDM, the ship will produce a fallout plot, following the principles described in the preceding paragraphs with a few adjustments:

- Step 1.** Determine downwind distance of Zone I by using the actual yield (item N in NAV NBC 2 nuclear report as entrance figure in Figure 3-36 or Figure 3-37).
- Step 2.** Determine the cloud radius by using the actual yield as your entrance figure in Figure 3-38.
- Step 3.** Determine the safety distance by using the actual yield as entrance figure in Figure 3-34.

**Step 4.** When the plot has been prepared, complete the fallout prediction plot by indicating the following on the template:

- NAV NBC 2 nuclear report used,
- Yield, and date-time of burst,
- GZ,
- Geographic chart number (scaling), and
- NAV EDM used.

The NBC 2 nuclear report and simplified fallout procedures are designed to give the tactical commander a quick reference or picture of the potential fallout pattern. This picture will allow the commander to plan accordingly, if the unit is within the potential fallout pattern. Such planning and preparation may include: start continuous monitoring, cover supplies and equipment (to include food and water supplies), warn adjacent and subordinate units of the potential threat, and ensure dosimeters (IM93s) are zeroed and issued to appropriate individuals.

Once the NBCC has collected sufficient data (numerous NBC 1 and 2 nuclear reports from designated units, a visual description of the crater and exact location of ground zero) the center will generate an NBC 3 nuclear report for a detailed fallout prediction. This report provides tactical units more precise data on the extent and arrival of fallout that will possibly be of operational concern.

**DOWNWIND DISTANCE  
ZONE OF IMMEDIATE CONCERN**

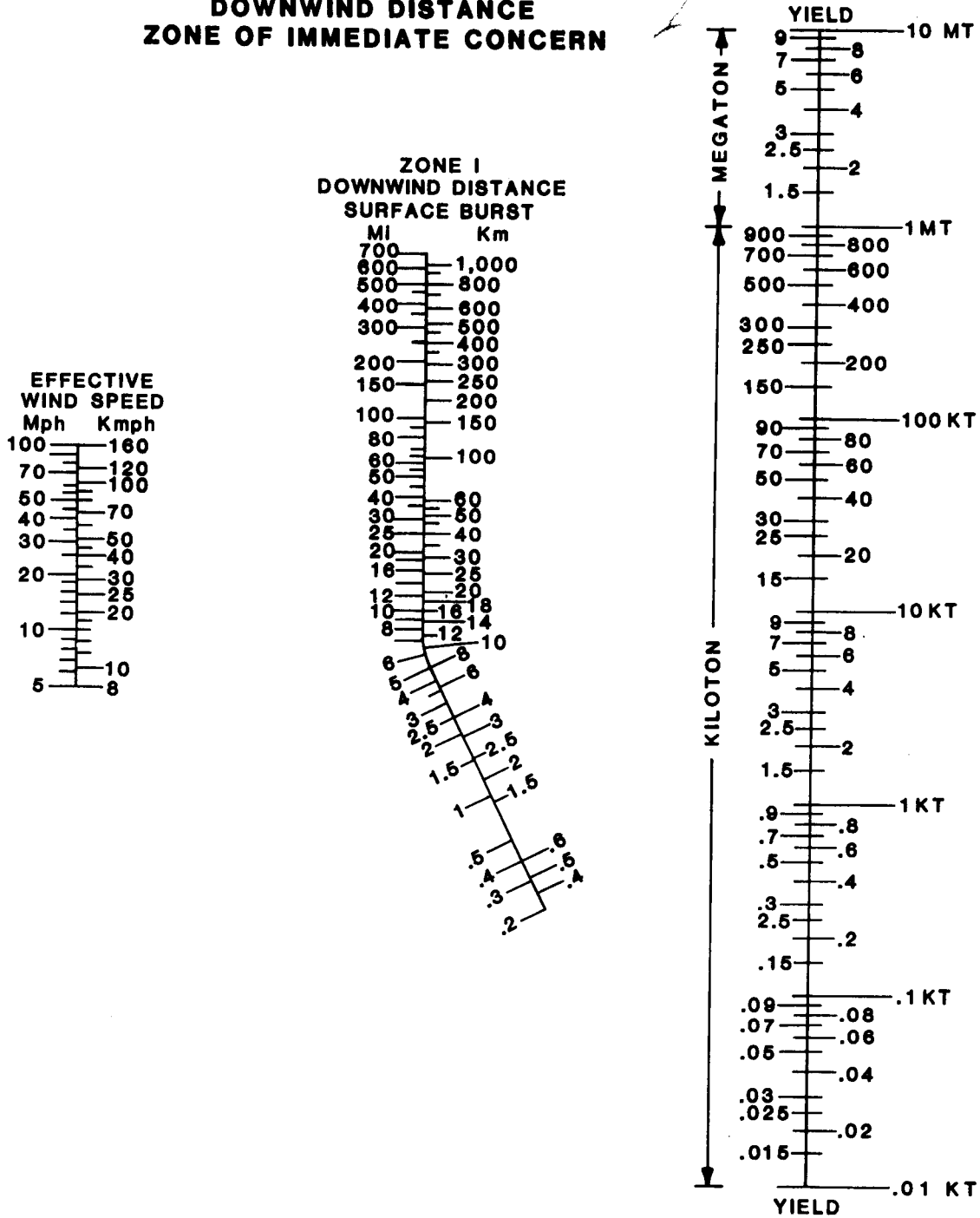

Figure. 3-37. Downwind distance to zone 1.



**RADIOACTIVE CLOUD AND STEM PARAMETERS  
(STABILIZED AT H + 10 MINUTES)**

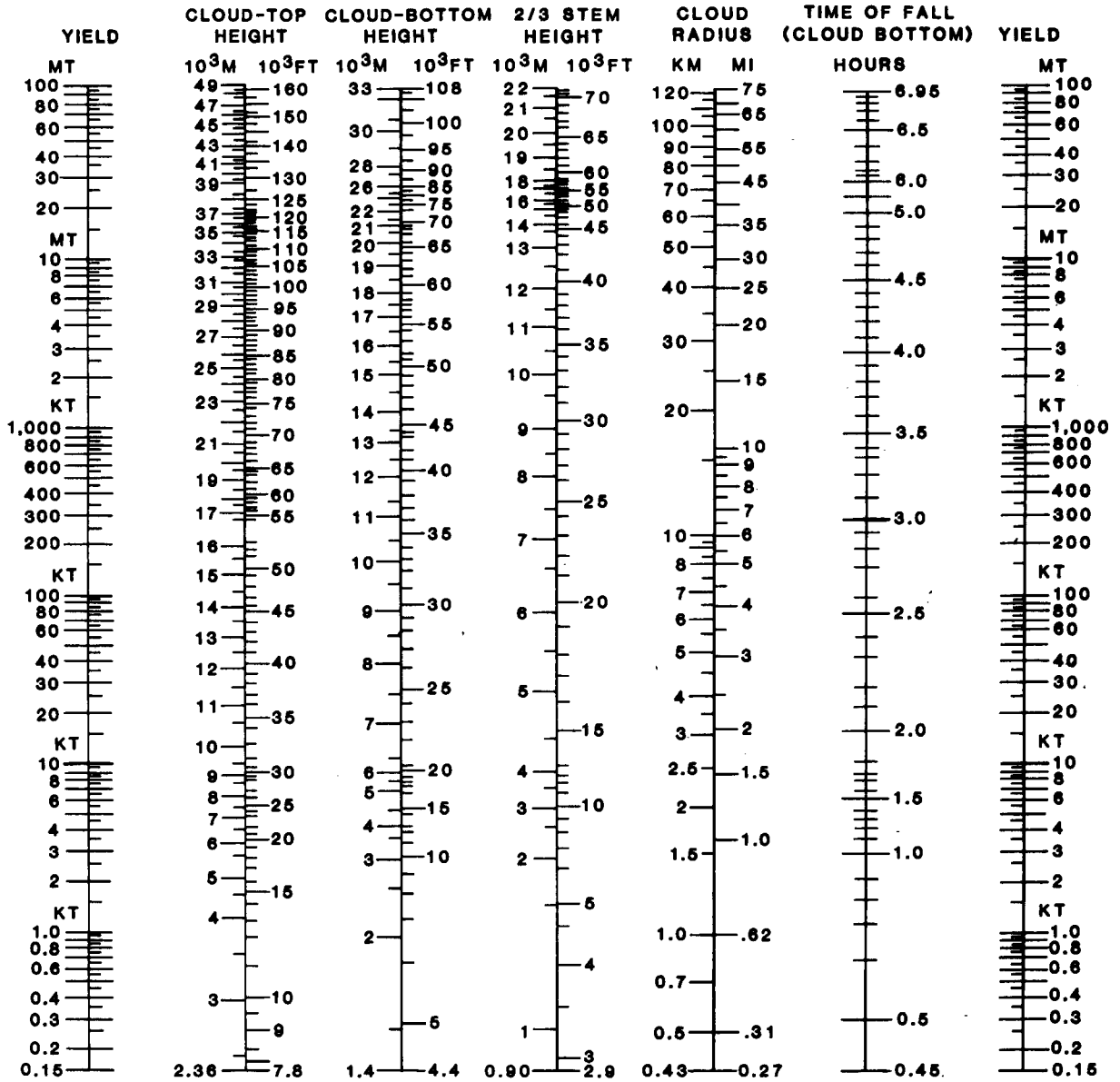

Figure 3-38. Stabilized cloud and stem parameters.

## Chapter 4

# Detailed Fallout Prediction—NBC 3 Report

## Overview

The need for a fallout prediction system stems from the large-area radiological hazard that develops from fallout-producing nuclear bursts. Contamination has a large impact on military planning and operations. This hazard produces mass casualties if its presence is not detected and actions taken to minimize the radiological hazards. Commanders at all echelons must understand its effects and take action to minimize those effects.

There are many occasions when a commander will require a fallout prediction. Three examples follow:

- When the commander plans to use a nuclear weapon that lacks 99-percent probability of being fallout safe or whenever a contact backup fuze is used, a prestrike fallout prediction is prepared as part of the target analysis.
- Information may indicate that fallout is occurring or that fallout probably will occur from a nuclear burst (friendly or enemy). In this case, a fallout prediction is required to enable the commander to warn higher, adjacent, and subordinate units.
- When a fallout-producing burst occurs, an evaluating procedure is begun that will answer the commander's questions about the hazard. However, a time lag of several hours to a day or more may occur between the time of burst and the availability of measured data (from radiological monitoring and/or survey). This delays evaluation of the actual hazard. During this time lag, the fallout prediction (area of expected hazard), or at best the fallout prediction supplemented by measured radiation data, may be the only available information for estimating the effects of the radiation hazard on tactical operations or plans. This information is significant in that it will enable the commander to avoid the contamination, if possible.

### Significance of Predicted Fallout Zones

In both simplified and detailed prediction, a zone of primary hazard (Zone I) and one of secondary hazard (Zone II) are predicted. Figure 4-1 shows Zones I and II. These zones are defined as areas where exposed, unprotected personnel may receive militarily significant

total doses of nuclear radiation within four hours after arrival of fallout. These doses may result in a reduction in combat effectiveness.

### Inside the Predicted Area

Zone I delineates the area of primary hazard and it is called the zone of immediate operational concern. In this zone, there will be areas where exposed, unprotected personnel may receive doses of 150 centigray (cGy) (the emergency risk dose), or greater, in a relatively short period of time (less than four hours after arrival of fallout). (See Appendix A for a detailed discussion on emergency risk dose). Major disruptions of unit operations and personnel casualties may occur within portions of this zone. Actual areas of disruption are expected to be smaller than the entire area of Zone I. But, exact locations cannot be predicted.

The exact dose personnel will receive at any location inside Zone I depends on the dose rate at their location, the time of exposure, and available protection. There is, however, a reasonably high assurance that personnel outside the boundary of Zone I will not be exposed to any emergency risk dose in less than four hours. The radiation produced from neutron-induced activity will be closely confined to the area around GZ, which will be well within

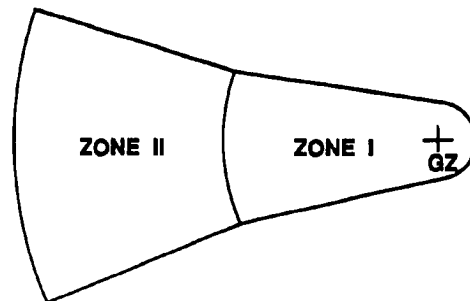

Figure 4-1. Example of predicted Zones I and II.

the limits of Zone I. So induced radiation will have no effect on the extent of Zone I but will cause higher dose rates in the area around GZ. Thus, the dose from induced radiation is not considered in determining the extent of Zone I.

Zone II is called the zone of secondary hazard. In this zone, the total dose received by exposed, unprotected personnel is not expected to reach 150 cGy within four hours after the arrival of fallout; but personnel may receive a total dose of 50 cGy (the negligible risk dose), or greater, within the first 24 hours after the arrival of fallout. But, only a small percentage of personnel in the zone is expected to receive these doses.

The exact dose personnel will receive at any location within Zone II depends upon the dose rate at their location, the time of exposure, and available protection. Personnel located close to the extent of Zone I normally will receive higher doses than those located close to the extent of Zone II. Personnel with no previous radiation exposure maybe permitted to continue critical missions for as long as four hours after the arrival of fallout without incurring the emergency risk dose. If personnel in this zone have previously received significant radiation doses (a cumulative dose of 150 cGy or more), serious disruption of unit mission and casualty-producing doses may be expected.

## Outside the Predicted Area

Exposed, unprotected personnel may receive a total dose that does not reach 50 cGy in the first day (24 hours) after actual arrival of fallout. The total dose for an infinite time of stay outside the predicted area should not reach 150 cGy. Therefore, outside the predicted area, no serious disruption of military operations is expected to occur if personnel have not previously been exposed to nuclear radiation. Appreciable previous exposure should be considered. In either case, periodic radiological monitoring coupled with routine radiological defense measures normally will provide adequate protection. These defense measures or protection measures are outlined in FM 3-4.

## Reliability

The predicted zones of fallout are larger than the actual area of the ground that will be covered by fallout. These zones represent areas of hazard. Radioactive particles are predicted to fall within these zones. Due to the uncertainty of weather and nuclear burst input data, the precise locations of fallout within the zones cannot be reliably predicted. Reconnaissance, monitoring, and survey will assist in locating contaminated areas after fallout has settled. These procedures are discussed in Chapter 5. The zones, therefore, have been developed so that there is a reasonably high assurance that all militarily significant fallout will occur inside them. This is true in all cases

except those that involve rainout or washout. They represent an expected hazard area that can be quickly predicted immediately after receipt of actual or planned nuclear burst information.

## Arrival of Fallout

The arrival of fallout is of great interest to commanders. Only by knowing when to expect fallout can plans be made to avoid it. Calculate the estimated time of arrival of fallout using the following procedures—

**Step 1.** Measure the distance from the given location to GZ.

**Step 2.** Determine the effective wind speed from the NBC 3 nuclear report or by using the procedures outlined previously for EDMs in the preceding chapter.

**Step 3.** Divide the distance from GZ by the effective wind speed. The result is the estimated time of arrival :

$$\text{Time of arrival (TARR)} = \frac{\text{distance from GZ (km)}}{\text{effective wind speed (kmph)}}$$

Commanders must remember three basic rules when estimating the time of arrival of fallout

**Rule 1.** Fallout may arrive as early as one-half of the estimated time of arrival (ETA).

**Rule 2.** If fallout has not arrived by twice the ETA or H+ 12 (whichever is earliest) fallout is not expected to fall on that location.

**Rule 3.** Fallout may not cover the entire predicted area. Therefore, units must not move based solely on the fallout prediction.

An estimate may also be made mathematically to determine when fallout will be completed at a particular location on the battlefield:

$$T \text{ completion} = 1.25 \times \text{TARR} + \frac{\text{cloud diameter}}{\text{effective wind speed}}$$

The time (T) in hours after detonation by which fallout will be completed at any specific point is approximately one and one-quarter the time of arrival (in hours after detonation) of fallout, plus the time in hours required for the nuclear cloud to pass over.

Example: For a particular location, the following data has been determined:

$$\text{TARR} = \text{H} + 2 \text{ hr}$$

Cloud Diameter = 9 km (this number comes from Figure 4-2, line i, next page). Find the cloud radius for any given yield and multiply by 2.

Effective Wind Speed = 20 kmph

$$T \text{ completion} = 1.25 \times 2 \text{ hr} + \frac{18 \text{ km}}{20 \text{ kmph}}$$

$$T \text{ completion} = 2.5 + .9 = \text{H} + 3.4 \text{ hrs} \\ = 3 \text{ hr } 24 \text{ min after the burst.}$$

The actual time of completion maybe determined by taking a series of dose-rate readings at the same location over a period of time or by looking at an NBC 4 Peak Report. The peak reading indicates that fallout is complete.

Plot these dose rates against time on log paper. The dose rate will increase, reach a maximum, and then start to decrease with time. Plot a series of readings until the

reading falls on the same straight line. This will indicate a constant rate of decay. The time of completion can be determined from the graph by reading the dose rate on the

FALLOUT PREDICTION WORKSHEET-SURFACE BURST	
For use of this form, see FM 3-3-1; proponent of this form is TRADOC.	
a. Time of burst (date-time group)	<u>270400</u> DELTA DDtttt <del>(Local or ZULU)</del>
b. GZ Coordinates	<u>NA170630</u> FOXTROT yyzzzzzz <del>(actual or estimated)</del>
c. FY/TY Ratio (from target analyst for friendly weapons only)	<u>1</u>
d. HOB (from target analyst for friendly weapons only)	<u>0</u> meters
e. Yield	<u>200</u> KT <del>or MT</del>
f. Cloud-top Height (Fig. 4-3)	<u>16</u> 10 <sup>3</sup> meters <del>or feet</del>
g. Cloud-bottom Height (Fig. 4-3)	<u>10.4</u> 10 <sup>3</sup> meters <del>or feet</del>
h. 2/3 Stem Height (Fig. 4-3)	<u>6.8</u> 10 <sup>3</sup> meters <del>or feet</del>
i. Stabilized Cloud Radius (Fig. 4-3)	<u>9</u> ZULU rr (km)
j. Time of Fall from Cloud Bottom (Fig. 4-3)	<u>2.8</u> hours
Fallout Wind Vector Plot (Enter f, g, and h radial lines on wind vector plot and measure distance from GZ to cloud-bottom height)	
k. Radial Line Distance from GZ to Cloud-Bottom Height	<u>39.5</u> km
l. Effective Wind Speed = $\frac{k \text{ (GZ to CB dist)}}{j \text{ (Time of fall)}}$	$\frac{39.5 \text{ km}}{2.8 \text{ hr}} = \underline{14}$ ZULU sss (kmph)
m. Downwind Distance of Zone 1 (Enter Fig. 4-7 with i and e)	<u>54</u> km
n. Adjustment = FY/TY Factor <u>1</u> x HOB Factor <u>1</u>	<u>1</u>
(Enter Fig. 4-8 with e and c or use a 1) (Enter Fig. 4-9 or 4-10 with d and e or use a 1)	
o. Adjusted Downwind Distance of Zone 1 (m x n)	<u>54</u> ZULU xxx (km)
Fallout Wind Vector Plot (Check lateral limits for 40 degrees)	
p. Azimuth of Left Radial Line	<u>273</u> YANKEE dddd <del>(mils or degrees)</del>
q. Azimuth of Right Radial Line	<u>354</u> YANKEE cccc <del>(mils or degrees)</del>
r. NBC 3 Nuclear	
ALFA AAA	<u>0</u> <u>0</u> <u>1</u> (Strike Serial Number)
DELTA DDtttt	<u>2</u> <u>7</u> <u>0</u> <u>4</u> <u>0</u> <u>0</u> <del>(Local or ZULU)</del>
FOXTROT yyzzzzzz	<u>N</u> <u>A</u> <u>1</u> <u>7</u> <u>0</u> <u>6</u> <u>3</u> <u>0</u> (GZ coordinates— <del>actual or estimated</del> )
YANKEE ddddcccc	<u>0</u> <u>2</u> <u>7</u> <u>3</u> <u>0</u> <u>3</u> <u>5</u> <u>4</u> (Azimuths or radial lines— <del>mils or degrees</del> )
ZULU sssxxxxr	<u>0</u> <u>1</u> <u>4</u> <u>0</u> <u>5</u> <u>4</u> <u>0</u> <u>9</u> (effective wind speed) (downwind distance) (cloud radius)

Figure 4-2. Completed fallout prediction worksheet.

straight line showing constant decay. This procedure will be discussed later in this chapter.

## NBCC Procedures

The NBCC prepares the detailed fallout prediction and disseminates the information to subordinate units as an NBC 3 nuclear report. The NBCC prepares the detailed fallout prediction by determining how high (layer) the fallout particles rise and then uses the wind vector plot to

predict where the particles will land. The following steps are used to prepare the detailed fallout predictions:

**Step 1.** Prepare the fallout wind vector plot as described in Appendix D to this field manual. The fallout wind vector plot is prepared each time new upper air wind data

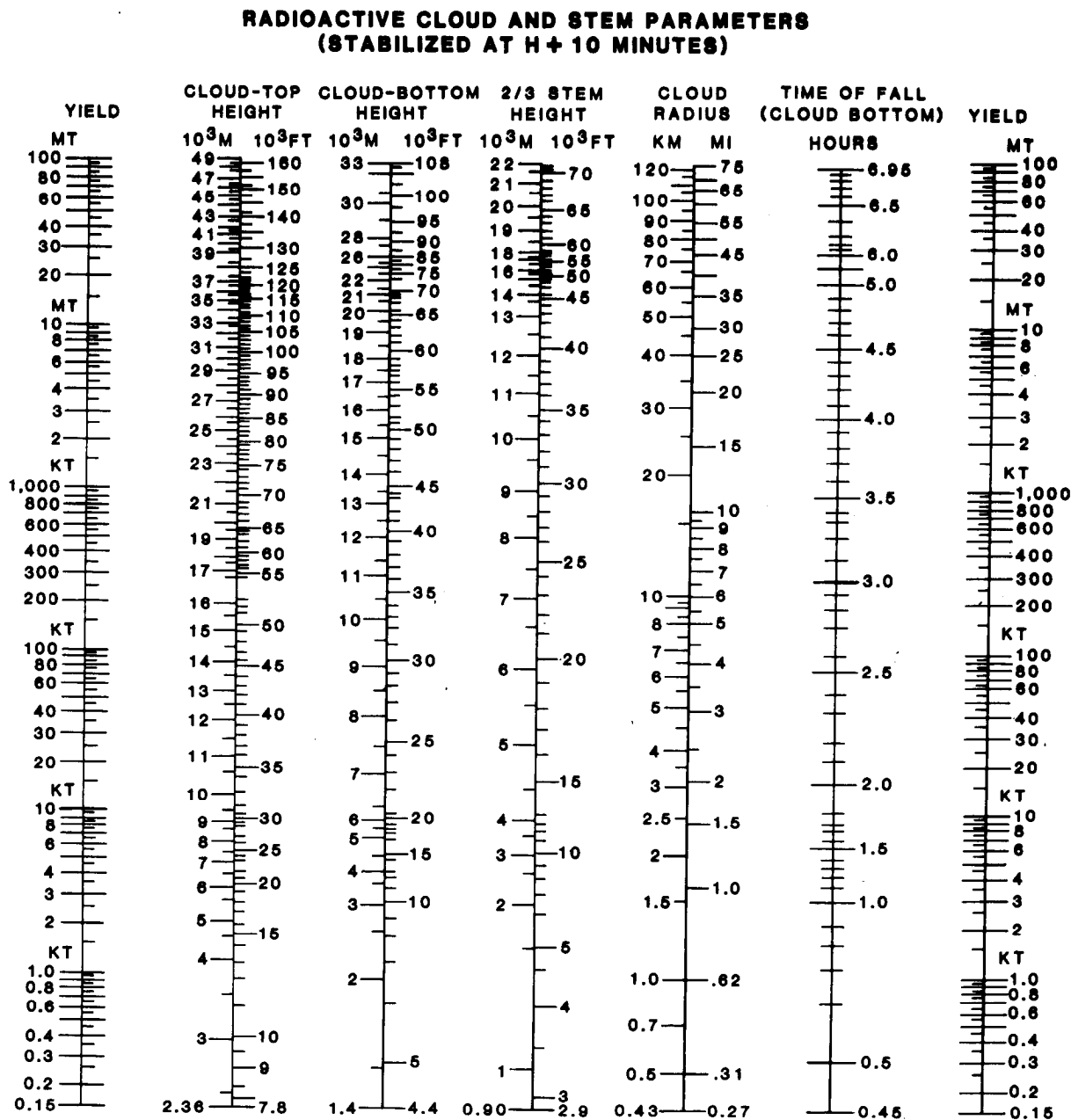

Figure 4-3. Radioactive cloud and stem parameters nomogram.

### FM 3-3-1

are received. Every prediction made from the current fallout wind vector plot should be prepared on a separate overlay so that the current fallout wind vector plot can be saved for further use. The fallout wind vector plot may be drawn to any convenient map scale.

**Step 2.** Determine nuclear burst information. Use DA Form 1971-4-R (Fallout Prediction Worksheet—Surface

Burst) for recording data. Nuclear burst information is recorded on lines a through e from the NBC 2 nuclear reports (see Figure 4-2).

**Step 3.** Determine cloud parameters. Once yield is determined (Step 2), use Figure 4-3 to determine cloud parameters. Place a straightedge so that the values on the left yield index scale and on the right yield index scale are

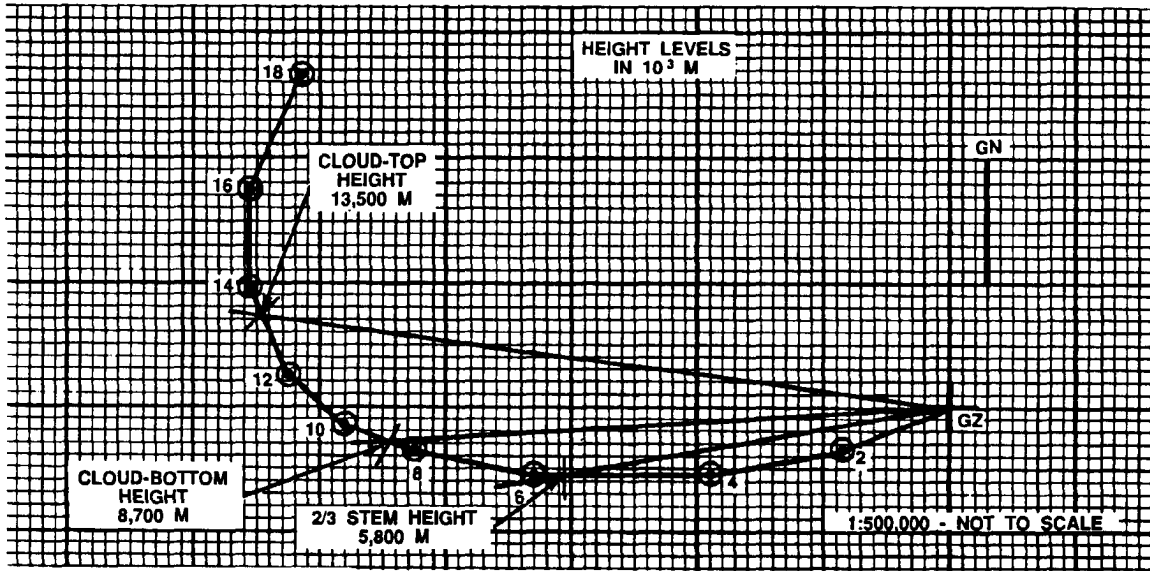

Figure 4-4. Initial determination of radial lines.

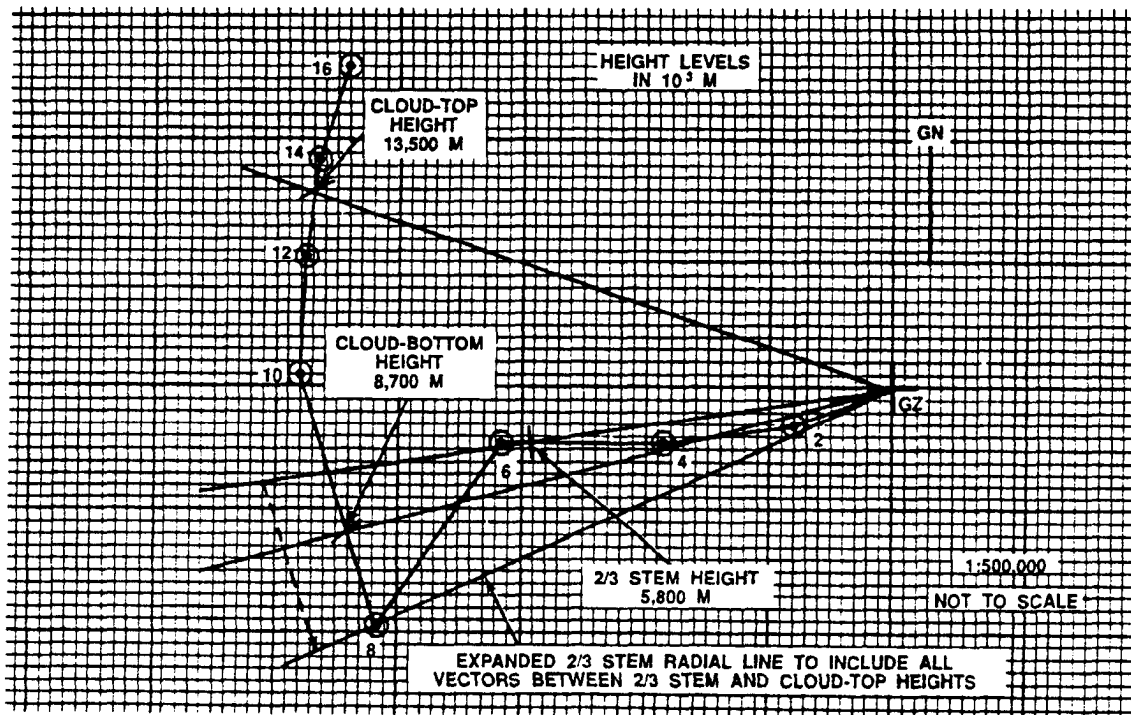

Figure 4-5. Expansion of radial lines.

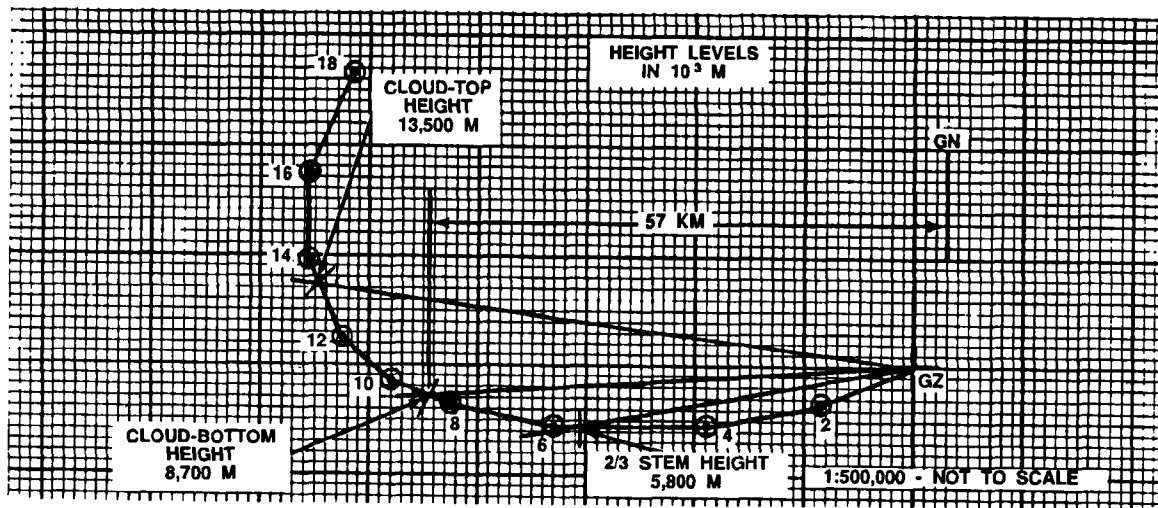

Figure 4-6. Determination of effective wind speed.

the same. Read all parameters under the straightedge. Record cloud parameter values on lines f through j of the worksheet.

**Step 4.** Determine lateral limits of the fallout prediction. Mark points representing the cloud-top height, cloud-bottom height, and two-thirds stem height on the fallout wind vector plot. Draw radial lines from the GZ point through these height points (Figure 4-4). (Interpolate linearly between the wind vector if necessary.) Disregard all wind vectors below the two-thirds stem height point and above the cloud-top height point when preparing the prediction. If wind vectors between the two-thirds stem height point and the cloud-top height point fall outside the radial lines drawn from GZ through these points, expand the angle formed by these two radial lines to include these outside wind vectors. An example of this is shown in Figure 4-5

**Step 5.** Determine the effective wind speed. Measure the length of the radial line, in kilometers, from GZ to the cloud-bottom height point (Figure 4-6). Record this value on line k of the work sheet. Read the time of fall from the cloud bottom (determined in step 3) from the work sheet (item j). Compute the effective wind speed as shown in the formula below, and record on line Lima of the work sheet:

$$\text{Effective wind speed} = \frac{\text{radial line distance from GZ to cloud-bottom height (km)}}{\text{time of fall from cloud bottom (hr)}}$$

**Note:** If the effective wind speed is less than 8 kmph, it is a special case. When the wind speed is less than 8 kmph, always use an 8 kmph wind speed in step 6.

**Step 6.** Determine the downwind distances of Zones I and II.

Using Figure 4-7, align a straightedge from the yield on the right-hand scale to the value of the effective wind speed on the left-hand scale. Where the straightedge intersects

with the center scale, read the downwind distance of Zone I. Record this value on line M of the work sheet.

Obtain the fission yield/total yield (FY/TY) ratio from the nuclear target analyst. FY/TY can also be found in FM 101-31-2 (S). The FY/TY ratio is expressed as a percentage. It states the percent of the weapon's explosive ability that is contributed by the fission process. The remainder of the weapon's yield is derived from fusion. This is significant in fallout prediction. The fusion portion of the weapon does not create residual contamination. Thus, a weapon with a FY/TY ratio of 0.6 means that 60 percent is fission and 40 percent is fusion. A crude comparison could be that this weapon will make 40 percent less fallout than a weapon with the same size yield which is 100 percent fission. If the FY/TY ratio is known, obtain the FY/TY adjustment factor from Figure 4-8, page 4-7, or by using the FY/TY table in Appendix E.

Lay a straightedge from the total yield on the left-hand scale to the value of the FY/TY ratio on the right-hand scale. Where the straightedge intersects with the center scale, read the FY/TY adjustment factor. If the FY/TY ratio is not known, assume the yield to be 100-percent fission and use an FY/TY adjustment factor of 1. Record the FY/TY adjustment factor on line N of the work sheet,

HOB is known (as in the case of a prestrike friendly burst), obtain the height-of-burst adjustment factor from Figure 4-9 or 4-10, pages 4-8 or 4-9. Figure 4-9 is for yields equal to or less than 100 KT. Figure 4-10 is for yields greater than 100 KT. Lay a straightedge from the yield on the left-hand scale to the value of the Height-of-Burst on the center scale. At the intersection of the straightedge with the right-hand scale, read the height-of-burst adjustment factor. If height-of-burst is not known, assume a zero height-of-burst and use a height-of-burst adjustment factor of 1. Record on line n of the work sheet.

**DOWNWIND DISTANCE  
ZONE OF IMMEDIATE CONCERN**

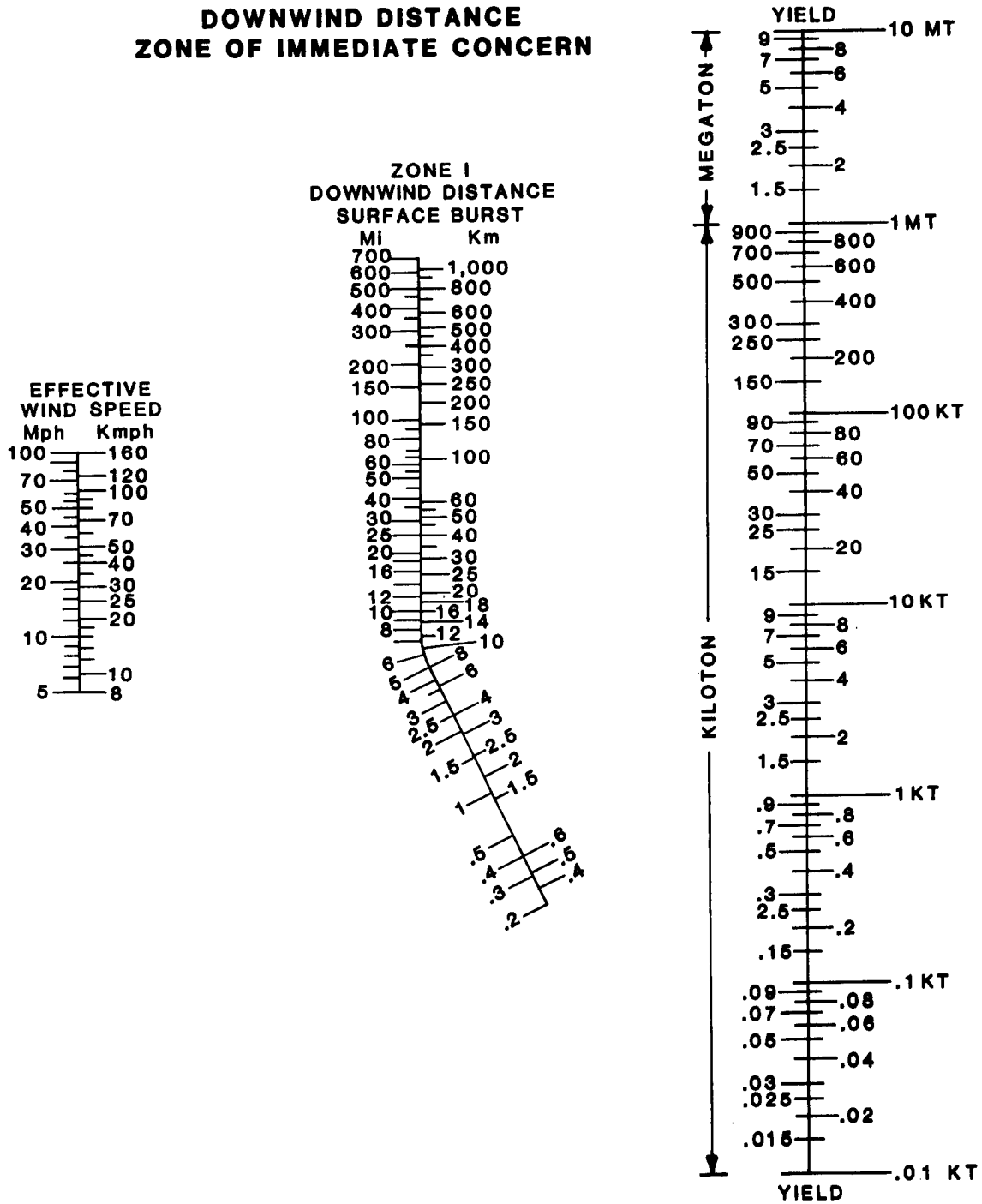

Figure 4-7. Nomogram for determining Zone I.



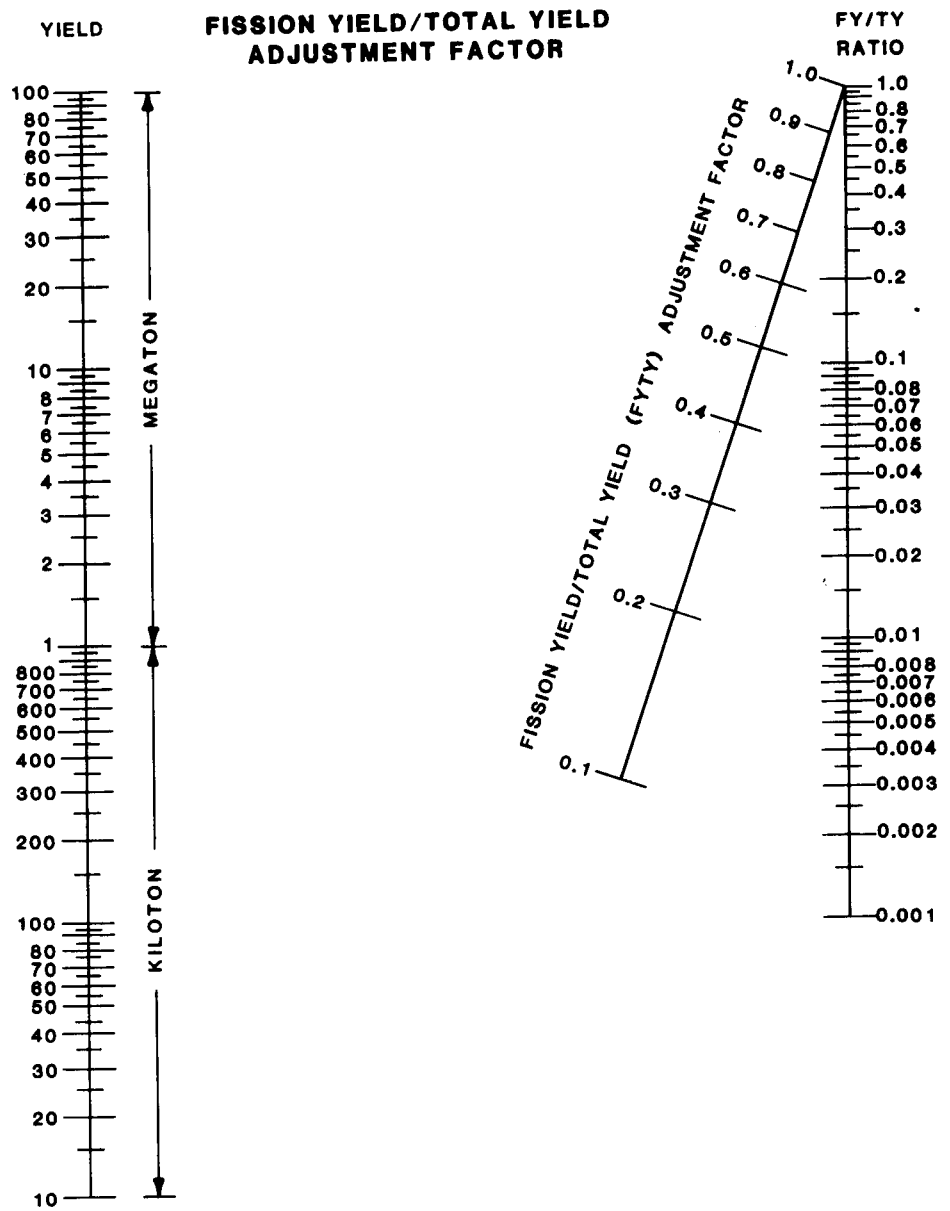

Figure 4-8. Nomogram for determining fission yield and/or total yield adjustment factor.

**HEIGHT-OF-BURST ADJUSTMENT FACTOR, KILOTON  
YIELD  $\leq$  100 KT**

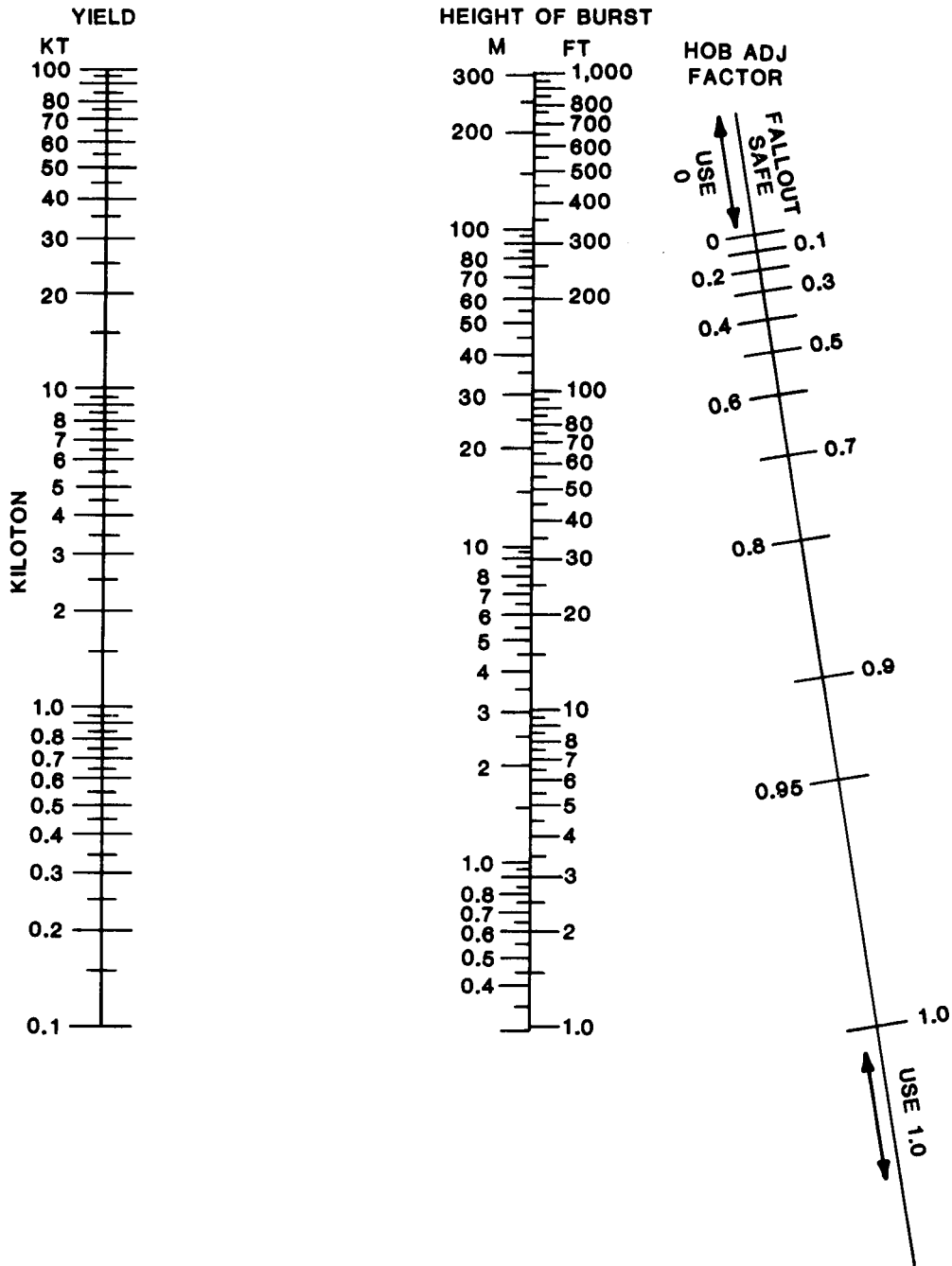

Figure 4-9. Nomogram for determining height-of-burst adjustment factor.

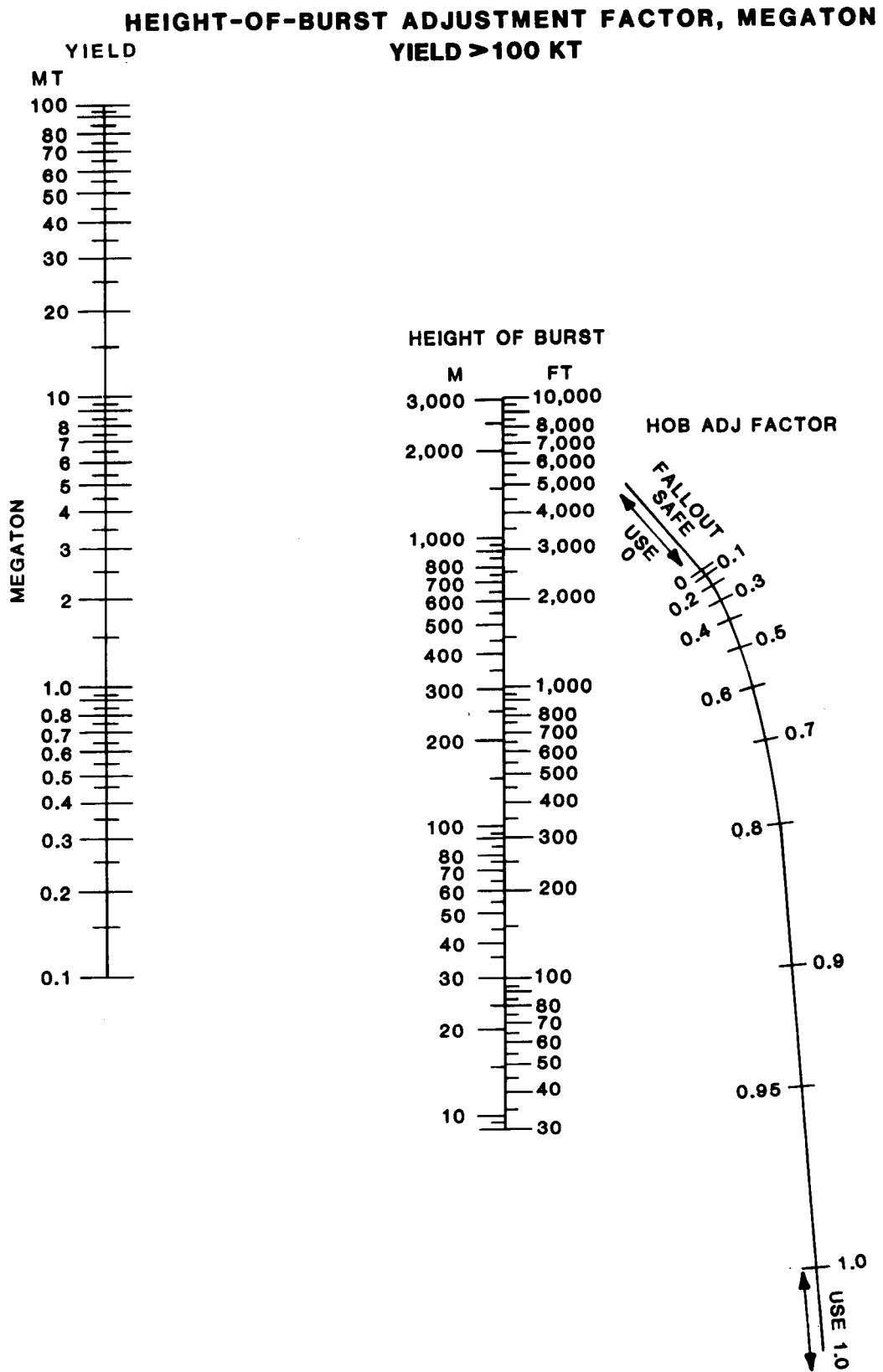

Figure 4-10. Nomogram for determining height-of-burst adjustment factor, megaton.

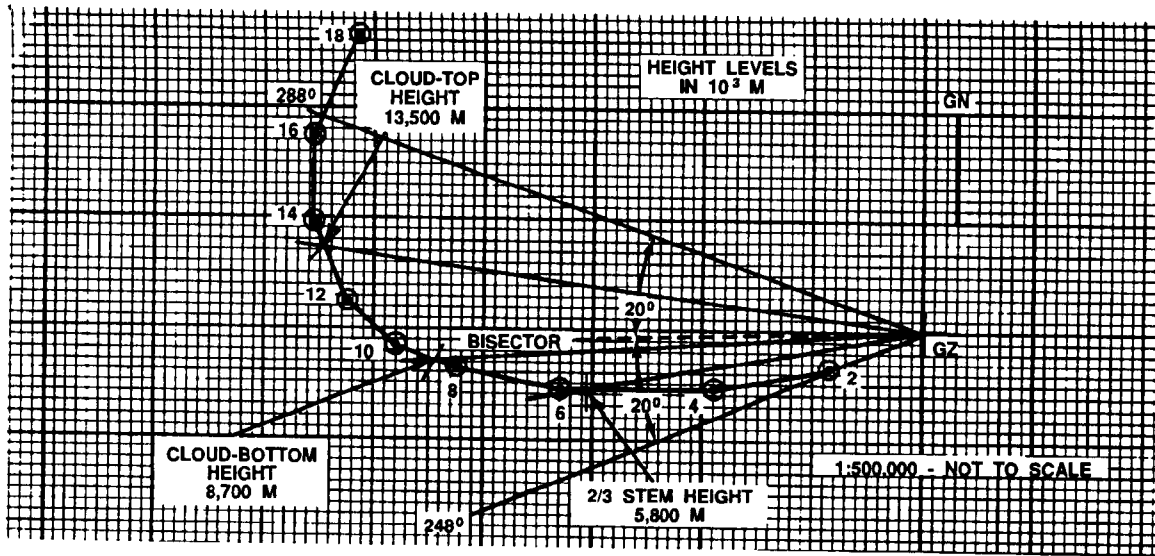

Figure 4-11. Constructing radial lines.

HOB adjustment factor may also be obtained by using the HOB adjustment table in Appendix E.

Multiply the Zone I downwind distance for a surface burst (determined in "a" above) by both the height-of-burst and the FY/TY adjustment factor to obtain the adjusted downwind distance of Zone I for the given conditions. Record this value on line o of the work sheet.

Double the Zone I distance recorded on line o to obtain the adjusted downwind distance of Zone II.

**Note:** If the effective wind speed is less than 8 kmph, the detailed prediction is now complete. Prepare the NBC 3 nuclear report (line r on the work sheet) as described in Step 9. If the wind speed is not less than 8 kmph, go to Step 7.

**Step 7.** Construct left and right radial lines.

Measure the angle formed by the radial lines drawn from GZ to the cloud-top height and two-thirds stem height points on the fallout wind vector plot (or the radial lines which have been expanded to include vectors between the two-thirds stem height and the cloud-top height). If the angle formed is 40 degrees or greater, measure the azimuths (in roils or degrees from GN) of the final left and right lines and record on lines p and q of the work sheet. If the angle formed is less than 40 degrees, bisect the angle and expand the angle formed by the two radial lines to 40 degrees (20 degrees on each side of the bisector) (Figure 4-11, above).

**Step 8.** Complete the fallout prediction.

Start with GZ on an overlay at the selected map scale, and extend the radial lines at their proper azimuths to any convenient distance. Mark GN on this overlay. (The fallout wind vector plot was originally drawn to a convenient map scale; for example, 1:500,000. If it is more convenient, a

different map scale can now be used to complete the fallout prediction.)

Between the two radial lines drawn from GZ, and using GZ as center, draw two arcs with radii equal to the Zone I and Zone II downwind distances found in step 6 (Figure 4-12, next page, Part 1).

Using GZ as center, draw a circle around GZ with a radius equal to the cloud radius at the selected map scale (Figure 4-12, Part 2).

Draw two tangents extending from the GZ circle to the points of intersection of the two radial lines with the Zone I arc (Figure 4-12, Part 3).

Using GZ as center, indicate the estimated times of arrival of fallout by drawing dashed arcs downwind at distances representing effective wind speed for each hour of interest (Figure 4-12, Part 4).

**Step 9.** Prepare the NBC 3 nuclear report. Complete line r of the work sheet. The report will always include the following line items:

**Alfa**—This line is the strike serial number. The strike serial number is assigned by the NBCC at the operations center responsible for the area in which the strike occurs.

**Delta** DDtttt—This line is the date-time group of the burst, with DD (the day) and tttt (H-hour) in local or Zulu time (GMT) (state which).

**Foxtrot** yyzzzzzz—This line is the actual or estimated (state which) coordinates of GZ. The two letters yy represent the appropriate 100, 000-meter grid square and the letters zzzzzz coordinates of GZ within this grid square. This line item will be encoded if sent over an unsecure communications net. This is to deny tactical information on the effectiveness and accuracy of enemy weapons.

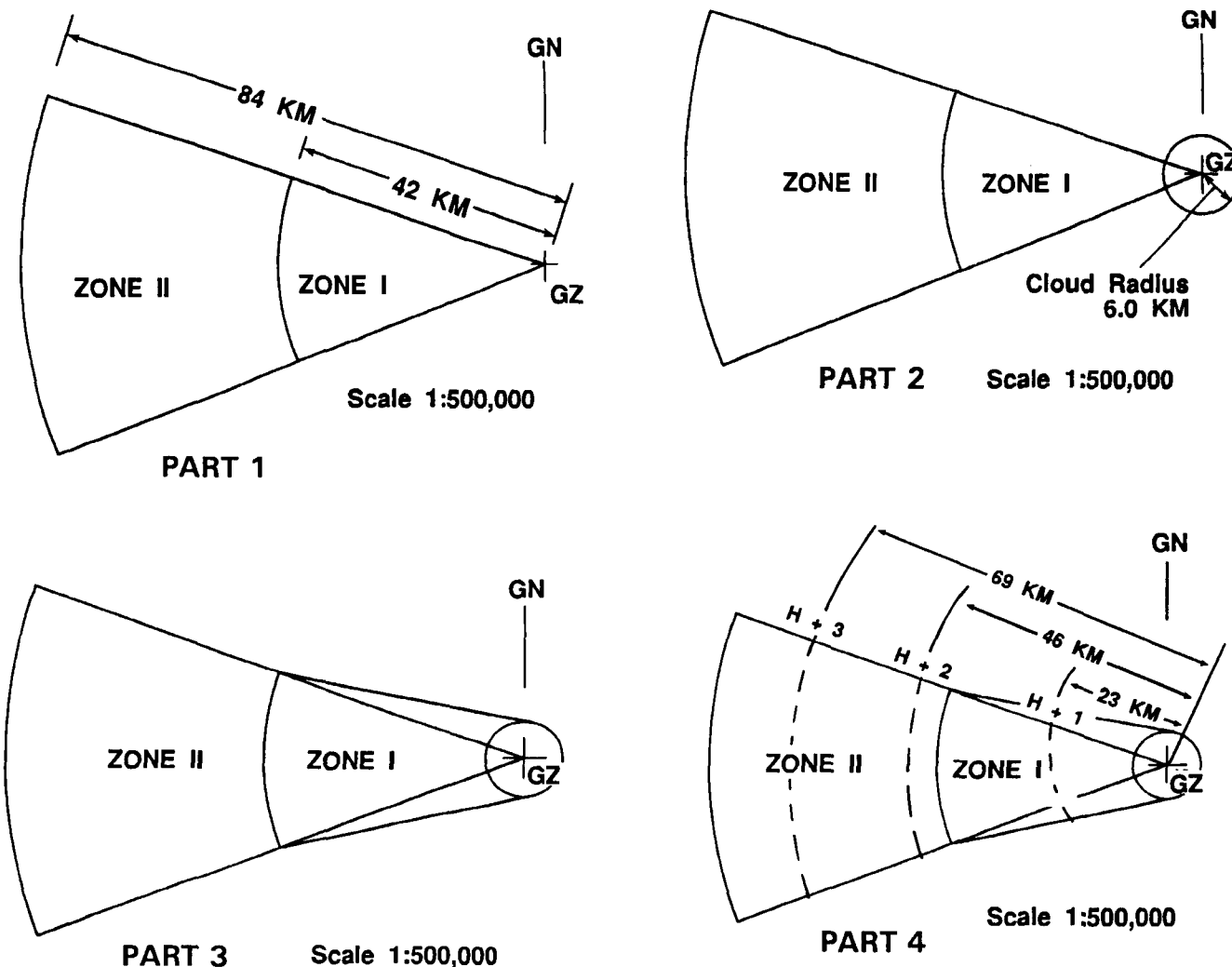

Figure 4-12. Four parts of completing a fallout prediction.

**Yankee ddddcccc**—This line is the azimuths of the two radial lines to the nearest mil or degree from GN. The letters dddd represent the azimuth of the left radial line and the letters cccc represent the azimuth of the right radial line. Left and right in this case are the angles as they would appear to an observer located at GZ looking downwind. The unit of measurement (mils or degrees) of the azimuths must be indicated. Omit this line when the special case of low winds (less than 8 kmph) exists.

**Zulu sssxxrr**—This line is the prediction dimensions. The letters sss represent the effective wind speed (to the nearest kilometer per hour), xxx represent the downwind distance of Zone I (to the nearest kilometer), and rr represent the radius of the stabilized cloud (GZ circle) to the next higher kilometer if the value is not a whole number. (This line contains only three digits when the special case of low winds applies.) Figure 4-13, next page, shows sample NBC reports.

## Unit Procedures

Upon receipt of an NBC 3 nuclear report, the unit inspects the report. Several items are looked at. First, has the report been received or previously plotted? Second, is the GZ location within the unit's area of interest or zone of

operations? If the report is new and/or may impact on unit operations, it must be plotted. Two different plotting procedures exist. Each procedure is discussed in the following paragraphs. See figures 4-14 and 4-15, next page.

**Example 1—(Winds less than 8 kmph)**

Standard Format	USMTF Program
NBC 3 Nuclear	MSGID/NBC3/NUC//
A N016	ALFA/N016//
D 221100Z	DELTA/221100Z//
F BV754082	FOXTROT/E/32UBV754082//
Estimated	
Z 017	ZULU/17//

Note that line item Yankee is omitted for wind speeds of less than 8 kmph.

**Example 2**

Standard Format	USMTF Program
NBC 3 Nuclear	MSGID/NBC3/NUC//
A N004	ALFA/N004//
D 211100Z	DELTA/211100Z//
F MN556705	FOXTROT/E/32UMN556705//
Estimated	
Y 01500050	YANKEE/015DEG/0050DEG//
Z 01501002	ZULU/015/010/02//

**Figure 4-13. Sample NBC 3 nuclear reports.**

If the NBC 3 nuclear report contains line item Yankee, follow these steps:

**Step 1.** Identify map scale to be used. Obtain a sheet of overlay paper or other transparent material. Mark a GZ location and GN.

**Step 2.** Examine line item Yankee. Starting at the GZ location, draw the left radial line and then the right radial line measured from GN.

**Step 3.** From line item Zulu, determine the downwind distance of Zone I. Starting from GZ, draw an arc between the radial lines with a radius equal to the distance of Zone I. Label this area Zone I. Draw a second arc between the radial lines at twice the radius as the downwind distance of Zone II. Label this area Zone II.

**Step 4.** From line item Zulu, determine the size of the cloud radius. Using GZ as the center, draw a circle with a radius equal to the stabilized cloud radius.

**Step 5.** Draw tangent lines from the outer edge of the cloud radius to the points of intersection of the radial lines with the Zone I arc.

**Step 6.** From line item Zulu, determine the effective wind speed. Beginning at GZ, draw as many dashed time-of-arrival arcs between the radial and tangent lines as will fit inside the prediction. Label the dashed arcs as hours after the burst: H + 1, H + 2, and so on. H + 1 is the closest arc to GZ. If a time-of-arrival arc coincides with a Zone I or Zone II arc, extend the zone boundary with a dashed line.

**Step 7.** Add marginal information to the plot. This should be all known information about the attack.

**Step 8.** Orient the prediction to the map and evaluate the hazard.

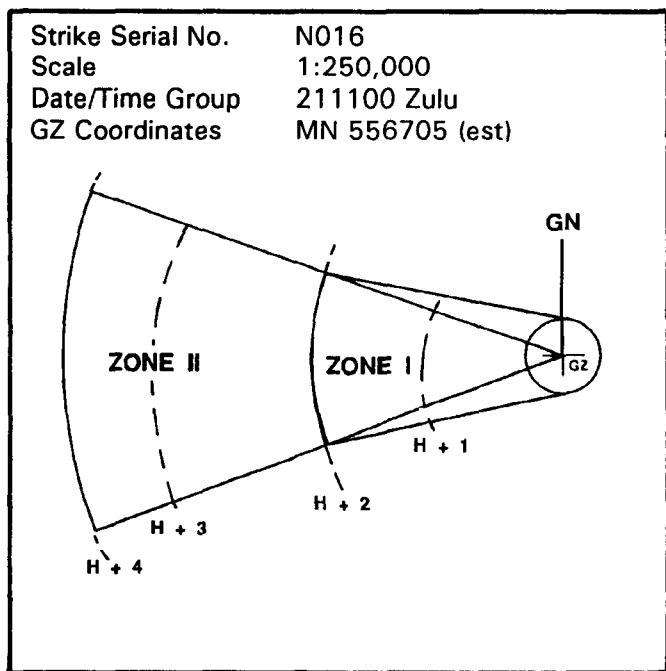

**Figure 4-14. Fallout prediction from NBC 3 nuclear report.**

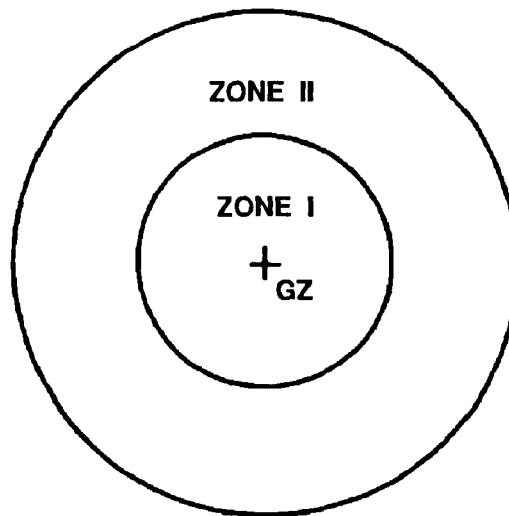

A. N016  
 D. 221100Z  
 F. BV 754082 (est) 1:50,000

**Figure 4-15. Fallout prediction from NBC 3 nuclear report (special case).**

If the NBC 3 nuclear report does not contain line item Yankee, follow these steps:

**Step 1.** Identify map scale to be used. Obtain a sheet of overlay paper or other transparent material. Mark a GZ. A GN line is not necessary.

**Step 2.** The three digits shown are the radius of a circle for Zone I. Using the GZ as the center, draw a circle with

a radius equal to Zone I distance. Label this area Zone I. Draw a second circle at twice this radius for Zone II. Label this arc Zone II.

**Step 3.** Add marginal information to the plot. This should be all known information about the attack.

**Step 4.** Orient the prediction to the map and evaluate the hazard.

## Fallout Plotting from NAV NBC 3 Nuclear Report

In the case of a fallout producing nuclear detonation, the NBC collection/sub-collection center will prepare a fallout prediction, using the detailed procedure, as described previously.

The prediction will be passed to naval forces/ships in the format of a NAV NBC 3 nuclear report. An example follows:

NAV NBC 3 Nuclear

- A. 24 (Strike serial number)
- D. 2014052 (Date-time of burst)
- F. 56°00'N-11°15'E (Location of burst)
- N. 10KT (Weapon yield)
- Y. 01470187 DEGREES (Direction measured clockwise from GN to left and right radial lines)
- z. 01000802 (Effective downwind speed (knots) 3 digits, downwind distance of Zone I (nautical miles) 3 digits, and cloud radius (nautical miles) 2 digits).

The NBC information contained in the NAV NBC 3 nuclear report can easily and rapidly be transferred to the ships fallout template (see Figure 3-35, in Chapter 3).

From letter "Y" it is seen that the angle between the GN line and the left radial line is 147 degrees, and the angle between the GN line and the right radial line is 187 degrees.

The effective downwind direction will then be the bisector of the angle formed by the two radial lines:

$$\frac{147 \text{ degrees} + 187 \text{ degrees}}{2} = 167 \text{ degrees}$$

From GZ, draw the GN line through 167 degrees on the compass rose, and label GN.

From letter "Z," find the downwind distance of Zone I to be 8 nautical miles. Then the downwind distance of Zone II will be  $8 \times 2 = 16$  nautical miles. Using the appropriate map scale, with GZ as center and the two distances as radii, draw two arcs between the radial lines.

From letter "Z," the last two digits are the cloud radius, in this example 02 nautical miles. Using GZ as center and 2 nautical miles radius, draw the cloud radius semi-circle upwind of GZ to scale.

From the intersections of the Zone I arc with the radial lines, draw lines to connect with the ends of the semicircle.

From Figure 3-36, in Chapter 3, find the safety distance for the yield, in this example for a 10 KT weapon. Safety distance for 10 KT yield is 2.5 nautical miles.

Determine the area where deposition of fallout is estimated to take place at a specific time after the detonation. The effective downwind speed is given in letter "Z," the first three digits. In the example, the wind speed is 10 knots. Multiply the effective downwind speed by the time (hours after detonation, that is, 1.25 hours after detonation, or  $H + 1.25$  hours):

$$10 \text{ knots} \times 1.25 \text{ hours} = 12.5 \text{ nautical miles.}$$

Add and subtract the safety distance (from e above) to and from 12.5 nautical miles.

$$12.5 + 2.5 = 15 \text{ nautical miles, and}$$

$$12.5 - 2.5 = 10 \text{ nautical miles.}$$

Using these two distances as radii and GZ as center draw two arcs across the fallout pattern. The area confined by the two arcs and the cross wind boundaries of the fallout area defines the approximate area of deposition at  $H + 1.25$  hours.

Complete the fallout plot by indicating the following on the fallout template:

- (1) NAV NBC 3 nuclear report used
- (2) Yield and date-time of burst
- (3) GZ
- (4) Geographic chart number (scaling).

**Note:** When the effective downwind speed is less than 5 knots, the predicted fallout area will be circular. Then, the NAV NBC 3 nuclear report contains no letter "Y," and letter "Z" contains only three digits, indicating the Zone I downwind distance in nautical miles. The fallout prediction plot is prepared by drawing two concentric circles with GZ as center and Zone I and Zone II downwind distances as radii—the Zone II radius being twice the Zone I radius.

There may occur cases in which meteorological information normally used for fallout prediction is not available, for example the basic wind data message and the NAV EDM.

It may, however, be possible for ships to obtain the necessary wind data for fallout prediction from other sources and to compute the effective downwind direction and speed by using standard pressure level winds.

This method of computation is described in Appendix D to this field manual.

## Actual Fallout Direction

The actual direction fallout takes can be determined in several ways. First, data submitted by radar operators on line item Papa Bravo of the NBC 1 nuclear report reflects the direction fallout is actually traveling. This can indicate fallout prediction reliability. Direction may be determined even before the fallout prediction is created. When actual direction varies with predicted direction, the prediction is revised in favor of the actual direction.

A second method of determining actual fallout direction is to plot NBC 4 nuclear reports, since these reports should originate from within the predicted area. If the reports come from areas not predicted to receive fallout, the prediction may require revision. Note that the prediction's shape is not an absolute boundary. Fallout will occur outside the area. However, militarily significant fallout as defined by Zone I and Zone II should be inside the predicted area.

When a unit is in an area predicted to receive fallout, it must take action to reduce the potential threat. These actions must be listed in the unit SOP. Some examples of these actions are—

- Alert all personnel.
- Construct shelters with overhead cover or improve existing shelters.
- Calculate when fallout will arrive (H + . hours after burst). Plan on having only half of this time to be sure.
- Upload and prepare to move out of the contaminated area.
- Request permission to move depends on a combination of several factors (previous radiation absorbed dose; location within the prediction, especially Zone I; importance of mission in the area; physical capability; and optimum time to exit).
- Move only when told to (depending on prearranged plans).
- Fasten clothing, roll down sleeves, and put on and wear helmet and gloves.
- Calculate Optimum Time of Exit (Topt) and advise higher headquarters (discussed in detail in Chapter 6).
- Feed all personnel if time permits.
- Fill canteens; cover food and water in airtight containers.
- Cover as much equipment as possible with NBC Protective Cover (NBC-PC) to reduce the decon burden.
- Use expendable field expedient covers such as plastic, foliage, mud (washed off later to remove fallout), and tarpaulins.
- Improve shielding ability of evacuation vehicles by adding clean earth before fallout arrives.

- Strike and store all tentage if unit intends on moving. If not, cover tentage with NBC-PC.
- Implement continuous radiological monitoring.
- Shutoff all ventilation systems not provided with dust filtration capability.
- Protect items that will be difficult or impossible to decontaminate later (such as rope).
- Do not allow personnel to leave shelters while fallout is arriving.
- Request air evacuation.

Once the unit receives an NBC 3 nuclear report, the report must be plotted on the operations map. This is best accomplished by an overlay on clear plastic or other transparent material.

The preceding paragraphs outlined actions that should be part of a unit SOP. Once the chemical staff places the NBC 3 nuclear report on the situation map, he or she must be prepared to answer these two basic questions from the commander:

1. Where did it go off?
2. Are we or any of our troops in danger?

The first question is easy, but one should be prepared to discuss the exact location and whether or not there is a crater. If any friendly units were in the immediate area of ground zero, obtain a battle damage assessment or post-strike analysis. Either one may be obtained from either the unit itself, if it is an organic element, the affected units higher headquarters, or through intelligence channels.

The other question is more difficult to answer. The commander must understand that the NBC 3 nuclear report is only a prediction of potential fallout. The plot is safesided to incorporate all areas that may be affected. The plot, by no means, indicates that fallout will cover everything within the radial lines. Calculate, for the commander, the time of arrival fallout as discussed earlier. This will provide necessary information to the commander and the unit as a whole as to when the fallout may arrive.

Armed with this information the affected unit may adjust plans accordingly and know how long they have to prepare before the arrival of fallout.

If a unit lies within the predicted fallout area, the commander will be interested in how soon that unit can depart the area, if required. This is calculated as the optimum time of exit .



## Chapter 5

# Monitoring, Survey, and Reconnaissance

## Planning, Conducting, Recording, and Reporting

As explained in Chapter 3, nuclear fallout may contaminate a large portion of the battlefield. In order to operate and survive on the nuclear battlefield, this contamination must be located, reported, and avoided if possible.

Terrain affects wind direction which in turn determines where fallout will be deposited. Fallout will deposit differently in a valley as with a reversed slope of a hill. The only sure way of determining where fallout has actually contaminated the surface is by conducting a radiological survey or by receiving NBC 4 nuclear reports from individual monitors. These reports are essential to report the actual contamination that is present.

Fallout predictions provide a means of locating probable radiation hazards (see Chapter 4). Militarily significant

fallout will occur within the predicted area. However, the prediction does not indicate exactly where the fallout will occur or what the dose rate will be at a specific location. Radiological contamination can also be created by rainout or washout. Areas of neutron-induced radiation also can be caused by low airbursts. Operations in a neutron-induced gamma activity (NIRA) area are explained in detail in Chapter 7. Before planning operations in a nuclear environment, commanders must be aware of residual contamination hazards and measure the dose rate. This is done by one of three methods—monitoring, survey, or recon and the results are transmitted to units in the form of an NBC 5 nuclear report.

## Monitoring

Radiological monitoring is done routinely to determine the presence and intensity of the residual radiation hazard. Monitoring is performed while in a stationary position. The radiation may be from fallout or neutron-induced areas. The IM174-series Radiacmeter or the AN/VDR-2 are the basic instruments used to monitor for radiation.

**Area Monitoring.** Since nuclear weapons may be employed at any time on the battlefield, all units monitor for radiation upon initial deployment. Monitoring is included in normal intelligence activities. It provides early warning and useful radiological information to units at all levels. There are two types of area monitoring—periodic and continuous. Both types of monitoring can be performed using the direct or indirect technique, discussed later in this chapter.

**Periodic Monitoring.** Periodic monitoring consists of frequent checks of the unit area for radiation. Periodic monitoring assures the commander that the unit area is not contaminated. It warns the unit if contamination arrives.

Periodic monitoring is initiated after the first use of nuclear weapons in theater, when a unit is out of contact with higher headquarters, when ordered by higher headquarters, or when the unit stops continuous monitoring.

During periodic monitoring, take a reading with the IM174 or an AN/VDR-2 radiacmeter at least once each hour. Unit SOPs may require more frequent readings and should provide detailed information on monitoring procedures. When a unit has more than one Radiacmeter, only one is required for periodic monitoring.

**Continuous Monitoring.** Continuous monitoring is the surveillance for radiation in the unit area or position. It is usually performed by units using the indirect technique. Frequency of readings will depend on the current situation and unit SOP. Units will initiate continuous monitoring—

- When a nuclear detonation is observed, heard, or reported in their area of operations.
- When an NBC 3 nuclear report is received and the unit is in the predicted area of contamination.

## FM 3-3-1

- When a dose rate of 1 cGyph is recorded during periodic monitoring.
- When ordered by the unit commander.  
Units return to periodic monitoring when the dose rate (unshielded) falls below 1 cGyph or when ordered to do so.

### Direct Monitoring

Direct monitoring is the simplest and most precise of the monitoring techniques. A radiacmeter is used to get an unshielded dose rate. Determine the unshielded (outside) dose rate by standing with the IM174 or AN/VDR2 held waist high, or 1 meter off the ground, and rotating your body 360 degrees. The highest reading observed is recorded as the dose rate. Take this reading in the open at least 10 meters away from buildings or other large structures or objects that may shield out a portion of the radiation. In cities or built-up areas, take readings in the center of the streets or at street intersections. If there are points of operational interest where you cannot get 10 meters away from interference, take additional readings. Thus, if a road through a narrow cut or defile is of operational interest, take readings both in the open near the cut and in the cut.

Direct monitoring is used—

- While monitoring for the initial detection or arrival of fallout.
- When in low dose rate areas.
- When determining unshielded (outside) ground dose rates for transmission or correlation factors.
- When verifying the contamination status of a new position.
- While moving through a contaminated area on foot.

Direct readings are used when conditions and operational exposure guidance permit.

### Indirect Monitoring

Indirect monitoring is done inside shelters or vehicles. This allows the unit to measure radiation levels and still keep exposure to a minimum. Indirect monitoring is the preferred technique when operating in a contaminated area. It is used whenever dose rates are high enough to be read inside the shielded location.

When the indirect technique is used, most of the readings are taken inside the vehicle or shelter. However, at least one outside reading is necessary to determine the correlation factor. Both the inside and outside readings must be taken within three minutes of each other. Both must also be taken after fallout is complete. Take both readings before determining the correlation factor. For those vehicles in which the AN/VDR2 has been installed, the user need only verify that the correct attenuation factor has been entered (IAW TM 11-6665-251-10) and then read the outside dose directly off the display.

Calculate the correlation factor using the following formula:

$$\text{Correlation factor (CF)} = \frac{\text{Outside dose rate (OD)}}{\text{Inside dose rate (ID)}}$$

**Note:** CFs are always greater than 1.0. CFs are rounded to the nearest hundredth.

Preprinted correlation factors are calculated for vehicles based on the “best” location for the radiac instrument. CFs may be reported in the NBC 4 nuclear report by line Zulu Bravo (ZB). CFs are the same as the attenuation factor when operating the AN/VDR-2.

### Survey Meter Location in Vehicles

Dose-rate readings are taken during a ground survey by mounted personnel using the route technique. These readings are taken inside the vehicle and later converted to outside dose rates, using a correlation factor. For operational situations, the correlation factor data should be obtained by the survey party for use by the unit NBC defense team in calculating ground dose rates. The survey meter should be located as indicated in Figure 5-1, next page.

If the vehicle being used is not one of those in which the location of the survey meter is designated in Figure 5-1, the survey meter should be held in a vertical position (face up) by the monitor, who is positioned in the assistant driver's seat. The monitor should take the readings with the survey meter consistently located in the selected position.

When the correlation factor data cannot be obtained by the survey party, published correlation factors may be used from Figure 5-1.

For a vehicle in which the AN/VDR2 has already been installed, using the appropriate installation kit, the user need only verify that the proper attenuation factor has been entered (IAW TM 11-6665-2571-10). It is not necessary to relocate the AN/VDR2.

### Correlation Factor Data

Correlation factor data are required in order to convert the reported readings taken inside the vehicle to ground dose rates existing outside the vehicle.

Data for the vehicle correlation factor are provided by the survey party and consist of a set of two readings taken at the same location. One reading is taken inside the vehicle with the instrument located as indicated in Figure 5-1. All subsequent inside readings reported for the survey must be taken with the meter in this same position. The other reading is taken immediately as a normal ground monitoring reading at the same location with the vehicle at least 10 meters away. One or two additional sets of data should be taken at different locations so that the NBC Defense Team can use an average vehicle correlation factor.

The sites for obtaining vehicle correlation factor data should be selected to approximate average foliage and

ground surface conditions for the contaminated area. New data must be obtained if these conditions change significantly or if the survey meter or vehicle is changed. Additional correlation factor data taken because of the aforementioned changes should not be averaged into previously collected data, but should be used for applicable routes or points. Accuracy of the correlation factor data is of paramount importance.

When taking readings inside a shelter, the monitor stands at the center of the shelter, holds the radiacmeter waist high, rotates 360 degrees, and notes the highest readings. All subsequent readings are taken the same way at the

same point. When readings are taken from vehicles, all readings are taken from one selected position.

The readings taken inside the vehicle or shelter represent inside shielded dose rates. These readings must be converted to outside unshielded dose rates by unit NBC defense team personnel before forwarding to higher.

Readings are converted using the following formula:

$$OD = ID \times CF$$

*OD = Outside dose*

*ID = Inside dose*

*CF = Correlation factor used.*

Here is an example of this procedure. A company monitor is located in an shelter which has an open front, dug into the side of a hill. A nuclear burst occurs several kilometers away. The monitor begins continuous monitoring on the outside of the shelter from a location that is at least 10 meters away from any object that might shield the reading. Upon noting a reading of 1 cGyph on the instrument, the monitor returns to the shelter and notifies the unit NBC defense team of the arrival of fallout. The monitor continues to observe the instrument, recording readings and providing other data per unit SOP. There is a steady rise in the dose rate. When the monitor is certain that the dose rate has peaked and is decreasing (fallout is complete), a reading of 20 cGyph is taken inside the shelter. This reading was taken from the center of the shelter, 1 meter above the floor. Within three minutes the monitor goes to the preselected location outside the shelter. A ground dose-rate reading shows 250 cGyph. Before entering the shelter, the monitor brushes off any fallout. The monitor reports to the unit NBC defense team. The report includes the inside reading, the outside reading, the highest (peak) reading noted in the shelter, and any other data required per unit SOP. The unit NBC defense team calculates the CF and submits all required reports to higher headquarters.

Environmental Shielding	Location of Survey Meter	Correlation Factor
<b>Vehicles</b>		
M60 tank	Turret, rear top	25.0
	Turret, front	53.0
	Chassis, near driver	23.0
M113 APC	Directly in front of driver on front wall	3.6
	Near first squad member on left facing forward	3.6
M1 Tank		20.0
M2 IFV		9.1
M3 CFV		9.1
M109 SP Howitzer	Near driver, left side	9.1
	Rear, right side	3.5
M88 Recovery Vehicle	Commander position	3.4
M577 Command Post Carrier	Near driver, right side	6.9
	Rear, left side	3.2
M551 Armored Recon Airborne Assault Vehicle	Near driver, right side	2.5
		4.6
<b>Trucks</b>		
1/4-ton		1.3
3/4-ton (M998) (HUMMWV)		1.7
2-1/2-ton		1.7
4-ton to 10-ton (also M1008) (HEMMT)		2.0
<b>Structures</b>		
Multistory building		
Top floor		100.0
Lower floor		10.0
Frame house		
First floor		2.0
Basement		10.0
<b>Underground Shelter (3-foot earth cover)</b>		5,000.0
<b>Individual Fighting Positions</b>		10.0

**Figure 5-1. Locations of survey meters and corresponding correlation factors for residual radiation.**

The precalculated list of CFs is shown in Figure 5-1 is not used by the unit NBC defense team when

calculating or reporting outside dose rates. Its principal use is to establish the relative shielding ability of one shelter, structure, or vehicle as compared to another. It is also used for instructional and practice purposes.

## Recording and Reporting Monitoring Data

The NBCC receives monitoring reports from subordinate units. These reports provide data essential to the construction and updating of the contamination overlay. This overlay is used by the entire command.

At unit level the primary purpose of monitoring is to warn all personnel of the arrival or presence of contamination. This allows the commander to take prompt action to minimize the hazard.

### Recording Monitoring Data

DA Form 1971-R (Radiological Data Sheet-Monitoring or Point Technique) is used to record monitoring data at unit level. Block headings are self-explanatory. Any heading not applicable to the situation should be lined out. Space is provided for the monitor to enter data for the CF. The monitor does not calculate the CF; this is done by the unit NBC defense team. The monitor uses the remarks block to provide any additional information of value to the NBC defense team. This block is also used by the NBC defense team to enter the time of burst and to calculate the CF.

A completed DA Form 1971-R showing monitoring data and unit NBC defense team calculation of CF is shown in Figure 5-2.

The DA Form 1971-R is also used as a copy sheet for monitoring data passed from one headquarters to another. Only outside dose rates are forwarded. The form can also be sent or carried directly to the NBCC. Use the remarks block to show normalizing factor calculations.

### Reporting Monitoring Data

The format for monitoring reports follows that found in NATO STANAG 2103/ATP45. Only that part of NBC 4 report which pertains to monitoring reports is discussed here.

**Note:** Correlation factors are based on the inverse of the transmission factor for the given vehicle at the prescribed location for the radiac instrument.

Monitoring reports contain the location of the reading, the dose rate, and the date-time the reading was taken. The location is sent as UTM grid coordinates; the dose-rate reading is expressed in cGyph. Only outside (unshielded) dose rates are reported by the unit NBC defense team, and the date-time is reported in Zulu time. Certain words are

associated with the dose rate that describes the circumstances surrounding the contamination. Note that the definition of line item Romeo has been expanded. Key words used in preparing the NBC 4 nuclear report are listed below. The following words are associated with line item Romeo:

Automatic Reports	Directed Reports	Any Report
initial	series	increasing
peak	summary	decreasing
special	verification	fallout
contact (used for recon only)		induced
		overlapping

**Note:** More than one word may be used on a single report.

### Radiological Data Sheet Notes

(See Figure 5-2)

A nuclear weapon has detonated. Continuous monitoring is initiated. Monitor awaits arrival of fallout in open areas.

Fallout arrives. Monitor reads 1 cGyph, notes it, and reports it to the unit NBC defense team.

Monitor enters the shelter. No dose rate is noted inside because of the shielding. Dose rate must build to equal the CF before a dose rate of 1 cGyph is apparent.

Dose rate on the outside now equals CF (of course, the monitor does not know the CF at this time). Monitor reads 1 cGyph on the inside. The dose rate continues to build. In this example the OD must reach 40 before ID will reach 2.

The dose rate builds. The OD now equals 40 (this can be seen once CF is applied to all previous readings).

The dose rate continues to build and starts slowing the rate of increase.

The dose rate is almost the same as the previous reading. This indicates peak or near peak. The dose rate is measured every 5 minutes now. The dose rate levels off. It appears that no more fallout will arrive. Decay now takes over. The peak reading is reported to the unit NBC defense team.

The decrease is noted. At this point, a collection of CF data is possible. The monitor notes the continuing decrease in dose rates. An OD of 180 is taken. The monitor reports a peak of 10 (shielded) at 1005 hours and the data for the CF (OD = 180 and ID = 9). The NBC defense team calculates a CF of 20 and applies this data to the peak reading.

The monitor continues to take readings at 30-minute intervals until dose rate decreases below 1 cGyph or told to stop.

The following instructions do not limit the scope or body of monitoring data. They attempt to show a large and

flexible system. The important consideration is that both the NBCC and the unit understand each other's needs.

The format for NBC 4 nuclear reports is as follows:

RADIOLOGICAL DATA SHEET— MONITORING OR POINT TECHNIQUE					DATE	PAGE NO.	NO. OF PAGES		
For use of this form, see FM 3-3; proponent of this form is TRADOC.					10 January	1	1		
SURVEY PARTY OR MONITORING UNIT DESIGNATION				Co. B/1-11 INF	MONITOR (Print name) PFC I.M. Observer				
MAP USED		Series V259 1:50,000		TYPE OF VEHICLE OR OTHER SHIELDING		INSTRUMENT TYPE			
				Foxhole		IM - 174B/PD			
READING NO	LOCATION	TIME	DOSE RATE (cGyph)	DO NOT USE*	READING NO.	LOCATION	TIME	DOSE RATE (cGyph)	DO NOT USE*
1	AY123456	0600	0 (1)		16	AY123456	9		
2		0615	0		17		9		
3		0630	0		18		10 (7)		
4		0645	1 (2)		19		10		
5		0700	0 (3)		20		10		
6		0715	0		21		9		
7		0730	0		22		10		
8		0745	1		23		9		
9		0800	1 (4)		24		9 (8)		
10		0815	1		25		8		
11		0830	2 (5)		26		7 (9)		
12		0845	2		27		5		
13		0900	3 (6)		28		6		
14		0915	5		29		5		
15		0930	7		30		5		
REMARKS TOB 0555 $CF = \frac{180}{9} = 20$									
*DO NOT USE. For control party only									
CORRELATION FACTOR DATA									
LOCATION	READING NO.	DOSE RATE (cGyph)		CF*	LOCATION	READING NO.	DOSE RATE (cGyph)		CF*
		Inside	Outside				Inside	Outside	
AY123456	24	9	180	20					

DA FORM 1971-R, SEP 88

Replaces DA Form 1971 R, 1 Jun 63, which is obsolete

Figure 5-2. Completed DA Form 1971-R for monitoring.

Line Item	Meaning
Q	Location of reading.
R	Dose rate in cGyph. Additional descriptive words such as initial, increasing, peak, series, or summary, may be added.
S	Date and time of reading in local or Zulu time (state which).
ZB	Correlation factor data.

**Report Formatting Instructions**

Only the unit NBC defense team places monitoring data to be sent to higher headquarters in the NBC 4 nuclear report format. Unit monitors do not originate the NBC 4 nuclear report or send it to higher headquarters.

Line items Quebec, Romeo, and Sierra may be repeated as many times as necessary. When locations and times change, this gives a specific picture of the contamination throughout the area. A “zero” dose rate may be reported on line item Romeo.

The NBCC provides guidance on precedence for an NBC 4 nuclear report in the SOP or other instructions. This guidance is based on whether the report is an automatic or a directed report. The precedence depends on the urgency of the report. It is usually sent IMMEDIATE, but may be upgraded or downgraded as the situation dictates.

NBCC SOPs will detail in general terms how automatic NBC 4 nuclear reports travel from company level to the NBCC. When necessary, specified nets are used to allow timely flow and to avoid overload. Directed reports will be transmitted on the communications nets or other means specified by the NBCC.

Figure 5-3, shows examples of NBC 4 nuclear reports. These reports follow the format and report formatting instructions. Line item Quebec is the unit’s location and should be encoded for OPSEC purposes. This data need not be encoded if the report is sent by secure means. Users of the NBC 4 nuclear report are not limited solely to the use of the line items shown in these examples. Other line items may be added at the user’s discretion.

**Automatic Reports**

All units in the contaminated area submit certain monitoring reports automatically. These provide the minimum essential information for warning, hazard evaluation, and survey planning. Reports are sent through specified channels to reach the NBCC. Nondivisional and corps units in a division area submit reports to the division NBCC. Corps units send reports to corps NBCC.

It is emphasized that the purpose of establishing automatic reports is to prevent overload of communications. In this way units are obligated, yet limited, to certain types of reports. This also insures that only meaningful data are reported. The automatic reports are initial, peak, and special—those specified by the NBCC or required by intermediate commanders for operational purposes.

**Initial Report.** The unit monitor normally conducts periodic monitoring. When conditions require continuous monitoring, that technique is used. After noting a dose rate of 1 or more cGyph outside, the monitor notes the time and moves directly to shelter. The monitor reports to the unit

Standard Format		USMTF Program Format	
NBC 4 Nuclear Report	NBC 4 Nuclear Report	MSGID/NBC4/NUC//	MSGID/NBC4/NUC//
Q LB193351	Q LB193351	NBCMSGTP/SPECIAL//	NBCMSGTP/SUMMARY//
R 1 Initial	R 35 Series	QUEBEC/32ULB193351//	QUEBEC/32ULB193351//
S 021200Z	S 021400Z	ROMEO/20//	ROMEO/8//
	Q LB193351	SIERRA/151200Z//	SIERRA/041200Z
	R 30 Series		QUEBEC/32ULB190360//
	S 021430Z		ROMEO/10//
NBC 4 Nuclear Report	Q LB193351		SIERRA/041205Z//
Q LB193351	R 27 Series		QUEBEC/32ULB195331//
R 40 peak	S 021500Z		ROMEO/4//
S 021330Z	Q LB193351		
ZB 20	R 25 Series		
	S 021530Z		
	Q LB193351		
	R 23 Series		
	S 021600Z		
	Q LB193351		
	R 21 Series		

Figure 5-3. Examples of NBC 4 nuclear reports.

NBC defense team that an outside dose rate of 1 or more cGyph exists and gives the time of reading. The unit NBC defense team warns and alerts all unit personnel of the arrival of fallout. Defensive measures per SOP are implemented. The defense team then formats an NBC 4 nuclear report to send to the NBCC. The word “initial” is used with line item Romeo to alert the NBCC to the value of the report.

Intermediate headquarters screen and evaluate the initial NBC 4 nuclear report. If the hazard has already been reported, the precedence of the report is reduced. The report may be eliminated if several reports have already been submitted. The initial report is used at the NBCC to confirm the fallout prediction. The dose rates cannot be converted to  $H + 1$ .

**Peak Report.** While performing continuous monitoring, the unit monitor records dose rates on DA Form 1971-R according to the time intervals specified in unit SOP. Dose rates should be recorded at 15-minute intervals while fallout is arriving. The dose rate steadily rises until it reaches a peak and then it decreases. In some cases, the dose rate may fluctuate for a short time before beginning a constant decrease.

Once there is a constant decrease, the monitor takes an inside reading and then an outside reading for the CF calculation. First, the inside reading is recorded on DA Form 1971-R as the next reading in sequence (in the main body of the form) and also in the CF data portion of the form. Other entries for the CF block are completed. Within three minutes, the monitor goes to the outside location previously used and takes an outside dose-rate reading. The monitor immediately returns to the shelter. Exposure to radiation during this short period of time is minimal.

The monitor records the highest outside dose-rate reading in the CF data block on DA Form 1971-R. The monitor then reports the location of the readings, the time of readings, the inside dose rate and the outside dose rate to the unit NBC defense team. The monitor does not calculate or apply the CF to this data. The unit SOP outlines the means of communication to be used. The monitor does not need to use the NBC 4 format to report this information. It is usually sent over unit radio or wire nets or presented in person. Any questions about the information are cleared up at this time. The monitor resumes continuous monitoring-recording dose rates at 30-minute intervals after the peak dose rate has been reported. This procedure is continued until the unit leaves the contaminated area or the radiation level drops to 1 cGyph or the commander directs that periodic monitoring begin.

The unit NBC defense team records the monitor’s information onto DA Form 1971-R. After all information is recorded, the team calculates the CF and applies it to the highest dose rate. It then formats the NBC 4 nuclear

report. The word “peak” is used with line item Romeo. Intermediate headquarters do not screen or delay peak reports. This information is extremely important to the NBCC.

**Special Reports.** FSOP/OPLAN/OPORD and other standing instructions may establish the requirement for special NBC 4 nuclear reports. These special reports are evaluated by the NBCC. They invite command attention to areas or conditions of serious concern. The operational situation, unit radiation status, and similar considerations determine the criteria for these special reports. They cannot be specified here. Generally, this report may be required when the ground dose rate goes above a specified value. When the dose rate increases after it has decreased, a special report may also be sent. In this case, the word “overlapping” could be used with line item Romeo. Special reports may be required after a specified period of time if the unit remains in the area.

### Additional Reports

In addition to the automatic reports-initial, peak, and special-units may be required or directed to submit other reports.

**Increasing and Decreasing Reports.** Dose rates reported on NBC 4 nuclear reports (line item Romeo) followed by the words increasing or decreasing are never sent unless requested. This cuts down on communications overload. It is logical to assume that the dose rate at a unit which sent an initial NBC 4 nuclear report will increase, peak, and then decrease. The computations used to normalize (convert to  $H + 1$ ) the peak dose rate also convert any decreasing dose rate at that location to the same  $H + 1$  dose rate. From this it can be seen that unsolicited increasing and decreasing reports clutter the reporting channels with useless information.

**Directed Reports.** Selected units in the contaminated area will be directed to submit additional NBC 4 nuclear reports. The NBCC uses these reports to evaluate a radiological contamination hazard-the decay rate of fallout and how long this decay rate (and the contamination overlay) will remain valid. They are used to determine the H-hour (if unknown) and the soil type in induced areas.

Reliable calculations are directly related to the precision of the dose rate measurement. Tactical decisions and personnel safety depend on the accuracy of these measurements. Further development of the contamination situation depends upon this data. An error in dose rate measurements means a similar error in calculating future dose rates and total dose.

The NBCC carefully selects locations for additional dose-rate readings. Close coordination with the G3 is required.

Selection is based on—

- How long the unit is likely to remain in the area.
- The training status of the unit.

- Comparison of average soil, vegetation, and terrain across the entire area and at the proposed monitoring location.
- The tactical situation.
- The need for representative information throughout the contaminated area according to its size and unit distribution.

There are three directed reports—Series, Summary, and Verification. Instructions for report frequency, precedence, reporting procedures, communications channels, and format are established by FSOP/OPLAN/OPORD and other written instructions. The names of these reports describe their purpose. To the monitor or unit defense team the name means a dose-rate reading taken in accordance with a specific procedure.

**Series Reports.** A Series report consists of dose-rate readings taken at the same location at 30-minute intervals for 2 ½ hours followed by hourly reports. This report begins after a peak dose rate has been noted at the monitor's location.

Requests to units selected to submit series reports come through intelligence channels. Requests must ask specifically for a Series report and are passed, ultimately, to the NBC defense team, which directs the monitoring. A request for a Series report alerts the monitor to take a series of dose rate readings at 30-minute intervals. Whenever possible, the readings are taken at 30-minute or hourly intervals from time of burst (TOB). If TOB is 0745, readings should be taken at 0815, 0845, 0915, and 0945. The location must remain constant. Readings are recorded on DA Form 1971-R. The monitor reports each reading and the time it was measured to the NBC defense team. The monitor continues the procedure until told to stop. The instrument used to measure dose rates should be zeroed before each reading.

The unit NBC defense team organizes the data into the NBC 4 nuclear report. The word "Series" is used with line item Romeo. As per FSOP/OPLAN/OPORD or other written instructions, the reports may be sent one at a time or held until several have been collected and then reported. Intermediate headquarters do not screen or delay these reports. They are needed at the NBCC for fallout decay rate and other calculations.

**Summary Reports.** A Summary report shows the radiation distribution throughout a unit's area of responsibility. The locations for readings are selected by the reporting unit according to the distribution of its elements and the extent or variety of the area's terrain. The

time each reading was taken is also given. Inside dose rates are converted to outside dose rates. Units may be directed to submit the Summary report or FSOP/OPLAN/OPORD or other written instructions may require the report to be submitted at a specified time (for example, H + 24 or H + 48).

The unit NBC defense team will direct its unit monitors to take dose-rate readings at several locations within their subunit boundaries. Unit monitors take these readings at locations specified either by the defense team or at locations they choose. The location, dose rate, and time of reading are recorded on DA Form 1971-R and the form returned to the defense team.

The defense team organizes this data into the NBC 4 nuclear Summary report. The word "Summary" is used with line item Romeo. The defense team ensures that enough readings are taken at various points so the coverage expresses the situation across its area. The report is sent to the NBCC through intermediate headquarters where additional data from other units are added if available. The report can be used to verify an overlay of shrinking contamination.

**Verification Reports.** The Verification report is a unit's response to a direct request from the NBCC. If data is lacking from a specified location near or in the unit area, the NBCC requests a Verification report. These reports also can be used to recheck an unusually high dose rate, a zero reading, or other abnormalities. The NBCC is aware that the previously reported dose rate is no longer valid because radioactive decay will have taken place. A Verification report is not a retransmission of previously reported readings, but a check of the actual condition of the area.

A unit tasked with submitting a Verification report will receive specific instructions. These will include the exact location for the readings, why the report is requested, and details about communications.

A unit monitor tasked to perform monitoring uses the direct technique to take the readings whenever possible. The monitor records all data on DA Form 1971-R and turns the form in to the unit NBC defense team when the mission is completed.

The team will format the NBC 4 nuclear report. The word "Verification" is used with line item Romeo. Intermediate headquarters do not screen these reports. They are passed without delay to the NBCC.

## Surveys

Nuclear surveys are conducted to find the extent and intensity of contamination. Radiological monitoring and reconnaissance provides general information about contamination for immediate operations. Surveys provide detailed information on which future operations are based.

Surveys require time and coordination. Men and equipment must be diverted from primary missions. Because of these circumstances, surveys are conducted only when the intensity of contamination must be known. Future dose rates can be predicted from the data provided by



monitoring or survey. Recon cannot provide sufficient data for this. Monitoring provides data only in areas occupied by troops.

If no operations are planned in the area, a survey is not required. However, if there is a remote chance that this is not the case, a survey should be conducted at the earliest opportunity. Current techniques are designed for reasonable safe survey of high dose rate areas. Once the contamination has decayed, the survey will be difficult. Often, a survey will be delayed until the area is under friendly control. Survey in the Covering Force Area (CFA) or forward of the Forward Line of Troops (FLOT) is not done unless knowledge is imperative and loss of survey team is acceptable. This will be an extremely rare case.

Calculations based upon survey data are a series of approximations. These are sufficient for field use; however, best accuracy is obtained by resurveying the area every few days. Theoretically, once a radiological hazard has been identified, the contamination existing at any future time can be calculated. However, weathering and inaccuracies in initial survey make this approach unrealistic. Frequent resurvey of contaminated areas is essential. The frequency and detail of resurvey will be determined by the reliability of the initial survey. Resurvey will be planned and conducted in the same way as the initial survey.

Surveys are not conducted by units unless directed. The NBCC will initiate surveys or request that a subordinate unit be directed to conduct a survey.

A survey is performed by a group comprised of a defense team and one or more survey teams. The defense team, consisting of one or more men, plans and directs the survey. It screens and transmits the data to the authority that ordered the survey. The survey team, organized within the company/troop/ battery NBC team, consists of a monitor and necessary support and security personnel. Only the minimum number of personnel are exposed to radiation. The defense team briefs the survey teams and controls their movements.

There are two types of surveys, aerial and ground. The type used depends on many factors. Aerial surveys are conducted for large areas and have advantages over ground surveys. They are faster and more flexible. They expose personnel to lower doses, and require fewer personnel and equipment to perform. However, aircraft may not always be available. Ground surveys can be done under unit control using unit equipment. They can be done in any type of weather, and they can be done when aircraft cannot fly. They are more accurate than aerial surveys. These points are considered by the NBCC when deciding the type of survey to use.

## Control of Surveys

There are two different methods of control over surveys, centralized and decentralized. Centralized surveys mean that the NBCC ordering the survey provides the defense team. The radiological data is reported directly to this team. The data is not screened, consolidated, or evaluated in any way by intermediate headquarters.

Decentralized control is used when the NBCC cannot or should not control the movements of the survey teams. Thus, decentralized control means that the NBCC has directed a subordinate unit to control a survey. This unit will report data directly to the NBCC. It will not screen, consolidate, or evaluate the data in any way.

The type of survey used is also a factor in determining which method of control is used. Aerial surveys can cover large areas. They also require air space management. The unit NBC defense team must be able to obtain information on the operational situation. This avoids directing the aircraft into hostile areas. This type of information is not available below NBCC level. Also, subordinate units do not normally have aircraft available for a survey. Thus, centralized control by the NBCC is used for aerial surveys. This may differ, however, based on the organizational composition of the unit.

During ground surveys, decentralized control is best. This is because the NBCC does not have radios or has only limited access to radios, which are necessary to control the ground survey teams. Also, distances may be too great from the survey area to the NBCC location for good communications. Control of a ground survey may require too much of the NBCC's time. For these reasons, the subordinate unit tasked to perform the ground survey provides the defense team. Therefore, decentralized control by the subordinate unit is used for ground surveys.

Table 5-1 shows the relationships between the NBCC and subordinate units, centralized and decentralized control, and the type of surveys.

**Table 5-1. Control of surveys.**

Centralized	Decentralized
NBCC	Subordinate Unit
Aerial	Ground

## Survey Planning at the NBC Center

Radiological contamination on the nuclear battlefield may cover large areas. It may occur in many locations with overlap of contaminated areas, and may be in varying stages of decay. Initial detection of new contamination will probably be in the form of NBC 4 nuclear Contact reports from recon elements. These reports will alert the command to the presence of a previously undetected hazard. This

will cause a new series of orders and requests to be initiated for radiological information. These orders and requests will be superimposed upon existing survey plans already functioning for older contaminated areas. Thus, the supervision and coordination of the radiological intelligence effort will be a continuing process.

The NBCC initiates all radiological surveys. This ensures that the right amount of data is obtained at the right time. It also ensures that surveys are not initiated when data is not required. This reduces the burden of subordinate units. Subordinate units execute only their assigned portions of the plan(s).

### Factors Influencing Reliability

With the guidance and procedures outlined, aerial surveys provide the defense team with adequate and sufficiently reliable data. Generally, the dose rate determined by aerial survey varies from the true dose rate at the ground location. This is because of survey meter errors, pilot errors, monitoring errors, errors due to contamination of aircraft at touchdown for ground reading, and the overall system errors.

The type and source of contamination will determine the survey requirements and sequence of calculations to be performed. The types and sources of radiological contamination are—

- **Induced contamination.** Contamination resulting from a nuclear burst where the contamination can be related to a specific nuclear burst where fallout did not occur, or contamination is localized around an obvious ground zero area.
- **Fallout (known weapon).** Contamination arriving or identifiable as fallout which can be related to a particular nuclear burst.
- **Fallout (unknown weapon).** Contamination arriving or identifiable as fallout which cannot be related to a particular nuclear burst.
- **Contamination (unknown source).** Contamination identifiable as induced or fallout which cannot be related to a known source.
- **Combination and multiples of the above.**

The radiological survey plan for a contaminated area will be based upon the estimation of many variables. The plan must establish, as a minimum, the amount of detail required, method of control (decentralized or centralized), type of survey (ground or air), and technique to be used (route, point, course leg, or preselected dose rate). The survey plan for a particular contaminated area will probably contain a combination of these methods, types, and techniques.

For example, a typical survey of a contaminated area may include an aerial survey and a ground survey. Each covers a different zone within the contaminated area, and all the techniques may be employed.

### Factors Influencing the Plan

The following paragraphs list some of the factors affecting survey planning with guidance concerning their major effects. In preparing the survey plan, each factor must be estimated and balanced against the need for information:

- **Knowledge of the Contamination.** Knowledge about the contaminated area which is available or expected to be available (such as recon data and monitoring reports) will help determine the size of the area to be surveyed and the amount of detail required.
  - **Operational Situation.** In rapidly changing situations, centralized control is necessary. Under such conditions, aerial survey is required for critical counterattack routes. A checkpoint overlay for aerial survey planning will be prepared as areas are assigned or as areas of interest change. Main supply routes and so forth may be surveyed using the ground technique later. The operational situation will dictate the availability of personnel and equipment.
  - **Urgency.** Aerial surveys are normally the most rapid means of obtaining information.
  - **Weather.** Aerial surveys may be precluded by poor visibility. Surveys should be delayed during precipitation and high winds. These conditions tend to change a contamination pattern. Ground surveys can be accomplished in any weather, except as noted. Aerial surveys may be precluded by bad weather.
  - **Terrain.** Lack of road nets or the inability of the soil to support ground movement may eliminate a ground survey. An aerial survey is of limited use in mountainous terrain. In areas such as arctic, desert, or jungle, where reference points are rare, marking reference points with cans of paint or bags of talc or flour may be required. The type of survey must be carefully selected. Often radio fixes and precise time, distance, speed, and direction calculations must be made.
- S Status of Training.** Inadequate training or losses of trained personnel may limit survey capability. The status of training must be considered in selection of the type of survey. Status of training of defense teams at subordinate headquarters will also affect this. A record of equipment status and training status of available monitors, survey teams, and subordinate defense teams must be maintained for survey planning. Aerial survey requires the best or most well-trained monitors.
- T Time-distance.** Time-distance factors must be estimated and considered when selecting the most appropriate type of survey to obtain data and allow evaluation within the commander's time limits. Survey operations are not initiated until fallout has ceased. Dependence upon monitoring reports is the primary method of obtaining a rough estimate of contamination information during arrival of fallout.
- **Dose.** Dose status of survey personnel and the operation exposure guidance set by the commander must be evaluated when planning the type of survey.

- **Communications.** Availability of communications will affect all phases of the survey plan. Aerial survey will normally impose the least communications load or risk.
- **Maps.** The NBCC must consider maps and the areas they cover. These maps must be available to units that will participate in the survey.
- **Area Coverage.** All helicopters have approximately the same survey area coverage capability of between 130 and 450 square kilometers per hour per aircraft, depending upon the detail required. Any powered vehicle is satisfactory for conducting ground surveys. All vehicles have approximately the same area coverage capability of between 15 and 40 square kilometers per hour per vehicle, depending upon the degree of detail required, the road network, and the trafficability of the contaminated area. However, because of the superior shielding and cross-country characteristics of the tracked armored vehicle, this type of vehicle is preferred. Regardless of the type of vehicle used, additional shielding (sand bags or metal plates) is always added to the vehicle. To determine how much additional shielding to add to the vehicle, refer to Appendix B and the vehicle data plate for load density. This will reduce the total dose of survey personnel. Selection of the type of vehicle used is based upon the relative shielding correlation factors of one vehicle compared to another. See Figure 5-1 to make these comparisons. The higher the number, the better the protection.
- **Contamination.** A listing or an overlay showing points, routes, or areas where contamination could seriously affect accomplishment of the mission will be maintained for survey planning. These areas, routes, and points are prioritized to help with survey planning.
- **Damage Assessment.** Often a helicopter will be deployed to conduct area damage assessment after an attack. When this occurs, survey and damage assessment can be combined.
- **Multiple Bursts/Sources of Contamination.** When multiple bursts occur, fallout can overlap other fallout areas or induced areas can interlock. Also, several sources can overlap one another such as a neutron-induced area overlapped by fallout.

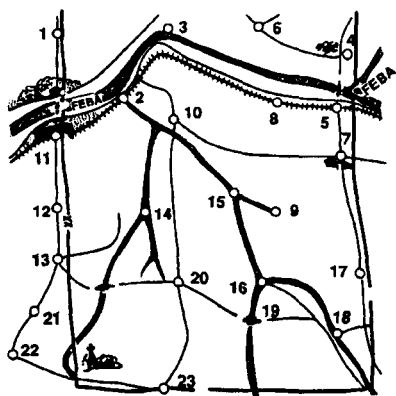

Figure 5-4. Sketch map of division area, showing preselected checkpoints.

Survey of these areas is not difficult; however, normal calculations necessary to present a clear picture will not work. The primary task in these calculations involves sorting dose rates of one contribution from the other. Prior knowledge about decay or soil type for an area before overlap occurs is critical. See Chapter 6 for more details on overlapping calculations.

The basis for planning an aerial survey is the checkpoint overlay. Checkpoints that are easily identified from the air and on a map (small bodies of water, streams, or road junctions) are selected for the entire area of responsibility by the NBCC in coordination with the aviation section. These checkpoints are maintained as an overlay by these two staffs. Then, when a survey requirement is established, the defense team selects a series of course legs, routes, and points where data will provide sufficient ground dose-rate information to evaluate the contaminated area.

Figure 5-4 illustrates a divisional area with preselected checkpoints. This overlay is used with the fallout prediction or neutron-induced prediction outlined in Chapters 4 and 7. Figure 5-5 shows an overlay plan for an aerial survey. Figure 5-6 (next page) shows an overlay plan for the ground survey portion of the plan. When survey of neutron-induced areas is required, a single course leg is selected which will pass directly through ground zero. The survey will begin at the edge of the contaminated area. Since the contaminated area is taken to be circular, survey ceases at ground zero.

Dose rates equal to those found on the course leg are assumed to be present on the other side of ground zero in reverse order. When conducting a survey of an induced area, use either the IM174 or AN/VDR2 Radiacmeter. Only this survey instrument is capable of detecting the entire radiation hazard. Thus, the find plot will be concentric circles. Figure 5-7 (next page) illustrates survey of neutron-induced areas. Only aerial survey is used. Ground survey will result in unacceptable total doses for survey personnel.

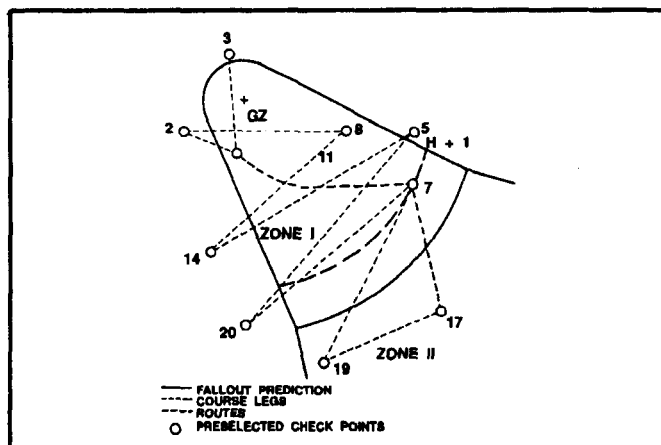

Figure 5-5. Fallout prediction and planned aerial survey overlay.

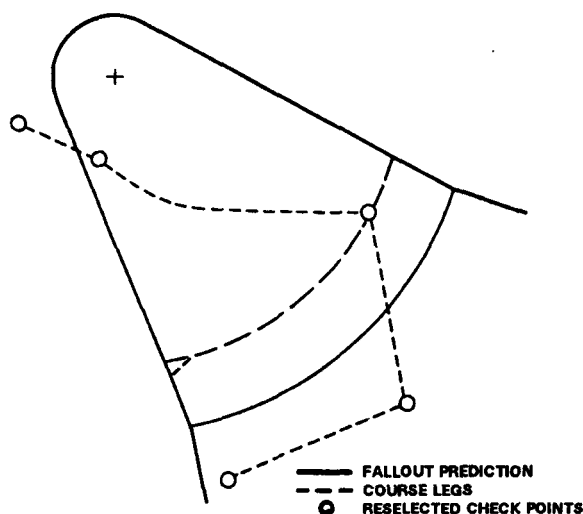

Figure 5-6. Fallout prediction and planned ground survey overlay.

## Personnel and Equipment Requirements

Personnel and equipment for ground survey teams and monitors for aerial survey teams are drawn from the company/troop/battery NBC teams subordinate to the authority directing the survey. Reconnaissance units have the capability (if provided aircraft) of performing aerial or ground surveys as a priority mission when required.

### Personnel

The number of ground survey teams required at any one time will depend on the situation, terrain, time available, detail desired, and other factors. Generally, more personnel are needed for large areas, if time is limited.

The same factors that influence the number of survey teams required for ground surveys apply to aerial surveys. Monitors for the aerial survey teams should be selected from units normally located near aircraft landing areas. This reduces the time needed to brief the survey teams and get them airborne. Primary sources for monitors are—

- NBC recon units.
- Other units with trained monitors.
- Aerial observers who regularly fly recon and surveillance missions.

NBC defense teams for ground survey established at all echelons use organic, school-trained personnel.

### Equipment

Units will require the following equipment to perform ground surveys:

- The IM174-series or AN/VDR2 radiacmeter used for measuring dose rates.

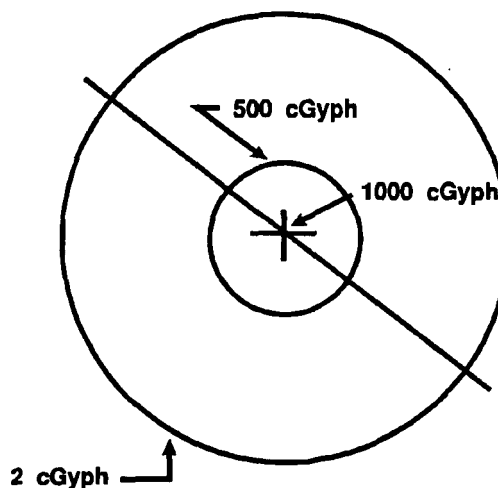

Figure 5-7. Illustration of neutron-induced survey.

- A dosimeter, such as the DT 236/PDR75, IM47, AN/UDR13/PD, or IM143/PD (USMC), must be carried for purposes of radiation exposure control. The IM47 or IM143 should be mechanically zeroed before use and all radiac equipment should be checked to see that it is serviceable. The AN/VDR2 can also be used to read accumulated dose, but the instrument must remain in operation for the entire mission.
- DA Forms 1971-R and 1971-1-R are used for recording information collected during the survey. Local reproduction of these forms is required.
- A watch is needed to determine the time when survey readings are taken. For aerial surveys, a stopwatch or a watch with a sweep-second hand is needed to time the interval between readings.
- Vehicles that have high radiation shielding characteristics (high correlation factors listed in Figure 5-1) should be selected for ground surveys.
- Communications equipment necessary for rapid reporting is required.
- Maps of the land areas to be surveyed must be available to the survey team.

## Coordination

The unit NBC defense team will coordinate the activities of the survey teams with the units located in or near the area to be surveyed. If coordination by the defense team cannot be accomplished because of lack of communications or other causes, the survey teams will be informed. The survey teams will then be directed to coordinate, provided the situation in the area and the required time of completion of the survey permit.

## Survey Team Briefing

Adequate control of the radiological survey, once initiated, will depend to a large extent upon proper briefing of the survey teams. Survey team briefings may vary from group to individual briefings. This depends upon space, time, and operational conditions; briefings may be given in oral, written, overlay, or other form. In any case, a briefing should always be conducted. The written or oral briefing is essentially an order. It should generally follow the form of the five-paragraph operation order. The following is a radiological survey party briefing order reference list (List any maps, charts, or other documents necessary to understand the order.):

### **Radiological Survey Party Briefing Reference List**

#### 1. Situation.

a. *Operational Situation.* Briefly describe the operational situation as it concerns conduct of the survey, to include enemy forces, friendly forces, and planned actions.

b. *Contamination Situation.* Present any factual information available about the contaminated area, to include limits, dose rates, sources of contamination, terrain, and weather.

#### 2. Mission.

Clear, concise statement of task to be accomplished (who, what, when, where, and why).

#### 3. Execution.

a. *Concept of Operation.*

b. *Specific Assignment of Each Team.* In subsequent separate lettered subparagraphs (such as a, b, c, d, and e) give a specific task of each survey party. Include the coordination required.

c. *Coordinating Instructions.* The last subparagraph of paragraph 3 of the order contains instructions applicable to two or more of the survey teams, such as—

- (1) Time of departure and return.
- (2) Routes and alternate routes to and from the contaminated area.
- (3) Coordination required.
- (4) Dose danger limitations. If the AN/VDR-2 is to be used to check for turnback dose (or dose rate), this value shall be entered as the alarm setpoint and checked prior to departure (turnback dose and operation exposure guidance).
- (5) Actions to be taken upon reaching limitations in (4) above.
- (6) Whether and when marking of contaminated areas is required.
- (7) Debriefing—where, when, by whom.
- (8) Decontamination - if required, when, where, and by whom.

#### 4. Administration and Logistics.

Contains information such as required equipment and forms.

#### 5. Command and Signal.

a. *Command.* Location of defense team.

b. *Signal.*

(1) *Data reporting procedure.*

(2) *Special instructions concerning SOI.*

(3) *Call signs, code to be used, and reporting times.*

(4) *Communications means (primary and alternate).*

## Aerial Survey

Aerial radiological survey information can be obtained by use of the IM1740/PD or AN/VDR-2 Radiacmeter held in a vertical position (face up), in rotary wing aircraft. Aerial surveys are conducted rapidly and at a distance from the radiation source. Hence, aerial survey teams are exposed to considerably less radiation than ground survey teams if an equivalent ground survey were conducted over the same area. Aerial surveys can be employed over areas that have dose rates unacceptably dangerous to ground survey teams. Because of speed and flexibility, aerial surveys can be employed over large areas, over unoccupied areas of operational concern, over enemy occupied areas, and over areas of difficult accessibility to ground troops. Aerial survey is preferable when conducting surveys of large areas. The advantages of aerial survey over ground survey are speed and flexibility of employment; lower radiation doses to survey team members, and minimum requirements for equipment, personnel, and communications. However, the dose-rate readings are not as accurate as those obtained by ground survey. Another disadvantage is that dose rates for specific points on the ground may not be provided by aerial survey.

## Techniques

The techniques used to conduct detailed aerial surveys include the route technique, the course leg technique, and the point technique.

In using the route technique, the pilot flies between two checkpoints, following the route of some predominant terrain feature such as a road that connects the two checkpoints.

In using the course leg technique, the pilot flies a straight line course (course leg) between two checkpoints. The procedure followed in obtaining dose-rate information between checkpoints is the same, using either the route technique or the course leg technique. When the dose-rate information obtained from either technique is processed, the result is a series of ground dose rates spaced at equidistant intervals along the path over which the aircraft flew.

The point technique is used to determine the ground dose rate at points of operational concern and is normally employed to obtain more precise dose-rate information at those points than can be obtained by use of other aerial survey techniques. Processed data from dose-rate

information obtained using the point technique are ground dose rates existing at each of the selected points.

**Procedures**

The course leg technique requires that the aerial survey party fly a straight line course (course leg) between two checkpoints. The pilot maintains as near as possible a constant height above the ground, a constant ground speed, and a straight flight direction between the starting and ending checkpoints of each course leg.

The pilot locates the starting checkpoint of a course leg to be flown and either locates the end checkpoint or determines the azimuth of the course leg.

The pilot flies the aircraft on the proper course to pass over the initial checkpoint on a straight path to the end checkpoint. When on course, the pilot alerts the monitor and gives him the height above ground. Shortly before reaching the initial checkpoint, the monitor records the time and height above ground. The monitor rechecks/rezeroes the survey instrument before each course leg, to assure proper operation.

The pilot commands "Mark" when the aircraft is directly over the starting checkpoint, at which time the monitor reads the survey meter, records the dose rate, and begins timing preselected time intervals.

The monitor reads the survey meter and records the dose rate at each preselected time interval (for example, every 10 seconds).

The pilot again alerts the monitor when the aircraft approaches the end checkpoint. When the aircraft is directly over the end checkpoint, the pilot commands "Mark". At this time, the monitor reads and records the final dose rate.

The procedures for a route survey are identical to those for a course leg survey. However, this may or may not require a straight flight direction.

Procedures for a point survey require the aircraft to land near the point of interest. The monitor dismounts, proceeds to the selected point, and takes the reading by using normal ground monitoring procedures. When high dose rates do not permit this procedure, aerial dose rates are taken and air-ground correlation factor (AGCF) data are applied by the NBCC.

**Survey Meter Location in Aircraft**

A specific location for the survey meter in the aircraft must be selected for each aerial survey.

The best survey meter locations for several aircraft are in Table 5-2. If the air-ground correlation factors from Table 5-3 are to be used, the survey meter **must** be located within the aircraft as specified in Table 5-2.

When air-ground correlation factor data are to be determined during the survey, the location of the survey meter may be as given in Table 5-2 or the location may be

**Table 5-2. Location of Survey Meter During Aerial Survey.**

Aircraft <sup>1</sup>	Survey meter location
OH-6A	Held in front of the left rear seat. <sup>2</sup>
UH-1	In the passenger compartment, held in front of the second seat from the left side of the aircraft.

<sup>1</sup> Order of preference of currently available aircraft for use in aerial survey is as listed.

<sup>2</sup> This location recommended in the OH-6A aircraft, for which air-ground correlation factors are not available, nor is information concerning the location for the instrument in the UH-60 and the AH-64.

**Table 5-3. Planning AGCF for survey height determination.<sup>1</sup>**

Height Above Ground		AGCF <sup>2</sup>
Feet	Meters	
100	30	2.2
150	45	2.7
200	60	3.2
250	75	3.9
300	90	4.5
350	106	5.4
400	120	6.2
450	136	7.2
500	150	8.2
750	227	18.6
1,000*	300*	29
1,500*	454*	80
2,000*	600*	300
2,500*	757*	1,450
3,000*	900*	2,600

<sup>1</sup> Some figures are rounded for practical use.  
**Note:** For wooded areas, multiply the AGCF by 0.8. For urban areas (in open) multiply the AGCF by 0.7. These will give you approximate ground dose rates.  
<sup>2</sup> Interpolation and extrapolation are valid.  
 \* The use of AGCF with readings taken at these heights results in approximations of ground dose rates.

selected for the convenience of the pilot and monitor. When aircraft not included in the table are used, such as the UH-60 or AH-64, the survey meter location must be

selected. All dose-rate readings in a survey must be made with the meter in the selected location.

$$\begin{aligned} \text{Ground dose rate} &= \text{Aerial dose rate} \times \text{AGCF} \\ &= 10 \text{ cGyph} \times 8.2 \\ &= 82 \text{ cGyph.} \end{aligned}$$

**Air-Ground Correlation Factors**

An air-ground correlation factor (AGCF) is required for calculation of ground dose rates from aerial dose rates taken in an aircraft during a survey. The AGCF is the ratio of a ground dose-rate reading to a reading taken at approximately the same time in an aircraft at survey height over the same point on the ground. There are two techniques for obtaining the AGCF.

The preferred technique is by direct determination of ground and aerial dose rates during the survey and subsequent calculation of the AGCF. The AGCF may be calculated as shown below, using the aerial dose rate taken at survey height and the ground dose rate:

$$\begin{aligned} \text{Ground dose rate} &= 20 \text{ cGyph.} \\ \text{Aerial dose rate (60-meter survey height)} &= 5 \text{ cGyph} \\ \text{Air-ground correlation factor} &= \frac{\text{Ground dose rate}}{\text{Aerial dose rate}} \\ &= \frac{20 \text{ cGyph}}{5 \text{ cGyph}} \\ \text{AGCF} &= 4. \end{aligned}$$

By multiplying the reading taken in the aircraft at a survey height of 60 meters by the AGCF, the 1-meter above ground level reading can be estimated. The procedure for determining the ground dose-rate reading involves landing near the selected point. The monitor proceeds to that point and takes the ground dose-rate reading, using normal monitoring procedures. AGCF data are obtained if possible for each two to four course legs or routes flown. The sites for obtaining AGCF data should be selected to approximate average foliage and ground surface conditions in the contaminated area. Accuracy of this AGCF data as to position, height above ground, and dose rate is of primary importance. New data must be obtained when survey height changes by 15 meters or more, when ground foliage or average ground surface conditions change significantly, if the aircraft or the survey meter is changed, or if weather conditions change drastically during monitoring.

When the tactical situation, terrain conditions, high radiation dose rates, or other factors do not permit the use of the preferred technique, the AGCF shown in Table 5-3 are used. To estimate a ground dose rate, multiply the aerial dose rate obtained by the correlation factor from Table 5-3 for the type of aircraft and the height above ground at which the reading was taken. In the following example, while flying at a 150-meter survey height in a UH-1, a reading of 10 cGyph was obtained; the AGCF for a UH-1 at a height of 150 meters is 8.2:

**Capability of Aircraft**

Light fixed-wing aircraft or helicopters are satisfactory for conducting aerial surveys; however, because of the slow speeds required, helicopters are the most desirable. Light fixed-wing aircraft and helicopters have approximately the same survey area coverage capability of between 130 and 450 square kilometers per hour per aircraft, depending upon the detail required. Order of preference of currently available aircraft for use in aerial surveys is in Table 5-2.

**Determination of Overall Correction Factor**

When calculating aerial survey data, an additional step reduces the number of required calculations. Multiply the AGCF by the normalization factor (NF, Table 6-5, on page 6-26) for the start time of the aerial route or course leg. The product is the overall correction factor (OCF). An OCF is calculated for each course leg, or route, of the survey. The OCF is used instead of the NF and is calculated by the NBCC after the survey is completed. The OCF will convert shielded readings to unshielded readings normalized to H+1.

Sample:  $\text{AGCF} \times \text{NF} = \text{OCF}$

When processing ground survey data, use the same procedures but use a vehicle correlation factor instead of an AGCF. Round dose rates to the nearest whole number. Vehicle correlation factors are discussed later in this chapter.

Figure 5-8 (next page) shows a completed DA Form 1971-1-R for an aerial survey. Note that an OCF was determined for each leg of the survey. The OCF was then used to multiply the dose rates on the legs to obtain the normalized readings. H + 1 readings are located in the control party column.

A special circumstance can arise whenever a survey or recon is made over wooded or urban areas. In this case, the AGCF does not properly represent the air-to-ground ratio. This is because the fallout is much closer to the aircraft and the radiac instrument. The fallout is on the tops of trees and on rooftops. To adjust for this situation, a correlation factor, as shown in Figure 5-1, must be applied to the readings which were taken over trees or urban areas.

During recon and some survey operations, the decay rate will be unknown. Thus, two different OCF will be calculated for the survey/recon data. One will be based on  $n = 1.2$  to provide a rapid means of developing a picture.

RADIOLOGICAL DATA SHEET - <del>ROUTE OR COURSE LEG TECHNIQUE</del> (Ground and Aerial Survey)					DATE	PAGE NO.	NO. OF PAGES					
For use of this form, see FM 3-3-1; proponent of this form is TRADOC.					20 July	1	1					
SURVEY PARTY DESIGNATION B-2.9			MONITOR (Print Name) PFC FARES									
MAP USED BIERHOFEN 1:50,000		AIRCRAFT OR VEHICLE TYPE UH1		INSTRUMENT TYPE AN/VDR2								
ROUTE OR COURSE LEG DESIGNATION			CK-CE	CE-CB	CB-CD							
TIME AT START OF LEG OR ROUTE			0950Z	0955Z	1005Z							
TIME ROUTE COMPLETED (Ground) OR SURVEY HEIGHT (Air)*			200FT	200FT	200FT							
DISTANCE OR TIME INTERVAL USED			10 SEC	10 SEC	10 SEC							
REMARKS TIME OF BURST 200730Z N = 1.2 CK-CE AGCF = 3.8 NR = 2.767 OCF = 10.515 CE-CB AGCF = 3.8 NR = 2.884 OCF = 10.559 CB-CD AGCF = 3.8 NR = 3.123 OCF = 11.867			READING NO.	DOSE RATE (cGyph)	DO NOT USE**	READING NO.	DOSE RATE (cGyph)	DO NOT USE**	READING NO.	DOSE RATE (cGyph)	DO NOT USE**	
			1	12	126	1	2	22	1	0	0	
			2	12	126	2	2	22	2	0	0	
			3	11	116	3	2	22	3	1	12	
			4	10	105	4	3	33	4	2	24	
			5	9	95	5	3	33	5	3	36	
			6	8	84	6	3	33	6	3	36	
			7	7	74	7	3	33	7	3	36	
			8	6	63	8	4	44	8	3	36	
			9	5	53	9	4	44	9	2	24	
			10	5	53	10	5	55	10	1	12	
			11	5	53	11	5	55	11	1	12	
			*Times of start and stop are reported for each route or portion of route completed at one time by ground survey, if a route is done in parts, use a separate column for each part.			12	4	42	12			12
**DO NOT USE. For control party use only.			13	4	42	13			13			
AIR-GROUND OR VEHICLE CORRELATION FACTOR DATA			14	4	42	14			14			
LOCATION	HEIGHT (feet) AIR ONLY	DOSE RATE (cGyph)		CF **	15	3	32	15			15	
		INSIDE AIR	OUTSIDE GROUND		16	3	32	16			16	
BF	200	5	19	3.8	17	2	21	17			17	
					18			18			18	
					19			19			19	
					20			20			20	

DA FORM 1971-1-R, JAN 94

Replaces DA Form 1971-1-R, Sep 86, which is obsolete.

Figure 5-8. Completed DA Form 1971-1-R for an aerial survey sheet.



The second OCF will be based on the decay rate actually present. This may or may not be  $n = 1.2$ .

### Plotting Data

Contaminated areas are shown on the radiological situation map. Only minimum essential information about detected and identified areas of contamination are shown. This allows interpretation of the contamination situation. Each contaminated area is shown by a pattern of dose-rate contour lines and a few key dose rates for points, routes, or areas of particular concern. Eventually all monitoring, survey, and recon information for a contaminated area is plotted as ground dose rates. This information is corrected

to unshielded ground dose rates at the reference time (normally  $H + 1$ ) for the particular pattern.

Determination of dose-rate contours and key dose-rate locations requires large quantities of dose-rate information. However, much of the information is not needed on the radiological situation map. So, worksheet overlays are prepared for the initial identification and surveillance of each contamination hazard. Only the necessary identification information is transferred to the radiological situation map.

Monitoring reports and point surveys are processed and plotted into ground dose rates for the points at which the readings were taken.

## Airborne Radioactivity

Most contaminated particles in a radioactive cloud rise to considerable heights. Thus, fallout may occur over a large area. It may also last for an extended period. A survey conducted before fallout is complete would be inaccurate; because, contaminants would still be suspended in the air. For this reason, as well as the hazard to surveying personnel, radiological surveys are not accomplished before completion of fallout.

An estimate of the time of completion ( $T_{comp}$ ) of fallout for a particular location may be determined using a mathematical procedure. The time ( $T$ ) in hours after burst when fallout will be completed at any specific point is approximately 1.25 times the time of arrival (in hours after burst). Add the time in hours required for the nuclear cloud to pass over.

This is expressed by using the formula:

$$T_{comp} = 1.25 \times T_{arrival} + \frac{\text{cloud diameter}}{\text{effective wind speed}}$$

Example: For a given location, the following data has been determined—

- Time arrival =  $H + 2$  hours

(Determined by dividing the distance from GZ to the given point by the effective wind speed.)

- Cloud diameter = 4 km

(Determined from the radioactive cloud and stem parameters nomogram in Figure 5-9, next page. (Lineup yield on both sides—read cloud radius-multiply by 2).)

- Effective wind speed = 20 kmph

(Determined from line Zulu of the NBC 3 report.)

Apply the formula to this data as follows:

$$T_{comp} = 1.25 \times 2hr + \frac{4 \text{ hr}}{20 \text{ kmph}} = 2.5 + .2 = H + 2.7hr$$

**Note:** To convert 2.7 hours into clock time, multiply .7 by 60. The product in this example is 42. Therefore,  $T_{comp}$  is 2 hours and 42 minutes.

Thus, fallout for the given location is expected to be complete by  $H + 2.7$  hours, or  $H + 2$  hours and 42

minutes. Actual completion of fallout can be determined if a peak NBC 4 nuclear report is received from the area of interest.

Dose-rate information from an aerial survey using the route or course leg technique is processed into normalized ground dose rates that existed at certain points along the route. To plot this information—

- Before receiving the dose-rate information, mark and label the checkpoints for the route or course leg on the worksheet overlay. Trace out the preselected route or course leg that the survey party actually traveled.
- After the survey data is received, count the number of readings taken for the route or leg. The number of time intervals used during the flight is required, so be sure to include all readings, including zero readings. Since the aircraft flew at a constant ground speed, taking readings at equal time intervals, the distance covered between any two consecutive readings will be the same. If the route or leg is divided into a number of equal length segments, the total number of segments will equal the number of time intervals. Each division point on the route or leg will represent a location over which a dose rate reading was taken. The interval between readings equals the length of the course leg or route divided by the number of readings minus one.

For example—Figure 5-10 shows the points along route over which readings were taken. In this case, seven readings were taken (#1—#7); but the route is divided into only six segments (A—F)—one less than the number of readings taken by the survey party. The formula is—

$$\text{interval distance} = \frac{\text{route or course leg distance (km)}}{\text{number of readings} - 1}$$

As the dose-rate readings are processed, post the normalized dose rates to the worksheet overlay besides the location point for the route,

Dose-rate information from an aerial survey conducted using course legs is plotted basically the same as the aerial route technique.

**RADIOACTIVE CLOUD AND STEM PARAMETERS  
(STABILIZED AT H + 10 MINUTES)**

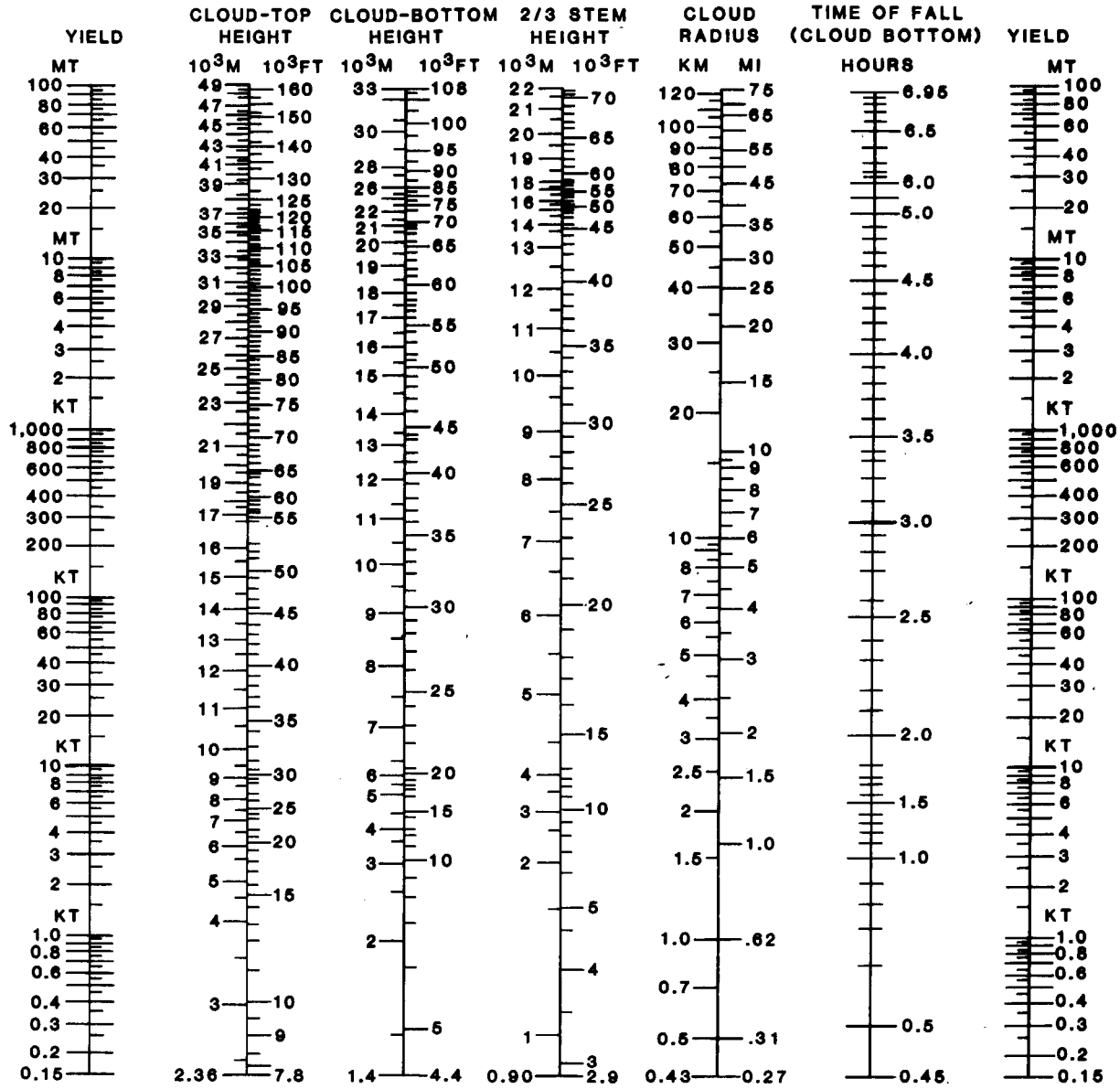

Figure 5-9. Radioactive cloud and stem parameters nomogram.

## Contour Line Plotting

Once we have the information gathered by the survey team or individual monitor, as presented in the NBC 4 report, normalized H + 1 (R.) readings, the data may be plotted on the situation map (Figure 5-11, Part 1, next page). Draw a contour line connecting all 20-cGyph or near-20-cGyph readings (Figure 5-11, Part 2, next page). This contour line should be black. Use a contour line of 30 cGyph for NATO use. Label this contour line and mark GZ with a "+."

When constructing the radiological contamination overlay, there are factors that locally affect the contamination pattern. This is particularly true between points in an aerial survey. These include terrain features, such as bluffs or cuts, heavily built-up or wooded areas, and bodies of water. For example, a large river will carry away any fallout landing in it, leaving its path relatively free of contamination. Also, the contamination hazard near a lake will be lower than expected. The fallout particles will sink to the bottom of the lake and the water will provide shielding. In wooded areas or built-up areas, a measure of the reduction of dose rate can be obtained by using the transmission factors (see Table 6-1) for these areas.

Draw a contour line connecting all readings of 100 cGyph or near 100 cGyph (Figure 5-11, Part 3, page 5-19). Label this line 100 cGyph. For colored overlays, this contour line should be blue. Using lines Whiskey and Xray, record this overlay or plot information as an NBC 5 nuclear report.

Higher readings probably would be present (300-1,000 cGyph); but for this example, only plot the readings shown in Figure 5-11 (pages 5-18 and 5-19).

The following NBC 5 report supports the overlay in Figure 5-11:

Priority  
 261840 local  
 Unclass  
 NBC 5 Nuclear  
 A 25  
 F NB201251  
 R 1.2  
 T 261600 Zulu  
 W NB195250; NB204270; NB206290;  
 NB209269; NB195250  
 X NB200241; NB216264; NB224285;  
 NB217302; NB200303; NB196285;  
 NB191250; NB200241

The NBC 5 report states where the contamination is and at what dose rate—unlike the NBC 2 or 3, which reports where the contamination is expected or predicted to land. This gives the ground commander information required to plan operations, while limiting or avoiding radiation exposure.

Dose-rate contour lines showing the contamination hazard in an area can be drawn when all the dose-rate information in the area is posted. To do this—

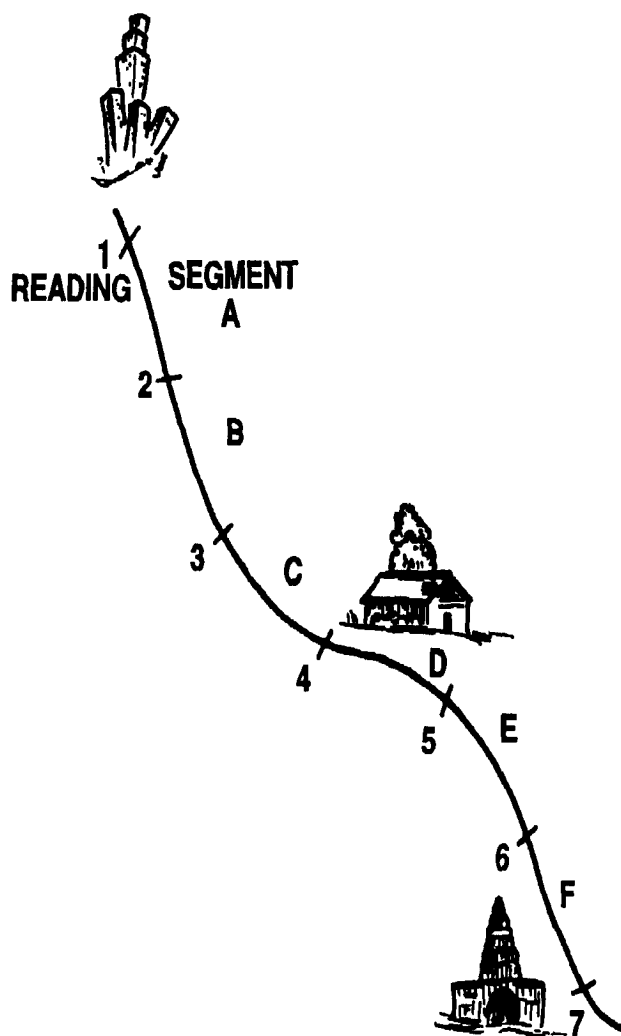

Figure 5-10. Plotting of aerial survey route.

- Determine the H + 1 dose-rate contour lines to be plotted (for example, 30, 100, 300, 1000 cGyph). These contour lines may be required for NBC 5 purposes or for anticipated calculations to be made from the data.
- Determine the points along the various survey routes, course legs, and near monitoring locations where the desired dose rates are located. Mathematically estimate between dose rates, if necessary.
- Connect with a smooth line all the points having the same dose rates. Use all plotted monitoring data as additional guides in constructing these contours.

The plotter must use care and judgment in plotting these contours and must visualize the probable general shape and direction of the pattern. Any dose rates disproportionately higher than other readings in the immediate area indicate possible hot spots. When such readings are reported, that area should be rechecked. If dose rates are confirmed, these hot spots should be plotted and clearly identified.

Plotted contours may be extended to downwind areas where fallout has not arrived. The contours may be extended if necessary to complete the fallout pattern. As

peak reports or surveys are submitted from downwind locations, the pattern is altered accordingly and thus kept up to date. Figure 5-12, next page, shows a typical plot that might be developed from survey data.

Radiological contamination overlays used for evaluation must provide the most detailed information possible. The minimum information required is—

- Map designation and orientation data.
- Nuclear burst and GZ identification.
- H-hour.
- Reference time.
- Decay rate/soil type.
- Time-of preparation and validity time.
- Source of the contamination-fallout or neutron-induced contamination.
- Militarily significant contamination perimeters—
  - New fallout (H-hour to H + 48 hours)—20 cGyph at H + 1 for short-term (24-hour) occupancy, 10 cGyph at H + 1, if longer occupancy of a contaminated area is expected.
  - Old fallout (H + 48 hours)—1 cGyph at the time of preparation.
  - Neutron-induced contamination—2 cGyph at H + 1 hour.
- Dose-rate, information-contour lines and key dose rates, if possible.

Additional information that is desirable but not essential—

- Time-of-completion lines for fallout.
  - Dose at reference time for key crossings or probable stay times.
- The preferred method for transmitting a radiological contamination overlay is by facsimile channels of electrical communications. It is fast and accurate. Facsimile devices normally are available at battalion and higher headquarters. Three devices are used to transmit contamination overlays to lateral and higher commands. When liaison or messenger service is not available, the information can be sent as an NBC 5 nuclear report.

### Reporting Data

Facsimile channels of electrical communications are not always available. If this is the case, the radiological contamination overlay must be converted into a series of readings and coordinates for transmission as an NBC 5 nuclear report. From the division NBCC the readings should be transmitted to the three brigades; the division artillery; the armored cavalry squadron, the aviation, signal, and engineer battalions; the chemical company; the MP company; the support command and attached units; and any other units designated by the commander. This method has a disadvantage. It requires the addressee to replot data from the NBC 5 nuclear report and draw dose-rate contours, a time-consuming process. Staff planners must consider that the shapes of dose-rate

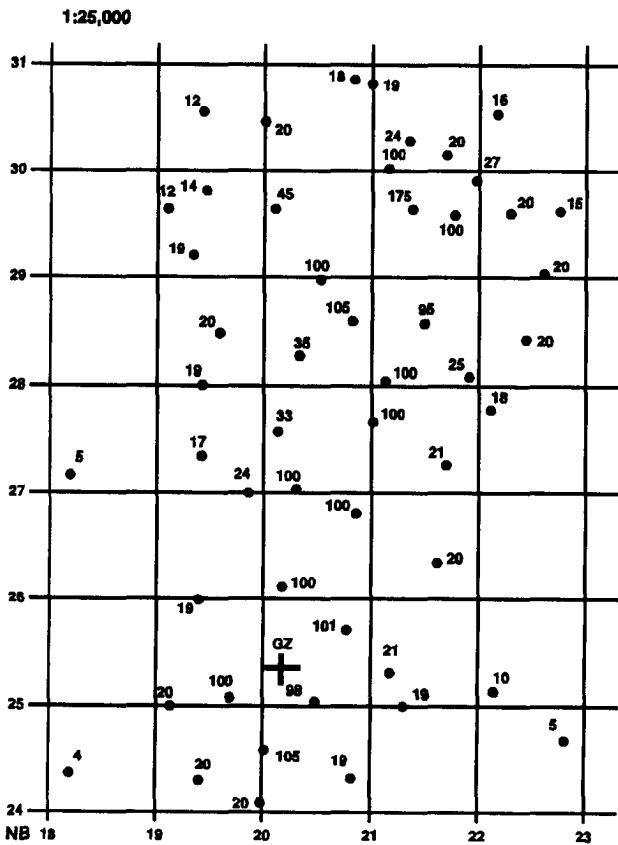

Figure 5-11 (Part 1 of 4).  
Plotting NBC 4 nuclear report readings.

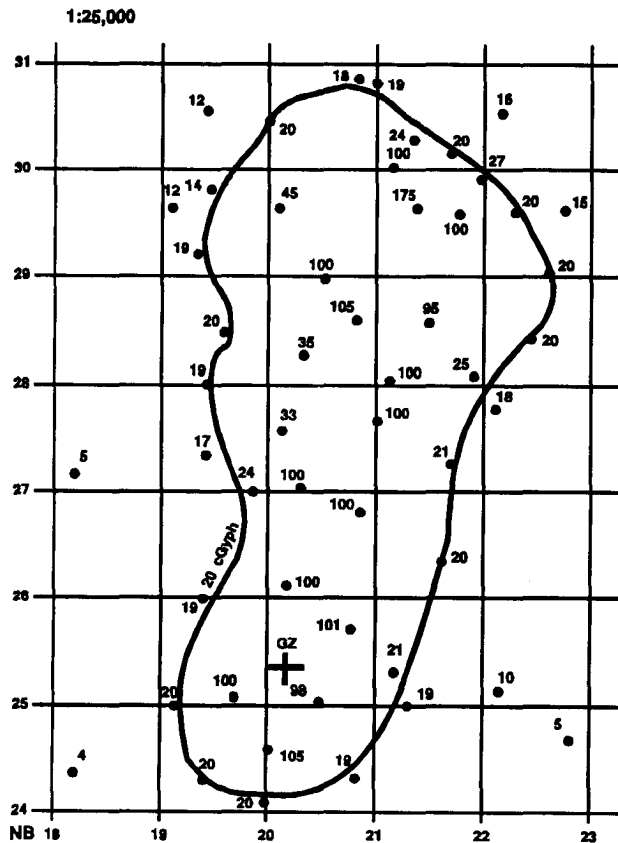

Figure 5-11 (Part 2 of 4). Plotting NBC nuclear 4 report readings—20-cGyph readings connected.

contours drawn to correspond with a relatively brief series of readings and coordinates can vary significantly.

If electrical communications for hard copy are not available and if time and distance permit, radiological contamination overlays are sent by messenger. Data is transmitted by the NBC 5 nuclear report as a last resort.

When the contamination comes from a single burst, the dose rates will be normalized to H + 1. But if there have been several detonations at different times and no single H + 1 is possible, the dose rates are reported for a specific time. Line item Oscar is used instead of line item Tango on the NBC 5 nuclear report.

It is not necessary or even desirable to report all four line items (Uniform, Victor, Whiskey, and Xray) on the NBC 5 nuclear report. Four lines have been provided for flexibility. Line item Xray should always be sent for avoidance purposes.

On the NBC 5 nuclear report, coordinates are listed sequentially around the contour. A contour line that completes a plot is represented by repeating the first coordinate. NBC 5 nuclear reports having incomplete contours are sent in sequence, with the first and last coordinate different, indicating the break in the contour.

Report the decay rate on line Romeo. Users of the NBC 5 nuclear report are not confined to predetermined lines. Any line described in Chapter 2 may be added.

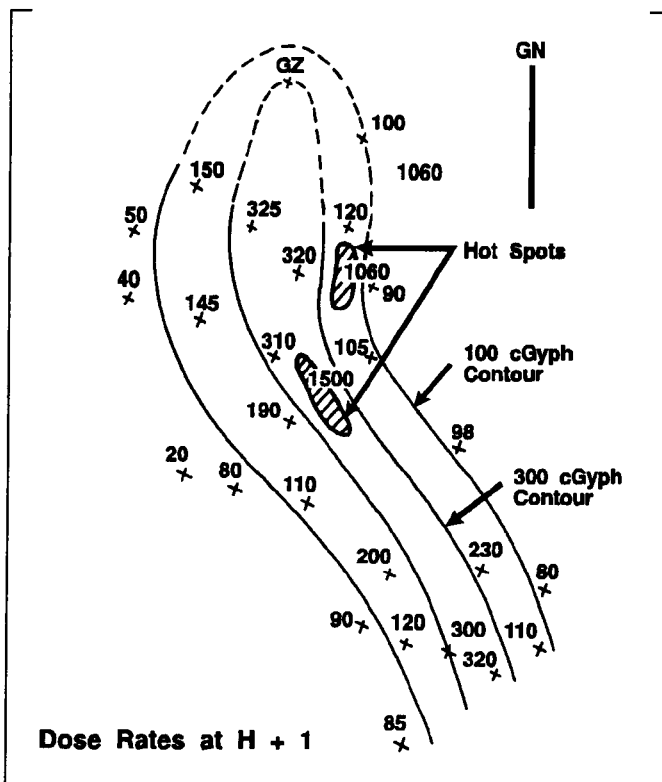

Figure 5-12. Example of fallout pattern plotted from survey data.

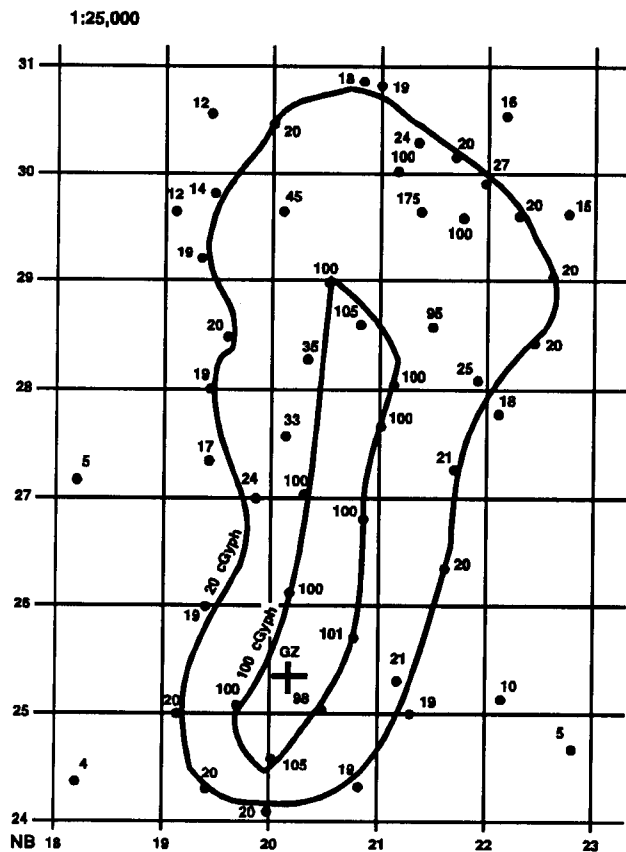

Figure 5-11 (Part 3 of 4). Plotting NBC 4 nuclear report readings—100-cGyph contour line.

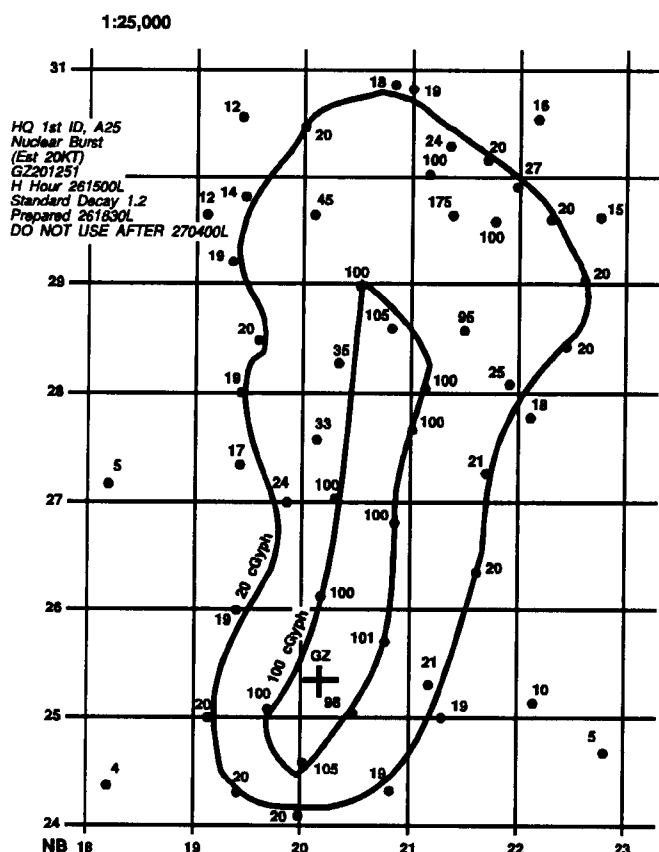

Figure 5-11 (Part 4 of 4). Completed NBC 4 nuclear report, including marginal information.

### Evaluation Contamination Overlays

Figure 5-13 (next page) illustrates an evaluation contamination plot showing H + 1 dose rates. The H + 1 dose rate plot is the beginning point for developing a plot that will show the contaminated area shrinking. The first step is to determine what is to be illustrated. An examination of Figure 5-14, page 5-22, reveals the 30- and 100-cGyph contour lines have been shown at H + 7 and H + 11. The 10-cGyph contour line has been shown at H + 1, H + 7, and H + 11. H + 11 is the latest time, because it equals the do-not-use-after date-time group 171600Z.

Since a dose rate at H + 1 will decay to a lesser value, a decay nomogram must be used. Thus, the solution involves solving for a higher dose rate that will decay to the preselected dose rate at the specified time. The selected dose rates are diagramed below for clarity:

R	t	R <sub>1</sub>	n=1.2
10	7		
10	11		
30	7		
30	11		
10	7		
100	11		

Use of then = 1.2 decay nomogram results in—

R	t	R <sub>1</sub>	n = 1.2
10	7	103	
10	11	170	
30	7	300	
30	11	325	
100	7	1,000	
100	11	1,700	

The next step is to return to the H + 1 dose-rate plot and mathematically estimate these dose rates. Place a piece of transparent material over the H + 1 plot and trace the estimated dose rate contour lines. Label each contour line with dose rate and time. Thus, for 10 cGyph, three contour lines are drawn and labeled. Figure 5-14 (page 5-22) shows the process to this point.

Repeat the process for the 100- and 300-cGyph contour lines. Note that the NBC 5 nuclear report cannot be used to disseminate this plot.

A contamination overlay prepared for estimation purposes, showing total dose areas for various times of stay, is in Figure 5-15 (page 5-23). This plot shows the consequence of occupying or crossing the area. The plot assists in planning future operations and goes to the staffs and down to battalion commander. (See Figure 5-16, page 5-24.) The plot is marked in color or contrasting patterns to identify hazard areas.

Again, Figure 5-15 is used as the start point along with guidance concerning the times of entry and times of stay. For Figure 5-15, a time of entry of H + 7 was used for all calculations. Time of stay was selected as 1, 2, 3, and 4 hours. Note that the plot is divided into four areas-A, B, C, and D.

The maximum H + 1 (R<sub>1</sub>) dose rate encountered in each of the areas is used as part of the dose calculations. A diagram of the data is shown in Figure 5-17 (page 5-25).

Using the n = 1.2 total dose nomogram, the solution is shown as the inset to Figure 5-15 (page 5-23).

Total dose calculations should not be projected beyond the do-not-use-after date-time group. In the above example, entry is H + 7, and maximum stay time is four hours. Thus, time of exit is H + 11. Note that neither the plot nor the data can be sent in an NBC 5 nuclear report.

### Estimation Contamination Overlays

A radiological contamination overlay prepared for estimation purposes does not lend itself to briefings and similar requirements. A briefing requires a presentation of the current radiological contamination picture that lets the viewer picture the current hazard and the decay of the hazard over a short period (three to six hours). This type of presentation is of particular use for staff analysis of the area, and for rapid visualization of the contamination hazard.

A contamination overlay showing dose rates for estimation purposes, is shown in Figure 5-14 (page 5-22). The overlay attempts to show a shrinking contaminated area. This may be done by color contrast, overlay flips, or the use of dashed, dotted, and solid lines.

### Aerial Survey Team Actions

The NBC defense team has ready access to the latest information available concerning the survey area. The defense team provides this information to the survey team at a briefing. In addition to information about the contaminated area, the defense team provides the aerial survey team with the identification of the course legs or routes to be flown, the tentative survey height, and the approximate times during which groups of the course legs or routes are to be flown. The unit NBC defense team will furnish the survey team with the operation exposure guidance and the turnback dose. For an explanation of turn-back dose rate (D<sub>tb</sub>) refer to Appendix A.

The aerial survey party determines, as applicable—

- Actual height above ground at which each course leg or route is to be flown.
- Ground speed for each course leg or route.
- Direction of flight for each course leg or route.
- Locations for determining AGCF data.
- Time intervals between readings.
- Whether to delay the flight of a particular course leg or route.

Upon arrival over the contaminated area, the survey team has several decisions to make before the actual survey begins. Four of these decisions and a discussion of each follow:

*Direction of flight for each course leg or route.* Factors that could influence this decision include weather, sun glare, fuel economy, the aircraft's duration of flight, and completion of fallout.

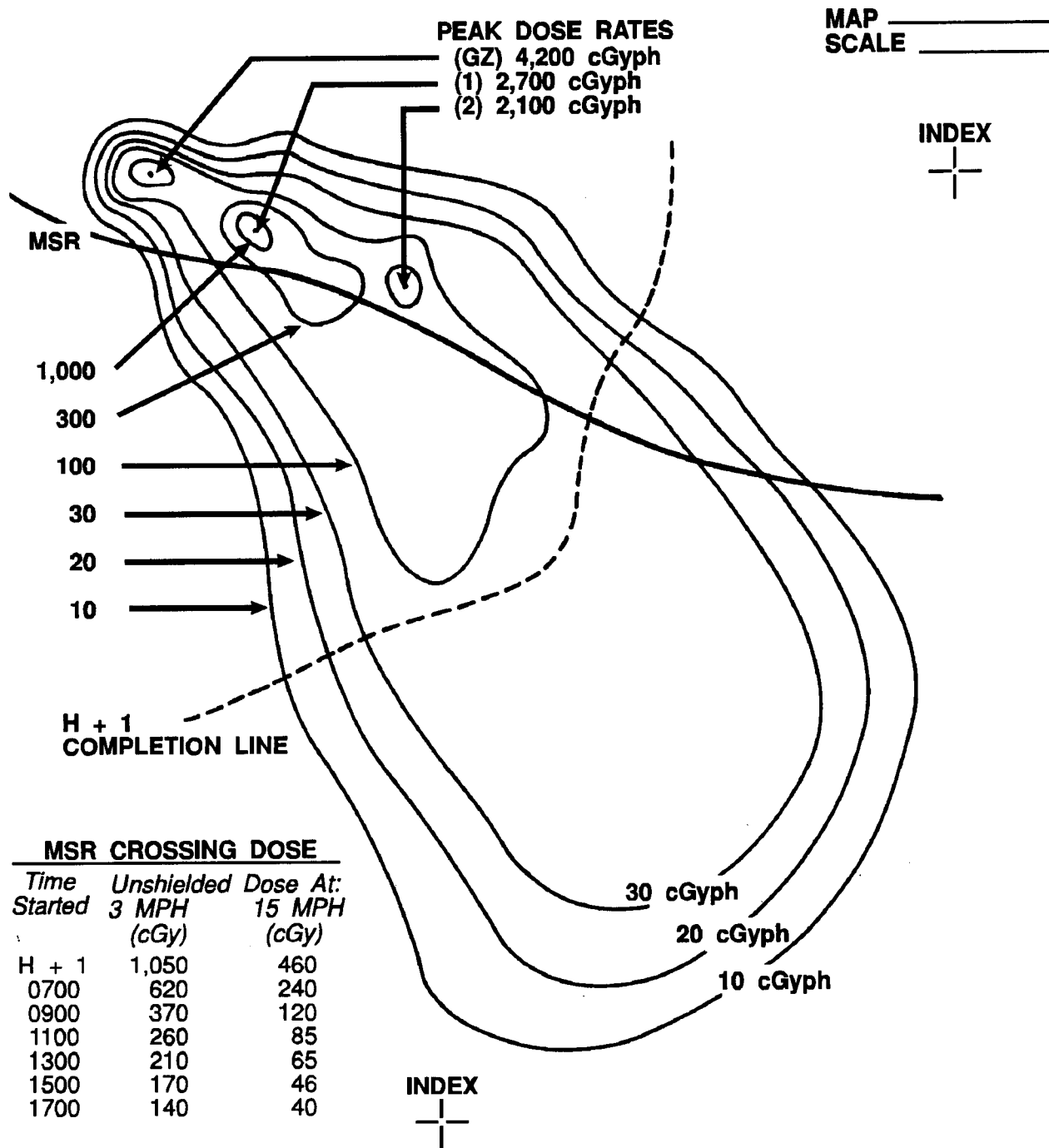

HQ...Inf Div  
 Nuclear Burst (30 KT)  
 GZ MN671355  
 H-hour 170500Z  
 Reference Time H + 1 (0600)  
 Standard Decay (n = 1.2)  
 Prepared 171000Z  
 DO NOT USE AFTER 191000Z

All Fallout Completed by  
 H + 2 Hours (0700)

All Dose and Dose-rate Data  
 are as of H + 1 (170600Z)  
 Unless Otherwise Specified

Figure 5-13. Evaluation-type nuclear contamination overlay.

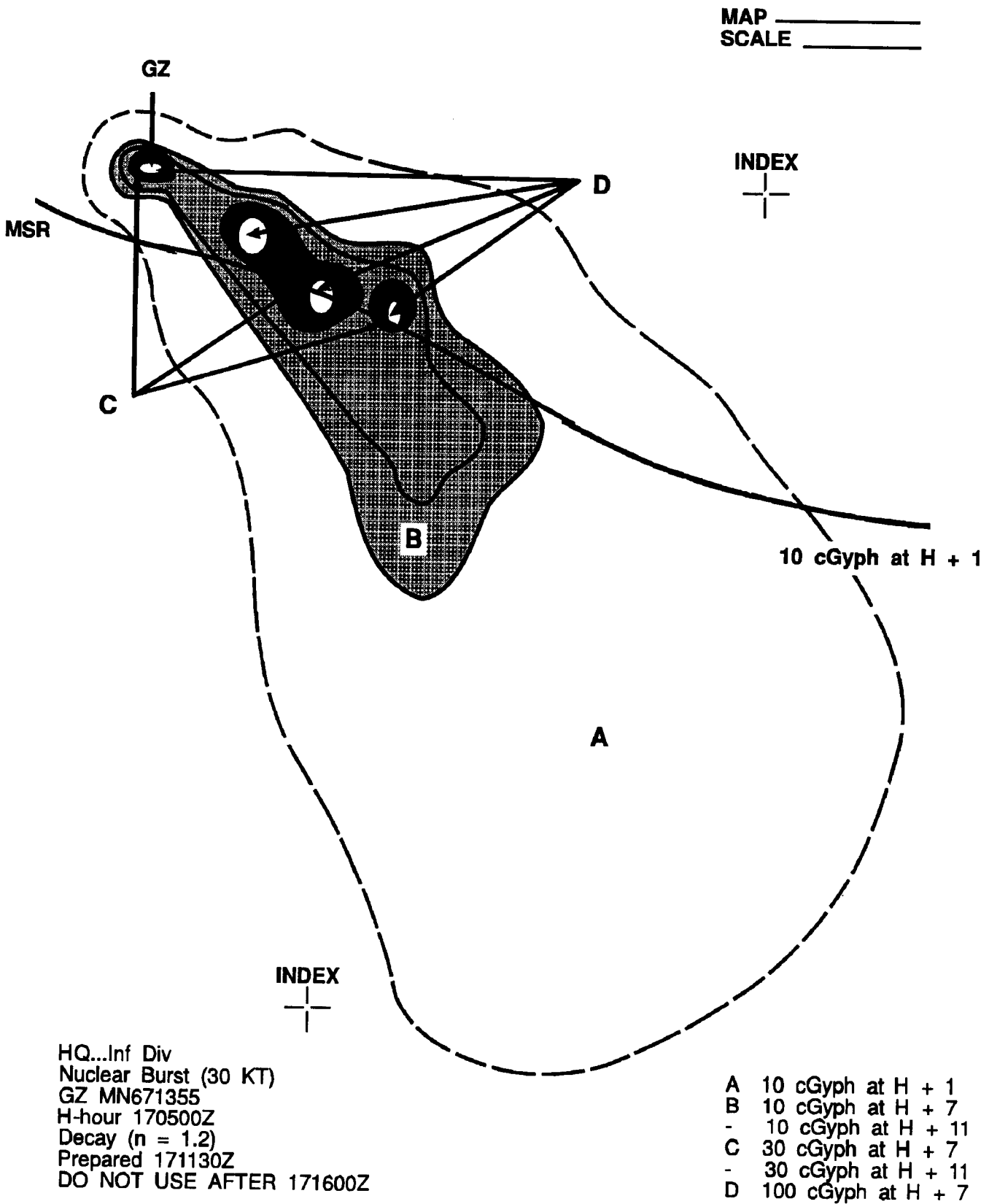
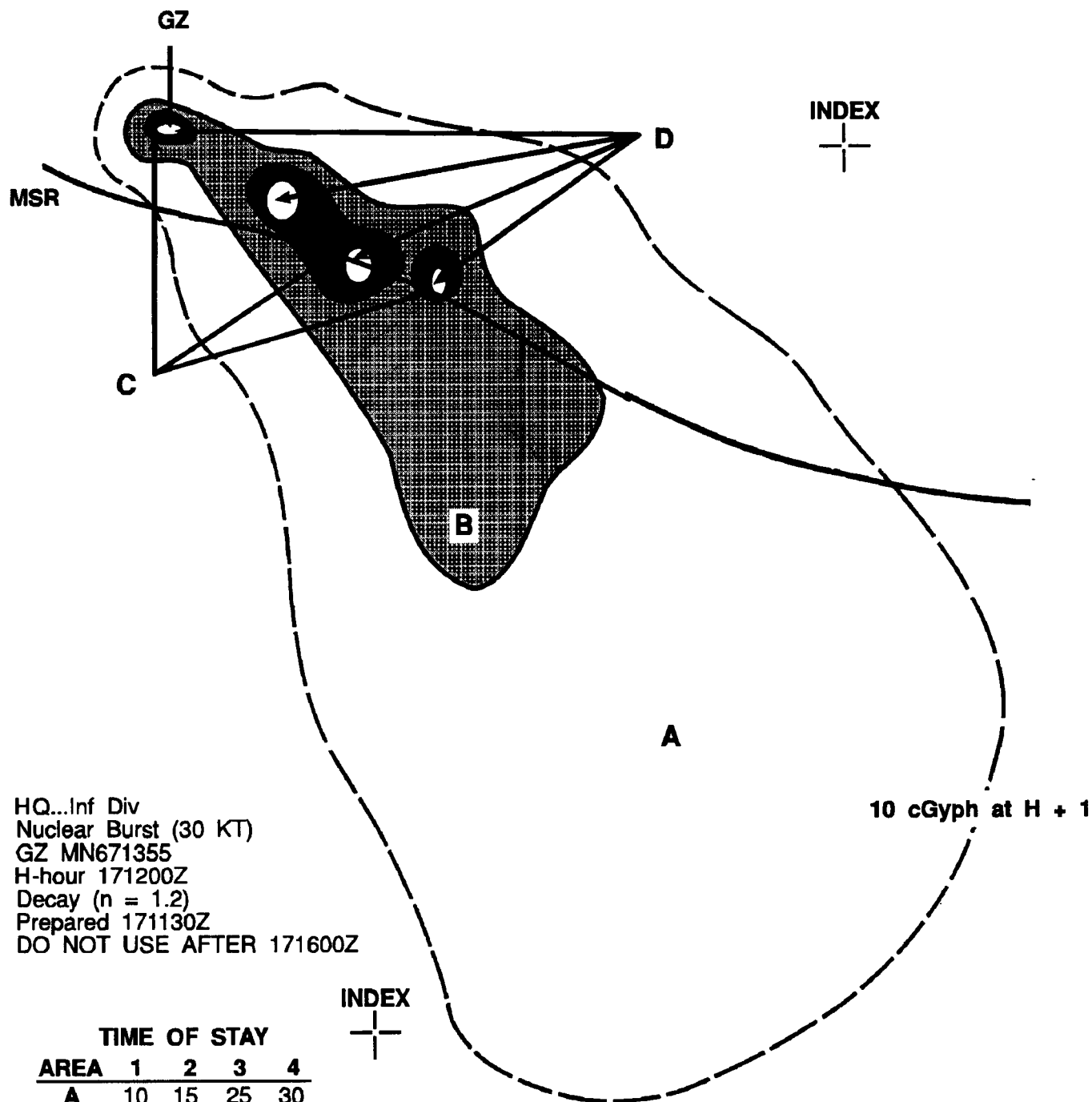

Figure 5-14. Current estimated radiological contamination overlay (dose rate).



MAP \_\_\_\_\_  
 SCALE \_\_\_\_\_



HQ...Inf Div  
 Nuclear Burst (30 KT)  
 GZ MN671355  
 H-hour 171200Z  
 Decay (n = 1.2)  
 Prepared 171130Z  
 DO NOT USE AFTER 171600Z

AREA	TIME OF STAY			
	1	2	3	4
A	10	15	25	30
B	25	50	70	85
C	90	165	240	290
D	180	335	460	580

$T_e = H + 7$  (Dose rounded to nearest 5 centigray)

Figure 5-15. Sample evaluation-type nuclear contamination overlay.

MAP \_\_\_\_\_  
SCALE \_\_\_\_\_

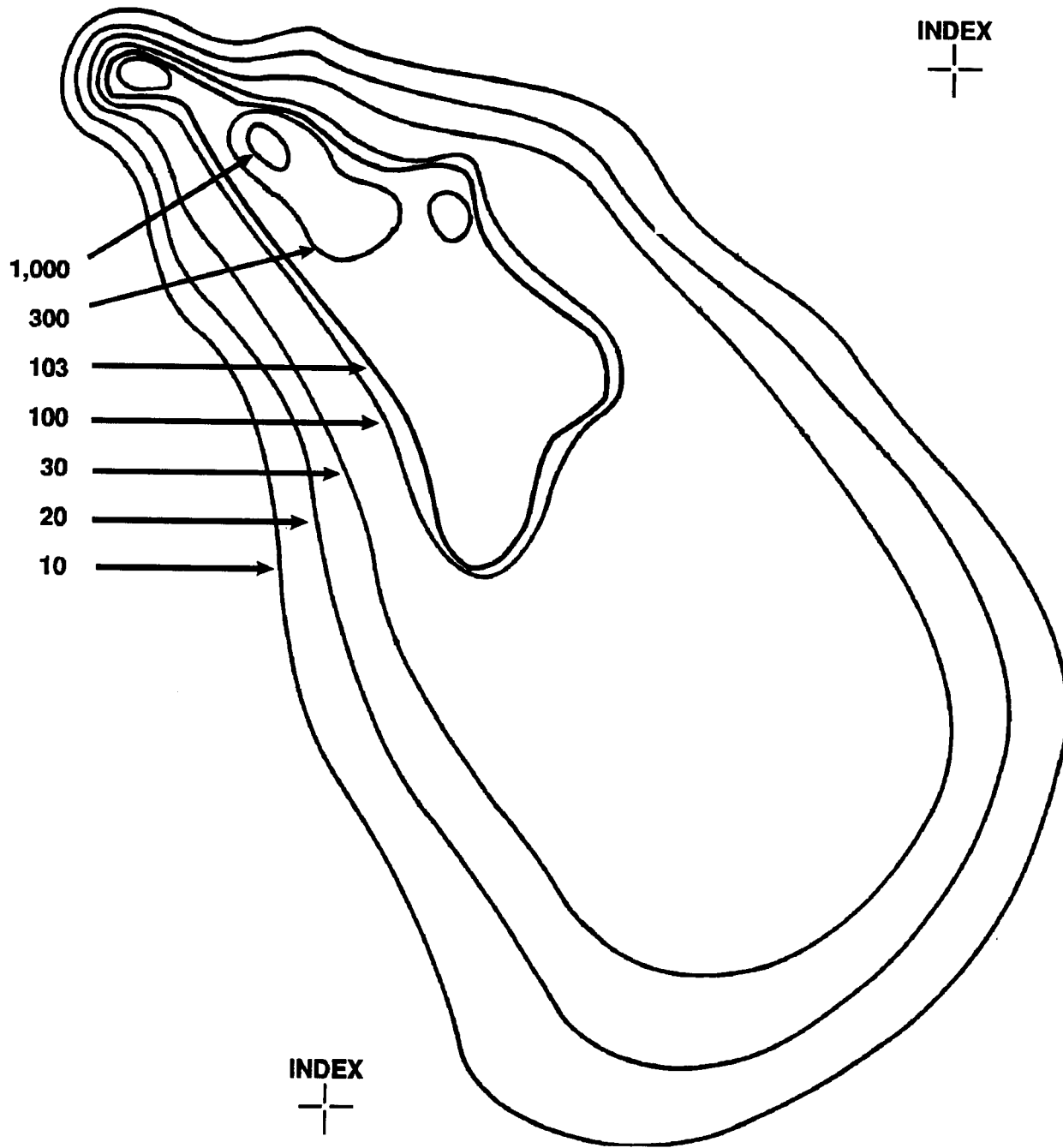

*Figure 5-16. Sample estimated radiological contamination overlay (dose rate).*

Actual height above ground at which course leg or route is to be flown. The NBCC will provide tentative guidance on survey height. Survey data obtained at heights above 500 feet above ground level (AGL) (150 meters) is unreliable. A height of 200 feet AGL (60 meters) is considered optimum. Actual survey height calculation is done by the team. To do this, the team makes an initial pass over the fallout area along a course leg at 1,000 feet. The monitor observes the radiacmeter and notes the highest dose rate at that height. The monitor multiplies this dose rate by the AGCF for this height—found in Table 5-3 (page 5-14). After the ground dose rate is found, consult Table 5-3 again. This time the monitor looks for an AGCF which, when divided into the ground dose area will result in a dose rate that can be easily read on the instrument. For example, the highest dose rate noted over a course leg at 200 feet was 30 cGyph. The AGCF from Table 5-3 for this height is 3.2. This results in 96 cGyph at 1 meter above the ground:

$$\begin{aligned}
 OD &= ID \times AGCF \\
 &= 30 \times 3.2 \\
 &= 96 \text{ cGyph}
 \end{aligned}$$

Next, the monitor selects a higher altitude that will give a lower dose rate reading on the instrument. The monitor confirms this selection by dividing the AGCF for that height into the ground dose rate. To continue the example, if the monitor selected a height of 400 feet, the AGCF would be 6.2. When this is divided into the ground dose rate, the highest dose rate the monitor will read on this course leg is 15 cGyph:

$$ID = \frac{OD}{AGCF} = \frac{96}{6.2} = 15.48 \text{ or } 15 \text{ cGyph}$$

Data for Table 5-3 was developed from Cobalt-60. Use of the data provides a good estimate. In actual fallout situations, the NBCC will task survey teams to determine raw data for an actual table of fallout data. After the actual AGCF table has been determined, it is used in place of Table 5-3. The calculation technique described above will be valid for the actual fallout data. Survey heights are

expressed in feet when working with US aircraft—US altimeters are graduated in feet. Most NATO aircraft use meters.

**Ground speed for each course leg or route.** The slower the aircraft speed and the shorter the time between readings, the more accurate the results. The NBCC will provide general guidance on distance between readings for certain high-interest areas. These may be areas near GZ or in areas a unit is required to occupy. Final selection of speed and interval is the judgment of the survey team. The maximum acceptable interval between readings is 500 meters. The slow response time of the IM174()/PD family of radiacmeters reduces reliability of the data obtained at ground speeds above 53 knots (98 kilometers per hour).

For best plotting accuracy, at least 10 readings between checkpoints is required. Table 5-4 (next page) shows all practical combinations of speed and time intervals. Inspection of Table 5-4 reveals that any combination of speed less than 53 knots and 15-second time interval will yield a distance between readings of less than 500 meters.

**Locations for determination of AGCF data.** The NBCC provides recommendations on locations during the survey briefing. The team makes the final selection of sites based upon several factors. These factors are average foliage and ground conditions, dose rates, and number of course legs or routes to be surveyed. AGCF dose rates should be taken where they can be read on the low end of the scale of the radiacmeter (1 to 10 cGyph). This ensures accuracy. The aerial dose-rate portion of AGCF data must be taken at the survey height for the course leg or route. Actual determination of ground dose rate for the AGCF requires the aircraft to land near the point of interest. The monitor dismounts, proceeds to the selected point, and takes the reading by using normal ground monitoring techniques.

The survey team must determine new AGCF data for every two to four course legs or routes flown, when average surface conditions change (for example, from an area with little snow to a lot of snow coverage or from an area with much standing water to an area with little or no standing water), when terrain conditions change (from hilly areas to flat lands), and when average foliage conditions change (for example, from wooded areas to open areas or from grasslands to wooded areas). Selected sites for AGCF data must approximate the survey area.

New data must be obtained when survey height changes by 15 meters or more, when ground foliage or average ground surface conditions change significantly, if the aircraft or the survey meter is changed, or if weather conditions change drastically during monitoring.

Ground survey involves considerably less planning or action on the part of the survey team. Essentially, the team follows the instructions given during the survey briefing.

Area A				Area B			
D	R <sub>1</sub>	T <sub>s</sub>	T <sub>e</sub>	D	R <sub>1</sub>	T <sub>s</sub>	T <sub>e</sub>
	100	1	7		300	1	7
	100	2	7		300	2	7
	100	3	7		300	3	7
	100	4	7		300	4	7
Area C				Area D			
D	R <sub>1</sub>	T <sub>s</sub>	T <sub>e</sub>	D	R <sub>1</sub>	T <sub>s</sub>	T <sub>e</sub>
	1,000	1	7		2,000	1	7
	1,000	2	7		2,000	2	7
	1,000	3	7		2,000	3	7
	1,000	4	7		2,000	4	7

Figure 5-17. Total dose calculations.

### Recording and Reporting

The radiological data sheet is used for recording data obtained in aerial surveys. Data obtained using the route or course leg technique are recorded on DA Form 1971-1-R

**Table 5-4. Interval between aerial survey readings.**

Interval Table (Meters)													
Ground Speed		Time (Seconds) Between Readings											
Knots	Kmph	5	10	15	20	25	30	35	40	45	50	55	60
53	98	136	272	408									
51	95	132	264	396									
49	90	125	250	375	500								
46	85	118	236	354	472								
43	80	111	222	333	444								
40	75	104	208	312	416								
38	70	97	194	291	388	486							
35	65	90	180	270	361	451							
32	60	83	166	249	333	416	500						
30	55	76	152	229	305	382	458						
27	50	69	138	208	277	347	416	486					
24	45	63	125	188	250	313	375	438	500				
22	40	55	111	166	222	277	333	388	444	500			
19	35	48	97	146	194	243	291	340	388	437	486		
16	30	42	83	125	166	208	249	291	333	375	416	458	500

(Radiological Data Sheet-Monitoring or Point Technique). (See Figure 5-18, next page.) Data obtained by the point technique are recorded on DA Form 1971-R. Block headings are self-explanatory. Any headings not applicable to the situation are lined through by the monitor. Space is provided for use of the control team—the DO NOT USE\* blocks—for entry of the AGCF and normalized readings. The Remarks block is used by the monitor to provide any additional information of value to the unit NBC defense team. This block also is used by the defense

team to enter time of nuclear burst and computations of the AGCF, normalizing factor, and overall correction factor.

A radiological data sheet completed by the monitor and showing data collected by use of the course leg technique during aerial survey is shown in Figure 5-18.

Survey data is delivered to the defense team, upon completion of the survey, by physical drop, radio, or telephone from the nearest landing zone. The NBCC must specify in the survey briefing how this is to be done.

### Ground Survey

Ground radiological surveys are normally performed by personnel in M93 NBC reconnaissance systems (NBCRSs) or FOXs. Armored vehicles also may be used. These

vehicles reduce doses received by personnel and must be used whenever possible. Ground surveys lack the speed and flexibility of aerial surveys. They result in higher nuclear radiation doses to personnel, place larger load on communication facilities, and require division of more personnel and equipment from the mission. However, a ground survey is independent of weather conditions. It provides more accurate information than an aerial survey. All echelons can perform ground surveys within their areas of responsibility, using regularly assigned personnel and equipment.

The techniques used to conduct ground surveys include the route technique, the point technique, and the preselected dose-rate technique. For a detailed explanation on these techniques and specific movement formations to use while conducting ground surveys, refer to FM 3-19.

Most ground surveys are performed using the route technique. In this technique, dose-rate readings are taken inside the vehicle at selected intervals between checkpoints along a route. The unit defense team uses a correlation factor to determine ground dose rates. The dose rate information is then processed into normalized ground dose rates. The route, checkpoints, and interval are determined prior to the survey. The plotting procedure can be done before the survey information is received. To plot this information—

Radiological Data Sheet - <del>Route or</del> Course Leg Technique (Ground and Aerial Survey)					Date	Page No.	No. of Pages						
For use of this form, see FM 3-3-1; the proponent agency is TRADOC.					20 JULY	1	1						
Survey Party Designation B-2-9				Monitor (Print Name) PFC FARES									
Map Used BIERHOFFEN 1:50,000		Aircraft or Vehicle Type UH-1		Instrument Type AN/VDR-2									
<del>Route or</del> Course Leg Designation		CK-CE	CE-CB	CB-CD									
Time at Start of Leg or <del>Route</del>		0950Z	0955Z	1005Z									
<del>Time Route Completed (for Ground)</del> or Survey Height (for Aerial)		200 FT	200 FT	200 FT									
<del>Distance or</del> Time Interval Used		10 SEC	10 SEC	10 SEC									
Remarks: TIME OF BURST 200730Z N = 1.2 CK-CE = AGCF = 3.8 NR = 2.767 OCF = 10.515 CE-CB = AGCF = 3.8 NR = 2.884 OCF = 10.959 CB-CD = AGCF = 3.8 NR = 3.123 OCF = 11.867  * Times of start and stop are reported for each route or portion of route completed at one time by ground survey. If a route is done in parts, use a separate column for each part. ** Do Not Use - for control party use only.					Reading No.	Dose Rate (cGyph)	Do Not Use**	Reading No.	Dose Rate (cGyph)	Do Not Use**	Reading No.	Dose Rate (cGyph)	Do Not Use**
					1	12	126	1	2	22	1	0	0
					2	12	126	2	2	22	2	0	0
					3	11	116	3	2	22	3	1	12
					4	10	105	4	3	33	4	2	24
					5	9	95	5	3	33	5	3	36
					6	8	84	6	3	33	6	3	36
					7	7	74	7	3	33	7	3	36
					8	6	63	8	4	44	8	3	36
					9	5	53	9	4	44	9	2	24
					10	5	53	10	5	55	10	1	12
					11	5	53	11	5	55	11	1	12
					Air-Ground or Vehicle Correlation Factor Data					12	4	42	12
13	4	42	13								13		
14	4	42	14								14		
15	3	32	15								15		
Location	Height (Feet) (Air Only)	Dose Rate (cGyph)		CF**	16	3	32	16			16		
		Inside Air	Outside Ground		17	2	21	17			17		
BF	200	5	19	3.8	18			18			18		
					19			19			19		
					20			20			20		

DA Form 1971-1-R, JAN 93

Figure 5-18. Example of DA Form 1971-1-R completed for course-leg survey.

- Mark and label the checkpoints on the worksheet overlay. Trace the preselected routes.
- Divide the route between checkpoints into the preselected intervals. Move in the same direction as that assigned the survey party.
- Enter the normalized ground dose rate beside the proper location as processed data is available on DA 1971-1-R.

In using the point technique, the ground dose rate is determined at a selected point. The reading is obtained by dismounting from the vehicle and taking a direct ground dose-rate reading or by taking the dose-rate reading inside the vehicle. For accuracy, the first method is preferred. If the dose rate is taken inside the vehicle, the ground dose rate will be determined by the unit NBC defense team by using a CF. When taking readings while dismounted, monitors should move at least 10 meters from the vehicle to take the readings. This prevents undue shielding of the radiation by the vehicle. Enter the normalized ground dose rates beside the proper location on the DA Form 1971-R.



With the preselected dose-rate technique, locations of preselected dose rates are determined along assigned routes. This technique normally is used only for resurveying old fallout contamination (after H + 48 hours) where the decay is very slow. Enter the normalized ground dose rates beside the proper location on the 1971-R.

Most dose-rate readings taken during a ground survey by mounted personnel using the route technique are taken inside the vehicle. These readings are converted later to ground dose rates by the NBCC. The survey meter should be located as indicated in Figure 5-1. If the vehicle being used is not listed in Figure 5-1, the survey meter should be held in a vertical position (face up) by the monitor sitting in the assistant driver's seat. The survey meter should remain in the same position for all the readings.

Correlation factor data are required to convert the reported readings taken inside the vehicle to ground dose rates outside the vehicle. Data for the vehicle CF are provided by the survey team. It consists of a set of two readings taken at the same location within three minutes of each other. One readings is taken inside the vehicle. All subsequent inside readings must be taken with the meter in the same position as the first. The other reading is taken immediately at the same location as a normal ground monitoring reading (the vehicle is pulled away at least 10 meters). Accuracy of the CF data is very important.

**Notes:** 1. Average ground survey vehicle speed is 15 miles per hour.

2. Use midtime for ground survey for NF calculation.

Record data obtained using the point or preselected dose rate technique on DA Form 1971-R. Record data obtained using the route technique on DA Form 1971-1-R. (See Appendix H for reproducible forms.)

Report survey data to the unit NBC defense team or the authority directing the survey as rapidly as possible. Intermediate headquarters do not screen or evaluate this data. The communications means and reporting procedure for the data are specified by the NBCC during the survey briefing. Careful consideration must be given to signal security SIGSEC and enemy electronic warfare (EW) capabilities.

Radiological survey information is of intelligence value to the enemy. Proper security procedures for the reporting of these data are established by the defense team. For example, location coordinates must be encoded if sent over unsecured nets, or sent clear text on secure land lines. The more detailed the briefing of the survey parties, the more easily security can be maintained.

## Reconnaissance

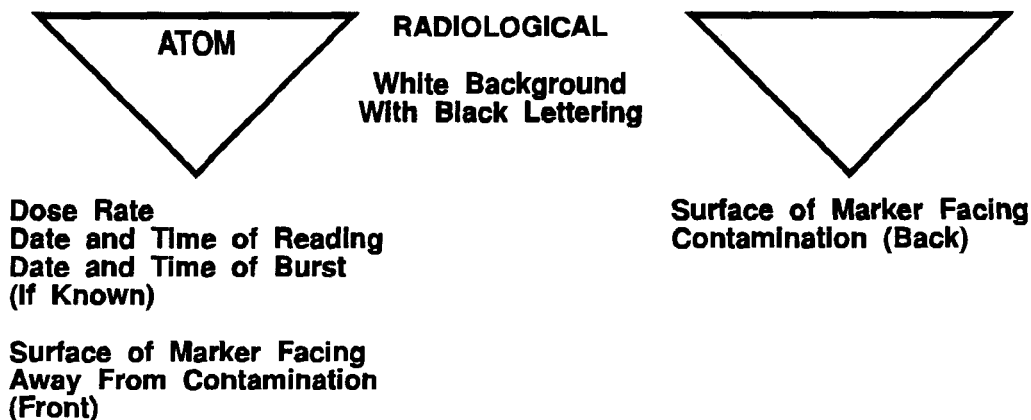

Figure 5-19. Nuclear contamination marking signs.

**FLAG CONTAINERS**

Each container holds 20 marking flags:

20 white flags for marking nuclear contamination.

20 blue flags for marking biological contamination.

20 yellow flags for marking chemical contamination.

**RIBBON CONTAINER**

Holds 13 separate rolls of yellow-marking ribbon.

Ribbon used to provide a way to hang flags between poles or other objects.

Carrying straps can be adjusted for front or back wear.

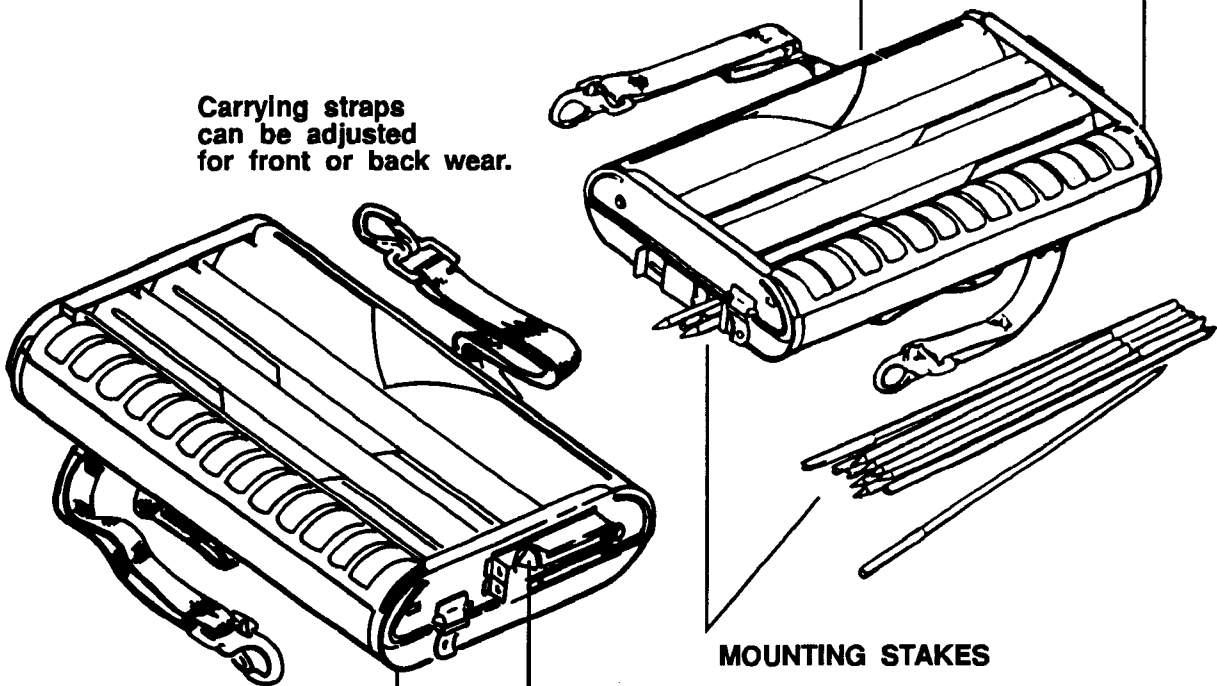

**CARRYING CONTAINER**

Holds all individual parts of set.

**MOUNTING STAKES**

48 stakes stored in bottom of carrying container.

Used to make poles for hanging flags and attaching marking ribbon.

**CRAYONS**

Red crayons used to mark information on flags.

*Figure 5-20. NBC contamination marking set.*

Radiological reconnaissance is the act of detecting the presence of radiation and measuring it with radiac instruments while moving. It is done before the main body of the unit encounters the hazard. Reconnaissance differs from monitoring and survey in that reconnaissance maybe used when—

- A maneuver unit is required to move through or occupy an area where the presence of NBC contamination is unknown.
- The boundaries of a known contaminated area must be determined.
- A clear route through or around a contaminated area is required.

This contamination could be the result of fallout, rainout, or neutron-induced contamination. Regardless of the source, recon concentrates on location rather than intensity or dose rate. Once plotted, recon data provides the minimum essential information needed to evaluate the impact the contamination will have on current operations. Stated another way, recon provides information about uncontaminated or clean areas. Recon, then, permits avoidance of hazard areas.

Often, contamination avoidance of radiological contamination is a matter of accepting the least amount of radiation rather than none at all.

Radiological recon may be performed on the ground or in the air. Ground radiological recon (GRR) is conducted by all units when moving. Aerial radiological recon (ARR) is conducted only when an area is known to be contaminated. The best vehicle available for GRR is the NBCRs, or, as it is more commonly called, the Fox. This vehicle is especially designed and equipped to operate in a contaminated environment and to perform NBC recon missions. The system has an added advantage in that the operator does not have to leave the vehicle to take a reading or sample. For more information concerning this vehicle, refer to FM 3-19 and the operator's manual.

Also, this vehicle gives a commander the ability to quickly determine the extent of contamination by using those techniques outlined in FM 3-19. Operators of this vehicle are also able to mark the contaminated area with the standard NATO NBC markers depicted in Figure 5-19, without leaving the vehicle.

If the unit does not have this vehicle, follow the procedures outlined next for contamination marking.

### **Contamination Marking**

Once contamination is found, mark the area and report to higher headquarters. Marking contaminated areas and equipment warns friendly units and helps them avoid the contamination. Marking a contaminated area merely indicates the presence of a hazard. The extent of a hazard is determined by a detailed survey.

### **Standard Signs**

Signs used for marking contaminated areas are standard throughout NATO in color and size. This permits easy identification. The color of the sign indicates the type of contamination. The primary or background color indicates the general type of hazard. The secondary color gives specifics as to what the hazard is.

In addition to color, signs are also a standard size and shape. The sign is a right-angled isosceles triangle. The base is approximately 28 centimeters (11-½ inches), and the sides are approximately 20 centimeters (8 inches). The signs can be made of wood, plastic, metal, or any other available material. Place each sign with the point of the triangle down.

For radiological contamination, you need the dose rate, date and time of reading, and date and time of detonation, if known.

US forces mark contaminated areas with the NBC contamination marking set. It contains everything needed to mark a contaminated area: flags, ribbon, crayons, mounting stakes, and a carrying container. TM 3-9905401-10 describes the kit and its use. Figure 5-20 (next page) shows the kit and its major components.

If units do not have this kit available, they can make the signs out of available metal, plastic, or wood. Field expedient signs must be of standard shapes, sizes, and colors.

### **Marking Procedures**

Marking warns friendly troops of contamination. Therefore, the signs are placed where they most likely will be encountered by friendly units. In rear areas the entire circumference of the hazard area may need to be marked. Individuals who find the contamination place the signs. They are placed where the contamination is detected. Adjacent signs should be within sight of each other (25 to 100 meters apart depending on terrain). This prevents units from missing the signs and entering a contaminated area. Recon elements mark the area at the point of entry. Unit survey teams are then responsible for determining and marking the extent of the contamination.

Some areas may contain more than one type of contamination or hazard. Mark these areas with the appropriate signs placed near each other. For example, if an area is both chemically and radiologically contaminated, both signs are used and placed near each other.

For rear areas in, around, and behind the division support area (DSA), and while in open terrain (desert, plains, rolling hills, etc.), it is possible to raise these contamination markers on poles. The poles may be camouflage support poles, extra tent poles, or any other such material. The intent is to raise the contamination marker up high enough so it can be seen for at least 200



meters. This is done so that follow-on forces and support troops can be aware of the hazard.

In these rear areas, clear areas or lanes also maybe marked for easy identification. One method of marking this lane is using the NBC contamination bypass marker depicted in figures 5-21 and 5-22 page 5-31.

Placing markers on poles or using the bypass marker in forward areas is considered tactically unsound and should be avoided. It would only provide a roadmap for the enemy.

**Marking Contaminated Materiel.** Special procedures are used when marking and handling contaminated materiel. Materiel is marked to keep personnel from accidentally becoming contaminated. This means that markers placed on materiel have to be visible from any angle. The disposition of the materiel depends on the situation. If it can be left in place to weather, that might be the best solution. If contaminated materiel is collected in a holding area, then the area has to be marked and monitored for residual hazards. Since vapor hazards are additive, several pieces of like contaminated equipment together could create a serious vapor hazard when located near each other. This could be a problem in areas such as maintenance holding areas.

Since residual hazards can collect in inaccessible places, contaminated vehicles and equipment must be marked or identified. Otherwise, maintenance personnel could be injured by hidden contamination. One way of doing this is to attach a marker to the outside of the vehicle.

**Radiological Procedures.** Radiological contamination marking signs are usually placed by unit recon teams. The signs are placed on principal routes of entry into the contaminated area where the dose rate is 1 cGyph at 1 meter above the ground. Signs are not placed in the interior portion of the area. This defeats the purpose of the warning. They are only placed on the perimeter of the area. Signs are moved periodically as the contamination decays.

If a military advantage will be lost by marking a contaminated area, the commander may order that the area not be marked. When this occurs, unit defense team personnel must be placed at principal entry points if the tactical situation permits.

Traffic control personnel normally are positioned so they can inform personnel entering the contaminated area about the extent of the hazard. Defense team personnel should not be positioned too near the contaminated area and they should wear a tactical dosimeter. Generally, they should not receive a dose greater than 1 cGy per day.

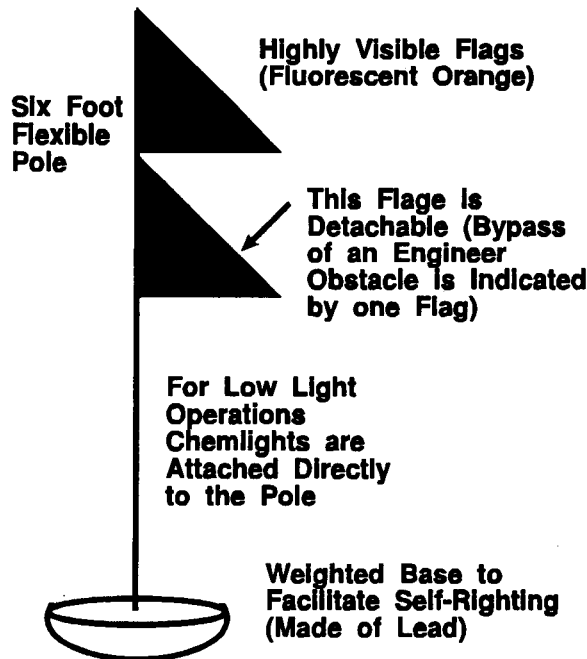

**BASIS OF ISSUE:**

- 6/Infantry, Scout, and Engineer Platoon
- 6/NBC Recon Vehicle
- 6/Smoke Generator and Decon Squad

Figure 5-21. Contamination bypass marker.

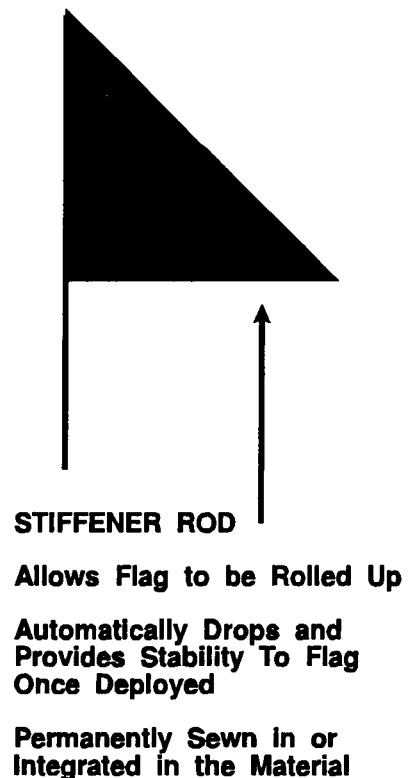

Figure 5-22. Contamination bypass marker flag.

### Vehicle Correlation Factor

In addition to the initial set of vehicle correlation factor (VCF) data, presented in Figure 5-1 and discussed earlier in this chapter, one or two additional sets of data should be taken at different locations so that the defense team can use an average VCF. Sites for obtaining VCF data should be selected to approximate average foliage and ground surface conditions for the contaminated area. New data must be obtained if these conditions change significantly or if the survey meter or vehicle is changed. Additional correlation factor data taken because of these changes should not be averaged into previously collected data, but should be used for applicable routes or points.

Meter readings for VCF data should be taken within three minutes of one another. Note that the monitor never calculates or applies the VCF to his data.

If the vehicle in question is equipped with the AN/VDR2 radiacmeter, this correlation factor is used and is referred to as the attenuation factor for this meter. Mounting instructions for the AN/VDR2 are in TM 11-6665-251-20.

### Unit Procedures

Unit involvement in radiological recon consists of GRR. The unit plots contamination locations for local use only. Units do not normalize GRR data; they are concerned with location, not amount.

Scouts and unit recon parties have principal missions of gathering information about specific facets of the battlefield. These missions could be bridge classification, fording locations, enemy strength and composition, or site evaluation for headquarters elements or other activities. GRR is an inherent part of this recon. On occasion GRR could be a principal mission. This would occur when contamination is known to exist.

The overall objective of the recon team is to locate a clean path or a path acceptable to the commander. The path may, however, be in another unit's area of operations. Use of this path would require approval from and coordination with higher headquarters. If a contaminated path in the unit's area that would result in low exposure to troops can be found, the commander may choose to use it. The amount of contamination that can be crossed safely is relative to the type of unit. An armor unit can safely cross an area with high dose rates; while a dismounted infantry unit must avoid such an area. Crossing should be done as quickly as possible to reduce stay time, but at an appropriate extended interval or slightly different parallel routes to minimize radioactive dust pick-up from traffic movement.

### Ground Radiological Recon

GRR is included in normal recon activities and provides the following:

- Warning of a hazard that otherwise might go undetected. Thus, GRR alerts units on the move when they contact a contaminated area.
- Information to the unit commander about the extent or size of the hazard just encountered.
- Information to the unit commander about the location of clean or uncontaminated areas.
- Information about routes that can be used to avoid the contaminated area. If total avoidance cannot be accomplished, GRR may be able to determine the lowest dose-rate route to be used while crossing the area.

**Attack Indications.** When reconnoitering for a radiological hazard, the team surveys the surroundings for indications of the reason for its existence and additional damage or obstacle indications. Some indicators areas follows—

- Arrival and settling of dust-like particles.
- Tree blowdown.
- Scorching on one side of an object.
- Overturned objects.
- Evidence of treetop fires.
- Dead animals and birds.
- Rain or snow after an airburst occurs.

**Radiological Samples.** When directed, the GRR team takes samples of the contamination. This sampling is required when the dose rate or decay rate is unpredictable. Samples are taken in low dose rate areas. These samples

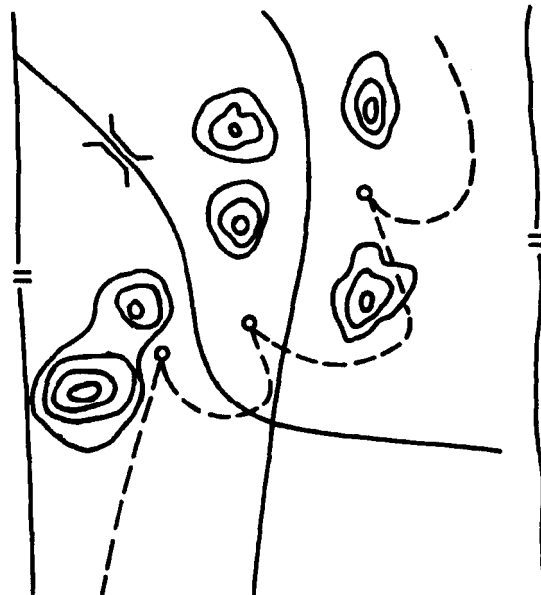

○ = RADIATION DETECTED

Figure 5-23. In-and-out recon technique.

are forwarded through channels specified by the NBCC. Units do not automatically take such samples.

**Conditions for GRR.** Nuclear weapons may be used on the battlefield at any time. This could produce extensive fallout areas or more localized neutron-induced contamination areas. Even the total use of fallout-free airbursts can create residual contamination hot spots because of rainout.

These hot spots could be in the vicinity of GZ or at distant locations. Because of the constant threat, all units, upon initial deployment, must conduct GRR. Thus, GRR is conducted during all tactical operations, patrols, and unit movements.

**Limitations of GRR.** When a mission is given to conduct an area, zone, or route recon, the anticipated hazards are considered. Avoidance techniques and methods for complete protection from enemy action, minefield, and chemically contaminated areas exist. However, since radiation presents a penetrating hazard, the only complete protection from radiological contamination is avoidance of the area entirely. At this stage of recon, when radiological hazards are initially located, there is no indication of the maximum dose rate that may be found.

The process of determining the highest dose rate may be lethal to the GRR team. The GRR team cannot conduct detailed assessment of the contamination. Keep in mind that the GRR teams also must locate other contaminated areas during other operations. These teams must have a very low dose limit or operational exposure guidance (OEG). The arbitrary setting of a high OEG will result in the loss of the team. These limitations restrict the GRR team to locating only the outer limit of a contaminated area. Further reconnaissance for terrain trafficability, enemy activity, obstacles, chemical contamination, and so forth, must stop if a low dose limit is to be maintained.

$D_b$  is specified for each mission. (Refer to Appendix A for further discussion of  $D_b$ .) This total dose is low enough to permit additional exposure to the contamination at later times.

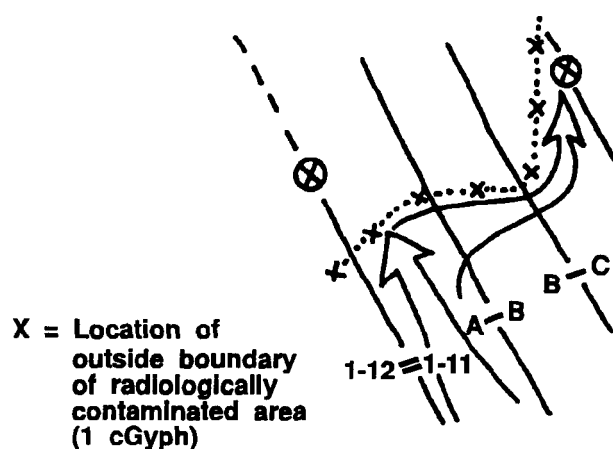

**Figure 5-24. Contact contamination plot.**

**Ground Radiological Reconnaissance Techniques.** In GRR, the most desirable information is the location of uncontaminated areas. GRR is rarely concerned with the determination of the dose rates inside contaminated areas. This task is left to radiological survey. (Surveys were previously discussed in this chapter.)

Dose rates found during GRR are usually of secondary value. The location of the perimeter of the contamination or paths around or through the contamination is of principal value and importance. Knowledge of the perimeter location allows units to avoid the hazard completely.

Prior to the GRR, scouts or NBC teams must have a specified dose-rate level. During GRR, this dose rate serves as the threshold for contamination. This dose rate may be a matter of SOP or may be provided in mission briefings. The dose rate should be inside dose rate. Further, the dose rate should be low enough to be easily read on radiac instruments while moving. This is not a turnback dose rate. This threshold dose rate must be carefully considered and compared to the TF for the vehicles. The threshold dose rate may be entered into the AN/VDR2 after which the VDR2 will automatically alarm every time this dose rate is reached.

When scouts or GRR teams discover contamination, they report its location. They may also report dose rates and time of detection. The NBC 4 nuclear report format can be used to report these data; however, most expeditious reporting requires only a simple statement that contamination is present at a specific location. When the NBC 4 nuclear report format is used, the word "CONTACT" is used with the dose rate or line item Romeo. The word "INITIAL" is not used.

The in-and-out process is used by the GRR team after discovery. Upon detecting contamination, the team records the reading, time, and location on DA Form 1971-R. A report is rendered to alert the main body or unit. The team then withdraws to an uncontaminated area. The team flanks the contamination, repeating the in-and-out process within the team's assigned area, section, or zone. Figure 5-23 illustrates this process. Additional methods of determining the location of radiological contamination are outlined in FM 3-19.

**Marking Areas.** GRR teams mark the outer boundaries of the contamination unless told not to do so. In some cases, this may provide benefit to the enemy about troop movements. NATO markers are erected only at logical points of entry facing away from the contamination. Data are not normally recorded on the signs due to time limitations in keeping with the expeditious nature of reconnaissance operations. Writing on the signs does not enhance the warning afforded by sighting or recognition.

**Washout or Rainout.** The washing out of radiological fallout particles from the air can vastly affect GRR operations. For more information on washout and rainout

refer to Chapter 6. If the condition is caused by rain, the resulting contamination will collect in low areas, streams, ponds, and rivers, creating hot spots. However, large still bodies of water will allow heavier fallout particles to settle and provide shielding. If snow causes the rainout, the area will initially be evenly blanketed. Heavy snowfall may shield indications and readings of radiation levels, but it will eventually melt, and the result will be the same as that caused by rain.

A rainout area can be larger or smaller than a fallout area when given the same size attack employed as a surface burst. There is no satisfactory rainout prediction system. Essentially, the prediction involves determining when it will rain, how much it will rain, and how large the raindrops (sleet, hail, or snow) will be. Rainout can also cause a significant hot spot in an otherwise normal fallout pattern. The GRR team should be aware of rainout and its effects on the mission. Rainout can cause residual contamination from what should have been a fallout-free burst.

**Unit NBC Defense Team Actions.** The unit NBC defense team plots reports from the GRR team. The plot attempts to outline the contaminated area. The NBC defense team does not attempt to normalize the GRR data. Avoidance rather than evaluation is the objective. Figure 5-24 shows a contact contamination plot made by a unit NBC defense team. The NBC defense team may be required to exchange data with lateral units to obtain a larger picture of the contamination. It also must submit its data to the NBCC for evaluation. Such data consist of dose rates, locations, and times of measurement. The NBC 4 nuclear report format should be used.

### Aerial Recon

The NBCC directs all aerial radiological recon (ARR) as well as all radiological surveys. This centralizes control of the teams and provides data for command-wide use. Only the NBCC has dedicated personnel who can evaluate and analyze ARR data and rapidly convert it into usable form.

ARR is a highly specialized operation, which requires trained personnel and careful planning. In most cases, ARR is conducted at or ahead of the FLOT. This requires air defense artillery planning as

well as aerial security, fire support, communications, and airspace coordination.

Fallout also must be complete before ARR can begin at a given location. Completion time may be calculated or it may be indicated by NBC 4 nuclear peak reports from the area or an area further downwind. Given the scope of the operation, only the NBCC can effectively coordinate these matters. This centralized control permits greater flexibility in moving the aerial teams to suspect areas. It also eases coordination across unit boundaries and provides data to the organization best equipped to convert, plot, and disseminate the results—the NBCC.

The product of ARR is a simplified contamination plot. This plot, illustrated in Figure 5-25 also reflects the results of unit monitoring and GRR reports. The plot has a short life span. It is constantly updated and refined as the intelligence cycle feeds in additional information. Ultimately, an aerial survey will be conducted; however, the tactical situation must be stable for this to occur.

Finally, aircraft coordination, specifically helicopter support, is required. In these circumstances, division-level taskings for helicopters will be required.

### ARR Techniques

The techniques for conducting ARR are the same as for radiological surveys, with the following exceptions:

- The ARR team selects the checkpoints, routes, and course legs when they arrive over the area. The NBCC preplans only the general area over which the ARR is conducted. Under hostile air defense artillery (ADA) conditions, route and course leg techniques are not recommended because of their unique signatures. In this case, the point technique with nap-of-the-earth flight at appropriate speed is recommended.

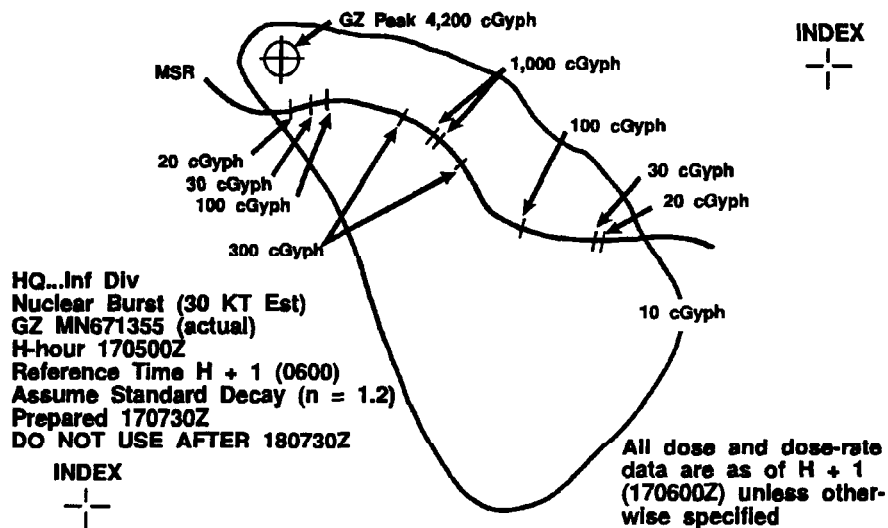

Figure 5-25. Sample simplified contamination plot.

- The ARR provides relatively little detail, covering only those parts of the contaminated area that are of immediate operational concern. Other portions of the area can wait until surveys are conducted.
- A debriefing is held by the NBCC's centralized defense team after the ARR is complete.

Upon arrival over the contaminated area, the ARR team locates the edge of the area. Once the edge is located, the team determines checkpoints that can be identified from the air and on the map. Often the team flies on an azimuth from a known point, as a modification of the course leg technique. The altitude and air speed are determined by the team as explained for aerial survey. These team-selected check-points are used for route, course leg, and point techniques. An additional technique involves flying from a checkpoint along a compass heading. Constant airspeed is maintained. This airspeed and the flight duration is also recorded on DA Form 1971-1-R.

The point technique may be the only viable way to perform ARR at or ahead of the FLOT. This technique permits nap-of-the-earth flight at appropriate speeds and evasive maneuvers. It reduces the ADA threat. It also permits shielded readings if accurate AGCF dose rates are determined for the aircraft. All shielded readings must be taken from the same height as the aerial dose rate of the AGCF data.

### ARR Limitations

Under hostile ADA conditions, route and course leg techniques for ARR are not recommended. These techniques create a unique signature and predictable movements.

ARR in **arctic, desert, or jungle** regions with few or no landmarks for checkpoint identification is difficult. The quickest way to identify a location under such conditions is to mark the spot on the ground by dropping bags of talc, flour, or paint from the helicopter. Specialized communications support may also be required to establish locations from radio fixes while the helicopter hovers.

The **status of training** of the ARR team must also be considered. The best source of ARR teams is the aviation unit that supplies the helicopter. In general, ARR teams must be better trained than survey teams. ARR teams are essentially autonomous. They must understand all facets of the operation. They must also be capable of independent and innovative action to accomplish their missions.

The **previous dose** of the ARR team is another important factor. The ARR team carries an IM147/PD (USA) or IM143/PD (USMC) dosimeter. This dosimeter is checked frequently to ensure the OEG is not exceeded. Other type dosimeters are unacceptable because of their large scales. Usually the OEG given to ARR teams will be around 10 cGy. Large-scale dosimeters do not permit readings in this range. Because of the maneuverability of the helicopter, the team can immediately remove itself from high dose rate areas, if necessary.

**Communications** play a large part in the ability of an ARR team to quickly accomplish its mission. The NBCC does not have organic radios. It may not have assigned frequencies or call signs. Thus, the NBCC must rely on other nets. ARR teams will monitor these nets awaiting mid-mission changes. Because the NBCC must borrow a radio, real-time transmission of data may be impossible. Under hostile EW conditions, it may not be recommended. Range of radios must also be considered. Face-to-face delivery of data is preferred. However, pilots must be briefed so they do not inadvertently disclose the NBCC location. This OPSEC measure may require the pilot to land at a location and send the data by telephone.

### NBCC Actions

The NBCC converts shielded dose rates to ground dose rates by application of the AGCF. Further processing involves normalizing dose rates to H + 1 or other reference time. At early stages, the decay rate of fallout is assumed to be  $n = 1.2$ . If neutron-induced contamination is present, soil type 11 is assumed to be present. Outside dose rates may be normalized using normalizing factors or the M1A1 radiac calculator for fallout or decay nomograms for induced contamination. Subsequent actions for plotting are identical to those used to plot survey data.

Contamination plots are for immediate operations and are valid, at best, for a few hours after creation. Each plot consists of the perimeter of the contamination and dose rates at points of operational interest. See Figure 5-25 for an example of a plot developed from reconnaissance data.

The NBC 5 nuclear report format is not used to disseminate a contamination plot. This avoids confusion with line item Xray contour line. When the plot must be sent to other units and messengers or facsimiles are not available, the corner coordinates of a box outlining the area may be sent. The NBCC should establish this procedure in the FSOP.

**NEXT PAGE INTENTIONALLY LEFT BLANK**

## Chapter 6

# Nuclear Defense

Nuclear operations present unique challenges to commanders, unit NBC defense teams, and chemical staff personnel. To provide the required accurate information and battlefield intelligence, numerous mathematical calculations must be performed. These calculations are used to—

- Calculate the optimum time to exit a fallout area.

- Determine H-hour, or when the nuclear device exploded.
- Determine the tactical implication of rainout.
- Determine the period of validity and decay rate.
- Normalize survey readings to H + 1.
- Calculate total dose when crossing fallout areas.

This chapter details the mathematical procedures required to provide this essential information.

## Optimum Time of Exit for Fallout Areas

Radiological fallout may present a serious hazard to units that remain in a contaminated area. Shelters, such as field emplacements, are the best protective measures against nuclear radiation for troops. If the shelter provides any appreciable amount of protection, it will be advantageous to remain and improve the shelter rather than to evacuate to an uncontaminated area. If the situation permits, and higher headquarters approves, the commander may decide to move out of the contaminated area. By evacuating at the optimum exit time, the radiation dose to personnel is kept to a minimum.

To compute the optimum exit time for a fallout area, you must know the time of detonation, location of uncontaminated area; and the average transmission factor of the vehicles used and the shelters involved, plus the time required to evacuate the position.

If the nuclear burst was not sighted by the unit, the nearest NBCC will provide the H-hour.

When moving from an area contaminated by fallout, the unit moves into an uncontaminated location. This will necessitate waiting until fallout is complete at present positions.

The average transmission factor of the fallout shelters and the vehicles used to leave the contaminated area must be computed. Since all shelters are not the same, an average value should be used. The transmission factor of a vehicle may be calculated. A unit moving on foot will be fully exposed and will have a transmission factor of 1.0.

The time to load vehicles and move out of the contaminated area must be estimated. To minimize exposure time, it may be necessary to temporarily abandon

nonessential items and recover them at a later time when the dose rate has decreased to an acceptable value.

The following abbreviations are used in optimum time of exit calculations:

$$T_{opt} = MF \times T_{ev}$$

$T_{opt}$  = optimum time of exit.

$MF$  = multiplication factor.

$T_{ev}$  = time (in hours) required to evacuate the contaminated area.

$A_e$  = average transmission factor of the vehicles used during movement out of the contaminated areas.

$A_s$  = average transmission factor of the shelter. (This includes vehicles being used as shelters).

Compute the optimum exit time using the three following steps:

**Step 1.** Calculate the transmission factor ratio,  $A_s/A_e$ .

**Step 2.** Determine the multiplication factor. Enter the vertical axis of Figure 6-1 with the value obtained for  $A_s/A_e$ . Move horizontally along this value to the curve. Move straight down and read the multiplication factor from the horizontal axis.

**Step 3.** Calculate the optimum exit time. Multiply the multiplication factor by the  $T_{ev}$ . The product is the optimum time, in hours after detonation, that the unit should leave its shelters and evacuate the area. Optimum time of exit equals the multiplication factor times  $T_{ev}$ .

## Special Considerations

The unit should evacuate the fallout area as soon as possible when ratios of  $\frac{A_s}{A_e}$  are equal to or greater than 0.5.

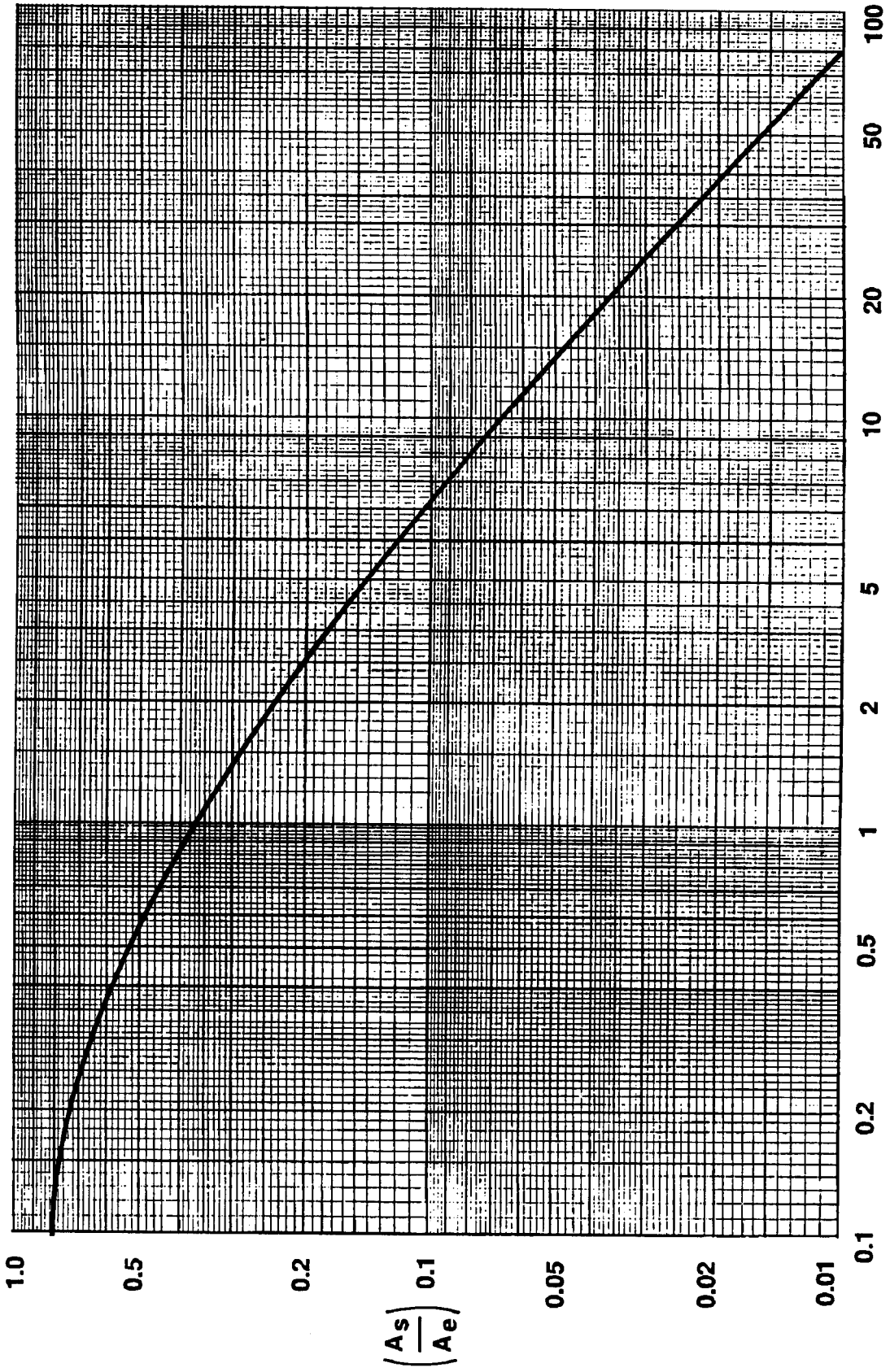

Figure 6-1. Multiplication factor.

If the optimum time of exit is estimated to be before the actual arrival of fallout, the unit should evacuate the area as soon as possible after fallout is complete and an uncontaminated area is available.

The unit will receive the smallest dose possible if it leaves the contaminated area at the optimum time of exit. If the unit commander is willing to accept up to a ten percent increase in dose, he or she may leave the shelters any time between one-half and twice the optimum time of exit.

If possible, personnel should improve their shelters while waiting for the optimum time of exit. This, however, should only be attempted if the personnel do not have to leave the shelter to improve it. The estimate of the optimum time of exit should be recalculated if significant improvement is made in the shelters. Improved shelters mean the unit may remain for a longer period, to minimize the dose to personnel.

## Sample Problem

Given:  $A_s = 0.1$  (foxhole)

$A_e = 0.6$  (2½-ton truck)

$T_{ev} = 1$  hour

Find: Optimum time of exit

$$\text{Solution: } \frac{A_s}{A_e} = \frac{0.1}{0.6} = 0.167$$

Multiplication factor = 2.9

Optimum time of exit = Multiplication factor x  $T_{ev}$

$$= 2.9 \times 1$$

$$= 2.9, \text{ or } 2 \text{ hours and } 54 \text{ minutes.}$$

Optimum time of exit calculations bring up two other areas that are a vital part to radiological operations. One is transmission factors and the other is the calculation of H-hour.

## Transmission Factors

A transmission factor (TF) is that fraction of the outside (ground) dose or dose rate received inside the enclosure that provides the shielding. (Refer to Appendix B for a more detailed discussion on shielding). TFs are always less than one. TFs are used to find the reduction in dose or dose rates received when personnel are protected from radiation.

TFs are always determined in operational situations by the unit NBC defense team. Each TF is calculated using the formula below:

$$\text{transmission factor} = \frac{\text{inside dose or dose rate (ID)}}{\text{outside dose or dose rate (OD)}}$$

Rearrangement of this formula yields  $ID = OD \times TF$

and  $OD = \frac{ID}{TF}$ . The TF is needed because its principal use is to find the ID.

Problem 1. The outside dose is 90 cGyph. Use the transmission factor to calculate the inside dose. What dose would troops in M 113 armored personnel carriers receive? The TF for an M113 is 0.3.

$$\begin{aligned} ID &= OD \times TF \\ &= 90 \times 0.3 \\ &= 27 \text{ cGy} \end{aligned}$$

Problem 2. Transmission factors also may be applied to dose rates. A measured outside dose rate is 100 cGyph. The inside dose rate is calculated by use of the transmission factor. Find the dose rate inside the M113:

$$\begin{aligned} ID &= OD \times TF \\ &= 100 \times 0.3 \\ &= 30 \text{ cGyph.} \end{aligned}$$

A list of precalculated transmission factors are in Table 6-1. These TFs are for the most exposed occupied location.

They are not based on dose rates from fallout; they are based on gamma radiation from Cobalt 60. Energies from radioactive elements are measured in million electron volts (MEVs). The average from Cobalt 60 is roughly 1.25. Average energy from gamma activity in fallout is 0.67. Since Cobalt-60 radiation is almost twice as strong as the radiation from fallout, actual TFs should be much smaller (more protection).

Note that these TFs are not used under operational situations. Commanders and operations personnel use these precalculated TFs to judge the relative shielding ability of various vehicles and shelters. They are provided also for instruction and practice. For vehicles that have AN/VDR2s installed, each user need only verify that the correct attenuation factor has been entered (IAW TM 11-6665-251-10) and then read the outside dose directly off the display. The attenuation factor is the mathematical inverse of the transmission factor and has already been calculated for many vehicles. These factors are printed on the mounting bracket for the AN/VDR2.

Another method that may be used to calculate the shielding properties is using a protection factor (PF). PF may be calculated with the following formula:

$$\frac{1}{TF} = PF$$

To determine the shielding properties of a vehicle use the following formula

$$\frac{D_t}{PF} = ID_t$$

$OD_t =$  outside total dose

$ID_t =$  inside total dose



## Calculation of H-Hour

H-hour may be calculated mathematically or by using the ABC-M1 radiac calculator. Calculate H-hour mathematically, using the following procedure (All calculations must be made after fallout is complete.):

$$T_1 = \frac{T_b - T_a}{\left(\frac{R_a}{R_b}\right)^{1/n - 1}}$$

T<sub>1</sub> = time after H-hour at which reading R<sub>a</sub> was made.  
 T<sub>b</sub>-T<sub>a</sub> = interval between readings R<sub>a</sub> and R<sub>b</sub>.

The value of  $\left(\frac{R_a}{R_b}\right)^{1/n}$  can be calculated or may be read from a family of slopes (Figure 6-2, next page). To calculate, use an assumed decay exponent or one that has been determined.

For example, monitoring reports R<sub>a</sub> and R<sub>b</sub> represent the earliest and latest data available for a particular location within a contaminated area:

R<sub>a</sub> = 112 cGyph (0500, 15 January)

R<sub>b</sub> = 24 cGyph (2200, 15 January).

From Figure 6-2, assuming n = 1.2

$$T_1 = \frac{17 \text{ hours}}{3.6 - 1} = 6.54 = 6.5 \text{ hours}$$

Since T<sub>1</sub> is the time after H-hour at which reading R<sub>a</sub> was made, the H-hour = T<sub>a</sub> - T<sub>1</sub> = 0500, 15 January - 6.5 hours = 2230, 14 January.

## Use of ABC-M1 Radiac Calculator

The ABC-M1 radiac calculator (Figure 6-3, page 6-6) may be used to determine H-hour (if n = 1.2) as follows:

- Choose two readings. For example, the first and last readings made at a particular location:

Time    Dose Rate  
 1600 50 cGyph  
 1830 40 cGyph.

- Locate the two dose rates on the outer disk of the ABC-M1. Determine the time interval between the two readings.
- Move the intermediate disk until a time interval of 2½ hours coincides with the 40- and 50-cGyph readings on the outer disk. Read the time under the 50 cGyph as 12 hours. The 50-cGyph dose rate was read at 1600; thus, 1600 corresponds

**Table 6-1. Transmission factors for residual radiation.**

Environmental Shielding	Vehicles	Transmission Factor (TF)	Environmental Shielding	Engineer Equipment	Transmission Factor (TF)
M1 tank		0.04	M9 ACE		0.3
M48 tank		0.02	Grader		0.8
M60 tank		0.04	Bulldozer		0.5
M2 IFV		0.2	Scraper		0.5
M3 CFV		0.2		<b>Structures</b>	
M93 NBC Reconnaissance Vehicle		0.2	Frame house		0.3--0.6
M113 armored personnel carrier		0.3	Basement		0.05--0.1
M109 self propelled howitzer		0.2		<b>Multistory Building (Apartment Type)</b>	
M548 cargo vehicle		0.7	Upper stories		0.01
M88 recovery vehicle		0.09	Lower stories		0.1
M577 command post carrier		0.3		<b>Concrete Blockhouse Shelter</b>	
M551 armored recon airborne assault vehicle		0.2	9-in. walls		0.007--0.09
M728 combat engineer vehicle		0.04	12-in. walls		0.0001--0.03
	<b>Helicopters (Parked)</b>		24-in. walls		0.0001--0.002
OH-58		0.8		<b>Shelter, Partly Above Ground</b>	
UH-60		0.7	With 2-ft earth cover		0.005--0.02
CH-47		0.6	With 3-ft earth cover		0.001--0.005
	<b>Trucks</b>		Urban Areas (in open)		0.7 *
HUMMV		0.6	Woods		0.8 *
¼-ton		0.8	Underground Shelters(3-ft earth cover)		0.0002
¾-ton		0.6	Foxholes		0.1
CUCV		0.6			
2½-ton		0.6			
4-ton to 7-ton		0.5			

\* These factors apply to aerial survey dose rates.

**Note:** For vehicles in which AN/VDR2s have been installed, the users need only verify that the correct attenuation factor has been entered (IAW TM 11-6665-251-10) and then read the outside dose directly off the display. The attenuation factor is the mathematical inverse of the transmission factor. If the attenuation factor has not been set properly, refer to TM 11-6665-251-20.

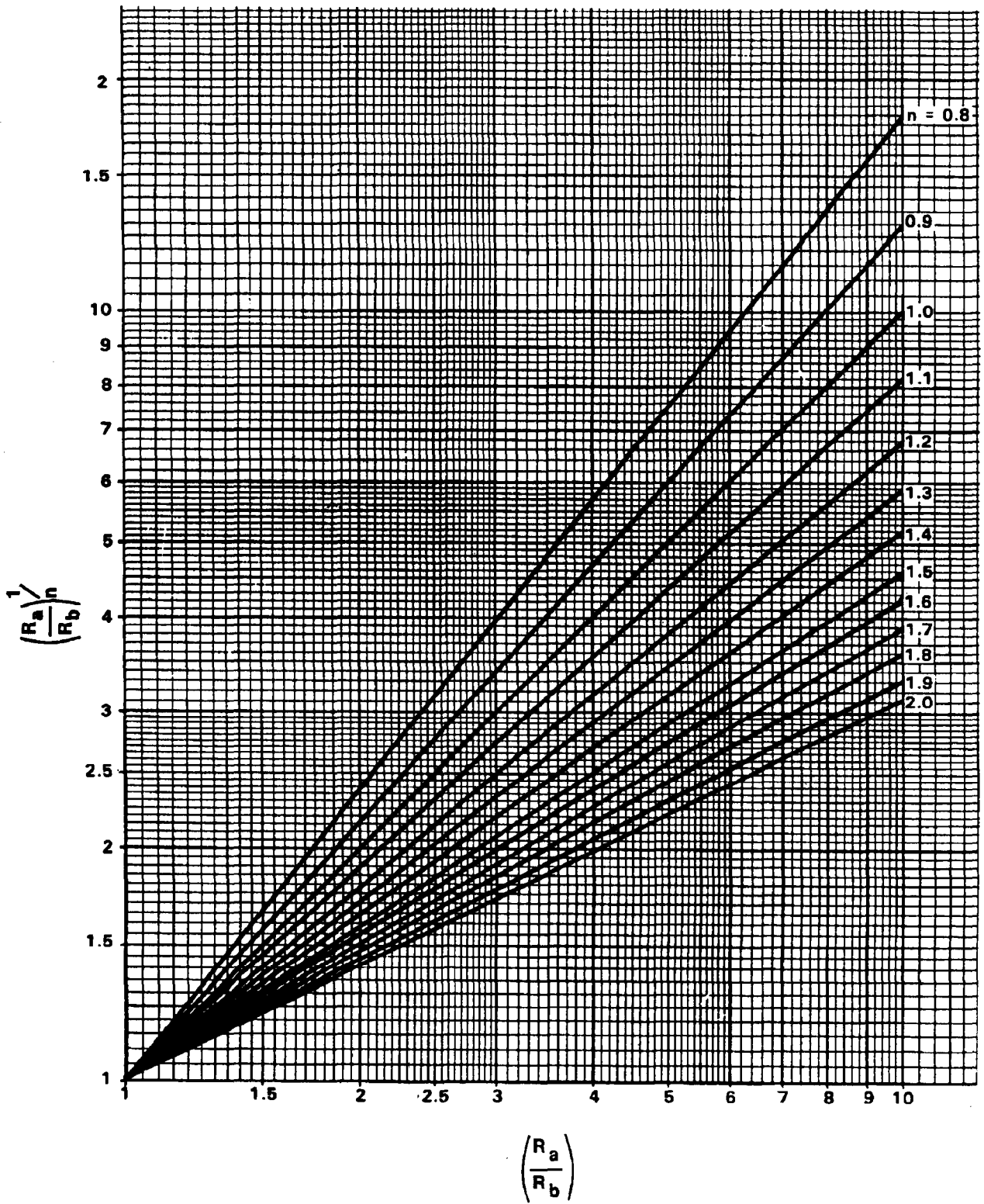

Figure 6-2. Value of  $\frac{R_a}{R_b}$ .

to  $H = 12$ . This means that H-hour was 12 hours earlier than 1600 (see Figure 6-3).  $H\text{-hour} = 1600 - 1200 = 0400$ .

As mentioned previously, the NBC 3 nuclear report is only a prediction which provides a means of locating probable radiation hazards. Militarily significant fallout will occur within the predicted area. However, the prediction does not indicate exactly where the fallout will occur or what the dose rate will be at a specific location. Where fallout will occur is a function of weather and terrain. The most significant weather effect, as far as fallout is concerned, is commonly referred to as rainout or washout.

### Rainout and Washout

Rainout and washout are nothing more than the removal of radioactive particles from a nuclear cloud by precipitation when the nuclear cloud is below or within a precipitation cloud. Even when rain clouds are not present, rainout or washout may occur. This will depend on the amount of water evaporated by the fireball and rising as water vapor. Such evaporation may occur when a nuclear detonation occurs over a large body of water, such as a lake or ocean. A nuclear weapon detonated in a high humidity area may also result in rainout or washout. When water vapor rises with the nuclear cloud, it will cool and

condensate in the atmosphere, then fall back to the surface as rain.

If the airborne radioactive debris from a nuclear burst should encounter precipitation, a large portion of the debris may be brought to earth with the rain or other moisture. The resulting fallout pattern will be irregular, producing local hot spots within the fallout pattern. Although an air burst normally does not produce any militarily significant fallout, precipitation in or above the nuclear cloud can cause significant contamination on the ground. Precipitation may also affect the fallout distribution from surface or sub-surface bursts by washing contamination from one location and depositing it in lower areas.

There are basically two factors that must be considered to determine whether or not rainout will occur and to what extent. The first is **duration of the precipitation**—the longer the precipitation the greater the percentage of the nuclear cloud will be washed or scavenged. Table 6-2 represents this percentage as a factor of precipitation duration. This occurs when a nuclear cloud is within a rain cloud. Notice, rainfall rate appears to have little effect on rainout. Washout, on the otherhand, occurs when the nuclear cloud is below the rain cloud. Here, the rainfall rate directly effects the amount of scavenging that will occur. Table 6-3 reflects this effect. The terms light, moderate, and heavy in this table refer to rates of 0.05, 0.2, and 0.47 inches of rain per hour, respectively, as measured at the surface. Thus, it would appear that rainout is more effective than washout in scavenging a nuclear cloud.

The other factor is the **altitude of the stabilized nuclear cloud** versus the

**Table 6-2. Estimated scavenging for rainout.**

Percent of Cloud Scavenged	Rate of Rainfall (in/hr)
25	0.07
50	0.16
75	0.32
90	0.53
99	1.10

**Table 6-3. Estimated scavenging for washout.**

Percent of Cloud Scavenged	Rate of Rainfall (in/hr)		
	Light	Moderate	Heavy
25	8	1.6	0.8
50	19	3.8	1.9
75	38	7.7	3.6
90	64	13.0	6.4
99	128	26.0	13.0

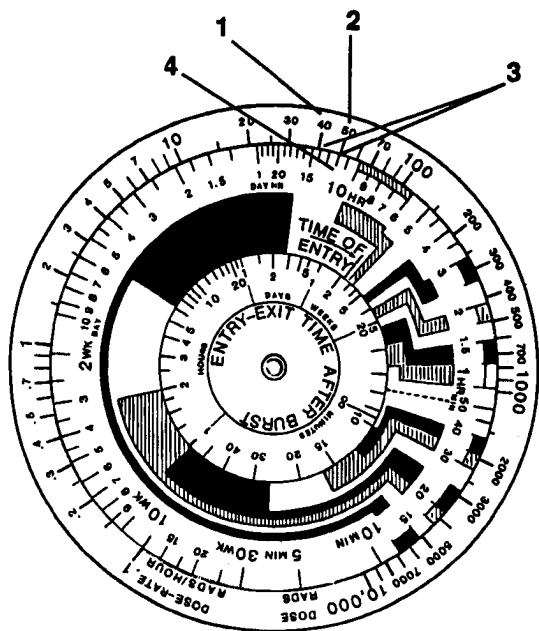

1. 40 cGyph on outer disk
2. 50 cGyph on outer disk
3. 2 1/2 hour interval on intermediate disk
4. Reading of 12 hours

**Figure 6-3. Determining H-hour,**

altitude of the rain or snow cloud. The altitudes of most rain cloud tops range from 10,000 to 30,000 feet. The bottom of these clouds, where most precipitation emerges, is commonly at an altitude of about 2,000 feet. Precipitation from severe thunderstorms may originate as high as 60,000 feet. If the rain cloud is smaller than the nuclear cloud, then only that portion of the nuclear cloud covered by the rain cloud will be affected by washout or rainout; whichever applies. If the nuclear cloud extends past, or higher than the top of the rain cloud, then only that portion of the nuclear cloud that lies within and under the rain cloud will be affected. Figure 6-4 depicts the average heights or altitudes of stabilized nuclear cloud tops and bottoms, per yield for surface and low-air bursts. Obtain data from the staff weather service to determine the heights of clouds that cover the area in which the nuclear burst occurred. This will provide data that can be used to determine whether or not the nuclear cloud will be subject to washout or rainout.

If the nuclear cloud should drift into a rain or snow cloud at some point after the burst, the surface contamination caused by scavenging will be decreased due to radioactive decay. The longer between detonation and entering into the rain cloud, the less radioactive material will be present. Finally, the particles that are scavenged will not be deposited on the ground immediately, but will fall with the precipitation (typically 800 to 1,200 feet per minute for rain and 200 feet per minute for snow). Since the particles are scavenged over time and over a range of

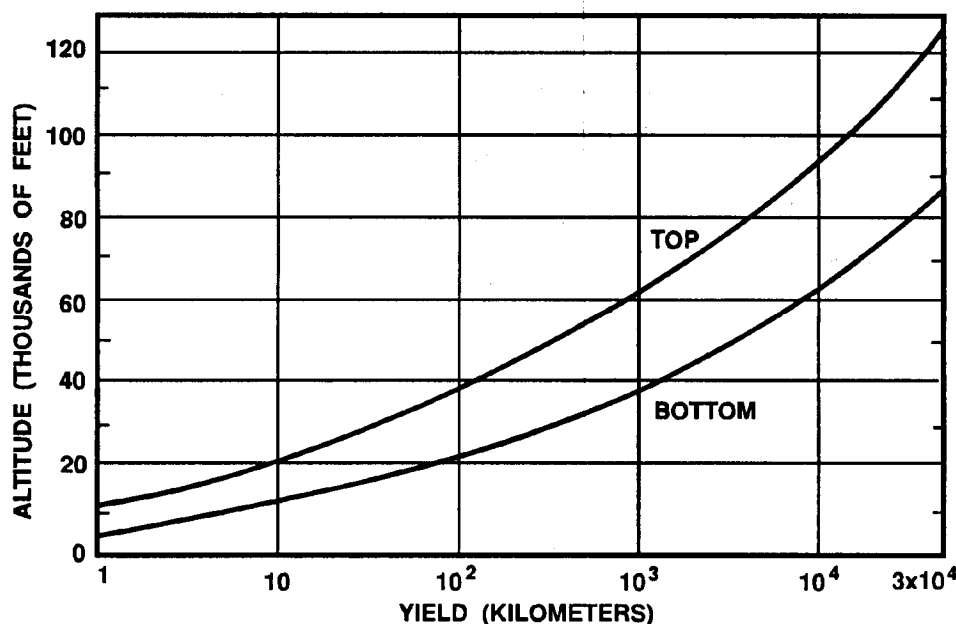

Figure 6-4. Altitudes of stabilized cloud tops and cloud bottoms as a function of total energy yield for surface or low air bursts.

Yield (KT)	Infinite whole-body external gamma dose (cGy)	
	Rainout (airburst)	Fallout (surface burst)
1	25,000	45
10	5,000	240
50	1,500	950
100	800	3,000

Figure 6-5. Infinite whole-body gamma dose.

altitudes, horizontal movement during the fall of particles will tend to decrease the concentration of radioactivity on the ground. This movement and deposition will result in elongated surface fallout patterns. The exact shape will depend on the amount of rainfall, wind, and surface conditions. However, the radioactivity deposited on the ground from rainout is much more significant than that of dry or normal fallout. This is due primarily to the fact that rainout causes the radioactive particles suspended in the atmosphere to fall to the surface at a faster and more concentrated level than dry fallout. Research of this phenomena was conducted in the early 1970's and yielded the data presented in Figure 6-5. This data suggests that the contamination from low yield air bursts subject to rainout produces radioactive contamination at a much more

significant level than dry fallout from a surface burst. This is due primarily to the rain or snow forcing the particles of fallout to the ground faster and in a heavier concentration.

### Tactical Implications

Exposed personnel without access to structures, vehicles or field works offering a reasonable radiological protection factor (such as, trenches with 18 inches of earth overhead cover) would soon become non-effective if they were in an area of rainout from a lower-yield weapon(s). The area would be contaminated to such an extent as to render it dangerous for them to remain in the affected area long without receiving an incapacitating dose of radiation.

Runoff from the affected area, containing high-intensity radiological contamination, could

contaminate water supplies in an adjacent unaffected area. Runoff in contaminated areas will flow into water sources such as lakes, rivers, and streams, creating concentrated energy levels. Monitor water sources with the AN/PDR27 set on the higher scale and the probe in a plastic bag, before consuming or entering the water.

It seems obvious that certain extra warning measures should be implemented. Divisional NBCCs should give special warnings to units that may be subject to rainout. At present it is not yet practicable to give this with great accuracy, but enough should be known to enable sensible

forecasts to be made. Guidance, based on this forecast may then be passed to affected units on what action commanders should be prepared to take. One obvious action is that they should order continuous monitoring when rainout is forecasted or at the onset of rain. If rainout occurs, they are faced with one of two simple choices: either get their units under proper cover, or get them away from the area—if tactical considerations permit. It is worth mentioning that the enemy is unlikely to occupy the vacated area for the same reason the unit leaves it.

## Period of Validity and Decay Rate

Fallout will decay according to the following Kaufman equation—

$$R_1 T_1^n = R_2 T_2^n$$

R = dose rates at a single location, and 1 and 2 correspond to the times they were taken.

T = time in hours after H-hour, that readings 1 and 2 were taken.

n = decay exponent, and 1 and 2 denote different times after H-hour. When 1 denotes H + 1, and 2 denotes any other time, the equation becomes  $R_2 = R_1 T_2^{-n}$ .

Dose calculations and pattern evaluations depend upon decay rate. So the decay exponent must be known. In fallout contamination, the value of n will not necessarily be constant with time or even constant throughout a particular contaminated area, although the pattern as a whole will

calculations are to be made. That is, the more reliable the dose-rate monitoring and the longer the time interval over which they are taken, the longer the time in which reliable dose calculations can be made.

As a rule of thumb, reliable dose calculations can be projected in time ( $T_p$ -period of validity) over a period three times as long as the monitoring time interval. The period of validity ( $T_p$ ) is a mathematical calculation that determines how long the decay rate is good. For example, for a decay rate determined from monitoring readings taken between H + 4 and H + 8, dose calculations could be reliably projected from H + 8 to H + 20 ( $T_p = H + 8 + [3(8 - 4)] = H + 20$ ). Additional monitoring data will extend this time. Thus, the calculations based upon decay rate are valid for 20 hours after the burst. The date-time representing 20 hours from the attack is recorded on the contamination overlay as the do-not-use-after date-time group. This calculation is placed on the contamination overlay to advise the user of the length of time the calculations are valid.

The formula for determining the period of validity  $T_p$  is—

$$T_p = 3(T_b - T_a) + T_b$$

An illustration of the preferred method in which decay-rate determinations and estimations are used in developing a contamination pattern is presented below. Additional methods to calculate the decay rate are presented in Appendix F.

**Example:** Collection effort for a fallout-producing nuclear burst (H-hour known) begins at H + 4. It is expected to be completed by H + 6. The target time for preparation of the pattern is H + 8. By H + 6, a decay estimation can be made and the remainder of the dose-rate information processed. This will result in a reasonably reliable H + 1 pattern. By H + 6, a decay-rate determination can be accomplished to allow the use of the pattern until about H + 12. By H + 12, a decay-rate determination can be made to allow use of the pattern until H + 36 hours. Each extension of time extends the do-not-use-after date-time group for the contamination plot.

### Caution

When dealing with overlapping contamination patterns, using an average n value for the overall pattern can lead to serious error.

have an average value. This average value will vary from pattern to pattern.

The amount of variation is expected to be from about 0.2 to 2.0 for fallout. The lower values of n also can be expected for salted weapons. Salted weapons refers to weapons that have additives included in the warhead generally to produce or increase induced radiation. The average value of n for most patterns (referred to as standard decay) will be 1.2. Standard decay may be assumed when decay-rate determination has not yet been made.

Determination of decay rate depends on H-hour. A sequence of dose-rate readings (NBC 4 nuclear Series reports) from several selected locations is required. The reliability of the decay-rate calculation depends on the precision of the dose-rate readings, the interval over which the readings are taken, and the time over which dose

## Determination of Decay Rate

Determine the decay exponent by solving the Kaufman equation for n:

$$n = \frac{\log(R_a + R_b)}{\log(T_b + T_a)}$$

R<sub>a</sub> = dose rate (cGyph) measured at time, T<sub>a</sub> (a peak dose rate recorded at H + 1 or later).

R<sub>b</sub> = dose rate (cGyph) measured at time, T<sub>b</sub> (the last dose rate available).

T<sub>a</sub> = the time (H + . hours after burst) that dose rate R<sub>a</sub> was measured.

T<sub>b</sub> = the time (H + \_ hours after burst) that dose rate R<sub>b</sub> was measured.

n = decay rate of fallout.

**Note:** R<sub>a</sub>, R<sub>b</sub>, T<sub>a</sub>, and T<sub>b</sub> are determined from the NBC 4 nuclear series reports submitted by units that have been directed by the NBCC to pass dose rate readings every half hour for 2 hours, followed by hourly reports. These reports begin after the NBC 4 peak has been determined.

Table 6-4, (next four pages), provides nontypical logarithms of numbers. The tables consist of two columns marked A and B. Column A is the quotient of  $\frac{R_a}{R_b}$  or  $\frac{T_b}{T_a}$ .

The logarithm of that quotient is found in Column B.

Note that Column A is given to one decimal place only. To use the table, round your quotient to the nearest single decimal place, and locate that number in Column A. Read the logarithm of that number in Column B.

**Example:** 10 divided by 6 equals 1.66666667. Round to 1.7, and enter Column A with 1.7. The logarithm from Column B is 0.230.

Sometimes, when using the logarithms in Table 6-4, you may need the "log of a number that is not listed. In this case, mathematical estimation is required.

**Example:** You need the logarithm of 12.85. Reading down Column A in Table 6-4, you find values only for 12.8 and 12.9—none for 12.85. To find the log of 12.85—Set the problem up like this and follow the four steps shown:

Value from Column A	Value from Column B
12.81.107	(log of 12.8)
12.8 X	(log of 12.85)
12.91.110	(log of 12.9)

**Step 1.** Take the difference between 12.8 and 12.85, which is 0.05. Take the difference between 12.8 and 12.9, which is 0.1. Set these values up as a numerator and

denominator:  $\frac{0.05}{0.10}$

**Step 2.** Take the difference between 1.107 (log value of 12.8 derived from Column B, Table 6-4) and the log value of 12.85, which at this point, is unknown. This unknown is presented by an "x." Take the difference between 1.107 (log value of 12.8 derived from Column B in Table 6-4) and 1.110 (log value of 12.9 derived from Column B, Table 6-4. In this case, the answer is 0.003. Set these two values up as a numerator and denominator  $\frac{x}{.003}$ .

**Step 3.** Take the value in Step 1 and value in Step 2 and set them equal to each other:  $\frac{0.05}{0.10} = \frac{x}{0.003}$ .

Solve the equation:  $0.5 = \frac{x}{0.003}$

$$(0.003) 0.5 = \frac{x}{0.003} (0.003).$$

**Step 4.** Add the value of "x" (0.0015) to the log value of 12.8 (1.107). The answer will be the log value of 12.85.

$$\begin{array}{r} 1.107 \text{ (log value of 12.8)} \\ + 0.0015 \\ \hline 2.1085 \text{ (log value of 12.85)} \end{array}$$

## Normalizing Readings to H + 1

Once the decay rate (n) is determined, the radiological reading may be normalized to H + 1 readings. This normalized reading is commonly referred to as the R<sub>1</sub> reading. It is nothing more than determining, mathematically what the dose rate reading was at any given location, one hour after the burst. Survey teams and monitors enter an area and take readings at various times after the burst (H-hour). These readings may be 15 minutes or 10 hours after the burst. Any reading that is not recorded 1 hour (H + 1) after a burst is commonly referred to as an R<sub>t</sub> reading. To perform radiological calculations and make decisions on the nuclear battlefield, all readings must be represented using the same time reference. If this is not done, the radioactive elements will

decay and a true representation of the hazard, past and present (because radioactivity is accumulative in the human body) cannot be made.

In other words—

First Situation-Monitor A reports a dose rate of 100 cGyph 5 hours after the burst. The decay rate is unknown, so the monitor assumes standard decay (n = 1.2). What was the dose rate at Monitor A's location at H + 1?

This can be determined by two methods; the nomogram method, which is the preferred method, but subject to operator error, and the mathematical method which is outlined in Appendix F.

(Text continued on page 6-14)

Table 6-4 (Part 1 of 4). Logarithms for numbers 0.0 to 24.9.

A	B	A	B	A	B	A	B	A	B
0.0	0.000	5.0	0.699	10.0	1.000	15.0	1.176	20.0	1.301
0.1	-0.100	5.1	0.707	10.1	1.004	15.1	1.179	20.1	1.303
0.2	-0.699	5.2	0.716	10.2	1.008	15.2	1.182	20.2	1.305
0.3	-0.523	5.3	0.724	10.3	1.012	15.3	1.185	20.3	1.307
0.4	-0.398	5.4	0.732	10.4	1.017	15.4	1.188	20.4	1.309
0.5	-0.301	5.5	0.740	10.5	1.021	15.5	1.190	20.5	1.312
0.6	-0.222	5.6	0.748	10.6	1.025	15.6	1.193	20.6	1.314
0.7	-0.155	5.7	0.756	10.7	1.029	15.7	1.196	20.7	1.316
0.8	-0.099	5.8	0.763	10.8	1.033	15.8	1.199	20.8	1.318
0.9	-0.046	5.9	0.771	10.9	1.037	15.9	1.201	20.9	1.320
1.0	0.000	6.0	0.778	11.0	1.041	16.0	1.204	21.0	1.322
1.1	0.041	6.1	0.785	11.1	1.045	16.1	1.206	21.1	1.324
1.2	0.079	6.2	0.792	11.2	1.049	16.2	1.209	21.2	1.326
1.3	0.114	6.3	0.799	11.3	1.053	16.3	1.212	21.3	1.328
1.4	0.146	6.4	0.806	11.4	1.057	16.4	1.215	21.4	1.330
1.5	0.176	6.5	0.813	11.5	1.060	16.5	1.217	21.5	1.332
1.6	0.204	6.6	0.819	11.6	1.064	16.6	1.220	21.6	1.334
1.7	0.230	6.7	0.826	11.7	1.068	16.7	1.222	21.7	1.336
1.8	0.255	6.8	0.832	11.8	1.072	16.8	1.225	21.8	1.338
1.9	0.279	6.9	0.839	11.9	1.078	16.9	1.228	21.9	1.340
2.0	0.301	7.0	0.845	12.0	1.079	17.0	1.230	22.0	1.342
2.1	0.322	7.1	0.851	12.1	1.083	17.1	1.232	22.1	1.344
2.2	0.342	7.2	0.857	12.2	1.086	17.2	1.235	22.2	1.346
2.3	0.362	7.3	0.863	12.3	1.090	17.3	1.238	22.3	1.348
2.4	0.380	7.4	0.869	12.4	1.093	17.4	1.240	22.4	1.350
2.5	0.398	7.5	0.875	12.5	1.097	17.5	1.243	22.5	1.352
2.6	0.415	7.6	0.881	12.6	1.100	17.6	1.245	22.6	1.354
2.7	0.431	7.7	0.886	12.7	1.104	17.7	1.248	22.7	1.356
2.8	0.447	7.8	0.892	12.8	1.107	17.8	1.250	22.8	1.358
2.9	0.462	7.9	0.898	12.9	1.110	17.9	1.253	22.9	1.360
3.0	0.477	8.0	0.903	13.0	1.114	18.0	1.255	23.0	1.362
3.1	0.491	8.1	0.908	13.1	1.117	18.1	1.257	23.1	1.364
3.2	0.505	8.2	0.914	13.2	1.120	18.2	1.260	23.2	1.365
3.3	0.518	8.3	0.919	13.3	1.124	18.3	1.262	23.3	1.367
3.4	0.531	8.4	0.924	13.4	1.127	18.4	1.265	23.4	1.369
3.5	0.544	8.5	0.929	13.5	1.130	18.5	1.267	23.5	1.371
3.6	0.556	8.6	0.934	13.6	1.134	18.6	1.269	23.6	1.373
3.7	0.568	8.7	0.939	13.7	1.137	18.7	1.272	23.7	1.375
3.8	0.580	8.8	0.944	13.8	1.140	18.8	1.274	23.8	1.377
3.9	0.591	8.9	0.949	13.9	1.143	18.9	1.276	23.9	1.378
4.0	0.602	9.0	0.954	14.0	1.146	19.0	1.279	24.0	1.380
4.1	0.613	9.1	0.959	14.1	1.149	19.1	1.281	24.1	1.382
4.2	0.623	9.2	0.964	14.2	1.152	19.2	1.283	24.2	1.383
4.3	0.633	9.3	0.968	14.3	1.155	19.3	1.285	24.3	1.385
4.4	0.647	9.4	0.973	14.4	1.158	19.4	1.288	24.4	1.387
4.5	0.653	9.5	0.978	14.5	1.161	19.5	1.290	24.5	1.389
4.6	0.663	9.6	0.982	14.6	1.164	19.6	1.292	24.6	1.390
4.7	0.672	9.7	0.987	14.7	1.167	19.7	1.294	24.7	2.392
4.8	0.681	9.8	0.991	14.8	1.170	19.8	1.297	24.8	1.394
4.9	0.690	9.9	0.996	14.9	1.173	19.9	1.299	24.9	1.396

Table 6-4 (Part 2 of 4). Logarithms for numbers 25.0 to 49.9.

A	B	A	B	A	B	A	B	A	B
25.0	1.398	30.0	1.477	35.0	1.544	40.0	1.602	45.0	1.653
25.1	1.400	30.1	1.479	35.1	1.545	40.1	1.603	45.1	1.654
25.2	1.401	30.2	1.480	35.2	1.546	40.2	1.604	45.2	1.655
25.3	1.403	30.3	1.481	35.3	1.548	40.3	1.605	45.3	1.656
25.4	1.405	30.4	1.483	35.4	1.549	40.4	1.606	45.4	1.657
25.5	1.407	30.5	1.484	35.5	1.550	40.5	1.607	45.5	1.658
25.6	1.408	30.6	1.486	35.6	1.551	40.6	1.608	45.6	1.659
25.7	1.410	30.7	1.487	35.7	1.553	40.7	1.609	45.7	1.660
25.8	1.412	30.8	1.488	35.8	1.554	40.8	1.610	45.8	1.661
25.9	1.413	30.9	1.490	35.9	1.555	40.9	1.611	45.9	1.662
26.0	1.415	31.0	1.491	36.0	1.556	41.0	1.612	46.0	1.663
26.1	1.417	31.1	1.493	36.1	1.558	41.1	1.614	46.1	1.664
26.2	1.418	31.2	1.494	36.2	1.559	41.2	1.615	46.2	1.665
26.3	1.420	31.3	1.496	36.3	1.560	41.3	1.616	46.3	1.666
26.4	1.422	31.4	1.497	36.4	1.561	41.4	1.617	46.4	1.667
26.5	1.423	31.5	1.498	36.5	1.562	41.5	1.618	46.5	1.668
26.6	1.425	31.6	1.499	36.6	1.563	41.6	1.619	46.6	1.669
26.7	1.427	31.7	1.501	36.7	1.565	41.7	1.620	46.7	1.670
26.8	1.428	31.8	1.502	36.8	1.566	41.8	1.621	46.8	1.671
26.9	1.430	31.9	1.504	36.9	1.567	41.9	1.622	46.9	1.672
27.0	1.431	32.0	1.505	37.0	1.568	42.0	1.623	47.0	1.673
27.1	1.433	32.1	1.506	37.1	1.569	42.1	1.624	47.1	1.674
27.2	1.435	32.2	1.508	37.2	1.570	42.2	1.625	47.2	1.674
27.3	1.436	32.3	1.509	37.3	1.572	42.3	1.626	47.3	1.675
27.4	1.438	32.4	1.510	37.4	1.573	42.4	1.627	47.4	1.676
27.5	1.439	32.5	1.512	37.5	1.574	42.5	1.628	47.5	1.677
27.6	1.441	32.6	1.513	37.6	1.575	42.6	1.629	47.6	1.678
27.7	1.442	32.7	1.514	37.7	1.576	42.7	1.630	47.7	1.679
27.8	1.444	32.8	1.516	37.8	1.577	42.8	1.631	47.8	1.680
27.9	1.446	32.9	1.517	37.9	1.579	42.9	1.632	47.9	1.681
28.0	1.447	33.0	1.518	38.0	1.580	43.0	1.633	48.0	1.682
28.1	1.449	33.1	1.520	38.1	1.581	43.1	1.634	48.1	1.682
28.2	1.450	33.2	1.521	38.2	1.582	43.2	1.635	48.2	1.683
28.3	1.452	33.3	1.522	38.3	1.583	43.3	1.636	48.3	1.684
28.4	1.453	33.4	1.524	38.4	1.584	43.4	1.637	48.4	1.685
28.5	1.455	33.5	1.525	38.5	1.585	43.5	1.638	48.5	1.686
28.6	1.456	33.6	1.526	38.6	1.587	43.6	1.639	48.6	1.687
28.7	1.458	33.7	1.528	38.7	1.588	43.7	1.640	48.7	1.688
28.8	1.459	33.8	1.529	38.8	1.589	43.8	1.641	48.8	1.689
28.9	1.461	33.9	1.530	38.9	1.590	43.9	1.642	48.9	1.690
29.0	1.462	34.0	1.531	39.0	1.591	44.0	1.643	49.0	1.691
29.1	1.464	34.1	1.532	39.1	1.592	44.1	1.644	49.1	1.691
29.2	1.465	34.2	1.534	39.2	1.593	44.2	1.645	49.2	1.692
29.3	1.467	34.3	1.535	39.3	1.594	44.3	1.646	49.3	1.693
29.4	1.468	34.4	1.536	39.4	1.595	44.4	1.647	49.4	1.694
29.5	1.470	34.5	1.538	39.5	1.597	44.5	1.648	49.5	1.695
29.6	1.471	34.6	1.539	39.6	1.598	44.6	1.649	49.6	1.696
29.7	1.473	34.7	1.540	39.7	1.599	44.7	1.650	49.7	1.697
29.8	1.474	34.8	1.541	39.8	1.600	44.8	1.651	49.8	1.698
29.9	1.476	34.9	1.543	39.9	1.601	44.9	1.652	49.9	1.699



Table 6-4 (Part 3 of 4). Logarithms for numbers 50.0 to 74.9.

A	B	A	B	A	B	A	B	A	B
50.0	1.700	55.0	1.740	60.0	1.778	65.0	1.813	70.0	1.845
50.1	1.700	55.1	1.741	60.1	1.779	65.1	1.814	70.1	1.845
50.2	1.701	55.2	1.742	60.2	1.780	65.2	1.814	70.2	1.846
50.3	1.702	55.3	1.743	60.3	1.780	65.3	1.815	70.3	1.847
50.4	1.703	55.4	1.744	60.4	1.781	65.4	1.816	70.4	1.847
50.5	1.703	55.5	1.744	60.5	1.782	65.5	1.816	70.5	1.848
50.6	1.704	55.6	1.745	60.6	1.782	65.6	1.817	70.6	1.849
50.7	1.705	55.7	1.746	60.7	1.783	65.7	1.818	70.7	1.849
50.8	1.706	55.8	1.747	60.8	1.784	65.8	1.818	70.8	1.850
50.9	1.707	55.9	1.747	60.9	1.785	65.9	1.819	70.9	1.850
51.0	1.708	56.0	1.748	61.0	1.785	66.0	1.820	71.0	1.851
51.1	1.708	56.1	1.749	61.1	1.786	66.1	1.820	71.1	1.851
51.2	1.709	56.2	1.750	61.2	1.787	66.2	1.821	71.2	1.852
51.3	1.710	56.3	1.751	61.3	1.787	66.3	1.822	71.3	1.853
51.4	1.711	56.4	1.751	61.4	1.788	66.4	1.822	71.4	1.853
51.5	1.712	56.5	1.752	61.5	1.789	66.5	1.823	71.5	1.854
51.6	1.713	56.6	1.753	61.6	1.790	66.6	1.824	71.6	1.855
51.7	1.714	56.7	1.754	61.7	1.790	66.7	1.824	71.7	1.855
51.8	1.714	56.8	1.754	61.8	1.791	66.8	1.825	71.8	1.856
51.9	1.715	56.9	1.755	61.9	1.792	66.9	1.825	71.9	1.857
52.0	1.716	57.0	1.756	62.0	1.792	67.0	1.826	72.0	1.857
52.1	1.717	57.1	1.757	62.1	1.793	67.1	1.827	72.1	1.858
52.2	1.718	57.2	1.758	62.2	1.794	67.2	1.827	72.2	1.858
52.3	1.719	57.3	1.759	62.3	1.794	67.3	1.828	72.3	1.859
52.4	1.719	57.4	1.760	62.4	1.795	67.4	1.828	72.4	1.859
52.5	1.720	57.5	1.760	62.5	1.796	67.5	1.829	72.5	1.860
52.6	1.721	57.6	1.760	62.6	1.797	67.6	1.830	72.6	1.860
52.7	1.722	57.7	1.761	62.7	1.797	67.7	1.831	72.7	1.861
52.8	1.723	57.8	1.762	62.8	1.798	67.8	1.831	72.8	1.862
52.9	1.723	57.9	1.763	62.9	1.799	67.9	1.831	72.9	1.862
53.0	1.724	58.0	1.763	63.0	1.799	68.0	1.832	73.0	1.863
53.1	1.725	58.1	1.764	63.1	1.800	68.1	1.833	73.1	1.863
53.2	1.726	58.2	1.765	63.2	1.801	68.2	1.834	73.2	1.864
53.3	1.727	58.3	1.766	63.3	1.801	68.3	1.835	73.3	1.865
53.4	1.728	58.4	1.767	63.4	1.802	68.4	1.835	73.4	1.865
53.5	1.728	58.5	1.767	63.5	1.803	68.5	1.836	73.5	1.866
53.6	1.729	58.6	1.768	63.6	1.803	68.6	1.836	73.6	1.866
53.7	1.730	58.7	1.769	63.7	1.804	68.7	1.837	73.7	1.867
53.8	1.731	58.8	1.770	63.8	1.805	68.8	1.837	73.8	1.868
53.9	1.732	58.9	1.770	63.9	1.806	68.9	1.838	73.9	1.868
54.0	1.732	59.0	1.771	64.0	1.806	69.0	1.839	74.0	1.869
54.1	1.733	59.1	1.772	64.1	1.807	69.1	1.839	74.1	1.869
54.2	1.734	59.2	1.772	64.2	1.808	69.2	1.840	74.2	1.870
54.3	1.735	59.3	1.773	64.3	1.808	69.3	1.840	74.3	1.870
54.4	1.736	59.4	1.774	64.4	1.809	69.4	1.841	74.4	1.871
54.5	1.736	59.5	1.775	64.5	1.810	69.5	1.842	74.5	1.872
54.6	1.737	59.6	1.775	64.6	1.810	69.6	1.842	74.6	1.872
54.7	1.738	59.7	1.776	64.7	1.811	69.7	1.843	74.7	1.873
54.8	1.739	59.8	1.777	64.8	1.812	69.8	1.843	74.8	1.873
54.9	1.740	59.9	1.777	64.9	1.812	69.9	1.844	74.9	1.874

Table 6-4 (Part 4 of 4). Logarithms for numbers 75.0 to 100.0.

A	B	A	B	A	B	A	B	A	B
75.0	1.875	80.0	1.903	85.0	1.929	90.0	1.954	95.0	1.977
75.1	1.875	80.1	1.903	85.1	1.929	90.1	1.954	95.1	1.978
75.2	1.876	80.2	1.904	85.2	1.930	90.2	1.955	95.2	1.978
75.3	1.876	80.3	1.904	85.3	1.930	90.3	1.955	95.3	1.979
75.4	1.877	80.4	1.905	85.4	1.931	90.4	1.956	95.4	1.979
75.5	1.877	80.5	1.905	85.5	1.931	90.5	1.956	95.5	1.980
75.6	1.878	80.6	1.906	85.6	1.932	90.6	1.957	95.6	1.980
75.7	1.879	80.7	1.907	85.7	1.932	90.7	1.957	95.7	1.980
75.8	1.879	80.8	1.907	85.8	1.933	90.8	1.958	95.8	1.981
75.9	1.880	80.9	1.907	85.9	1.933	90.9	1.958	95.9	1.981
76.0	1.880	81.0	1.908	86.0	1.934	91.0	1.959	96.0	1.982
76.1	1.881	81.1	1.909	86.1	1.935	91.1	1.959	96.1	1.982
76.2	1.881	81.2	1.909	86.2	1.935	91.2	1.960	96.2	1.983
76.3	1.882	81.3	1.910	86.3	1.936	91.3	1.960	96.3	1.983
76.4	1.883	81.4	1.910	86.4	1.936	91.4	1.961	96.4	1.984
76.5	1.883	81.5	1.911	86.5	1.937	91.5	1.961	96.5	1.984
76.6	1.884	81.6	1.911	86.6	1.937	91.6	1.962	96.6	1.984
76.7	1.884	81.7	1.912	86.7	1.938	91.7	1.962	96.7	1.985
76.8	1.885	81.8	1.912	86.8	1.938	91.8	1.963	96.8	1.985
76.9	1.885	81.9	1.913	86.9	1.939	91.9	1.963	96.9	1.986
77.0	1.886	82.0	1.913	87.0	1.939	92.0	1.963	97.0	1.986
77.1	1.887	82.1	1.914	87.1	1.940	92.1	1.964	97.1	1.987
77.2	1.887	82.2	1.914	87.2	1.940	92.2	1.964	97.2	1.987
77.3	1.888	82.3	1.915	87.3	1.941	92.3	1.965	97.3	1.988
77.4	1.888	82.4	1.915	87.4	1.941	92.4	1.965	97.4	1.988
77.5	1.889	82.5	1.916	87.5	1.942	92.5	1.966	97.5	1.989
77.6	1.889	82.6	1.916	87.6	1.942	92.6	1.966	97.6	1.989
77.7	1.890	82.7	1.917	87.7	1.942	92.7	1.967	97.7	1.989
77.8	1.890	82.8	1.918	87.8	1.943	92.8	1.967	97.8	1.990
77.9	1.891	82.9	1.918	87.9	1.943	92.9	1.968	97.9	1.990
78.0	1.892	83.0	1.919	88.0	1.944	93.0	1.968	98.0	1.991
78.1	1.892	83.1	1.919	88.1	1.944	93.1	1.968	98.1	1.991
78.2	1.893	83.2	1.920	88.2	1.945	93.2	1.969	98.2	1.992
78.3	1.893	83.3	1.920	88.3	1.945	93.3	1.969	98.3	1.992
78.4	1.894	83.4	1.921	88.4	1.946	93.4	1.970	98.4	1.992
78.5	1.894	83.5	1.921	88.5	1.946	93.5	1.970	98.5	1.993
78.6	1.895	83.6	1.922	88.6	1.947	93.6	1.971	98.6	1.993
78.7	1.895	83.7	1.922	88.7	1.947	93.7	1.971	98.7	1.994
78.8	1.896	83.8	1.923	88.8	1.948	93.8	1.972	98.8	1.994
78.9	1.897	83.9	1.923	88.9	1.948	93.9	1.972	98.9	1.995
79.0	1.897	84.0	1.924	89.0	1.949	94.0	1.973	99.0	1.995
79.1	1.898	84.1	1.924	89.1	1.949	94.1	1.973	99.1	1.996
79.2	1.898	84.2	1.925	89.2	1.950	94.2	1.974	99.2	1.996
79.3	1.899	84.3	1.925	89.3	1.950	94.3	1.974	99.3	1.996
79.4	1.899	84.4	1.926	89.4	1.951	94.4	1.974	99.4	1.997
79.5	1.900	84.5	1.926	89.5	1.951	94.5	1.975	99.5	1.997
79.6	1.900	84.6	1.927	89.6	1.952	94.6	1.975	99.6	1.998
79.7	1.901	84.7	1.927	89.7	1.952	94.7	1.976	99.7	1.998
79.8	1.902	84.8	1.928	89.8	1.953	94.8	1.976	99.8	1.999
79.9	1.902	84.9	1.928	89.9	1.953	94.9	1.977	99.9	1.999
								100.0	2.000

The nomogram method uses the nomograms in Appendix E for the specific decay rate involved. The mathematical method requires a hand-held pocket calculator that has a power function, which is represented by a button labeled either “y<sup>x</sup>” or “x<sup>y</sup>.”

Visualize the problem by preparing a situation matrix as follows:

Rt	t	R1	n
100 cGyph	H + 5 hours	?	1.2

**Step 1.** Write the situation matrix (at left) to properly record the information in the problem.

**Step 2.** Find the nomogram for fallout decay using a decay rate (n) of 1.2 (see Figure E-16).

**Step 3.** Lineup a hairline on the value of 100 cGyph on the far left hand Rt column. Lay the hairline across 5 in the center Time column.

**Step 4.** Holding the hairline straight and steady, read the value in the right-hand R column. Your answer should be approximately 650 cGyph.

**Second Situation** -Further monitoring determines the decay rate to be 0.9. Monitor A’s reading, using the

procedure of the first situation, is normalized to a new R1 (H+ 1) of 426 cGyph. The commander wants to know what the reading will be at Monitor A’s location at H + 8 hours.

Rt	t	R1	n
7	H = 8 hours	426 cGyph	0.9

**Step 1.** Write the situation matrix (left) to properly record the information in the problem.

**Step 2.** Find the nomogram for fallout decay using a decay rate (n) of 0.9 (see Figure E-14).

**Step 3.** Line up the hairline on the value of 426 cGyph on the far right-hand R1 column. Lay the hairline across 8 in the center Time column. If the correct value is not listed (as in this problem for the number 8 in the Time column), approximate where the number would lie between 5 and 10.

**Step 4.** Holding the hairline straight and steady, read the value in the far left-hand Rt column. This answer should be approximately 65 cGyph.

Use the nomograms in Appendix E to solve similar problems. Be sure to select the correct nomogram for the stated decay rate.

## Normalizing Factor

The NF corrects dose rate readings to the selected reference time. Readings from radiological surveys received from units must be normalized to H + 1 for use in plotting fallout contamination. The H + 1 calculations also are needed to estimate total dose. Normalizing factors may be found by using any of three methods: a table of values, mathematical, or graphical. The table of values method is the preferred method. The mathematical and graphical methods are discussed in Appendix F.

Tables 6-5 and 6-6 (next two pages) are examples of tables of normalizing factors for selected times after a nuclear burst and for anticipated decay exponents. The reference time in Table 6-5 is H + 1. The reference time in Table 6-6 is H + 48 hours. This type of table normally is used when H-hour is known and the collection is initiated immediately. The following steps outline the procedure for using a table of values.

**Step 1.** Determine the time in hours and minutes after the burst that the reading was taken.

**Step 2.** Enter Table 6-5 with the time after burst. Read across to the appropriate decay exponent column and find the NF.

**Step 3.** Multiply the dose-rate reading by the normalization factor. The product is the H + 1 dose-rate reading.

The following example uses the table of values to determine the normalization factor, and uses it to convert R2 to R1.

### Example

The outside dose rate at 1 hour and 20 minutes after the burst was 100 cGyph. Enter Table 6-5 with 1 hour and 20 minutes and extract the normalizing factor of 1.41 from the 1.2 decay exponent column. (Because decay was not stated, assume standard decay of 1.2.) Calculate R1 as follows:

$$R1 = NF \times R2$$

$$R1 = 1.41 \times 100 \text{ cGyph}$$

$$R1 = 141 \text{ cGyph.}$$

## Total Dose Procedures

The dose rate of radiation does not directly determine whether or not personnel become casualties. Casualties depend on total dose received. If the dose rate were constant, total dose would simply be the product of the dose rate and the time spent in the contaminated area (just as in a road movement problem, Rate x Time = Distance).

But the dose rate continually diminishes because of decay. This makes the calculation more complicated. The actual dose received is always less than the product of dose rate at time of entry times duration of stay.

Total dose, time of entry, and time of stay calculations in fallout areas are solved in total dose nomograms. These

nomograms are based on anticipated decay rates of  $n = 0.2$  to  $n = 2.0$  and are in Appendix E.

Total dose nomograms relate total dose,  $H + 1$  dose rate, stay time, and entry time. The index scale is a pivoting line. It is used as an intermediate step between  $D$  and  $R_1$ , and  $T_s$  and  $T_e$ . The index scale value can be used to multiply the  $R_1$  to find the  $D$ . The four values on these nomograms are defined below:

- $D$  = total dose in cGy.
- $R_1$  = dose rate in cGyph one hour after burst ( $H + 1$ ). The  $H + 1$  dose rate ALWAYS must be used. NEVER use a dose rate taken at any other time. Total dose nomograms are never used to determine the  $R_1$ . Decay nomograms are used for this purpose.
- $T_s$  = stay time in hours.
- $T_e$  = entry time (hours after burst).

$R_1$  must be known before the total dose nomograms can be used. If any two of the other three values are known,

the nomograms can be used to find the missing piece of information. Determination of  $R_1$  was discussed earlier.

$D$  and  $R_1$ , and  $T_s$  and  $T_e$  are used together. When working with total dose nomograms, start the problem on the side of the nomogram where the two known values are located. If  $D$  and  $R_1$  are given, start on the left side. If  $T_s$  and  $T_e$  are given, start on the right side. Never begin a problem by joining  $D$  or  $R_1$  with either of the time values.

The following problems are for single explosions only. Multiple-burst fallout procedures are covered later in this chapter.

**Problem 1.**

- Given:  
 $R_1 = 200$  cGyph  
 $T_e = H + 1.5$  hours  
 $T_s = 1$  hour  
 $n = 1.2$ .  
 Find:  $D$ .

**Table 6-5. Normalizing factors (correction to  $H + 1$  hour).**

TIME AFTER BURST	DECAY EXPONENT (n)							
	0.600	0.800	1.000	1.200	1.400	1.600	1.800	2.000
10 min	0.341	0.238	0.167	0.116	0.081	0.057	0.040	0.028
20 min	0.517	0.415	0.333	0.268	0.215	0.172	0.138	0.111
30 min	0.660	0.574	0.500	0.435	0.379	0.330	0.287	0.250
40 min	0.784	0.723	0.667	0.615	0.567	0.523	0.482	0.444
50 min	0.896	0.864	0.833	0.803	0.775	0.747	0.720	0.694
1 hr 0 min	1.000	1.000	1.000	1.000	1.000	1.000	1.000	1.000
1 hr 10 min	1.090	1.130	1.160	1.200	1.240	1.280	1.320	1.360
1 hr 20 min	1.180	1.250	1.330	1.410	1.490	1.580	1.670	1.770
1 hr 30 min	1.270	1.380	1.500	1.620	1.760	1.910	2.070	2.250
1 hr 40 min	1.350	1.500	1.660	1.840	2.040	2.260	2.500	2.770
1 hr 50 min	1.430	1.620	1.830	2.070	2.330	2.630	2.970	3.360
2 hr 0 min	1.510	1.740	2.000	2.290	2.630	3.030	3.480	4.000
2 hr 15 min	1.620	1.910	2.250	2.640	3.110	3.660	4.300	5.060
2 hr 30 min	1.730	2.080	2.500	3.000	3.600	4.330	5.200	6.250
2 hr 45 min	1.830	2.240	2.750	3.360	4.120	5.040	6.170	7.560
3 hr 0 min	1.930	2.400	3.000	3.730	4.650	5.800	7.220	9.000
3 hr 15 min	2.020	2.560	3.250	4.110	5.200	6.590	8.340	10.560
3 hr 30 min	2.120	2.720	3.500	4.490	5.770	7.420	9.530	12.250
3 hr 45 min	2.210	2.870	3.750	4.880	6.360	8.280	10.790	14.060
4 hr 0 min	2.290	3.030	4.000	5.270	6.960	9.190	12.120	16.000
4 hr 20 min	2.410	3.230	4.330	5.810	7.790	10.440	14.000	18.770
4 hr 40 min	2.520	3.420	4.660	6.350	8.640	11.760	16.000	21.770
5 hr 0 min	2.620	3.620	5.000	6.890	9.510	13.130	18.110	25.000
5 hr 20 min	2.730	3.810	5.330	7.450	10.410	14.560	20.350	28.440
5 hr 40 min	2.830	4.000	5.660	8.010	11.340	16.040	22.690	32.110
6 hr 0 min	2.930	4.190	6.000	8.580	12.280	17.580	25.150	36.000
6 hr 20 min	3.020	4.370	6.330	9.160	13.250	19.170	27.720	40.110
6 hr 40 min	3.120	4.560	6.660	9.740	14.230	20.800	30.410	44.440
7 hr 0 min	3.210	4.740	7.000	10.330	15.240	22.490	33.200	49.000
7 hr 20 min	3.300	4.920	7.330	10.920	16.270	24.230	36.100	53.770
7 hr 40 min	3.390	5.100	7.660	11.520	17.310	26.020	39.110	58.770
8 hr 0 min	3.480	5.270	8.000	12.120	18.370	27.850	42.220	64.000
9 hr 0 min	3.730	5.800	9.000	13.960	21.670	33.630	52.190	81.000
10 hr 0 min	3.980	6.310	10.000	15.840	25.110	39.810	63.090	100.000
11 hr 0 min	4.210	6.800	11.000	17.760	28.700	46.360	74.900	121.000
12 hr 0 min	4.440	7.300	12.000	19.720	32.420	53.290	87.600	144.000

Table 6-6. Normalizing factors (correction to H + 48 hours).

TIME AFTER BURST (HOURS)	DECAY RATE (n)														
	0.60	0.70	0.80	0.90	1.00	1.10	1.20	1.30	1.40	1.50	1.60	1.70	1.80	1.90	2.00
H + 48	1.00	1.00	1.00	1.00	1.00	1.00	1.00	1.00	1.00	1.00	1.00	1.00	1.00	1.00	1.00
H + 49	1.01	1.01	1.02	1.02	1.02	1.02	1.03	1.03	1.03	1.03	1.03	1.04	1.04	1.04	1.04
H + 50	1.02	1.03	1.03	1.04	1.04	1.05	1.05	1.05	1.06	1.06	1.07	1.07	1.08	1.08	1.09
H + 51	1.04	1.04	1.05	1.06	1.06	1.07	1.08	1.08	1.09	1.10	1.10	1.11	1.12	1.12	1.13
H + 52	1.05	1.06	1.07	1.07	1.08	1.09	1.10	1.11	1.12	1.13	1.14	1.15	1.15	1.16	1.17
H + 53	1.06	1.07	1.08	1.09	1.10	1.12	1.13	1.14	1.15	1.16	1.17	1.18	1.20	1.21	1.22
H + 54	1.07	1.09	1.10	1.11	1.13	1.14	1.15	1.17	1.18	1.19	1.20	1.22	1.24	1.25	1.27
H + 55	1.09	1.10	1.12	1.13	1.15	1.16	1.17	1.20	1.21	1.22	1.24	1.26	1.28	1.30	1.31
H + 56	1.10	1.11	1.13	1.15	1.17	1.18	1.21	1.23	1.24	1.26	1.28	1.32	1.34	1.34	1.36
H + 57	1.11	1.13	1.15	1.17	1.19	1.21	1.23	1.25	1.27	1.29	1.32	1.34	1.36	1.39	1.41
H + 58	1.12	1.14	1.16	1.19	1.21	1.23	1.25	1.28	1.30	1.33	1.35	1.38	1.41	1.43	1.46
H + 59	1.13	1.15	1.18	1.20	1.23	1.25	1.28	1.30	1.33	1.36	1.39	1.42	1.45	1.48	1.51
H + 60	1.14	1.17	1.20	1.22	1.25	1.28	1.31	1.34	1.37	1.40	1.43	1.47	1.49	1.53	1.56
H + 61	1.15	1.18	1.21	1.24	1.27	1.30	1.33	1.37	1.40	1.43	1.47	1.50	1.54	1.58	1.62
H + 62	1.17	1.20	1.23	1.26	1.29	1.33	1.36	1.39	1.43	1.47	1.50	1.55	1.59	1.63	1.67
H + 63	1.18	1.21	1.24	1.28	1.31	1.35	1.39	1.42	1.46	1.50	1.55	1.59	1.63	1.68	1.72
H + 64	1.19	1.22	1.26	1.30	1.33	1.37	1.41	1.45	1.50	1.54	1.58	1.62	1.68	1.73	1.78
H + 65	1.20	1.24	1.27	1.31	1.35	1.40	1.44	1.48	1.53	1.58	1.62	1.67	1.73	1.78	1.83
H + 66	1.21	1.25	1.29	1.33	1.38	1.42	1.47	1.51	1.56	1.61	1.66	1.72	1.77	1.83	1.89
H + 67	1.22	1.26	1.31	1.35	1.40	1.44	1.49	1.54	1.60	1.65	1.71	1.76	1.82	1.88	1.95
H + 68	1.23	1.28	1.32	1.37	1.42	1.47	1.52	1.57	1.63	1.69	1.75	1.81	1.87	1.94	2.01
H + 69	1.24	1.29	1.34	1.39	1.44	1.49	1.55	1.60	1.66	1.72	1.79	1.85	1.92	1.99	2.07
H + 70	1.25	1.30	1.35	1.40	1.46	1.51	1.57	1.63	1.70	1.76	1.83	1.90	1.97	2.05	2.13
H + 71	1.26	1.32	1.37	1.42	1.48	1.54	1.60	1.66	1.73	1.80	1.87	1.95	2.02	2.10	2.19
H + 72	1.28	1.33	1.38	1.44	1.50	1.56	1.63	1.69	1.76	1.84	1.91	1.99	2.07	2.16	2.25
H + 96	1.52	1.62	1.74	1.87	2.00	2.14	2.30	2.46	2.64	2.83	3.03	3.25	3.48	3.73	4.00
H + 120	1.73	1.90	2.08	2.28	2.50	2.74	3.00	3.29	3.61	3.95	4.33	4.75	5.20	5.70	6.25
H + 144	1.93	2.16	2.41	2.69	3.00	3.35	3.74	4.17	4.66	5.20	5.80	6.47	7.22	8.06	9.00
H + 168	2.12	2.40	2.72	3.09	3.50	3.97	4.50	5.10	5.78	6.55	7.42	8.41	9.54	10.80	12.25

Visualize the problem as follows:

D	R <sub>1</sub>	T <sub>s</sub>	T <sub>e</sub>
?	200 cGyph	1 hour	H + 1.5 hours

Answer: 90 cGy.

Solution:

Select the n = 1.2 total dose nomogram. Connect H + 1.5 hours on the T<sub>e</sub> scale and 1 hour on the T<sub>s</sub> scale with a hairline. Pivot the hairline at its point of intersection with the index scale to the 200 cGyph on the R<sub>1</sub> scale. Read D = 90 cGyph on the total dose scale.

**Problem 2.**

Given:

D = 20 cGy

R<sub>1</sub> = 100 cGyph

T<sub>s</sub> = 1 hour

n = 0.8

Find: T<sub>e</sub>

Visualize the problem as follows:

D	R <sub>1</sub>	T <sub>s</sub>	T <sub>e</sub>
20 cGy	100 cGyph	1 hour	?

Answer: H + 6.6 hours.

Solution Select then = 0.8 total dose nomogram. Connect 20 cGyph on the D scale and 100 cGyph on the R<sub>1</sub> scale. Pivot the hairline at its point of intersection with the index to the 1 hour on the T<sub>s</sub> scale. Read T<sub>e</sub> = 6,6 hours on the T<sub>e</sub> scale.

**Problem 3.**

D = 50 cGy

R<sub>1</sub> = 200 cGyph

T<sub>e</sub> = H + 3 hours

n = 1.6

Find: T<sub>s</sub>.

Visualize the problem as follows:

D	R <sub>1</sub>	T <sub>s</sub>	T <sub>e</sub>
50 cGy	200 cGyph	?	H + 3 hours

Solution: Select then = 1.6 total dose nomogram. Connect 50 cGyph on the D scale and 200 cGyph on the R<sub>1</sub> scale. Pivot the hairline at its point of intersection with the index scale to the 3 hour point on the T<sub>e</sub> scale. Read 2 hours on the T<sub>s</sub> scale.

**Problem 4. (Special case-Hairline off scale)**

Given: R<sub>1</sub> = 10 cGyph

T<sub>s</sub> = 2 hour

T<sub>e</sub> = H + 2 hours

n = 1.4.

Find: D

Answer: 4.6 cGy.

Visualize the problem as follows:

D	R <sub>1</sub>	T <sub>s</sub>	T <sub>e</sub>
?	10 cGyph	2 hours	H + 2 hours

Solution:

Select the n = 1.4 total dose nomogram. Connect 2 hours on the T<sub>e</sub> scale and 2 hours on the T<sub>s</sub> scale with a hairline. Pivot the hairline at its point of intersection with the index scale to 10 cGyph on the R<sub>1</sub> scale. Note that the hairline crosses above the D column. To find D, multiply the value found where the hairline crosses the index scale by the R<sub>1</sub>. In this case, index = 0.46, and R<sub>1</sub> = 10 cGyph. Therefore, D = 4.6 cGy.

By 25 hours after the burst, the change in the rate of decay is so low that it is relatively insignificant. Therefore, a different approach is used to estimate total dose when T<sub>e</sub> is greater than 25 hours. In this case, simply multiply the dose rate at the time of entry by the time of stay. This is written—

D = R<sub>te</sub> x T<sub>s</sub>.

D = total dose (cGy)

R<sub>te</sub> = dose rate (cGyph) at time of entry

T<sub>s</sub> = time of stay (hr).

For example—

Given: R<sub>1</sub> = 3 Gyph

T<sub>s</sub> = 2 hours

T<sub>e</sub> = H + 30 hours

n = 0.9

Find: D

Answer: 28 cGy.

Visualize the problem as follows:

D	R <sub>1</sub>	T <sub>s</sub>	T <sub>e</sub>
?	300 cGyph	2 hours	H + 30 hours

Solution Select the 0.9 decay rate nomogram. Align 2 hours on the T<sub>s</sub> scale with 30 hours on the T<sub>e</sub> scale.

However, in this case there is not a 30 hour scale on the time of entry chart. Use the 0.9 fallout decay nomogram to determine what the dose would beat H + 30 hours.

Find dose:

D = R<sub>te</sub> x T<sub>s</sub>

D = 14 cGyph x 2hr

D = 28 cGy

When T<sub>s</sub> must be calculated against a dose limit or OEG, the above formula must be rearranged:

$$T_s = \frac{D}{R_{te}}$$

Using the data from the previous problem this is solved as follows:

$$T_s = \frac{D}{R_{te}} = \frac{28}{14} = 2 \text{ hours.}$$

Note that the dose rate at the time of entry is used here. Get the time of entry by determining the time the R<sub>1</sub> value will decay to the R<sub>t</sub> value. Using the data from the two previous examples—

$$R_{te} = \frac{D}{T_s} = \frac{28}{2} = 14.$$

Now determine when (time) 300 cGyph will reduce to 14 cGyph. Align the R<sub>1</sub> value and the R<sub>t</sub> value. Note that the hairline crosses the time (t) scale at H + 30 hours.

Sometimes monitors or survey team members will record radiological contamination readings that are not normal readings. This situation may not be apparent until the readings are plotted by the NBCC on the situation map. These readings may record dose rates that are higher than

what would be normal for that area. This difference may be caused by—rainout, which was discussed earlier, overlapping fallout from multiple bursts, and neutron-induced radiation.

## Multiple Burst Procedures

Under nuclear warfare conditions, there probably will be occasions when a fallout prediction overlaps an area in which contamination already exists. Similarly, there may be cases in which fallout predictions overlap each other. For example, two fallout-producing bursts can occur within a few hours of each other—one upwind from the other.

Use the following rule for determining the relative hazard when two or more fallout predictions overlap—The hazard classification of an area where predicted fallout hazard zones overlap should be only that of the higher classification involved. That is, an overlap area involving Zone I should be designated Zone I, and an overlap area involving nothing more hazardous than Zone II should be designated Zone II (see Figures 6-6 and 6-7).

The above rule is useful only for a matter of several hours after the bursts. The extent of contamination should be determined as soon as possible from monitoring and survey reports. When bursts are separated by several hours, the pattern already on the ground must be considered with the fallout prediction for the later burst.

It is highly probable that there will be areas on the battlefield subject to fallout from more than one nuclear

weapon detonation. Procedures for predicting future dose rates in areas contaminated by single explosions are not adequate in many instances within overlapping fallout patterns. Fallout produced by more than one explosion normally has different decay exponents at different locations in the area. The next section outlines procedures for predicting future dose rates within overlapping fallout patterns.

## Dose Rate Calculation Methods

The methods described next apply to two or more overlapping fallout patterns. The choice of method depends on whether the dose rates of each burst can be separated. If enough information is not available to separate the bursts or dose rates, refer to Appendix F.

If enough information is known to separate the different dose rates, use the following three steps:

**Step 1.** Separate the dose rates. You need the H-hour of each burst and two or more dose rate readings for the location of interest. Take these readings after the fallout from each burst peaks and prior to the arrival of new

fallout. Use normal procedures for calculating the decay exponent ( $n$ ) for each burst at the location of interest.

**Step 2.** Calculate separately the dose rate for the desired future time for each burst. Add the results. This procedure lets you calculate the total dose rate for a specific location at any time in the future.

**Step 3.** Repeat steps 1 and 2 for each location of interest within the overlapping fallout patterns.

If enough information is not known to separate the different dose rates, use the following procedures:

**Step 1.** For a specific location, use log-log graph paper and plot the last two dose rate measurements (after peak) against the time after the latest burst. (If the time of the latest detonation is unknown, estimate H-hour as the time of the latest known burst.)

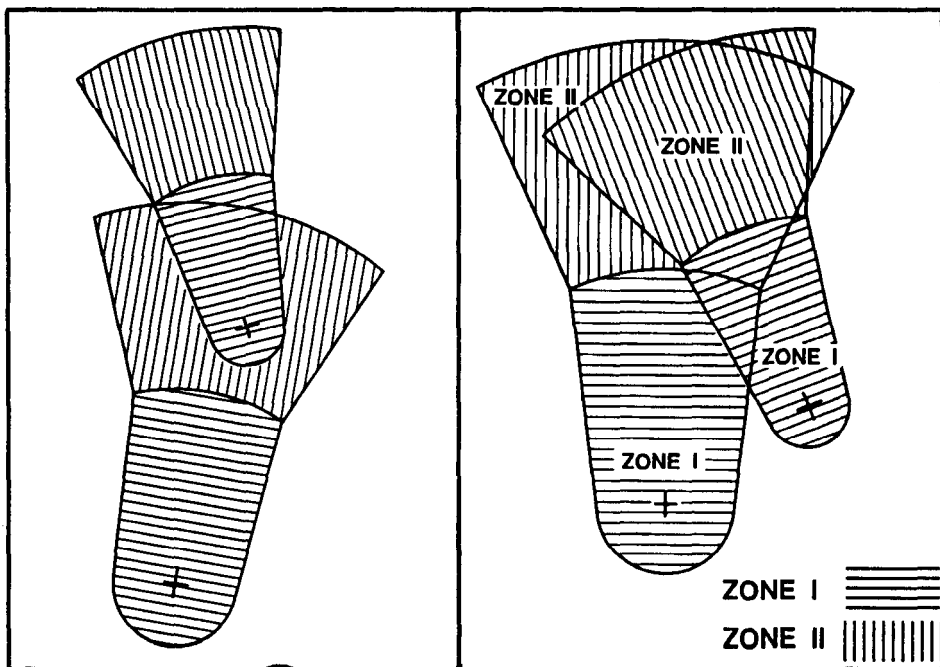

Figure 6-6. First example of overlapping fallout predictions.

Figure 6-7. Second example of overlapping fallout predictions.

**Step 2.** Draw a straight line through these points and extend the line to later times.

**Step 3.** Determine a first approximation of the future dose rate directly from the graph.

**Step 4.** Plot a later dose-rate measurement at that location when it becomes available.

**Step 5.** Draw a straight line through the new latest two points and extrapolate the line to later times.

**Step 6.** Determine a better approximation of the future dose rate directly from the latest extrapolation.

**Step 7.** Repeat steps 4,5, and 6 as later dose rate measurements at that location become available.

**Step 8.** Repeat steps 1 through 7 for each location of interest within the overlapping fallout patterns.

Example of dose rate calculation:

**Problem:** Fallout has been received from two detonations-one at 0800Z and one at 1100Z (see Figure 6-8).

Predict the dose rates for 0800Z at this location 24 hours after the burst. Sufficient data is available to separate the two bursts.

Solution: Separate the two dose rates. This can be done by two different methods: the logarithm method, which is preferred, and the calculator method found in Appendix F.

### Logarithm chart method

R<sub>1a</sub> = Dose rate of first burst at H + 1.

R<sub>2b</sub> = Dose rate at the time of the second burst.

T<sub>2b</sub> = Time in hours after the first burst of the R<sub>2b</sub>

reading.

T<sub>1a</sub> = Time (in hours after first burst) of the R<sub>1a</sub> reading.

$$n = \frac{\log\left(\frac{R_a}{R_b}\right)}{\log\left(\frac{T_b}{T_a}\right)}$$

**Step 1.** Divide 100 by 27 to get 3.7. Turn to Table 6-4 (page 6-10) for the logarithm chart. Read down Column A until you find 3.7. Read across to Column B, and extract the log of 3.7, which is 0.568.

Time	Dose Rate (cGyph)
0900	100 Peak
0930	61
1000	44
1030	33
1100	27
1130	451 Peak
1200	219

Figure 6-8. Example of dose-rate readings.

**Step 2.** Replace  $\frac{100}{27}$  log with 0.568 in the formula.

$$\frac{0.568}{\log\left(\frac{3}{1}\right)}$$

**Step 3.** Repeat Step 1 for log.  $\left(\frac{3}{1}\right)$

Once you divide 3 by 1, you should get 3. Turn to Table 6-4,

and read down Column A until you find 3; read across to Column B, and read 0.477. Substitute this number for  $\log\left(\frac{3}{1}\right)$  in the formula, just as in Step 2.

**Step 4.** The new formula should now look like this:  
 $\frac{0.568}{0.477}$  Divide the top number by the bottom number.

**Step 5.**  $\frac{0.568}{0.477} = 1.190775681$ .

Rounding this number up to the nearest tenth (0.1), your answer should be an n value (or decay rate) of 1.2, which equals standard decay.

**Step 6.** Next, determine the decay rate for the second burst (see Figure 6-8). The second burst occurred at 1100. This is three hours after the first burst. The fallout from the second burst peaked prior to H + 1 (1200). Thus, the reference dose rate for this portion is 219 cGyph. Determine how much of this reading (219 cGyph) was contributed by the first burst. We know that the first burst occurred at 0800. This is four hours prior to our second burst's H + 1 value. Our H + 1 or R<sub>1</sub> value for the first burst was 100 cGyph. Enter the nomogram for fallout decay of 1.2 found in Figure 6-9 with the R<sub>1</sub> value of 100 and H + 4. Read the R<sub>t</sub> value of 19 cGyph. Therefore, 19 cGyph of the 219 cGyph reading at 1200 was contributed by the first burst. Subtract 19 cGyph from 219 cGyph to determine the H + 1 value of the second burst. The formula to determine the decay rate of the second burst would look like this:

$$\frac{\log\left(\frac{219-19}{108-x}\right)}{\log\left(\frac{T_b}{1}\right)}$$

**Step 7.** The last reading in the report was 108 cGyph at 1300 This is five hours after detonation of the first burst. Using the same procedures outlined in Step 6, determine that 14.5 cGyph of the 108 cGyph reading was contributed by the first burst. Substitute the "x" value in our formula with 14.5 and substitute the T<sub>b</sub> value for 2, since 1300 is 2 hours after the second burst. Our formula now looks like this:

$$\frac{\log\left(\frac{219-19}{108-14.5}\right)}{\log\left(\frac{2}{1}\right)} = \log\left(\frac{200}{93.5}\right)$$

**Step 8.** Divide 200 by 93.5. This should equal 2.13. Enter the logarithm chart in Table 6-4 and read down Column A until you find 2.1. Due to the rules of simple rounding, you would go to 2.1. If this is not desired, you may mathematically estimate the log for 2.13. Extract the number 0.322. Divide 2 by 1 and enter the logarithm chart, find 2 and read 0.301. Divide 0.322 by 0.301. This gives you a decay rate for the second burst of 1.069 or 1.1:



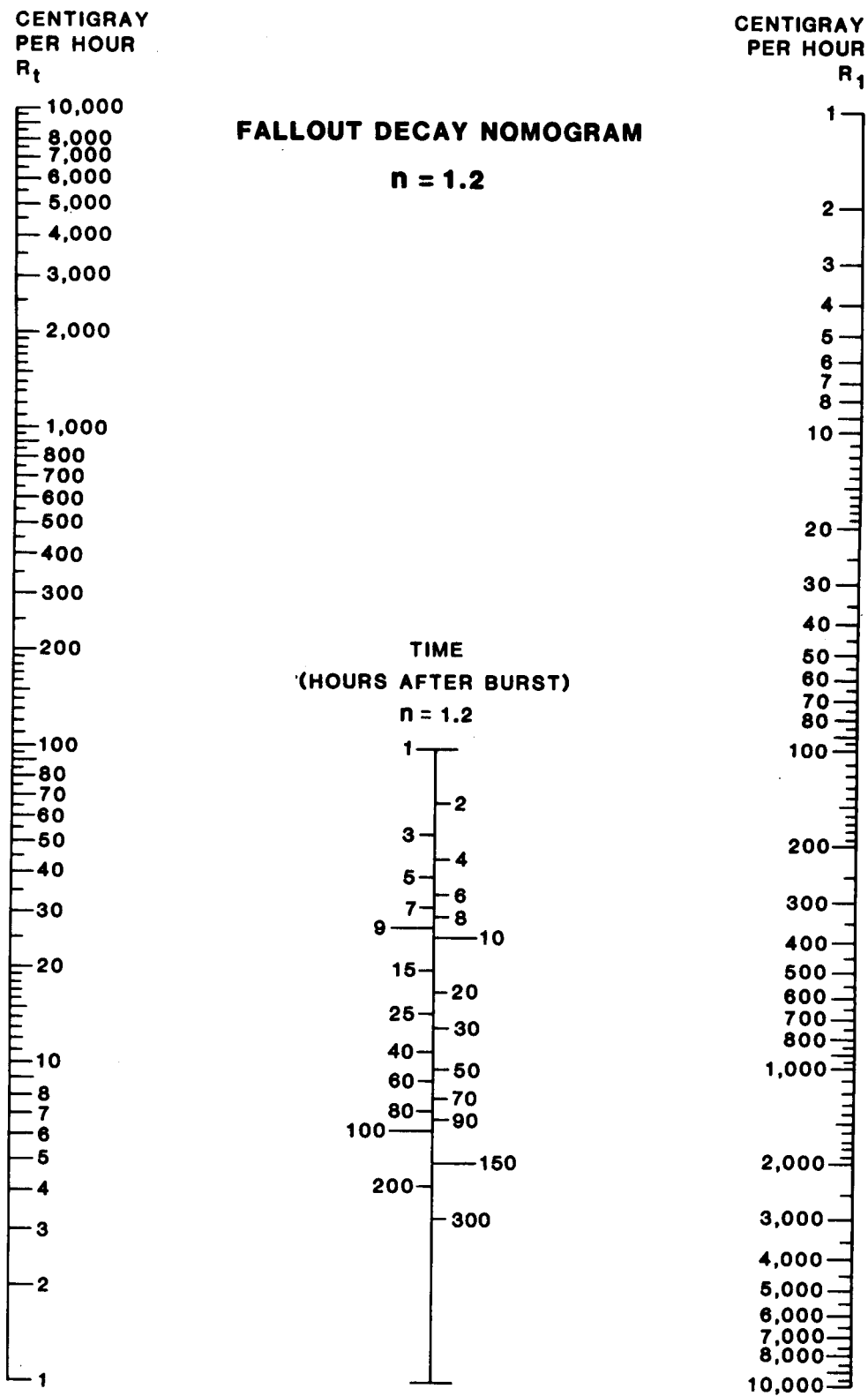

Figure 6-9. Fallout decay nomogram  $n = 1.2$ .

$$\frac{\log\left(\frac{200}{93.5}\right)}{\log\left(\frac{2}{1}\right)} = \frac{0.322}{0.301} = 1.06976, \text{ or } 1.1.$$

The nomogram method may now be used to calculate the dose rate at the time of operational interest.

Using a nomogram, calculate the 0800Z dose rate 24 hours after the first burst by finding the dose rate for that specific time for each burst separately, and add the two values. Use a decay rate of 1.2 for the first burst, and 1.1 for the second:

(n = 1.2 nomogram in Figure 6-9).

$$\frac{R_t}{2.2 \text{ cGyph}} \quad \frac{t}{H + 24} \quad \frac{R_1}{100 \text{ cGyph}}$$

(n = 1.1 nomogram in Figure 6-10).

$$\frac{R_t}{7.0 \text{ cGyph}} \quad \frac{t}{H + 21} \quad \frac{R_1}{200 \text{ cGyph}}$$

Dose rate total at 24 hours after the first burst is calculated as follows:

$$2.2 \text{ cGyph} + 7.0 \text{ cGyph} = 9.2, \text{ or } 9 \text{ cGyph.}$$

### Dose Rate Calculations for Overlapping Fallout

H-hour is known for each burst. At 251500, a 20-KT nuclear weapon was detonated on the surface. Sometime later, fallout arrived on your position. At 1630, a peak dose rate of 126 cGyph was measured. Subsequent readings indicated that n = 1.4. At 251700, another weapon was detonated, and fallout arrived at your position soon after. At 251830, a second peak dose rate of 300 cGyph was measured.

**Note:** This problem also may be calculated with a hand-held pocket calculator. These procedures are outlined in Appendix F. The calculator procedures must be followed if the value for t (time) is less than 1 hour.

**Problem 1.** Assuming that n = 1.2 for the second weapon, what will the dose rate be at 2000? This may be calculated by either of two methods for determining an R<sub>1</sub> value. The first method (A) is to follow the steps for using the nomogram. The second method (B) is outlined in Appendix F.

**Solution:**

When H-hour for each detonation is known, calculate the dose or dose rate for each event, and add them together to get the total dose or dose rate received.

Find R<sub>1</sub> for the first detonation.

Visualize the problem as follows:

R <sub>t</sub>	t	R <sub>1</sub>
126 cGyph	H + 1.5	?

**Step 1.** Using the nomogram in Figure 6-11 for a decay rate of 1.4, line up the hairline across the R<sub>t</sub> value and t value. Read 222 cGyph on the R<sub>1</sub> scale.

Find R<sub>t</sub> at 1830 hours for the first fallout only.

Visualize the problem as follows:

R <sub>t</sub>	t	R <sub>1</sub>
?	H + 3.5	222 cGyph

**Step 2.** Using the same nomogram as in Step 1, lineup the hairline across the R<sub>1</sub> value of 222 and the t value of 3.5 (1830 is 3.5 hours after the first burst). Read the value of 38 on the R<sub>t</sub> scale.

**Step 3.** Find the dose rate contribution at 1830 from the second burst. Subtract the R<sub>t</sub> value determined in Step 2 from the reported dose rate at 1830 (300 cGyph). Dose rate contribution of the second burst is 262 cGyph.

$$R_{t2} = R_t - R_1$$

$$R_t = 300 \text{ cGyph} - 38 \text{ cGyph}$$

$$R_t = 262 \text{ cGyph}$$

**Step 4.** Find R<sub>1</sub> for the second burst only. Follow the procedures outlined in Step 1 to determine the R<sub>1</sub> value. Use the 1.2 nomogram in Figure 6-9. Line up the R<sub>t</sub> value of 262 cGyph and the t value of 1.5. Read the R<sub>1</sub> value of 400 cGyph.

Find R<sub>t</sub> at 2000 hour for each burst.

Visualize the problem as follows:

R <sub>t</sub>	t	R <sub>1</sub>
?	H + 5 hours	222 cGyph

**Step 5.** For first burst, using the same nomogram as in Step 1, lineup the hairline on the R<sub>1</sub> scale at approximately the 222 cGyph value. Hairline must cross the t scale at 5 (H + 5). Read the approximate value of 34 cGyph on the R<sub>t</sub> scale.

$$R_1 = 222 \text{ cGyph}$$

$$t = H + 4 \text{ hours}$$

For the second burst, using the 1.2 decay-rate nomogram as in Step 4, line up the hairline on the R<sub>t</sub> value of 400 cGyph and cross the t scale at 3 (H + 3). Read the R<sub>1</sub> value of 85 cGyph.

**Step 6.** Find the total dose rate at 2000 hours. Total dose rate is the sum of dose rates at that time. Add the R<sub>t</sub> value of 34 cGyph at H + 5 for the first burst and the R<sub>t</sub> value of 85 cGyph at H + 3 for the second burst.

$$\text{total dose at 2000} = R_{t1} + R_{t2}$$

$$\text{total dose at 2000} = 34 \text{ cGyph and } 85 \text{ cGyph}$$

$$\text{total dose at 2000} = 119 \text{ cGyph}$$

**Problem 2.** If a new unit moves into your area at 2200 and occupies foxholes for three hours, what total dose can they expect to receive? To work this portion of the problem, use the total dose nomogram for the decay rate of 1.4 in Figure 6-11.

**Step 1.** Find dose received from first burst.

Visualize the problem as follows:

OD	R <sub>1</sub>	T <sub>s</sub>	T <sub>e</sub>
----	----------------	----------------	----------------

? | 222cGyph | 3 hr | H + 7  
(2200 is 7 hours after the first burst).

**Note:** In computing this problem do not consider any radiation exposure the unit may receive prior to entering the foxholes. For the purposes of this example, only consider the radiation exposure the unit will receive once it (the unit) enters the foxholes.

From Figure 6-11, read the value of 30 cGy. Multiply this value by the transmission factor for foxholes (0.1), found in Table 6-1.

$$ID = OD \times TF$$

$$ID = 30 \text{ cGy} \times 0.1$$

$$ID = 3 \text{ cGy}$$

**Step 2.** Find dose received from the second burst. Visualize the problem as follows:

OD	R <sub>1</sub>	T <sub>s</sub>	T <sub>e</sub>
?	400 cGyph	3 hours	H + 5 hours

(2200 is 5 hours after the second burst).

Using the nomogram for total dose, decay rate 1.2 in Figure 6-12, compute the following:

$$OD = 125 \text{ cGy}$$

$$ID = OD \times TF$$

$$ID = 125 \text{ cGy} \times 0.1$$

$$ID = 12.5 \text{ cGy}$$

**Step 3.** Find the total dose from both bursts.

$$D \text{ total} = D1 + D2$$

$$= 3 \text{ cGy} + 12.5 \text{ cGy}$$

$$= 15.5 \text{ cGy}$$

**Note:** These values apply only to the location where the dose rate measurement was taken. The procedure must be repeated for each additional location.

**Problem 3.**

You have the following information and monitoring data:

- 100900 H-hour
- 101030350 cGyph (peak)
- 101100260 cGyph
- 101200163 cGyph
- 101400 94 cGyph, H-hour, second burst
- 101500100 cGyph
- 101600515 cGyph
- 101700295 cGyph
- 101800216 cGyph
- 101900163 cGyph

Find the dose rate at 111100.

**Solution:**

Since H-hour is known for both detonations, a mathematical procedure can be used.

**Step 1.** Determine the decay constant for the first burst.

$$n = \frac{\log\left(\frac{R_a}{R_b}\right)}{\log\left(\frac{T_b}{T_a}\right)} = \frac{\log\left(\frac{350}{94}\right)}{\log\left(\frac{5}{1.5}\right)} = \frac{\log 3.72}{\log 3.33} = \frac{0.5705}{0.5224}$$

Answer:  $n = 1.09 = 1.1$

**Step 2.** Using  $n = 1.1$ , calculate the contribution the first burst made to the total dose rate after 101500. Using the data presented in the problem and the decay value of 1.1, normalize the peak reading of 350 cGyph at H + 1.5 hours to H + 1. Using Figure 6-10 and the methods discussed previously, determine an H + 1 value of 530 cGyph.

- Dose Rate from First Burst:
- 101000 (H + 1) 530 cGyph
- 101500 (H + 6) 78 cGyph
- 101600 (H + 7) 65 cGyph
- 101700 (H + 8) 55 cGyph
- 101800 (H + 9) 48 cGyph
- 101900 (H + 10) 43 cGyph

**Step 3.** Calculate the decay constant for the second burst.

$$n = \frac{\log\left(\frac{R_a}{R_b}\right) \text{ using } T_a \text{ at } 1000}{\log\left(\frac{T_b}{T_a}\right) \text{ and } T_b \text{ at } 101900}$$

$$= \frac{\log\left(\frac{515 - 65}{163 - 43}\right)}{\log\left(\frac{5}{2}\right)} = \frac{\log\left(\frac{450}{120}\right)}{\frac{5}{2}} = \frac{\log 3.75}{\log 2.5} = \frac{0.5740}{0.3979}$$

Answer:  $n = 1.444 = 1.4$

**Step 4.** Calculate dose rate at 111100 for each burst, and add together.

Visualize the problem for the first burst ( $n = 1.1$ ) as follows:

R <sub>t</sub>	t	R <sub>1</sub>
?	H + 26 hours	530 cGyph

$$R_t = 15 \text{ cGyph}$$

Visualize the problem for the second burst ( $n = 1.4$ ) as follows:

R <sub>t</sub>	t	R <sub>1</sub>
?	H = 21 hours	450 cGyph

$$R_1 = 1100 \text{ cGyph}$$

$$R_t = 16 \text{ cGyph}$$

$$R_{total} = R_{t1} + R_{t2}$$

$$= 15 \text{ cGyph} + 16 \text{ cGyph}$$

Answer:  $R_{total} = 31 \text{ cGyph}$ .

H-hour is known only for the most recent burst. In this circumstance, a graphical approximation must be made.

Situation: There have been several surface bursts which have deposited fallout on your position. H-hour for the

most recent detonation was 150700 hours. Monitoring reports since are listed below:

- 150700 30 cGyph
- 150800 128 cGyph
- 150830263 cGyph (peak)
- 151000 112 cGyph

**Problem:** Find the dose rate at 161000 using these steps:

**Step 1.** On log-log graph paper, plot the peak dose (263 cGyph) and subsequent dose rates. Draw a straight line through them extending to 161000 (H + 27 hours) (see Figure 6-13, page 27).

**Step 2.** Read as first extrapolation, 7.5 cGyph.

Situation (continued): It is now 151300 and you have received these additional reports:

15110083 cGyph

15130055 cGyph.

What is the projected H + 27 dose rate at this time?

**Step 3.** Plot the new data and connect the two most current values with a straight line, extending it to H + 27 hours.

**Step 4.** Read as a second extrapolation, 11.8 cGyph.

Situation (continued): It is now 152400, and the latest monitor report is 22 cGyph.

What is the projected H + 27 rate now?

**Step 5.** Plot the new data and connect the last two values with a straight line extending to H + 27 hours.

**Step 6.** Read as a third extrapolation, 15.5 cGyph.

## Crossing a Fallout Area

In nuclear warfare, it is possible that extensive areas will be contaminated with residual activity. It may be necessary to cross an area where there is residual radiation. This might occur when exploiting our own nuclear bursts or in retrograde or offensive operations coupled with enemy-delivered nuclear bursts. These areas may be occupied eventually, but operations will be complicated because the total dose received by our troops must be kept to a minimum.

When crossing a contaminated area, the dose rate will increase as the center of the area is approached and will decrease as the far side is approached. Therefore, determine an average dose rate for total dose calculations. A reasonable approximation of the average dose rate can be determined by using one-half of the highest dose rate. This is written—

$$R_{1 \text{ avg}} = \frac{R_{1 \text{ max}}}{2}$$

R<sub>1</sub> average = average dose rate at H + 1

R<sub>1</sub>max = highest dose rate encountered or expected to be encountered at H+ 1.

After the average dose rate has been determined, entry times that will keep the total dose below that specified in operational exposure guidance can be computed on the basis of estimated stay times. Total dose also can be computed for specified entry times and stay times. The following paragraphs outline procedures for these calculations.

In calculating the total dose to be received when crossing a fallout area, you need the time of entry into the area, the average dose rate along the route, and the time of stay within the area. Use the total dose nomograms in Appendix E for these calculations.

In crossing, the average dose rate is equal to one-half of the maximum dose rate encountered on the route. If the maximum dose rate encountered is 60 cGyph, then—

$$R_{1 \text{ avg}} = \frac{R_{1 \text{ max}}}{2} = \frac{60 \text{ cGyph}}{2} = 30 \text{ cGyph.}$$

In crossing a fallout area, the length of exposure or time of stay must be calculated. The length of the crossing route within the outer perimeter of the contamination is divided by the average speed of crossing. This speed must be constant.

$$T_s = \frac{\text{distance}}{\text{speed}}, \text{ where } T_s \text{ is time of stay}$$

If the distance across an area is 2 kilometers, and the speed is a constant 20 kilometers per hour then—

$$T_s = \frac{\text{distance}}{\text{speed}} = \frac{2 \text{ km}}{20 \text{ kmph}} = 0.1 \text{ hours, or 6 minutes.}$$

When a unit must cross a contaminated area, it is given OEG. (See Appendix A for more details on OEG.) This is the maximum permissible dose. The unit calculates various entry times and stay times that will keep the total dose below the OEG. The average dose rate also must be known. Transmission factors for vehicles are applied to total dose or dose rates. (Refer to Table 6-1.)

The following problems concern techniques only. They do not consider the impact that these doses or dose rates might have on operations in a contaminated area. When solving for total dose (D) with an actual stay time (T<sub>s</sub>) of less than 1 hour, align the hairline with 1 hour on the appropriate nomogram to obtain a total dose. Multiply this total dose figure by the actual decimal fraction of the time of stay to obtain the true total dose.

### Problem 1.

Troops are to cross the fallout area in Figure 6-14 (page 6-28) at H + 3 hours in M113s moving at 10 kmph. The route from A to B, a distance of 5 km, will be used. (Assume standard decay of 1.2).

Find: Total dose the troops will receive.

Visualize the problem as follows:

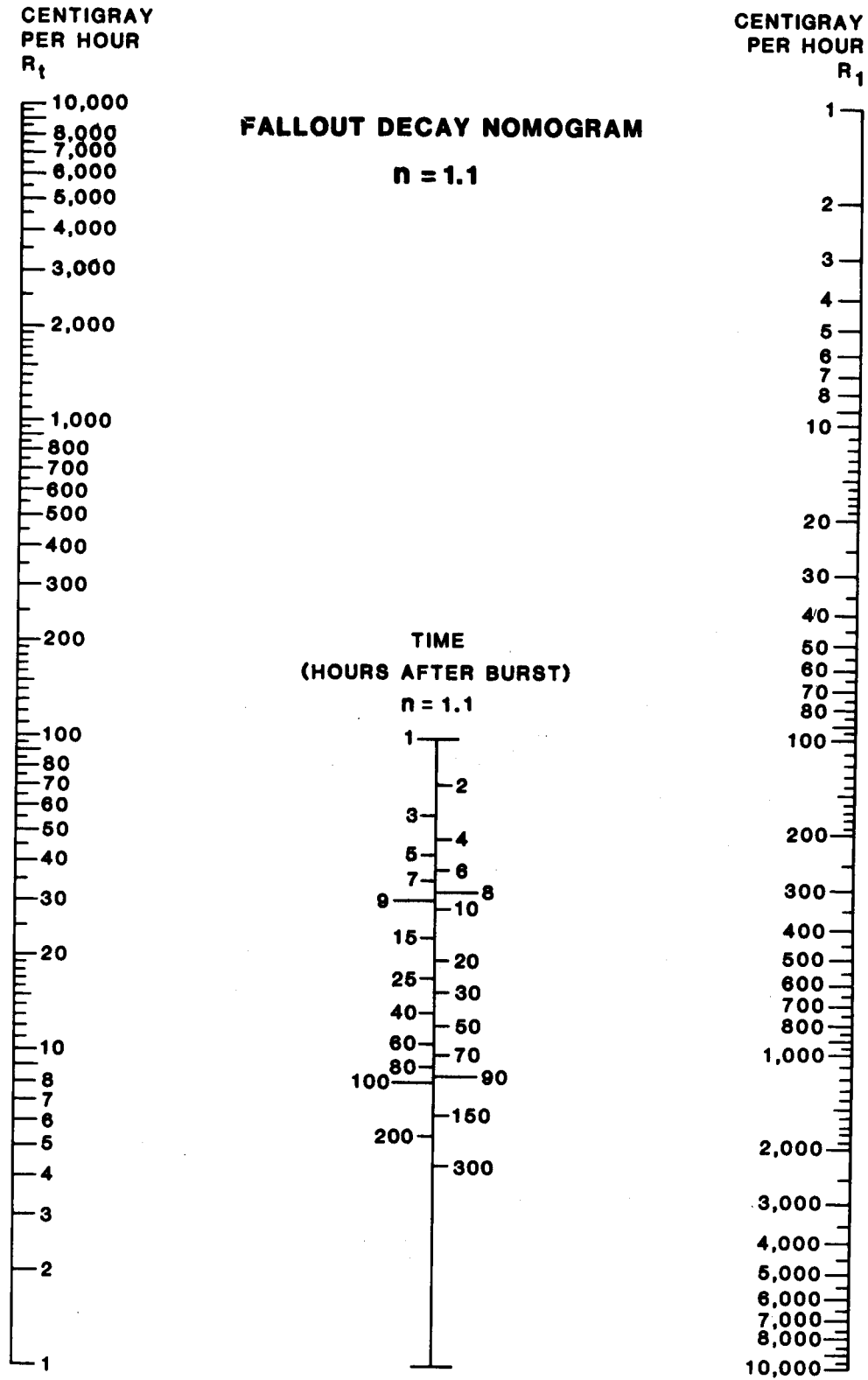

Figure 6-10. Fallout decay nomogram  $n = 1.1$ .

**TOTAL DOSE (FALLOUT)**  
 **$n = 1.4$**

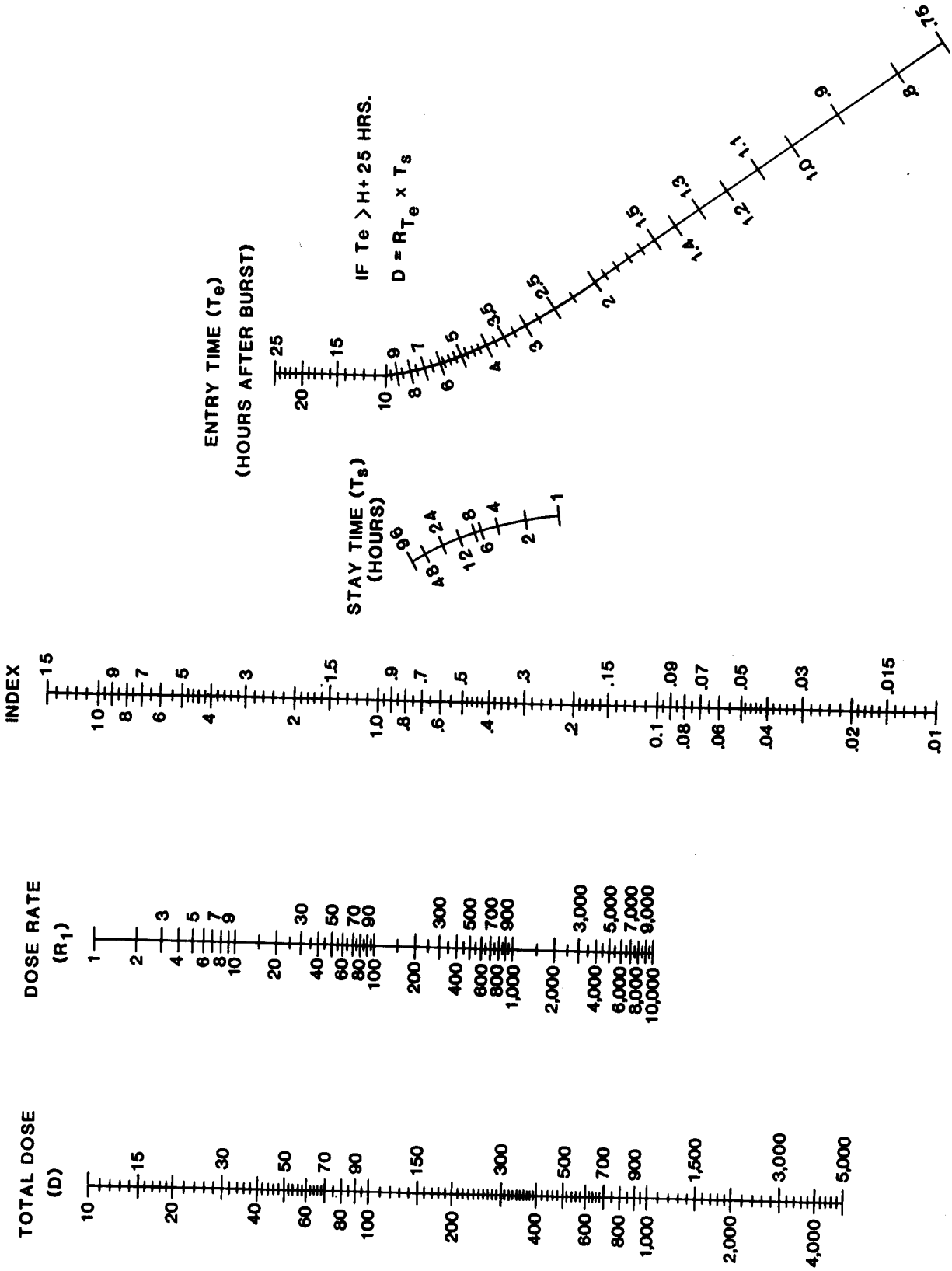

Figure 6-11. Fallout decay nomogram  $n = 1.4$ .

**TOTAL DOSE (FALLOUT)**

**n = 1.2**

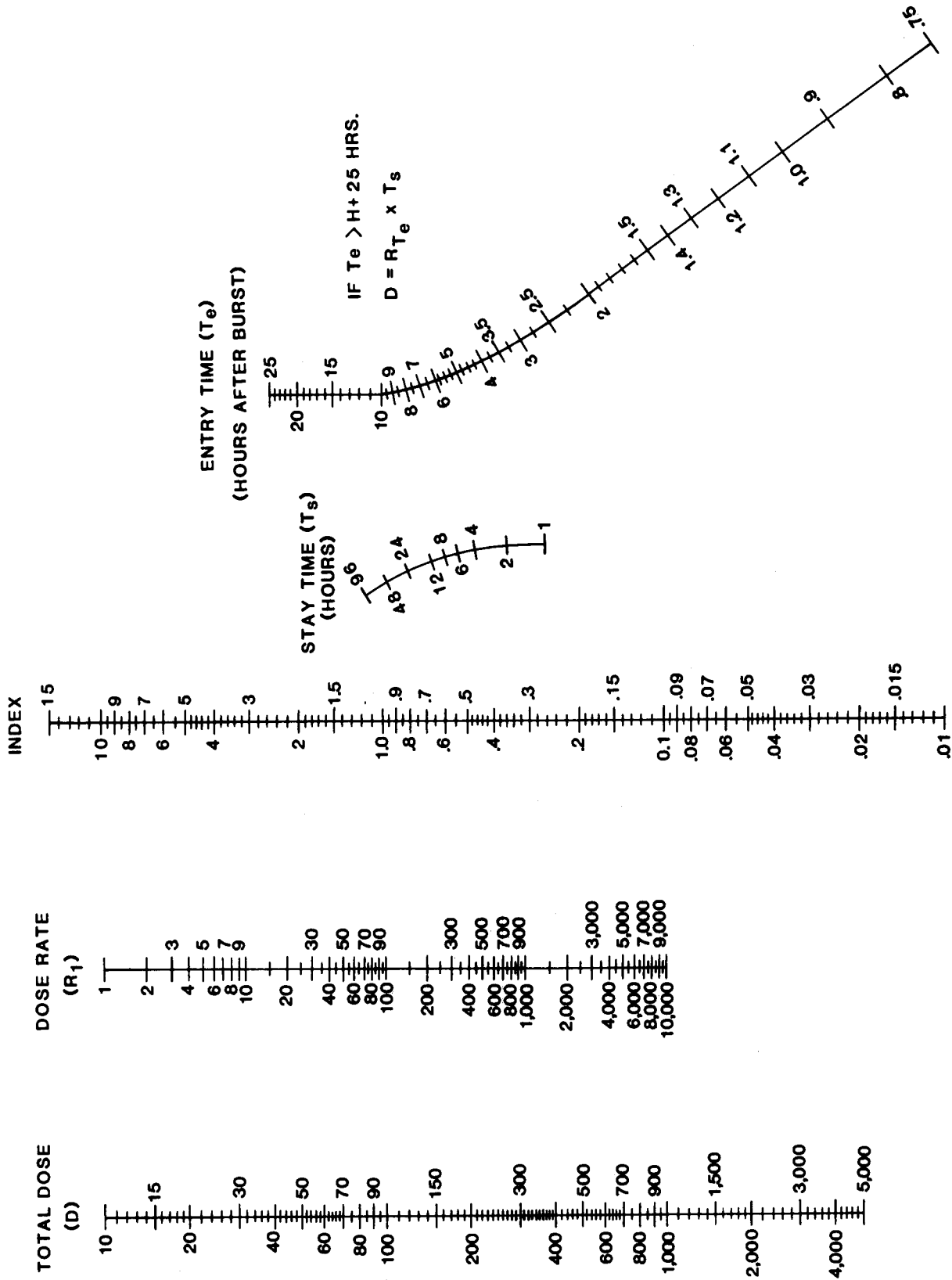

Figure 6-12. Total dose (fallout) nomogram n = 1.2.

D	R <sub>1</sub> avg	T <sub>s</sub>	T <sub>e</sub>
?	150 cGyph	0.5 hours	H + 3 hours

Answer: 9.6 cGy

Solution: Calculate the average dose rate as follows:

$$T_e = H + 3 \text{ hrs}$$

$$T_s = \frac{\text{distance}}{\text{speed}} = \frac{5 \text{ km}}{10 \text{ kmph}} = 0.5 \text{ hours}$$

$$R_1 = (\text{highest exposure anticipated})$$

$$= (300 \text{ cGyph})$$

$$= 150 \text{ cGyph}$$

$$D = ?$$

Use Figure E-36 to compute average dose rate.

D = 32 cGyph outside dose from nomogram at 1 hour T<sub>s</sub>

$$D = 32 \times (.5) T_s$$

$$D = 16 \text{ cGyph.}$$

Calculate the inside dose:

$$TF = 0.3 \text{ (Table 6-1)}$$

$$ID = OD \times IF$$

$$= 16 \times 0.3$$

$$= 4.8 \text{ cGy.}$$

**Problem 2.**

Troops are to cross the fallout area in Figure 6-15 (page 6-28) at H + 3 hours in 2-ton trucks moving at 15 kmph, using the route A-B-C-D-E. Total distance equals 7.5 kilometers.

Find: Total dose the troops will receive.

Answer: 7.2 cGy.

solution

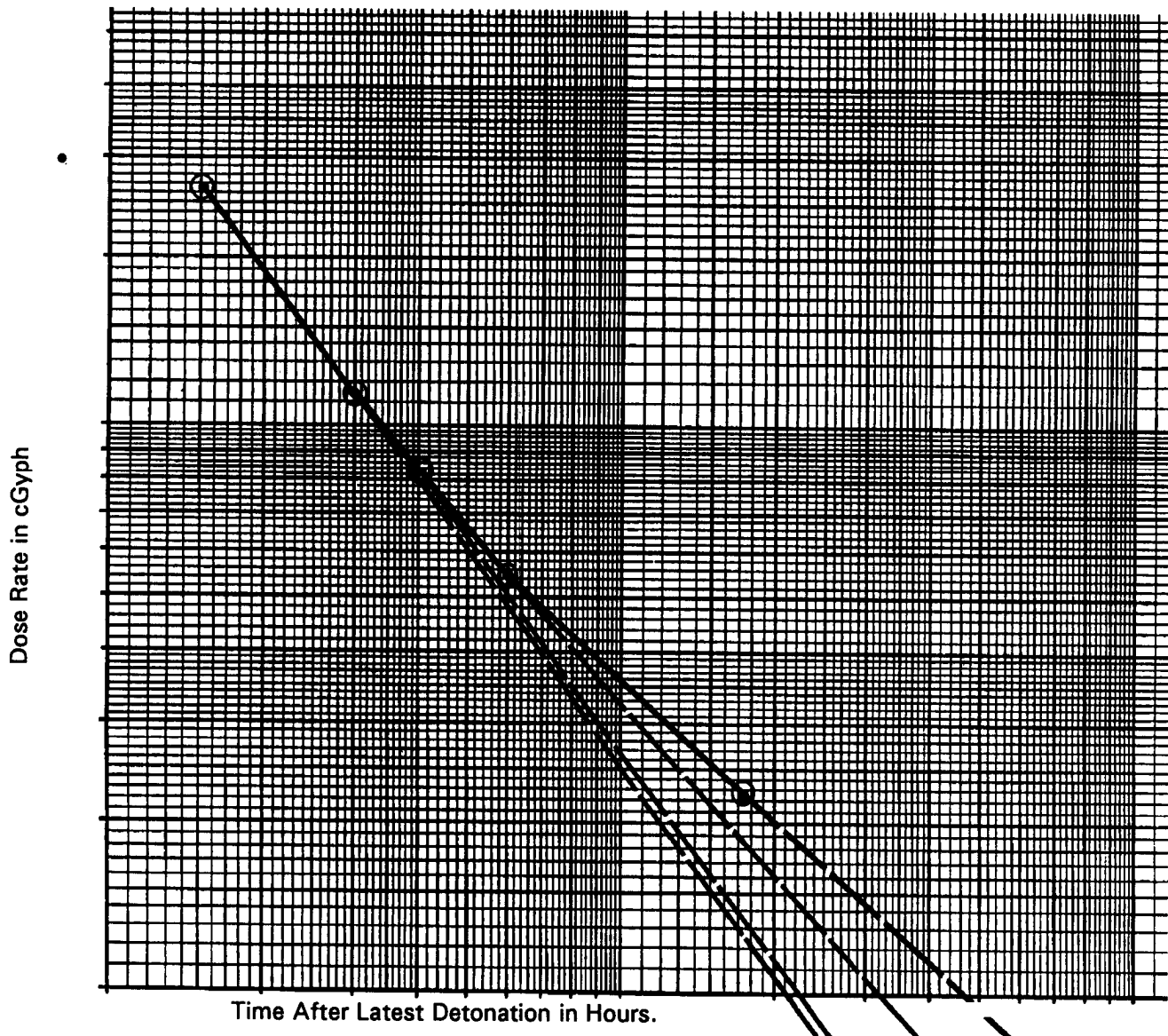

Figure 6-13. Mathematical estimation (extrapolation) method of dose rate prediction, with periodic revisions.



1. Calculate the average dose rate:

$$R_{1avg} = \frac{R_{1max}}{2} = \frac{200cGyph}{2} = 100cGyph \text{ (at H + 1)}$$

(R<sub>1</sub> max at point C interpolated from Figure 6-16 page 6-28).

2. Calculate the time of stay:

$$T_s = \frac{\text{distance}}{\text{speed}} = \frac{7.5}{15kmph} = 0.5\text{hours.}$$

3. Find the outside dose:

$$R_{1avg} = 100 \text{ cGyph}$$

$$T_e = H + 3 \text{ hours}$$

$$T_s = 0.5 \text{ hour}$$

$$D = 12 \text{ cGy.}$$

4. Calculate the inside dose:

$$TF = 0.6 \text{ (Table 6-1)}$$

$$ID = OD \times TF$$

$$= 12 \times 0.6$$

$$= 7.2 \text{ cGy.}$$

**Problem 3.**

A chemical company smoke generator platoon operating within 1st Brigade's sector must top off its fog oil load while moving to the new mission site at the BSA (refer to Figure 6-16, page 6-29). A mountain range 3 kilometers, to the south and enemy activity 3 kilometers to the north prevent the platoon from maneuvering around the contamination. Time to complete this mission is essential. It is now 261830, and the platoon must have smoke on target by 262100 to support the next phase of 1st Brigade's operation. The platoon must move along the main supply route (MSR) to the brigade support area (BSA) to obtain more fog oil. Due to previous operations, the platoon is rated at RES 1 (moderate risk—as explained in Appendix A) and the soldiers are not to exceed 70 cGy total in this movement. The brigade S3 has turned to you, as the chemical staff specialist for 1st Brigade, and asked whether or not the platoon can accomplish this mission and not exceed the 70 cGy OEG. The S3 also wants to know what dose the platoon is expected to receive, and if there are any special precautions the platoon should take to limit its exposure.

Although presented as an example, this may be a typical situation on a nuclear battlefield, and is representative of what is commonly referred to as a crossing problem. The platoon will depart (SP) from its location (NB187262) at 1900 and travel in HMMWVs along the MSR at a speed of 25 kilometers per hour. Using the map scale in Figure E-1, Appendix E, answer the brigade S3's questions.

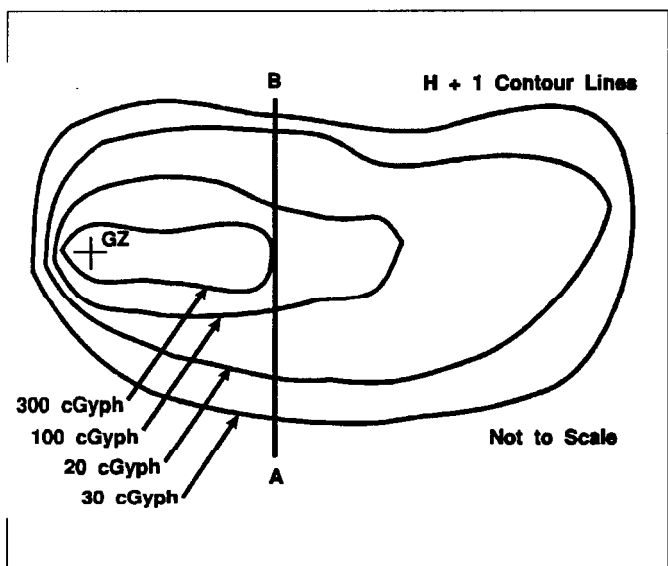

Figure 6-14. Problem 1 fallout area.

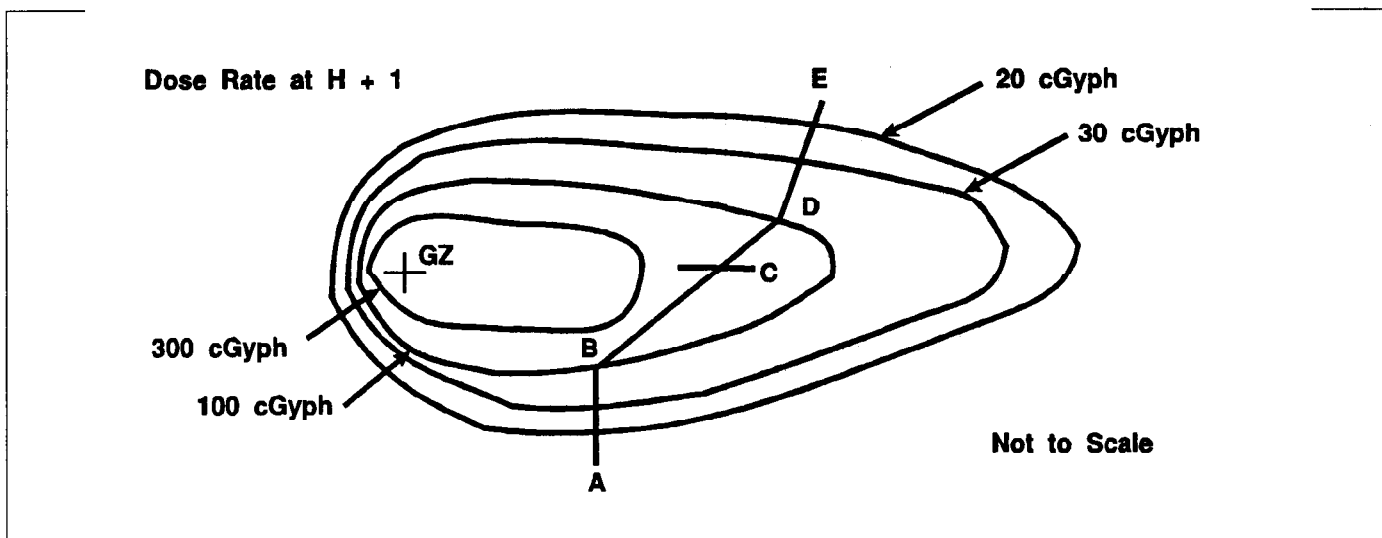

Figure 6-15. Problem 2 fallout area.

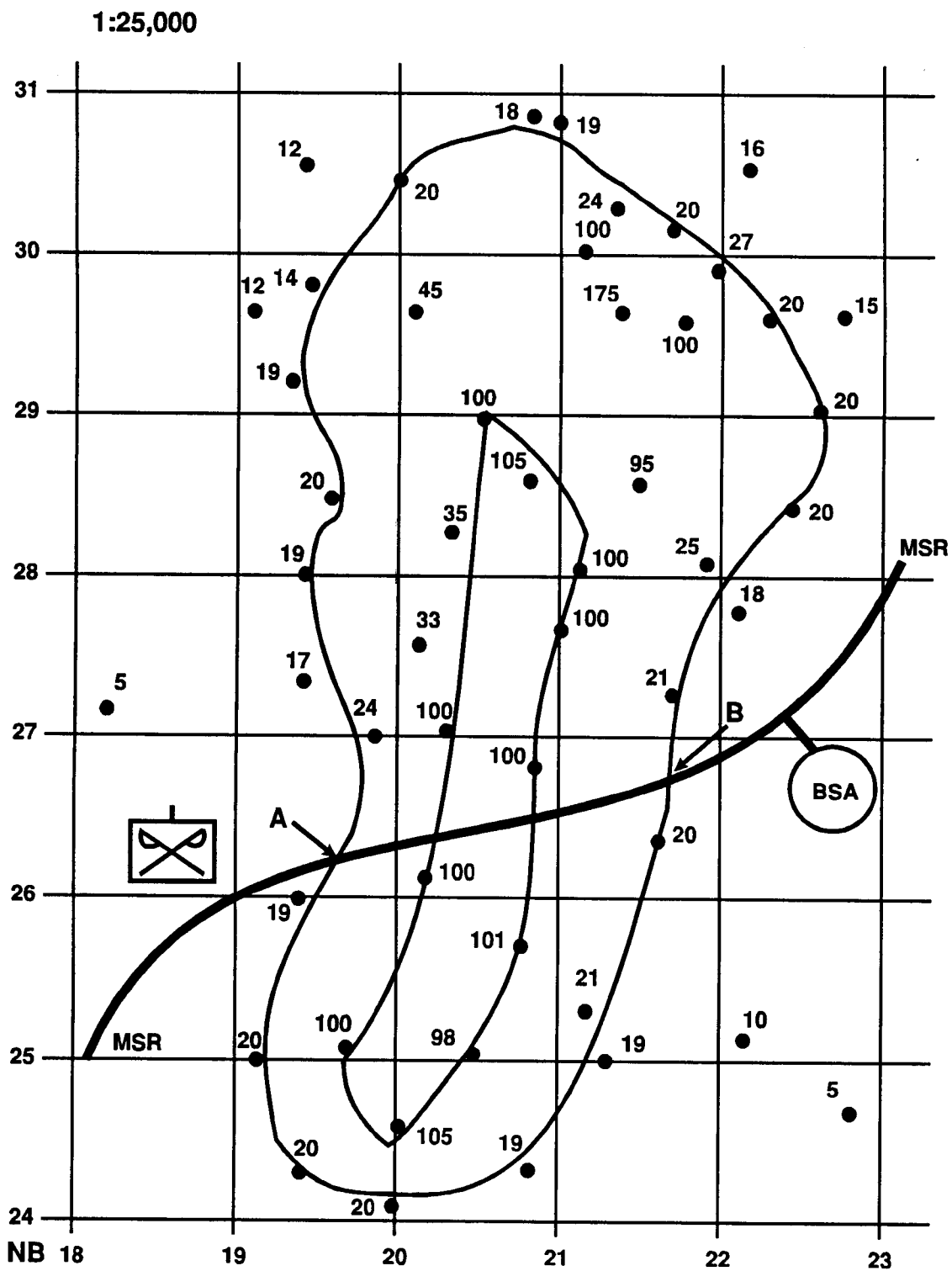

Figure 6-16. Chemical platoon crossing a contaminated area.

**Step 1.** Place a pencil compass on the center of the platoon's position and measure over the 20 cGyph contour line where this contour line crosses the MSR. Without changing the compass gap, place the compass on the map scale in Figure E-1, Appendix E. Use the 1:25,000 scale. The distance from the platoon's position to the 20 cGyph contour line should be 0.6 kms.

**Step 2.** If the platoon departs from its location at 1900, and travels 0.6 kms at 25 kmph, at what time will the platoon enter the contaminated area? To determine this use the following formula:

$$T(\text{time}) = \frac{\text{distance}}{\text{speed}} = \frac{0.6\text{km}}{25\text{kmph}}$$

In other words, with a nuclear burst that occurred at 1500, the unit will depart at H + 4 hours. The distance that the unit must travel down the MSR, before it reaches the contaminated environment will take approximately 1.45 minutes. This is derived by multiplying 0.024 by 60 to gain the time in minutes. When working with radiological contamination, from fallout, 1.45 minutes is immaterial. Because this time and distance is small, for the purpose of this example, use the time of H + 4 for the platoon to enter (T<sub>e</sub>) the contaminated area.

**Step 3.** Setup the remainder of the problem in the following manner—

$$ID_t = TF \times D.$$

ID<sub>t</sub> = inside total dose received

TF = transmission factor for HMMWVs (see Table 6-1)

D = total dose received (unshielded).

Visualize the problem of finding D (total dose):

D	R <sub>1</sub> avg	T <sub>s</sub>	T <sub>e</sub>
?	?	?	H + 4 hours

R<sub>1</sub> avg = average R<sub>1</sub> value

T<sub>s</sub> = time of stay in contaminated area

T<sub>e</sub> = time in which unit enters the contaminated area

In this example, use H + 4 as the T<sub>e</sub> value.

**Step 4.** Referring back to Figure 6-16, the highest dose rate the platoon is expected to encounter is 100 cGyph—used as the R<sub>1</sub> max, because it is the highest known dose rate along the MSR. Unless a survey actually establishes the actual R<sub>1</sub> max, use the known dose rates found on T<sub>e</sub> overlay graphics. Calculate the R<sub>1</sub> average for the problem:

$$R_{1\text{avg}} = \frac{R_{1\text{max}}}{2} = \frac{100\text{cGyph}}{2} = 50\text{cGyph}.$$

Now, go back to the visualization in Step 3, and plug in the value for R<sub>1</sub> avg.

Plug into the visualization (Step 3) the value for TF from Table 6-1.

**Step 5.** Measure the map distance from Point A (intersection of the 20 cGyph contour line and the MSR) to Point B, where the platoon will exit the contamination. This distance should equal approximately 1.4 kilometers. Time of stay (T<sub>s</sub>) is calculated as follows:

$$T_s = \frac{\text{distance}}{\text{speed}} = \frac{1.4\text{km}}{25\text{kmph}} = 0.056\text{hours}.$$

**Step 6.** Turn to Figure 6-12, page 6-26, the total dose nomogram for a decay rate of 1.2. Align the hairline across the T<sub>e</sub> value of H + 4. Again, find that the T<sub>s</sub> value is less than 1 hour. As described earlier, place the hairline on 1. Pin the hairline down on the index scale (middle scale); and rotate the hairline so that it crosses the R<sub>1</sub> scale at the R<sub>1</sub> value of 50 cGyph. Read the value in the far left-hand column labeled Total Dose (D). Again, this value is off the printed scale.

In this case and all similar cases in which the hairline falls off the scale, there are two ways to solve the problem. First method is to multiply the R<sub>1</sub> avg value (50 cGyph) by 10. When rotating the hairline on the index scale, lay the hairline across the new R<sub>1</sub> avg value of 500 cGyph. Read adjusted total dose from the far left-hand column. In this case, that dose is approximately 80 cGyph. Divide this number (80 cGyph) by 10 to find actual dose—in this case, 8 cGy. The second method is to multiply the R<sub>1</sub> value by the index value where the hairline crosses the index scale. Both methods are correct, and the preferred method is left to the individual. Place this value in the visualization.

**Step 7.** This dose (8 cGy) is the dose for a T<sub>s</sub> of 1 hour. In this problem the T<sub>s</sub> value was 0.056. To determine the actual outside, unshielded dose in this area, multiply the dose by the T<sub>s</sub>:

$$\begin{aligned} D_{\text{adj}} &= D \times T_s \\ &= 8 \times 0.056 \\ D_{\text{adj}} &= 0.448 \text{ cGy}. \end{aligned}$$

So, for this problem the actual unshielded dose the soldiers may receive is less than 1 cGy or 0.448 cGy. However, the soldiers are in HMMWVs.

**Step 8.** Multiply the dose (0.448 cGy) by the transmission factor for HMMWVs (0.6) to calculate the inside, shielded dose rate the soldiers can expect to receive:

$$\begin{aligned} ID_t &= 0.448 \text{ cGy} \times 0.6 \\ &= 0.2688 \text{ or } 0.3 \text{ cGy}. \end{aligned}$$

soldiers of the chemical platoon are expected to receive 0.3 cGy, or less than 1 cGy, during their movement. Keep in mind that this calculation is based on a HMMWV transmission factor that was obtained using a radioactive source that is almost twice as strong as average fallout. So, the actual dose the soldiers receive may be less.

To answer the brigade S3's question, give the final dose the soldiers will receive. The S3 does not want to know how you arrived at those numbers—just the information. In this case, the soldiers are expected to receive 0.2688 cGy. As stated originally, the platoon is rated at RES-1 moderate risk. Refer to Appendix A to determine the risk value. From Table A-2 in Appendix A, moderate risk for RES-1 units is less than or equal to 30 cGy. Add the expected dose of 0.2688 or 0.3 cGy to determine what RES category the platoon will be in after its movement. The answer to the brigade S3's question is "Yes," the platoon can

accomplish the move without exceeding 70 cGy total exposure. No additional protective measures are required other than to cover the nose and mouth with a cloth or wear the protective mask to protect the respiratory track from airborne radiological contaminants. If for some reason (enemy activity, vehicle breakdown, etc.) the platoon has to extend its stay in the area, new calculations must be made using the new value for  $T_s$ .

If the actual dose received by the platoon were to exceed the prescribed dose, you should suggest they either delay

the platoon's entry into the area, increase the traveling speed of the vehicles, or add shielding to the vehicles (see Appendix B for adding shielding). In some cases all three steps outlined here may be used to reduce the dose received and meet mission requirements.

To calculate the time of exit ( $T_x$ ) in this problem, or exactly when the platoon must exit the area, use the following formula:

$$T_x = T_e + T_s.$$

## Application of Avoidance Principles

The concepts presented in this chapter can be applied to the integrated battlefield. To do this, you use the checklist in Appendix G as a guide for tactical operations.

### ANBACIS System

As discussed in Chapter 2, ANBACIS is a computer system capable of generating NBC warning and reporting messages; but the system also is capable of calculating

EDMs and radiological calculations for total dose, crossing problems and induced radiation.

Chapter 7

# Neutron-Induced Radiation Areas

As discussed in the beginning of Chapter 3, neutrons are produced in all nuclear weapon bursts. Some of these neutrons may be captured by the various elements in the soil under the burst. As a result, these elements become radioactive, emitting beta particles and gamma radiation for an extended period.

Beta particles are a negligible hazard unless the radioactive material makes direct contact with the skin for an extended period or is inhaled. Beta particles can cause skin irritations varying from reddening to open sores. In contrast, gamma radiation readily penetrates the body and can cause radiation injury and even death. To determine the external military hazard posed by induced radiation, an analysis of the dose rate of the emitted gamma radiation must be determined. For this reason neutron-induced areas are considered areas of gamma activity.

The location of a suspected induced-radiation area created by an airburst is determined by nuclear burst data. Weather conditions have no influence upon its location or size. Surface winds will not affect the pattern. The pattern, if produced, will always be around GZ. The size of the pattern depends on the yield of the weapon and the height of burst. Figure 7-1 shows the boundaries of the induced area for different yields. Refer to Figure 7-4 (page 7-3 and page 7-4) for the Keller Nomogram. Assuming an optimum height of the weapon (or interpolated if not listed), the distance given is the maximum horizontal radius to which a 2-cGyph dose rate will extend one hour after burst.

Estimated Yield (KT)	2-cGyph dose rate at H + 1 hr Horizontal Radius (meters)
0.1	300
1	530
10	760
100	1,080
1,000	2,000

Figure 7-1. Radii of induced contamination.

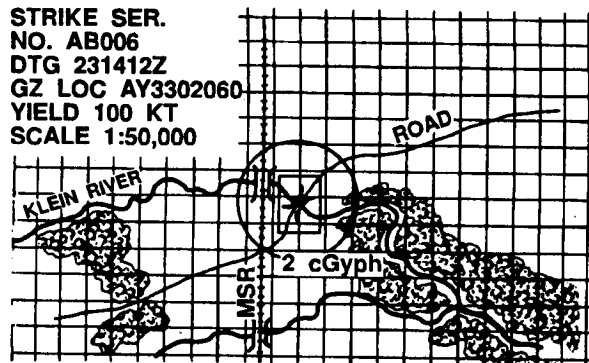

Figure 7-2. Sample overlay of a suspected neutron-induced contamination area.

On the map overlay, this radius is drawn about the GZ point as a circle. The circle is labeled, and nuclear burst data and overlay data are recorded. (See Figure 7-2.) This area is regarded as contaminated until actual dose-rate readings indicate otherwise. The actual area of contamination is usually substantially less, depending upon actual yield and height of burst.

Avoid neutron-induced radiation areas whenever possible. If the area cannot be avoided, the commander must follow the protection techniques for fallout.

To avoid neutron-induced radiation, the commander must know where the suspected area may be. All enemy airbursts are assumed to create hazard areas. Friendly bursts employed in packages may create induced areas very near one another. Commanders must understand that the GZ for an airburst should not be crossed for 24 to 96 hours after the burst. Routine occupancy of an area of induced radiation is possible from two to five days after burst. In this case, low dose rates become even more significant. This is because of the accumulated dose acquired over the period of exposure. A commander should seek the least contaminated region available. During occupancy, the area should be checked with the dosimeter once an hour.

## Plotting NIGA Areas

To plot a neutron-induced gamma activity area, enter Figure 7-4, Part 1 or Part 2, with the known yield on the left side of the chart. Lay the hairline across the chart and pin down the hairline on the dark black index line. Rotate the hairline laterally and read the radii of the NIGA pattern in hundreds of meters at the bottom of the chart.

## Decay of Induced Radiation

The soil in the target area is radioactive to a depth of 0.5 meter at GZ. In contrast, fallout is a deposit of radioactive dust on the surface. From this it can be seen that decon of the induced-radiation area is impractical.

Decay characteristics of induced radiation are considerably different from those of fallout. Fallout is a mixture of many substances, all with different rates of decay. Induced radiation is produced primarily in aluminum, manganese, and sodium. Other elements, such as silicon, emit so little gamma radiation, or decay so fast, that they are less important. During the first 30 minutes after a burst, the principal contributor to induced radiation is radioactive aluminum.

Almost all soils contain aluminum. It is one of the most abundant elements in the earth's surface. Aluminum-28 has a half-life of 2.3 minutes. Because of this, almost all of the radioactive aluminum has decayed within 30 minutes after burst.

Most soils also contain significant quantities of manganese. This element, Manganese 56 has a half-life of 2.6 hours. From 30 minutes after burst until 10 to 20 hours after burst, both manganese and Sodium 24, which has a half-life of 15 hours are the principal contributors to radiation. After 10 to 20 hours after burst, Sodium 24, is the principal source of radiation.

Soil composition is the most important factor in the decay of induced radiation. Its decay must be considered differently from that of

fallout. For fallout, the decay rate is calculated by using the Kaufman equation. For induced radiation, the percentage, by weight, of elements present in the soil determines the decay rate. Since soil composition varies widely, even in a localized area, you must know the actual chemical composition of the soil to determine the rate of decay of induced radiation.

All soils are divided into four types. Table 7-1 has been extracted from Defense Nuclear Agency Effects Manual 1 (DNA E-M-1). Since the actual soil composition will not be known, Soil Type II, the slowest decay, is used for all calculations until the NBCC advises use of a different soil type.

Soil type is determined by using engineer soil maps or an NBC 4 report and the induced-decay nomograms. The method is basically a process of elimination. The dose rate and the time it was measured are applied to an induced-decay nomogram. This results in an H + 1 or R<sub>1</sub> dose rate. Then, if the other dose rates and times from the series report result in the same R<sub>1</sub> dose rate, that is the soil

**Table 7-1. Chemical composition of soils.**

Element	Type I (Liberia, Africa)	Type II (Nevada Desert)	Type III (Lava, Clay, Hawaii)	Type IV (Beach; Sand; Pensacola, FL)
Sodium		1.30	0.16	0.001
Manganese	0.008	0.01	2.94	--
Aluminum	2.89	6.70	18.79	0.006
Iron	3.75	2.20	10.64	0.005
Silicon	33.10	32.00	10.23	46.65
Titanium	0.39	0.27	1.26	0.004
Calcium	0.08	2.40	0.45	--
Potassium		2.70	0.88	
Hydrogen	0.39	0.70	0.94	0.001
Boron				0.001
Nitrogen	0.065		0.26	--
Sulfur	0.07	0.03	0.26	--
Magnesium	0.05	0.60	0.34	--
Chromium			0.04	--
Phosphorus	0.008	0.04	0.13	--
Carbon	3.87		9.36	--
Oxygen	50.33	50.82	43.32	53.332

type. If not, check the other nomograms until the one used results in the same  $R_t$ .

Soil Type II is listed as the type of soil found in the Nevada Desert. This is due to the amount of sodium and manganese in the soil and not the composition as a whole. Figure 7-3 (next page) depicts a graph comparing NIGA decay for various soils. From this graph, Soil Type II NIGA decay compares directly to the soil type labeled Consensus. Consensus is the average soil (sodium and manganese content only) world-wide. Therefore, Soil Type II is considered the standard soil used for calculations when the actual soil type is unknown.

From Figure 7-3, Soil Type IV compares directly to the average European soil, in sodium and manganese content. Therefore, use Soil Type IV when determining NIGA decay in this region.

### Dose-Rate Calculations

The decrease in the dose rate must be calculated before total dose can be found. This is done with decay nomograms. Use the residual radiation (induced) decay nomograms in Appendix E (Figures E-44, E-45, E-48 and E49) for these calculations. They allow the user to predict the dose rate at any time after the burst. Each nomogram denotes time (hours) after burst for one of the four soil types.

In each nomogram, the  $R_t$  scale is at the right. This scale shows  $H + 1$  dose rates. The  $R_i$  scale is on the left. This scale shows dose rates at times other than  $H + 1$ .

In working with nomograms, be as consistent as possible when joining values with the hairline. Be sure the hairline

intersects the vertical line and the interpolated value (tick mark) as closely as possible. The following three problems are concerned with technique only; they do not consider the impact that high dose rates might have on operations in the contaminated area. Each problem requires the use of a Keller nomogram for solving the problem (Figure 7-4, parts 1 and 2, next two pages). The caption for each nomogram contains a guide for using the nomogram.

**Problem 1.**

Given:  $R_t = 150$  cGyph at  $H + 3$  hours, Soil Type 11.

Find:  $R_i$ .

Answer: 180 cGyph.

Solution: Select nomogram for Soil Type 11. Align the hairline with the 3-hour tick mark on the Time (middle) scale (t) and the 150 cGyph point on the  $R_t$  scale. Read the dose rate as 180 cGyph at the point of intersection with the  $R_i$  scale.

**Problem 2.**

Given:  $R_i = 300$  cGyph, Soil Type III.

Find:  $R_t$  at  $H + 7$  hours.

Answer 63 cGyph.

Solution: Select nomogram for Soil Type III. Align the hairline with the 7-hour tick mark on the Time (middle) scale (t) and the 300-cGyph point on the  $R_i$  scale. Read the dose rate as 63 cGyph at the point of intersection with the  $R_t$  scale.

**Problem 3.**

Given:  $R_i = 200$  cGyph, Soil Type IV.

Find: time (t) when  $R_t = 70$  cGyph.

Answer:  $H + 11$  hours.

Solution: Select nomogram for Soil Type IV. Align the hairline with 200 cGyph on the  $R_i$  scale and 70 cGyph on

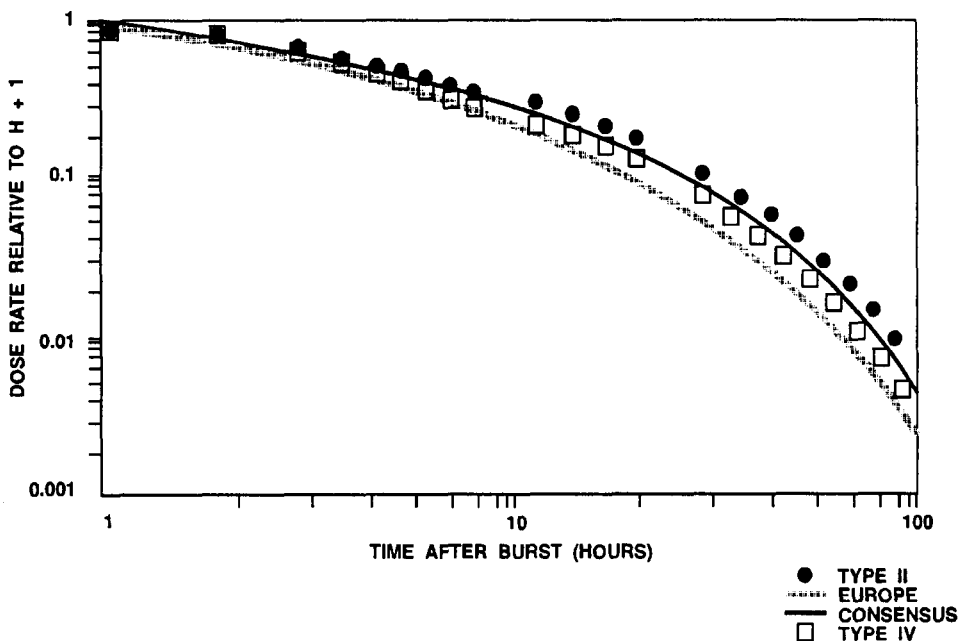

Figure 7-3 Soil type comparison for NIGA decay.

the  $R_1$  scale. Read the time as  $H + 11$  hours at the point of intersection of the hairline with the time scale.

### Total Dose Calculations for NIGA

Use the nomogram in Figure 7-5 (page 7-5) for predicting the total dose received in an induced area. This nomogram relates total dose,  $H + 1$  dose rate, stay time, and entry time. The two scales to the left of the index line show total dose and  $H + 1$  dose rate. There are two time-of-stay scales to the right of the index line. The extreme right scale shows time of entry. The index line is a "pivoting" line used as an intermediate step between  $D$  and  $R_1$ .  $R_1$  is found by using one of the induced & cay nomograms. If soil type is unknown, assume the soil is type II. The total dose nomogram, Figure 7-5 is never used to find  $R_1$ .

In Figure 7-5, soil types II and IV under stay time are used for total dose calculations if the soil type is not known. If the soil type is known, the appropriate scale under stay time is used. It is possible to find any one value on the total dose nomogram if the other three are given, as illustrated in the following problems.

These problems are concerned with techniques only. They do not consider the impact the dose or dose rates might have on operations in a contaminated area.

**Problem 1.**

Given:  $R_1 = 140$  cGyph

$T_e = H + 6$  hours

$T_s = 1$  hour

Soil Type II.

Find:  $D$ .

Answer: 72 cGy.

Solution: On the nomogram in Figure 7-5, connect  $H + 6$  on the  $T_e$  scale with 1 hour on the  $T_s$  scale (soil types II and IV) with a hairline. Pin the hairline at the point of intersection with the index scale. Now pivot the hairline to 140 cGyph on the  $R_1$  scale. Read 72 cGy on the  $D$  scale.

**Problem 2.**

Given:  $R_1 = 300$  cGyph

$T_e = H + 6$  hours

$D = 70$  cGy

Soil Type III.

Find:  $T_s$ .

Answer: 1 hour.

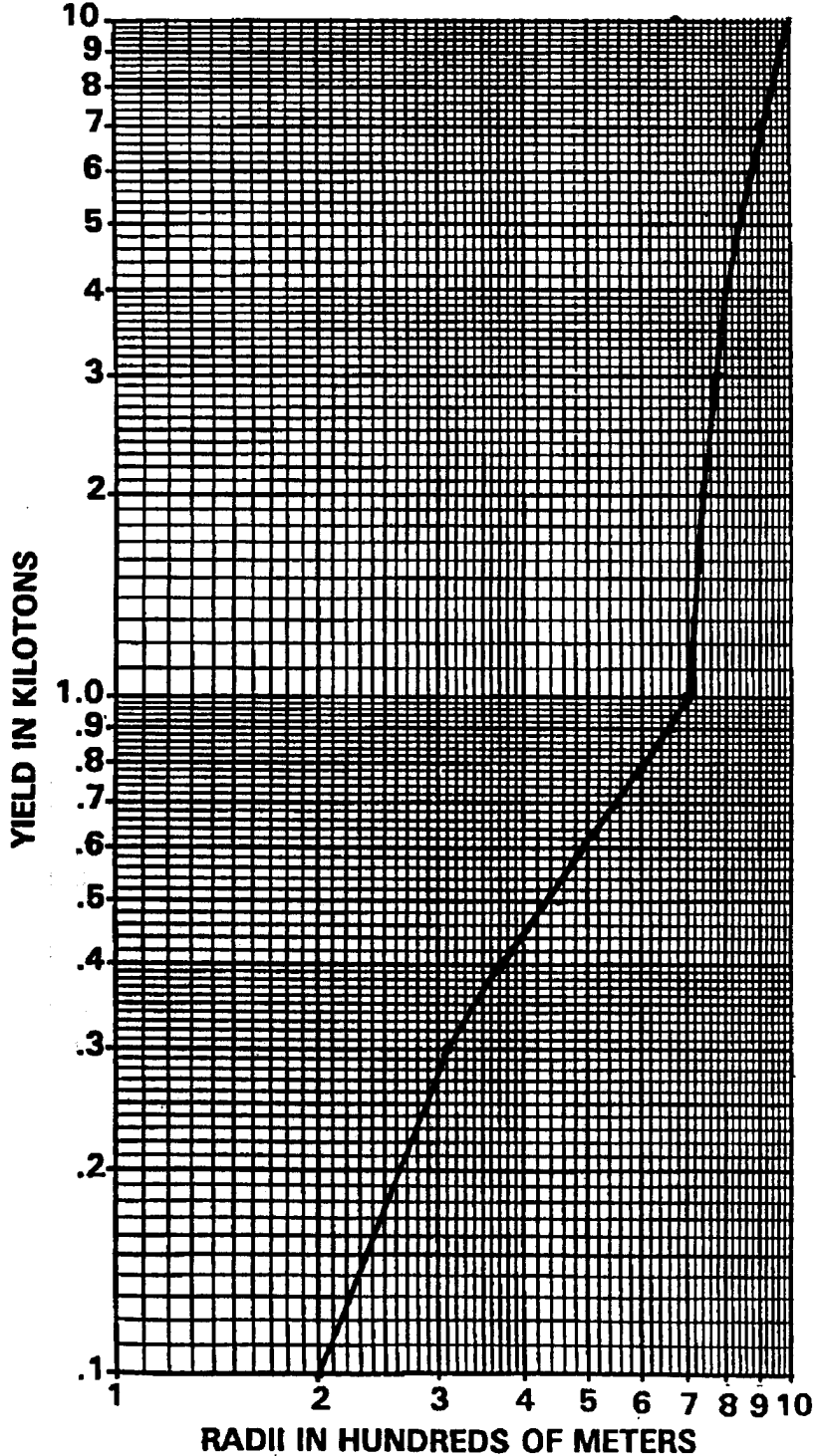

Figure 7.4. Keller Nomogram for neutron inducement (0.1—10 KT). Enter the nomogram with known yield. Extract the radius from the bottom of the nomogram. This radius indicates the 2cGph dose rate at  $H + 1$ . The answer will be in hundreds of meters. Example—The neutron-induced radius for a 1-kilogram weapon is 700 meters.



Solution: On nomogram in Figure 7-5, connect 70 cGy on the D scale with 300 cGyph on the R<sub>1</sub> scale. Pin the hairline at the point of intersection with the index scale. Pivot the hairline to H + 6 hours on the T<sub>e</sub> scale. Read 1 hour on the T<sub>s</sub> scale (soil types I and III).

### Crossing an Induced-Radiation Area

If an area must be crossed, select the lowest dose rate area, consistent with the mission. Route selection may be influenced by several factors. Unpassable terrain, such as mountains or swamps, may influence the route. Obstacles, such as tree blowdown, fires, or rubble, also may limit the number of routes or the mode of movement.

If an option exists for crossing an induced area, select the method in the following priority order:

1. Aircraft.
2. Armored vehicles and personnel carriers.
3. Wheeled vehicles.
4. On foot.

Sandbag all vehicles used in crossing to increase shielding. Sandbag floors and sides of cargo vehicles.

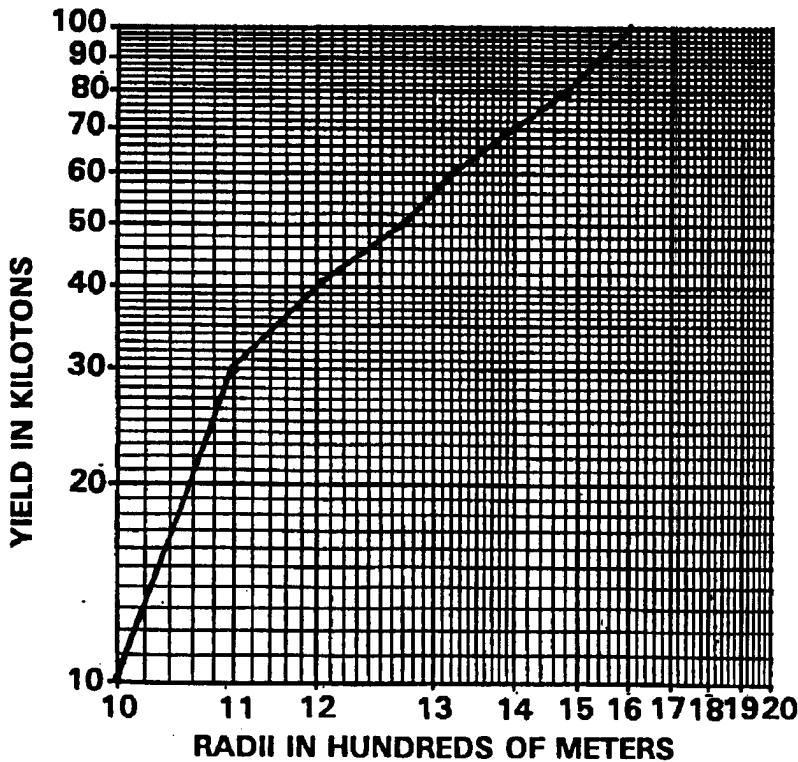

Figure 7-4, Part 2. Keller Nomogram for neutron inducement (10—100 kilotons). Enter the nomogram with known yield. Extract the radius from the bottom of the nomogram. This radius indicates the 2cGyph dose rate at H + 1. The answer will be in hundreds of meters. Example—The neutron-induced radii for a 1-kiloton weapon is 1,600 meters.

APCs should be sandbagged both on top and bottom. Always use uncontaminated soil in the sandbags.

As with fallout, the limit to the amount of exposure to radiation is expressed by the higher commander's OEG. To meet this OEG, the lower commander must employ as many of the dose reduction principles as possible.

In calculating total dose, it is necessary to determine an average dose rate. Dose rates increase as the center of the area is approached, and then decrease beyond the center of the area. The average dose rate represents a mean value the individual is exposed to during the time of stay. A reasonable approximation of the average dose rate can be obtained by dividing by two the maximum dose rate

predicted to be encountered. This is written  $R_{1avg} = \frac{R_{max}}{2}$

Time of stay: Time of stay (stay time) must be calculated for crossing problems. Use the following relationship:

$$T_s = \frac{\text{distance}}{\text{speed}}$$

**Problem.**

Figure 7-6 (page 7-6) shows an example problem for calculating dose when crossing an induced radiation area.

Given: A crossing will take place (as shown in Figure 7-6) at H + 20 hours. Distance of the route across the area is 1 kilometer. Speed during the crossing (on foot) will be 5 kilometers per hour.

Find: D.

Answer 20 cGy.  
solution

$$R_{1avg} = \frac{R_{1max}}{2} = \frac{1,000cGyph}{2} = 500cGyphT_s = \frac{\text{distan}}{\text{spee}}$$

T<sub>e</sub> = H + 20 hours.

On the nomogram in Figure 7-5, connect 0.2 hours on the T<sub>s</sub> scale (soil types II and IV) and 20 hours on the T<sub>e</sub> scale with a hairline. Pivot through the point of intersection with the index scale to 500 cGyph on the R<sub>1</sub> scale. Read a total dose of 19 cGy on the D scale at the point of intersection with the hairline.

**Problem 2.**

Given: An induced area with Soil Type II must be crossed at H + 10 hours. Distance across the area is 1 kilometer. Speed of crossing is 10 kilometers per hour. The highest H + 1 dose rate is 300 cGyph. Crossing will be conducted in APCs with a TF of 0.22.

Find: ID.

Answer: 1.32 cGy, or 1 cGy.

Solution:

1. Calculate R<sub>1avg</sub>:

**TOTAL DOSE RECEIVED IN AN INDUCED AREA**

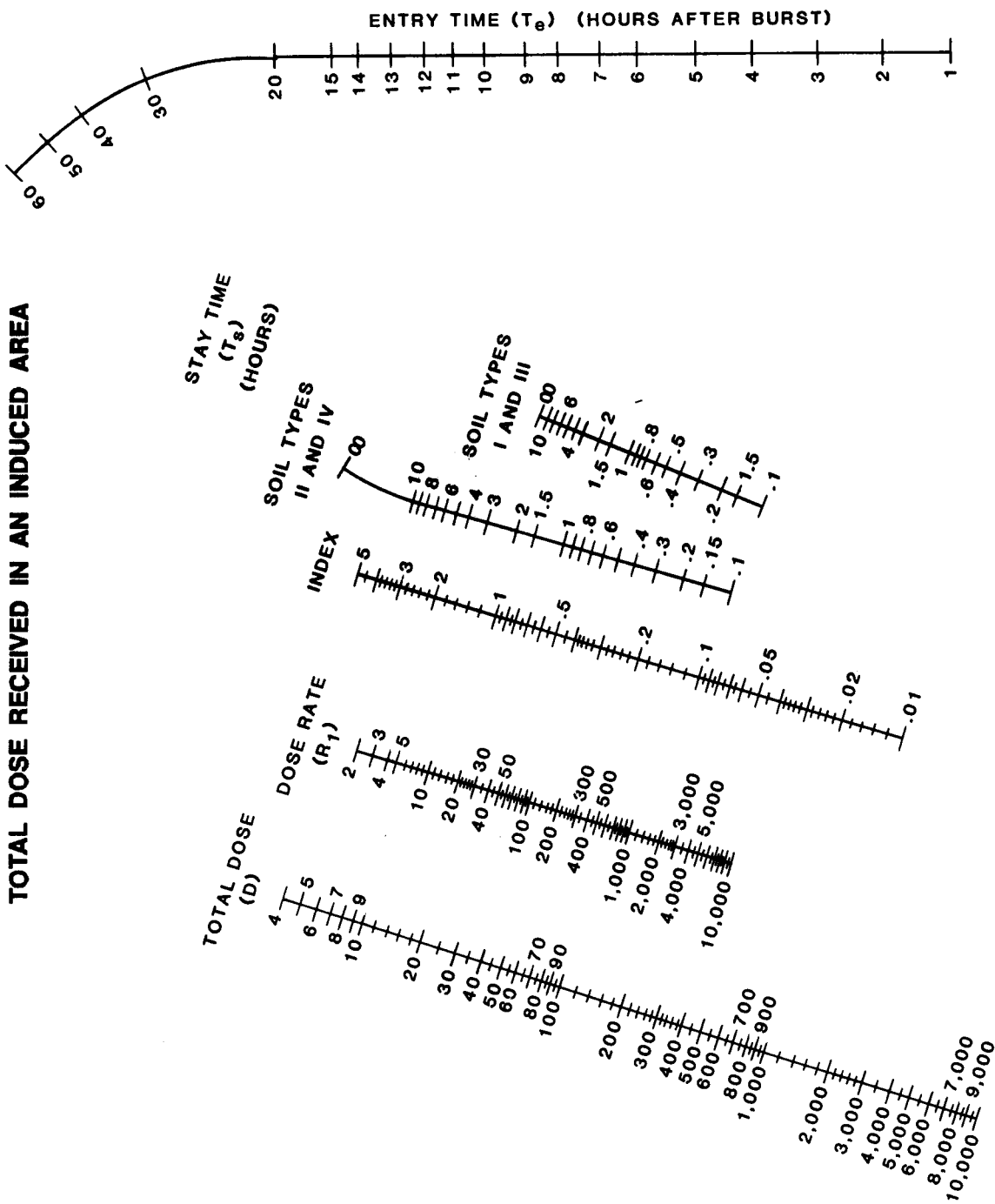

Figure 7-5. Total dose nomogram.

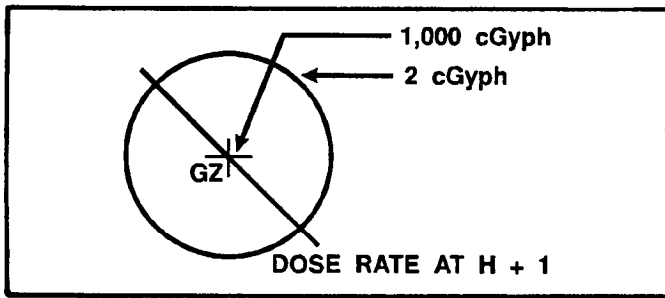

Figure 7-6. Sample situation for dose rate calculation when crossing an induced-radiation area.

$$R_{1avg} = \frac{R_{1max}}{2} = \frac{300cGyph}{2} = 150cGyph.$$

2. Calculate  $T_s$ :

$$T_s = \frac{\text{distance}}{\text{speed}} = \frac{1km}{10kmph} = 0.1hours.$$

3. On the nomogram in Figure 7-5, connect 10 hours on the  $T_e$  scale with 0.1 hour on the  $T_s$  scale (soil types II and IV). Pin the hairline on the index scale. Pivot the hairline 150 cGyph on the  $R_1$  scale. Read the outside dose as 6 cGy.

4. Calculate the inside total dose:

$$\begin{aligned} \text{inside dose} &= \text{outside dose} \times TF \\ &= 6 \text{ cGy} \times 0.22 \\ &= 1.32 \text{ cGy, or } 1 \text{ cGy.} \end{aligned}$$

## Transmission Factors for Neutron-Induced Areas

Transmission factors for induced areas are determined in the field. The TFs in Table 7-2 should be used with the greatest reservation. Actual TFs in induced areas may be higher by as much as 70 percent, because of a very technical characteristic of radiation. Essentially the strength of gamma radiation is measured in million electron volts (MEV). Fallout less than 24 hours old has an average energy of 0.67 MEV. Induced radiation emitted from the three principal soil elements has a range of 0.68 MEV to 1.2 MEV.

Because of the unique decay characteristics of induced radiation, TFs must be recalculated frequently. Every four hours is recommended. This accounts for changes in the penetrating ability of the remaining radiation.

Field calculation of neutron-induced TFs is identical to that for fallout. TFs may be applied to dose rates or total dose.

The following mathematical calculations relate to NIGA from a single burst at a single location.

## Determination of Decay Rate for Induced Radiation

Decay characteristics of induced radiation are considerably different from those of fallout. The Kaufman equation may not be applied.

The decay of induced radiation depends on the elements in which it is induced. Soil contains many different elements with varying half-lives, so, the decay rate changes in time, and must be monitored constantly.

The decay rate  $n$  at a fixed location can only be determined from consecutive measurements, using the following equation:

$$\frac{1}{t} \times \ln \left( \frac{R_a}{R_a + t} \right).$$

$R_a$  is the dose rate reading in cGyph at an arbitrary time  $a$  and  $R_{a+t}$  is a second reading taken at the same location after  $t$  hours. One  $\ln()$  is the natural logarithm to base  $e$  ( $e = 2.71828...$ , Eulerian constant).

Manganese and sodium are two elements frequently found in soils with relatively long half-lives. Therefore, they are expected to be the principal sources of radiation after a burst. For sodium with its half-life of 15 hours, the decay rate is 0.046. For manganese with its half-life of 2.6 hours, the decay rate is 0.27.

Table 7-2. Transmission factors for common structures.

Structure	Neutrons
Three feet underground	0.01
Frame House	0.8
Basement	0.8
Multistory building (apartment type)	
Upper stories	1.0
Lower stories	0.8
Concrete blockhouse shelter	
9-in. walls	0.5
12-in. walls	0.4
24-in. walls	0.2
Shelter, partly above ground	
With 2-ft earth cover	0.08
With 3-ft earth cover	0.05

### Determination of the Dose Rate for an Arbitrary Time

The dose rate  $R_t$  in cGyph at an arbitrary time  $t$  hours after a reading is calculated as  $R_t = R_a * \text{EXP}(-n * t)$ .  $R_a$  is the dose rate at the time  $t$  of the reading,  $n$  is the decay rate at that time, and  $\text{exp}()$  is the exponential function (inverse or  $\text{INV}()$ ; the argument is the power to which  $e = 2.71828 \dots$  is raised).

**Note:** The following characters or character combinations indicate keys on the pocket calculator:  $\text{EXP}$ ,  $\text{Y}^x$ ,  $\text{INV}$ , (and  $\text{.}$ ). When you encounter one of these in a formula, press the key indicated. Remember that negative  $n$  ( $-n$ ) is not an indication to press the minus key.

### Determination of Dose Accumulated in an NIGA Area

The dose  $D$  in cGy accumulated between entry to and exit from an NIGA area is found by using the formula—  
 $D = R_i / n * (\text{EXP}(-n * T_e) - \text{EXP}(-n * t_{out}))$ .  $R_i$  is the dose rate in cGyph at the reference time,  $n$  is the decay rate at that time,  $t_{in}$  and  $t_{out}$  are the time of entry and exit from the NIGA area in hours after the reference time.  $\text{EXP}()$  is the exponential function.

### Determination of Time of Exit from an NIGA Area Given a Maximum Dosage

If a certain limit  $DL$  for the dose accumulated during a stay in an NIGA area is given, the time  $t_{out}$  to leave the area can be determined from the following equation:

$T_{out} = -1/n * \ln(\text{EXP}(-n * T_e) - (n * DL) / R_i)$   
 Where  $T_e$  is the time of entry in hours after the reference time at which the dose rate was  $R_i$  and the decay rate was  $D$ . One  $\ln()$  and  $\text{EXP}()$  are the natural logarithm and the exponential function, respectively.

**Determination of the Earliest Time of Entry.** To ensure a limiting dose  $DL$  is not accumulated during a stay in an NIGA area, the earliest time of entry  $t_{in}$  can be determined as follows:

$T_e = -1/n * (\text{DL} / (R_i * n * (1 - \text{exp}(-n * T_s))))$ .  
 Where  $T_s$  is the time of stay in the area in hours,  $R_i$  is the dose rate at the reference time  $H + 1$ , and  $n$  is the decay rate at that time. One  $\ln()$  and  $\text{EXP}()$  are the natural logarithm and the exponential function, respectively.

There are two other methods to calculate crossing problems. The **hand-held pocket calculator method:**  
**Step 1.** Turn on the calculator, and punch in the value for  $R_i$ , press  $\div$ ; then  $(1 - n)$ .

**Step 2.** Press the multiplication key; then  $($  and the value for  $T_s$ . Then push the power key  $Y^x$ .

**Step 3.** Press  $($  again and  $1 - n$ . push the minus symbol  $-$ .

**Step 4.** Again, press  $($ , the value for  $T_e$ , and  $Y^x$ . Press  $($  again and then  $1 - n$ . Press  $($  twice, then equals.

The whole equation written out looks like this—  
 $D = R_i + (1 - n) * (T_s * Y^x(1 - n) - (T_e * Y^x(1 - n))) =$

For time of entry ( $T_e$ )—  
 $T_e = (T_s * Y^x(1 - n) - D * (1 - n)) / R_i = \text{INV } Y^x(1 - n) =$

For time of stay ( $T_s$ )—  
 $T_s = (D * (1 - n)) / R_i + T_e * Y^x(1 - n) = I * Y^x(1 - n) =$

## Chapter 8

# Civilian Radiation Hazards

The number of nations that have invested in nuclear power and nuclear research is extensive and increasing. With this increase, the potential for US forces to operate in or around areas that have these facilities also increases. Damage to one of these facilities will present unique challenges to US and allied armed forces and the citizens of the host nation (HN). Radiation hazards released into the environment may cause immediate casualties or casualties years later. To safeguard friendly forces and civilians from these potential hazards, peacetime and tactical nuclear contamination avoidance principles must be carefully blended.

If a nuclear facility (power plant, research facility, etc.) is damaged or destroyed, alpha and beta particulates are of the utmost concern. As discussed in Chapter 3, alpha radiation is not considered to be of tactical significance. However, alpha contamination is considered to be of prime importance in peacetime radiation safety. This is due to the alpha particles ability to cause ionization of cells within the body.

Alpha particles cannot be detected with normal tactical radiac instruments (AN/PDR27, IM174, or AN/VDR2). Alpha contamination can be detected only with the AN/PDR56 or AN/PDR60 radiac instruments. These instruments are generally assigned to special teams. These teams, called NAIRA teams (or nuclear accident/incidence response and assistance teams) have the mission to respond to the unwanted or unexpected release of radiological material into the environment.

Beta particles are also of concern. These particles may cause skin burns, similar to sunburn, or cause internal damage to the body. Furthermore, beta particles can cause damage to the eyes, normally manifesting itself as cataracts later in life.

To minimize the effects or hazards resulting from the damage or destruction of a nuclear facility, prior planning must occur. When friendly units are required to operate in an area where such a facility exists, the chemical staff must accomplish the following:

- Coordinate, through G5/S5, with emergency response teams. These teams may be from the host nation government, armed forces, or from the nuclear facility itself.
- Identify what radiological source material is present and what type of contamination it will emit (alpha, beta, gamma, xray, or neutron).
- Coordinate with the divisional radiation protection officer (RPO) for technical assistance.
- Coordinate with higher headquarters and the host nation to identify available NAIRA teams, technical escort units, or similar civilian agencies to assist if required,
- Establish evacuation procedures for noncombatants.
- Identify a chain-of-command for supervision and coordination of the clean-up effort.

The following steps should be taken immediately by the tactical unit within the area of a civilian radiation hazard:

- Notify higher, lower, and adjacent units.
- Start continuous monitoring. Although tactical units will not be able to detect alpha, continuous monitoring with an AN/PDR27 or AN/VDR2 with the beta shield open may provide a form of monitoring.
- Secure the area around the facility. Establish a security perimeter of 620 meter radius around the site, until relieved by appropriate response team or military police.
- Attempt to evacuate casualties without endangering personnel to the needless exposure to ionizing radiation.
- Personnel operating in and around the site should wear protective masks to protect the respiratory tract from the inhalation of particulates and to protect the eyes from beta radiation.

Appendix A

# Operational Exposure Guidance

Operational exposure guidance gives the commander a flexible system of radiation exposure control. OEG procedures aid in the successful employment of a unit on a contaminated battlefield, while keeping the exposure of personnel to a minimum. Radiation exposure must be controlled to the maximum extent possible consistent with the mission. If exposure control is ignored, the results could be disastrous. Establishing and using OEG helps the commander keep radiation exposures to a minimum and still accomplish the mission. OEG is the key for reducing casualties in radioactive fallout areas.

All nuclear radiation, even in small doses, has some harmful effect on the body. It should be avoided whenever possible, without interfering with military operations.

It is not possible to give the commander hard and fast rules on radiation exposure. We cannot say that 20 cGy of radiation will not affect the unit. The unit may have been exposed to radiation previously. If the unit has had previous exposure and receives another 20 cGy of radiation, there may be casualties. This is why RES must be maintained. Establishing OEG must be based on a unit's prior exposure. The commander establishes an OEG for each tactical operation.

Establishing one numerical value or acceptable degree of risk as an OEG for all subordinate units throughout a campaign would be meaningless. An OEG must be established for each unit and each operation. It must be

based upon the radiation exposure status of the unit at that time and on the combat situation.

The commander can decide which unit to select for a given mission based on the OEG. Each level of command uses the OEG system to select the best unit to conduct a mission. The commander is assured the troops will receive the least amount of injuries or sickness possible. Commanders put OEG in all operation orders. All command and staff agencies use OEG and RES to accomplish the mission while minimizing radiation exposure.

Based on the OEG, a unit can determine the turn-back dose ( $D_{tb}$ ) and turn-back dose rate ( $R_{tb}$ ) for a military operation (such as a radiological survey):

$$D_{tb} = \frac{(OEG) - \text{previous exposure}}{(2)}$$

$$R_{tb} = \frac{2 \times (OEG - \text{previous exposure}) \times \text{speed}}{\text{distance}}$$

If the dosimeter reading indicates a turnback dose and the dose rate is still increasing, the unit should immediately leave the contaminated area by the same route it used to enter the area. If the dose rate is decreasing, the commander must decide whether to continue through the contaminated area (then return to the unit by a clean route) or immediately leave by the same route used to enter the area. This may conflict with some basic rules of tactics or recon, but it must be done to minimize casualties.

## Categories of Exposure

Effective use of radiation exposure records permits rapid determination of a unit's potential to operate in a radiologically contaminated area. Dose criteria has been established in four categories. Radiation Exposure Status-0 (RES-0), Radiation Exposure Status-1 (RES-1), Radiation Exposure Status-2 (RES-2), and Radiation Exposure Status-3 (RES-3). Dose criteria is shown in Tables A-1 and A-3 (page A-5) for each category. This information is based on the best available estimates on predicting the effects of radiation exposure.

**Table A-1. Radiation exposure status categories.**

<b>RES-0</b>	The unit has not had any radiation exposure.
<b>RES-1</b>	The unit has been exposed to greater than 0 cGy but less than or equal to 70 cGy.
<b>RES-2</b>	The unit has been exposed to greater than 70 cGy but less than or equal to 150 cGy.
<b>RES-3</b>	The unit has been exposed to greater than

## Risk Criteria

The degree-of-risk concept helps the commander to establish an OEG for a single operation and minimize the number of radiation casualties. By using the RES categories (Table A-1) of subordinate units and the acceptable degree of risk, the commander establishes an OEG based on the degree of risk (Table A-3, page A-4). There are three degrees of risk—negligible, moderate, and emergency. Each risk can be applied to radiation hazards from enemy or friendly weapons, or both, and from initial nuclear radiation from planned friendly supporting fire.

Degrees of risk are defined in percentages of either casualties or performance degradation. From a radiation standpoint, the effect causing performance degradation (but not casualties) is vomiting. This is commonly called a nuisance effect. Degrees of risk for radiation are discussed in following paragraphs. (See FM 101-31-1 for a complete discussion of degrees of risk, to include blast and thermal effects.)

Before beginning this discussion, let's first look at what a casualty is and what nuisance effects are. A casualty is defined as an individual whose performance effectiveness has dropped by 25% from normal. Specific measures of performance depend upon the task. This, of course, implies that an individual casualty status may depend on the task assigned.

The casualty data presented next is based on a 50% confidence level that the unit is at 75% performance decrement. Nuisance effects can range from vomiting, skin burns, and ear drum rupture to nausea. These symptoms, at low radiation levels, may take hours to develop. Individuals thus exposed should be able to function in the important hours after a nuclear attack and after the first set of symptoms abate. This performance decrement is further explained in Figure A-1, parts 1 and 2 (next page).

### Negligible Risk

Negligible risk is the lowest risk category. The dose is 0 to 50 cGy for personnel in RES-0. This dose will not cause any casualties. Troops receiving a negligible risk dose will experience no more than 2.5 percent nuisance effects. Negligible risk is acceptable when the mission requires units to operate in a contaminated area. Negligible risk

should not be exceeded unless a significant advantage will be gained.

### Moderate Risk

Moderate risk is the second risk category. The dose is 70 cGy for personnel in RES-0. This dose generally will not cause casualties. Troops receiving a moderate risk dose will experience no more than 5 percent incidence of nuisance effects. Moderate risk is usually acceptable in close support operations. Moderate risk must not be exceeded if troops are expected to operate at full efficiency.

### Emergency Risk

Emergency risk is the final risk category. The dose is 150 cGy. In this category, not more than 5 percent casualties are expected. Nuisance effects may exceed the 5 percent level. The emergency risk dose is only acceptable in rare situations, termed disaster situations. Only the commander can decide when the risk of the disaster situation outweighs the radiation emergency risk.

To better understand the relationship between the risk categories and the dose rate received, see Table A-2 (pages A-3 & -A4). The table data are not intended for use in determining operational exposure guidance or categories of risk. That information is contained in Table A-3 (page A-4). Table A-3 shows the relationship of the categories of exposure and the degree of risk categories. It also shows the possible exposure criteria for a single operation that will not exceed the dose criteria for a stated degree of risk.

The risk criteria for the RES-1 and RES-2 categories are based on assumed average exposures for units in RES-1 and RES-2 (40 cGy for RES-1, and 110 cGy for RES-2). This criteria should be used only when the numerical value of the total past cumulative dose of a unit is unknown. When the cumulative dose within a category is known, subtract the known dose from the RES-0 criteria for the degree of risk of concern.

For example, if a unit in RES-1 received 30 cGy, it may receive an additional dose of 20, 40, or 120 cGy, respectively, before exceeding the negligible, moderate, or emergency dose.

## Radiation Exposure Records

The OEG concept requires that radiation exposure records be maintained by all units. Because platoons are usually located in areas of equal radiation levels, the most realistic unit exposure data are based on readings obtained at the platoon level. Radiation exposure records are maintained at all levels.

Battalion S1, in coordination with the battalion NBC staff, maintains RES records for all assigned and attached units. The records are based on platoon level data received daily or after a mission in a radiologically contaminated area. Unit SOP indicates specific reporting procedures. Monthly records are maintained according to unit SOP.

Figure A-2 (page A-5) shows a suggested way of maintaining RES data for each company within a battalion (companies maintain records by section). A blank radiation exposure chart, DA 1971-6-R, is in Appendix H.



### Processing DATA

The data from each platoon-size element are passed to the unit NBC defense team. Readings from tactical dosimeters (IM93s or DT236s) are averaged by the defense team on a daily basis, and an informal record maintained at platoon and company level (Figure A-2 page A-5). The

IM93s, which work on the principle of the electrical collection of ions, are recharged after each report is submitted or every three days, whichever occurs first. For the DT236, prior to nuclear operations, each unit will read 10 percent of the total number of DT236 weekly to ensure no leakage has occurred. After nuclear operations have commenced in the theater of operations, one third of the total number of DT236s will be read daily. The DT236s have a response time of 24 hours and  $\pm 30\%$  accuracy. This is due to the process by which the DT236 records radiation levels.

(Text continued on page A-6)

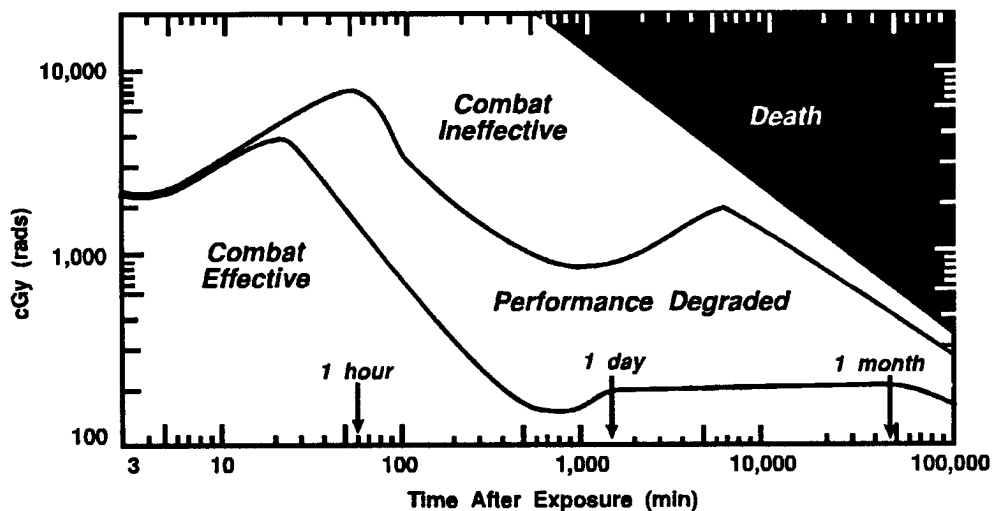

Figure A-1, Part 1. Combat effectiveness for physically demanding tasks after exposure to ionizing radiation.

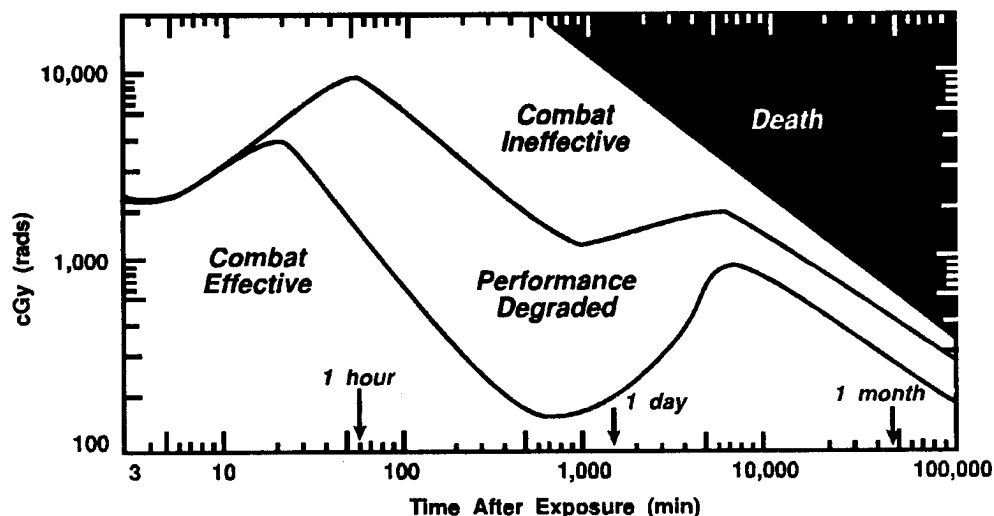

Figure A-1, Part 2. Combat effectiveness for nonphysically demanding tasks after exposure to ionizing radiation.



**Table A-2. Effects of radiation exposure on combat personnel.**

<b>Dose Range (cGy)</b>	<b>Initial Symptoms</b>	<b>Approx Time of Initial Symptoms (beginning-ending)</b>	<b>Performance Capability (mid-dose range)</b>	<b>Final Disposition</b>
0 to 70	None to slight incidence of transient headache and nausea. Vomiting in up to 5% of personnel in upper range.	6 to 12 hours	Combat effective	Duty
70 to 150	Transient mild nausea vomiting in 5%--30% of personnel. Vomiting in up to 5% of personnel in upper part of range.	2 to 20 hours	Combat effective	Duty: No deaths.
150 to 300	Transient mild to moderate nausea and vomiting in 20%--70% of personnel. Mild to moderate fatigue and weakness in 25%--60% of personnel.	2 hours to 2 days	DT: PD from 4 hours til recovery. UT: PD from 6 hours to 1 day then 6 weeks til recovery.	Duty: Less than 5% deaths at low end of exposure range; death may occur in 10% of personnel.
300 to 500	Transient moderate nausea vomiting in 50%--90% of personnel. Moderate fatigue in 50%--90% of personnel.	2 hours to 3 days	DT: PD from 3 hours to 2 weeks, til death or recovery. UT: PD from 4 hours to 2 weeks or until death or recovery.	Duty at low end of exposure range; less than 10% deaths. At high end of exposure range, death may occur in more than 50% of personnel after 4 weeks.
500 to 800	Moderate to severe nausea and vomiting in 80%--100% of personnel. Moderate to severe fatigue and weakness in 90%--100% of personnel.	Within 1 hour  2 hours to at least 6 weeks	DT: PD from 2 hours to 3 weeks; CI from 3 weeks til death. UT: PD from 2 hours to 2 days then 7 days to 4 weeks.	At low end of exposure range, death may occur in more than 50% of personnel beginning, after 4 weeks. At high end of exposure range, 99%, beginning after 3 weeks.
800 to 1,500	Moderate to severe nausea, vomiting, dizziness, disorientation in 100% of personnel; moderate fluid loss in 80% of personnel.	45 minutes to 2½ days	DT: PD 1 hour to 6 hours then 1½ days to 1 week; CI up to 6 hours then 1½ days to 1 week until death. UT: PD 1½ hours to 8 days; CI 8 days til death.	1,000 cGys—death in 1 to 3 weeks  <b>Continued</b>

**LEGEND:** DT—demanding task  
UT—undemanding task

PD—performance decrement (25%--70% of pre-irradiation performance level)  
CI—combat ineffective (less than 25% of preirradiation performance level)

Table A-2 continued.

Dose Range (cGy)	Initial Symptoms	Approx Time of Initial Symptoms (beginning-ending)	Performance Capability (mid-dose range)	Final Disposition
	Severe fatigue and weakness in 100% of personnel.	2 hours til death (1 to 3 weeks).		
1,500 to 3,000	Severe nausea, vomiting, fluid loss, and headache in 100% of personnel.  Severe fatigue, weakness, dizziness, disorientation in 100% of personnel.	30 minutes to 3 days  1 hour til death (5 to 12 days)	DT: PD 30 minutes to 2½ hours til death. UT: PD 45 minutes to 5 days; CI 5 hours til death.	2,500 cGy—death in 5 to 12 days
3,000 to 8,000	Severe nausea, vomiting, fatigue, weakness, dizziness, and disorientation, fluid imbalance, and headache.	15 minutes to 5 days	DT/UT: CI 3 minutes to 30 minutes; PD 30 minutes to 90 minutes; CI 90 minutes til death.	4,500 cGy—100% death at 2 to 3 days

**LEGEND:** DT—demanding task PD—performance decrement (25-70% of preirradiation performance level).  
UT—undemanding task CI—combat ineffective (less than 25% of preirradiation performance level).

Table A-3. Nuclear radiation exposure status and degree of risk exposure.

Radiation Status Category <sup>A &amp; B</sup>	Total Past Cumulative Dose <sup>C</sup> (cGy)	Possible Exposure Criteria, for a single operation that will not result in exceeding the dose criteria for the stated degree of risk <sup>D &amp; E</sup> (cGy).
RES-0 Units	No exposure	Negligible risk: ≤ 50 Moderate Risk: ≤ 70 Emergency Risk: ≤ 150
RES-1 Units	More than 0, but less than or equal to 70	Negligible risk: ≤ 10 Moderate Risk: ≤ 30 Emergency Risk: ≤ 110
RES-2 Units	More than 70 but less than or equal to 150	Any further exposure is considered to exceed a negligible or moderate risk. Emergency Risk: ≤ 40
RES-3 Units	More than 150	Any further exposure will exceed the emergency risk.

**Notes:**

- A. Radiation status categories are based on previous exposure to radiation.  
 B. Reclassification of units from one radiation status category to a less serious one is made by the commander, upon advice of the surgeon, after ample observation of actual state of health of exposed personnel.  
 C. All exposures to radiation are considered total body and simply additive. No allowance is made for body recovery from radiation injury.  
 D. Risk levels are graduated within each status category to provide more stringent criteria as the total radiation dose accumulated becomes more serious. The exposure criteria given for RES-1 and RES-2 units should be used only when the numerical value of a unit's total past cumulative dose is unknown.  
 E. Each of the degrees of risk can be applied to radiation hazards resulting from enemy or friendly weapons, or both, and from initial nuclear radiation resulting from planned friendly supporting fire.

DATE: 23 July 9X  
 UNIT: B/4-14 FA

Radiation status category	Numerical criteria Total cumulative dose (cGy)
RES - 0	0 = (no exposure)
RES - 1	1 = Greater than 0, but less than or equal to 70
RES - 2	2 = Greater than 70, but less than or equal to 150
RES - 3	3 = Greater than 150

ELEMENT	Previous Exposure	New Exposure	Total Exposure	RES Category
HQ Plt	25	40	65	1
1st Plt	20	20	40	1
2d Plt	40	40	80	2
3d Plt	10	20	30	1
Spt Plt	30	10	40	1

Radiation status category of company or battalion	Number of platoons in company or number of companies in battalion						Category Total 6
	2	3	4	5	6	7	
RES - 0	0	0-1	0-1	0-2	0-2	0-3	Overall Status 1
RES - 1	1-2	2-4	2-5	3-7	3-8	4-10	
RES - 2	3-4	5-7	6-9	8-12	9-14	11-17	
RES - 3	5-6	8-9	10-12	13-15	15-18	18-21	

Figure A-2. Example of completed radiation exposure chart.

The DT236 uses the process of scintillation, or the conversion of radiation into detectable light, to record gamma; and the process of a solid state semi-conductor for neutron radiation. The solid-state semi-conductor must be heated to obtain a radiation dose reading. Therefore, those DT236s read directly after a nuclear burst will not show the true amount of radiation received. During this response time, readings should be obtained with the IM93 dosimeters and used for planning purposes once the 24 hours has elapsed. The readings from the DT236 will be used for determining unit RES. After recording all platoon information, the company reports platoon and company status to the battalion according to its SOP.

Battalion records and maintains the status on each platoon, company, and attached elements. An overall battalion status is reported to the S3 or placed on the daily briefing chart. Battalion then forwards the company and overall battalion status to brigade.

Brigades maintain records on all company-size elements as well as battalion overall RES. This information generally is collected at the brigade administrative and logistics center (ALOC) with the brigade S1. Brigade NBC personnel must ensure this information is collected, tabulated correctly,

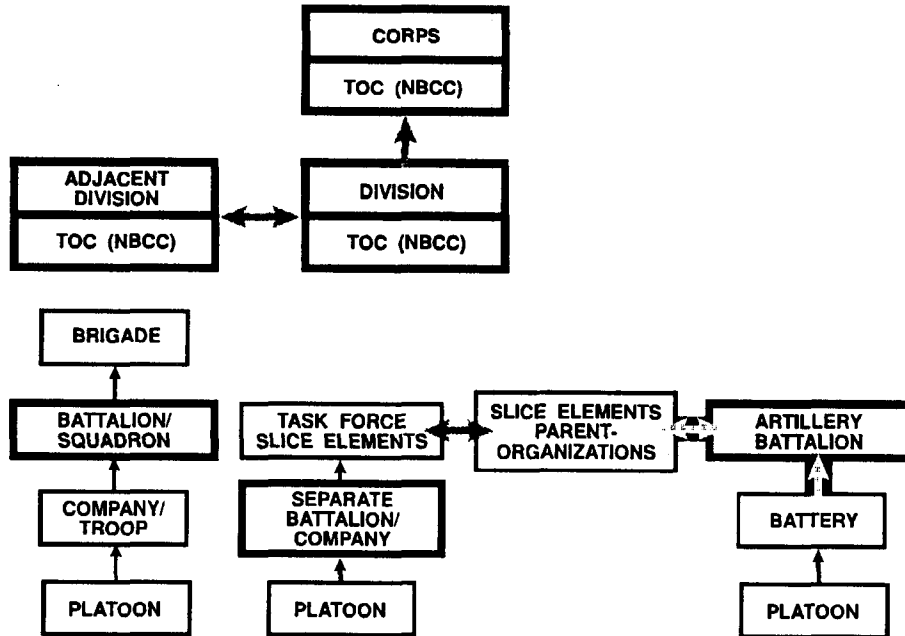

Processed data on request only  
 Processed data through intervening headquarters (i.e. Brigade)  
 Basic unit data  
 Bold blocks indicate units that keep radiation dose status charts.

Figure A-3. Typical flow of dosimetry information within a division.

and maintained. Typical flow of dosimetry within a division is shown in Figure A-3.

In the example, total exposure begins with the records of the previous day. The new exposure occurred in the past 24 hours. The RES category for each unit or element is determined from Table A-3. Overall status of the battalion is determined from the same table.

Since the platoon is the lowest level at which radiation exposure records are kept, replacements should be at platoon level. An ineffective platoon is either pulled out of a company, or the personnel are reassigned to different platoons with the same RES. A new platoon is then assigned to the company.

This creates severe management problems for personnel replacement. All levels of command must follow these

procedures. It may be difficult, but it keeps personnel from becoming incapacitated due to overexposure to radiation.

### Individual Dosimetry

The following information concerns unit dosimetry. As an interim measure until the Army issues the DT236 individual dosimeters to each soldier, the dose of the soldier is assumed to be the same as the platoon or similar size unit to which the soldier is assigned. When reassigned or evacuated through medical or other channels, the soldier's dose will be assumed to be the same as the platoon or similar-size unit to which last assigned. A notation of this status (RES-0, RES-1, RES-2, RES-3) will be made on the soldier's official records for formal record of radiation exposure when the individual is passed on to a gaining unit.

The following is an example of employment of an operation exposure guide:

It is 6 October. The battalion commander plans to commit Company B on 7 October in a radiologically contaminated area. He will accept a moderate risk. The radiation dose status chart (Figure A-4) is checked, and the radiation status of Company B is determined to be RES-1.

The commander notes from Table A-3 that a RES-1 unit may receive a dose less than or equal to 30 cGy and not exceed a moderate risk. Therefore, he establishes an OEG of no more than 30 cGy for Company B in this operation. He then examines the estimate of hazard shown on the contamination chart provided by the division NBCC. If it does not exceed the OEG, he consults with the S3 and the surgeon concerning the potential of B Company's personnel for successful accomplishment of the mission under the conditions contemplated. The steps discussed above usually precede finalization of an operations plan and are accomplished routinely through normal staff action.

DATE: 30 OCT 9X  
 UNIT: B Company

Radiation status category	Numerical criteria Total cumulative dose (cGy)
RES - 0	0 = (no exposure)
RES - 1	1 = Greater than 0, but less than or equal to 70
RES - 2	2 = Greater than 70, but less than or equal to 150
RES - 3	3 = Greater than 150

Radiation Exposure Chart				
ELEMENT	Previous Exposure	New Exposure	Total Exposure	RES Category
<b>B1</b>	<b>20</b>	<b>20</b>	<b>40</b>	<b>1</b>
<b>B2</b>	<b>20</b>	<b>20</b>	<b>40</b>	<b>1</b>
<b>B3</b>	<b>0</b>	<b>0</b>	<b>0</b>	<b>0</b>
<b>B4</b>	<b>20</b>	<b>0</b>	<b>20</b>	<b>1</b>

Radiation status category of company or battalion	Number of platoons in company or number of companies in battalion						Category Total
	2	3	4	5	6	7	
	Sum of RES numbers of all platoons or companies						
RES - 0	0	0-1	0-1	0-2	0-2	0-3	Overall Status <b>1</b>
RES - 1	1-2	2-4	2-5	3-7	3-8	4-10	
RES - 2	3-4	5-7	8-9	8-12	9-14	11-17	
RES - 3	5-6	8-9	10-12	13-15	15-18	18-21	

Figure A-4. Radiation dose status chart, month 10.

## Appendix B

# Shielding

Shielding reduces the effects of gamma radiation on personnel and equipment. Metal, concrete, soil, water, and wood are good shielding materials. The denser the material, the better the shield. Low-density materials are as effective as higher density materials when the total thickness of the low density material is increased. Density is defined as the number of molecules per unit of volume. The denser a material, the better shield it makes.

It is not possible for gamma radiation to be completely absorbed. However, if enough material is placed between the individual and the radiation source, the dose rate can be reduced to negligible proportions.

The three types of radiation which we try to shield against are as follows:

**Alpha Radiation** - A helium nucleus, stripped of its electrons, that travels only a few centimeters in air (5-10 cm) and is an internal hazard only.

**Beta Radiation** - A very high speed electron that travels a few meters in air, but has limited penetrating power. Beta radiation is an external hazard and internal hazard.

**Gamma Radiation** - Pure energy traveling at the speed of light. Gamma can never be totally shielded out, but can be reduced to insignificant or negligible levels.

To determine the effectiveness of shielding, you must calculate the dose rate (inside or outside) based on the density and thickness of a given shield. This calculation requires determining the half-thickness or total thickness of a particular shielding material.

## Principles

**Density** - Mass (number of molecules per unit of volume). The denser a material, the better shield it makes.

**Half-thickness** — The amount of material required to reduce the dose rate by one-half,

**Total thickness** - This is the actual thickness of the shielding material.

**Position of the shield** — The closer the shield is to the source the better.

**Dose rate build-up** — This is produced by the shield. The shield causes radiation to scatter; therefore, the closer you are to the shield the higher the dose rate.

## Materials

**Earth.** The most common shielding material. About one foot of earth makes a very adequate shield.

**Concrete.** About 6 to 8 inches of concrete makes a good shield.

**Steel.** Tanks and (USMC) amtracks are very good shields against radiation.

**Buildings.** Wood or brick buildings make good shields.

## Effectiveness

The effectiveness of a given material in decreasing radiation intensity is measured in units of half-value-layer thickness, or half-thickness. This unit is defined as the thickness of any material which reduces the dose rate of gamma radiation to one-half its unshielded value. Thus, if a soldier were surrounded by a 6-inch concrete wall (6 inches is the half-thickness of concrete) and the gamma radiation outside were 200 cGyph, he or she would receive gamma radiation at the rate of 100 cGyph. The addition of another 6 inches reduces the rate to 50 cGyph. Each succeeding half-thickness of concrete would, therefore, reduce the radiation dose by one-half.

**Problem:** How many half-thicknesses of the above concrete wall reduce the radiation dose to 25 cGyph?

**Solution:** Beginning with the rate of 200 cGyph, the first half-thickness reduces it to 100 cGyph. The second half-thickness reduces the dose rate to 50 cGyph, and the third to 25 cGyph. Three half-thicknesses (18 inches) of concrete meets the requirement.

## Mathematical Method

A series of computations are necessary to determine shielding requirements. The following symbols represent

unknown values. An equation accompanies each to allow a better understanding of what each represents.

- $R_0$  = Initial dose rate with no shielding.  $R_0 = (2^n) (R)$
- $X_{1/2}$  = half-thickness of a shielding material.  $X_{1/2} = \frac{X}{n}$
- $X$  = Total thickness of the shielding material  $X = (n) (X_{1/2})$
- $R$  = Final dose-rate resulting from  $X$  amount of shielding.  $R = \frac{R_0}{2^n}$
- $n$  = The number of half-thicknesses contained in  $X$ , the total thickness of material.  $2^n = \frac{R_0}{R}$

Sample problem, using mathematical method:

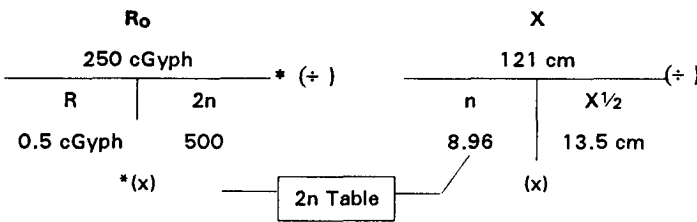

Sample problem, using the same method with the (2n table): Use Table B-1 (page B-5) to simplify the process. Table B-1 includes directions for extrapolating safe-sided values not listed in the table. Table B-1 eliminates the need for logarithms, graph paper, or slide rule.

### Sample Problems

**Problem:** Find the final dose rate with a known amount of shielding.

**Situation:** You are in a bunker after a nuclear detonation and need to know what final dose rate you will receive. The initial dose rate with no shielding ( $R_0$ ) is 2,000 cGyph. The total thickness of the shielding material ( $X$ ) is 31 centimeters. The half-thickness of the shielding material

( $X_{1/2}$ ) is 4 centimeters. What is the final dose rate resulting from the shielding?

- $R_0 = 2,000$  cGyph
- $X = 31$  cm
- $X_{1/2} = 4$  cm
- Find:  $R$

Solution: First, solve the equation  $n = \frac{X}{X_{1/2}}$ :

$$n = \frac{X}{X_{1/2}} = \frac{31 \text{ cm}}{4 \text{ cm}} = 7.75.$$

Enter Table B-1 in the  $n$  column and find  $n = 7.7$  and  $7.8$ . Go to Table B-1. You are looking for  $R$ , and you entered with  $n$ ; so, select the smaller  $n$  value of 7.7. Read the corresponding  $2n$  value of 206. Apply the equation

$$R = \frac{R_0}{2n} = \frac{2,000 \text{ cGyph}}{206(2n \text{ value})} = 9.71 \text{ cGyph}.$$

Figure B-1, below, shows the key strokes for algebraic notation system calculators.

Note: Solutions based on calculator key strokes will always be smaller than those based on the  $2n$  safe-sided table, as a mathematical formula is more accurate than a nomogram.

**Situation:**  $R = 1.5$  cGyph  $X = 12$  cm  $X_{1/2} = 5$  cm.  
Find: The outside dose rate.

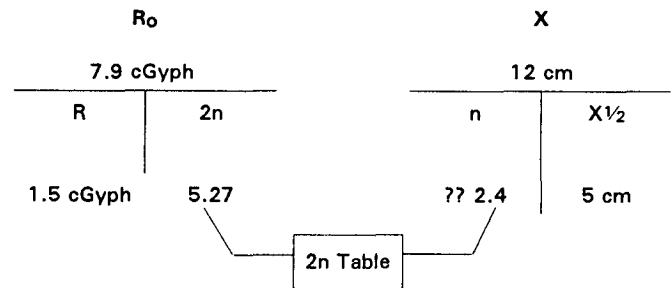

**Situation:**  $R = 1$  cGyph  $R_0 = 120$  cGyph  $X = 24$  cm.  
Find: The half thickness for the shielding material.

**To find X:**  
 $R_0 \div R = \text{Ln}x \div .693 = X \times X_{1/2}$

**To find X<sub>1/2</sub>:**  
 $R_0 \div R = \text{Ln}x \div .693 = \text{STO} \times \div \text{RCL} =$

**To find R:**  
 $X \div X_{1/2} = \text{STO} \text{ 2 } Y^x \text{ RCL} = \text{STO} R_0 \div \text{RCL} =$

**To find R<sub>0</sub>:**  
 $X \div X_{1/2} = \text{STO} \text{ 2 } Y^x \text{ RCL} = X \times R =$

   = Calculator key. Ln x may appear as INV on some calculators.

Figure B-1. Key strokes for algebraic notation system calculators.

FM 3-3-1

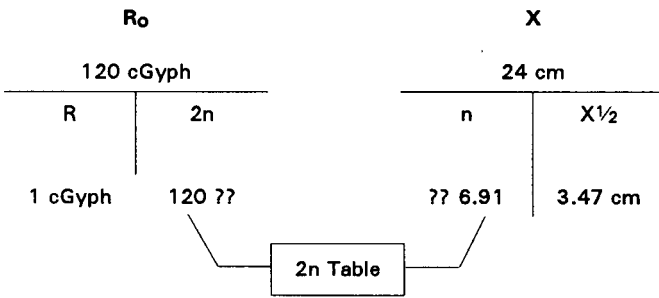

\* Note: When working any problem with the mathematical method, a horizontal line means you divide; a vertical line means you multiply.

Having found the half thickness for the shielding material in the problem above, the NBC officer wants to know how much material is needed to reduce a dose rate of 25 cGyph down to .5 cGyph.

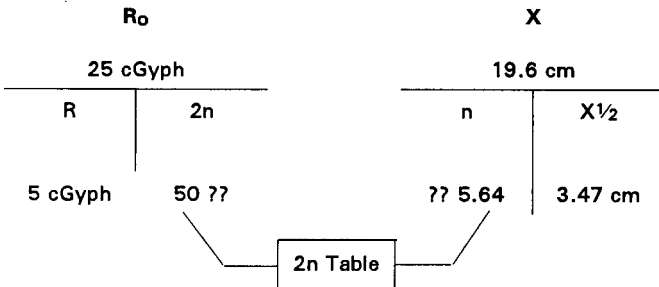

The bunker you are in has two feet of sandbags on it. A monitor has reported a dose rate reading of 36 cGyph outside. The commander has taken the monitor on a trip to the division Command Center. The NBC Officer must report the inside reading to the battalion XO in ten minutes. Division NBC has reported that 4.7 inches of the local earth in sandbags will reduce a dose rate in half.

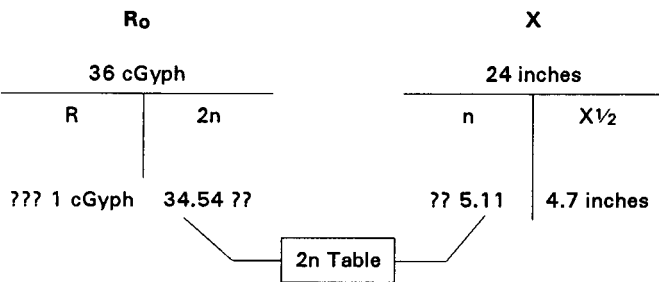

**Problem:** Find the half thickness, using the 2n table.  
 Situation 1: An initial dose rate with no shielding (Ro) was 1,000 cGyph. The total thickness of the bunkers shielding material (X) is 27 cm. A final dose-rate (R) received inside the bunker was 7.60 cGyph. What is the half thickness of the bunkers shielding material?

Ro = 1,000 cGyph  
 X = 27CM  
 R = 7.60 cGyph  
 Find: X½.

solution  

$$2n = \frac{Ro}{R} = \frac{1,000cGyph}{7.6cGyph} = 132.$$

Enter Table B-2 in the 2n column and find 2n equals 128 and 136. Table B-1 directs use of the smaller 2n of 128. Read corresponding n value of 7.0.

Apply the equation:  

$$X_{1/2} = \frac{X}{n} = \frac{27cm}{7.0} = 3.86cm.$$

**Problem:** Find total thickness of shielding.  
 Situation 2. You reported an initial dose rate with no shielding (Ro of 500 cGyph after a nuclear detonation. Your shielding material has a half-thickness of 7.5 cm (thickness of material necessary to degrade gamma radiation dose by one-half).

For safety, you desire no more than 1 cGyph exposure inside a bunker. What thickness of shielding material is needed to protect the occupants?

Ro = 500 cGyph  
 X½ = 7.5 cm  
 R = 1 cGyph  
 Find: X.

First, solve for 2n:  

$$2n = \frac{Ro}{R} = \frac{500cGyph}{1cGyph}$$

Enter Table B-2 in 2n column, and find 2n is between 480 and 512. Table B-1 directs use of the larger 2n of 512. Read the corresponding n value of 9.0. Use the equation X = (n) (X-1/2) = (9.0) (7.5 cm) = 67.5 cm.

**Problem:** Find the initial dose rate with no shielding.

Situation 3: A bunker has a total thickness of 12 cm shielding material (X). The half-thickness of the shielding material (X-1/2) is 6.25 cm. From inside the bunker, a final dose-rate (R) of 5 cGyph is read. What was the initial dose rate with no shielding (Ro)?

X = 12cm  
 X½ = 6.25 cm  
 R = 5 cGyph.  
 Find: Ro

Solution:  
 First, solve the equation for n:  

$$n = \frac{X}{X_{1/2}} = \frac{12cm}{6.25cm} = 1.92cm.$$

Enter Table B-2 in the n column, and find n is between 1.9 and 2.0. Table B-1 directs use of the larger n value of 2.0. The corresponding 2n value is 4. Utilize the equation Ro = (2n) (R)

$$Ro = (5 cGyph) (4.0) = 20 cGyph.$$

## Transmission Factors

Transmission factors are used in radiation calculations to determine the impact of shielding on radiation exposure. TFs are simpler and preferred when the half thickness and total thickness are not important, and only the actual reduction of the dose rate is the primary consideration. Transmission factors are always less than 1.

### Determination of Transmission Factors

TFs are calculated using the following formula:

$$\frac{\text{ID}}{\text{OD}} = \text{TF}$$

ID = inside dose, or dose rate.  
 OD = outside dose or dose rate.  
 TF = transmission factors.

### Sample Problems

Situation: ID = 66 OD = 550.

Find: TF.

Solution:  $66 \div 550 = .12$ .

Situation: ID = 45 OD = 120.

Find: TF.

Solution:  $45 \div 120 = .375$ .

Situation: You are inside a tank with a reading of 45 cGyph, and you have recorded an outside reading of 1,125 cGyph. What is the TF for the tank?

Solution:  $45 \div 1125 = 0.04$ .

### Exercise Problems

In the table below are half-thicknesses for some common materials (These values will be used in solving the problems that follow.):

Material	Half-thickness (inches)
Steel	0.7
Concrete	2.2
Earth	3.3
Wood	8.8

**Problem:** The outside dose rate of residual radiation in a radiologically contaminated area is 400 cGyph at H + 1.

Find: What would be the dose rate inside a concrete bunker if the walls were 10 inches thick?

Solution:

$R_0 = 400$  cGyph.

$$R = \frac{R_0}{2n} = \frac{400}{23.42} = 17.08 \text{ cGyph.}$$

X = 10 inches.

$X^{1/2} = 2.2$  inches.

$$n = \frac{10}{2.2} = 4.55.$$

$2n = 23.42$ .

Find: What would be the dose rate if you added 1 foot of earth cover to the bunker?

Solution:

$R_0 = 17.08$  cGyph.

$$R = \frac{R_0}{2n} = \frac{17.08}{12.47} = 1.37 \text{ cGyph.}$$

X = 12 inches.

$X^{1/2} = 3.3$  inches.

$$n = \frac{12}{3.3} = 3.64.$$

$2n = 12.47$ .

Find: What would the dose rate be inside a tank with 3 inches of armor plating (steel)?

Solution:

$R_0 = 400$  cGyph.

$$R = \frac{R_0}{2n} = \frac{400}{19.56} = 20.45 \text{ cGyph.}$$

X = 3 inches.

$X^{1/2} = 0.7$  inches.

$$n = \frac{3.0}{0.7} = 4.29.$$

$2n = 19.56$ .

**Problem:** In the same radiologically contaminated area, the dose rate has decayed to 180 cGyph at H + 2 hours. Which of the following would offer you more protection from the radiation: a wooden building with 2-inch walls; a concrete bunker with 6-inch walls; a foxhole with 12 inches of earth cover?

Solutions:

**Building:**  $R_0 = 180$  cGyph.

R = ?

$X^{1/2} = 8.8$  inches.

X = 2 inches.

$$n = \frac{2.0}{8.8} = 0.23.$$

**Bunker:**  $R_0 = 180$  cGyph.

R = ?

$X^{1/2} = 2.2$  inches.

X = 6 inches.

$$n = \frac{6.0}{2.2} = 2.73.$$

**Foxhole:**  $R_0 = 180$  cGyph.

R = ?

$X^{1/2} = 3.3$  inches.

X = 12 inches.



$$n = \frac{6.0}{2.2} = 3.64.$$

**Answer:** A foxhole with 12 inches of earth cover would give the best protection.

**Note:** The higher the n, the higher the 2n; so, the better the protection. The higher 2n divided into the R<sub>0</sub> will result in a smaller R.

**Problem:** You are located in a tank in a radiologically contaminated area. The dose rate inside is 75 cGyph. The tank has approximately 2 inches of armor plating (steel).

**Find:** What is the approximate outside dose rate?

**Solution:**

$$R_0 = 6.95 \times 75 = 521.25 \text{ cGyph.}$$

$$R = 75 \text{ cGyph.}$$

$$X^{1/2} = 0.7 \text{ inches (from Table B-3).}$$

$$X = 2.0 \text{ inches.}$$

$$n = \frac{2.0}{0.7} = 2.86.$$

$$2n = 6.95 \text{ (from Table B-1, next page).}$$

The guide for safe-siding depends on the unknown variable. For example, if the thickness is unknown, find X in the unknown column, read to the right. Enter the table with 2n, select the larger value of 2n, and leave with the value of n corresponding to that larger value.

**Note:** Gamma radiation energy varies.

**Table B-1. 2n values and guide for safe siding 2n values (right)**

Unknown	Enter 2n Table With	Select	Leave 2n Table With
X <sup>1/2</sup>	2n	Smaller 2n	n
X	2n	Larger 2n	n
R	n	Smaller n	2n
R <sub>0</sub>	n	Larger n	2n

n	2n	n	2n	n	2n	n	2n	n	2n
0.0	1.000	4.5	22.6	9.0	512	13.5	11.600	18.0	262.000
0.1	1.072	4.6	24.2	9.1	550	13.6	12.900	18.1	279.000
0.2	1.149	4.7	25.9	9.2	580	13.7	13.300	18.2	299.000
0.3	1.232	4.8	27.8	9.3	630	13.8	14.200	18.3	320.000
0.4	1.320	4.9	29.8	9.4	680	13.9	15.400	18.4	327.000
0.5	1.415	5.0	32.0	9.5	720	14.0	16.384	18.5	369.000
0.6	1.515	5.1	34.2	9.6	770	14.1	17.600	18.6	395.000
0.7	1.627	5.2	36.7	9.7	830	14.2	18.850	18.7	426.000
0.8	1.743	5.3	39.2	9.8	890	14.3	20.200	18.8	456.000
0.9	1.868	5.4	42.1	9.9	950	14.4	21.800	18.9	492.000
1.0	2.00	5.5	45.2	10.0	1,024	14.5	23.200	19.0	525.000
1.1	2.15	5.6	48.4	10.1	1,100	14.6	24.800	19.1	564.000
1.2	2.30	5.7	52.0	10.2	1,180	14.7	26.600	19.2	594.000
1.3	2.47	5.8	56.0	10.3	1,260	14.8	28.500	19.3	646.000
1.4	2.57	5.9	60.0	10.4	1,350	14.9	30.600	19.4	696.000
1.5	2.83	6.0	64.0	10.5	1,455	15.0	32.768	19.5	738.000
1.6	3.03	6.1	68.0	10.6	1,566	15.1	35.100	19.6	788.000
1.7	3.25	6.2	74.0	10.7	1,670	15.2	37.600	19.7	852.000
1.8	3.48	6.3	78.0	10.8	1,780	15.3	40.200	19.8	903.000
1.9	3.73	6.4	84.0	10.9	1,920	15.4	43.200	19.9	974.000
2.0	4.00	6.5	90.0	11.0	2,048	15.5	46.400	20.0	1,050.000
2.1	4.28	6.6	97.0	11.1	2,200	15.6	49.600		
2.2	4.59	6.7	104.0	11.2	2,360	15.7	53.300		
2.3	4.95	6.8	112.0	11.3	2,530	15.8	57.400		
2.4	5.28	6.9	119.0	11.4	2,640	15.9	61.600		
2.5	5.65	7.0	128.0	11.5	2,900	16.0	65.536		
2.6	6.05	7.1	136.0	11.6	3,110	16.1	69.700		
2.7	6.50	7.2	146.0	11.7	3,330	16.2	75.800		
2.8	6.95	7.3	157.0	11.8	3,560	16.3	80.000		
2.9	7.45	7.4	170.0	11.9	3,820	16.4	86.200		
3.0	8.00	7.5	181.0	12.0	4,096	16.5	92.300		
3.1	8.55	7.6	194.0	12.1	4,390	16.6	99.500		
3.2	9.18	7.7	206.0	12.2	4,700	16.7	107.000		
3.3	9.85	7.8	220.0	12.3	5,070	16.8	115.000		
3.4	10.60	7.9	240.0	12.4	5,420	16.9	122.000		
3.5	11.30	8.0	256.0	12.5	5,790	17.0	131.072		
3.6	12.10	8.1	272.0	12.6	6,200	17.1	139.000		
3.7	13.00	8.2	292.0	12.7	6,760	17.2	150.000		
3.8	13.90	8.3	312.0	12.8	7,120	17.3	162.000		
3.9	15.00	8.4	338.0	12.9	7,630	17.4	174.000		
4.0	16.00	8.5	360.0	13.0	8,192	17.5	186.000		
4.1	17.20	8.6	385.0	13.1	8,760	17.6	199.000		
4.2	18.40	8.7	415.0	13.2	9,410	17.7	211.000		
4.3	18.70	8.8	445.0	13.3	10,100	17.8	228.000		
4.4	21.20	8.9	480.0	13.4	10,870	17.9	246.000		

## Appendix C

# Nuclear Burst Effects on Electronics

Electromagnetic pulse is a nuclear weapons effect that can have significant impact on electrical and electronic equipment. EMP, although it represents only one percent of the total energy produced by a nuclear burst, can destroy or cause serious damage to electronic equipment through current surges.

Transient-radiation effects on electronics has similar effects to EMP, except TREE is caused by gamma and neutron (initial) radiation. Although gamma radiation causes only temporary ionization of electronic components, this can lead to permanent damage in other parts of the

equipment. Fast neutrons cause permanent damage by displacing (or dislodging) atoms in crystals. Shielding that reduces gamma and neutron radiation will reduce the effects of TREE. The cause of the damage may be short in duration but permanent. Damage amount depends on the dose rate. The effects on electronic equipment may or may not be shielded out.

Unlike lightning, EMP does not produce a flash in the sky or a loud noise. Also, devices that protect equipment against lightning do not necessarily provide protection against EMP (see Figure C-1).

## Types of EMP

Nuclear explosions occurring at heights of roughly 2 kilometers to 30 kilometers are, for complex technical reasons, less likely to produce EMP effects of concern to forces in the field. There are two types of EMP of particular importance for tactical forces:

- Surface-burst EMP (SBEMP)
- High-altitude EMP (HEMP).

### Surface-Burst EMP

Surface-burst EMP is produced whenever a nuclear device is set off on the ground or at a low altitude above the earth. A tactical nuclear weapon could produce SBEMP.

SBEMP from surface bursts at altitudes of about 200 meters or less can be even more powerful than HEMP—HEMP energy levels may be in the range of 50,000 volts per meter. Values for SBEMP may be in the region of one million volts per meter. Furthermore, these high levels of SBEMP may couple (weld together) buried or above-ground cables outside the immediate vicinity of the nuclear detonation. If this happens, these cables may remain intact and transmit tremendous surges of energy to connected systems down the line.

Because of the physics involved, SBEMP fields extend only to ranges on the order of 10 to 20 kilometers from the point of detonation. These fields are significant for tactical units that might be far enough away from a nuclear

detonation to avoid damage due to blast, thermal and other effects, but they still may be subject to damage from SBEMP. At the same time, however, a range denoted in tens of kilometers is considerably below the ranges associated with HEMP; its effects can cover areas on the order of thousands of kilometers.

Furthermore, depending on a unit's location within the area affected by SBEMP, other effects (blast, thermal, radiation) may be of greater tactical significance. For

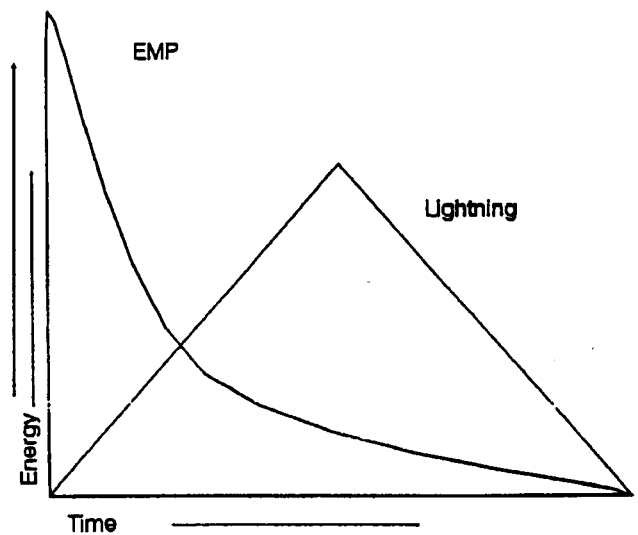

Figure C-1. Comparison of EMP and lightning en-

high-altitude nuclear detonations, in contrast, EMP is the only militarily significant nuclear weapons effect.

A unit not affected by the other effects of a near surface burst of a nuclear weapon can still be affected by SBEMP, which is the most far-reaching of the prompt effects produced by a nuclear weapon detonated on the ground or at low altitude.

When units are threatened by SBEMP, commanders are aware that a threat exists because of the thermal, blast, and other effects of the nuclear detonation. However, commanders may not be aware of the effective ranges at which the SBEMP energy can damage critical electronic equipment. For example, if a 10-kiloton nuclear weapon were detonated on the ground, the safety (standoff) distance for troops in the open is about 2,400 meters. At this range, troops could withstand the thermal effects, which would extend farther than blast and other immediate effects. In this same example, however, EMP damage to some types of critical electronic equipment could occur at ranges of 5,000 meters.

### High-Altitude EMP

High-altitude EMP (HEMP) is produced when a nuclear explosion occurs 30 kilometers or more above the earth's surface. Because of the physical processes that generate HEMP, which differ from those that produce SBEMP, HEMP effects can have considerable strength at great distances. Units throughout a theater might be affected without ever being aware that a nuclear explosion had taken place. An example of HEMP's effects is provided by a test conducted by the United States in 1962 in which a nuclear device was detonated above Johnston Island in the Pacific. EMP effects were evident in electronic devices in Hawaii, 800 miles away from the test site.

Furthermore, a nuclear detonation 400 kilometers above Moscow would produce an EMP field that would cover all of Germany. US forces in Germany would not see a flash nor feel a shockwave, yet the HEMP field could damage or destroy critical electronic components in communications systems and other materiel. While the strengths of HEMP fields vary, it could be as much as 50,000 volts per meter. Since field forces have no way to anticipate the levels of EMP to which they will be subjected, tactical units must be capable of withstanding the worst case, 50,000 volts per meter. Figure C-2 illustrates HEMP ground coverages of at least 25,000 volts per meter for heights of burst of at least 100 kilometers (inner ring) and 500 kilometers (outer ring).

While 99 percent of HEMP energy is at frequencies below 100 megahertz, most HEMP occurs in the frequency ranges between 100 kilohertz and 10 megahertz.

Communication systems operating in these frequency ranges are most likely to pick up EMP energy and suffer damage. Correspondingly, microwave and other systems that operate at higher frequencies are less likely to be

impaired because their antennas are not designed to pick up energy in the frequency ranges in which EMP energy is most likely to occur. Because of the extremely high altitudes of the explosions that produce HEMP, forces in the field will not be affected by the blast, thermal, radiation and other effects of the nuclear weapon. Indeed, field units may not have any indication that a nuclear explosion has occurred except for the arrival of HEMP and the resultant effects on electronic equipment.

In some respects, EMP energy is similar to radio waves produced by nearby lightning strikes. Both involve a sudden pulse of energy, and both are attracted to intentional and unintentional collectors or antennas. EMP and lightning differ in the following crucial respects:

- EMP pulses rise much more rapidly. The pulse rise time for EMP may be a few billionths of a second; the comparable interval for a lightning pulse involves millionths of a second.
- Each field strength can differ radically. Lightning may be in the range of a few thousand volts per meter; EMP can involve 50,000 volts per meter. In some circumstances, a nearby lightning strike (50 to 100 meters distant) may be similar to some manifestations of EMP energy.
- HEMP pulses are shorter in duration—usually less than a thousandth of a second as compared to lightning pulses that last hundreds of milliseconds.
- Lightning occurs at much lower frequencies and in bands well below the frequencies used by tactical communications systems. Unfortunately, EMP concentrates in some of the bands most frequently used by tactical communications systems.

Because of these differences, devices that provide protection against lightning strikes may not necessarily protect against EMP effects.

### The HEMP Threat

High-altitude EMP (HEMP) can present unique threats to tactical forces. Because of the extremely high altitudes at which these nuclear detonations occur, forces on the



**Figure C-2. EMP ground coverage over US map.**

ground may be unaware of the explosion until after EMP has struck, causing damage to unhardened equipment.

Such a high-altitude nuclear burst could disable US forces' communications, sensors, and other electronic equipment. By employing hardened equipment and using mitigation techniques, the aggressor might use HEMP to create confusion and surprise in US forces.

This type of preliminary attack would have an added advantage, aside from its effects on electronic systems: the high altitude nuclear burst would not cause collateral damage.

In this unclassified publication, a detailed assessment of enemy threats cannot be provided. Note, however, that such exploitations of HEMP effects would be consistent with the emphasis Threat military doctrine places on surprise attack, the potential use of nuclear weapons at the outset of a conflict, and Threat operational procedures in which units are trained to operate for sustained periods

with minimal communications (and hence less reliance on communications equipment). Furthermore, some unclassified assessments suggest that many items of Threat military equipment may be capable of withstanding EMP effects.

Because of the possibility of nuclear proliferation, the unique threats posed by HEMP may be encountered in conflicts with other aggressor nations as well. A nation that has only recently acquired nuclear weapons may have only a small number of them available for use. In a conflict with the United States, such a nation might use one or more nuclear weapons to produce HEMP effects to disrupt operations of US forces and make them more vulnerable to follow-on conventional, chemical, and nuclear attacks.

These threats posed by HEMP reinforce the requirement to integrate EMP mitigation techniques into tactical unit standing operating procedures to ensure that mission-essential capabilities are not upset or destroyed.

## Tactical Equipment

Tactical units use many types of electronic equipment and electrical components, such as radios, radars, power generators, calculators, fire-control systems, computers, and computer chips. Also, units use civilian sources for electrical power. The primary threat of EMP is damage to electronic equipment and components.

Both HEMP and surface burst EMP (SBEMP) can damage electronic equipment by causing current surges, burning out or melting components, and upsetting computer memories. Modern microprocessor computer chips, increasingly used in tactical equipment, are particularly vulnerable since they are designed to operate at very low power levels.

EMP can cause functional damage or operational upset. Functional damage is physical damage to equipment that requires replacement or repair of components. It should not be assumed that equipment suffering from functional damage is destroyed forever. By using postattack mitigation procedures, it may be possible to quickly return the item to use (such as, by replacing fuses and resetting circuit breakers).

No physical damage is evident with operational upset. This may appear to be less important than functional damage. However, it can be just as damaging, because EMP interferes with the operation of the equipment by erasing data from a computer memory or by causing a computer device to send an erroneous signal to the piece of equipment it controls. In addition, operational upset is of concern because it can occur at EMP energy levels that are 1/10th to 1/100th of those required to inflict functional damage. EMP does not directly affect internal electronic components. It can only cause damage if it gets into a piece of equipment through collectors or antennas, or if it

penetrates an equipment case and couples to internal wiring. Examples of damage caused by operational upset are-

- Operators of intelligence gathering and target acquisition equipment may lose track of hostile forces.
- Essential information such as crypto identification codes may be lost.
- Pilots of helicopters and fixed-wing aircraft may be given erroneous information on their instrument panel readouts.
- Weapon guidance systems may malfunction.

Unhardened equipment varies in its vulnerability to EMP. While the hardness or vulnerability levels of specific items of equipment are classified, the most vulnerable categories of equipment are shown in Figure C-3 (next page).

As emphasized in Figure C-3, vulnerability to EMP can vary significantly within each category of equipment. Several rules of thumb can be employed to make rough estimates of the vulnerability of electronic equipment (None of these rules apply to EMP-hardened equipment. Hardened material should withstand EMP effects.):

- Any system that employs a digital computer is susceptible, particularly to upset. EMP can destroy or distort the information contained in the computer's memory.
- Pieces of equipment with state-of-the-art, low-power transistors and semiconductors are more susceptible to EMP damage than similar equipment using older technologies with vacuum tubes.
- The more powerful the signal a piece of equipment (such as a radio receiver) is designed to receive, the less susceptible it is to EMP-induced damage.
- Equipment with large collectors is more susceptible to EMP damage than equipment with small collectors.

- Unhardened radios operating at frequencies of 100 megahertz or below, (such as, high frequency systems) are susceptible. Communications systems operating at frequencies above 100

megahertz (such as, super high frequency and microwave equipment) may be less susceptible.

## Personnel

Personnel can be directly injured by EMP only if they are physically touching metallic collectors (cables, railroad lines, etc.) at the moment of the tremendous EMP surge. However, troops are unlikely to be in this situation and can be instructed to avoid physical contact with such collectors.

EMP hazards may exist from indirect or secondary EMP effects. For example, damaged electronic equipment may

catch fire if relays are switched to the wrong positions. Also, pilots may receive incorrect information from digital instruments that have been upset by EMP. These secondary effects can be mitigated using appropriate standing operating procedures.

## Collectors and Antennas

Unlike some other nuclear weapon effects, the damage caused by EMP depends in large part on the configuration of the equipment subjected to it. For example, equipment that has been developed in EMP hardening programs can resist high levels of EMP. The key to these hardening programs is shielding—creating barriers between the EMP energy and critical components of the equipment. Recall that EMP is a powerful radio wave, and like other radio waves, it is picked up by collectors and antennas. Shielding eliminates unintentional antennas or creates protective barriers around critical electronic components.

While there is no substitute for the use of equipment that has been hardened against EMP, some of the principles of EMP hardening and shielding can be employed by units in the field to minimize EMP effects. Collectors and antennas have a major impact on the amount of EMP energy that can get into a piece of equipment and cause damage.

In developing EMP mitigation plans, commanders need to know about the two types of antennas that absorb EMP

- Intentional antennas are those normally used with tactical communications equipment.

- Unintentional antennas are any metal conducting materials, to include rail lines, pipes, power lines, vehicle bodies, and concertina wire used to protect positions.

Commanders' EMP mitigation plans will be effective only if they deal with both types of collectors and antennas. Usually, there are a number of unintended EMP collectors in or near a tactical unit.

Commanders can identify the unintended antennas in their units and areas of operations to which EMP mitigation procedures must be applied. If there is a metal object in the unit area that you would not want to touch during a lightning storm (particularly if you were to take the object and place it vertically in the air), it is probably an unintended antenna, such as, a long wire, grounding rod, spool of metal cable, or rail line.

However, this rule of thumb only applies to the identification of potential unintended antennas through which EMP energy might couple to electronic/electrical systems. EMP is not the same as lightning, and devices that provide protection against lightning generally do not automatically provide protection against EMP.

## Basic Planning

EMP mitigation is not something that can be handled by a higher headquarters. Each unit employing communications and other electronic equipment must develop and implement an EMP mitigation plan consistent with its assigned mission(s). The following paragraphs contain planning considerations that should be used when developing mitigation plans.

### **Take EMP effects seriously.**

If no mitigation procedures are used, both HEMP and surface-burst EMP (SBEMP) can damage mission-essential electronic equipment that is not hardened.

### **Don't exaggerate the effects of EMP.**

EMP is not a blinding flash of energy that instantly kills or injures everyone or automatically destroys tactical material. Primarily, it affects electronic equipment and the use of mitigation techniques can reduce or eliminate damage caused by EMP. Hardened items may not be affected at all.

Don't regard EMP as a hard to understand newly discovered effect. EMP was one of the nuclear weapon effects predicted during the first nuclear tests, and it has been studied for over 30 years. You don't have to be a nuclear physicist to understand how EMP can affect

tactical equipment or to develop and implement effective mitigation procedures.

**Use hardened equipment.**

Through command channels, commanders can obtain information concerning the EMP hardness of their equipment, including the identification of equipment that has been hardened in EMP shielding programs.

Make maximum use of and place primary reliance on hardened equipment.

Keep hardened equipment hardened. Improper use or maintenance can reduce the hardness or shielding of equipment. Use EMP mitigation procedures to maintain the hardness of shielding equipment; and ensure that troops follow maintenance procedures specified in technical manuals.

Know your equipment. Ensure all personnel in the unit know their equipment and understand the factors that make these items more or less vulnerable to EMP damage. Some characteristics, such as the use of microprocessor computer chips in a system or the presence of an intended or unintended antenna, can have a major impact on a piece of equipment's vulnerability.

Avoid myths and misconceptions. EMP has been the subject of a number of popular science articles that are not necessarily accurate. Some false rumors about EMP and EMP mitigation have been circulating. Here are the facts—

Don't rely on lightning suppressors and arrestors. While EMP is similar to lightning in some ways, EMP is more powerful and differs in other characteristics. Hence, military and commercial devices that provide adequate protection against lightning strikes generally do not provide protection against EMP.

Don't plan on wrapping everything in aluminum foil or putting every item of equipment in metal boxes. Taking these steps may make sense when dealing with small, redundant items, such as an extra hand-held calculator might be kept in a sealed ammunition can. As a general rule, it doesn't make sense to try to put all of your equipment away in these types of expedient shielded containers. In reality, your equipment may not be protected and more importantly, you need your equipment to accomplish the mission.

Don't rely on nonmilitary standard commercial equipment. During peacetime

training, it is tempting to use commercial radios and other nonmilitary-issue equipment which are nonstandard and not

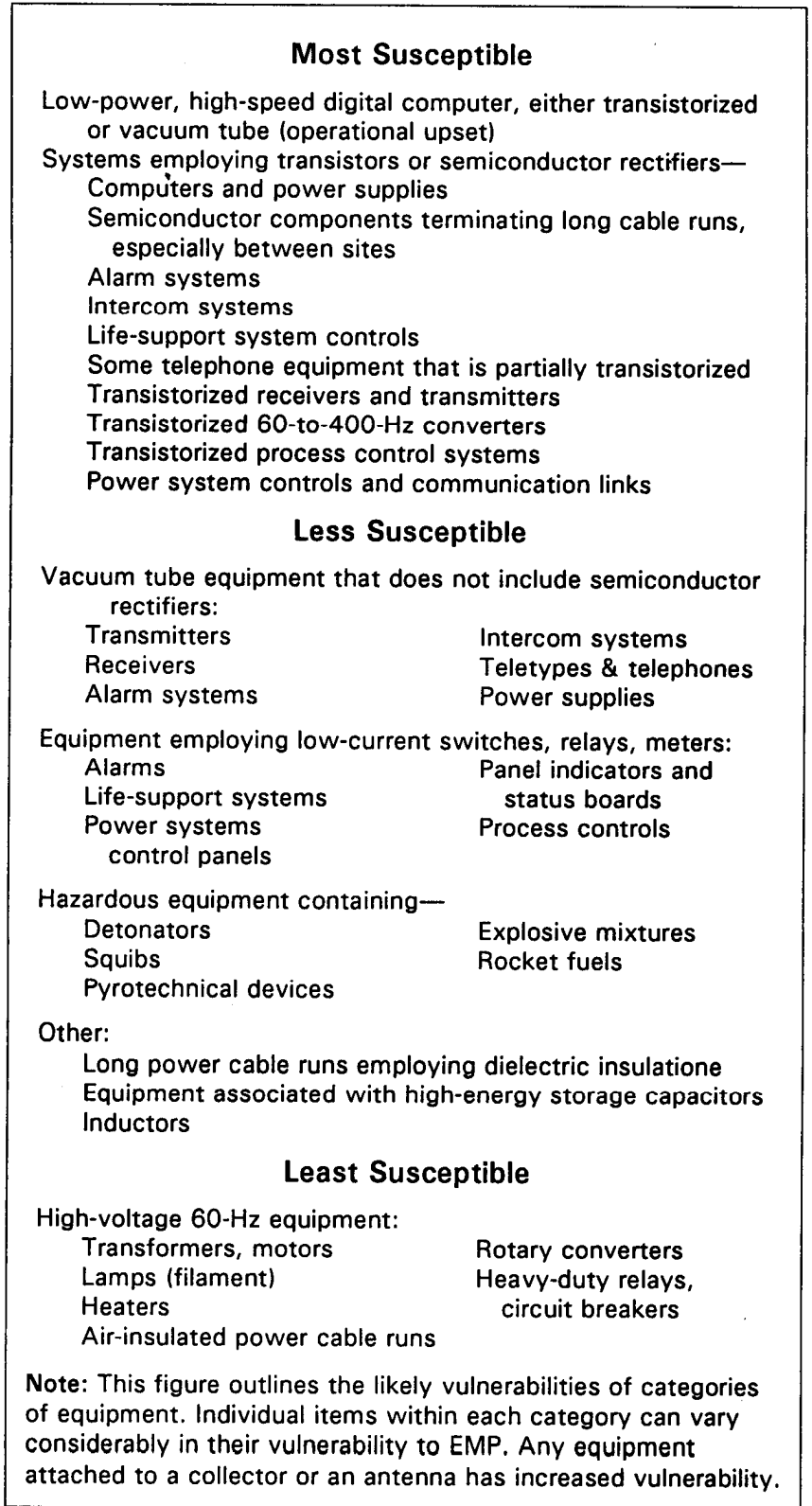

Figure C-3. Degrees of susceptibility to EMP for equipment.

EMP hardened. In many situations, quick reconstitution and recovery of standard-issue equipment will be possible because the needed parts are in the supply system. This will not be true for nonstandard items.

Avoid the single-event fallacy. In assessments of potential tactical situations, don't assume that EMP will occur once and then be over. The contrary may be the case. An aggressor may initiate a precursor attack with high altitude EMP to initially damage unprotected equipment, and then follow-up with additional high altitude or surface-burst explosions to exploit the tactical situation. The only valid countermeasure is to adopt and sustain EMP mitigation postures consistent with tactical missions.

Anticipate EMP. Effective EMP mitigation techniques must be integrated into a unit's standard operating procedures. Units should normally operate in a protective posture. Additional protective measures to be undertaken if

warning of an attack is provided should take no more than 15 minutes to implement.

#### **Integrate EMP mitigation into battle plans.**

AirLand Battle doctrine requires the synchronization of all elements of the force in integrated plans. Commanders must understand their superiors' overall operational concepts and plans, and must take the initiative to exploit opportunities to implement these plans as the opportunities occur.

Effective EMP protection procedures are not confidential nor impractical. In most cases, effective EMP procedures are simply extensions of approved tactical doctrine.

Place priority on EMP mitigation procedures that are consistent with the unit's assigned missions and aligned with the basic operational concept—AirLand Battle doctrine. Place emphasis on mitigation techniques that are integrated into unit standing operating procedures, with particular emphasis on warning or short warning conditions.

## **Mitigation Techniques**

EMP mitigation techniques apply in the following three environments in which tactical units operate:

1. Administrative and training situations.
2. Preattack and during attack operations.
3. Postattack recovery and continued operations.

This appendix presents EMP mitigation techniques appropriate for each of these environments. The distinctions made between these three environments are not hard and fast. For example, tactical operations will be conducted concurrent with the implementation of postattack recovery measures. Furthermore, the presentation of these techniques is cumulative, and the techniques suggested for administrative and training situations also should be carried forward to the preattack, during attack, and postattack environments.

### **Administrative and Training Situations**

Some of the most important EMP mitigation procedures can be initiated under peacetime administrative and training conditions. These include—

- Adhering to maintenance procedures.
- Training with back-up systems.

Under all conditions, the most important EMP mitigation procedures are to use hardened equipment and to maintain equipment hardness by using correct maintenance and operational procedures. Improper maintenance can readily reduce or eliminate a piece of equipment's built-in EMP hardening.

Extreme caution must be exercised when adding components to already hardened equipment, such as, placing new systems in a hardened van or mobile shelter.

As a general rule, making an addition to stand-alone equipment that does not have wires or connectors running outside the protected enclosure does not interfere with the EMP hardening of the shelter. However, any addition of new connectors (such as, running a telephone wire or extra air conditioning or ventilation hoses into a shelter) that do not go through an approved surge arrestor and penetration shield or connector, can seriously impact on the hardness of the protected area.

### **Rules of Thumb**

Many EMP-hardening schemes create shields between the electronic equipment and external EMP environments. Therefore, any cable or other penetration that creates a hole or gap in the shield can seriously degrade the system's survivability. Field units should never add connectors to hardened equipment unless directed to do so. Even the small break in the shielding required "to allow a heater power cord or a ventilation hose to enter can be damaging. A number of rules of thumb can be kept in mind when performing maintenance on both EMP-hardened and nonhardened systems, from backpack radios to communications vans:

- Make every effort to ensure that metal-to-metal connections are clean and provide good metal-to-metal contact. Ensure that no gaps exist in the shield. Don't allow dust or dirt to accumulate. Make sure that sloppy paint jobs don't allow globs or paint to build up along the edges of hatches, doors, or other openings.
- Check for, and repair holes and cracks, ensuring that clean metal-to-metal contact is restored.

- Ensure that operating and maintenance personnel can identify all cable shields used for the system.
- Have maintenance personnel check, repair, and, if necessary, replace shields that become worn or damaged. Ensure that shields make good contact with connector shells.
- Replace loose or damaged connections, such as, gaskets and finger stocks.
- Keep access panel doors and other openings shut whenever possible. Such openings provide breaks in shielding and allow EMP energy to enter and damage components.
- Minimize the length of cable runs and avoid cable loops, if possible. Long runs and loops can create unintentional antennas that attract EMP energy.
- Ensure power systems and other cable layouts are in an approved “tree” configuration. This configuration is outlined in the discussion of cables and grounding.
- If the system uses filters, ensure they are maintained according to appropriate technical manuals.
- DO not add grounding points within an enclosure or shelter. Multiple grounds can create loops, which can have damaging currents induced into them by EMP.
- Ensure copies of all required technical manuals and other pertinent documents are available.
- Train and cross train personnel in prescribed maintenance procedures and evaluate their performance in field conditions. Take advantage of the maintenance required to meet chemical warfare requirements. Vans and cases designed to survive in a chemical warfare environment are often airtight with clean contact between edges of the outer surface of the container. This is the same clean contact required to maintain EMP shielding and hardness.

## Training With Back-Up Systems

Tactical forces use electronic equipment, which can be operationally upset or seriously damaged by EMP, for a variety of purposes, including—

- Position finding and reporting.
- Communications.
- Computation and calculation (such as, targeting solutions).
- Storage of tactical and logistical information.

For each of these functions, there are approved nonelectronic or alternative electronic procedures and systems. Maps and compasses can provide location information. With adequate preplanning, a backup signal system, employing messengers, flares, sound-making devices, and other nonelectronic means, can be employed. Also, multiple electronic systems, such as, wire and SHF radios, can be used to supplement potentially vulnerable HF and UHF radios.

Nomograms and slide rules can be used to solve tactical problems. Also, extra calculators can be stored in empty, sealed ammunition cans within vehicles or vans. Manual systems exist that can be used to sort and retrieve tactical and logistical information.

In a combat environment where forces might be subjected to EMP, a firm grasp of these approved procedures can make the difference between defeat and victory. Commanders can be confident in the ability of their units to employ these approved backup procedures only if they train and test their forces prior to combat.

## Preattack and During-Attack Operations

While it is impossible to list a single set of EMP mitigation procedures to be used in all tactical situations, some general guidelines likely to be valid in most circumstances are discussed in this section.

### Learn to recognize EMP effects.

Under demanding field conditions, individual items of electronic equipment may fail for a number of reasons other than EMP. For instance, combat units may be subjected to radio electronic combat (REC) that may interfere with radio communications by jamming and emitting false signals. It is important not to confuse these events with the effects of EMP. In addition, it is important to recognize that the effects of EMP may not be immediately evident, particularly if a unit has many items of equipment that have been hardened to resist EMP effects. Nevertheless, EMP effects could be present, with potentially disastrous consequences, such as, upsetting computer memories so they no longer provide an accurate portrayal of the tactical situation.

Several rules of thumb can be used to identify the possible presence of EMP effects.

- Failures in electronic systems that are confined to nonhardened items of equipment.
- Failures in multiple types and numbers of nonhardened electronic systems.
- The simultaneous failure of electronic equipment in multiple units. This can be ascertained by establishing contact with adjacent units and higher headquarters.
- The inability to establish electronic communications and/or the sudden occurrence of static. REC can also interfere with radio transmissions; but REC does not cause physical damage to the radio itself. Hence, if nonhardened radios continue to function, but encounter static or jamming, REC, rather than EMP, may be the cause.
- The results of arcing—burnt or melted spots—can indicate the impact of EMP on a nonhardened system.
- If sufficiently close to a surface burst to observe blast and thermal signatures, presume that EMP effects may be present. Use the other rules of thumb to identify the potential effects of high-altitude EMP.

**Ensure subordinate leaders understand the commander’s operational concept.** If EMP degrades or eliminates communications, mission accomplishment hinges on the ability of subordinate leaders to implement



the intent of their commander's operational concept until communications are reestablished.

**Keep subordinate commanders apprised of critical intelligence information.** The electronic systems used to gather, process, and disseminate information concerning hostile forces may be upset or damaged by EMP effects. Subordinate leaders will be able to respond to the loss of this information only if they have a clear picture of the most critical facets of the battlefield situation before the intelligence information was interrupted or lost.

**Make maximum use of the least vulnerable equipment:**

- If only some of the equipment in a unit has been hardened against EMP effects, commanders must place these items where they can have maximum impact (like contributing to the main effort).
- Maximum use also should be made of unhardened, but less vulnerable, equipment. For example, radios operating at frequencies of 100 megahertz and above tend to be less vulnerable to EMP than radios operating at lower frequencies.

**Provide for redundant, multiple mode communication links between positions.** It has always been sound tactical doctrine to provide for alternative modes of communication between positions, such as, backing up a radio link with wire or messengers. The need to reduce EMP effects on radios and other electronic equipment gives even greater priority to this requirement.

Preplanning and training in the use of backup and alternate communications nets are essential. Wherever and whenever consistent with the mission, establish two or more communications paths and have a contingency plan to reestablish communications. For example, SHF radios might be used as an alternative link because they are less vulnerable to EMP. Area microwave nets might be another option, as well as fiber optics systems, if available, since they couple very little (if any) EMP energy. Other alternatives include air, messengers, motor vehicles, and wire.

**Note:** If fiber optics are wrapped in metal, the metal can function as an antenna and the devices attached to fiber optics cables may be vulnerable. Also, fiber optics may be susceptible to damage from radiation.

Try to **maintain a stock of critical spare parts.** In some cases, EMP damage may affect only one part of a system, which, if replaced, will allow the device to function as before. Fuses are particularly important; therefore, troops need to know the locations of all fuses in their equipment and maintain and keep spares on hand.

**Emphasize crosstraining.** After equipment has been subjected to EMP, reconstitution and recovery will be maximized if personnel know what to look for and what to do to restore essential equipment.

**Prepare safety plans and practice safety drills.** In some mitigation postures, troops will be operating in closed equipment vans and other shelters. Under these

conditions, fires that may start after EMP damages relays and other electronic components could be a hazard. Troops need to practice the skills needed to extinguish electrical fires inside shelters and enclosures, and must have appropriate life-support and fire-fighting equipment at hand.

Remember that **EMP may not be the most significant effect.** While both types of EMP cause similar types of damage, it is useful to recall the basic differences between them:

- While surface-burst EMP is the most far-reaching of the effects produced by a near-surface-burst nuclear weapon, it may or may not be the most important effect for tactical unit operations. In some situations, depending on METT-T, emphasis may be given to blast and thermal effects.
- In case of a high-altitude nuclear detonation, the only effect of the weapon that can affect troops in the field is HEMP.

Recognize that **indications and warning** of enemy use of surface and air burst nuclear weapons **may not be present for HEMP threats.** Current doctrine highlights a number of indicators that may provide warning of enemy use of surface and air burst nuclear weapons. These include the withdrawal of hostile forces from contact, increased air reconnaissance, heightened activity on the part of enemy NBC units, and steps taken by hostile forces to increase their mission-oriented protective posture status. Such indicators, however, are unlikely to provide warning of a high altitude EMP threat.

## Collectors and Antennas

For EMP to damage electronic and electrical equipment, the EMP energy must establish contact with these devices. Army hardening programs protect equipment by establishing shields between the harmful EMP fields and critical components.

The form that damaging EMP energy takes depends on the type of antenna or other receiver that picks up the energy. Long lines tend to pick up electrical energy; loops tend to gather magnetic energy. Both can be extremely damaging, especially on sensitive computer memories.

Because they are not commonly regarded as collectors or antennas, unintended pickups may be overlooked. Potential unintended antennas include such objects as gun tubes, heating and ventilation ducts, water pipes, fuel pipelines, conduits, grounding rods and wires, commercial phone and power lines, missiles, guy wires, fences, railroad tracks, and power lines from generators, etc. Remember, if you wouldn't touch the object if it were standing upright in a lightning storm, assume it is an unintentional collector or antenna.

A number of EMP mitigation techniques that can be employed with these collectors or antennas follow:

- Identify all collectors or antennas in your area. Even a quick survey can reveal surprising vulnerabilities to EMP.

- Where possible, avoid contact of equipment with unintentional collectors or antennas:
  - Each physical contact is an opportunity for EMP to enter and damage tactical equipment. For example, signal and power equipment attached to commercial lines can pick up damaging surges of power.
  - While contact with unintentional antennas, such as civilian and military power lines, should be avoided, don't cause any unnecessary damage to these facilities. They may be of value for recovery and reconstitution.
- When possible, disconnect and collapse collectors or antennas. If the mission permits, shut down electronic equipment and disconnect all antennas. Simply turning the equipment off is not sufficient; damaging energy can still enter through the antennas.
- Where possible, avoid use of the most vulnerable antennas. The most vulnerable types of antennas include long wires or rods, wide angle doublets, and omnidirectional antennas. Less vulnerable antennas include—
  - Those with smaller radiating elements, such as small directional antennas, that pick up relatively less EMP energy.
  - Antennas designed to pickup frequencies above 100 megahertz.
- Extend antennas to the minimum amount possible. The amount of potentially damaging EMP energy that gets into a radio depends, in large part, on the length of the antenna.
- Avoid loops.
  - Avoid the creation of loops in wire and other antennas or collectors. Loops act as magnetic dipole antennas, allowing magnetic EMP energy to affect the systems connected to them. Exercise caution in using equipment with internal loops, which can also function as antennas.
  - Recognize different types of systems that might be linked in nonobvious loops. For example, a phone line may run from a van to a switchboard; the switchboard may be linked by wire to a command post; the command post may have a power line connection to a generator; and the same generator may have a power line to the van, thus resulting in an effective loop antenna or collector.
- Ensure antenna guy lines are properly insulated from the antenna. Some large antennas use guy lines as braces to provide stability, and these lines can function as antennas, coupling EMP. This energy will flow into the antenna (and through it into electronic equipment) unless the antenna or guy line connections are well insulated.

## Cables and Grounds

Normally, ground cables and rods provide protection from lightning. From the standpoint of EMP mitigation, however, grounds and other forms of cables are unintentional antennas. The following points must be considered for grounding and other forms of cables.

First, avoid loops that function as magnetic dipole antennas. Loops may not be obvious immediately; different types of equipment and connectors may be involved. Secondly, whenever possible, rely on short, straight cable runs. The length of a cable has a major impact on the amount of EMP energy that it picks up and transmits to equipment. For example, a 5-foot cable run might pick up an electrical current of 5 amps, which is enough to operationally upset some electronic equipment, but not enough to cause functional damage. A 1-mile cable run in the same EMP field could pick up as much as 50,000 amps. Try to use short straight cable runs with low impedance grounds; and if possible, cluster cable runs.

If cables are strung in the air, they can pickup more EMP energy. Shallow underground burial does not provide significant protection; and deep burial (10 feet or more) is not worth the construction effort.

Use balanced, shielded, twisted-pair cable in preference to coaxial; and use coaxial in preference to unshielded cable. Imagine three 250-foot cables in the same EMP environment. An unshielded cable could pick up as much as 100,000 volts. A coaxial cable could pick up only about 1/30th of this energy—roughly 2,000 to 3,000 volts. A balanced, shielded twisted-pair cable would do even better, only picking up about 500 to 1,000 volts.

If grounds are required for troop safety, provide them according to the specifications in technical manuals. Also use grounds that offer the best protection against EMP. If available, make use of insulating material, such as rubber mats, in communication vans, shelters, etc.

Whenever possible use common grounds. In multiple cabinet systems (communications vans), ground each cabinet within the shelter and have only one common ground reaching outside the vehicle to the earth. Employ grounding schemes that provide the best protection against EMP. Figure C-4 outlines the preferred grounding schemes for EMP mitigation—the single-point star or crow's foot ground and the "tree." The tree grounding scheme is likely to be the most practical for many configurations of equipment. Since loops are to be avoided, use the tree configuration whenever equipment needs to be linked by connectors that might couple EMP energy.

## Command, Control, Communications, and Intelligence

C<sup>3</sup>I equipment poses some of the most challenging tactical decisions for commanders developing EMP mitigation plans and procedures.

Dispersed operations, to include the use of remotes, increase survivability by reducing the unit's single-point signatures and increasing the number of targets an enemy must find and engage. At the same time, when operating in this mode, units depend more on electronic devices to maintain command and control through communications.

## FM 3-3-1

For example, long lines between positions that can function as unintended antennas, can increase the unit's vulnerability to EMP. Furthermore, if electronic communications are interrupted or destroyed by EMP, the unit may not be able to accomplish its missions.

There are realistic tactical trade-offs for which no pat answers can be offered. However, some guidelines can be applied to specific METT-T situations. Remember the following:

- Use redundant, multiple-mode communications. Units generally do not have extra radio equipment, but do have access to other modes of communication, such as field telephones, messengers, flares, and other signal devices, and aircraft and vehicles.
- Make maximum use of the least vulnerable equipment:
  - Most EMP energy occurs in the frequency range below 100 megahertz. While many tactical radios operate in this frequency range, some, like microwave systems, do not. Figure C-5 shows the correlation between megahertz and commonly used abbreviations for radio frequencies.
  - Microwave grids may be very effective alternative communications nets.
  - Broadband radios pose major problems in that EMP energy is broadband. Hence, broadband radios can couple more energy than narrow-band radios.
- Plan for the potential loss of communications equipment. Everyone in the unit should know the standing operating procedures to be adopted if, for any reason, one or more modes of communication are lost. Units should practice using backup and alternative systems.
- Consider disconnecting some communications equipment. This extreme measure may need to be considered; however, mission factors must be examined carefully before using this tactical option. If this mitigation technique is employed, the best procedure is to disconnect the radios from antennas and/or store them inside sealed vans, vehicles, or shelters.
- Other effects, in addition to EMP, may interfere with radio communication. A high-altitude nuclear detonation can affect the earth's ionosphere and thereby interfere with radios that use the ionosphere to move signals. By the same token, radios may be lost due to battle damage. These possibilities reinforce the need to develop and practice backup and alternate communications schemes. Take special steps to protect computers. These steps may include—
  - To the extent practical, operate and store computers in shielded shelters, vans, or vehicles. Consider placing extra calculators and other small devices in ammunition cans, and storing those cans in sheltered areas away from the sides and comers.
  - Computer tapes, discs, and drums tend to be relatively resistant to

EMP effects. Make regular backups of computer memories to ensure that essential data is not lost in case of EMP-induced operational upset or damage, and store them in a separate place, ideally an EMP-shielded van, shelter, or vehicle.

## Shelters and Shielding

Even if EMP fields are very powerful, damage to equipment can be limited or eliminated if devices are kept in shielded shelters that prevent the EMP energy from entering. The key principles to remember when dealing with shields and shelters are the requirements for a continuous shield made of metal.

Shields are continuous when they have no breaks or openings. Once the shielding metal is at least a few millimeters thick, having a continuous shield with no breaks is more important than adding more layers of shielding metal. However, most shields and shelters used by tactical forces will have openings (van doors, access panels in radio cases, etc.). If these apertures are left open, the integrity of the shield is compromised, and damaging EMP energy can enter to damage equipment.

EMP is composed of both electrical and magnetic energy, and any conducting metal can shield against

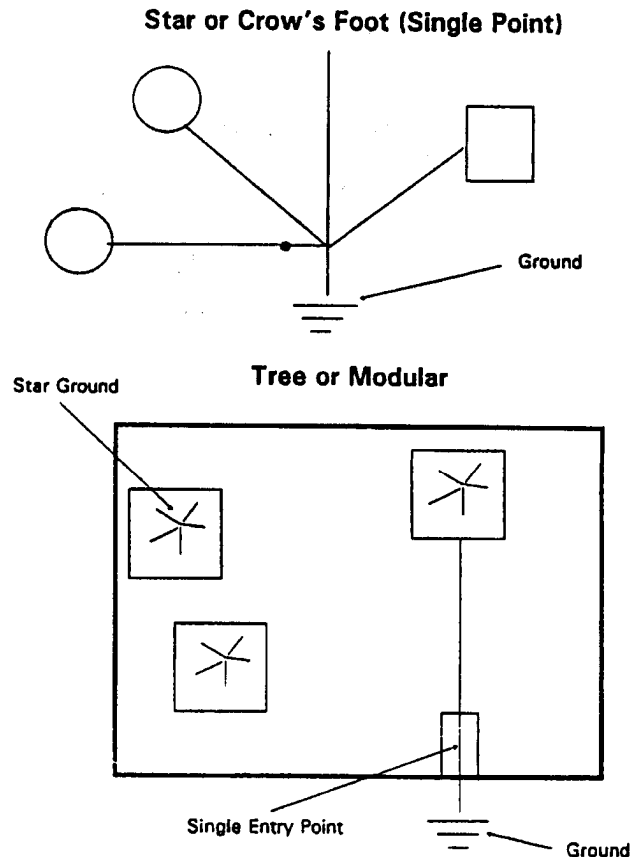

C-4. Good grounding schemes for EMP mitigation.

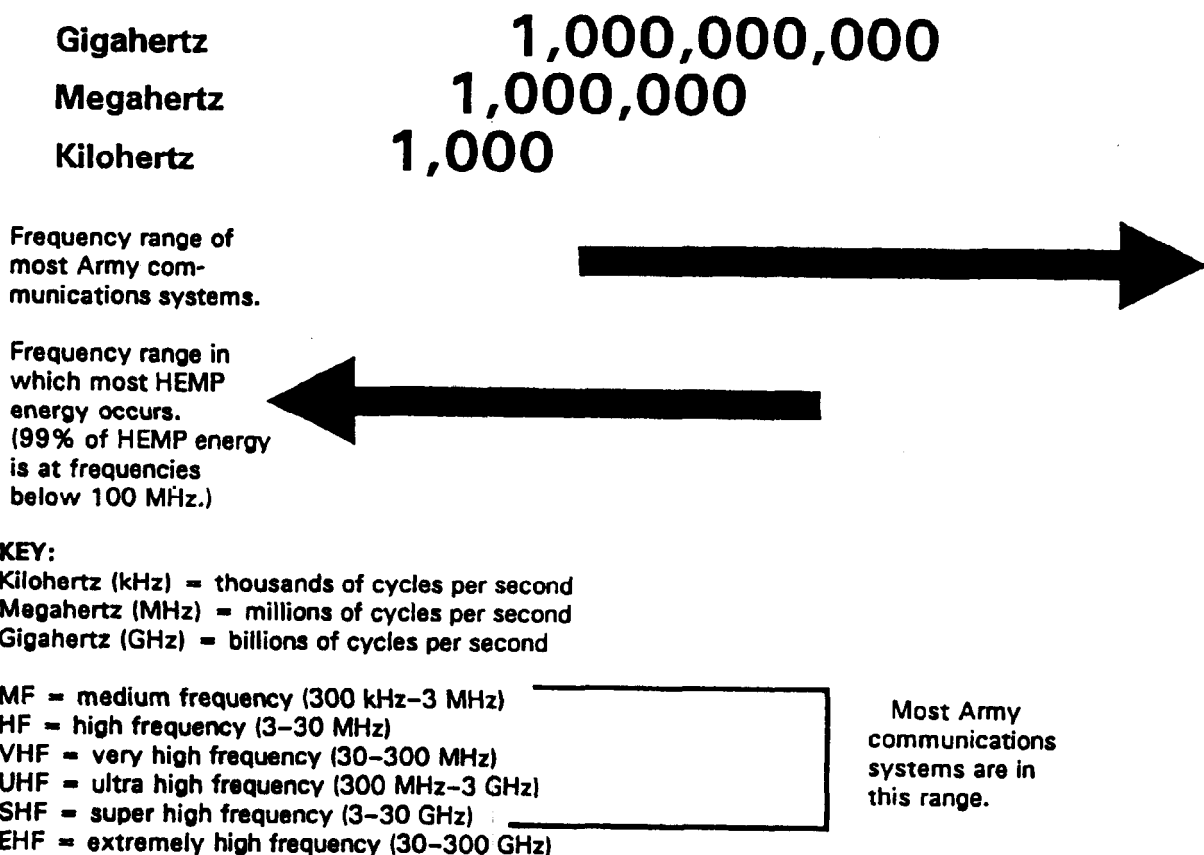

**Figure C-5. Radio and EMP frequencies.**

electrical effects. Iron and steel provide good protection against magnetic EMP energy. Other kinds of shielding are unlikely to be effective and/or practical for field use.

Shielded shelters can take many forms. A communications van or an armored fighting vehicle is what many people think of when shelters are discussed. However, an ammunition can (with the lid tightly closed) is an expedient shelter for small items such as calculators or backup computer diskettes, and the metal case of a radio can be an effective shelter if antennas have been removed and all access panels are closed.

It is possible to have cables, antennas, and other connectors attached to, or running into, a shielded shelter and still maintain the EMP protection. One should not have complete confidence unless these connections have been evaluated in an Army EMP shielding program.

Nevertheless, there are good layout procedures that can limit the possible damage from running (intended or unintended) antennas through shields into shelters. Proper procedures must be used when linking shelters to antennas and other connectors. These procedures include—

- If possible, group cables and other intended or unintended antennas.
- Place groups of cables in metal conduit.

- If the group of cables must enter the shelter, place them near the phone or power penetrations.
- Try to terminate cable shields, ground buses, and other connectors on the exterior of the shelter without a penetration.
- If possible, insulate penetrating lines just before entry into the shelter, for instance, air conditioning lines, water pipes, ventilation ducts. Exhaust pipes are penetrations that can serve as unintended antennas, and they should be insulated if possible.

As is true for all EMP mitigation procedures, commanders need to consider shielding and shelters in the context of their overall tactical situation. Employment of proper maintenance and operating procedures is of particular importance.

### Power Sources

Electronic equipment needs power. In some situations, power sources may be more vulnerable to EMP effects than the devices being driven. While generating equipment may be fairly resistant to EMP, devices within the generating equipment that control power generation can be vulnerable. Therefore, the following procedures can be used to lessen power source vulnerability. If EMP occurs, commercial power equipment and sources may be taken off

line. Therefore, plan to rely on military power-generating equipment. The long lines used in civilian power systems can pick up significant amounts of EMP energy, which can cause damage to military equipment connected to the civilian grid.

Automatic control systems and other components may be vulnerable to EMP effects. If consistent with the mission, the best posture is to have this equipment shut off and physically disconnected. Keep commercial power grids in mind as a potential source of energy after an initial attack.

Commercial power sources may be able to stay on line or come back up after EMP energy hits.

Use of commercial power sources after an attack requires an evaluation of trade-offs. On the one hand, this may be the most readily available alternative or backup source, particularly for combat support and combat service support units. On the other hand, the next EMP attack may damage critical connected equipment. Selective use may be the best option with some systems (but not all) interconnected on a mission-specific basis.

## Postattack Recovery and Continued Operations

For either HEMP or SBEMP, the first priorities of commanders should be to continue to engage in tactical operations and to carry out high-priority, mission-essential, recovery and reconstitution operations that integrate EMP mitigation with other tactical considerations.

Use standing operating procedures to establish and implement priorities. Postattack and transattack environments will be confusing. Hence, commanders need to establish recovery and reconstitution priorities prior to the attack, and exercise oversight to ensure these priorities are followed.

### Avoid the single-event fallacy.

There is no reason to presume that an attacker will stop after the initial use of nuclear weapons, particularly if high-altitude EMP is being used to create surprise. Indeed, hostile forces may plan to use a series of EMP attacks to disrupt and destroy US forces' combat capabilities. If a unit abandons its EMP mitigation posture as soon as it begins recovery and reconstitution operations, it will be highly vulnerable to a follow-on attack.

Unit standing operating procedures and plans must strike a balance between recovery and reestablishment of mission-essential capabilities and maintenance of mitigation postures against EMP and other nuclear weapon effects.

**Place a high priority on the reestablishment of command functions.** Since EMP predominantly affects electronic equipment, and since the maintenance of command is the prerequisite for effective operations, mitigation techniques that advance this objective should be given high priority.

**Start with a rapid assessment of damage.** In a unit that has been subjected to EMP effects, electronic equipment may be functionally damaged, operationally upset, or unaffected, depending on shielding, effectiveness of EMP mitigation posture, etc. Therefore, initial postattack operations should include a rapid assessment of the overall damage inflicted on predesignated high-priority equipment.

**Implement quick-fix repairs on critical equipment.** Even though electronic equipment has suffered functional damage from EMP, repairs may be straight-forward, such as, resetting circuit breakers or replacing fuses. Troops

should be taught the procedures needed to attempt quick fixes, and should have necessary tools and parts (such as fuses) on hand.

### Presume that upset has occurred to computers.

Mission-critical computer memories can suffer upset at levels of EMP that are far lower than the intensities required to inflict functional damage. At first glance, the results of upset may be invisible and may only be revealed when it becomes evident that critical information is incorrect or unavailable. It is a good practice to assume that memories have been upset and automatically reload backups.

After this has been done, create a duplicate and save it as the backup and return it to its EMP protected location to be used if additional attacks occur.

**Test all equipment.** Consistent with command priorities, all electronic equipment should be inspected for operational upset and/or functional damage. This includes items that have been shielded or hardened against EMP effects in Army shielding programs. In some cases, both upset and functional damage may not be immediately evident.

When inspecting equipment for damage, focus on the most obvious areas for problems. In assessing damage and attempting expedient recoveries, begin with the obvious fixes (fuses and circuit breakers) at the obvious places-points at which EMP energy may have entered the system via components near the antenna.

Army targeting doctrine does not call for the deliberate use of EMP effects to inflict damage on targets. Any damage that does result is a bonus. It is, however, highly consistent with AirLand Battle doctrine to exploit the possibilities for surprise that enemy use of EMP may present. An enemy employing EMP effects to disrupt mission-critical electronic equipment may be subject to tactical surprise if the commanders of US forces, who survived the attack with essential combat capabilities intact, seize and exploit the initiative. In addition, recognize that EMP can function as a valuable supplement to the nuclear attack warning and reporting system. In many tactical situations, EMP effects may be the first indication that nuclear weapons have been employed.

## Appendix E

# Nomograms and Tables

This appendix contains nomograms and tables for use in radiological calculations, a hairline for local reproduction, and a map scale for use in total dose calculations (crossing problems).

Tables beginning Table E-1 are set to tabular format. They are presented with their corresponding nomograms. To determine the radioactive cloud and stem parameters, find the appropriate yield in the left-hand column (Table E-1) and read the data across the table.

Stabilized cloud-top and cloud-bottom angle yield estimation is presented in Table E-2. Enter the table with the stabilized cloud-top or bottom angle in the left-hand column. Read across the top of the table with the flash-to-bang time or distance to ground zero. Where the two columns intersect is the estimated yield, some mathematical estimation may be required.

To determine the downwind distance of Zone I (zone of immediate concern) (Table E-4), find the appropriate yield in the left-hand column, and the effective wind speed

across the top. Where the two columns intersect is the downwind distance of Zone I.

For fallout decay (Table E-5), enter with the  $R_1$  value on the left side, and  $t$  in hours across the top. Where the two columns intersect is the  $R_t$  value. To determine the  $R_1$  value, find the  $R_t$  value in the  $t$  column and read across to the left to determine  $R_1$ . Some mathematical estimation of the data may be required.

To determine total dose (Table E-24), page E-50, enter the table for the appropriate decay rate with the  $T_e$  value in the left-hand column and the  $T_s$  value across the top.

Where the two columns intersect is the value for the index scale. Turn to Table E-43, page E-88, for the index table. Enter the index value across the top of the table and the  $R_1$  value down the left hand side. Where the two columns intersect is the total dose. If the index and  $R_1$  values are not present in the table either multiply the index value by  $R_1$  value for a product in total dose, or mathematically estimate the data in the table.

### MAP SCALES

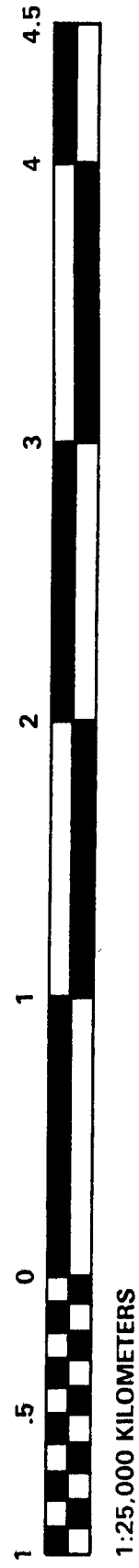
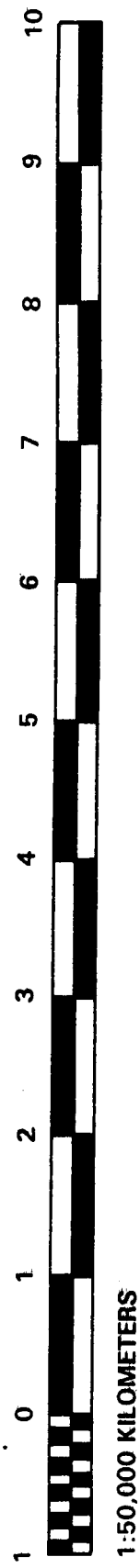
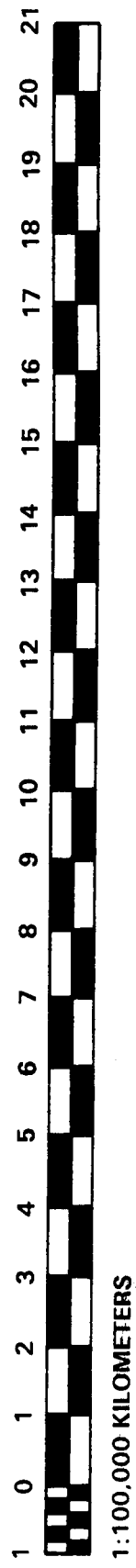
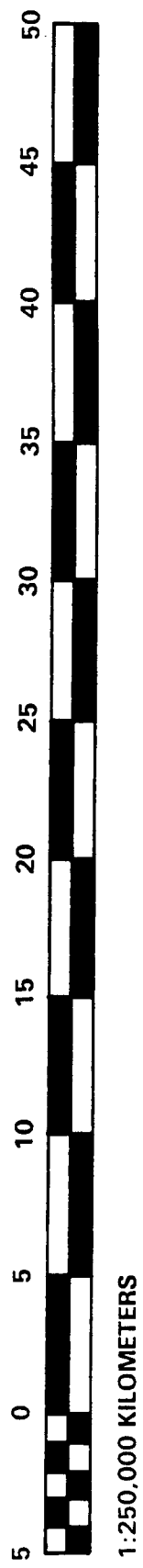
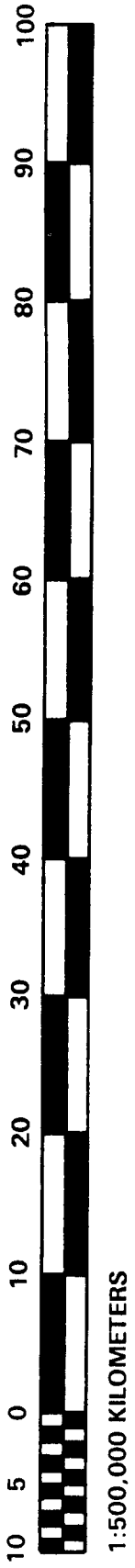
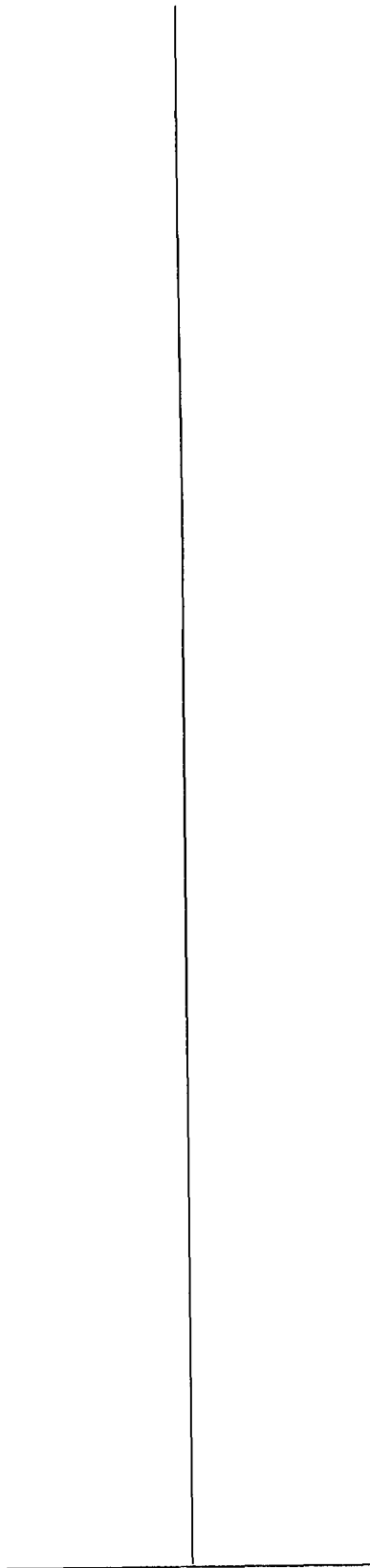

Figure E-1. Map scales



*Figure E-2. Hairline.*



**RADIOACTIVE CLOUD AND STEM PARAMETERS  
(STABILIZED AT H + 10 MINUTES)**

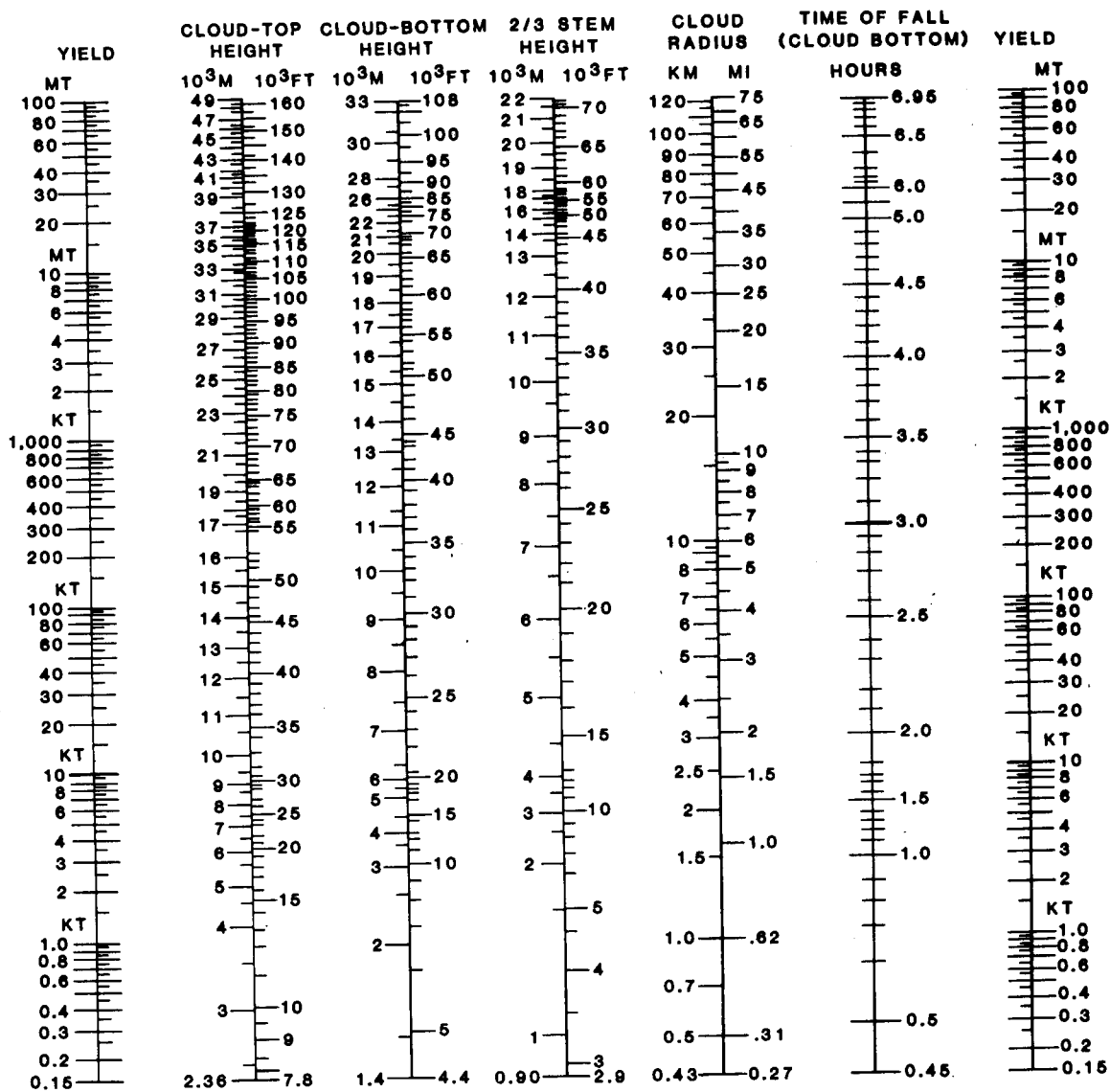

Figure E-3. Radioactive cloud and stem parameters nomogram (stabilized at H + 10 minutes).

Table E-1. Radioactive cloud and stem parameters (stabilized at H + 10 minutes).

YIELD (KT)	CLOUD-TOP HEIGHT		CLOUD-BOTTOM HEIGHT		2/3 STEM HEIGHT		CLOUD RADIUS		TIME OF FALL (CLOUD BOTTOM)  hours
	km	1000 ft	km	1000 ft	km	1000 ft	km	mi	
0.15	2.4	7.9	1.3	4.3	0.9	2.9	0.4	0.2	0.4
0.20	2.6	8.5	1.4	4.6	0.9	3.1	0.5	0.3	0.4
0.30	2.8	9.2	1.5	4.9	1	3.3	0.6	0.4	0.4
0.40	3	9.8	1.6	5.3	1.1	3.5	0.7	0.4	0.5
0.50	3.2	11	1.7	5.6	1.1	3.7	0.7	0.4	0.5
0.60	3.3	11	1.8	5.9	1.2	3.9	0.8	0.5	0.5
0.70	3.4	11	1.8	5.9	1.2	3.9	0.8	0.5	0.5
0.80	3.5	11	1.9	6.2	1.3	4.1	0.9	0.6	0.5
0.90	3.6	12	2	6.6	1.3	4.4	0.9	0.6	0.5
1	3.7	12	2	6.6	1.3	4.4	1	0.6	0.5
2	4.4	14	2.3	7.5	1.5	5	1.3	0.8	0.6
3	5.1	17	2.8	9.2	1.9	6.1	1.5	0.9	0.7
4	5.7	19	3.3	11	2.2	7.3	1.7	1.1	0.8
5	6.3	21	3.6	12	2.4	8	1.9	1.2	0.9
6	6.7	22	4	13	2.7	8.7	2.1	1.3	1
7	7.2	24	4.3	14	2.9	9.3	2.2	1.4	1
8	7.5	25	4.6	15	3.1	10	2.3	1.4	1.1
9	7.9	26	4.8	16	3.2	11	2.4	1.5	1.1
10	8.2	27	5.1	17	3.4	11	2.6	1.6	1.1
20	11	36	7.2	24	4.8	16	3.4	2.1	1.5
30	12	39	7.6	25	5.1	17	4	2.5	1.6
40	12	39	8	26	5.3	17	4.6	2.9	1.6
50	13	43	8.3	27	5.5	18	5	3.1	1.7
60	13	43	8.5	28	5.7	19	5.4	3.4	1.7
70	14	46	8.7	29	5.8	19	5.8	3.6	1.8
80	14	46	8.9	29	5.9	19	6.1	3.8	1.8
90	14	46	9.1	30	6.1	20	6.4	4	1.8
100	14	46	9.3	31	6.2	21	6.7	4.2	1.9
200	16	53	10	33	6.7	22	9	5.6	2
300	17	56	11	36	7.3	24	11	6.8	2.1
400	18	59	12	39	8	26	12	7.5	2.3
500	19	62	12	39	8	26	13	8.1	2.3
600	20	66	12	39	8	26	14	8.7	2.3
700	20	66	13	43	8.7	29	15	9.3	2.4
800	21	69	13	43	8.7	29	16	9.9	2.4
900	21	69	13	43	8.7	29	17	11	2.4
MT 1	22	72	13	43	8.7	29	18	11	2.4
2	24	79	15	49	10	33	24	15	2.7
3	26	85	16	53	11	35	28	17	2.9
4	28	92	17	56	11	37	32	20	2.9
5	29	95	17	56	11	37	35	22	2.9
6	30	98	18	59	12	39	37	23	3.1
7	31	102	18	59	12	39	40	25	3.1
8	31	102	19	62	13	41	42	26	3.3
9	32	105	19	62	13	41	44	27	3.3
10	33	108	19	62	13	41	46	29	3.3
20	37	121	21	69	14	46	62	39	3.6
30	40	131	23	75	15	50	74	46	3.8
40	42	138	24	79	16	53	83	52	4
50	43	141	25	82	17	55	91	57	4.1
60	45	148	26	85	17	57	99	62	4.1
70	46	151	26	85	17	57	105	65	4.1
80	47	154	27	89	18	59	111	69	4.3
90	48	158	27	89	18	59	117	73	4.3
100	49	161	28	92	19	61	122	76	4.5

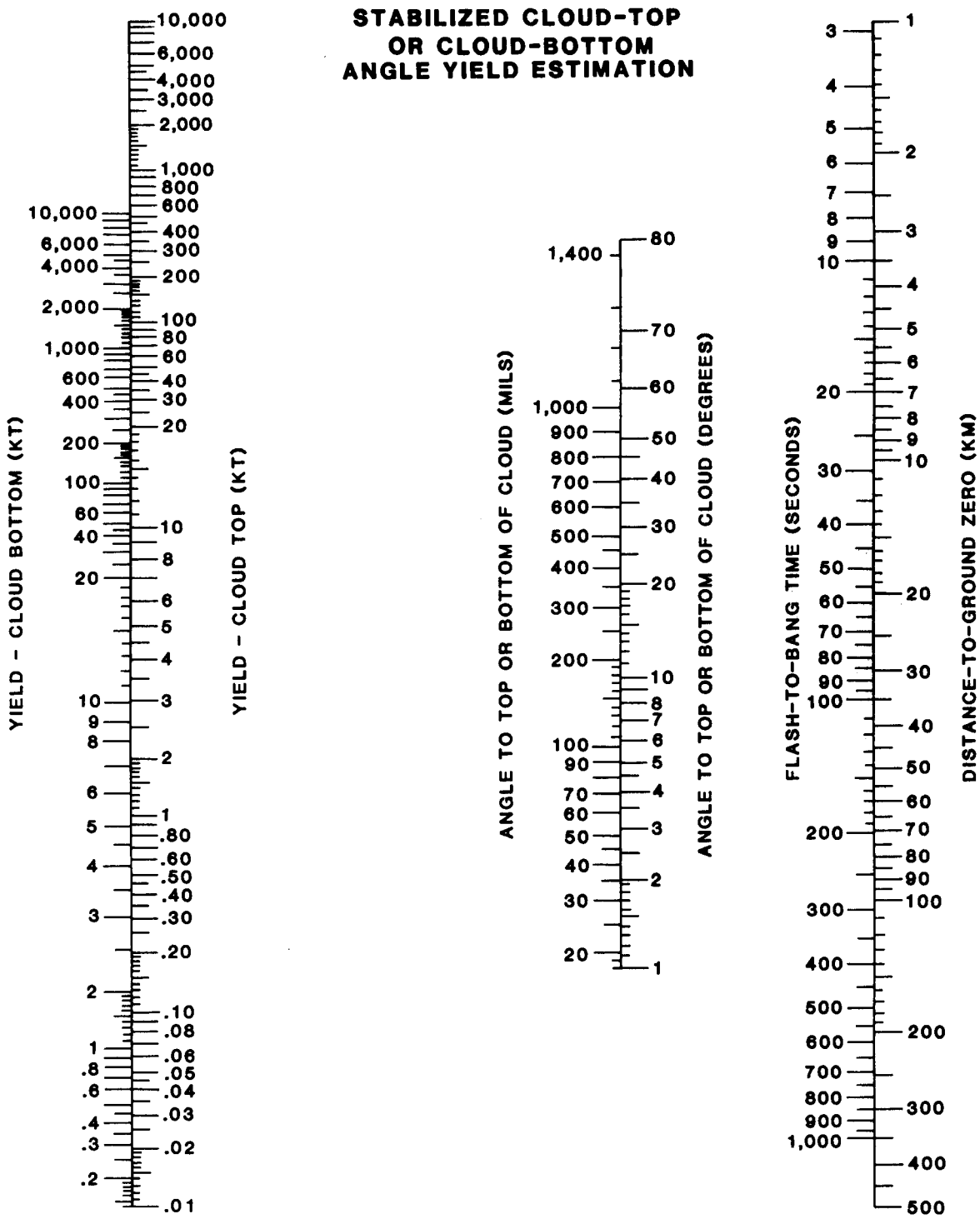

Figure E-4. Nomogram for yield estimation (distance between GZ and observer versus stabilized cloud-top angle or stabilized cloud-bottom angle).

Table E-2. Stabilized cloud-top angle yield estimation.

STABILIZED CLOUD TOP (MILS) (DEG)	FLASH TO BANG TIME (SECONDS)										DISTANCE TO GROUND ZERO (KMA)													
	10	12	14	16	18	20	30	40	50	60	70	80	90	100	120	140	150	160	170	180	190	200	250	300
3.5	4.2	4.9	5.6	6.3	7.0	10.5	14.0	17.5	21.0	24.5	28.0	31.5	35.0	42.0	48.0	52.5	56.0	59.5	63.0	66.5	70.0	87.5	105.0	
53	0	0	0	0	0	0	0	0	0	0	0	0	0.01	0.02	0.03	0.04	0.06	0.08	0.1	0.13	0.16	0.42	0.92	
71	0	0	0	0	0	0	0	0	0	0.01	0.02	0.03	0.04	0.1	0.16	0.28	0.35	0.45	0.56	0.74	0.92	2	4	
89	0	0	0	0	0	0	0	0.01	0.02	0.05	0.08	0.16	0.27	0.42	0.63	1.03	1.23	1.6	2	3	5	7		
107	0	0	0	0	0	0	0	0.02	0.05	0.1	0.2	0.36	0.66	0.94	2	3	4	4	5	6	7	13	22	
124	0	0	0	0	0	0	0.01	0.03	0.09	0.2	0.39	0.7	1.17	1.85	3	4	5	6	7	9	10	11	19	54
142	0	0	0	0	0	0	0.02	0.06	0.18	0.36	0.7	1.26	2	3	4	6	8	9	10	12	14	16	41	115
178	0	0	0	0	0	0	0.03	0.1	0.27	0.6	1.18	2	3	4	6	9	10	12	14	16	17	23	61	226
196	0	0	0	0	0	0.01	0.01	0.02	0.03	0.06	0.12	0.23	0.42	0.7	1.1	1.7	2.4	3.4	4.6	6.1	8.1	11	18	41
213	0	0	0	0	0	0.01	0.01	0.02	0.03	0.06	0.12	0.23	0.42	0.7	1.1	1.7	2.4	3.4	4.6	6.1	8.1	11	18	41
231	0	0	0	0	0	0.01	0.01	0.02	0.03	0.06	0.12	0.23	0.42	0.7	1.1	1.7	2.4	3.4	4.6	6.1	8.1	11	18	41
249	0	0	0	0	0	0.01	0.01	0.02	0.03	0.06	0.12	0.23	0.42	0.7	1.1	1.7	2.4	3.4	4.6	6.1	8.1	11	18	41
257	0	0	0	0	0	0.01	0.01	0.02	0.03	0.06	0.12	0.23	0.42	0.7	1.1	1.7	2.4	3.4	4.6	6.1	8.1	11	18	41
284	0	0	0	0	0	0.01	0.01	0.02	0.03	0.06	0.12	0.23	0.42	0.7	1.1	1.7	2.4	3.4	4.6	6.1	8.1	11	18	41
302	0	0	0	0	0	0.01	0.02	0.03	0.06	0.09	0.52	1.81	3	5	8	11	15	19	25	37	51	70	94	121
320	0	0	0	0	0	0.01	0.02	0.03	0.06	0.09	0.52	1.81	3	5	8	11	15	19	25	37	51	70	94	121
338	0	0	0	0	0	0.01	0.02	0.03	0.06	0.09	0.52	1.81	3	5	8	11	15	19	25	37	51	70	94	121
356	0	0	0	0	0	0.01	0.02	0.03	0.06	0.09	0.52	1.81	3	5	8	11	15	19	25	37	51	70	94	121
444	0	0	0	0	0	0.01	0.02	0.03	0.06	0.09	0.52	1.81	3	5	8	11	15	19	25	37	51	70	94	121
533	0	0	0	0	0	0.01	0.02	0.03	0.06	0.09	0.52	1.81	3	5	8	11	15	19	25	37	51	70	94	121
622	0	0	0	0	0	0.01	0.02	0.03	0.06	0.09	0.52	1.81	3	5	8	11	15	19	25	37	51	70	94	121
711	0	0	0	0	0	0.01	0.02	0.03	0.06	0.09	0.52	1.81	3	5	8	11	15	19	25	37	51	70	94	121
800	0	0	0	0	0	0.01	0.02	0.03	0.06	0.09	0.52	1.81	3	5	8	11	15	19	25	37	51	70	94	121
889	0	0	0	0	0	0.01	0.02	0.03	0.06	0.09	0.52	1.81	3	5	8	11	15	19	25	37	51	70	94	121
1067	0	0	0	0	0	0.01	0.02	0.03	0.06	0.09	0.52	1.81	3	5	8	11	15	19	25	37	51	70	94	121
1244	0	0	0	0	0	0.01	0.02	0.03	0.06	0.09	0.52	1.81	3	5	8	11	15	19	25	37	51	70	94	121
1422	0	0	0	0	0	0.01	0.02	0.03	0.06	0.09	0.52	1.81	3	5	8	11	15	19	25	37	51	70	94	121

NOTE: Numbers in () are yield in megatons (MT). An "\*" in the table means a yield over 100 MT.



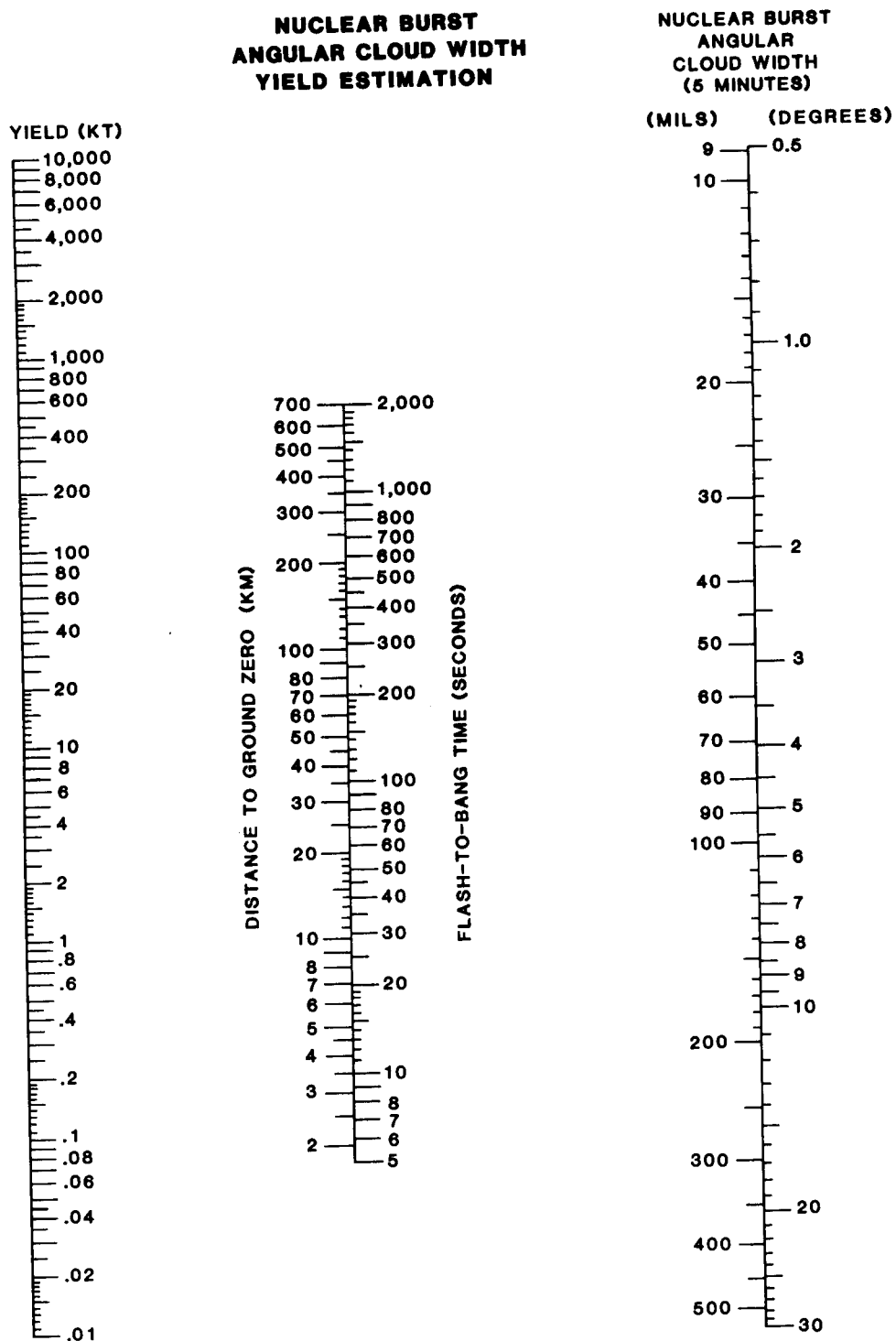

Figure E-5. Nomogram for determining yield estimation (nuclear burst angular cloud width at H + 5 minutes).

**DOWNWIND DISTANCE  
ZONE OF IMMEDIATE CONCERN**

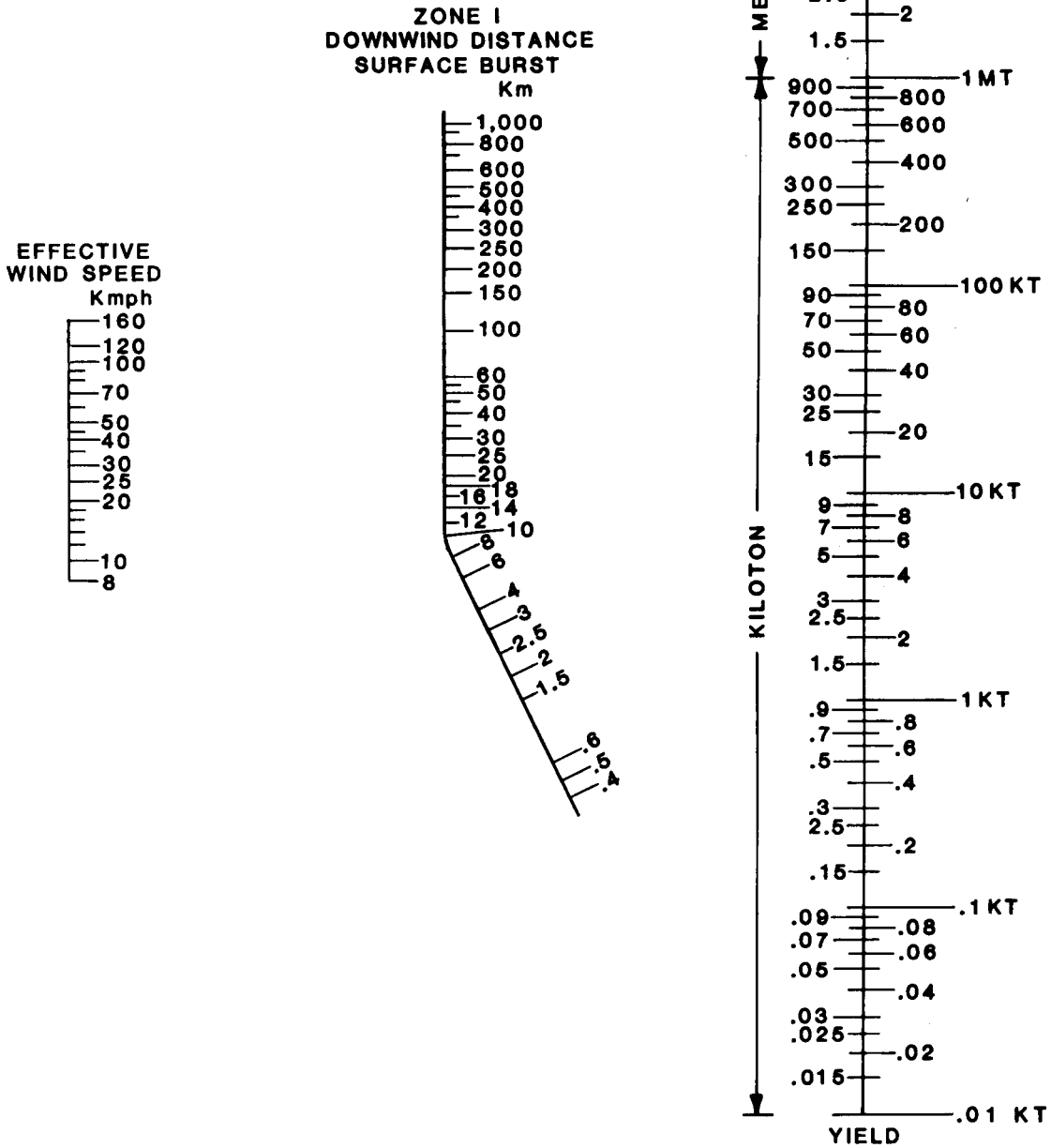

Figure E-6. Nomogram for determination of Zone I.

Table E-4. Downwind distance—zone of immediate concern.

YIELD (KT)	EFFECTIVE WIND SPEED (kmph)																			
	8	10	12	14	16	18	20	25	30	35	40	45	50	60	70	80	90	100	120	160
0.01	0.1	0.1	0.1	0.1	0.1	0.1	0.1	0.2	0.2	0.2	0.2	0.2	0.3	0.3	0.3	0.3	0.3	0.4	0.4	0.5
0.02	0.1	0.2	0.2	0.2	0.2	0.2	0.2	0.3	0.3	0.3	0.4	0.4	0.4	0.5	0.5	0.5	0.6	0.6	0.7	0.8
0.03	0.2	0.2	0.2	0.3	0.3	0.3	0.3	0.4	0.4	0.5	0.5	0.6	0.6	0.7	0.7	0.8	0.9	1	1.1	1.2
0.04	0.2	0.3	0.3	0.3	0.4	0.4	0.4	0.5	0.5	0.6	0.6	0.7	0.7	0.8	0.9	1	1.1	1.2	1.3	1.4
0.05	0.3	0.3	0.3	0.4	0.4	0.4	0.5	0.5	0.6	0.7	0.7	0.8	0.8	0.9	1	1.1	1.2	1.3	1.4	1.7
0.06	0.3	0.4	0.4	0.4	0.5	0.5	0.5	0.6	0.7	0.8	0.8	0.9	0.9	1.1	1.2	1.3	1.3	1.4	1.6	1.9
0.07	0.4	0.4	0.5	0.5	0.5	0.6	0.6	0.7	0.8	0.9	0.9	1	1.1	1.2	1.3	1.4	1.5	1.6	1.8	2.1
0.08	0.4	0.4	0.5	0.5	0.6	0.6	0.7	0.8	0.9	1	1	1.1	1.2	1.3	1.4	1.6	1.7	1.8	2	2.4
0.09	0.4	0.5	0.5	0.6	0.6	0.7	0.7	0.8	0.9	1	1.1	1.2	1.3	1.4	1.6	1.7	1.8	2	2.2	2.6
0.1	0.5	0.5	0.6	0.6	0.7	0.8	0.8	0.9	1	1.1	1.2	1.3	1.4	1.6	1.7	1.8	2	2.1	2.4	2.8
0.2	0.8	0.9	1	1.1	1.2	1.3	1.4	1.6	1.7	1.9	2.1	2.2	2.4	2.6	2.9	3.1	3.4	3.6	4	4.7
0.3	1.1	1.2	1.4	1.5	1.6	1.7	1.8	2.1	2.4	2.6	2.8	3	3.2	3.6	3.9	4.2	4.6	4.9	5.4	6.4
0.4	1.3	1.5	1.7	1.9	2	2.2	2.3	2.6	2.9	3.2	3.5	3.7	4	4.4	4.9	5.3	5.7	6	6.7	10
0.5	1.6	1.8	2	2.2	2.4	2.6	2.7	3.1	3.5	3.8	4.1	4.4	4.7	5.3	5.8	6.3	6.7	9	9	11
0.6	1.8	2.1	2.3	2.5	2.7	2.9	3.1	3.6	4	4.4	4.7	5.1	5.4	6	6.6	8	9	9	10	12
0.7	2	2.3	2.6	2.8	3.1	3.3	3.5	4	4.5	4.9	5.3	5.7	6.1	6.8	8	9	10	10	11	13
0.8	2.2	2.6	2.9	3.1	3.4	3.6	3.9	4.4	5	5.4	5.9	6.3	6.7	8	9	10	10	11	12	14
0.9	2.4	2.8	3.1	3.4	3.7	4	4.2	4.9	5.4	5.9	6.4	6.9	8	9	10	10	11	11	12	14
1	2.6	3	3.4	3.7	4	4.3	4.6	5.3	5.9	6.4	7	8	8	9	10	11	11	12	13	15
2	4.5	5.1	5.7	6.3	6.8	7	7	8	9	10	10	11	12	13	14	15	16	17	18	21
3	6.1	7	7	7	8	8	9	10	11	12	13	13	14	16	17	18	19	20	22	26
4	6	7	8	9	9	10	10	11	13	14	15	15	16	18	19	21	22	23	25	29
5	7	8	9	10	11	11	11	13	14	15	16	17	18	20	21	23	24	26	28	32
6	8	9	10	10	11	12	12	14	15	16	18	19	20	22	23	25	26	28	31	35
7	8	9	10	11	12	13	13	15	16	18	19	20	21	23	25	27	28	30	33	38
8	9	10	11	12	13	13	14	16	17	19	20	21	23	25	27	29	30	32	35	41
9	9	11	12	13	13	14	15	17	18	20	21	23	24	26	28	30	32	34	37	43
10	10	11	12	13	14	15	16	18	19	21	22	24	25	27	30	32	34	36	39	45
20	14	15	17	18	20	21	22	24	27	29	31	33	35	38	41	44	47	49	54	63
30	17	19	20	22	24	25	26	30	33	35	38	40	42	46	50	53	57	60	66	76
40	19	21	23	25	27	29	30	34	37	40	43	46	48	53	57	61	65	69	75	87
50	21	24	26	28	30	32	34	38	41	45	48	51	54	59	64	69	74	76	83	97
60	23	26	28	31	33	35	37	41	45	49	52	55	58	64	69	74	79	83	91	105
70	25	28	31	33	35	37	40	44	49	52	56	60	63	69	75	80	85	89	98	113
80	26	30	33	35	38	40	42	47	52	56	60	63	67	73	79	85	90	95	104	121
90	28	31	34	37	40	42	45	50	55	59	63	67	71	78	84	90	95	101	110	128
100	29	33	36	39	42	44	47	52	57	62	66	71	74	82	88	94	100	106	116	134
200	41	46	50	54	58	62	65	73	80	86	92	98	103	113	122	131	139	147	161	186
300	49	55	61	66	70	75	79	88	97	104	112	119	125	137	148	159	168	178	195	225
400	57	63	70	75	81	85	90	101	111	120	128	136	143	157	170	182	193	204	223	258
500	63	71	77	84	90	95	100	112	123	133	142	151	159	175	189	202	214	226	248	287
600	69	77	84	91	98	104	109	122	134	145	155	165	174	190	206	220	234	247	270	313
700	74	83	91	98	105	111	117	132	144	156	167	177	187	205	221	237	251	265	291	336
800	79	88	97	104	112	119	125	140	154	166	178	189	199	218	236	252	268	283	310	358
900	83	93	102	110	118	125	132	148	162	176	188	199	210	231	249	267	283	299	328	379
MT 1	87	98	107	116	124	132	139	156	171	185	198	210	221	242	262	280	298	314	344	398
1.5	106	119	130	141	150	160	168	189	207	224	239	254	268	294	318	340	361	380	417	483
2	121	136	149	161	172	183	193	216	237	256	274	291	307	337	364	389	413	436	478	553
2.5	135	151	166	179	192	203	215	240	263	285	305	323	341	374	404	433	459	484	531	614
3	147	165	181	195	209	222	234	262	287	310	332	352	372	408	441	472	501	528	579	670
4	169	189	207	224	239	254	268	300	329	356	381	404	426	467	505	540	574	605	663	767
5	187	210	230	249	266	282	298	333	366	395	423	449	473	519	561	601	637	672	737	853
6	204	229	251	271	290	308	325	363	399	431	461	489	516	566	612	655	695	733	804	930
7	220	246	270	291	312	331	349	391	429	463	496	526	555	609	658	704	747	788	864	1000
8	234	262	287	310	332	353	372	416	457	494	528	561	591	648	701	750	796	840	921	1065
9	247	277	304	328	351	373	393	440	483	522	558	593	625	686	741	793	842	888	974	1126
10	260	291	319	345	369	392	413	463	507	549	587	623	657	721	779	834	885	933	1023	1184

Distances are in kilometers.



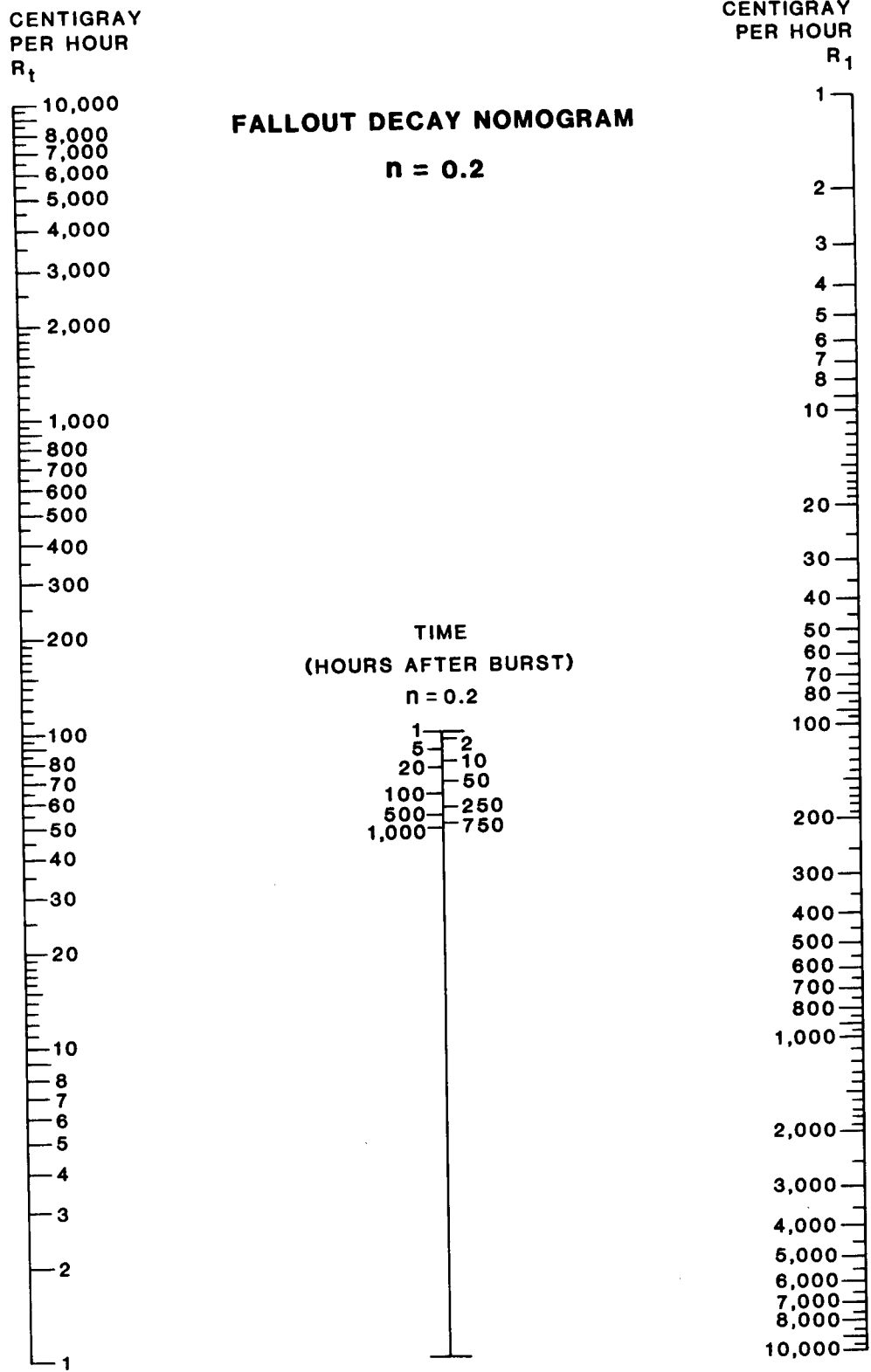

Figure E-7. Fallout decay nomogram  $n = 0.2$ .

Table E-5. Fallout decay table  $n = 0.2$ .

Centigray per hour (R1)	TIME (HOURS AFTER BURST)																	
	2	5	12	24	36	48	72	100	200	300	400	500	600	700	800	900	1000	1500
1	1	1	1	1	0	0	0	0	0	0	0	0	0	0	0	0	0	0
2	2	1	1	1	1	1	1	1	1	1	1	1	1	1	1	1	1	0
3	3	2	2	2	1	1	1	1	1	1	1	1	1	1	1	1	1	1
4	3	3	2	2	2	2	2	2	1	1	1	1	1	1	1	1	1	1
5	4	4	3	3	2	2	2	2	2	2	2	2	2	2	2	2	2	1
6	5	4	4	3	3	3	3	2	2	2	2	2	2	2	2	2	2	2
7	6	5	4	4	3	3	3	3	2	2	2	2	2	2	2	2	2	2
8	7	6	5	4	4	4	3	3	3	3	2	2	2	2	2	2	2	2
9	8	7	5	5	4	4	4	4	3	3	3	3	3	2	2	2	2	2
10	9	7	6	5	5	5	4	4	3	3	3	3	3	3	3	3	3	2
15	13	11	9	8	7	7	6	6	5	5	5	4	4	4	4	4	4	3
20	17	14	12	11	10	9	9	8	7	6	6	6	5	5	5	5	5	5
25	22	18	15	13	12	12	11	10	9	8	8	7	7	7	7	6	6	6
30	26	22	18	16	15	14	13	12	10	10	9	9	8	8	8	8	8	7
35	30	25	21	19	17	16	15	14	12	11	11	10	10	9	9	9	9	8
40	35	29	24	21	20	18	17	16	14	13	12	12	11	11	11	10	10	9
45	39	33	27	24	22	21	19	18	16	14	14	13	13	12	12	12	11	10
50	44	36	30	26	24	23	21	20	17	16	15	14	14	13	13	13	13	12
60	52	43	37	32	29	28	26	24	21	19	18	17	17	16	16	15	15	14
70	61	51	43	37	34	32	30	28	24	22	21	20	19	19	18	18	18	16
80	70	58	49	42	39	37	34	32	28	26	24	23	22	22	21	21	20	19
90	78	65	55	48	44	41	38	36	31	29	27	26	25	24	24	23	23	21
100	87	72	61	53	49	46	43	40	35	32	30	29	28	27	26	26	25	23
150	131	109	91	79	73	69	64	60	52	48	45	43	42	40	39	38	38	35
200	174	145	122	106	98	92	85	80	69	64	60	58	56	54	53	51	50	46
250	218	181	152	132	122	115	106	100	87	80	75	72	70	67	66	64	63	58
300	261	217	183	159	147	138	128	119	104	96	91	87	83	81	79	77	75	69
350	306	254	213	185	171	161	149	139	121	112	106	101	97	94	92	90	88	81
400	348	290	243	212	195	184	170	159	139	128	121	115	111	108	105	103	100	93
450	392	326	274	238	220	207	191	179	156	144	136	130	125	121	118	115	113	104
500	435	362	304	265	244	231	213	199	173	160	151	144	139	135	131	128	126	116
550	479	399	335	291	269	254	234	219	191	176	166	159	153	148	144	141	138	127
600	522	435	365	318	293	277	255	239	208	192	181	173	167	162	158	154	151	139
650	566	471	395	344	317	300	276	259	225	208	196	188	181	175	171	167	163	151
700	609	507	426	371	342	323	298	279	243	224	211	202	195	189	184	180	176	162
750	653	544	456	397	366	348	319	299	260	240	226	216	209	202	197	192	188	174
800	696	580	487	424	391	369	340	318	277	256	241	231	223	216	210	205	201	185
850	740	616	517	450	415	392	361	338	295	272	256	245	236	229	223	218	214	197
900	783	652	548	477	440	415	383	358	312	288	272	260	250	243	236	231	226	208
950	827	689	578	503	464	438	404	378	329	304	287	274	264	256	250	244	239	220
1000	871	725	608	530	488	461	425	398	347	320	302	289	278	270	263	257	251	232
1100	958	797	669	583	537	507	468	438	381	352	332	317	306	297	289	282	276	255
1200	1045	870	730	636	586	553	510	478	416	383	362	346	334	324	315	308	301	278
1300	1132	942	791	688	635	599	553	518	451	415	392	375	362	351	341	333	327	301
1400	1219	1015	852	741	684	645	595	557	485	447	422	404	389	378	368	359	352	324
1500	1306	1087	913	794	733	692	638	597	520	479	453	433	417	405	394	385	377	347
1600	1393	1160	973	847	781	738	680	637	555	511	483	462	445	432	420	410	402	371
1700	1480	1232	1034	900	830	784	723	677	589	543	513	491	473	459	447	436	427	394
1800	1567	1305	1095	953	879	830	765	717	624	575	543	519	501	486	473	462	452	417
1900	1654	1377	1156	1006	928	876	808	756	658	607	573	548	529	513	499	487	477	440
2000	1741	1450	1217	1059	977	922	850	796	693	639	603	577	556	540	525	513	502	463
2500	2176	1812	1521	1324	1221	1153	1063	995	866	799	754	721	696	674	657	641	628	579
3000	2612	2174	1825	1589	1465	1383	1275	1194	1040	959	905	866	835	809	788	770	754	695
3500	3047	2537	2129	1854	1709	1614	1488	1393	1213	1119	1056	1010	974	944	919	898	879	811
4000	3482	2899	2433	2118	1953	1844	1701	1592	1386	1278	1207	1154	1113	1079	1051	1026	1005	926
4500	3917	3262	2738	2383	2198	2075	1913	1791	1560	1438	1358	1298	1252	1214	1182	1154	1130	1042
5000	4353	3624	3042	2648	2442	2305	2126	1991	1733	1598	1509	1443	1391	1349	1313	1283	1256	1158

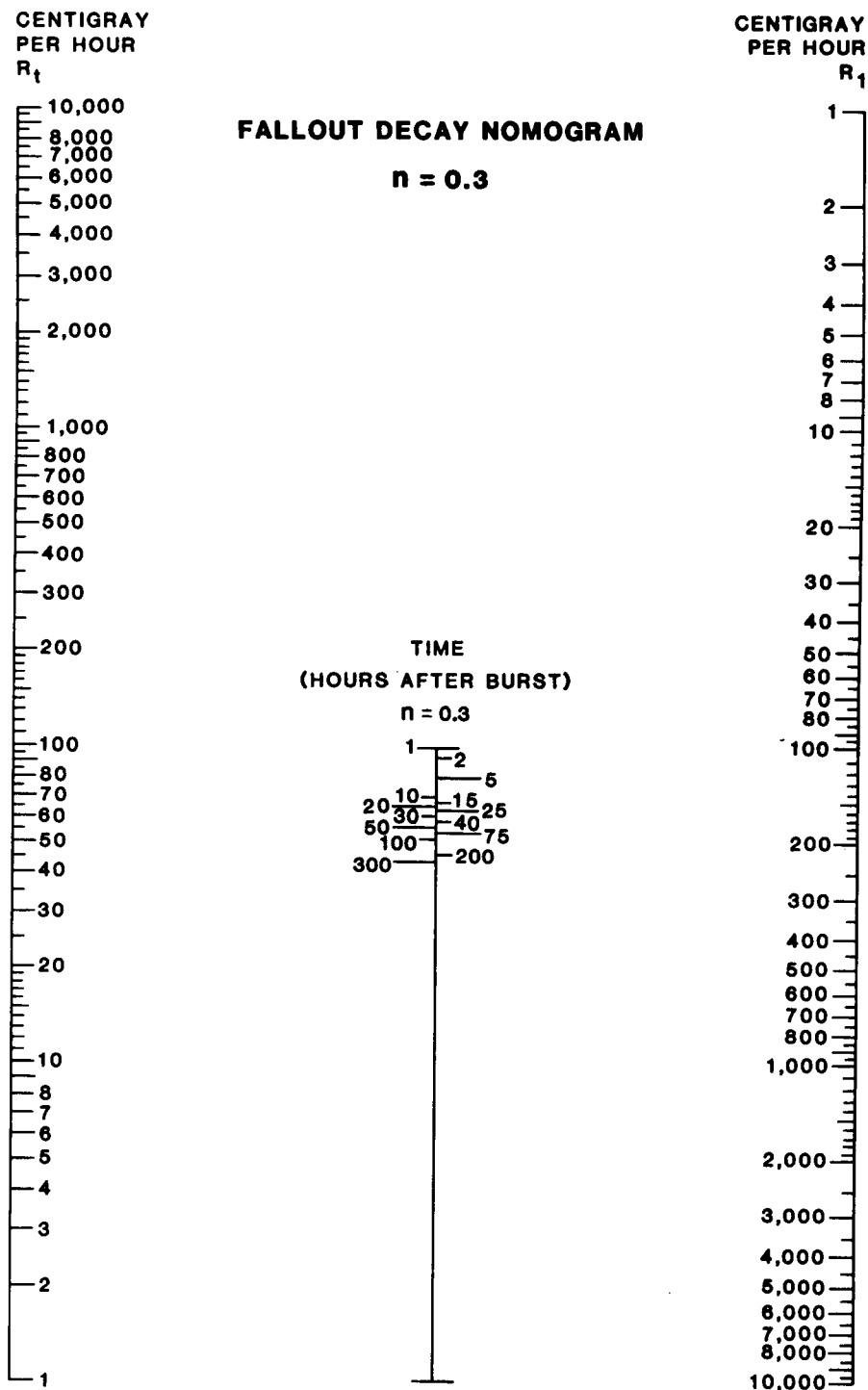

Figure E-8. Fallout decay nomogram  $n = 0.3$ .

Table E-6. Fallout decay table  $n = 0.3$ .

Centigray per hour (R1)	TIME (HOURS AFTER BURST)																	
	2	5	12	24	36	48	72	100	200	300	400	500	600	700	800	900	1000	1500
1	1	1	0	0	0	0	0	0	0	0	0	0	0	0	0	0	0	0
2	2	1	1	1	1	1	1	1	0	0	0	0	0	0	0	0	0	0
3	2	2	1	1	1	1	1	1	1	1	1	1	0	0	0	0	0	0
4	3	2	2	2	1	1	1	1	1	1	1	1	1	1	1	1	1	0
5	4	3	2	2	2	2	1	1	1	1	1	1	1	1	1	1	1	1
6	5	4	3	2	2	2	2	2	1	1	1	1	1	1	1	1	1	1
7	6	4	3	3	2	2	2	2	1	1	1	1	1	1	1	1	1	1
8	6	5	4	3	3	3	2	2	2	1	1	1	1	1	1	1	1	1
9	7	6	4	3	3	3	2	2	2	2	1	1	1	1	1	1	1	1
10	8	6	5	4	3	3	3	3	2	2	2	2	1	1	1	1	1	1
15	12	9	7	6	5	5	4	4	3	3	2	2	2	2	2	2	2	2
20	16	12	9	8	7	6	6	5	4	4	3	3	3	3	3	3	3	2
25	20	15	12	10	9	8	7	6	5	5	4	4	4	4	3	3	3	3
30	24	19	14	12	10	9	8	8	6	5	5	5	4	4	4	4	4	3
35	28	22	17	13	12	11	10	9	7	6	6	5	5	5	5	5	4	4
40	32	25	19	15	14	13	11	10	8	7	7	6	6	6	5	5	5	4
45	37	28	21	17	15	14	12	11	9	8	7	7	7	6	6	6	6	5
50	41	31	24	19	17	16	14	13	10	9	8	8	7	7	7	6	6	6
60	49	37	28	23	20	19	17	15	12	11	10	9	9	8	8	8	8	7
70	57	43	33	27	24	22	19	18	14	13	12	11	10	10	9	9	9	8
80	65	49	38	31	27	25	22	20	16	14	13	12	12	11	11	10	10	9
90	73	56	43	35	31	28	25	23	18	16	15	14	13	13	12	12	11	10
100	81	62	47	39	34	31	28	25	20	18	17	15	15	14	13	13	13	11
150	122	93	71	58	51	47	42	38	31	27	25	23	22	21	20	19	19	17
200	182	123	95	77	66	63	55	50	41	36	33	31	29	28	27	26	25	22
250	203	154	119	96	85	78	69	63	51	45	41	39	37	35	34	32	31	28
300	244	185	142	116	102	94	83	75	61	54	50	46	44	42	40	39	38	33
350	284	216	166	135	119	110	97	88	71	63	58	54	51	49	47	45	44	39
400	325	247	190	154	137	125	111	100	82	72	66	62	59	56	54	52	50	45
450	366	278	214	173	154	141	125	113	92	81	75	70	66	63	61	58	57	50
500	406	309	237	193	171	157	139	126	102	90	83	77	73	70	67	65	63	56
550	447	339	261	212	188	172	152	138	112	99	91	85	81	77	74	71	69	61
600	487	370	285	231	205	188	166	151	122	108	99	93	88	84	81	78	76	67
650	528	401	308	251	222	203	180	163	133	117	108	101	95	91	87	84	82	72
700	569	432	332	270	239	219	194	176	143	126	116	108	103	98	94	91	88	78
750	609	463	356	289	256	235	208	188	153	135	124	116	110	105	101	97	94	84
800	650	494	380	308	273	250	222	201	163	145	133	124	117	112	108	104	101	89
850	690	524	403	328	290	266	236	214	173	154	141	132	125	119	114	110	107	95
900	731	555	427	347	307	282	249	226	184	163	149	139	132	126	121	117	113	100
950	772	586	451	366	324	297	263	239	194	172	157	147	139	133	128	123	120	106
1000	812	617	475	385	341	313	277	251	204	181	166	155	147	140	135	130	126	111
1100	893	679	522	424	375	344	305	276	224	199	182	170	161	154	148	143	138	123
1200	975	740	569	463	410	376	333	301	245	217	199	186	176	168	162	156	151	134
1300	1056	802	617	501	444	407	360	327	265	235	215	201	191	182	175	169	164	145
1400	1137	864	664	540	478	438	388	352	286	253	232	217	205	196	188	182	176	156
1500	1218	926	712	578	512	470	416	377	306	271	249	232	220	210	202	195	189	167
1600	1300	987	759	617	546	501	444	402	326	289	265	248	235	224	215	208	201	178
1700	1381	1049	807	655	580	532	471	427	347	307	282	263	249	238	229	221	214	190
1800	1462	1111	854	694	614	564	499	452	367	325	298	279	264	252	242	234	227	201
1900	1543	1172	902	732	648	595	527	477	388	343	315	294	279	266	256	247	239	212
2000	1625	1234	949	771	683	626	554	502	408	361	331	310	293	280	269	260	252	223
2500	2031	1543	1186	964	853	783	693	628	510	452	414	387	367	350	337	325	315	279
3000	2437	1851	1424	1156	1024	939	832	754	612	542	497	465	440	420	404	390	378	334
3500	2843	2160	1661	1349	1194	1096	970	879	714	632	580	542	514	490	471	455	441	390
4000	3249	2468	1898	1542	1365	1252	1109	1005	816	723	663	620	587	560	538	520	504	446
4500	3655	2777	2135	1734	1536	1409	1247	1130	918	813	746	697	660	630	606	585	567	502
5000	4061	3085	2373	1927	1706	1565	1386	1256	1020	903	829	775	734	701	673	650	629	557

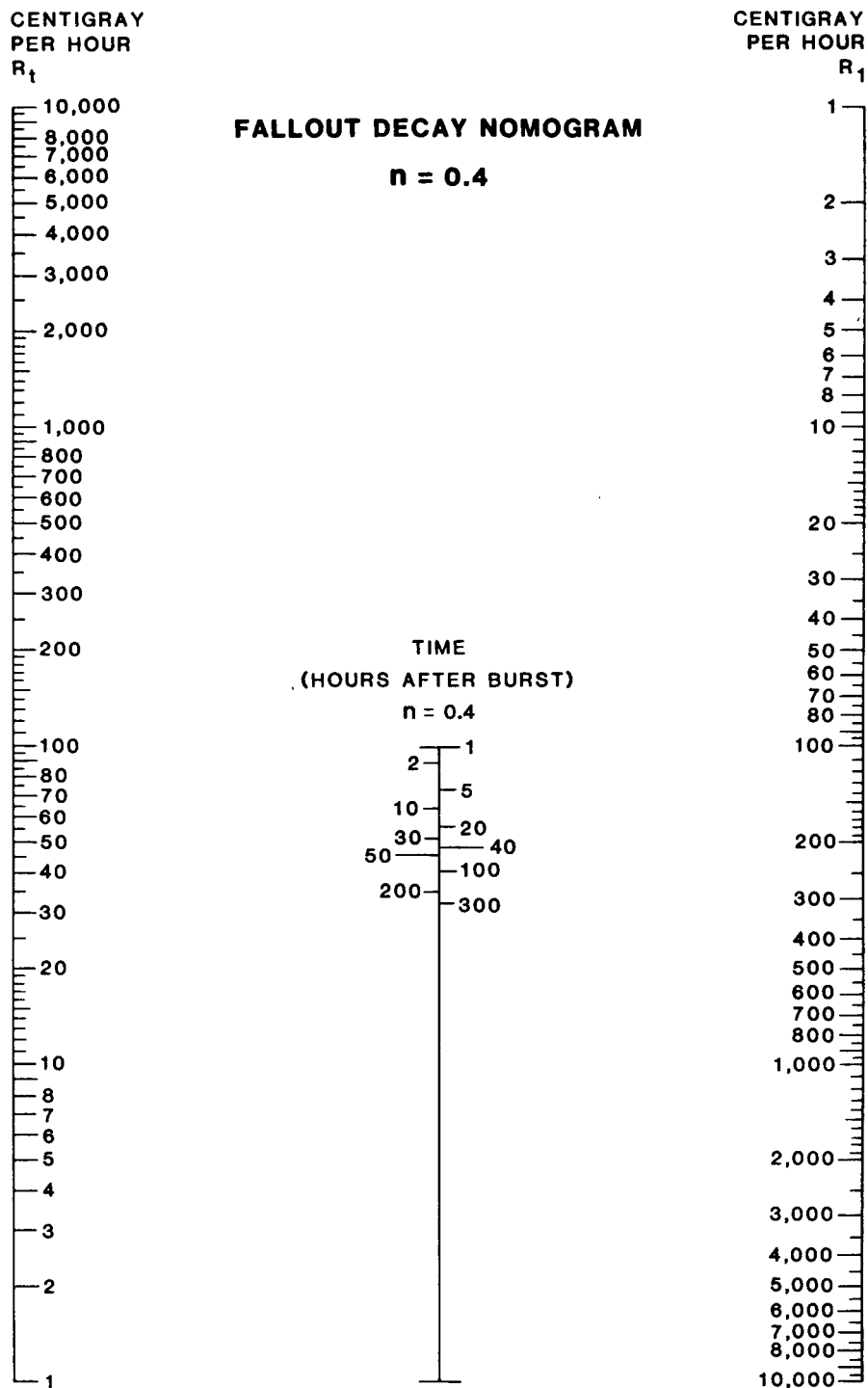

Figure E-9. Fallout decay nomogram  $n = 0.4$ .

Table E-7. Fallout decay table  $n = 0.4$ .

Centigray per hour (R1)	TIME (HOURS AFTER BURST)																	
	2	5	12	24	36	48	72	100	200	300	400	500	600	700	800	900	1000	1500
1	1	1	0	0	0	0	0	0	0	0	0	0	0	0	0	0	0	0
2	2	1	1	1	0	0	0	0	0	0	0	0	0	0	0	0	0	0
3	2	2	1	1	1	1	1	0	0	0	0	0	0	0	0	0	0	0
4	3	2	1	1	1	1	1	1	0	0	0	0	0	0	0	0	0	0
5	4	3	2	1	1	1	1	1	1	1	0	0	0	0	0	0	0	0
6	5	3	2	2	1	1	1	1	1	1	1	0	0	0	0	0	0	0
7	5	4	3	2	2	1	1	1	1	1	1	1	1	1	0	0	0	0
8	6	4	3	2	2	2	1	1	1	1	1	1	1	1	1	1	1	0
9	7	5	3	3	2	2	2	1	1	1	1	1	1	1	1	1	1	0
10	8	5	4	3	2	2	2	2	1	1	1	1	1	1	1	1	1	1
15	11	8	6	4	4	3	3	2	2	2	1	1	1	1	1	1	1	1
20	15	11	7	6	5	4	4	3	2	2	2	2	2	1	1	1	1	1
25	19	13	9	7	6	5	5	4	3	3	2	2	2	2	2	2	2	1
30	23	16	11	8	7	6	5	5	4	3	3	2	2	2	2	2	2	2
35	27	18	13	10	8	7	6	6	4	4	3	3	3	3	2	2	2	2
40	30	21	15	11	10	9	7	6	5	4	4	3	3	3	3	3	3	2
45	34	24	17	13	11	10	8	7	5	5	4	4	3	3	3	3	3	2
50	38	26	19	14	12	11	9	8	6	5	5	4	4	4	3	3	3	3
60	45	32	22	17	14	13	11	10	7	6	5	5	5	4	4	4	4	3
70	53	37	26	20	17	15	13	11	8	7	6	6	5	5	5	5	4	4
80	61	42	30	22	19	17	14	13	10	8	7	7	6	6	6	5	5	4
90	68	47	33	25	21	19	16	14	11	9	8	7	7	7	6	6	6	5
100	76	53	37	28	24	21	18	16	12	10	9	8	8	7	7	7	6	5
150	114	79	56	42	36	32	27	24	18	15	14	12	12	11	10	10	9	8
200	152	105	74	56	48	43	36	32	24	20	18	17	15	15	14	13	13	11
250	189	131	93	70	60	53	45	40	30	26	23	21	19	18	17	16	16	13
300	227	158	111	84	72	64	54	48	36	31	27	25	23	22	21	20	19	16
350	265	184	130	98	83	74	63	55	42	36	32	29	27	25	24	23	22	19
400	303	210	148	112	95	85	72	63	48	41	36	33	31	29	28	26	25	21
450	341	236	167	126	107	96	81	71	54	46	41	37	35	33	31	30	28	24
500	379	263	185	140	119	106	90	79	60	51	46	42	39	36	34	33	32	27
550	417	289	204	154	131	117	99	87	66	56	50	46	43	40	38	36	35	30
600	455	315	222	168	143	128	108	95	72	61	55	50	46	44	41	39	38	32
650	493	341	241	182	155	138	117	103	78	66	59	54	50	47	45	43	41	35
700	531	368	259	196	167	149	127	111	84	71	64	58	54	51	48	46	44	38
750	568	394	278	210	179	159	136	119	90	77	68	62	58	55	52	49	47	40
800	606	420	296	224	191	170	145	127	96	82	73	67	62	58	55	53	50	43
850	644	447	315	238	203	181	154	135	102	87	77	71	66	62	59	56	54	46
900	682	473	333	252	215	191	163	143	108	92	82	75	70	65	62	59	57	48
950	720	499	352	266	227	202	172	151	114	97	86	79	74	69	66	63	60	51
1000	758	525	370	280	238	213	181	158	120	102	91	83	77	73	69	66	63	54
1100	834	578	407	309	262	234	199	174	132	112	100	92	85	80	76	72	69	59
1200	909	630	444	337	286	255	217	190	144	123	109	100	93	87	83	79	76	64
1300	985	683	481	365	310	276	235	206	156	133	118	108	101	95	90	86	82	70
1400	1061	735	518	393	334	298	253	222	168	143	127	117	108	102	97	92	88	75
1500	1137	788	555	421	358	319	271	238	180	153	137	125	116	109	103	99	95	80
1600	1213	840	592	449	382	340	289	254	192	163	146	133	124	116	110	105	101	86
1700	1288	893	629	477	405	361	307	269	204	174	155	142	132	124	117	112	107	91
1800	1364	946	666	505	429	383	325	285	216	184	164	150	139	131	124	118	114	97
1900	1440	998	703	533	453	404	343	301	228	194	173	158	147	138	131	125	120	102
2000	1516	1051	740	561	477	425	361	317	240	204	182	167	155	146	138	132	126	107
2500	1895	1313	925	701	596	531	452	396	300	255	228	208	193	182	172	165	158	134
3000	2274	1576	1110	841	715	638	542	475	360	306	273	250	232	218	207	197	189	161
3500	2653	1839	1295	982	835	744	633	555	420	357	319	291	271	255	241	230	221	188
4000	3031	2101	1480	1122	954	850	723	634	480	409	364	333	310	291	276	263	252	215
4500	3410	2364	1665	1262	1073	957	813	713	541	460	410	375	348	327	310	296	284	241
5000	3789	2627	1851	1402	1192	1063	904	792	601	511	455	416	387	364	345	329	315	268

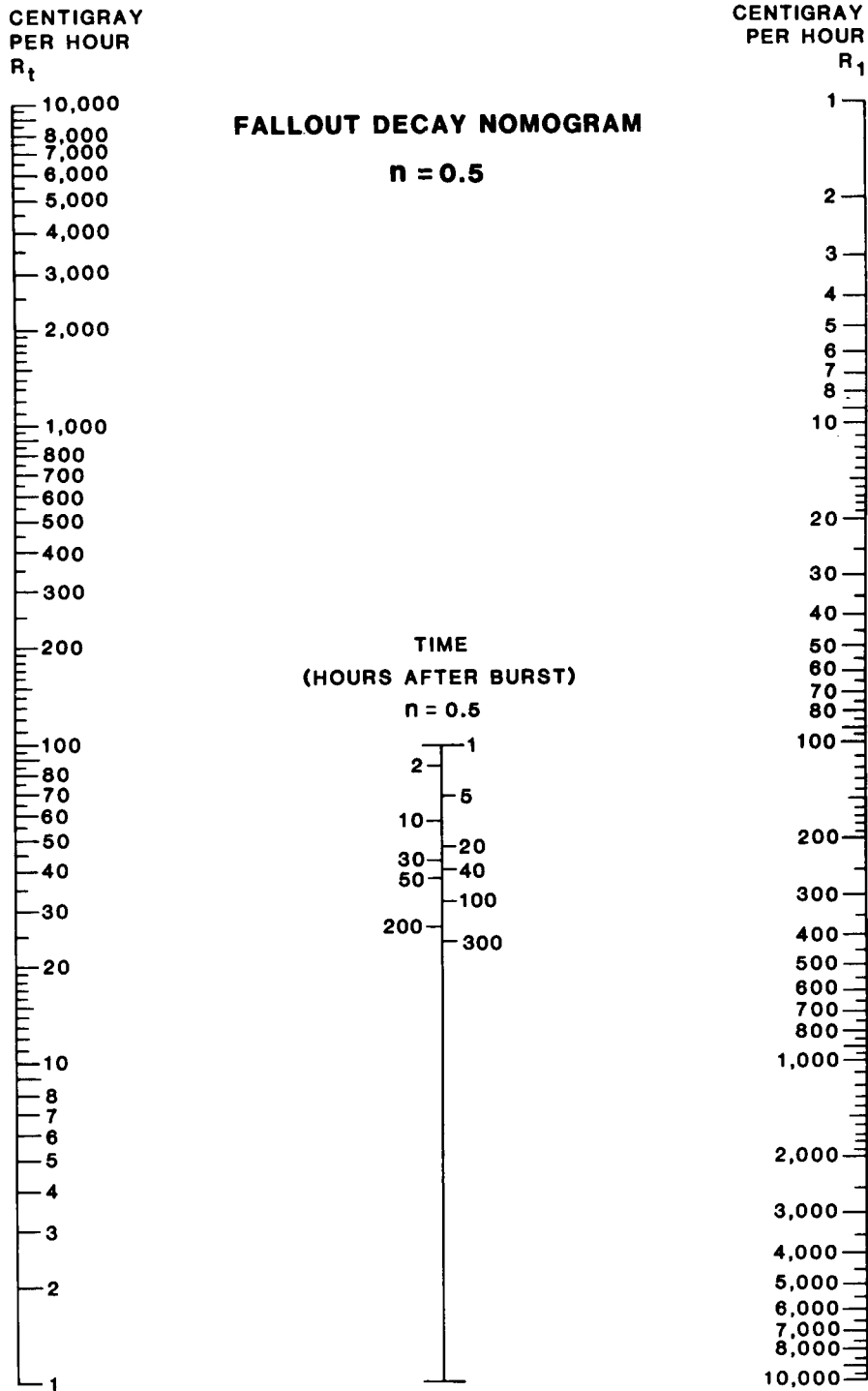

Figure E-10. Fallout decay nomogram  $n = 0.5$ .

Table E-8. Fallout decay table  $n = 0.5$ .

Centigray per hour (R1)	TIME (HOURS AFTER BURST)																	
	2	5	12	24	36	48	72	100	200	300	400	500	600	700	800	900	1000	1500
1	1	0	0	0	0	0	0	0	0	0	0	0	0	0	0	0	0	0
2	1	1	1	0	0	0	0	0	0	0	0	0	0	0	0	0	0	0
3	2	1	1	1	1	0	0	0	0	0	0	0	0	0	0	0	0	0
4	3	2	1	1	1	1	0	0	0	0	0	0	0	0	0	0	0	0
5	4	2	1	1	1	1	1	0	0	0	0	0	0	0	0	0	0	0
6	4	3	2	1	1	1	1	1	0	0	0	0	0	0	0	0	0	0
7	5	3	2	1	1	1	1	1	0	0	0	0	0	0	0	0	0	0
8	6	4	2	2	1	1	1	1	1	0	0	0	0	0	0	0	0	0
9	6	4	3	2	2	1	1	1	1	1	0	0	0	0	0	0	0	0
10	7	4	3	2	2	1	1	1	1	1	1	0	0	0	0	0	0	0
15	11	7	4	3	3	2	2	1	1	1	1	1	1	1	1	0	0	0
20	14	9	6	4	3	3	2	2	1	1	1	1	1	1	1	1	1	1
25	18	11	7	5	4	4	3	2	2	1	1	1	1	1	1	1	1	1
30	21	13	9	6	5	4	4	3	2	2	2	1	1	1	1	1	1	1
35	25	16	10	7	6	5	4	3	2	2	2	2	1	1	1	1	1	1
40	28	18	12	8	7	6	5	4	3	2	2	2	2	1	1	1	1	1
45	32	20	13	9	8	6	5	4	3	3	2	2	2	2	2	1	1	1
50	35	22	14	10	8	7	6	5	4	3	3	2	2	2	2	2	2	1
60	42	27	17	12	10	9	7	6	4	3	3	3	2	2	2	2	2	2
70	49	31	20	14	12	10	8	7	5	4	4	3	3	3	3	3	3	2
80	57	36	23	16	13	12	9	8	6	5	4	4	3	3	3	3	3	2
90	64	40	26	18	15	13	11	9	6	5	5	4	4	3	3	3	3	2
100	71	45	29	20	17	14	12	10	7	6	5	4	4	4	4	3	3	3
150	106	67	43	31	25	22	18	15	11	9	8	7	6	6	5	5	5	4
200	141	89	58	41	33	29	24	20	14	12	10	9	8	8	7	7	6	5
250	177	112	72	51	42	36	29	25	18	14	13	11	10	9	9	8	8	6
300	212	134	87	61	50	43	35	30	21	17	15	13	12	11	11	10	9	8
350	247	157	101	71	58	51	41	35	25	20	18	16	14	13	12	12	11	9
400	283	179	115	82	67	58	47	40	28	23	20	18	16	15	14	13	13	10
450	318	201	130	92	75	65	53	45	32	26	23	20	18	17	16	15	14	12
500	354	224	144	102	83	72	59	50	35	29	25	22	20	19	18	17	16	13
550	389	246	159	112	92	79	65	55	39	32	28	25	22	21	19	18	17	14
600	424	268	173	122	100	87	71	60	42	35	30	27	24	23	21	20	19	15
650	460	291	188	133	108	94	77	65	46	38	33	29	27	25	23	22	21	17
700	495	313	202	143	117	101	82	70	49	40	35	31	29	26	25	23	22	18
750	530	335	217	153	125	108	88	75	53	43	38	34	31	28	27	25	24	19
800	566	358	231	163	133	115	94	80	57	46	40	36	33	30	28	27	25	21
850	601	380	245	174	142	123	100	85	60	49	43	38	35	32	30	28	27	22
900	636	402	260	184	150	130	106	90	64	52	45	40	37	34	32	30	28	23
950	672	425	274	194	158	137	112	95	67	55	48	42	39	36	34	32	30	25
1000	707	447	289	204	167	144	118	100	71	58	50	45	41	38	35	33	32	26
1100	778	492	318	225	183	159	130	110	78	64	55	49	45	42	39	37	35	28
1200	849	537	346	245	200	173	141	120	85	69	60	54	49	45	42	40	38	31
1300	919	581	375	265	217	188	153	130	92	75	65	58	53	49	46	43	41	34
1400	990	626	404	286	233	202	165	140	99	81	70	63	57	53	49	47	44	36
1500	1061	671	433	306	250	217	177	150	106	87	75	67	61	57	53	50	47	39
1600	1131	716	462	327	267	231	189	160	113	92	80	72	65	60	57	53	51	41
1700	1202	760	491	347	283	245	200	170	120	98	85	76	69	64	60	57	54	44
1800	1273	805	520	367	300	260	212	180	127	104	90	80	73	68	64	60	57	46
1900	1344	850	548	388	317	274	224	190	134	110	95	85	78	72	67	63	60	49
2000	1414	894	577	408	333	289	236	200	141	115	100	89	82	76	71	67	63	52
2500	1768	1118	722	510	417	361	295	250	177	144	125	112	102	94	88	83	79	65
3000	2121	1342	866	612	500	433	354	300	212	173	150	134	122	113	106	100	95	77
3500	2475	1565	1010	714	583	505	412	350	247	202	175	157	143	132	124	117	111	90
4000	2828	1789	1155	816	667	577	471	400	283	231	200	179	163	151	141	133	126	103
4500	3182	2012	1299	919	750	650	530	450	318	260	225	201	184	170	159	150	142	116
5000	3536	2236	1443	1021	833	722	589	500	354	289	250	224	204	189	177	167	158	129



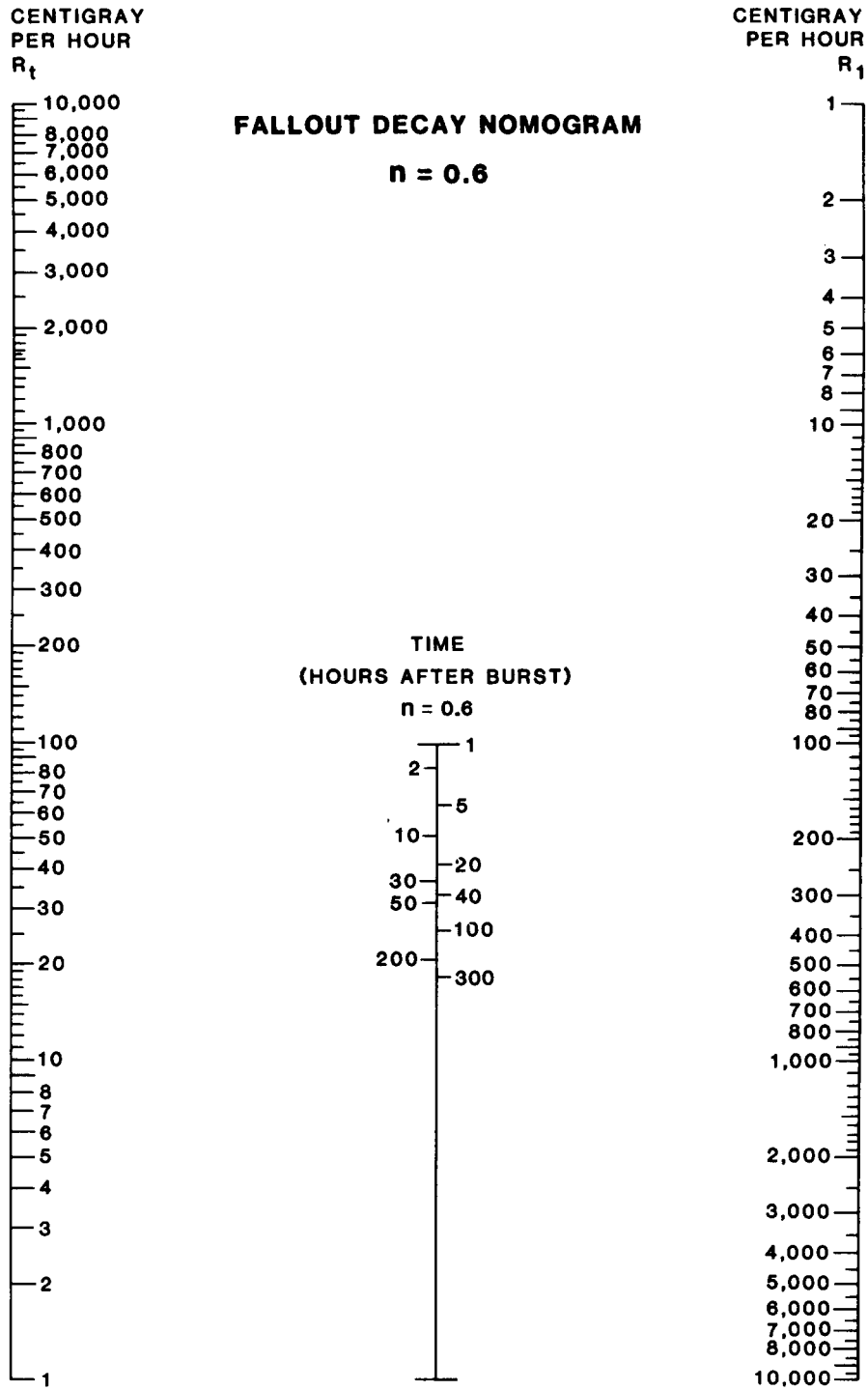

Figure E-11. Fallout decay nomogram  $n = 0.6$ .

Table E-9. Fallout decay table  $n = 0.6$ .

Centigray per hour (R1)	TIME (HOURS AFTER BURST)																	
	2	5	12	24	36	48	60	72	84	96	150	200	250	300	350	400	500	600
1	1	0	0	0	0	0	0	0	0	0	0	0	0	0	0	0	0	0
2	1	1	0	0	0	0	0	0	0	0	0	0	0	0	0	0	0	0
3	2	1	1	0	0	0	0	0	0	0	0	0	0	0	0	0	0	0
4	3	2	1	1	0	0	0	0	0	0	0	0	0	0	0	0	0	0
5	3	2	1	1	1	0	0	0	0	0	0	0	0	0	0	0	0	0
6	4	2	1	1	1	1	1	0	0	0	0	0	0	0	0	0	0	0
7	5	3	2	1	1	1	1	1	0	0	0	0	0	0	0	0	0	0
8	5	3	2	1	1	1	1	1	1	1	0	0	0	0	0	0	0	0
9	6	3	2	1	1	1	1	1	1	1	1	0	0	0	0	0	0	0
10	7	4	2	1	1	1	1	1	1	1	1	0	0	0	0	0	0	0
15	10	6	3	2	2	1	1	1	1	1	1	1	1	0	0	0	0	0
20	13	8	5	3	2	2	2	2	2	1	1	1	1	1	1	1	0	0
25	16	10	6	4	3	2	2	2	2	2	1	1	1	1	1	1	1	1
30	20	11	7	4	3	3	3	3	2	2	2	1	1	1	1	1	1	1
35	23	13	8	5	4	3	3	3	2	2	2	1	1	1	1	1	1	1
40	26	15	9	6	5	4	3	3	3	3	2	2	1	1	1	1	1	1
45	30	17	10	7	5	4	4	3	3	3	2	2	2	1	1	1	1	1
50	33	19	11	7	6	5	4	4	4	3	2	2	2	2	1	1	1	1
60	40	23	14	9	7	6	5	5	4	4	3	2	2	2	2	2	1	1
70	46	27	16	10	8	7	6	5	5	5	3	3	3	2	2	2	2	2
80	53	30	18	12	9	8	7	6	6	5	4	3	3	3	2	2	2	2
90	59	34	20	13	10	9	8	7	6	6	4	4	3	3	3	2	2	2
100	66	38	23	15	12	10	9	8	7	6	5	4	4	3	3	3	2	2
150	99	57	34	22	17	15	13	12	11	10	7	6	5	5	4	4	4	3
200	132	76	45	30	23	20	17	15	14	13	10	8	7	7	6	5	5	4
250	165	96	56	37	29	25	21	19	18	16	12	10	9	8	7	7	6	5
300	198	114	68	45	35	29	26	23	21	19	15	12	11	10	9	8	7	6
350	231	133	79	52	41	34	30	27	25	23	17	15	13	11	10	10	8	8
400	264	152	90	59	47	39	34	31	28	26	20	17	15	13	12	11	10	9
450	297	171	101	67	52	44	39	35	32	29	22	19	16	15	13	12	11	10
500	330	190	113	74	58	49	43	38	35	32	25	21	18	16	15	14	12	11
550	363	209	124	82	64	54	47	42	39	36	27	23	20	18	16	15	13	12
600	396	228	135	89	70	59	51	46	42	39	30	25	22	20	18	16	14	13
650	429	247	146	97	76	64	56	50	46	42	32	27	24	21	19	18	16	14
700	462	267	158	104	82	69	60	54	49	45	35	29	25	23	21	19	17	15
750	495	286	169	111	87	74	64	58	53	48	37	31	27	24	22	21	18	16
800	528	305	180	119	93	78	69	61	56	52	40	33	29	26	24	22	19	17
850	561	324	191	126	99	83	73	65	60	55	42	35	31	28	25	23	20	18
900	594	343	203	134	105	88	77	69	63	58	45	37	33	29	27	25	22	19
950	627	362	214	141	111	93	81	73	67	61	47	40	35	31	28	26	23	20
1000	660	381	225	149	116	98	86	77	70	65	49	42	36	33	30	27	24	22
1100	726	419	248	163	128	108	94	85	77	71	54	46	40	36	33	30	26	24
1200	792	457	270	178	140	118	103	92	84	78	59	50	44	39	36	33	29	26
1300	858	495	293	193	151	127	111	100	91	84	64	54	47	42	39	36	31	28
1400	924	533	315	208	163	137	120	108	98	91	69	58	51	46	42	38	34	30
1500	990	571	338	223	175	147	129	115	105	97	74	62	55	49	45	41	36	32
1600	1056	609	360	238	186	157	137	123	112	103	79	67	58	52	48	44	38	34
1700	1122	647	383	253	198	167	146	131	119	110	84	71	62	55	51	47	41	37
1800	1188	685	405	267	210	176	154	138	126	116	89	75	66	59	54	49	43	39
1900	1254	723	428	282	221	186	163	146	133	123	94	79	69	62	57	52	46	41
2000	1320	761	450	297	233	196	171	154	140	129	99	83	73	65	60	55	48	43
2500	1649	952	563	371	291	245	214	192	175	162	124	104	91	82	74	69	60	54
3000	1979	1142	675	446	349	294	257	231	210	194	148	125	109	98	89	82	72	65
3500	2309	1333	788	520	408	343	300	269	245	226	173	146	127	114	104	96	84	75
4000	2639	1523	901	594	466	392	343	307	280	259	198	167	146	131	119	110	96	86
4500	2969	1713	1013	668	524	441	386	346	315	291	223	187	164	147	134	124	108	97
5000	3299	1904	1126	743	582	490	429	384	350	323	247	208	182	163	149	137	120	108

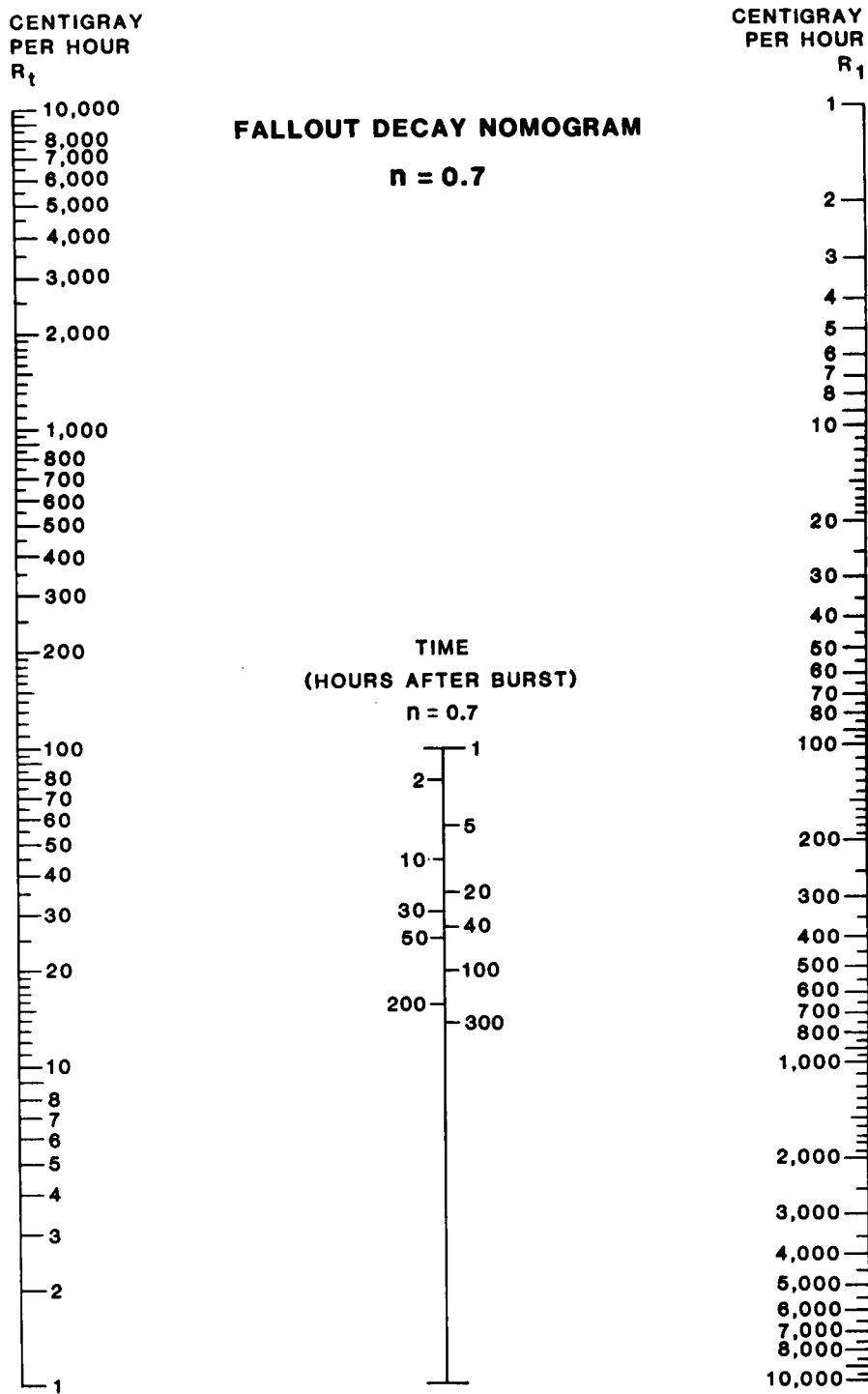

Figure E-12. Fallout decay nomogram  $n = 0.7$ .

Table E-10. Fallout decay table n = 0.7.

Centigray per hour (R1)	TIME (HOURS AFTER BURST)																	
	2	5	12	24	36	48	60	72	84	96	120	144	168	192	216	240	264	300
1	1	0	0	0	0	0	0	0	0	0	0	0	0	0	0	0	0	0
2	1	1	0	0	0	0	0	0	0	0	0	0	0	0	0	0	0	0
3	2	1	1	0	0	0	0	0	0	0	0	0	0	0	0	0	0	0
4	2	1	1	0	0	0	0	0	0	0	0	0	0	0	0	0	0	0
5	3	2	1	1	0	0	0	0	0	0	0	0	0	0	0	0	0	0
6	4	2	1	1	0	0	0	0	0	0	0	0	0	0	0	0	0	0
7	4	2	1	1	1	0	0	0	0	0	0	0	0	0	0	0	0	0
8	5	3	1	1	1	1	0	0	0	0	0	0	0	0	0	0	0	0
9	6	3	2	1	1	1	1	0	0	0	0	0	0	0	0	0	0	0
10	6	3	2	1	1	1	1	1	0	0	0	0	0	0	0	0	0	0
15	9	5	3	2	1	1	1	1	1	1	1	0	0	0	0	0	0	0
20	12	6	4	2	2	1	1	1	1	1	1	1	1	1	1	1	1	0
25	15	8	4	3	2	2	1	1	1	1	1	1	1	1	1	1	1	1
30	18	10	5	3	2	2	2	2	1	1	1	1	1	1	1	1	1	1
35	22	11	6	4	3	2	2	2	2	1	1	1	1	1	1	1	1	1
40	25	13	7	4	3	3	2	2	2	1	1	1	1	1	1	1	1	1
45	28	15	8	5	4	3	3	2	2	2	2	2	1	1	1	1	1	1
50	31	18	9	5	4	3	3	3	2	2	2	2	2	1	1	1	1	1
60	37	19	11	6	5	4	3	3	3	2	2	2	2	2	1	1	1	1
70	43	23	12	8	6	5	4	4	3	3	2	2	2	2	2	2	1	1
80	46	26	14	9	7	5	5	4	4	3	3	2	2	2	2	2	2	1
90	56	29	16	10	7	6	5	5	4	4	3	3	3	2	2	2	2	2
100	62	32	18	11	8	7	6	5	4	4	4	3	3	3	2	2	2	2
150	92	49	26	16	12	10	9	8	7	6	5	5	4	4	3	3	3	3
200	123	65	35	22	16	13	11	10	9	8	7	6	6	5	5	4	4	4
250	154	81	44	27	20	17	14	13	11	10	9	8	7	6	6	5	5	5
300	185	97	53	32	24	20	17	15	13	12	11	9	8	7	6	6	6	6
350	215	113	61	38	28	23	20	18	16	14	12	11	10	9	8	8	7	6
400	246	130	70	43	33	27	23	20	18	16	14	12	11	10	9	9	8	7
450	277	146	79	49	37	30	26	23	20	18	16	14	12	11	10	10	9	8
500	308	162	88	54	41	33	28	25	22	20	18	15	14	13	12	11	10	9
550	339	178	97	59	45	37	31	28	25	23	19	17	15	14	13	12	11	10
600	369	194	105	65	49	40	34	30	27	25	21	19	17	15	14	13	12	11
650	400	211	114	70	53	43	37	33	29	27	23	20	18	16	15	14	13	12
700	431	227	123	76	57	47	40	35	31	29	25	22	19	18	16	15	14	13
750	462	243	132	81	61	50	43	38	34	31	26	23	21	19	17	16	15	14
800	492	259	140	86	65	53	46	40	36	33	28	25	22	20	19	17	16	15
850	523	276	149	92	69	57	48	43	38	35	30	26	24	21	20	18	17	16
900	554	292	158	97	73	60	51	45	40	37	32	28	25	23	21	19	18	17
950	585	308	167	103	77	63	54	48	43	39	33	29	26	24	22	20	19	18
1000	616	324	176	108	81	67	57	50	45	41	35	31	28	25	23	22	20	18
1100	677	357	193	119	90	73	63	55	49	45	39	34	30	28	26	24	22	20
1200	739	389	211	130	98	80	68	60	54	49	42	37	33	30	28	26	24	22
1300	800	421	228	141	106	87	74	65	58	53	46	40	36	33	30	28	26	24
1400	862	454	246	151	114	93	80	70	63	57	49	43	39	35	33	30	28	26
1500	923	486	263	162	122	100	85	75	67	61	53	46	42	38	35	32	30	28
1600	985	519	281	173	130	106	91	80	72	66	56	49	44	40	37	35	32	30
1700	1046	551	299	184	138	113	97	85	76	70	60	52	47	43	39	37	34	31
1800	1108	583	316	195	147	120	102	90	81	74	63	56	50	45	42	39	36	33
1900	1170	616	334	205	155	126	108	95	85	78	67	59	53	48	44	41	38	35
2000	1231	648	351	216	163	133	114	100	90	82	70	62	55	50	46	43	40	37
2500	1539	810	439	270	203	166	142	125	112	102	88	77	69	63	58	54	50	46
3000	1847	972	527	324	244	200	171	150	135	123	105	93	83	76	70	65	61	55
3500	2155	1134	615	378	285	233	199	175	157	143	123	108	97	88	81	75	71	65
4000	2462	1297	702	432	326	266	228	200	180	164	140	123	111	101	93	86	81	74
4500	2770	1459	790	486	366	299	256	225	202	184	158	139	125	113	104	97	91	83
5000	3078	1621	878	541	407	333	285	251	225	205	175	154	138	126	116	108	101	92

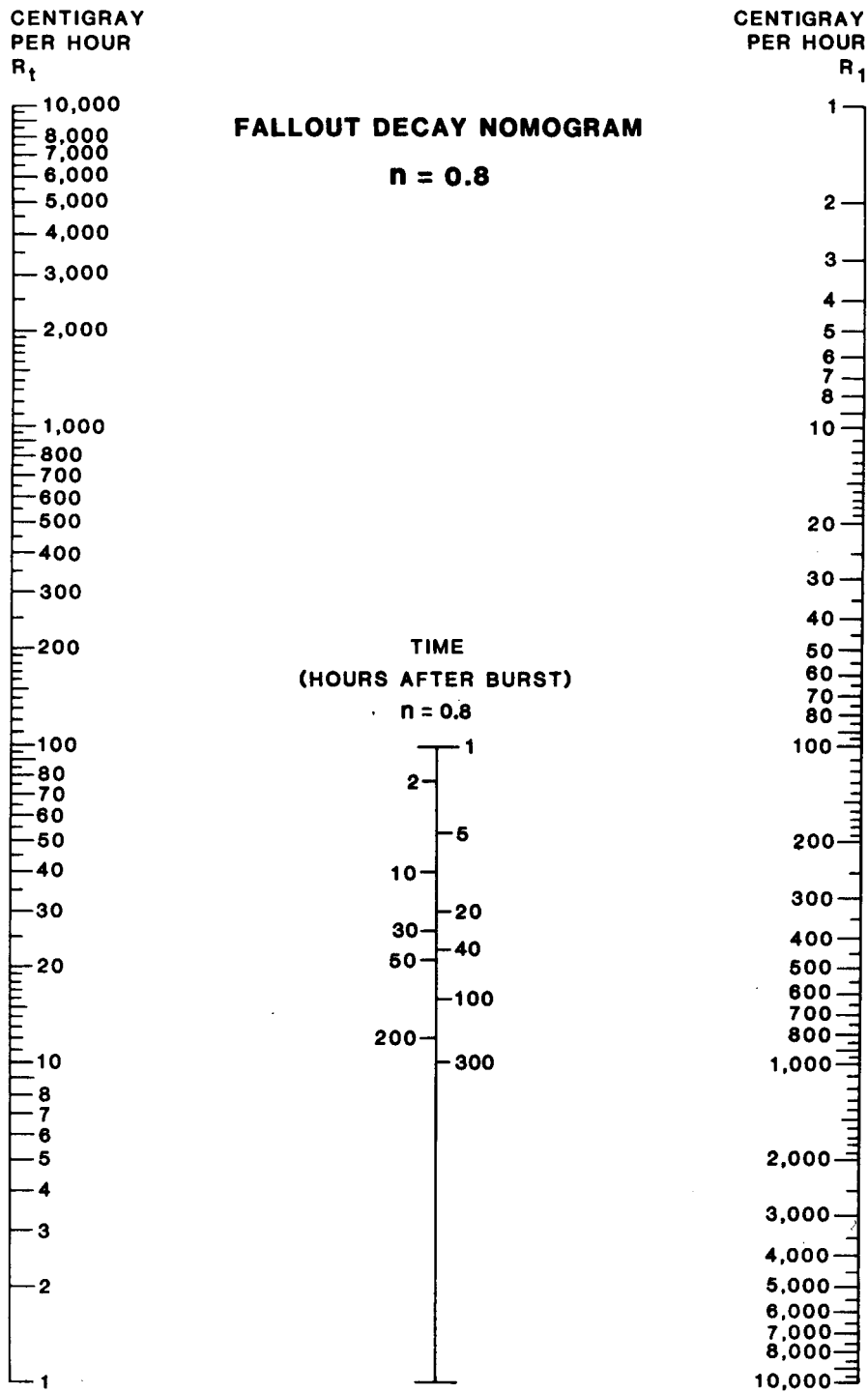

Figure E-13. Fallout decay nomogram n = 0.8.

Table E-11. Fallout decay table  $n = 0.8$ .

Centigray per hour (R1)	TIME (HOURS AFTER BURST)																	
	2	5	12	24	36	48	60	72	84	96	120	144	168	192	216	240	264	300
1	1	0	0	0	0	0	0	0	0	0	0	0	0	0	0	0	0	0
2	1	1	0	0	0	0	0	0	0	0	0	0	0	0	0	0	0	0
3	2	1	0	0	0	0	0	0	0	0	0	0	0	0	0	0	0	0
4	2	1	1	0	0	0	0	0	0	0	0	0	0	0	0	0	0	0
5	3	1	1	0	0	0	0	0	0	0	0	0	0	0	0	0	0	0
6	3	2	1	0	0	0	0	0	0	0	0	0	0	0	0	0	0	0
7	4	2	1	1	0	0	0	0	0	0	0	0	0	0	0	0	0	0
8	5	2	1	1	0	0	0	0	0	0	0	0	0	0	0	0	0	0
9	5	2	1	1	1	0	0	0	0	0	0	0	0	0	0	0	0	0
10	6	3	1	1	1	0	0	0	0	0	0	0	0	0	0	0	0	0
15	9	4	2	1	1	1	1	0	0	0	0	0	0	0	0	0	0	0
20	11	6	3	2	1	1	1	1	1	1	0	0	0	0	0	0	0	0
25	14	7	3	2	1	1	1	1	1	1	1	0	0	0	0	0	0	0
30	17	8	4	2	2	1	1	1	1	1	1	1	0	0	0	0	0	0
35	20	10	5	3	2	2	1	1	1	1	1	1	1	1	0	0	0	0
40	23	11	5	3	2	2	2	1	1	1	1	1	1	1	1	0	0	0
45	26	12	6	4	3	2	2	1	1	1	1	1	1	1	1	1	1	0
50	29	14	7	4	3	2	2	2	1	1	1	1	1	1	1	1	1	1
60	34	17	8	5	3	3	2	2	2	2	1	1	1	1	1	1	1	1
70	40	19	10	6	4	3	3	2	2	2	2	1	1	1	1	1	1	1
80	46	22	11	6	5	4	3	3	2	2	2	2	1	1	1	1	1	1
90	52	25	12	7	5	4	3	3	3	2	2	2	1	1	1	1	1	1
100	57	28	14	8	6	5	4	3	3	3	2	2	2	1	1	1	1	1
150	86	41	21	12	9	7	6	5	4	4	3	3	2	2	2	2	2	2
200	115	55	27	16	11	9	8	7	6	5	4	4	3	3	3	2	2	2
250	144	69	34	20	14	11	9	8	7	6	5	5	4	4	3	3	3	3
300	172	83	41	24	17	14	11	10	9	8	7	6	5	4	4	3	3	3
350	201	97	48	28	20	16	13	11	10	9	8	7	6	5	4	4	4	4
400	230	110	55	31	23	18	15	13	12	10	9	8	7	6	5	5	5	4
450	258	124	62	35	26	20	17	15	13	12	10	8	7	7	6	6	5	5
500	287	138	68	39	28	23	19	16	14	13	11	9	8	7	7	6	6	5
550	316	152	75	43	31	25	21	18	16	14	12	10	9	8	7	7	6	6
600	345	166	82	47	34	27	23	20	17	16	13	11	10	9	8	7	7	6
650	373	179	89	51	37	29	25	21	19	17	14	12	11	10	9	8	8	7
700	402	193	96	55	40	32	26	23	20	18	15	13	12	10	9	9	8	7
750	431	207	103	59	43	34	28	25	22	19	16	14	12	11	10	9	9	8
800	459	221	110	63	46	36	30	26	23	21	17	15	13	12	11	10	9	8
850	488	235	116	67	48	38	32	28	25	22	18	16	14	13	12	11	10	9
900	517	248	123	71	51	41	34	29	26	23	20	17	15	13	12	11	10	9
950	546	262	130	75	54	43	36	31	27	25	21	18	16	14	13	12	11	10
1000	574	276	137	79	57	45	38	33	29	26	22	19	17	15	14	12	12	10
1100	632	304	151	87	63	50	42	36	32	29	24	21	18	16	15	14	13	11
1200	689	331	164	94	68	54	45	39	35	31	26	23	20	18	16	15	14	13
1300	747	359	178	102	74	59	49	42	38	34	28	24	22	19	18	16	15	14
1400	804	386	192	110	80	63	53	46	40	36	30	26	23	21	19	17	16	15
1500	862	414	205	118	85	68	57	49	43	39	33	28	25	22	20	19	17	16
1600	919	442	219	126	91	72	60	52	46	42	35	30	27	24	22	20	18	17
1700	976	469	233	134	97	77	64	56	49	44	37	32	28	25	23	21	20	18
1800	1034	497	247	142	102	81	68	59	52	47	39	34	30	27	24	22	21	19
1900	1091	524	260	149	108	86	72	62	55	49	41	36	32	28	26	24	22	20
2000	1149	552	274	157	114	90	76	65	58	52	43	38	33	30	27	25	23	21
2500	1436	690	342	197	142	113	94	82	72	65	54	47	41	37	34	31	29	26
3000	1723	828	411	236	171	136	113	98	87	78	65	56	50	45	41	37	35	31
3500	2010	966	479	275	199	158	132	114	101	91	76	66	58	52	47	44	40	37
4000	2297	1104	548	315	228	181	151	131	116	104	87	75	66	60	54	50	46	42
4500	2585	1242	616	354	256	203	170	147	130	117	98	84	75	67	61	56	52	47
5000	2872	1380	685	393	284	226	189	163	144	130	109	94	83	75	68	62	58	52

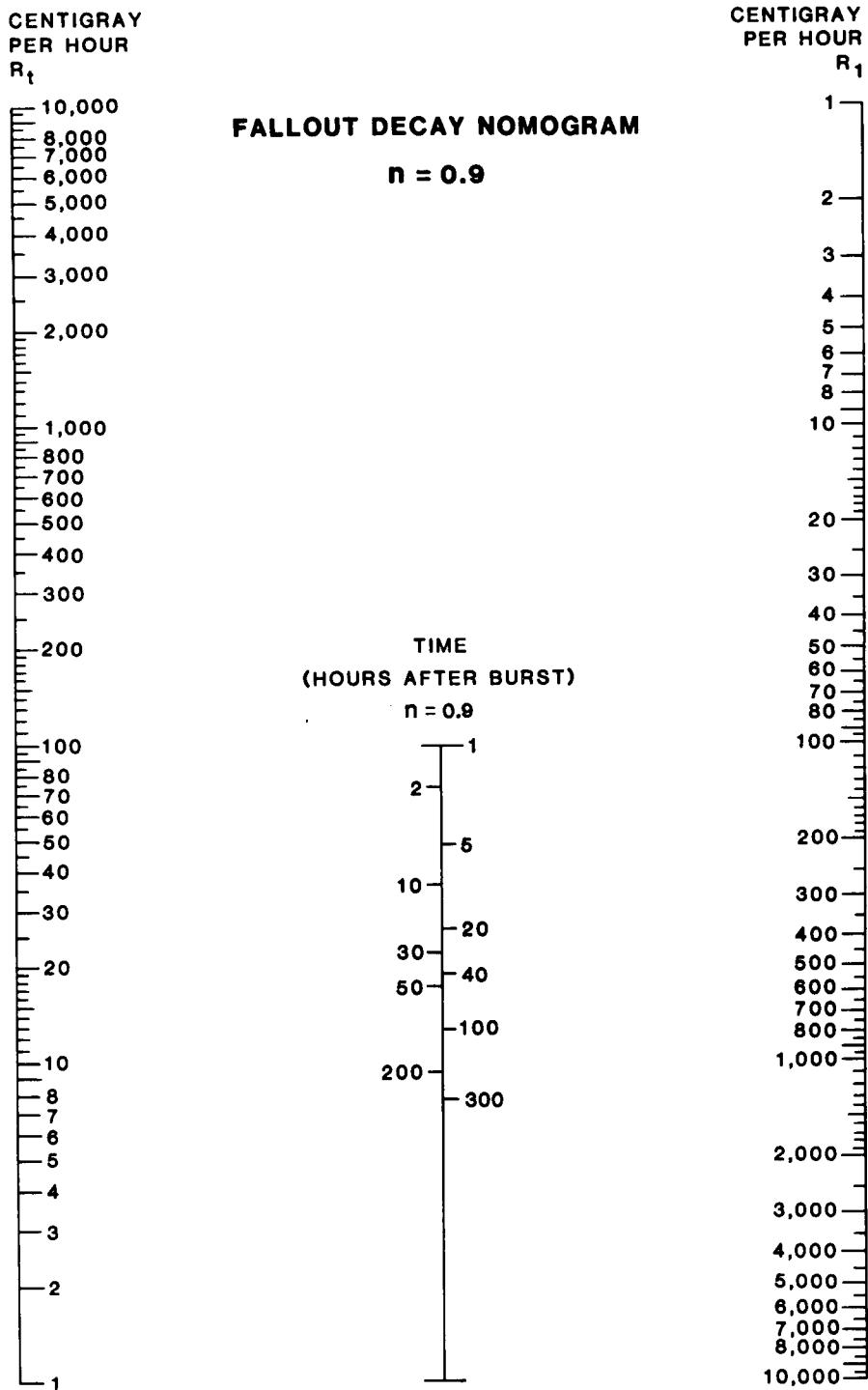

Figure E-14. Fallout decay nomogram  $n = 0.9$ .

Table E-12. Fallout decay table  $n = 0.9$ .

Centigray per hour (R1)	TIME (HOURS AFTER BURST)																	
	2	5	12	24	36	48	60	72	84	96	120	144	168	192	216	240	264	300
1	1	0	0	0	0	0	0	0	0	0	0	0	0	0	0	0	0	0
2	1	0	0	0	0	0	0	0	0	0	0	0	0	0	0	0	0	0
3	2	1	0	0	0	0	0	0	0	0	0	0	0	0	0	0	0	0
4	2	1	0	0	0	0	0	0	0	0	0	0	0	0	0	0	0	0
5	3	1	1	0	0	0	0	0	0	0	0	0	0	0	0	0	0	0
6	3	1	1	0	0	0	0	0	0	0	0	0	0	0	0	0	0	0
7	4	2	1	0	0	0	0	0	0	0	0	0	0	0	0	0	0	0
8	4	2	1	0	0	0	0	0	0	0	0	0	0	0	0	0	0	0
9	5	2	1	1	0	0	0	0	0	0	0	0	0	0	0	0	0	0
10	5	2	1	1	0	0	0	0	0	0	0	0	0	0	0	0	0	0
15	8	4	2	1	1	0	0	0	0	0	0	0	0	0	0	0	0	0
20	11	5	2	1	1	1	1	0	0	0	0	0	0	0	0	0	0	0
25	13	6	3	1	1	1	1	1	0	0	0	0	0	0	0	0	0	0
30	16	7	3	2	1	1	1	1	1	0	0	0	0	0	0	0	0	0
35	19	8	4	2	1	1	1	1	1	1	0	0	0	0	0	0	0	0
40	21	9	4	2	2	1	1	1	1	1	1	0	0	0	0	0	0	0
45	24	11	5	3	2	1	1	1	1	1	1	1	0	0	0	0	0	0
50	27	12	5	3	2	2	2	1	1	1	1	1	1	0	0	0	0	0
60	32	14	6	3	2	2	2	2	1	1	1	1	1	1	0	0	0	0
70	38	16	7	4	3	2	2	2	1	1	1	1	1	1	1	1	0	0
80	43	19	9	5	3	2	2	2	2	1	1	1	1	1	1	1	1	0
90	48	21	10	5	4	3	2	2	2	2	1	1	1	1	1	1	1	1
100	54	23	11	6	4	3	3	2	2	2	2	1	1	1	1	1	1	1
150	80	35	16	9	6	5	4	3	3	2	2	2	1	1	1	1	1	1
200	107	47	21	11	8	6	5	4	4	3	3	2	2	2	2	1	1	1
250	134	59	27	14	10	8	6	5	5	4	3	3	2	2	2	2	2	1
300	161	70	32	17	12	9	8	6	6	5	4	3	3	3	2	2	2	2
350	188	82	37	20	14	11	9	7	6	6	5	4	3	3	3	3	2	2
400	214	94	43	23	16	12	10	9	7	7	5	5	4	4	3	3	3	2
450	241	106	48	26	18	14	11	10	8	7	6	5	4	4	4	3	3	3
500	268	117	53	29	20	15	13	11	9	8	7	6	5	4	4	4	3	3
550	295	129	59	31	22	17	14	12	10	9	7	6	5	5	4	4	4	3
600	322	141	64	34	24	18	15	13	11	10	8	7	6	5	5	4	4	4
650	348	153	69	37	26	20	16	14	12	11	9	7	6	6	5	5	4	4
700	375	164	75	40	28	21	18	15	13	12	9	8	7	6	6	5	5	4
750	402	176	80	43	30	23	19	16	14	12	10	9	7	7	6	5	5	4
800	429	188	85	46	32	25	20	17	15	13	11	9	8	7	6	6	5	5
850	456	200	91	49	34	26	21	18	16	14	11	10	8	7	7	6	6	5
900	482	211	96	52	36	28	23	19	17	15	12	10	9	8	7	6	6	5
950	509	223	101	54	38	29	24	20	18	16	13	11	9	8	8	7	6	6
1000	536	235	107	57	40	31	25	21	19	16	13	11	10	9	8	7	7	6
1100	569	258	118	63	44	34	28	23	20	18	15	13	11	10	9	8	7	6
1200	643	282	128	69	48	37	30	26	22	20	16	14	12	11	10	9	8	7
1300	697	305	139	74	52	40	33	28	24	21	17	15	13	11	10	9	9	8
1400	750	329	150	80	56	43	35	30	26	23	19	16	14	12	11	10	9	8
1500	804	352	160	86	60	46	38	32	28	25	20	17	15	13	12	11	10	9
1600	857	376	171	92	64	49	40	34	30	26	22	18	16	14	13	12	11	9
1700	911	399	182	97	68	52	43	36	32	28	23	19	17	15	13	12	11	10
1800	965	423	192	103	72	55	45	38	33	30	24	21	18	16	14	13	12	11
1900	1018	446	203	109	76	58	48	40	35	31	26	22	19	17	15	14	13	11
2000	1072	470	214	115	79	61	50	43	37	33	27	23	20	18	16	14	13	12
2500	1340	587	267	143	99	77	63	53	46	41	34	29	25	22	20	18	17	15
3000	1608	705	321	172	119	92	75	64	56	49	40	34	30	26	24	22	20	18
3500	1876	822	374	200	139	107	88	75	65	58	47	40	35	31	28	25	23	21
4000	2144	940	427	229	159	123	100	85	74	66	54	46	40	35	32	29	26	24
4500	2411	1057	481	258	179	138	113	96	83	74	61	51	45	40	36	32	30	27
5000	2679	1175	534	286	199	153	125	107	93	82	67	57	50	44	40	36	33	29



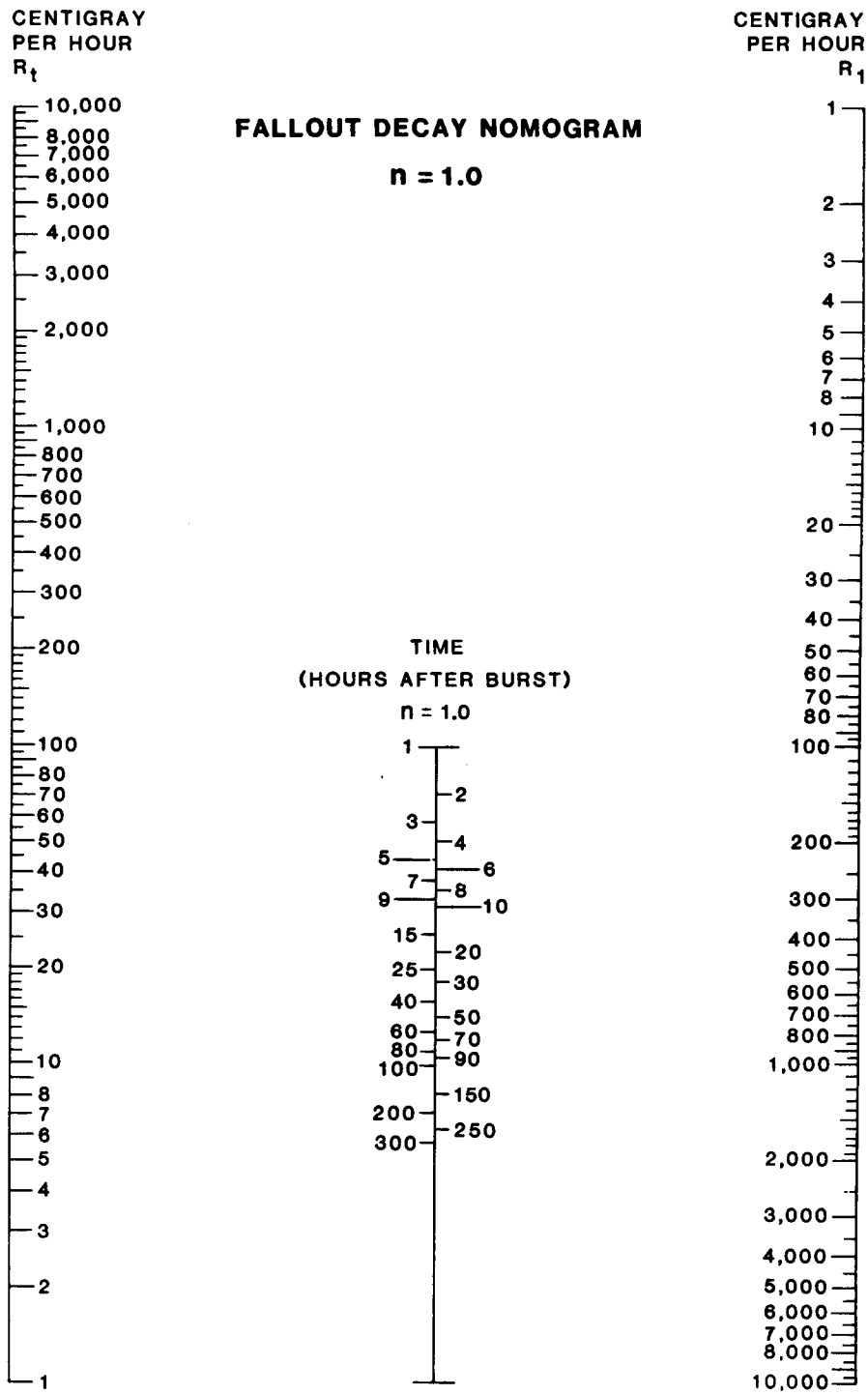

Figure E-15. Fallout decay nomogram  $n = 1.0$ .

Table E-13. Fallout decay table  $n = 1.0$ .

Centigray per hour (R1)	TIME (HOURS AFTER BURST)																					
	2	3	4	5	6	7	8	9	10	15	20	25	30	35	40	50	60	70	80	100	200	300
1	1	0	0	0	0	0	0	0	0	0	0	0	0	0	0	0	0	0	0	0	0	0
2	1	1	1	0	0	0	0	0	0	0	0	0	0	0	0	0	0	0	0	0	0	0
3	2	1	1	1	1	0	0	0	0	0	0	0	0	0	0	0	0	0	0	0	0	0
4	2	1	1	1	1	1	1	0	0	0	0	0	0	0	0	0	0	0	0	0	0	0
5	3	2	1	1	1	1	1	1	1	0	0	0	0	0	0	0	0	0	0	0	0	0
6	3	2	2	1	1	1	1	1	1	0	0	0	0	0	0	0	0	0	0	0	0	0
7	4	2	2	1	1	1	1	1	1	0	0	0	0	0	0	0	0	0	0	0	0	0
8	4	3	2	2	1	1	1	1	1	1	0	0	0	0	0	0	0	0	0	0	0	0
9	5	3	2	2	2	1	1	1	1	1	0	0	0	0	0	0	0	0	0	0	0	0
10	5	3	3	2	2	1	1	1	1	1	1	0	0	0	0	0	0	0	0	0	0	0
15	8	5	4	3	3	2	2	2	2	1	1	1	0	0	0	0	0	0	0	0	0	0
20	10	7	5	4	3	3	3	2	2	1	1	1	1	1	0	0	0	0	0	0	0	0
25	13	8	6	5	4	4	3	3	3	2	1	1	1	1	1	0	0	0	0	0	0	0
30	15	10	8	6	5	4	4	3	3	2	2	1	1	1	1	1	0	0	0	0	0	0
35	18	12	9	7	6	5	4	4	4	2	2	1	1	1	1	1	1	0	0	0	0	0
40	20	13	10	8	7	6	5	4	4	3	2	2	1	1	1	1	1	1	0	0	0	0
45	23	15	11	9	8	6	6	5	5	3	2	2	2	1	1	1	1	1	1	0	0	0
50	25	17	13	10	8	7	6	6	5	3	3	2	2	1	1	1	1	1	1	1	0	0
60	30	20	15	12	10	9	8	7	6	4	3	2	2	2	1	1	1	1	1	1	0	0
70	35	23	18	14	12	10	9	8	7	5	4	3	2	2	2	1	1	1	1	1	0	0
80	40	27	20	16	13	11	10	9	8	5	4	3	2	2	2	2	1	1	1	1	0	0
90	45	30	23	18	15	13	11	10	9	6	5	4	3	3	2	2	2	1	1	1	1	0
100	50	33	25	20	17	14	13	11	10	7	5	4	3	3	3	2	2	1	1	1	1	0
150	75	50	38	30	25	21	19	17	15	10	8	6	5	4	4	3	3	2	2	2	1	1
200	100	67	50	40	33	29	25	22	20	13	10	8	7	6	5	4	3	3	3	2	1	1
250	125	83	63	50	42	36	31	28	25	17	13	10	8	7	6	5	4	4	3	3	2	1
300	150	100	75	60	50	43	38	33	30	20	15	12	10	9	8	6	5	4	4	3	3	2
350	175	117	88	70	58	50	44	39	35	23	18	14	12	10	9	7	6	5	4	4	2	1
400	200	133	100	80	67	57	50	44	40	27	20	16	13	11	10	8	7	6	5	4	2	1
450	225	150	113	90	75	64	56	50	45	30	23	18	15	13	11	9	8	6	6	5	2	2
500	250	167	125	100	83	71	63	56	50	33	25	20	17	14	13	10	8	7	6	6	5	3
550	275	183	138	110	92	79	69	61	55	37	28	22	18	16	14	11	9	8	7	6	5	3
600	300	200	150	120	100	86	75	67	60	40	30	24	20	17	15	12	10	9	8	6	5	3
650	325	217	163	130	106	93	81	72	65	43	33	26	22	19	16	13	11	9	8	7	5	3
700	350	233	175	140	117	100	88	78	70	47	35	28	23	20	18	14	12	10	9	7	4	2
750	375	250	188	150	125	107	94	83	75	50	38	30	25	21	19	15	13	11	9	8	4	3
800	400	267	200	160	133	114	100	89	80	53	40	32	27	23	20	16	13	11	10	8	4	3
850	425	283	213	170	142	121	106	94	85	57	43	34	28	24	21	17	14	12	11	9	4	3
900	450	300	225	180	150	129	113	100	90	60	45	36	30	26	23	18	15	13	11	9	5	3
950	475	317	238	190	158	136	119	106	95	63	48	38	32	27	24	19	16	14	12	10	5	3
1000	500	333	250	200	167	143	125	111	100	67	50	40	33	29	25	20	17	14	13	10	5	3
1100	550	367	275	220	183	157	138	122	110	73	55	44	37	31	28	22	18	16	14	11	6	4
1200	600	400	300	240	200	171	150	133	120	80	60	48	40	34	30	24	20	17	15	12	6	4
1300	650	433	325	260	217	186	163	144	130	87	65	52	43	37	33	26	22	19	16	13	7	4
1400	700	467	350	280	233	200	175	156	140	93	70	56	47	40	35	28	23	20	18	14	7	5
1500	750	500	375	300	250	214	188	167	150	100	75	60	50	43	38	30	25	21	19	15	8	5
1600	800	533	400	320	267	229	200	178	160	107	80	64	53	46	40	32	27	23	20	16	8	5
1700	850	567	425	340	283	243	213	189	170	113	85	68	57	49	43	34	28	24	21	17	9	6
1800	900	600	450	360	300	257	225	200	180	120	90	72	60	51	45	36	30	26	23	18	9	6
1900	950	633	475	380	317	271	238	211	190	127	95	76	63	54	48	38	32	27	24	19	10	6
2000	1000	667	500	400	333	286	250	222	200	133	100	80	67	57	50	40	33	29	25	20	10	7
2500	1250	833	625	500	417	357	313	278	250	167	125	100	83	71	63	50	42	36	31	25	13	8
3000	1500	1000	750	600	500	429	375	333	300	200	150	120	100	86	75	60	50	43	38	30	15	10
3500	1750	1167	875	700	583	500	438	389	350	233	175	140	117	100	88	70	58	50	44	35	18	12
4000	2000	1333	1000	800	667	571	500	444	400	267	200	160	133	114	100	80	67	57	50	40	20	13
4500	2250	1500	1125	900	750	643	563	500	450	300	225	180	150	129	113	90	75	64	56	45	23	15
5000	2500	1667	1250	1000	833	714	625	556	500	333	250	200	167	143	125	100	83	71	63	50	25	17

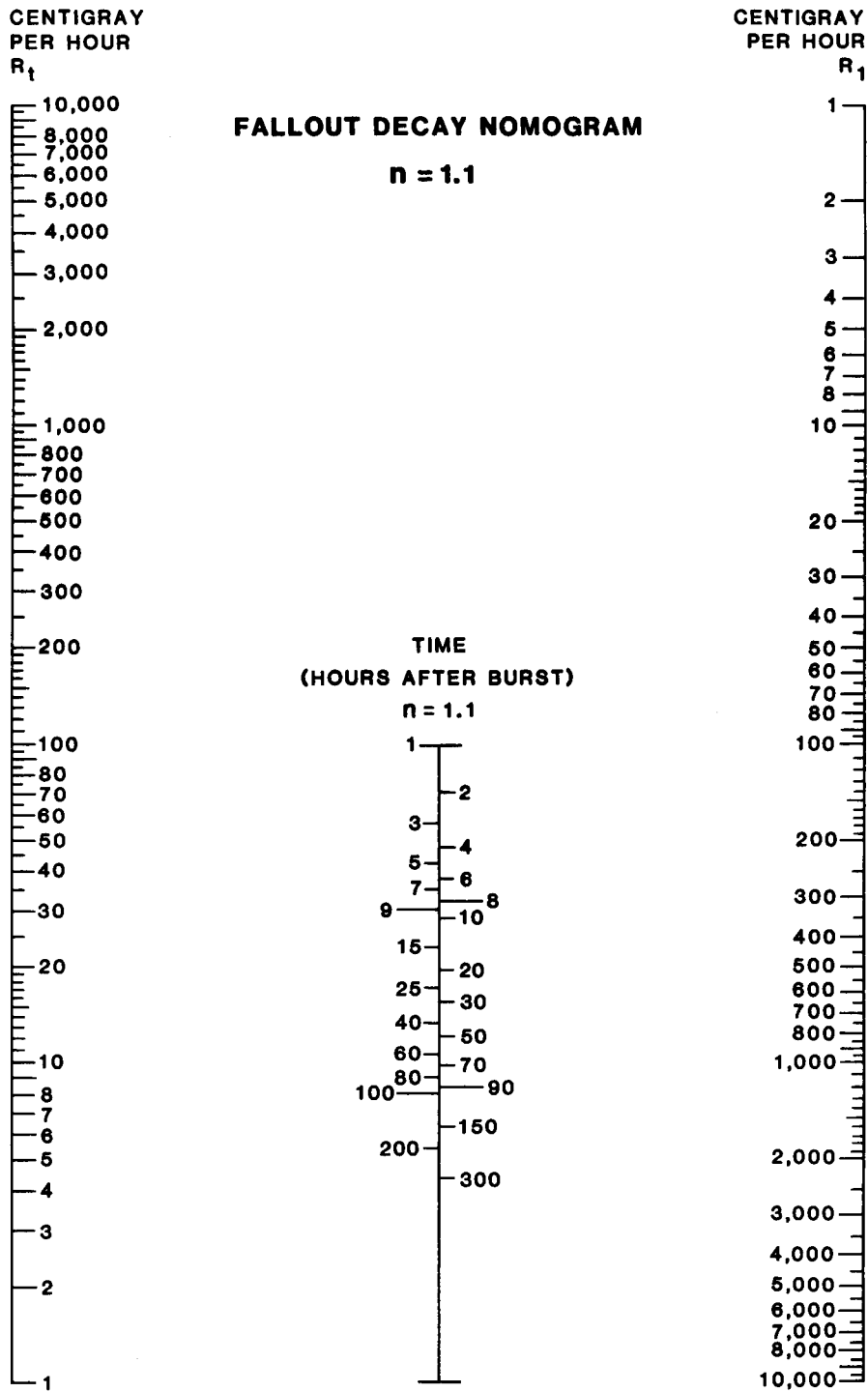

Figure E-16. Fallout decay nomogram  $n = 1.1$ .

Table E-14. Fallout decay table  $n = 1.1$ .

Centigray per hour (R1)	TIME (HOURS AFTER BURST)																					
	2	3	4	5	6	7	8	9	10	15	20	25	30	35	40	50	60	70	80	100	200	300
1	0	0	0	0	0	0	0	0	0	0	0	0	0	0	0	0	0	0	0	0	0	0
2	1	1	0	0	0	0	0	0	0	0	0	0	0	0	0	0	0	0	0	0	0	0
3	1	1	1	1	0	0	0	0	0	0	0	0	0	0	0	0	0	0	0	0	0	0
4	2	1	1	1	1	0	0	0	0	0	0	0	0	0	0	0	0	0	0	0	0	0
5	2	1	1	1	1	1	1	0	0	0	0	0	0	0	0	0	0	0	0	0	0	0
6	3	2	1	1	1	1	1	1	0	0	0	0	0	0	0	0	0	0	0	0	0	0
7	3	2	2	1	1	1	1	1	1	0	0	0	0	0	0	0	0	0	0	0	0	0
8	4	2	2	1	1	1	1	1	1	0	0	0	0	0	0	0	0	0	0	0	0	0
9	4	3	2	2	1	1	1	1	1	0	0	0	0	0	0	0	0	0	0	0	0	0
10	5	3	2	2	1	1	1	1	1	1	0	0	0	0	0	0	0	0	0	0	0	0
15	7	4	3	3	2	2	2	1	1	1	0	0	0	0	0	0	0	0	0	0	0	0
20	9	6	4	3	3	2	2	2	2	1	1	1	0	0	0	0	0	0	0	0	0	0
25	12	7	5	4	3	3	3	2	2	1	1	1	1	0	0	0	0	0	0	0	0	0
30	14	9	7	5	4	4	3	3	2	2	1	1	1	1	0	0	0	0	0	0	0	0
35	16	10	8	6	5	4	4	3	3	2	1	1	1	1	1	0	0	0	0	0	0	0
40	19	12	9	7	6	5	4	4	3	2	1	1	1	1	1	0	0	0	0	0	0	0
45	21	13	10	8	6	5	5	4	4	2	2	1	1	1	1	0	0	0	0	0	0	0
50	23	15	11	9	7	6	5	4	4	3	2	1	1	1	1	1	0	0	0	0	0	0
60	28	18	13	10	8	7	6	5	5	3	2	2	1	1	1	1	1	0	0	0	0	0
70	33	21	15	12	10	8	7	6	6	4	3	2	2	1	1	1	1	1	0	0	0	0
80	37	24	17	14	11	9	8	7	6	4	3	2	2	2	1	1	1	1	1	0	0	0
90	42	27	20	15	13	11	9	8	7	5	3	3	2	2	2	1	1	1	1	1	0	0
100	47	30	22	17	14	12	10	9	8	5	4	3	2	2	2	1	1	1	1	1	0	0
150	70	45	33	26	21	18	15	13	12	8	6	4	4	3	3	2	2	1	1	1	0	0
200	93	60	44	34	28	24	20	18	16	10	7	6	5	4	3	3	2	2	2	1	1	0
250	117	75	54	43	35	29	25	22	20	13	9	7	6	5	4	3	3	2	2	2	1	0
300	140	90	65	51	42	35	30	27	24	15	11	9	7	6	5	4	3	3	2	2	1	1
350	163	105	78	60	49	41	36	31	28	18	13	10	8	7	6	5	4	3	3	2	1	1
400	187	119	87	68	56	47	41	36	32	20	15	12	9	8	7	5	4	4	3	3	1	1
450	210	134	98	77	63	53	46	40	36	23	17	13	11	9	8	6	5	4	4	3	1	1
500	233	149	109	85	70	59	51	45	40	25	19	14	12	10	9	7	6	5	4	3	1	1
550	257	164	120	94	77	65	56	49	44	28	20	16	13	11	10	7	6	5	4	3	2	1
600	280	179	131	102	84	71	61	54	48	31	22	17	14	12	10	8	7	6	5	4	2	1
650	303	194	141	111	91	76	66	58	52	33	24	19	15	13	11	9	7	6	5	4	2	1
700	327	209	152	119	98	82	71	62	56	36	26	20	17	14	12	9	8	7	6	4	2	1
750	350	224	163	128	104	88	76	67	60	38	28	22	18	15	13	10	8	7	6	5	2	1
800	373	239	174	136	111	94	81	71	64	41	30	23	19	16	14	11	9	7	6	5	2	2
850	397	254	185	145	118	100	86	76	68	43	31	25	20	17	15	11	9	8	7	5	3	2
900	420	269	196	153	125	106	91	80	71	46	33	26	21	18	16	12	10	8	7	6	3	2
950	443	284	207	162	132	112	96	85	75	48	35	28	23	19	16	13	11	9	8	6	3	2
1000	467	299	218	170	139	118	102	89	79	51	37	29	24	20	17	14	11	9	8	6	3	2
1100	513	329	239	187	153	129	112	98	87	56	41	32	26	22	19	15	12	10	9	7	3	2
1200	560	358	261	204	167	141	122	107	95	61	44	35	28	24	21	16	13	11	10	8	4	2
1300	606	388	283	221	181	153	132	116	103	66	48	38	31	26	22	18	14	12	10	8	4	2
1400	653	418	305	238	195	165	142	125	111	71	52	41	33	28	24	19	15	13	11	9	4	3
1500	700	448	326	255	209	176	152	134	119	76	56	43	36	30	26	20	17	14	12	9	4	3
1600	746	478	348	272	223	188	162	143	127	81	59	46	38	32	28	22	18	15	13	10	5	3
1700	793	508	370	289	237	200	173	152	135	86	63	49	40	34	29	23	19	16	14	11	5	3
1800	840	538	392	306	251	212	183	161	143	92	67	52	43	36	31	24	20	17	15	11	5	3
1900	886	567	414	324	265	223	193	169	151	97	70	55	45	38	33	26	21	18	15	12	6	4
2000	933	597	435	341	279	235	203	178	159	102	74	58	47	40	35	27	22	19	16	13	6	4
2500	1166	747	544	426	348	294	254	223	199	127	93	72	59	50	43	34	28	23	20	16	7	5
3000	1400	896	653	511	418	353	305	268	238	153	111	87	71	60	52	41	33	28	24	19	9	6
3500	1633	1045	762	596	488	412	355	312	278	178	130	101	83	70	61	47	39	33	28	22	10	7
4000	1866	1195	871	681	557	470	406	357	318	203	148	116	95	80	69	54	44	37	32	25	12	8
4500	2099	1344	979	766	627	529	457	401	357	229	167	130	107	90	78	61	50	42	36	28	13	8
5000	2333	1493	1088	851	697	588	508	446	397	254	185	145	119	100	86	68	55	47	40	32	15	9

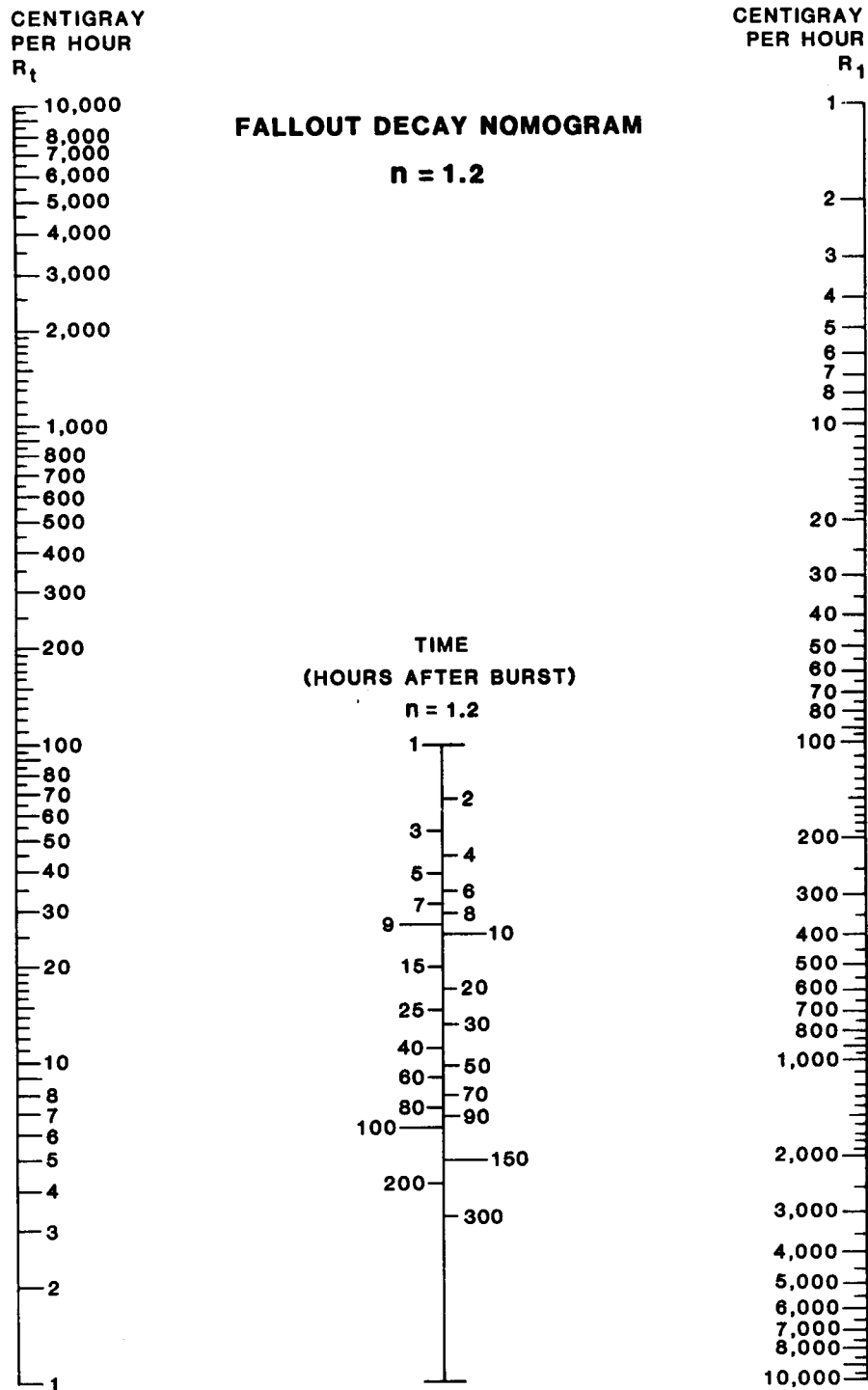

Figure E-17. Fallout decay nomogram  $n = 1.2$ .

Table E-15. Fallout decay table n = 1.2.

Centigray per hour (R1)	TIME (HOURS AFTER BURST)																					
	2	3	4	5	6	7	8	9	10	15	20	25	30	35	40	50	60	70	80	100	200	300
1	0	0	0	0	0	0	0	0	0	0	0	0	0	0	0	0	0	0	0	0	0	0
2	1	1	0	0	0	0	0	0	0	0	0	0	0	0	0	0	0	0	0	0	0	0
3	1	1	1	0	0	0	0	0	0	0	0	0	0	0	0	0	0	0	0	0	0	0
4	2	1	1	1	0	0	0	0	0	0	0	0	0	0	0	0	0	0	0	0	0	0
5	2	1	1	1	1	0	0	0	0	0	0	0	0	0	0	0	0	0	0	0	0	0
6	3	2	1	1	1	1	0	0	0	0	0	0	0	0	0	0	0	0	0	0	0	0
7	3	2	1	1	1	1	1	1	0	0	0	0	0	0	0	0	0	0	0	0	0	0
8	3	2	2	1	1	1	1	1	1	0	0	0	0	0	0	0	0	0	0	0	0	0
9	4	2	2	1	1	1	1	1	1	0	0	0	0	0	0	0	0	0	0	0	0	0
10	4	3	2	1	1	1	1	1	1	0	0	0	0	0	0	0	0	0	0	0	0	0
15	7	4	3	2	2	1	1	1	1	1	0	0	0	0	0	0	0	0	0	0	0	0
20	9	5	4	3	2	2	2	1	1	1	1	0	0	0	0	0	0	0	0	0	0	0
25	11	7	5	4	3	2	2	2	2	1	1	1	0	0	0	0	0	0	0	0	0	0
30	13	8	6	4	3	3	2	2	2	1	1	1	0	0	0	0	0	0	0	0	0	0
35	15	9	7	5	4	3	3	3	2	1	1	1	1	0	0	0	0	0	0	0	0	0
40	17	11	8	6	5	4	3	3	3	2	1	1	1	1	0	0	0	0	0	0	0	0
45	20	12	9	7	5	4	4	3	3	2	1	1	1	1	1	0	0	0	0	0	0	0
50	22	13	9	7	6	5	4	4	3	2	1	1	1	1	1	0	0	0	0	0	0	0
60	28	18	11	9	7	6	5	4	4	2	2	1	1	1	1	1	0	0	0	0	0	0
70	30	19	13	10	8	7	6	5	4	3	2	1	1	1	1	1	1	0	0	0	0	0
80	35	21	15	12	9	8	7	6	5	3	2	2	1	1	1	1	1	0	0	0	0	0
90	39	24	17	13	10	9	7	6	6	3	2	2	2	1	1	1	1	1	0	0	0	0
100	44	27	19	14	12	10	8	7	6	4	3	2	2	1	1	1	1	1	1	0	0	0
150	65	40	28	22	17	15	12	11	9	6	4	3	3	2	2	1	1	1	1	1	0	0
200	87	54	38	29	23	19	16	14	13	8	5	4	3	3	2	2	1	1	1	1	0	0
250	109	67	47	36	29	24	21	18	16	10	7	5	4	4	3	2	2	2	1	1	0	0
300	131	80	57	43	35	29	25	21	19	12	8	6	5	4	4	3	2	2	2	1	1	0
350	152	94	66	51	41	34	29	25	22	14	10	7	6	5	4	3	3	2	2	1	1	0
400	174	107	76	58	47	39	33	29	25	16	11	8	7	6	5	4	3	2	2	2	1	0
450	196	120	85	65	52	44	37	32	28	17	12	9	8	6	5	4	3	3	2	2	1	0
500	218	134	95	72	58	48	41	36	32	19	14	11	8	7	6	5	4	3	3	2	1	1
550	239	147	104	80	64	53	45	39	35	21	15	12	9	8	7	5	4	3	3	2	1	1
600	261	161	114	87	70	58	49	43	38	23	16	13	10	8	7	5	4	4	3	2	1	1
650	283	174	123	94	76	63	54	47	41	25	18	14	11	9	8	6	5	4	3	3	1	1
700	305	187	133	101	82	68	56	50	44	27	19	15	12	10	8	6	5	4	4	3	1	1
750	326	201	142	109	87	73	62	54	47	29	21	16	13	11	9	7	6	5	4	3	1	1
800	348	214	152	116	93	77	66	57	50	31	22	17	14	11	10	7	6	5	4	3	1	1
850	370	227	161	123	99	82	70	61	54	33	23	18	14	12	10	8	6	5	4	3	1	1
900	392	241	171	130	105	87	74	64	57	35	25	19	15	13	11	8	7	5	5	4	2	1
950	414	254	180	138	111	92	78	68	60	37	26	20	16	13	11	9	7	6	5	4	2	1
1000	435	268	189	145	116	97	82	72	63	39	27	21	17	14	12	9	7	6	5	4	2	1
1100	479	294	208	159	128	106	91	79	69	43	30	23	19	15	13	10	8	7	6	4	2	1
1200	522	321	227	174	140	116	99	86	76	47	33	25	20	17	14	11	9	7	6	5	2	1
1300	566	348	246	188	151	126	107	93	82	50	36	27	22	18	16	12	10	8	7	5	2	1
1400	609	375	265	203	163	136	115	100	88	54	38	29	24	20	17	13	10	9	7	6	2	1
1500	653	401	284	217	175	145	124	107	95	58	41	32	25	21	18	14	11	9	8	6	3	2
1600	696	428	303	232	186	155	132	115	101	62	44	34	27	22	19	15	12	10	8	6	3	2
1700	740	455	322	246	198	165	140	122	107	66	47	36	29	24	20	16	12	10	9	7	3	2
1800	783	482	341	261	210	174	148	129	114	70	49	38	30	25	22	16	13	11	9	7	3	2
1900	827	508	360	275	221	184	157	136	120	74	52	40	32	27	23	17	14	12	10	8	3	2
2000	871	535	379	290	233	194	165	143	126	78	55	42	34	28	24	18	15	12	10	8	3	2
2500	1088	669	474	362	291	242	206	179	158	97	69	53	42	35	30	23	18	15	13	10	4	3
3000	1306	803	568	435	349	290	247	215	189	116	82	63	51	42	36	27	22	18	16	12	5	3
3500	1523	937	663	507	408	339	289	251	221	136	96	74	59	49	42	32	26	21	18	14	6	4
4000	1741	1070	758	580	466	387	330	286	252	155	110	84	68	56	48	37	29	24	21	16	7	4
4500	1959	1204	853	652	524	436	371	322	284	175	124	95	76	63	54	41	33	27	23	18	8	5
5000	2176	1338	947	725	582	484	412	358	315	194	137	105	84	70	60	46	37	31	26	20	9	5

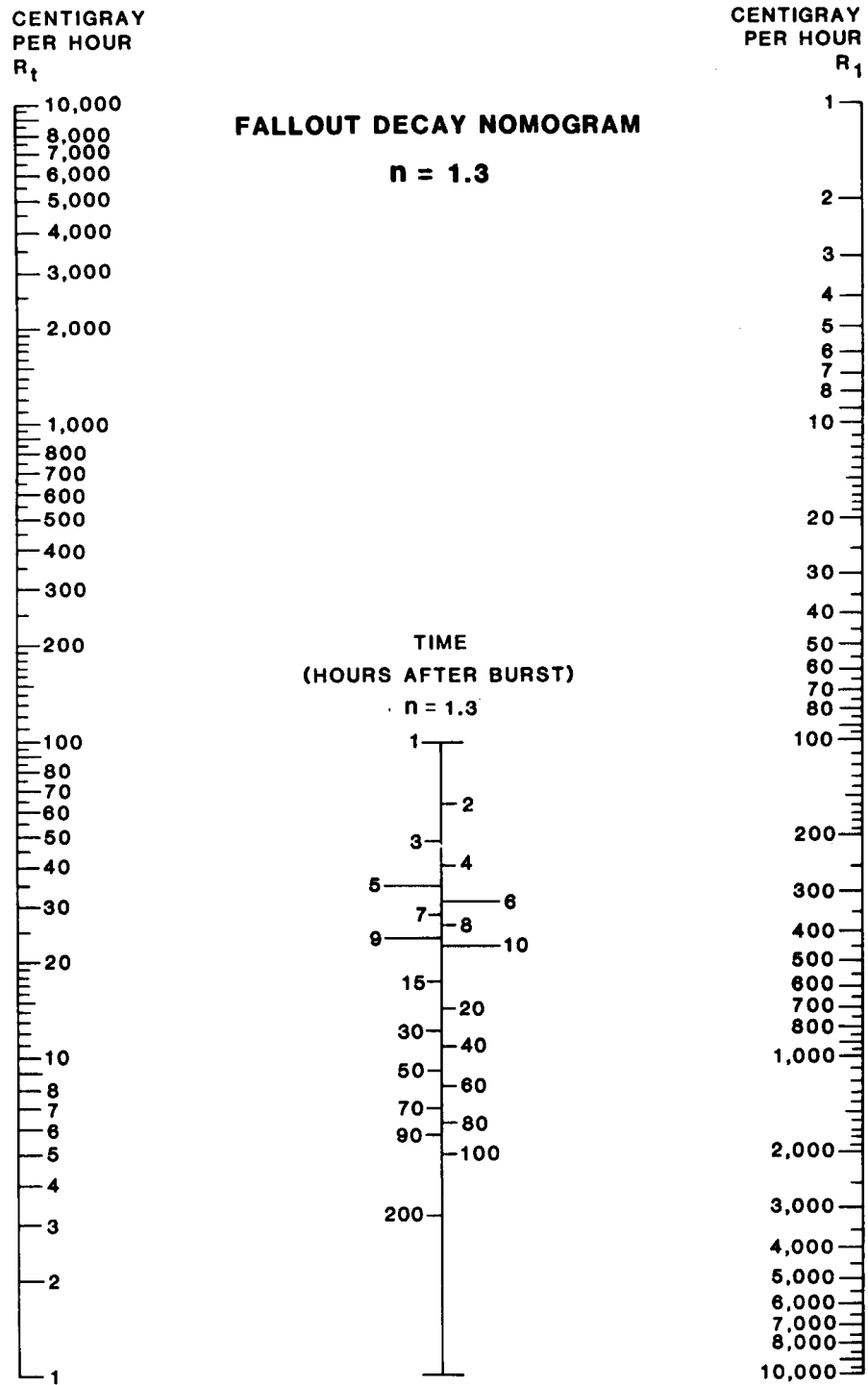

Figure E-18. Fallout decay nomogram n = 1.3.

Table E-16. Fallout decay table  $n = 1.3$ .

Centigray per hour (R1)	TIME (HOURS AFTER BURST)																					
	2	3	4	5	6	7	8	9	10	15	20	25	30	35	40	50	60	70	80	100	150	200
1	0	0	0	0	0	0	0	0	0	0	0	0	0	0	0	0	0	0	0	0	0	0
2	1	0	0	0	0	0	0	0	0	0	0	0	0	0	0	0	0	0	0	0	0	0
3	1	1	0	0	0	0	0	0	0	0	0	0	0	0	0	0	0	0	0	0	0	0
4	2	1	1	0	0	0	0	0	0	0	0	0	0	0	0	0	0	0	0	0	0	0
5	2	1	1	1	0	0	0	0	0	0	0	0	0	0	0	0	0	0	0	0	0	0
6	2	1	1	1	1	0	0	0	0	0	0	0	0	0	0	0	0	0	0	0	0	0
7	3	2	1	1	1	1	0	0	0	0	0	0	0	0	0	0	0	0	0	0	0	0
8	3	2	1	1	1	1	1	0	0	0	0	0	0	0	0	0	0	0	0	0	0	0
9	4	2	1	1	1	1	1	1	0	0	0	0	0	0	0	0	0	0	0	0	0	0
10	4	2	2	1	1	1	1	1	1	0	0	0	0	0	0	0	0	0	0	0	0	0
15	6	4	2	2	1	1	1	1	1	0	0	0	0	0	0	0	0	0	0	0	0	0
20	8	5	3	2	2	2	1	1	1	1	0	0	0	0	0	0	0	0	0	0	0	0
25	10	6	4	3	2	2	2	1	1	1	0	0	0	0	0	0	0	0	0	0	0	0
30	12	7	5	4	3	2	2	2	2	1	1	0	0	0	0	0	0	0	0	0	0	0
35	14	8	6	4	3	3	2	2	2	1	1	1	0	0	0	0	0	0	0	0	0	0
40	16	10	7	5	4	3	3	2	2	1	1	1	0	0	0	0	0	0	0	0	0	0
45	18	11	7	6	4	4	3	3	2	1	1	1	1	0	0	0	0	0	0	0	0	0
50	20	12	8	6	5	4	3	3	3	1	1	1	1	0	0	0	0	0	0	0	0	0
60	24	14	10	7	6	5	4	3	3	2	1	1	1	1	0	0	0	0	0	0	0	0
70	28	17	12	9	7	6	5	4	4	2	1	1	1	1	1	0	0	0	0	0	0	0
80	32	19	13	10	8	6	5	5	4	2	2	1	1	1	1	0	0	0	0	0	0	0
90	37	22	15	11	8	7	6	5	5	3	2	1	1	1	1	0	0	0	0	0	0	0
100	41	24	16	12	10	8	7	6	5	3	2	2	1	1	1	1	0	0	0	0	0	0
150	61	36	25	19	15	12	10	9	8	4	3	2	2	1	1	1	1	1	1	1	0	0
200	81	48	33	25	19	16	13	11	10	6	4	3	2	2	2	1	1	1	1	1	1	0
250	102	60	41	31	24	20	17	14	13	7	5	4	3	2	2	2	1	1	1	1	1	0
300	122	72	49	37	29	24	20	17	15	9	6	5	4	3	2	2	1	1	1	1	1	0
350	142	84	58	43	34	28	23	20	18	10	7	5	4	3	3	2	2	1	1	1	1	0
400	162	96	66	49	39	32	27	23	20	12	8	6	5	4	3	2	2	2	1	1	1	0
450	183	108	74	56	44	36	30	26	23	13	9	7	5	4	4	3	2	2	2	1	1	1
500	203	120	82	62	49	40	33	29	25	15	10	8	6	5	4	3	2	2	2	1	1	1
550	223	132	91	68	54	44	37	32	28	16	11	8	7	5	5	3	3	2	2	1	1	1
600	244	144	99	74	58	48	40	34	30	18	12	9	7	6	5	4	3	2	2	2	1	1
650	264	156	107	80	63	52	44	37	33	19	13	10	8	6	5	4	3	3	2	2	1	1
700	284	168	115	86	68	56	47	40	35	21	14	11	8	7	6	4	3	3	2	2	1	1
750	305	180	124	93	73	60	50	43	38	22	15	11	9	7	6	5	4	3	3	2	1	1
800	325	192	132	99	78	64	54	46	40	24	16	12	10	8	7	5	4	3	3	2	1	1
850	345	204	140	105	83	68	57	49	43	25	17	13	10	8	7	5	4	3	3	2	1	1
900	366	216	148	111	88	72	60	52	45	27	18	14	11	9	7	6	4	3	3	2	1	1
950	386	228	157	117	92	76	64	55	48	28	19	14	11	9	8	6	5	4	3	2	1	1
1000	406	240	165	123	97	80	67	57	50	30	20	15	12	10	8	6	5	4	3	3	1	1
1100	447	264	181	136	107	88	74	63	55	33	22	17	13	11	9	7	5	4	4	3	2	1
1200	487	288	198	148	117	96	80	69	60	36	24	18	14	12	10	7	6	5	4	3	2	1
1300	528	312	214	160	127	104	87	75	65	38	26	20	16	13	11	8	6	5	4	3	2	1
1400	569	336	231	173	136	112	94	80	70	41	28	21	17	14	12	9	7	6	5	4	2	1
1500	609	360	247	185	146	120	100	86	75	44	31	23	18	15	12	9	7	6	5	4	2	2
1600	650	384	264	197	156	127	107	92	80	47	33	24	19	16	13	10	8	6	5	4	2	2
1700	690	408	280	210	166	135	114	98	85	50	35	26	20	17	14	11	8	7	6	4	3	2
1800	731	432	297	222	175	143	121	103	90	53	37	27	22	18	15	11	9	7	6	5	3	2
1900	772	456	313	234	185	151	127	109	95	56	39	29	23	19	16	12	9	8	6	5	3	2
2000	812	479	330	247	195	159	134	115	100	59	41	30	24	20	17	12	10	8	7	5	3	2
2500	1015	599	412	309	243	199	167	144	125	74	51	38	30	25	21	15	12	10	8	6	4	3
3000	1218	719	495	370	292	239	201	172	150	89	61	46	36	30	25	19	15	12	10	8	4	3
3500	1421	839	577	432	341	279	234	201	175	104	71	53	42	34	29	22	17	14	12	9	5	4
4000	1625	959	660	494	389	319	268	230	200	118	81	61	48	39	33	25	20	16	13	10	6	4
4500	1828	1079	742	555	438	359	301	259	226	133	92	69	54	44	37	28	22	18	15	11	7	5
5000	2031	1199	825	617	487	398	335	287	251	148	102	76	60	49	41	31	24	20	17	13	7	5



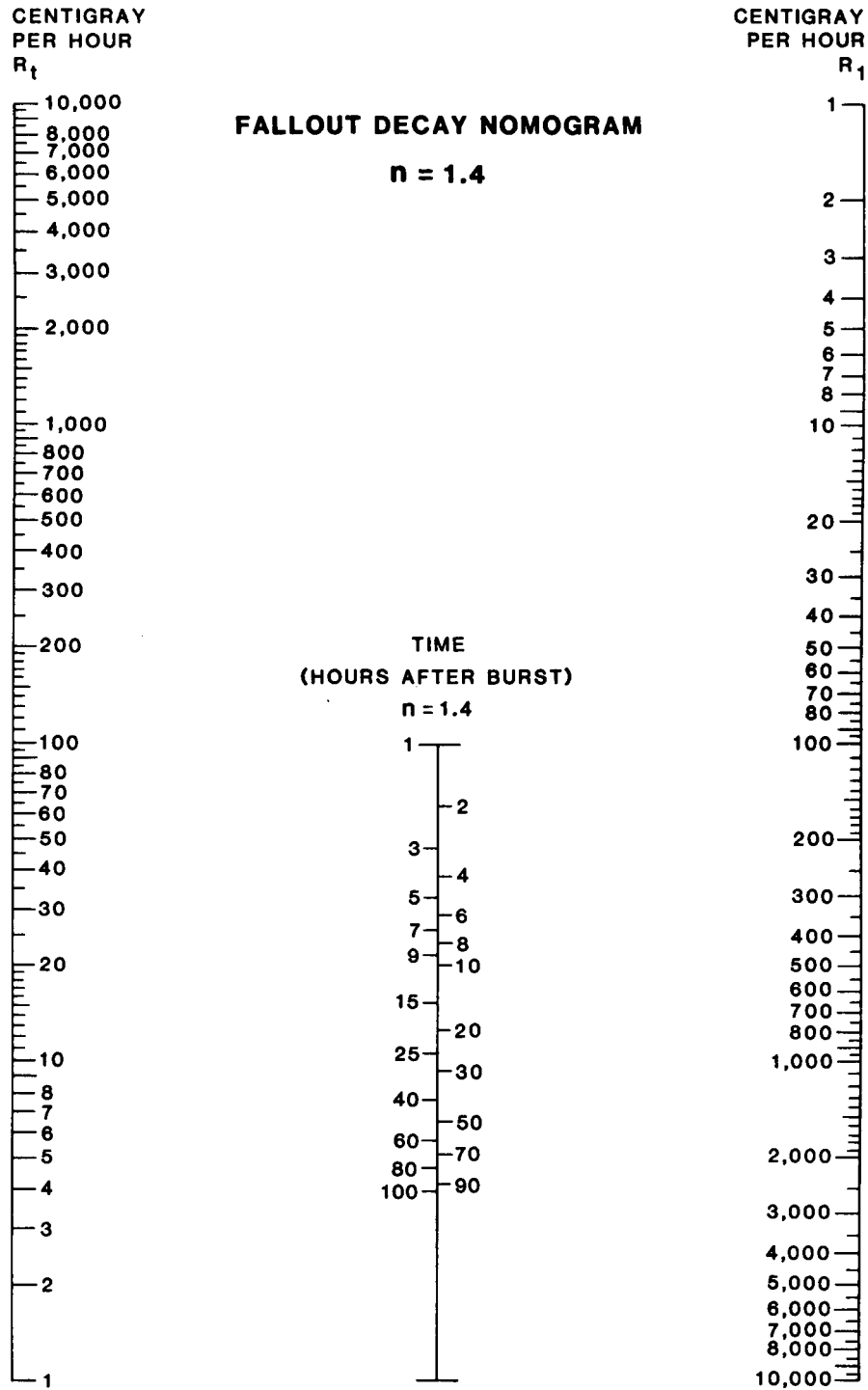

Figure E-19. Fallout decay nomogram  $n = 1.4$ .

Table E-17. Fallout decay table n = 1.4.

Centigray per hour (R1)	TIME (HOURS AFTER BURST)																					
	2	3	4	5	6	7	8	9	10	12	15	20	25	30	35	40	50	60	70	80	90	100
1	0	0	0	0	0	0	0	0	0	0	0	0	0	0	0	0	0	0	0	0	0	0
2	1	0	0	0	0	0	0	0	0	0	0	0	0	0	0	0	0	0	0	0	0	0
3	1	1	0	0	0	0	0	0	0	0	0	0	0	0	0	0	0	0	0	0	0	0
4	2	1	1	0	0	0	0	0	0	0	0	0	0	0	0	0	0	0	0	0	0	0
5	2	1	1	1	0	0	0	0	0	0	0	0	0	0	0	0	0	0	0	0	0	0
6	2	1	1	1	0	0	0	0	0	0	0	0	0	0	0	0	0	0	0	0	0	0
7	3	2	1	1	1	0	0	0	0	0	0	0	0	0	0	0	0	0	0	0	0	0
8	3	2	1	1	1	1	0	0	0	0	0	0	0	0	0	0	0	0	0	0	0	0
9	3	2	1	1	1	1	1	0	0	0	0	0	0	0	0	0	0	0	0	0	0	0
10	4	2	1	1	1	1	1	0	0	0	0	0	0	0	0	0	0	0	0	0	0	0
15	6	3	2	2	1	1	1	1	1	0	0	0	0	0	0	0	0	0	0	0	0	0
20	8	4	3	2	2	1	1	1	1	1	0	0	0	0	0	0	0	0	0	0	0	0
25	9	5	4	3	2	2	1	1	1	1	1	0	0	0	0	0	0	0	0	0	0	0
30	11	6	4	3	2	2	2	1	1	1	1	0	0	0	0	0	0	0	0	0	0	0
35	13	8	5	4	3	2	2	2	1	1	1	1	0	0	0	0	0	0	0	0	0	0
40	15	9	6	4	3	3	2	2	2	1	1	1	0	0	0	0	0	0	0	0	0	0
45	17	10	6	5	4	3	2	2	2	1	1	1	0	0	0	0	0	0	0	0	0	0
50	19	11	7	5	4	3	3	2	2	2	1	1	1	0	0	0	0	0	0	0	0	0
60	23	13	9	6	5	4	3	3	2	2	1	1	1	1	0	0	0	0	0	0	0	0
70	27	15	10	7	6	5	4	3	3	2	2	1	1	1	0	0	0	0	0	0	0	0
80	30	17	11	8	7	5	4	4	3	2	2	1	1	1	1	0	0	0	0	0	0	0
90	34	19	13	9	7	6	5	4	4	3	2	1	1	1	1	1	0	0	0	0	0	0
100	38	21	14	11	8	7	5	5	4	3	2	2	1	1	1	1	0	0	0	0	0	0
150	57	32	22	16	12	10	8	7	6	5	3	2	2	1	1	1	1	0	0	0	0	0
200	76	43	29	21	16	13	11	9	8	6	5	3	2	2	1	1	1	1	0	0	0	0
250	95	54	36	26	20	16	14	12	10	8	6	4	3	2	2	1	1	1	1	0	0	0
300	114	64	43	32	24	20	16	14	12	9	7	5	3	3	2	2	1	1	1	1	1	0
350	133	75	50	37	28	23	19	16	14	11	8	5	4	3	2	2	1	1	1	1	1	1
400	152	86	57	42	33	26	22	18	16	12	9	6	4	3	3	2	2	1	1	1	1	1
450	171	97	65	47	37	30	24	21	18	14	10	7	5	4	3	3	2	1	1	1	1	1
500	189	107	72	53	41	33	27	23	20	15	11	8	6	4	3	3	2	2	1	1	1	1
550	208	118	79	58	45	36	30	25	22	17	12	8	6	5	4	3	2	2	1	1	1	1
600	227	129	86	63	49	39	33	28	24	19	14	9	7	5	4	3	2	2	1	1	1	1
650	246	140	93	68	53	43	35	30	26	20	15	10	7	6	4	4	3	2	2	1	1	1
700	265	150	101	74	57	46	38	32	28	22	16	11	8	6	5	4	3	2	2	2	1	1
750	284	161	108	79	61	49	41	35	30	23	17	11	8	6	5	4	3	2	2	2	1	1
800	303	172	115	84	65	52	44	37	32	25	18	12	9	7	6	5	3	3	2	2	1	1
850	322	183	122	89	69	56	46	39	34	26	19	13	9	7	6	5	4	3	2	2	2	1
900	341	193	129	95	73	59	49	42	36	28	20	14	10	8	6	5	4	3	2	2	2	1
950	360	204	136	100	77	62	52	44	38	29	21	14	10	8	7	5	4	3	2	2	2	2
1000	379	215	144	105	81	66	54	46	40	31	23	15	11	9	7	6	4	3	3	2	2	2
1100	417	236	158	116	90	72	60	51	44	34	25	17	12	9	8	6	5	4	3	2	2	2
1200	455	258	172	126	98	79	65	55	48	37	27	18	13	10	8	7	5	4	3	3	2	2
1300	493	279	187	137	106	85	71	60	52	40	29	20	14	11	9	7	5	4	3	3	2	2
1400	531	301	201	147	114	92	76	65	56	43	32	21	15	12	10	8	6	5	4	3	3	2
1500	568	322	215	158	122	98	82	69	60	46	34	23	17	13	10	9	6	5	4	3	3	2
1600	606	344	230	168	130	105	87	74	64	49	36	24	18	14	11	9	7	5	4	3	3	3
1700	644	365	244	179	138	112	92	78	68	52	38	26	19	15	12	10	7	6	4	4	3	3
1800	682	387	258	189	147	118	98	83	72	56	41	27	20	15	12	10	8	6	5	4	3	3
1900	720	408	273	200	155	125	103	88	76	59	43	29	21	16	13	11	8	6	5	4	3	3
2000	758	430	287	210	163	131	109	92	80	62	45	30	22	17	14	11	8	6	5	4	4	3
2500	947	537	359	263	203	164	136	115	100	77	56	38	28	21	17	14	10	8	7	5	5	4
3000	1137	644	431	315	244	197	163	138	119	93	68	45	33	26	21	17	13	10	8	6	6	5
3500	1326	752	503	368	285	230	190	161	139	108	79	53	39	30	24	20	15	11	9	8	6	6
4000	1516	859	574	420	326	262	218	185	159	123	90	60	44	34	28	23	17	13	10	9	7	6
4500	1705	967	646	473	366	295	245	208	179	139	102	68	50	38	31	26	19	15	12	10	8	7
5000	1895	1074	718	525	407	328	272	231	199	154	113	75	55	43	34	29	21	16	13	11	9	8

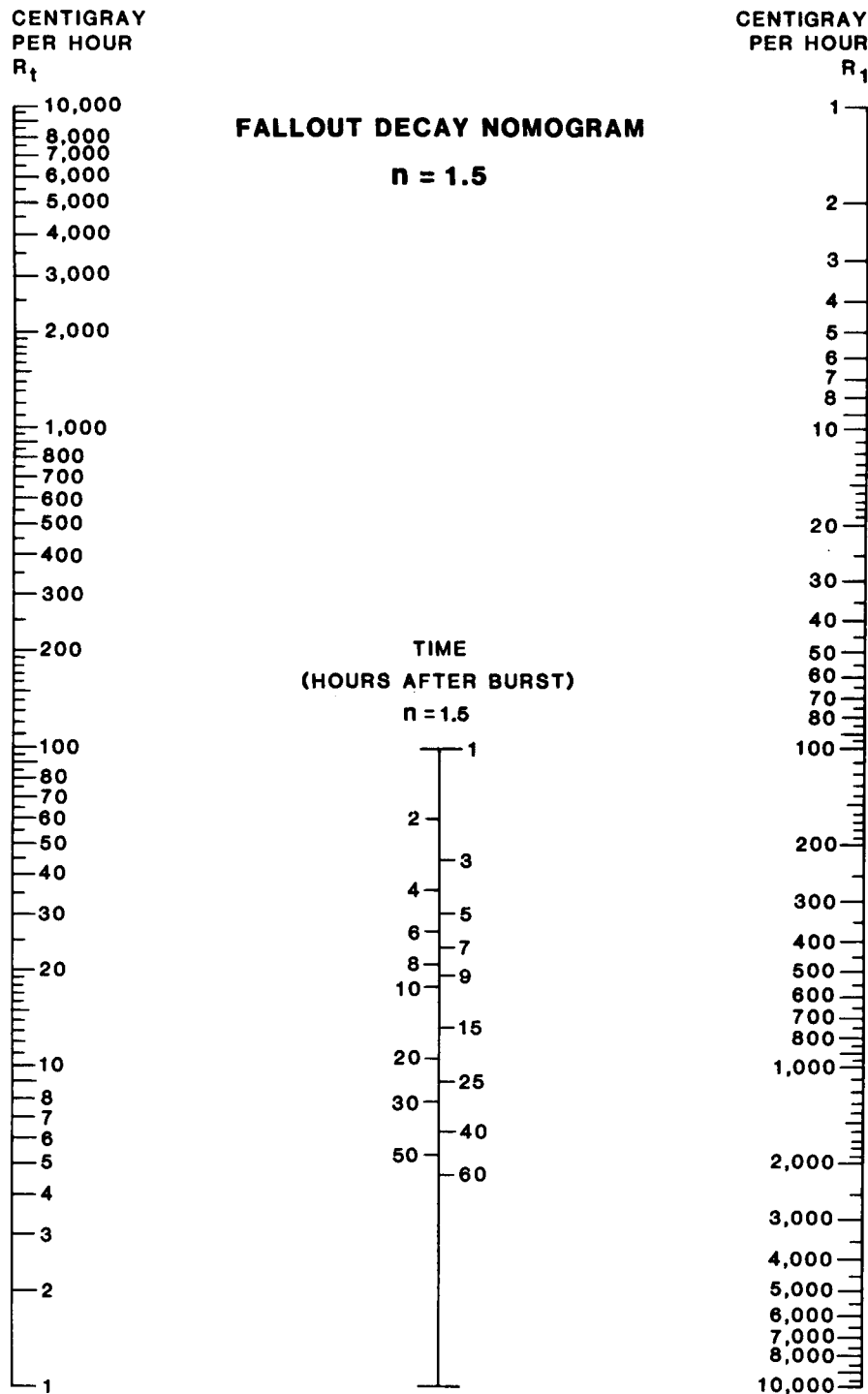

Figure E-20. Fallout decay nomogram  $n = 1.5$ .

Table E-18. Fallout decay table  $n = 1.5$ .

Centigray per hour (R1)	TIME (HOURS AFTER BURST)																					
	2	3	4	5	6	7	8	9	10	12	15	20	25	30	35	40	45	50	55	60	65	70
1	0	0	0	0	0	0	0	0	0	0	0	0	0	0	0	0	0	0	0	0	0	0
2	1	0	0	0	0	0	0	0	0	0	0	0	0	0	0	0	0	0	0	0	0	0
3	1	1	0	0	0	0	0	0	0	0	0	0	0	0	0	0	0	0	0	0	0	0
4	1	1	1	0	0	0	0	0	0	0	0	0	0	0	0	0	0	0	0	0	0	0
5	2	1	1	0	0	0	0	0	0	0	0	0	0	0	0	0	0	0	0	0	0	0
6	2	1	1	1	0	0	0	0	0	0	0	0	0	0	0	0	0	0	0	0	0	0
7	2	1	1	1	0	0	0	0	0	0	0	0	0	0	0	0	0	0	0	0	0	0
8	3	2	1	1	1	0	0	0	0	0	0	0	0	0	0	0	0	0	0	0	0	0
9	3	2	1	1	1	0	0	0	0	0	0	0	0	0	0	0	0	0	0	0	0	0
10	4	2	1	1	1	1	0	0	0	0	0	0	0	0	0	0	0	0	0	0	0	0
15	5	3	2	1	1	1	1	1	1	0	0	0	0	0	0	0	0	0	0	0	0	0
20	7	4	3	2	1	1	1	1	1	0	0	0	0	0	0	0	0	0	0	0	0	0
25	9	5	3	2	2	1	1	1	1	1	0	0	0	0	0	0	0	0	0	0	0	0
30	11	6	4	3	2	2	1	1	1	1	0	0	0	0	0	0	0	0	0	0	0	0
35	12	7	4	3	2	2	2	1	1	1	0	0	0	0	0	0	0	0	0	0	0	0
40	14	8	5	4	3	2	2	1	1	1	1	0	0	0	0	0	0	0	0	0	0	0
45	16	9	6	4	3	2	2	2	1	1	1	0	0	0	0	0	0	0	0	0	0	0
50	18	10	6	4	3	3	2	2	2	1	1	0	0	0	0	0	0	0	0	0	0	0
60	21	12	8	5	4	3	3	2	2	1	1	0	0	0	0	0	0	0	0	0	0	0
70	25	13	9	6	5	4	3	3	2	2	1	1	0	0	0	0	0	0	0	0	0	0
80	28	15	10	7	5	4	4	3	3	2	1	1	0	0	0	0	0	0	0	0	0	0
90	32	17	11	8	6	5	4	3	3	2	2	1	1	1	0	0	0	0	0	0	0	0
100	35	19	13	9	7	5	4	4	3	2	2	1	1	1	0	0	0	0	0	0	0	0
150	53	29	19	13	10	8	7	6	5	4	3	2	1	1	1	1	0	0	0	0	0	0
200	71	38	25	18	14	11	9	7	6	5	3	2	2	1	1	1	1	0	0	0	0	0
250	88	48	31	22	17	13	11	9	8	6	4	3	2	2	1	1	1	1	1	0	0	0
300	106	58	38	27	20	16	13	11	9	7	5	3	2	2	1	1	1	1	1	1	1	1
350	124	67	44	31	24	19	15	13	11	8	6	4	3	2	2	1	1	1	1	1	1	1
400	141	77	50	36	27	22	18	15	13	10	7	4	3	2	2	2	1	1	1	1	1	1
450	159	87	56	40	31	24	20	17	14	11	8	5	4	3	2	2	1	1	1	1	1	1
500	177	96	63	45	34	27	22	19	16	12	9	6	4	3	2	2	2	1	1	1	1	1
550	194	106	69	49	37	30	24	20	17	13	9	6	4	3	3	2	2	2	1	1	1	1
600	212	115	75	54	41	32	27	22	19	14	10	7	5	4	3	2	2	2	1	1	1	1
650	230	125	81	58	44	35	29	24	21	16	11	7	5	4	3	3	2	2	2	1	1	1
700	247	135	88	63	48	38	31	26	22	17	12	8	6	4	3	3	2	2	2	2	1	1
750	265	144	94	67	51	40	33	28	24	18	13	8	6	5	4	3	2	2	2	2	1	1
800	283	154	100	72	54	43	35	30	25	19	14	9	6	5	4	3	3	2	2	2	2	1
850	301	164	106	78	58	46	38	31	27	20	15	10	7	5	4	3	3	2	2	2	2	1
900	318	173	113	80	61	49	40	33	28	22	15	10	7	5	4	3	3	2	2	2	2	2
950	336	183	119	85	65	51	42	35	30	23	16	11	8	6	5	4	3	3	2	2	2	2
1000	354	192	125	89	68	54	44	37	32	24	17	11	8	6	5	4	3	3	2	2	2	2
1100	389	212	138	98	75	59	49	41	35	26	19	12	9	7	5	4	4	3	3	2	2	2
1200	424	231	150	107	82	65	53	44	38	29	21	13	10	7	6	5	4	3	3	3	2	2
1300	460	250	163	116	88	70	57	48	41	31	22	15	10	8	6	5	4	4	3	3	3	2
1400	495	269	175	125	95	76	62	52	44	34	24	16	11	9	7	6	5	4	3	3	3	2
1500	530	289	188	134	102	81	66	56	47	36	26	17	12	9	7	6	5	4	4	3	3	3
1600	566	308	200	143	109	86	71	59	51	38	28	18	13	10	8	6	5	5	4	3	3	3
1700	601	327	213	152	116	92	75	63	54	41	29	19	14	10	8	7	6	5	4	4	3	3
1800	636	346	225	161	122	97	80	67	57	43	31	20	14	11	9	7	6	5	4	4	3	3
1900	672	366	238	170	129	103	84	70	60	46	33	21	15	12	9	8	6	5	5	4	4	3
2000	707	385	250	179	136	108	88	74	63	48	34	22	16	12	10	8	7	6	5	4	4	3
2500	884	481	313	224	170	135	110	93	79	60	43	28	20	15	12	10	8	7	6	5	5	4
3000	1061	577	375	268	204	162	133	111	95	72	52	34	24	18	14	12	10	8	7	6	6	5
3500	1237	674	438	313	238	189	155	130	111	84	60	39	28	21	17	14	12	10	9	8	7	6
4000	1414	770	500	358	272	216	177	148	126	96	69	45	32	24	19	16	13	11	10	9	8	7
4500	1591	866	563	402	306	243	199	167	142	108	77	50	36	27	22	18	15	13	11	10	9	8
5000	1768	962	625	447	340	270	221	185	158	120	86	56	40	30	24	20	17	14	12	11	10	9

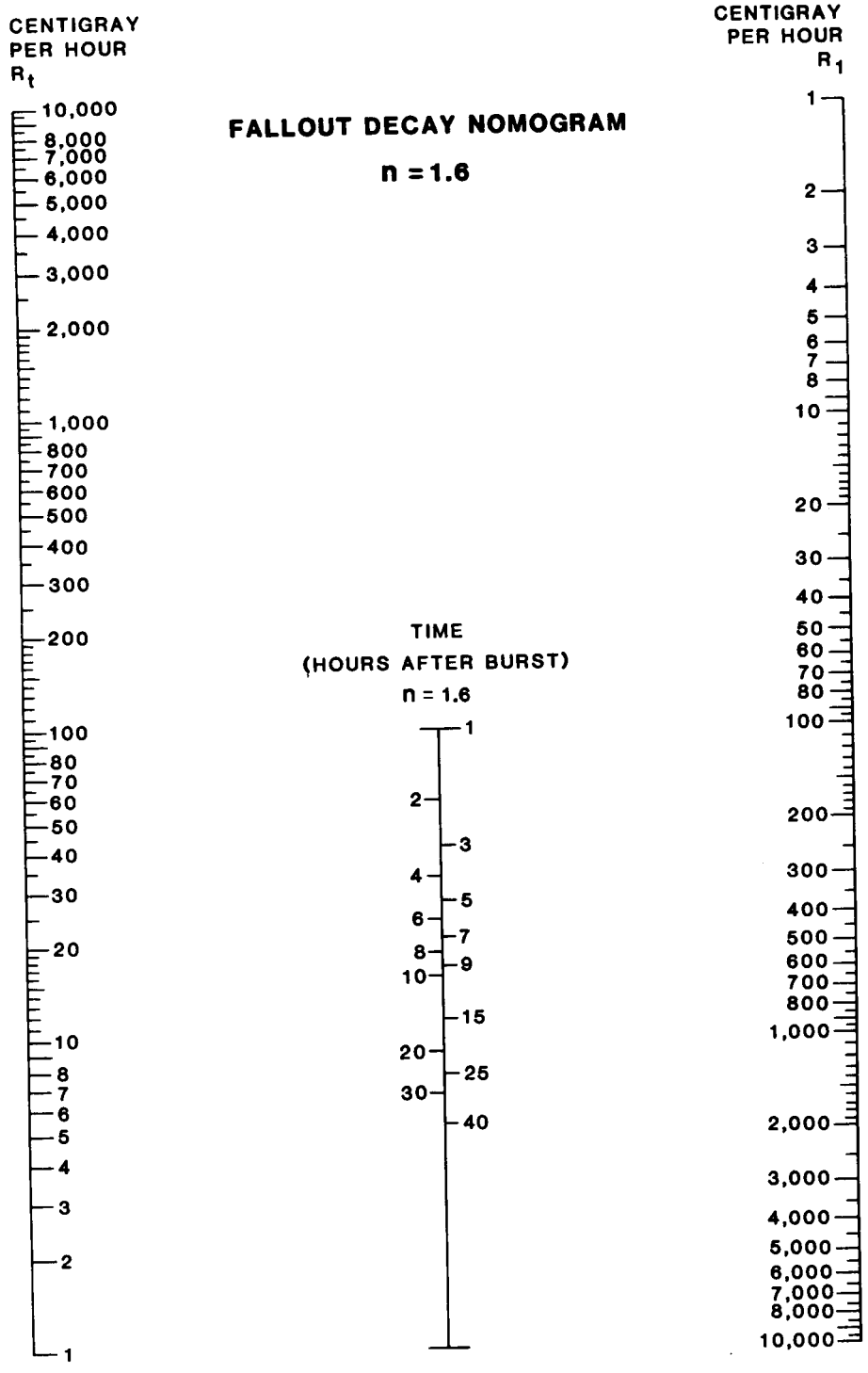

Figure E-21. Fallout decay nomogram  $n = 1.6$ .

Table E-19. Fallout decay table  $n = 1.6$ .

Centigray per hour (R1)	TIME (HOURS AFTER BURST)																					
	2	3	4	5	6	7	8	9	10	11	12	13	14	15	18	20	24	28	30	36	40	48
1	0	0	0	0	0	0	0	0	0	0	0	0	0	0	0	0	0	0	0	0	0	0
2	1	0	0	0	0	0	0	0	0	0	0	0	0	0	0	0	0	0	0	0	0	0
3	1	1	0	0	0	0	0	0	0	0	0	0	0	0	0	0	0	0	0	0	0	0
4	1	1	0	0	0	0	0	0	0	0	0	0	0	0	0	0	0	0	0	0	0	0
5	2	1	1	0	0	0	0	0	0	0	0	0	0	0	0	0	0	0	0	0	0	0
6	2	1	1	0	0	0	0	0	0	0	0	0	0	0	0	0	0	0	0	0	0	0
7	2	1	1	1	0	0	0	0	0	0	0	0	0	0	0	0	0	0	0	0	0	0
8	3	1	1	1	0	0	0	0	0	0	0	0	0	0	0	0	0	0	0	0	0	0
9	3	2	1	1	1	0	0	0	0	0	0	0	0	0	0	0	0	0	0	0	0	0
10	3	2	1	1	1	0	0	0	0	0	0	0	0	0	0	0	0	0	0	0	0	0
15	5	3	2	1	1	1	1	0	0	0	0	0	0	0	0	0	0	0	0	0	0	0
20	7	3	2	2	1	1	1	1	1	0	0	0	0	0	0	0	0	0	0	0	0	0
25	8	4	3	2	1	1	1	1	1	1	0	0	0	0	0	0	0	0	0	0	0	0
30	10	5	3	2	2	1	1	1	1	1	1	0	0	0	0	0	0	0	0	0	0	0
35	12	6	4	3	2	2	1	1	1	1	1	1	1	0	0	0	0	0	0	0	0	0
40	13	7	4	3	2	2	1	1	1	1	1	1	1	1	0	0	0	0	0	0	0	0
45	15	8	5	3	3	2	2	1	1	1	1	1	1	1	0	0	0	0	0	0	0	0
50	16	9	5	4	3	2	2	1	1	1	1	1	1	1	0	0	0	0	0	0	0	0
60	20	10	7	5	3	3	2	2	2	1	1	1	1	1	1	0	0	0	0	0	0	0
70	23	12	8	5	4	3	3	2	2	2	1	1	1	1	1	0	0	0	0	0	0	0
80	26	14	9	6	5	4	3	2	2	2	2	1	1	1	1	0	0	0	0	0	0	0
90	30	16	10	7	5	4	3	3	2	2	2	1	1	1	1	1	0	0	0	0	0	0
100	33	17	11	8	6	4	4	3	3	2	2	2	1	1	1	1	0	0	0	0	0	0
150	49	26	16	11	9	7	5	4	4	3	3	2	2	2	1	1	1	1	1	0	0	0
200	66	34	22	15	11	9	7	6	5	4	4	3	3	3	2	2	1	1	1	1	1	0
250	82	43	27	19	14	11	9	7	6	5	5	4	4	3	2	2	2	1	1	1	1	1
300	99	52	33	23	17	13	11	9	8	6	6	5	4	4	3	2	2	1	1	1	1	1
350	115	60	38	27	20	16	13	10	9	8	7	6	5	5	3	3	2	2	2	1	1	1
400	132	69	44	30	23	18	14	12	10	9	8	7	6	5	4	3	2	2	2	1	1	1
450	148	78	49	34	26	20	16	13	11	10	8	7	7	6	4	4	3	2	2	1	1	1
500	165	86	54	38	28	22	18	15	13	11	9	8	7	7	5	4	3	2	2	2	1	1
550	181	95	60	42	31	24	20	16	14	12	10	9	8	7	5	5	3	3	2	2	2	1
600	198	103	65	46	34	27	22	18	15	13	11	10	9	8	6	5	4	3	3	2	2	1
650	214	112	71	49	37	29	23	19	16	14	12	11	10	9	6	5	4	3	3	2	2	1
700	231	121	76	53	40	31	25	21	18	15	13	12	10	9	7	6	4	3	3	2	2	1
750	247	129	82	57	43	33	27	22	19	16	14	12	11	10	7	6	5	4	3	2	2	2
800	264	138	87	61	46	36	29	24	20	17	15	13	12	11	8	7	5	4	3	3	2	2
850	280	147	92	65	48	38	31	25	21	18	16	14	12	11	8	7	5	4	4	3	2	2
900	297	155	98	69	51	40	32	27	23	19	17	15	13	12	9	7	6	4	4	3	2	2
950	313	164	103	72	54	42	34	28	24	20	18	16	14	12	9	8	6	5	4	3	3	2
1000	330	172	109	76	57	44	36	30	25	22	19	17	15	13	10	8	6	5	4	3	3	2
1100	363	190	120	84	63	49	39	33	28	24	21	18	16	14	11	9	7	5	5	4	3	2
1200	396	207	131	91	68	53	43	36	30	26	23	20	18	16	12	10	7	6	5	4	3	2
1300	429	224	141	99	74	58	47	39	33	28	24	21	19	17	13	11	8	6	6	4	4	3
1400	462	241	152	107	80	62	50	42	35	30	26	23	21	18	14	12	9	7	6	5	4	3
1500	495	259	163	114	85	67	54	45	38	32	28	25	22	20	15	12	9	7	6	5	4	3
1600	528	276	174	122	91	71	57	48	40	35	30	26	23	21	16	13	10	8	7	5	4	3
1700	561	293	185	129	97	76	61	51	43	37	32	28	25	22	17	14	11	8	7	6	5	3
1800	594	310	196	137	102	80	65	54	45	39	34	30	26	24	18	15	11	9	8	6	5	4
1900	627	328	207	145	108	84	68	56	48	41	36	31	28	25	19	16	12	9	8	6	5	4
2000	660	345	218	152	114	89	72	59	50	43	38	33	29	26	20	17	12	10	9	6	5	4
2500	825	431	272	190	142	111	90	74	63	54	47	41	37	33	25	21	15	12	11	8	7	5
3000	990	517	326	228	171	133	108	89	75	65	56	50	44	39	29	25	19	15	13	10	8	6
3500	1155	603	381	267	199	156	126	104	88	75	66	58	51	46	34	29	22	17	15	11	10	7
4000	1320	690	435	305	228	178	144	119	100	86	75	66	59	53	39	33	25	19	17	13	11	8
4500	1484	776	490	343	256	200	162	134	113	97	84	74	66	59	44	37	28	22	19	15	12	9
5000	1649	862	544	381	284	222	179	149	126	108	94	83	73	66	49	41	31	24	22	16	14	10

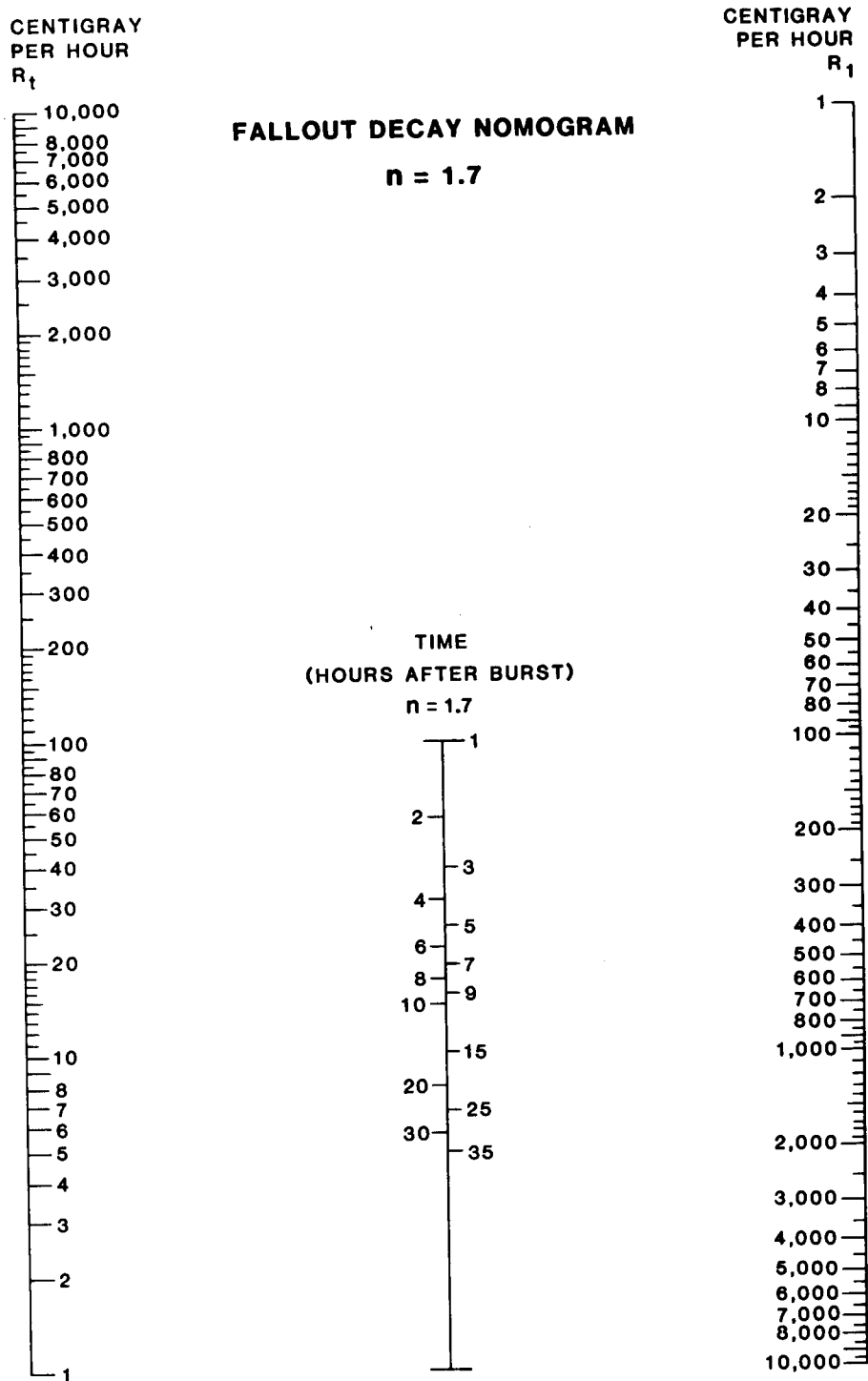

Figure E-22. Fallout decay nomogram  $n = 1.7$ .

Table E-20. Fallout decay table  $n = 1.7$ .

Centigray per hour (R1)	TIME (HOURS AFTER BURST)																					
	2	3	4	5	6	7	8	9	10	11	12	13	14	15	18	20	24	28	30	36	40	48
1	0	0	0	0	0	0	0	0	0	0	0	0	0	0	0	0	0	0	0	0	0	0
2	1	0	0	0	0	0	0	0	0	0	0	0	0	0	0	0	0	0	0	0	0	0
3	1	0	0	0	0	0	0	0	0	0	0	0	0	0	0	0	0	0	0	0	0	0
4	1	1	0	0	0	0	0	0	0	0	0	0	0	0	0	0	0	0	0	0	0	0
5	2	1	0	0	0	0	0	0	0	0	0	0	0	0	0	0	0	0	0	0	0	0
6	2	1	1	0	0	0	0	0	0	0	0	0	0	0	0	0	0	0	0	0	0	0
7	2	1	1	0	0	0	0	0	0	0	0	0	0	0	0	0	0	0	0	0	0	0
8	2	1	1	1	0	0	0	0	0	0	0	0	0	0	0	0	0	0	0	0	0	0
9	3	1	1	1	0	0	0	0	0	0	0	0	0	0	0	0	0	0	0	0	0	0
10	3	2	1	1	0	0	0	0	0	0	0	0	0	0	0	0	0	0	0	0	0	0
15	5	2	1	1	1	1	0	0	0	0	0	0	0	0	0	0	0	0	0	0	0	0
20	6	3	2	1	1	1	1	0	0	0	0	0	0	0	0	0	0	0	0	0	0	0
25	8	4	2	2	1	1	1	1	0	0	0	0	0	0	0	0	0	0	0	0	0	0
30	9	5	3	2	1	1	1	1	1	1	0	0	0	0	0	0	0	0	0	0	0	0
35	11	5	3	2	2	1	1	1	1	1	1	0	0	0	0	0	0	0	0	0	0	0
40	12	6	4	3	2	1	1	1	1	1	1	1	0	0	0	0	0	0	0	0	0	0
45	14	7	4	3	2	2	1	1	1	1	1	1	1	0	0	0	0	0	0	0	0	0
50	15	8	5	3	2	2	1	1	1	1	1	1	1	1	0	0	0	0	0	0	0	0
60	18	9	6	4	3	2	2	1	1	1	1	1	1	1	0	0	0	0	0	0	0	0
70	22	11	7	5	3	3	2	2	1	1	1	1	1	1	0	0	0	0	0	0	0	0
80	25	12	8	5	4	3	2	2	2	1	1	1	1	1	1	0	0	0	0	0	0	0
90	28	14	9	6	4	3	3	2	2	2	1	1	1	1	1	0	0	0	0	0	0	0
100	31	15	9	6	5	4	3	2	2	2	1	1	1	1	1	0	0	0	0	0	0	0
150	46	23	14	10	7	5	4	4	3	3	2	2	2	2	1	1	1	1	0	0	0	0
200	62	31	19	13	10	7	6	5	4	3	3	3	2	2	1	1	1	1	0	0	0	0
250	77	39	24	16	12	9	7	6	5	4	4	3	3	3	2	2	1	1	1	0	0	0
300	92	46	28	19	14	11	9	7	6	5	4	4	3	3	2	2	1	1	1	1	0	0
350	108	54	33	23	17	13	10	8	7	6	5	4	4	3	3	2	2	1	1	1	1	0
400	123	62	38	26	19	15	12	10	8	7	6	5	5	4	3	2	2	1	1	1	1	1
450	139	70	43	29	21	16	13	11	9	8	7	6	5	5	3	3	2	2	1	1	1	1
500	154	77	47	32	24	18	15	12	10	8	7	6	6	5	4	3	2	2	2	1	1	1
550	169	85	52	36	26	20	16	13	11	9	8	7	6	6	4	3	2	2	2	1	1	1
600	185	93	57	39	29	22	17	14	12	10	9	8	7	6	4	4	3	2	2	1	1	1
650	200	100	62	42	31	24	19	16	13	11	10	8	7	7	5	4	3	2	2	1	1	1
700	215	108	66	45	33	26	20	17	14	12	10	9	8	7	5	4	3	2	2	2	1	1
750	231	116	71	49	36	27	22	18	15	13	11	10	8	8	6	5	3	3	2	2	1	1
800	246	124	76	52	38	29	23	19	16	14	12	10	9	8	6	5	4	3	2	2	2	1
850	262	131	81	55	40	31	25	20	17	14	12	11	10	9	6	5	4	3	3	2	2	1
900	277	139	85	58	43	33	26	21	18	15	13	11	10	9	7	6	4	3	3	2	2	1
950	292	147	90	62	45	35	28	23	19	16	14	12	11	10	7	6	4	3	3	2	2	1
1000	308	154	95	65	48	37	29	24	20	17	15	13	11	10	7	6	5	3	3	2	2	1
1100	339	170	104	71	52	40	32	26	22	19	16	14	12	11	8	7	5	4	3	2	2	2
1200	369	185	114	78	57	44	35	29	24	20	18	15	14	12	9	7	5	4	4	3	2	2
1300	400	201	123	84	62	48	38	31	26	22	19	17	15	13	10	8	6	5	4	3	2	2
1400	431	216	133	91	67	51	41	33	28	24	20	18	16	14	10	9	6	5	4	3	3	2
1500	462	232	142	97	71	55	44	36	30	25	22	19	17	15	11	9	7	5	5	3	3	2
1600	492	247	152	104	76	59	47	38	32	27	23	20	18	16	12	10	7	6	5	4	3	2
1700	523	263	161	110	81	62	50	41	34	29	25	22	19	17	12	10	8	6	5	4	3	2
1800	554	278	171	117	86	66	52	43	36	31	26	23	20	18	13	11	8	6	6	4	3	2
1900	585	294	180	123	90	70	55	45	38	32	26	24	21	19	14	12	9	7	6	4	4	3
2000	616	309	189	130	95	73	58	48	40	34	29	26	23	20	15	12	9	7	6	5	4	3
2500	769	386	237	162	119	91	73	60	50	42	37	32	28	25	18	15	11	9	8	6	5	3
3000	923	463	284	194	143	110	87	72	60	51	44	38	34	30	22	18	14	10	9	7	6	4
3500	1077	541	332	227	166	128	102	84	70	59	51	45	39	35	26	21	16	12	11	8	7	5
4000	1231	618	379	259	190	146	117	95	80	68	59	51	45	40	29	25	18	14	12	9	8	6
4500	1385	695	426	292	214	165	131	107	90	76	66	57	51	45	33	28	20	16	14	10	9	6
5000	1539	772	474	324	238	183	146	119	100	85	73	64	56	50	37	31	23	17	15	11	9	7



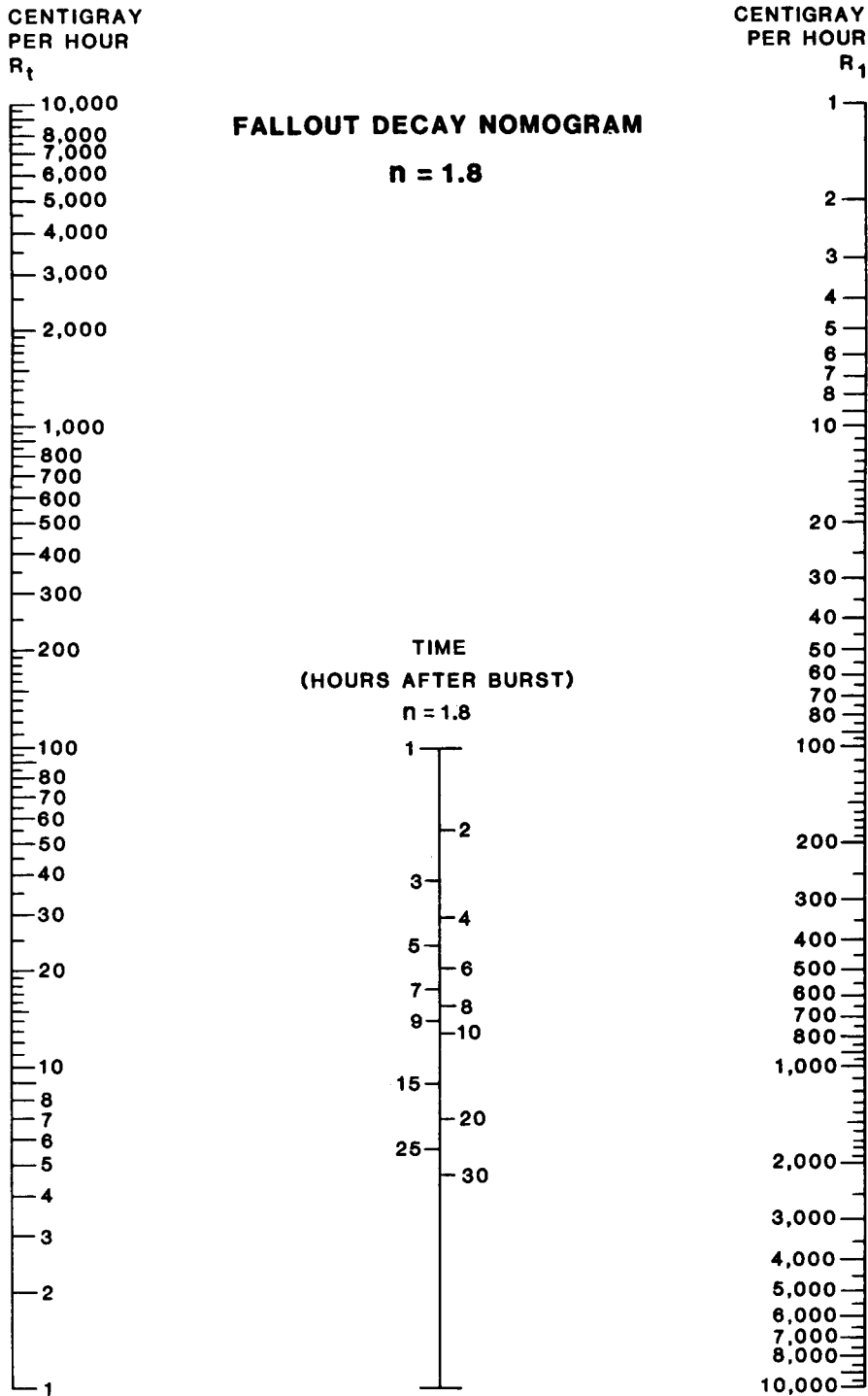

Figure E-23. Fallout decay nomogram  $n = 1.8$ .

Table E-21. Fallout decay table  $n = 1.8$ .

Centigray per hour (R1)	TIME (HOURS AFTER BURST)																					
	2	3	4	5	6	7	8	9	10	11	12	13	14	15	18	20	24	28	30	36	40	48
1	0	0	0	0	0	0	0	0	0	0	0	0	0	0	0	0	0	0	0	0	0	0
2	1	0	0	0	0	0	0	0	0	0	0	0	0	0	0	0	0	0	0	0	0	0
3	1	0	0	0	0	0	0	0	0	0	0	0	0	0	0	0	0	0	0	0	0	0
4	1	1	0	0	0	0	0	0	0	0	0	0	0	0	0	0	0	0	0	0	0	0
5	1	1	0	0	0	0	0	0	0	0	0	0	0	0	0	0	0	0	0	0	0	0
6	2	1	0	0	0	0	0	0	0	0	0	0	0	0	0	0	0	0	0	0	0	0
7	2	1	1	0	0	0	0	0	0	0	0	0	0	0	0	0	0	0	0	0	0	0
8	2	1	1	0	0	0	0	0	0	0	0	0	0	0	0	0	0	0	0	0	0	0
9	3	1	1	0	0	0	0	0	0	0	0	0	0	0	0	0	0	0	0	0	0	0
10	3	1	1	1	0	0	0	0	0	0	0	0	0	0	0	0	0	0	0	0	0	0
15	4	2	1	1	1	0	0	0	0	0	0	0	0	0	0	0	0	0	0	0	0	0
20	6	3	2	1	1	1	0	0	0	0	0	0	0	0	0	0	0	0	0	0	0	0
25	7	3	2	1	1	1	1	0	0	0	0	0	0	0	0	0	0	0	0	0	0	0
30	9	4	2	2	1	1	1	1	0	0	0	0	0	0	0	0	0	0	0	0	0	0
35	10	5	3	2	1	1	1	1	1	0	0	0	0	0	0	0	0	0	0	0	0	0
40	11	6	3	2	2	1	1	1	1	1	0	0	0	0	0	0	0	0	0	0	0	0
45	13	6	4	2	2	1	1	1	1	1	1	0	0	0	0	0	0	0	0	0	0	0
50	14	7	4	3	2	2	1	1	1	1	1	0	0	0	0	0	0	0	0	0	0	0
60	17	8	5	3	2	2	1	1	1	1	1	1	1	0	0	0	0	0	0	0	0	0
70	20	10	6	4	3	2	2	1	1	1	1	1	1	1	0	0	0	0	0	0	0	0
80	23	11	7	4	3	2	2	2	1	1	1	1	1	1	0	0	0	0	0	0	0	0
90	26	12	7	5	4	3	2	2	1	1	1	1	1	1	0	0	0	0	0	0	0	0
100	29	14	8	6	4	3	2	2	2	1	1	1	1	1	1	0	0	0	0	0	0	0
150	43	21	12	8	6	5	4	3	2	2	2	1	1	1	1	0	0	0	0	0	0	0
200	57	28	16	11	8	6	5	4	3	3	2	2	2	2	1	1	1	0	0	0	0	0
250	72	35	21	14	10	8	6	5	4	3	3	2	2	2	1	1	1	1	0	0	0	0
300	86	42	25	17	12	9	7	6	5	4	3	3	3	2	2	1	1	1	1	0	0	0
350	101	48	29	19	14	11	8	7	6	5	4	3	3	3	2	2	1	1	1	1	0	0
400	115	55	33	22	16	12	9	8	6	5	5	4	3	3	2	2	1	1	1	1	1	0
450	129	62	37	25	18	14	11	9	7	6	5	4	4	3	2	2	1	1	1	1	1	0
500	144	69	41	28	20	15	12	10	8	7	6	5	4	4	3	2	2	1	1	1	1	0
550	158	76	45	30	22	17	13	11	9	7	6	5	4	4	3	2	2	1	1	1	1	1
600	172	83	49	33	24	18	14	11	10	8	7	6	5	5	3	3	2	1	1	1	1	1
650	187	90	54	36	26	20	15	12	10	9	7	6	6	5	4	3	2	2	1	1	1	1
700	201	97	58	39	28	21	17	13	11	9	8	7	6	5	4	3	2	2	2	1	1	1
750	215	104	62	41	30	23	18	14	12	10	9	7	6	6	4	3	2	2	2	1	1	1
800	230	111	66	44	32	24	19	15	13	11	9	8	7	6	4	4	3	2	2	1	1	1
850	244	118	70	47	34	26	20	16	13	11	10	8	7	6	5	4	3	2	2	1	1	1
900	258	125	74	50	36	27	21	17	14	12	10	9	8	7	5	4	3	2	2	1	1	1
950	273	131	78	52	38	29	22	18	15	13	11	9	8	7	5	4	3	2	2	2	1	1
1000	287	138	82	55	40	30	24	19	16	13	11	10	9	8	6	5	3	2	2	2	1	1
1100	316	152	91	61	44	33	26	21	17	15	13	11	10	8	6	5	4	3	2	2	1	1
1200	345	166	99	66	48	36	28	23	19	16	14	12	10	9	7	5	4	3	3	2	2	1
1300	373	180	107	72	52	39	31	25	21	17	15	13	11	10	7	6	4	3	3	2	2	1
1400	402	194	115	77	56	42	33	27	22	19	16	14	12	11	8	6	5	3	3	2	2	1
1500	431	208	124	83	60	45	36	29	24	20	17	15	13	11	8	7	5	4	3	2	2	1
1600	459	221	132	88	64	48	38	31	25	21	18	16	14	12	9	7	5	4	4	3	2	2
1700	488	235	140	94	68	51	40	33	27	23	19	17	15	13	9	8	6	4	4	3	2	2
1800	517	249	148	99	72	54	43	34	29	24	21	18	16	14	10	8	6	4	4	3	2	2
1900	546	263	157	105	76	57	45	36	30	25	22	19	16	15	10	9	6	5	4	3	2	2
2000	574	277	165	110	79	60	47	38	32	27	23	20	17	15	11	9	7	5	4	3	3	2
2500	718	346	206	138	99	75	59	48	40	33	29	25	22	19	14	11	8	6	5	4	3	2
3000	862	415	247	166	119	90	71	57	48	40	34	30	26	23	17	14	10	7	7	5	4	3
3500	1005	484	289	193	139	105	83	67	55	47	40	35	30	27	19	16	11	9	8	6	5	3
4000	1149	554	330	221	159	120	95	77	63	53	46	40	35	31	22	18	13	10	9	6	5	4
4500	1292	623	371	248	179	136	107	86	71	60	51	44	39	34	25	20	15	11	10	7	6	4
5000	1436	692	412	276	199	151	118	96	79	67	57	49	43	38	28	23	16	12	11	8	7	5

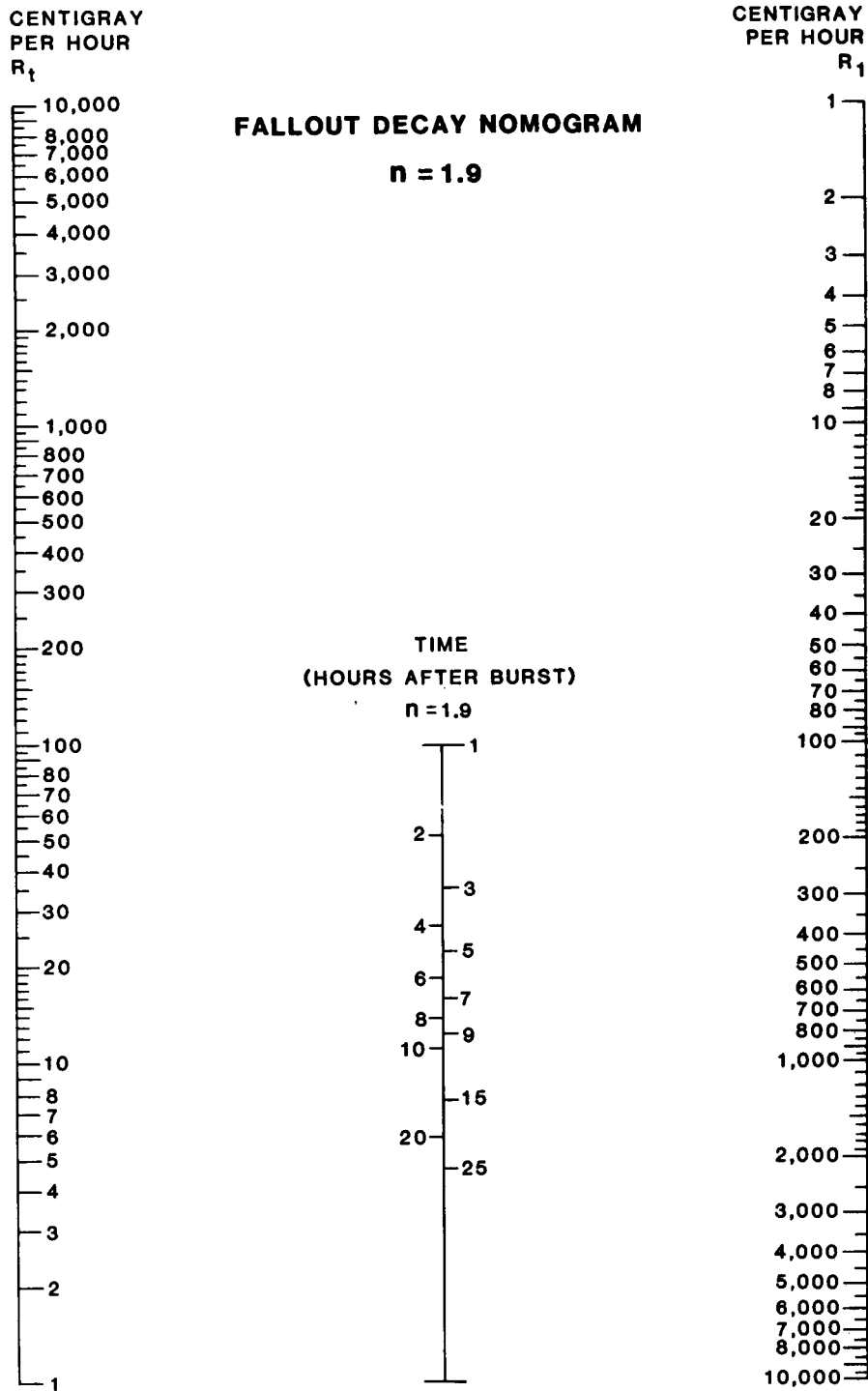

Figure E-24. Fallout decay nomogram  $n = 1.9$ .

Table E-22. Fallout decay table  $n = 1.9$ .

Centigray per hour (R1)	TIME (HOURS AFTER BURST)																					
	2	3	4	5	6	7	8	9	10	11	12	13	14	15	16	17	18	19	20	22	24	30
1	0	0	0	0	0	0	0	0	0	0	0	0	0	0	0	0	0	0	0	0	0	0
2	1	0	0	0	0	0	0	0	0	0	0	0	0	0	0	0	0	0	0	0	0	0
3	1	0	0	0	0	0	0	0	0	0	0	0	0	0	0	0	0	0	0	0	0	0
4	1	0	0	0	0	0	0	0	0	0	0	0	0	0	0	0	0	0	0	0	0	0
5	1	1	0	0	0	0	0	0	0	0	0	0	0	0	0	0	0	0	0	0	0	0
6	2	1	0	0	0	0	0	0	0	0	0	0	0	0	0	0	0	0	0	0	0	0
7	2	1	1	0	0	0	0	0	0	0	0	0	0	0	0	0	0	0	0	0	0	0
8	2	1	1	0	0	0	0	0	0	0	0	0	0	0	0	0	0	0	0	0	0	0
9	2	1	1	0	0	0	0	0	0	0	0	0	0	0	0	0	0	0	0	0	0	0
10	3	1	1	0	0	0	0	0	0	0	0	0	0	0	0	0	0	0	0	0	0	0
15	4	2	1	1	0	0	0	0	0	0	0	0	0	0	0	0	0	0	0	0	0	0
20	5	2	1	1	1	0	0	0	0	0	0	0	0	0	0	0	0	0	0	0	0	0
25	7	3	2	1	1	1	0	0	0	0	0	0	0	0	0	0	0	0	0	0	0	0
30	8	4	2	1	1	1	1	0	0	0	0	0	0	0	0	0	0	0	0	0	0	0
35	9	4	3	2	1	1	1	1	0	0	0	0	0	0	0	0	0	0	0	0	0	0
40	11	5	3	2	1	1	1	1	1	0	0	0	0	0	0	0	0	0	0	0	0	0
45	12	6	3	2	1	1	1	1	1	1	0	0	0	0	0	0	0	0	0	0	0	0
50	13	6	4	2	2	1	1	1	1	1	0	0	0	0	0	0	0	0	0	0	0	0
60	18	7	4	3	2	1	1	1	1	1	1	0	0	0	0	0	0	0	0	0	0	0
70	19	9	5	3	2	2	1	1	1	1	1	1	0	0	0	0	0	0	0	0	0	0
80	21	10	6	4	3	2	2	1	1	1	1	1	1	0	0	0	0	0	0	0	0	0
90	24	11	6	4	3	2	2	1	1	1	1	1	1	1	0	0	0	0	0	0	0	0
100	27	12	7	5	3	2	2	2	1	1	1	1	1	1	1	0	0	0	0	0	0	0
150	40	19	11	7	5	4	3	2	2	2	1	1	1	1	1	1	1	1	1	0	0	0
200	54	25	14	9	7	5	4	3	3	2	2	2	1	1	1	1	1	1	1	1	0	0
250	67	31	18	12	8	6	5	4	3	3	2	2	2	1	1	1	1	1	1	1	1	0
300	80	37	22	14	10	7	6	5	4	3	3	2	2	2	2	1	1	1	1	1	1	0
350	94	43	25	16	12	9	7	5	4	4	3	3	2	2	2	2	1	1	1	1	1	1
400	107	50	29	19	13	10	8	6	5	4	4	3	3	2	2	2	2	1	1	1	1	1
450	121	56	32	21	15	11	9	7	6	5	4	3	3	3	2	2	2	2	2	1	1	1
500	134	62	36	23	17	12	10	8	6	5	4	4	3	3	3	2	2	2	2	2	1	1
550	147	68	39	26	18	14	11	8	7	6	5	4	4	3	3	3	2	2	2	2	1	1
600	161	74	43	28	20	15	12	9	8	6	5	5	4	3	3	3	2	2	2	2	1	1
650	174	81	47	31	22	16	13	10	8	7	6	5	4	4	3	3	3	2	2	2	2	1
700	188	87	50	33	23	17	13	11	9	7	6	5	5	4	4	3	3	3	2	2	2	1
750	201	93	54	35	25	19	14	12	9	8	7	6	5	4	4	3	3	3	3	2	2	1
800	214	99	57	38	27	20	15	12	10	8	7	6	5	5	4	4	3	3	3	2	2	1
850	228	105	61	40	28	21	16	13	11	9	8	7	6	5	4	4	4	3	3	2	2	1
900	241	112	65	42	30	22	17	14	11	9	8	7	6	5	5	4	4	3	3	3	2	1
950	255	118	68	45	32	24	18	15	12	10	8	7	6	6	5	4	4	4	3	3	2	1
1000	268	124	72	47	33	25	19	15	13	11	9	8	7	6	5	5	4	4	3	3	2	2
1100	295	136	79	52	37	27	21	17	14	12	10	8	7	6	6	5	5	4	4	3	3	2
1200	322	149	86	56	40	30	23	18	15	13	11	9	8	7	6	6	5	4	4	3	3	2
1300	348	161	93	61	43	32	25	20	16	14	12	10	9	8	7	6	5	5	4	4	3	2
1400	375	174	101	66	47	35	27	22	18	15	12	11	9	8	7	6	6	5	5	4	3	2
1500	402	186	108	70	50	37	29	23	19	16	13	11	10	9	8	7	6	6	5	4	4	2
1600	429	198	115	75	53	40	31	25	20	17	14	12	11	9	8	7	7	6	5	5	4	2
1700	456	211	122	80	56	42	33	26	21	18	15	13	11	10	9	8	7	6	6	5	4	3
1800	482	223	129	85	60	45	35	28	23	19	16	14	12	10	9	8	7	7	6	5	4	3
1900	509	236	136	89	63	47	37	29	24	20	17	15	13	11	10	9	8	7	6	5	5	3
2000	536	248	144	94	66	50	38	31	25	21	18	15	13	12	10	9	8	7	7	6	5	3
2500	670	310	179	117	83	62	48	38	31	26	22	19	17	15	13	11	10	9	8	7	6	4
3000	804	372	215	141	100	74	58	46	38	32	27	23	20	17	15	14	12	11	10	8	7	5
3500	938	434	251	164	116	87	67	54	44	37	31	27	23	20	18	16	14	13	12	10	8	5
4000	1072	496	287	188	133	99	77	62	50	42	36	31	27	23	21	18	16	15	13	11	10	6
4500	1206	558	323	211	150	112	87	69	57	47	40	34	30	26	23	21	19	17	15	13	11	7
5000	1340	620	359	235	166	124	96	77	63	53	45	38	33	29	26	23	21	19	17	14	12	8

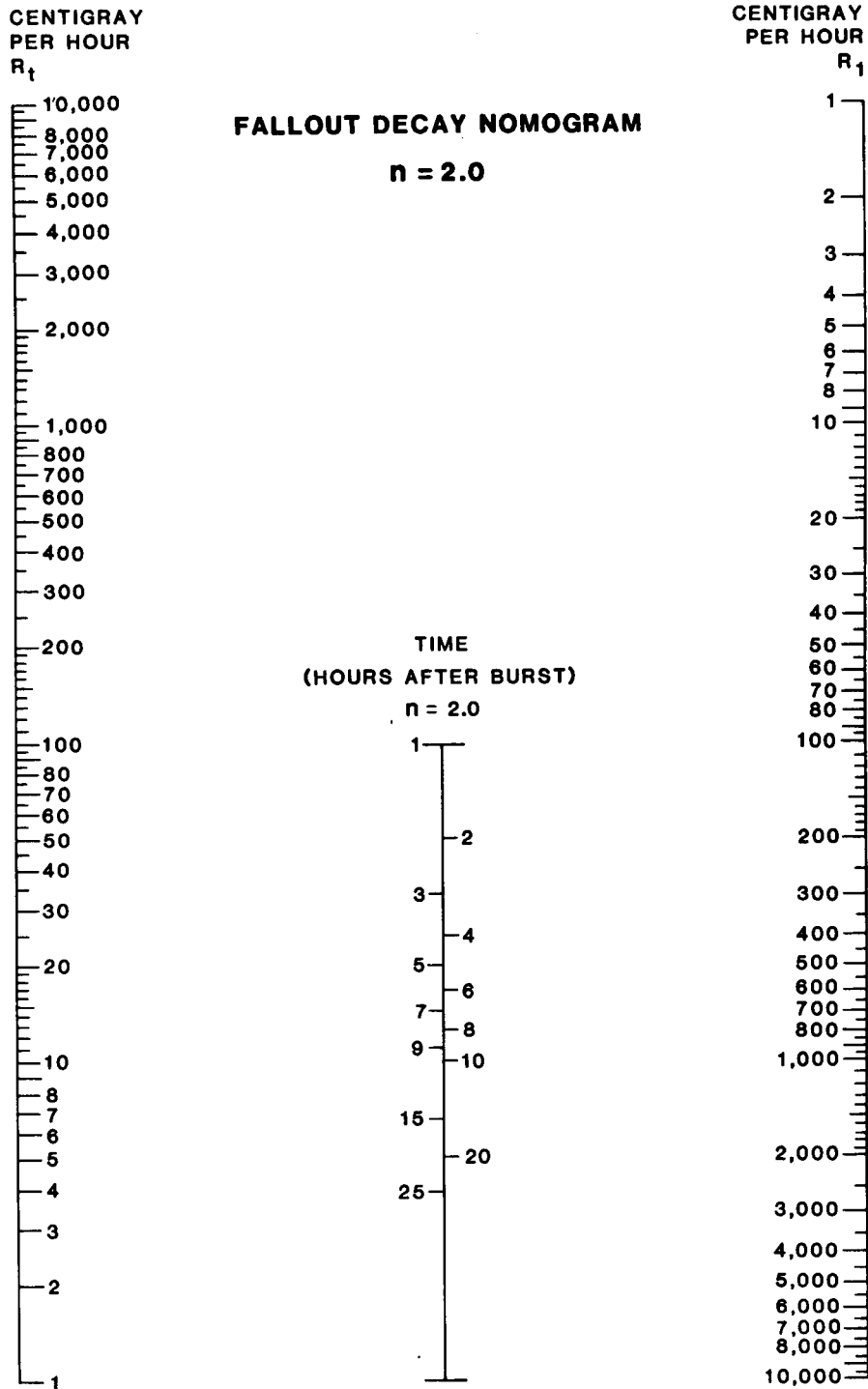

Figure E-25. Fallout decay nomogram n = 2.0.

Table E-23. Fallout decay table  $n = 2.0$ .

Centigray per hour (R1)	TIME (HOURS AFTER BURST)																					
	2	3	4	5	6	7	8	9	10	11	12	13	14	15	16	17	18	19	20	22	24	30
1	0	0	0	0	0	0	0	0	0	0	0	0	0	0	0	0	0	0	0	0	0	0
2	1	0	0	0	0	0	0	0	0	0	0	0	0	0	0	0	0	0	0	0	0	0
3	1	0	0	0	0	0	0	0	0	0	0	0	0	0	0	0	0	0	0	0	0	0
4	1	0	0	0	0	0	0	0	0	0	0	0	0	0	0	0	0	0	0	0	0	0
5	1	1	0	0	0	0	0	0	0	0	0	0	0	0	0	0	0	0	0	0	0	0
6	2	1	0	0	0	0	0	0	0	0	0	0	0	0	0	0	0	0	0	0	0	0
7	2	1	0	0	0	0	0	0	0	0	0	0	0	0	0	0	0	0	0	0	0	0
8	2	1	1	0	0	0	0	0	0	0	0	0	0	0	0	0	0	0	0	0	0	0
9	2	1	1	0	0	0	0	0	0	0	0	0	0	0	0	0	0	0	0	0	0	0
10	3	1	1	0	0	0	0	0	0	0	0	0	0	0	0	0	0	0	0	0	0	0
15	4	2	1	1	0	0	0	0	0	0	0	0	0	0	0	0	0	0	0	0	0	0
20	5	2	1	1	1	0	0	0	0	0	0	0	0	0	0	0	0	0	0	0	0	0
25	6	3	2	1	1	1	0	0	0	0	0	0	0	0	0	0	0	0	0	0	0	0
30	8	3	2	1	1	1	0	0	0	0	0	0	0	0	0	0	0	0	0	0	0	0
35	9	4	2	1	1	1	1	0	0	0	0	0	0	0	0	0	0	0	0	0	0	0
40	10	4	3	2	1	1	1	0	0	0	0	0	0	0	0	0	0	0	0	0	0	0
45	11	5	3	2	1	1	1	1	0	0	0	0	0	0	0	0	0	0	0	0	0	0
50	13	6	3	2	1	1	1	1	1	0	0	0	0	0	0	0	0	0	0	0	0	0
60	15	7	4	2	2	1	1	1	1	0	0	0	0	0	0	0	0	0	0	0	0	0
70	18	8	4	3	2	1	1	1	1	1	0	0	0	0	0	0	0	0	0	0	0	0
80	20	9	5	3	2	2	1	1	1	1	1	0	0	0	0	0	0	0	0	0	0	0
90	23	10	6	4	3	2	1	1	1	1	1	1	0	0	0	0	0	0	0	0	0	0
100	25	11	6	4	3	2	2	1	1	1	1	1	1	0	0	0	0	0	0	0	0	0
150	38	17	9	6	4	3	2	2	2	1	1	1	1	1	1	1	1	1	1	0	0	0
200	50	22	13	8	6	4	3	2	2	2	2	1	1	1	1	1	1	1	1	1	0	0
250	63	28	16	10	7	5	4	3	3	2	2	1	1	1	1	1	1	1	1	1	1	0
300	75	33	19	12	8	6	5	4	3	2	2	2	2	1	1	1	1	1	1	1	1	0
350	88	39	22	14	10	7	5	4	4	3	2	2	2	2	1	1	1	1	1	1	1	0
400	100	44	25	16	11	8	6	5	4	3	2	2	2	2	2	1	1	1	1	1	1	0
450	113	50	28	18	13	9	7	6	5	4	3	3	3	2	2	2	1	1	1	1	1	1
500	125	56	31	20	14	10	8	6	5	4	3	3	3	2	2	2	2	1	1	1	1	1
550	138	61	34	22	15	11	9	7	6	5	4	3	3	2	2	2	2	2	1	1	1	1
600	150	67	38	24	17	12	9	7	6	5	4	4	3	3	2	2	2	2	2	1	1	1
650	163	72	41	26	18	13	10	8	7	5	5	4	3	3	2	2	2	2	2	1	1	1
700	175	78	44	28	19	14	11	9	7	6	5	4	4	3	3	2	2	2	2	1	1	1
750	188	83	47	30	21	15	12	9	8	6	5	4	4	3	3	2	2	2	2	2	1	1
800	200	89	50	32	22	16	13	10	8	7	6	5	4	4	3	3	2	2	2	2	1	1
850	213	94	53	34	24	17	13	10	9	7	6	5	4	4	3	3	3	2	2	2	1	1
900	225	100	56	36	25	18	14	11	9	7	6	5	4	4	3	3	2	2	2	2	2	1
950	238	106	59	38	26	19	15	12	10	8	7	6	5	4	4	3	3	3	2	2	2	1
1000	250	111	63	40	28	20	16	12	10	8	7	6	5	4	4	3	3	3	3	2	2	1
1100	275	122	69	44	31	22	17	14	11	9	8	7	6	5	4	4	3	3	3	2	2	1
1200	300	133	75	48	33	24	19	15	12	10	8	7	6	5	5	4	4	3	3	2	2	1
1300	325	144	81	52	36	27	20	16	13	11	9	8	7	6	5	4	4	4	3	2	2	1
1400	350	156	88	56	39	29	22	17	14	12	10	8	7	6	5	4	4	4	3	2	2	1
1500	375	167	94	60	42	31	23	19	15	12	10	9	8	7	6	5	5	4	4	3	2	1
1600	400	178	100	64	44	33	25	20	16	13	11	9	8	7	6	6	5	4	4	3	2	1
1700	425	189	106	68	47	35	27	21	17	14	12	10	9	8	7	6	5	5	4	3	2	1
1800	450	200	113	72	50	37	28	22	18	15	13	11	9	8	7	6	6	5	4	3	2	1
1900	475	211	119	76	53	39	30	23	19	16	13	11	10	8	7	7	6	5	4	3	2	1
2000	500	222	125	80	56	41	31	25	20	17	14	12	10	9	8	7	6	6	5	4	3	2
2500	625	278	156	100	69	51	39	31	25	21	17	15	13	11	10	9	8	7	6	5	4	3
3000	750	333	188	120	83	61	47	37	30	25	21	18	15	13	12	10	9	8	8	6	5	3
3500	875	389	219	140	97	71	55	43	35	29	24	21	18	16	14	12	11	10	9	7	6	4
4000	1000	444	250	160	111	82	63	49	40	33	28	24	20	18	16	14	12	11	10	8	7	4
4500	1125	500	281	180	125	92	70	56	45	37	31	27	23	20	18	16	14	12	11	9	8	5
5000	1250	556	313	200	139	102	78	62	50	41	35	30	26	22	20	17	15	14	13	10	9	6

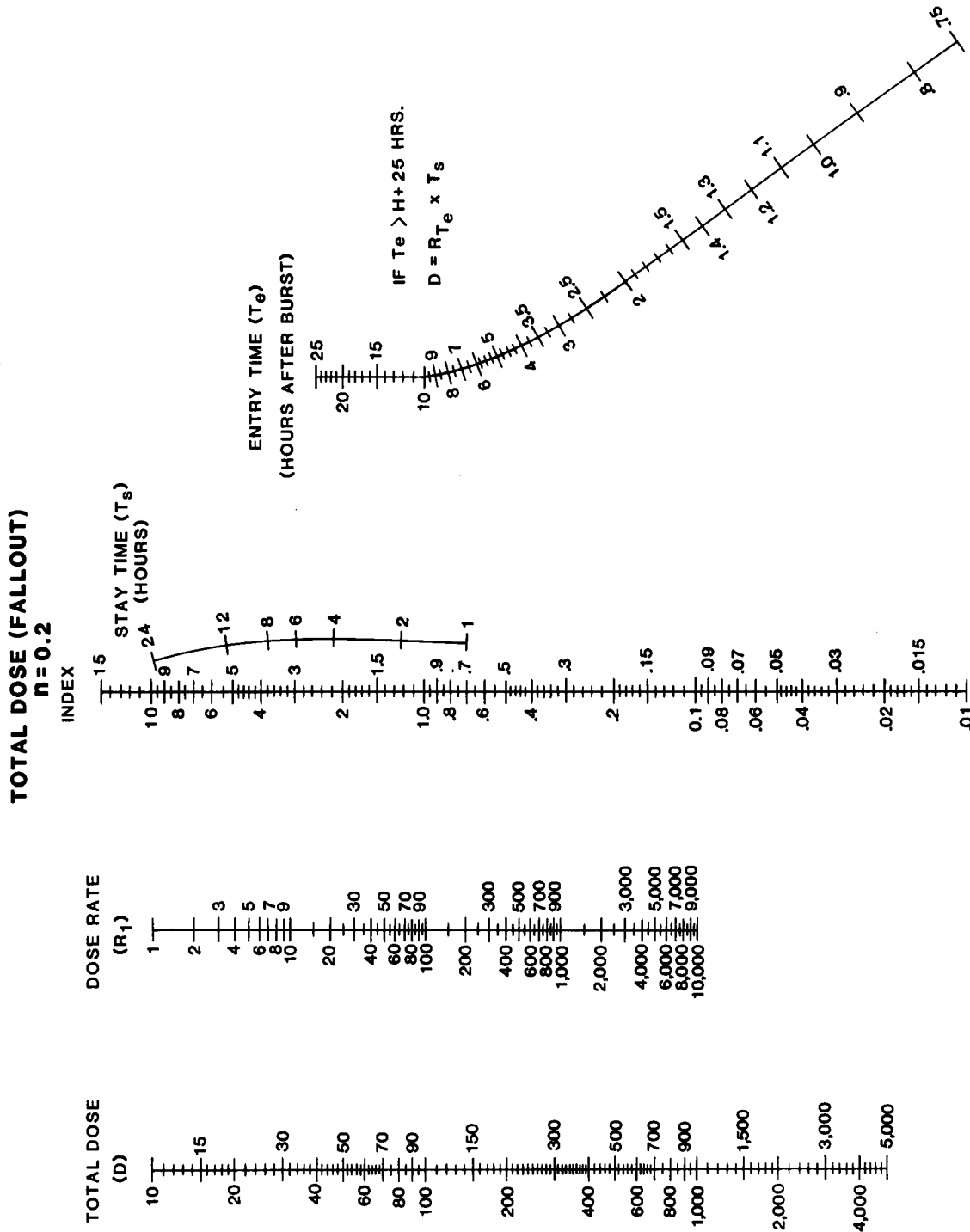

Figure E-26 Total doxe (fallout) nomogram  $n = 0.2$ .

Table E-24. Index for total dose (fallout)  $n = 0.2$ .

Enter table with entry time (Te) and stay time (Ts) to find INDEX

Entry time hrs after burst (Te)	Stay time in hours (Ts)														
	1	2	3	4	5	6	7	8	10	12	24	36	48	72	96
0.75	0.96	1.8	2.6	3.4	4.1	4.8	5.4	6.1	7.4	8.6	15.3	21.4	27	37.6	47.5
0.8	0.95	1.8	2.6	3.3	4.1	4.8	5.4	6.1	7.3	8.6	15.3	21.3	27	37.6	47.4
0.9	0.94	1.8	2.6	3.3	4	4.7	5.4	6	7.3	8.5	15.2	21.3	26.9	37.5	47.4
1	0.93	1.8	2.5	3.3	4	4.7	5.4	6	7.3	8.5	15.2	21.2	26.9	37.4	47.3
1.1	0.91	1.7	2.5	3.3	4	4.7	5.3	6	7.2	8.4	15.1	21.2	26.8	37.4	47.3
1.2	0.9	1.7	2.5	3.2	3.9	4.6	5.3	5.9	7.2	8.4	15.1	21.1	26.8	37.3	47.2
1.3	0.89	1.7	2.5	3.2	3.9	4.6	5.3	5.9	7.2	8.4	15	21.1	26.7	37.3	47.1
1.4	0.88	1.7	2.5	3.2	3.9	4.6	5.2	5.9	7.1	8.3	15	21	26.7	37.2	47.1
1.5	0.87	1.7	2.4	3.2	3.9	4.5	5.2	5.8	7.1	8.3	15	21	26.6	37.2	47
1.6	0.86	1.7	2.4	3.1	3.8	4.5	5.2	5.8	7.1	8.3	14.9	20.9	26.6	37.1	47
1.7	0.86	1.7	2.4	3.1	3.8	4.5	5.1	5.8	7	8.2	14.9	20.9	26.5	37.1	46.9
1.8	0.85	1.6	2.4	3.1	3.8	4.5	5.1	5.8	7	8.2	14.8	20.9	26.5	37	46.9
1.9	0.84	1.6	2.4	3.1	3.8	4.4	5.1	5.7	7	8.2	14.8	20.8	26.5	37	46.8
2	0.83	1.6	2.4	3.1	3.8	4.4	5.1	5.7	7	8.2	14.8	20.8	26.4	36.9	46.8
2.25	0.82	1.6	2.3	3	3.7	4.4	5	5.7	6.9	8.1	14.7	20.7	26.3	36.8	46.7
2.5	0.8	1.6	2.3	3	3.7	4.3	5	5.6	6.8	8	14.6	20.6	26.2	36.7	46.6
2.75	0.79	1.5	2.3	3	3.6	4.3	4.9	5.6	6.8	8	14.5	20.5	26.1	36.6	46.5
3	0.78	1.5	2.2	2.9	3.6	4.2	4.9	5.5	6.7	7.9	14.5	20.4	26	36.5	46.4
3.25	0.77	1.5	2.2	2.9	3.6	4.2	4.8	5.5	6.7	7.8	14.4	20.3	25.9	36.4	46.3
3.5	0.76	1.5	2.2	2.9	3.5	4.2	4.8	5.4	6.6	7.8	14.3	20.3	25.9	36.3	46.2
3.75	0.75	1.5	2.2	2.8	3.5	4.1	4.8	5.4	6.6	7.7	14.3	20.2	25.8	36.3	46.1
4	0.74	1.5	2.1	2.8	3.5	4.1	4.7	5.3	6.5	7.7	14.2	20.1	25.7	36.2	46
4.5	0.73	1.4	2.1	2.8	3.4	4	4.7	5.3	6.5	7.6	14.1	20	25.6	36	45.8
5	0.71	1.4	2.1	2.7	3.4	4	4.6	5.2	6.4	7.5	14	19.9	25.4	35.8	45.6
5.5	0.7	1.4	2	2.7	3.3	3.9	4.5	5.1	6.3	7.5	13.9	19.7	25.3	35.7	45.5
6	0.69	1.4	2	2.7	3.3	3.9	4.5	5.1	6.3	7.4	13.8	19.6	25.2	35.6	45.3
6.5	0.68	1.3	2	2.6	3.2	3.8	4.4	5	6.2	7.3	13.7	19.5	25	35.4	45.2
7	0.67	1.3	2	2.6	3.2	3.8	4.4	5	6.1	7.3	13.6	19.4	24.9	35.3	45
7.5	0.66	1.3	1.9	2.6	3.2	3.8	4.4	4.9	6.1	7.2	13.5	19.3	24.8	35.2	44.9
8	0.65	1.3	1.9	2.5	3.1	3.7	4.3	4.9	6	7.1	13.4	19.2	24.7	35	44.8
8.5	0.64	1.3	1.9	2.5	3.1	3.7	4.3	4.9	6	7.1	13.3	19.1	24.6	34.9	44.6
9	0.64	1.3	1.9	2.5	3.1	3.7	4.2	4.8	5.9	7	13.3	19	24.5	34.8	44.5
9.5	0.63	1.3	1.9	2.5	3.1	3.6	4.2	4.8	5.9	7	13.2	18.9	24.4	34.7	44.4
10	0.62	1.2	1.8	2.4	3	3.6	4.2	4.7	5.9	6.9	13.1	18.9	24.3	34.6	44.3
11	0.61	1.2	1.8	2.4	3	3.6	4.1	4.7	5.8	6.8	13	18.7	24.1	34.4	44
12	0.6	1.2	1.8	2.4	2.9	3.5	4.1	4.6	5.7	6.8	12.9	18.5	23.9	34.2	43.8
13	0.59	1.2	1.8	2.3	2.9	3.5	4	4.6	5.6	6.7	12.7	18.4	23.8	34	43.6
14	0.59	1.2	1.7	2.3	2.9	3.4	4	4.5	5.6	6.6	12.6	18.3	23.6	33.8	43.4
15	0.58	1.2	1.7	2.3	2.8	3.4	3.9	4.5	5.5	6.6	12.5	18.1	23.5	33.6	43.2
16	0.57	1.1	1.7	2.3	2.8	3.3	3.9	4.4	5.5	6.5	12.4	18	23.3	33.4	43
17	0.56	1.1	1.7	2.2	2.8	3.3	3.8	4.4	5.4	6.4	12.3	17.9	23.2	33.3	42.8
18	0.56	1.1	1.7	2.2	2.7	3.3	3.8	4.3	5.4	6.4	12.2	17.8	23.1	33.1	42.6
19	0.55	1.1	1.6	2.2	2.7	3.2	3.8	4.3	5.3	6.3	12.2	17.7	22.9	33	42.5
20	0.55	1.1	1.6	2.2	2.7	3.2	3.7	4.2	5.3	6.3	12.1	17.6	22.8	32.8	42.3
21	0.54	1.1	1.6	2.1	2.7	3.2	3.7	4.2	5.2	6.2	12	17.5	22.7	32.7	42.1
22	0.54	1.1	1.6	2.1	2.6	3.2	3.7	4.2	5.2	6.2	11.9	17.4	22.6	32.5	42
23	0.53	1.1	1.6	2.1	2.6	3.1	3.6	4.1	5.1	6.1	11.8	17.3	22.5	32.4	41.8
24	0.53	1.1	1.6	2.1	2.6	3.1	3.6	4.1	5.1	6.1	11.8	17.2	22.4	32.3	41.7
25	0.52	1	1.6	2.1	2.6	3.1	3.6	4.1	5.1	6.1	11.7	17.1	22.3	32.2	41.6

An "\*" in the table means an INDEX less than 0.005



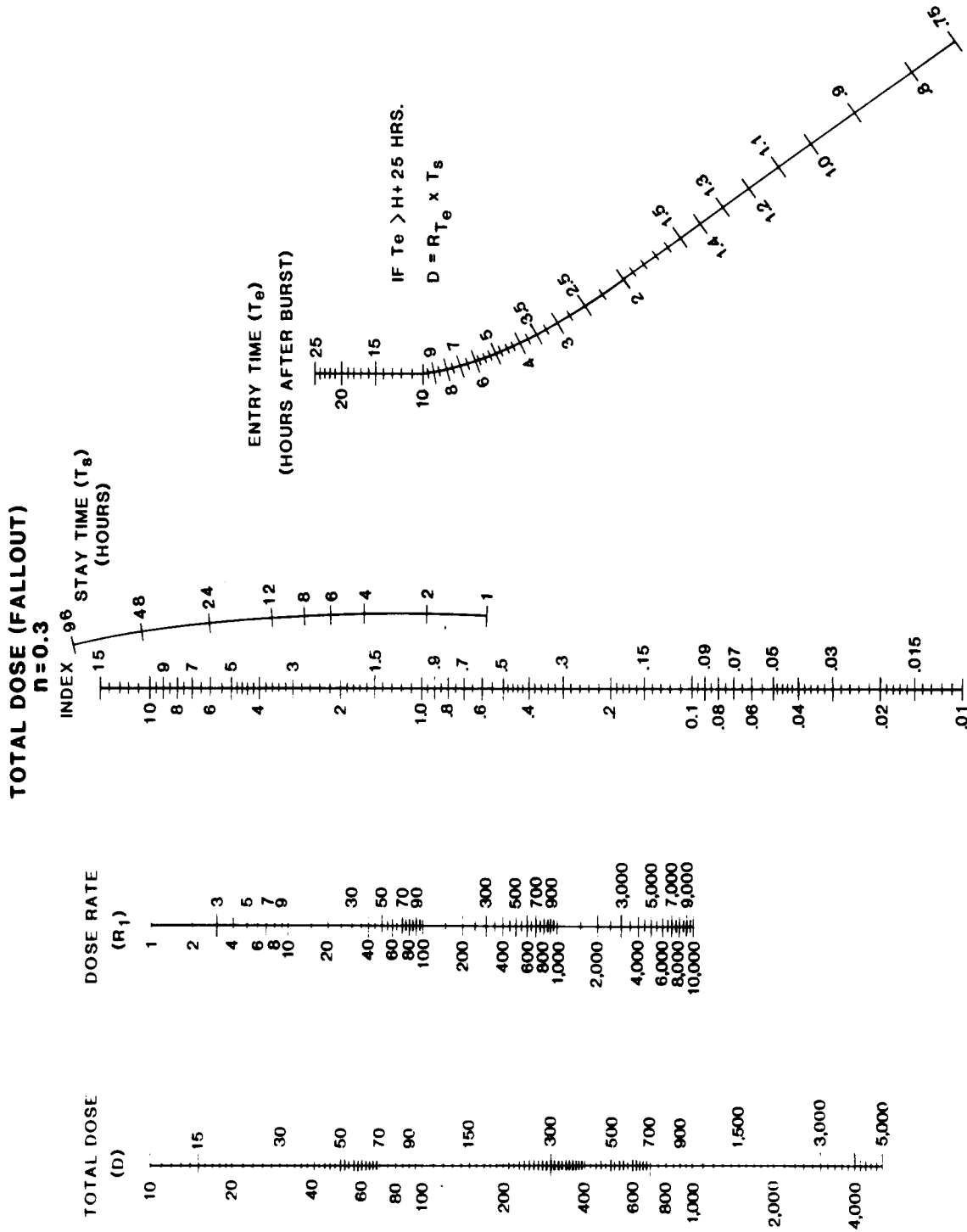

Figure E-27. Total doxe (fallout) nomogram  $n = 0.3$

Table E-28. Index for total dose (fallout)  $n = 0.3$ .

Enter table with entry time ( $T_e$ ) and stay time ( $T_s$ ) to find INDEX

Entry time hrs after burst ( $T_e$ )	Stay time in hours ( $T_s$ )														
	1	2	3	4	5	6	7	8	10	12	24	36	48	72	96
0.75	0.95	1.7	2.4	3.1	3.7	4.3	4.8	5.4	6.4	7.3	12.3	16.6	20.5	27.6	33.9
0.8	0.93	1.7	2.4	3.1	3.7	4.2	4.8	5.3	6.3	7.3	12.3	16.6	20.5	27.5	33.9
0.9	0.91	1.7	2.4	3	3.6	4.2	4.7	5.3	6.3	7.2	12.2	16.5	20.4	27.4	33.8
1	0.89	1.7	2.3	3	3.6	4.2	4.7	5.2	6.2	7.2	12.2	16.5	20.4	27.4	33.7
1.1	0.87	1.6	2.3	2.9	3.5	4.1	4.7	5.2	6.2	7.1	12.1	16.4	20.3	27.3	33.6
1.2	0.86	1.6	2.3	2.9	3.5	4.1	4.6	5.1	6.1	7.1	12.1	16.3	20.2	27.2	33.6
1.3	0.84	1.6	2.3	2.9	3.5	4	4.6	5.1	6.1	7	12	16.3	20.2	27.2	33.5
1.4	0.83	1.6	2.2	2.8	3.4	4	4.5	5.1	6	7	11.9	16.2	20.1	27.1	33.4
1.5	0.82	1.5	2.2	2.8	3.4	4	4.5	5	6	6.9	11.9	16.2	20	27	33.4
1.6	0.8	1.5	2.2	2.8	3.4	3.9	4.5	5	6	6.9	11.8	16.1	20	27	33.3
1.7	0.79	1.5	2.2	2.8	3.3	3.9	4.4	4.9	5.9	6.9	11.8	16.1	19.9	26.9	33.2
1.8	0.78	1.5	2.1	2.7	3.3	3.9	4.4	4.9	5.9	6.8	11.7	16	19.9	26.9	33.2
1.9	0.77	1.5	2.1	2.7	3.3	3.8	4.4	4.9	5.9	6.8	11.7	16	19.8	26.8	33.1
2	0.76	1.5	2.1	2.7	3.3	3.8	4.3	4.8	5.8	6.7	11.7	15.9	19.8	26.7	33.1
2.25	0.74	1.4	2	2.6	3.2	3.7	4.3	4.8	5.7	6.7	11.6	15.8	19.7	26.6	32.9
2.5	0.72	1.4	2	2.6	3.1	3.7	4.2	4.7	5.7	6.6	11.5	15.7	19.5	26.5	32.8
2.75	0.7	1.4	2	2.5	3.1	3.6	4.1	4.6	5.6	6.5	11.4	15.6	19.4	26.4	32.7
3	0.69	1.3	1.9	2.5	3	3.6	4.1	4.6	5.5	6.4	11.3	15.5	19.3	26.3	32.6
3.25	0.67	1.3	1.9	2.5	3	3.5	4	4.5	5.5	6.4	11.2	15.4	19.2	26.2	32.4
3.5	0.66	1.3	1.9	2.4	3	3.5	4	4.5	5.4	6.3	11.1	15.3	19.1	26	32.3
3.75	0.65	1.3	1.8	2.4	2.9	3.4	3.9	4.4	5.3	6.2	11	15.2	19	25.9	32.2
4	0.64	1.2	1.8	2.4	2.9	3.4	3.9	4.4	5.3	6.2	11	15.1	18.9	25.8	32.1
4.5	0.62	1.2	1.8	2.3	2.8	3.3	3.8	4.3	5.2	6.1	10.8	15	18.8	25.7	31.9
5	0.6	1.2	1.7	2.2	2.8	3.3	3.7	4.2	5.1	6	10.7	14.8	18.6	25.5	31.7
5.5	0.58	1.1	1.7	2.2	2.7	3.2	3.7	4.1	5	5.9	10.6	14.7	18.5	25.3	31.6
6	0.57	1.1	1.6	2.2	2.7	3.1	3.6	4.1	4.9	5.8	10.4	14.5	18.3	25.2	31.4
6.5	0.56	1.1	1.6	2.1	2.6	3.1	3.5	4	4.9	5.7	10.3	14.4	18.2	25	31.2
7	0.55	1.1	1.6	2.1	2.6	3	3.5	3.9	4.8	5.6	10.2	14.3	18	24.9	31.1
7.5	0.54	1.1	1.6	2	2.5	3	3.4	3.9	4.7	5.6	10.1	14.2	17.9	24.7	30.9
8	0.53	1	1.5	2	2.5	2.9	3.4	3.8	4.7	5.5	10	14.1	17.8	24.6	30.8
8.5	0.52	1	1.5	2	2.4	2.9	3.3	3.8	4.6	5.4	10	14	17.7	24.4	30.6
9	0.51	1	1.5	2	2.4	2.9	3.3	3.7	4.6	5.4	9.9	13.9	17.6	24.3	30.5
9.5	0.5	0.99	1.5	1.9	2.4	2.8	3.3	3.7	4.5	5.3	9.8	13.8	17.5	24.2	30.4
10	0.49	0.97	1.4	1.9	2.4	2.8	3.2	3.6	4.5	5.3	9.7	13.7	17.4	24.1	30.2
11	0.48	0.95	1.4	1.9	2.3	2.7	3.2	3.6	4.4	5.2	9.6	13.5	17.2	23.8	30
12	0.47	0.93	1.4	1.8	2.3	2.7	3.1	3.5	4.3	5.1	9.4	13.3	17	23.6	29.7
13	0.46	0.91	1.4	1.8	2.2	2.6	3	3.4	4.2	5	9.3	13.2	16.8	23.4	29.5
14	0.45	0.89	1.3	1.7	2.2	2.6	3	3.4	4.2	4.9	9.2	13	16.6	23.2	29.3
15	0.44	0.87	1.3	1.7	2.1	2.5	2.9	3.3	4.1	4.8	9.1	12.9	16.5	23	29.1
16	0.43	0.86	1.3	1.7	2.1	2.5	2.9	3.3	4	4.8	9	12.8	16.3	22.9	28.9
17	0.42	0.84	1.3	1.7	2.1	2.5	2.8	3.2	4	4.7	8.8	12.6	16.2	22.7	28.7
18	0.42	0.83	1.2	1.6	2	2.4	2.8	3.2	3.9	4.6	8.8	12.5	16	22.5	28.5
19	0.41	0.81	1.2	1.6	2	2.4	2.8	3.1	3.9	4.6	8.7	12.4	15.9	22.4	28.4
20	0.4	0.8	1.2	1.6	2	2.3	2.7	3.1	3.8	4.5	8.6	12.3	15.8	22.2	28.2
21	0.4	0.79	1.2	1.6	1.9	2.3	2.7	3.1	3.8	4.5	8.5	12.2	15.6	22.1	28
22	0.39	0.78	1.2	1.5	1.9	2.3	2.7	3	3.7	4.4	8.4	12.1	15.5	21.9	27.9
23	0.39	0.77	1.2	1.5	1.9	2.3	2.6	3	3.7	4.4	8.3	12	15.4	21.8	27.7
24	0.38	0.76	1.1	1.5	1.9	2.2	2.6	3	3.7	4.3	8.3	11.9	15.3	21.7	27.6
25	0.38	0.75	1.1	1.5	1.9	2.2	2.6	2.9	3.6	4.3	8.2	11.8	15.2	21.5	27.4

An "\*" in the table means an INDEX less than 0.005

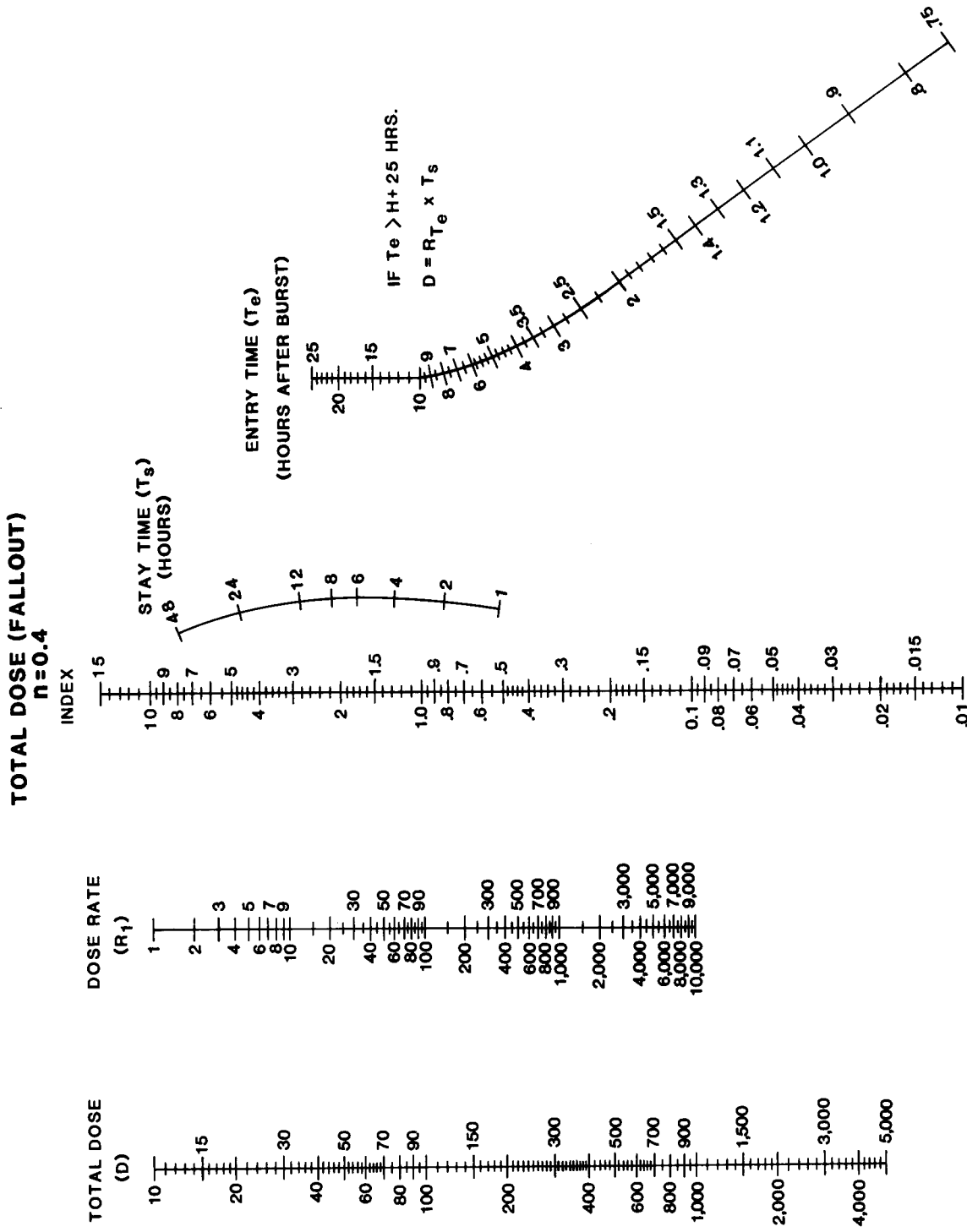

Figure E-28. Total dose (fallout) nomogram n = 0.4.

Table E-26. Index for total dose (fallout)  $n = 0.4$ .

Enter table with entry time (Te) and stay time (Ts) to find INDEX

Entry time hrs after burst (Te)	Stay time in hours (Ts)															
	1	2	3	4	5	6	7	8	10	12	24	36	48	72	96	
0.75	0.93	1.7	2.3	2.8	3.4	3.8	4.3	4.7	5.5	6.3	10	13.1	15.8	20.4	24.5	
0.8	0.91	1.6	2.3	2.8	3.3	3.8	4.3	4.7	5.5	6.2	10	13	15.7	20.4	24.5	
0.9	0.89	1.6	2.2	2.8	3.3	3.8	4.2	4.6	5.4	6.2	9.9	13	15.6	20.3	24.4	
1	0.86	1.6	2.2	2.7	3.2	3.7	4.1	4.6	5.4	6.1	9.8	12.9	15.6	20.2	24.3	
1.1	0.84	1.5	2.1	2.7	3.2	3.6	4.1	4.5	5.3	6	9.8	12.8	15.5	20.1	24.2	
1.2	0.82	1.5	2.1	2.6	3.1	3.6	4	4.5	5.2	6	9.7	12.7	15.4	20.1	24.1	
1.3	0.8	1.5	2.1	2.6	3.1	3.5	4	4.4	5.2	5.9	9.6	12.7	15.3	20	24	
1.4	0.78	1.4	2	2.5	3	3.5	3.9	4.4	5.1	5.9	9.6	12.6	15.3	19.9	24	
1.5	0.76	1.4	2	2.5	3	3.5	3.9	4.3	5.1	5.8	9.5	12.5	15.2	19.8	23.9	
1.6	0.75	1.4	2	2.5	3	3.4	3.9	4.3	5	5.8	9.5	12.5	15.1	19.8	23.8	
1.7	0.73	1.4	1.9	2.4	2.9	3.4	3.8	4.2	5	5.7	9.4	12.4	15.1	19.7	23.8	
1.8	0.72	1.3	1.9	2.4	2.9	3.3	3.8	4.2	5	5.7	9.4	12.4	15	19.6	23.7	
1.9	0.71	1.3	1.9	2.4	2.9	3.3	3.7	4.2	4.9	5.6	9.3	12.3	15	19.6	23.6	
2	0.7	1.3	1.9	2.4	2.8	3.3	3.7	4.1	4.8	5.6	9.3	12.3	14.9	19.5	23.6	
2.25	0.67	1.3	1.8	2.3	2.8	3.2	3.6	4	4.8	5.5	9.1	12.1	14.8	19.4	23.4	
2.5	0.65	1.2	1.8	2.2	2.7	3.1	3.6	3.9	4.7	5.4	9	12	14.6	19.3	23.3	
2.75	0.63	1.2	1.7	2.2	2.6	3.1	3.5	3.9	4.6	5.3	8.9	11.9	14.5	19.1	23.2	
3	0.61	1.2	1.7	2.1	2.6	3	3.4	3.8	4.5	5.2	8.8	11.8	14.4	19	23	
3.25	0.59	1.1	1.6	2.1	2.5	3	3.4	3.7	4.5	5.2	8.7	11.7	14.3	18.9	22.9	
3.5	0.58	1.1	1.6	2.1	2.5	2.9	3.3	3.7	4.4	5.1	8.6	11.6	14.2	18.8	22.8	
3.75	0.56	1.1	1.6	2	2.4	2.9	3.3	3.6	4.4	5	8.6	11.5	14.1	18.7	22.7	
4	0.55	1.1	1.5	2	2.4	2.8	3.2	3.6	4.3	5	8.5	11.4	14	18.6	22.6	
4.5	0.53	1	1.5	1.9	2.3	2.7	3.1	3.5	4.2	4.9	8.3	11.3	13.8	18.4	22.4	
5	0.51	0.96	1.4	1.9	2.3	2.7	3	3.4	4.1	4.8	8.2	11.1	13.7	18.2	22.2	
5.5	0.49	0.95	1.4	1.8	2.2	2.6	3	3.3	4	4.7	8.1	11	13.5	18	22	
6	0.47	0.92	1.4	1.8	2.1	2.5	2.9	3.2	3.9	4.6	7.9	10.8	13.4	17.9	21.9	
6.5	0.46	0.89	1.3	1.7	2.1	2.5	2.8	3.2	3.8	4.5	7.8	10.7	13.2	17.7	21.7	
7	0.45	0.87	1.3	1.7	2.1	2.4	2.8	3.1	3.8	4.4	7.7	10.6	13.1	17.6	21.5	
7.5	0.44	0.85	1.3	1.6	2	2.4	2.7	3.1	3.7	4.3	7.6	10.5	13	17.4	21.4	
8	0.42	0.83	1.2	1.6	2	2.3	2.7	3	3.6	4.3	7.5	10.3	12.9	17.3	21.2	
8.5	0.42	0.81	1.2	1.6	1.9	2.3	2.6	2.9	3.6	4.2	7.4	10.2	12.7	17.2	21.1	
9	0.41	0.8	1.2	1.5	1.9	2.2	2.6	2.9	3.5	4.1	7.4	10.1	12.6	17.1	21	
9.5	0.4	0.78	1.2	1.5	1.9	2.2	2.5	2.9	3.5	4.1	7.3	10	12.5	16.9	20.8	
10	0.39	0.77	1.1	1.5	1.8	2.2	2.5	2.8	3.4	4	7.2	9.9	12.4	16.8	20.7	
11	0.38	0.74	1.1	1.4	1.8	2.1	2.4	2.7	3.3	3.9	7	9.8	12.2	16.6	20.5	
12	0.36	0.72	1.1	1.4	1.7	2	2.4	2.7	3.3	3.8	6.9	9.6	12	16.4	20.3	
13	0.35	0.7	1	1.4	1.7	2	2.3	2.6	3.2	3.7	6.8	9.5	11.9	16.2	20.1	
14	0.34	0.68	1	1.3	1.6	1.9	2.2	2.5	3.1	3.7	6.7	9.3	11.7	16	19.9	
15	0.33	0.66	0.98	1.3	1.6	1.9	2.2	2.5	3	3.6	6.6	9.2	11.6	15.8	19.7	
16	0.33	0.64	0.96	1.3	1.6	1.9	2.1	2.4	3	3.5	6.5	9.1	11.4	15.7	19.5	
17	0.32	0.63	0.93	1.2	1.5	1.8	2.1	2.4	2.9	3.5	6.4	8.9	11.3	15.5	19.3	
18	0.31	0.62	0.91	1.2	1.5	1.8	2.1	2.3	2.9	3.4	6.3	8.8	11.2	15.4	19.1	
19	0.3	0.6	0.9	1.2	1.5	1.8	2	2.3	2.8	3.3	6.2	8.7	11	15.2	19	
20	0.3	0.59	0.88	1.2	1.4	1.7	2	2.3	2.8	3.3	6.1	8.6	10.9	15.1	18.8	
21	0.29	0.58	0.86	1.1	1.4	1.7	2	2.2	2.7	3.2	6	8.5	10.8	14.9	18.7	
22	0.29	0.57	0.85	1.1	1.4	1.7	1.9	2.2	2.7	3.2	5.9	8.4	10.7	14.8	18.5	
23	0.28	0.56	0.83	1.1	1.4	1.6	1.9	2.2	2.7	3.1	5.9	8.3	10.6	14.7	18.4	
24	0.28	0.55	0.82	1.1	1.4	1.6	1.9	2.1	2.6	3.1	5.8	8.2	10.5	14.6	18.3	
25	0.27	0.54	0.81	1.1	1.3	1.6	1.8	2.1	2.6	3.1	5.7	8.1	10.4	14.4	18.1	

An "\*" in the table means an INDEX less than 0.005

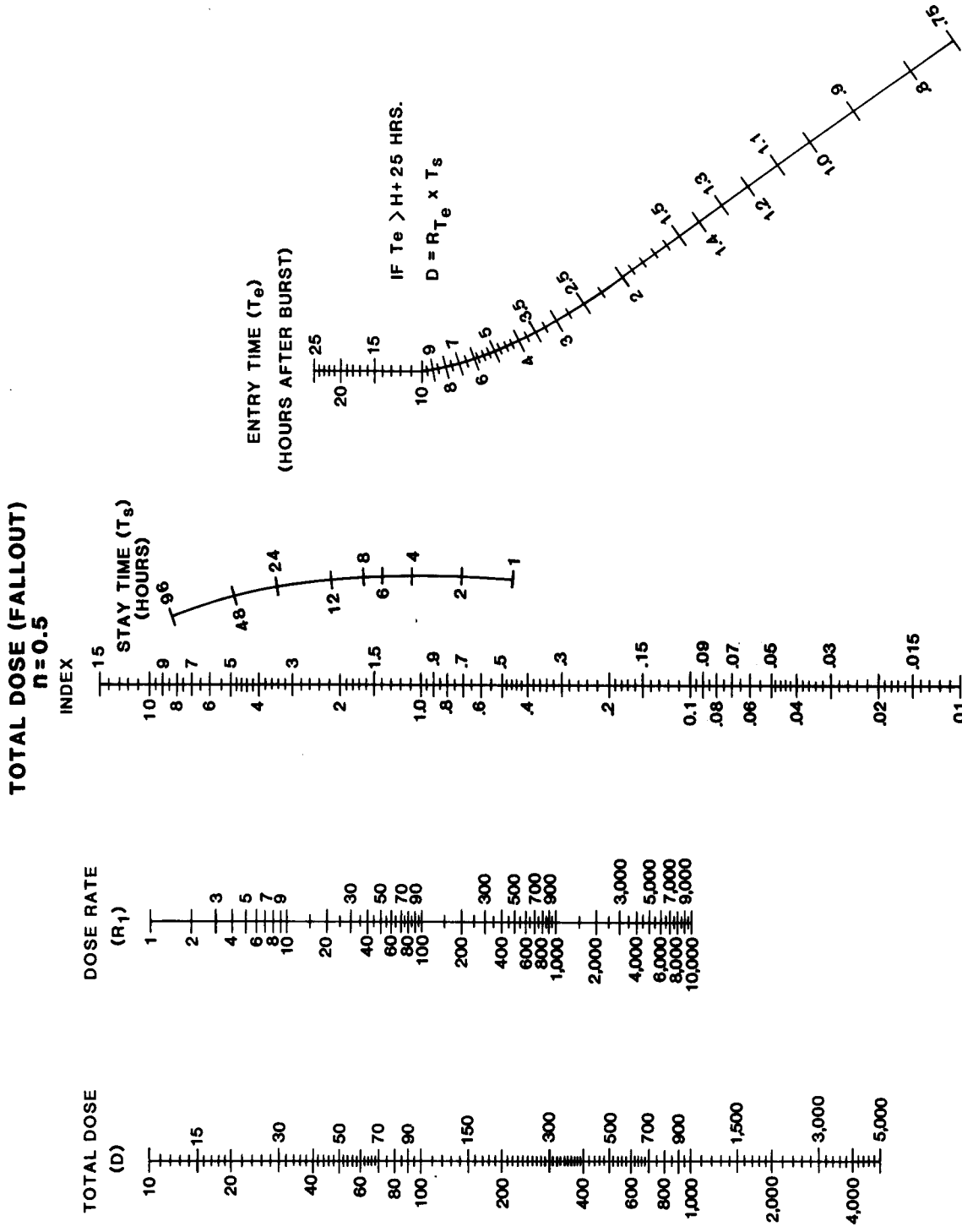

Figure E-29. Total dose (fallout) nomogram  $n = 0.5$ .

Table E-27. Index for total dose (fallout)  $n = 0.5$ .

Enter table with entry time (Te) and stay time (Ts) to find INDEX

Entry time hrs after burst (Te)	Stay time in hours (Ts)														
	1	2	3	4	5	6	7	8	10	12	24	36	48	72	96
0.75	0.91	1.6	2.1	2.6	3.1	3.5	3.8	4.2	4.8	5.4	6.2	10.4	12.2	15.3	17.9
0.8	0.89	1.6	2.1	2.6	3	3.4	3.8	4.1	4.8	5.4	6.2	10.3	12.2	15.3	17.9
0.9	0.86	1.5	2.1	2.5	3	3.4	3.7	4.1	4.7	5.3	6.1	10.3	12.1	15.2	17.8
1	0.83	1.5	2	2.5	2.9	3.3	3.7	4	4.6	5.2	6	10.2	12	15.1	17.7
1.1	0.8	1.4	2	2.4	2.8	3.2	3.6	3.9	4.6	5.1	7.9	10.1	11.9	15	17.6
1.2	0.78	1.4	1.9	2.4	2.8	3.2	3.5	3.9	4.5	5.1	7.9	10	11.8	14.9	17.5
1.3	0.75	1.4	1.9	2.3	2.7	3.1	3.5	3.8	4.4	5	7.8	9.9	11.8	14.8	17.5
1.4	0.73	1.3	1.8	2.3	2.7	3.1	3.4	3.8	4.4	5	7.7	9.9	11.7	14.8	17.4
1.5	0.71	1.3	1.8	2.2	2.7	3	3.4	3.7	4.3	4.9	7.7	9.8	11.8	14.7	17.3
1.6	0.7	1.3	1.8	2.2	2.6	3	3.3	3.7	4.3	4.9	7.6	9.7	11.8	14.6	17.2
1.7	0.68	1.2	1.7	2.2	2.6	2.9	3.3	3.6	4.2	4.8	7.5	9.7	11.5	14.6	17.2
1.8	0.66	1.2	1.7	2.1	2.5	2.9	3.3	3.6	4.2	4.8	7.5	9.6	11.4	14.5	17.1
1.9	0.65	1.2	1.7	2.1	2.5	2.9	3.2	3.5	4.1	4.7	7.4	9.6	11.4	14.4	17
2	0.64	1.2	1.6	2.1	2.5	2.8	3.2	3.5	4.1	4.7	7.4	9.5	11.3	14.4	17
2.25	0.61	1.1	1.6	2	2.4	2.7	3.1	3.4	4	4.6	7.3	9.4	11.2	14.2	16.8
2.5	0.58	1.1	1.5	1.9	2.3	2.7	3	3.3	3.9	4.5	7.1	9.3	11.1	14.1	16.7
2.75	0.56	1	1.5	1.9	2.3	2.6	2.9	3.2	3.8	4.4	7	9.1	10.9	14	16.6
3	0.54	1	1.4	1.8	2.2	2.5	2.9	3.2	3.8	4.3	6.9	9	10.8	13.9	16.4
3.25	0.52	0.98	1.4	1.8	2.1	2.5	2.8	3.1	3.7	4.2	6.8	8.9	10.7	13.7	16.3
3.5	0.5	0.95	1.4	1.7	2.1	2.4	2.7	3	3.6	4.1	6.8	8.8	10.6	13.6	16.2
3.75	0.49	0.92	1.3	1.7	2	2.4	2.7	3	3.5	4.1	6.7	8.7	10.5	13.5	16.1
4	0.47	0.9	1.3	1.7	2	2.3	2.6	2.9	3.5	4	6.6	8.7	10.4	13.4	16
4.5	0.45	0.86	1.2	1.6	1.9	2.2	2.5	2.8	3.4	3.9	6.4	8.5	10.3	13.3	15.8
5	0.43	0.82	1.2	1.5	1.9	2.2	2.5	2.7	3.3	3.8	6.3	8.3	10.1	13.1	15.6
5.5	0.41	0.79	1.1	1.5	1.8	2.1	2.4	2.7	3.2	3.7	6.2	8.2	9.9	12.9	15.5
6	0.39	0.76	1.1	1.4	1.7	2	2.3	2.6	3.1	3.6	6.1	8.1	9.8	12.8	15.3
6.5	0.38	0.73	1.1	1.4	1.7	2	2.3	2.5	3	3.5	6	7.9	9.7	12.6	15.2
7	0.37	0.71	1	1.3	1.6	1.9	2.2	2.5	3	3.4	5.8	7.8	9.5	12.5	15
7.5	0.35	0.69	1	1.3	1.6	1.9	2.1	2.4	2.9	3.4	5.8	7.7	9.4	12.4	14.9
8	0.34	0.67	0.98	1.3	1.6	1.8	2.1	2.3	2.8	3.3	5.7	7.6	9.3	12.2	14.7
8.5	0.33	0.65	0.95	1.2	1.5	1.8	2	2.3	2.8	3.2	5.6	7.5	9.2	12.1	14.6
9	0.32	0.63	0.93	1.2	1.5	1.8	2	2.3	2.7	3.2	5.5	7.4	9.1	12	14.5
9.5	0.32	0.62	0.91	1.2	1.5	1.7	2	2.2	2.7	3.1	5.4	7.3	9	11.9	14.4
10	0.31	0.6	0.89	1.2	1.4	1.7	1.9	2.2	2.6	3.1	5.3	7.2	8.9	11.8	14.3
11	0.29	0.58	0.85	1.1	1.4	1.6	1.9	2.1	2.5	3	5.2	7.1	8.7	11.6	14.1
12	0.28	0.56	0.82	1.1	1.3	1.6	1.8	2	2.5	2.9	5.1	6.9	8.6	11.4	13.9
13	0.27	0.53	0.79	1	1.3	1.5	1.7	2	2.4	2.8	5	6.8	8.4	11.2	13.7
14	0.26	0.52	0.76	1	1.2	1.5	1.7	1.9	2.3	2.7	4.9	6.7	8.3	11.1	13.5
15	0.25	0.5	0.74	0.97	1.2	1.4	1.6	1.9	2.3	2.7	4.7	6.5	8.1	10.9	13.3
16	0.25	0.49	0.72	0.94	1.2	1.4	1.6	1.8	2.2	2.6	4.7	6.4	8	10.8	13.2
17	0.24	0.47	0.7	0.92	1.1	1.4	1.6	1.8	2.2	2.5	4.6	6.3	7.9	10.6	13
18	0.23	0.46	0.68	0.9	1.1	1.3	1.5	1.7	2.1	2.5	4.5	6.2	7.8	10.5	12.9
19	0.23	0.45	0.66	0.87	1.1	1.3	1.5	1.7	2.1	2.4	4.4	6.1	7.7	10.4	12.7
20	0.22	0.44	0.65	0.85	1.1	1.3	1.5	1.6	2	2.4	4.3	6	7.6	10.2	12.6
21	0.22	0.43	0.63	0.83	1	1.2	1.4	1.6	2	2.3	4.3	5.9	7.5	10.1	12.5
22	0.21	0.42	0.62	0.82	1	1.2	1.4	1.6	1.9	2.3	4.2	5.9	7.4	10	12.3
23	0.21	0.41	0.61	0.8	0.99	1.2	1.4	1.5	1.9	2.2	4.1	5.8	7.3	9.9	12.2
24	0.2	0.4	0.59	0.79	0.97	1.2	1.3	1.5	1.9	2.2	4.1	5.7	7.2	9.8	12.1
25	0.2	0.39	0.58	0.77	0.95	1.1	1.3	1.5	1.8	2.2	4	5.6	7.1	9.7	12

An "\*" in the table means an INDEX less than 0.005

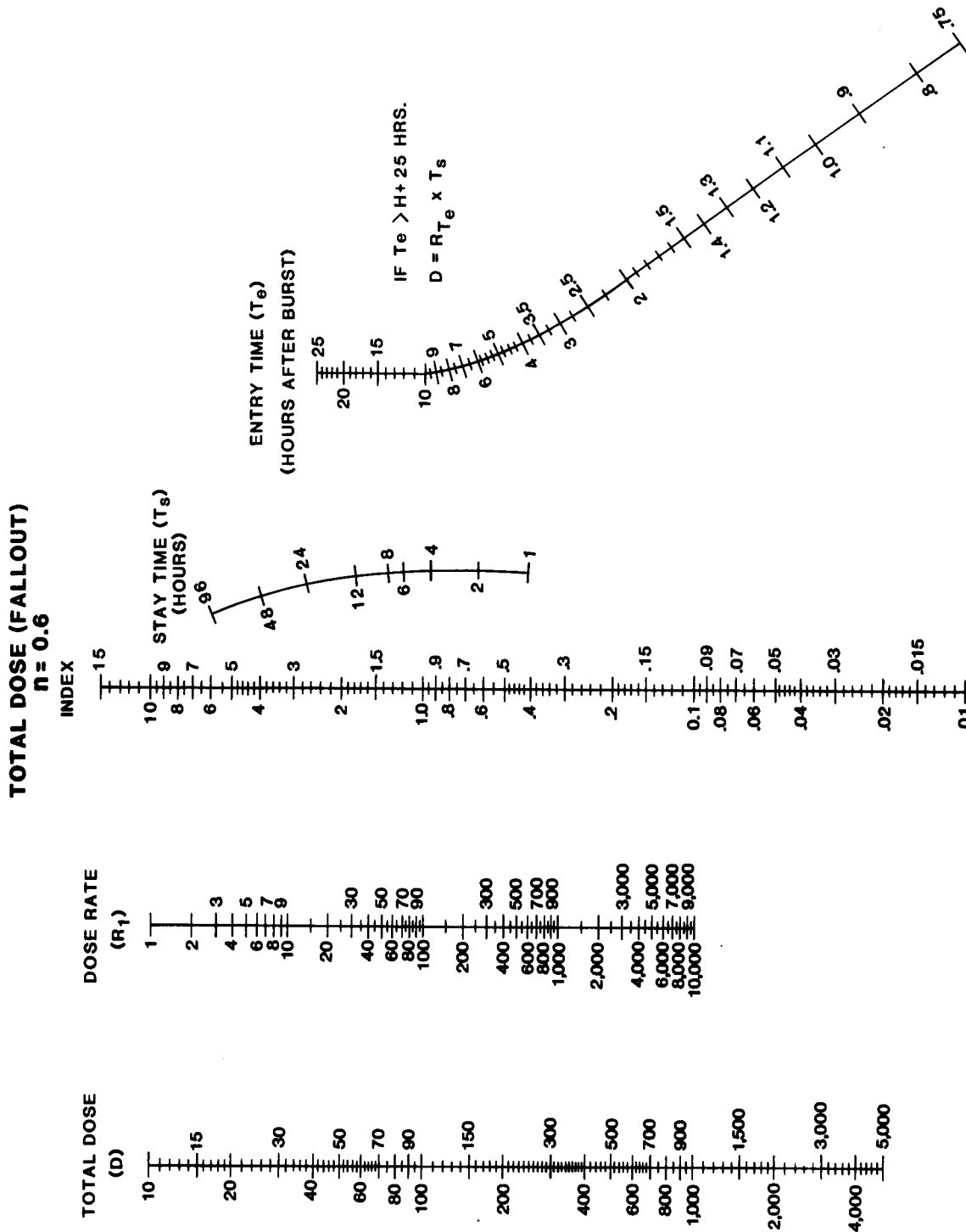

Figure E-30. Total dose (fallout) nomogram  $n = 0.6$ .

Table E-28. Index for total dose (fallout)  $n = 0.6$ .

Enter table with entry time (Te) and stay time (Ts) to find INDEX

Entry time hrs after burst (Te)	Stay time in hours (Ts)														
	1	2	3	4	5	6	7	8	10	12	24	36	48	72	96
0.75	0.9	1.5	2	2.4	2.8	3.1	3.4	3.7	4.2	4.7	6.8	8.3	9.6	11.7	13.3
0.8	0.88	1.5	2	2.4	2.8	3.1	3.4	3.7	4.2	4.6	6.7	8.3	9.6	11.6	13.3
0.9	0.83	1.4	1.9	2.3	2.7	3	3.3	3.6	4.1	4.6	6.7	8.2	9.5	11.5	13.2
1	0.8	1.4	1.9	2.3	2.6	2.9	3.2	3.5	4	4.5	6.6	8.1	9.4	11.4	13.1
1.1	0.77	1.3	1.8	2.2	2.6	2.9	3.2	3.5	4	4.4	6.5	8	9.3	11.3	13
1.2	0.74	1.3	1.8	2.2	2.5	2.8	3.1	3.4	3.9	4.3	6.4	7.9	9.2	11.2	12.9
1.3	0.71	1.3	1.7	2.1	2.4	2.8	3.1	3.3	3.8	4.3	6.3	7.9	9.1	11.2	12.8
1.4	0.69	1.2	1.7	2.1	2.4	2.7	3	3.3	3.8	4.2	6.3	7.8	9	11.1	12.8
1.5	0.67	1.2	1.6	2	2.4	2.7	2.9	3.2	3.7	4.1	6.2	7.7	9	11	12.7
1.6	0.65	1.2	1.6	2	2.3	2.6	2.9	3.2	3.7	4.1	6.1	7.7	8.9	10.9	12.6
1.7	0.63	1.1	1.6	1.9	2.3	2.6	2.9	3.1	3.6	4	6.1	7.6	8.8	10.9	12.5
1.8	0.61	1.1	1.5	1.9	2.2	2.5	2.8	3.1	3.6	4	6	7.5	8.8	10.8	12.5
1.9	0.6	1.1	1.5	1.9	2.2	2.5	2.8	3	3.5	3.9	6	7.5	8.7	10.7	12.4
2	0.58	1.1	1.5	1.8	2.2	2.4	2.7	3	3.5	3.9	5.9	7.4	8.7	10.7	12.4
2.25	0.55	1	1.4	1.8	2.1	2.4	2.6	2.9	3.4	3.8	5.8	7.3	8.5	10.6	12.2
2.5	0.52	0.96	1.3	1.7	2	2.3	2.6	2.8	3.3	3.7	5.7	7.2	8.4	10.4	12.1
2.75	0.49	0.92	1.3	1.6	1.9	2.2	2.5	2.7	3.2	3.6	5.6	7.1	8.3	10.3	12
3	0.47	0.88	1.2	1.6	1.9	2.1	2.4	2.6	3.1	3.5	5.5	6.9	8.2	10.2	11.8
3.25	0.45	0.85	1.2	1.5	1.8	2.1	2.3	2.6	3	3.4	5.4	6.9	8.1	10.1	11.7
3.5	0.44	0.82	1.2	1.5	1.8	2	2.3	2.5	3	3.4	5.3	6.8	8	10	11.6
3.75	0.42	0.79	1.1	1.4	1.7	2	2.2	2.5	2.9	3.3	5.2	6.7	7.9	9.9	11.5
4	0.41	0.77	1.1	1.4	1.7	1.9	2.2	2.4	2.8	3.2	5.1	6.6	7.8	9.8	11.4
4.5	0.38	0.72	1	1.3	1.6	1.8	2.1	2.3	2.7	3.1	5	6.4	7.6	9.6	11.2
5	0.36	0.69	0.96	1.3	1.5	1.8	2	2.2	2.6	3	4.9	6.3	7.5	9.5	11.1
5.5	0.34	0.65	0.94	1.2	1.5	1.7	1.9	2.1	2.5	2.9	4.7	6.2	7.3	9.3	10.9
6	0.33	0.62	0.9	1.2	1.4	1.6	1.9	2.1	2.5	2.8	4.6	6	7.2	9.2	10.8
6.5	0.31	0.6	0.87	1.1	1.4	1.6	1.8	2	2.4	2.8	4.5	5.9	7.1	9	10.6
7	0.3	0.58	0.83	1.1	1.3	1.5	1.7	1.9	2.3	2.7	4.4	5.8	7	8.9	10.5
7.5	0.29	0.56	0.81	1	1.3	1.5	1.7	1.9	2.3	2.6	4.3	5.7	6.9	8.8	10.4
8	0.28	0.54	0.78	1	1.2	1.4	1.6	1.8	2.2	2.5	4.3	5.6	6.8	8.7	10.3
8.5	0.27	0.52	0.76	0.98	1.2	1.4	1.6	1.8	2.2	2.5	4.2	5.5	6.7	8.6	10.2
9	0.26	0.5	0.73	0.95	1.2	1.4	1.6	1.7	2.1	2.4	4.1	5.4	6.6	8.5	10.1
9.5	0.25	0.49	0.71	0.93	1.1	1.3	1.5	1.7	2.1	2.4	4	5.4	6.5	8.4	10
10	0.24	0.48	0.69	0.9	1.1	1.3	1.5	1.7	2	2.3	4	5.3	6.4	8.3	9.9
11	0.23	0.45	0.66	0.86	1.1	1.2	1.4	1.6	1.9	2.2	3.8	5.1	6.3	8.1	9.7
12	0.22	0.43	0.63	0.82	1	1.2	1.4	1.5	1.9	2.2	3.7	5	6.1	8	9.5
13	0.21	0.41	0.6	0.79	0.97	1.1	1.3	1.5	1.8	2.1	3.6	4.9	6	7.8	9.4
14	0.2	0.39	0.58	0.76	0.93	1.1	1.3	1.4	1.7	2	3.5	4.8	5.8	7.7	9.2
15	0.19	0.38	0.56	0.73	0.9	1.1	1.2	1.4	1.7	2	3.4	4.7	5.7	7.5	9.1
16	0.19	0.37	0.54	0.71	0.87	1	1.2	1.3	1.6	1.9	3.4	4.6	5.6	7.4	8.9
17	0.18	0.35	0.52	0.68	0.84	1	1.2	1.3	1.6	1.9	3.3	4.5	5.5	7.3	8.8
18	0.17	0.34	0.51	0.66	0.82	0.97	1.1	1.3	1.5	1.8	3.2	4.4	5.4	7.2	8.7
19	0.17	0.33	0.49	0.64	0.8	0.94	1.1	1.2	1.5	1.8	3.1	4.3	5.3	7.1	8.6
20	0.16	0.32	0.48	0.63	0.77	0.92	1.1	1.2	1.5	1.7	3.1	4.2	5.2	7	8.5
21	0.16	0.31	0.46	0.61	0.75	0.89	1	1.2	1.4	1.7	3	4.2	5.2	6.9	8.4
22	0.15	0.3	0.45	0.59	0.73	0.87	1	1.1	1.4	1.6	3	4.1	5.1	6.8	8.3
23	0.15	0.3	0.44	0.58	0.72	0.85	0.98	1.1	1.4	1.6	2.9	4	5	6.7	8.2
24	0.15	0.29	0.43	0.57	0.7	0.83	0.96	1.1	1.3	1.6	2.9	4	4.9	6.6	8.1
25	0.14	0.28	0.42	0.55	0.69	0.81	0.94	1.1	1.3	1.5	2.8	3.9	4.9	6.5	8

An "\*" in the table means an INDEX less than 0.005



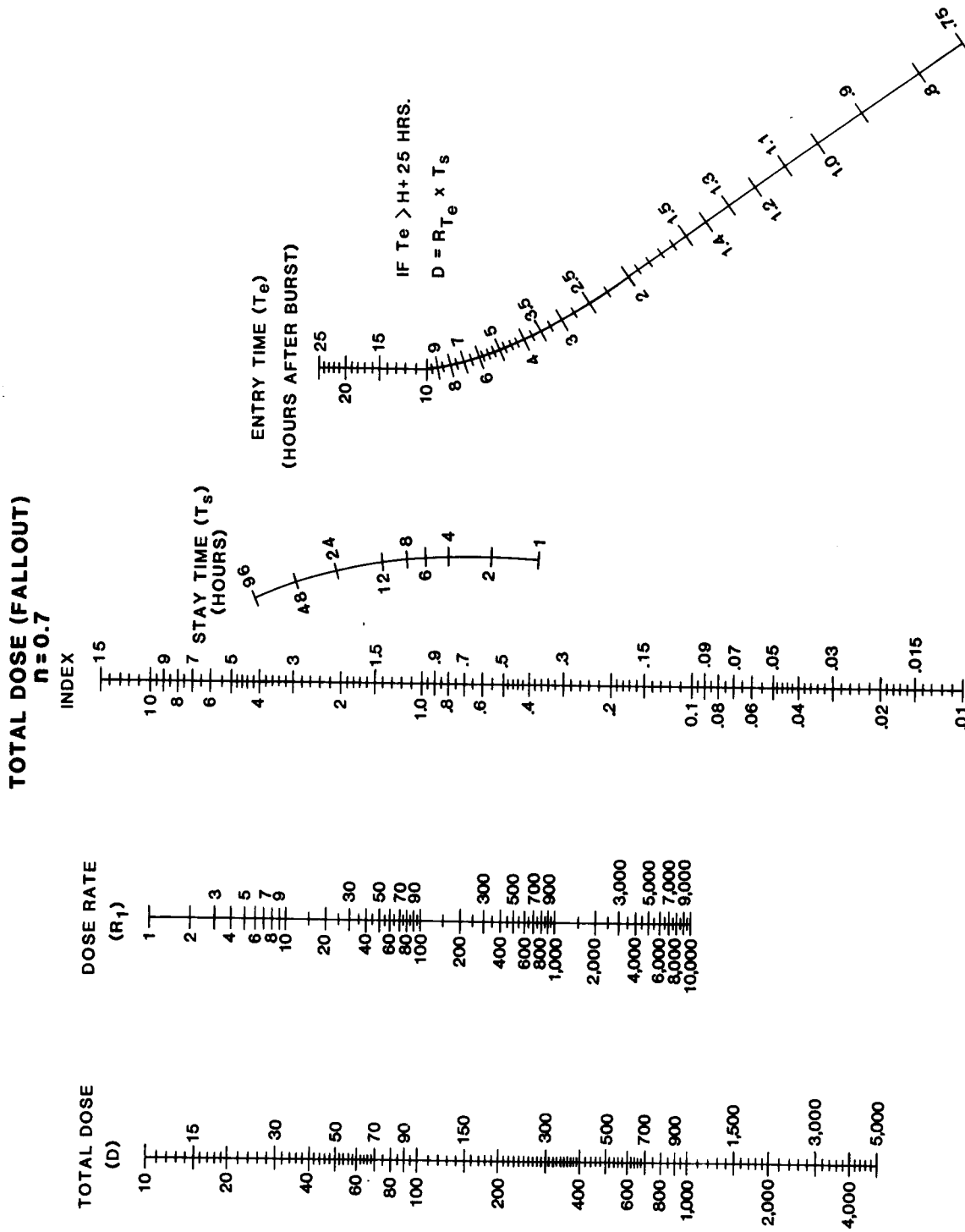

Figure E-31. Total dose (fallout) nomogram  $n = 0.7$ .

Table E-29. Index for total dose (fallout)  $n = 0.7$ .

Enter table with entry time (Te) and stay time (Ts) to find INDEX

Entry time hrs after burst (Te)	Stay time in hours (Ts)														
	1	2	3	4	5	6	7	8	10	12	24	36	48	72	96
0.75	0.86	1.5	1.9	2.3	2.6	2.9	3.1	3.3	3.7	4.1	5.7	6.8	7.6	9	10.1
0.8	0.86	1.4	1.9	2.2	2.5	2.8	3.1	3.3	3.7	4	5.6	6.7	7.6	9	10
0.9	0.81	1.4	1.8	2.1	2.5	2.7	3	3.2	3.6	4	5.5	6.6	7.5	8.8	9.9
1	0.77	1.3	1.7	2.1	2.4	2.6	2.9	3.1	3.5	3.9	5.4	6.5	7.4	8.7	9.8
1.1	0.73	1.3	1.7	2	2.3	2.6	2.8	3	3.4	3.8	5.3	6.4	7.3	8.7	9.7
1.2	0.7	1.2	1.6	2	2.2	2.5	2.8	3	3.4	3.7	5.3	6.3	7.2	8.6	9.6
1.3	0.67	1.2	1.6	1.9	2.2	2.5	2.7	2.9	3.3	3.6	5.2	6.3	7.1	8.5	9.6
1.4	0.65	1.1	1.5	1.8	2.1	2.4	2.6	2.8	3.2	3.6	5.1	6.2	7.1	8.4	9.5
1.5	0.62	1.1	1.5	1.8	2.1	2.3	2.6	2.8	3.2	3.5	5	6.1	7	8.3	9.4
1.6	0.6	1.1	1.4	1.8	2	2.3	2.5	2.7	3.1	3.5	5	6.1	6.9	8.3	9.3
1.7	0.58	1	1.4	1.7	2	2.2	2.5	2.7	3.1	3.4	4.9	6	6.9	8.2	9.3
1.8	0.56	1	1.4	1.7	2	2.2	2.4	2.6	3	3.4	4.9	5.9	6.8	8.1	9.2
1.9	0.55	0.97	1.3	1.6	1.9	2.2	2.4	2.6	3	3.3	4.8	5.9	6.7	8.1	9.1
2	0.53	0.95	1.3	1.6	1.9	2.1	2.3	2.6	2.9	3.3	4.8	5.8	6.7	8	9.1
2.25	0.5	0.90	1.2	1.5	1.8	2	2.3	2.5	2.8	3.2	4.6	5.7	6.5	7.9	9
2.5	0.47	0.85	1.2	1.5	1.7	2	2.2	2.4	2.7	3.1	4.5	5.6	6.4	7.8	8.8
2.75	0.44	0.8	1.1	1.4	1.7	1.9	2.1	2.3	2.6	3	4.4	5.5	6.3	7.7	8.7
3	0.42	0.77	1.1	1.3	1.6	1.8	2	2.2	2.6	2.9	4.3	5.4	6.2	7.5	8.6
3.25	0.4	0.73	1	1.3	1.5	1.8	2	2.1	2.5	2.8	4.2	5.3	6.1	7.4	8.5
3.5	0.38	0.7	0.99	1.3	1.5	1.7	1.9	2.1	2.4	2.7	4.2	5.2	6	7.3	8.4
3.75	0.36	0.68	0.96	1.2	1.4	1.7	1.8	2	2.4	2.7	4.1	5.1	5.9	7.3	8.3
4	0.35	0.65	0.92	1.2	1.4	1.6	1.8	2	2.3	2.6	4	5	5.9	7.2	8.2
4.5	0.32	0.61	0.87	1.1	1.3	1.5	1.7	1.9	2.2	2.5	3.9	4.9	5.7	7	8.1
5	0.3	0.57	0.82	1	1.3	1.4	1.6	1.8	2.1	2.4	3.8	4.8	5.6	6.9	7.9
5.5	0.29	0.54	0.78	0.99	1.2	1.4	1.6	1.7	2	2.3	3.6	4.6	5.4	6.7	7.8
6	0.27	0.51	0.74	0.94	1.1	1.3	1.5	1.7	2	2.2	3.5	4.5	5.3	6.6	7.6
6.5	0.26	0.49	0.7	0.9	1.1	1.3	1.4	1.6	1.9	2.2	3.5	4.4	5.2	6.5	7.5
7	0.24	0.47	0.67	0.87	1.1	1.2	1.4	1.5	1.8	2.1	3.4	4.3	5.1	6.4	7.4
7.5	0.23	0.45	0.65	0.83	1	1.2	1.3	1.5	1.8	2	3.3	4.2	5	6.3	7.3
8	0.22	0.43	0.62	0.8	0.98	1.1	1.3	1.4	1.7	2	3.2	4.2	4.9	6.2	7.2
8.5	0.21	0.41	0.6	0.78	0.94	1.1	1.3	1.4	1.7	1.9	3.1	4.1	4.9	6.1	7.1
9	0.21	0.4	0.58	0.75	0.91	1.1	1.2	1.4	1.6	1.9	3.1	4	4.8	6	7
9.5	0.2	0.39	0.56	0.73	0.89	1	1.2	1.3	1.6	1.8	3	3.9	4.7	5.9	6.9
10	0.19	0.37	0.54	0.71	0.86	1	1.2	1.3	1.5	1.8	3	3.9	4.6	5.9	6.9
11	0.18	0.35	0.51	0.67	0.81	0.95	1.1	1.2	1.5	1.7	2.8	3.7	4.5	5.7	6.7
12	0.17	0.33	0.49	0.63	0.77	0.91	1	1.2	1.4	1.6	2.7	3.6	4.4	5.6	6.6
13	0.16	0.32	0.46	0.6	0.74	0.87	0.99	1.1	1.3	1.6	2.7	3.5	4.3	5.4	6.4
14	0.15	0.3	0.44	0.58	0.71	0.83	0.95	1.1	1.3	1.5	2.6	3.4	4.1	5.3	6.3
15	0.15	0.29	0.42	0.55	0.68	0.8	0.91	1	1.2	1.5	2.5	3.3	4	5.2	6.2
16	0.14	0.28	0.41	0.53	0.65	0.77	0.88	0.99	1.2	1.4	2.4	3.3	4	5.1	6.1
17	0.13	0.26	0.39	0.51	0.63	0.74	0.85	0.96	1.2	1.4	2.4	3.2	3.9	5	6
18	0.13	0.25	0.38	0.49	0.61	0.72	0.82	0.93	1.1	1.3	2.3	3.1	3.8	4.9	5.9
19	0.13	0.25	0.36	0.48	0.59	0.69	0.8	0.9	1.1	1.3	2.2	3	3.7	4.8	5.8
20	0.12	0.24	0.35	0.46	0.57	0.67	0.77	0.87	1.1	1.2	2.2	3	3.6	4.8	5.7
21	0.12	0.23	0.34	0.45	0.55	0.65	0.75	0.84	1	1.2	2.1	2.9	3.6	4.7	5.6
22	0.11	0.22	0.33	0.43	0.53	0.63	0.73	0.82	1	1.2	2.1	2.8	3.5	4.6	5.5
23	0.11	0.22	0.32	0.42	0.52	0.61	0.71	0.8	0.98	1.2	2	2.8	3.4	4.5	5.4
24	0.11	0.21	0.31	0.41	0.51	0.6	0.69	0.78	0.95	1.1	2	2.7	3.4	4.5	5.4
25	0.1	0.2	0.3	0.4	0.49	0.58	0.67	0.76	0.93	1.1	2	2.7	3.3	4.4	5.3

An "\*" in the table means an INDEX less than 0.005

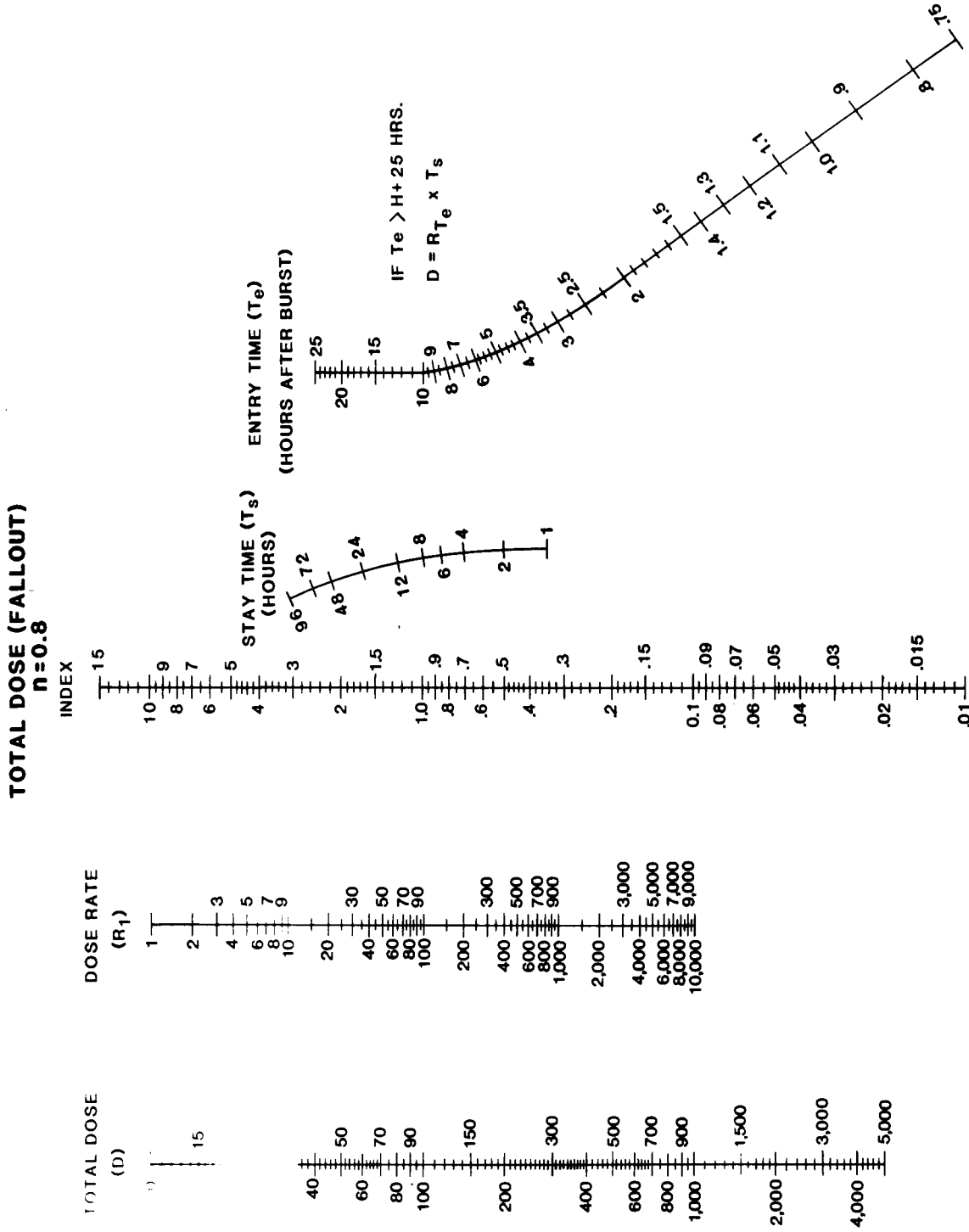

Figure E-32 Total dose (fallout) nomogram  $n = 0.8$ .

Table E-30. Index for total dose (fallout)  $n = 0.8$ .

Enter table with entry time (Te) and stay time (Ts) to find INDEX

Entry time hrs after burst (Te)	Stay time in hours (Ts)															
	1	2	3	4	5	6	7	8	10	12	24	36	48	72	96	
0.75	0.87	1.4	1.8	2.1	2.4	2.6	2.8	3	3.3	3.6	4.8	5.6	6.2	7.1	7.8	
0.8	0.84	1.4	1.8	2.1	2.3	2.6	2.8	2.9	3.3	3.5	4.7	5.5	6.1	7	7.7	
0.9	0.79	1.3	1.7	2	2.2	2.5	2.7	2.9	3.2	3.4	4.6	5.4	6	6.9	7.6	
1	0.74	1.2	1.6	1.9	2.2	2.4	2.6	2.8	3.1	3.4	4.5	5.3	5.9	6.8	7.5	
1.1	0.7	1.2	1.5	1.8	2.1	2.3	2.5	2.7	3	3.3	4.4	5.2	5.8	6.7	7.4	
1.2	0.67	1.1	1.5	1.8	2	2.2	2.4	2.6	2.9	3.2	4.4	5.1	5.7	6.6	7.3	
1.3	0.64	1.1	1.4	1.7	2	2.2	2.4	2.5	2.9	3.1	4.3	5	5.6	6.5	7.2	
1.4	0.61	1	1.4	1.7	1.9	2.1	2.3	2.5	2.8	3.1	4.2	5	5.6	6.5	7.2	
1.5	0.58	1	1.3	1.6	1.9	2.1	2.3	2.4	2.7	3	4.1	4.9	5.5	6.4	7.1	
1.6	0.56	0.97	1.3	1.6	1.8	2	2.2	2.4	2.7	2.9	4.1	4.8	5.4	6.3	7	
1.7	0.54	0.94	1.3	1.5	1.8	2	2.2	2.3	2.6	2.9	4	4.8	5.4	6.3	6.9	
1.8	0.52	0.91	1.2	1.5	1.7	1.9	2.1	2.3	2.6	2.8	4	4.7	5.3	6.2	6.9	
1.9	0.5	0.88	1.2	1.5	1.7	1.9	2.1	2.2	2.5	2.8	3.9	4.7	5.2	6.1	6.8	
2	0.48	0.85	1.2	1.4	1.6	1.8	2	2.2	2.5	2.7	3.9	4.6	5.2	6.1	6.8	
2.25	0.45	0.8	1.1	1.3	1.6	1.7	1.9	2.1	2.4	2.6	3.7	4.5	5.1	6	6.6	
2.5	0.42	0.75	1	1.3	1.5	1.7	1.8	2	2.3	2.5	3.6	4.4	5	5.8	6.5	
2.75	0.39	0.71	0.97	1.2	1.4	1.6	1.8	1.9	2.2	2.4	3.5	4.3	4.9	5.7	6.4	
3	0.37	0.67	0.93	1.2	1.4	1.5	1.7	1.9	2.1	2.4	3.4	4.2	4.8	5.6	6.3	
3.25	0.35	0.64	0.88	1.1	1.3	1.5	1.6	1.8	2.1	2.3	3.4	4.1	4.7	5.5	6.2	
3.5	0.33	0.61	0.85	1.1	1.3	1.4	1.6	1.7	2	2.2	3.3	4	4.6	5.5	6.1	
3.75	0.32	0.58	0.81	1	1.2	1.4	1.5	1.7	1.9	2.2	3.2	3.9	4.5	5.4	6	
4	0.3	0.56	0.78	0.98	1.2	1.3	1.5	1.6	1.9	2.1	3.1	3.9	4.4	5.3	6	
4.5	0.28	0.52	0.73	0.92	1.1	1.3	1.4	1.5	1.8	2	3	3.7	4.3	5.2	5.8	
5	0.26	0.48	0.68	0.88	1	1.2	1.3	1.5	1.7	1.9	2.9	3.6	4.2	5	5.7	
5.5	0.24	0.45	0.64	0.81	0.97	1.1	1.3	1.4	1.6	1.8	2.8	3.5	4.1	4.9	5.6	
6	0.22	0.42	0.6	0.77	0.92	1.1	1.2	1.3	1.6	1.8	2.7	3.4	4	4.8	5.5	
6.5	0.21	0.4	0.57	0.73	0.88	1	1.1	1.3	1.5	1.7	2.6	3.3	3.9	4.7	5.4	
7	0.2	0.38	0.55	0.7	0.84	0.97	1.1	1.2	1.4	1.6	2.6	3.2	3.8	4.6	5.3	
7.5	0.19	0.36	0.52	0.67	0.8	0.93	1.1	1.2	1.4	1.6	2.5	3.2	3.7	4.5	5.2	
8	0.18	0.35	0.5	0.64	0.77	0.9	1	1.1	1.3	1.5	2.4	3.1	3.6	4.4	5.1	
8.5	0.17	0.33	0.48	0.62	0.74	0.88	0.98	1.1	1.3	1.5	2.4	3	3.5	4.4	5	
9	0.17	0.32	0.46	0.59	0.72	0.83	0.95	1.1	1.3	1.4	2.3	3	3.5	4.3	4.9	
9.5	0.16	0.31	0.44	0.57	0.69	0.81	0.92	1	1.2	1.4	2.3	2.9	3.4	4.2	4.9	
10	0.15	0.29	0.43	0.55	0.67	0.78	0.89	0.99	1.2	1.4	2.2	2.8	3.3	4.2	4.8	
11	0.14	0.27	0.4	0.52	0.63	0.73	0.84	0.93	1.1	1.3	2.1	2.7	3.2	4	4.7	
12	0.13	0.26	0.38	0.49	0.59	0.69	0.79	0.88	1.1	1.2	2	2.6	3.1	3.9	4.5	
13	0.12	0.24	0.35	0.46	0.56	0.66	0.75	0.84	1	1.2	1.9	2.5	3	3.8	4.4	
14	0.12	0.23	0.34	0.44	0.53	0.63	0.72	0.8	0.96	1.1	1.9	2.5	2.9	3.7	4.3	
15	0.11	0.22	0.32	0.42	0.51	0.6	0.68	0.77	0.92	1.1	1.8	2.4	2.9	3.6	4.2	
16	0.11	0.21	0.3	0.4	0.49	0.57	0.66	0.74	0.89	1	1.8	2.3	2.8	3.5	4.1	
17	0.1	0.2	0.29	0.38	0.47	0.55	0.63	0.71	0.85	0.99	1.7	2.3	2.7	3.5	4.1	
18	0.1	0.19	0.28	0.36	0.45	0.53	0.61	0.68	0.82	0.96	1.7	2.2	2.6	3.4	4	
19	0.09	0.18	0.27	0.35	0.43	0.51	0.58	0.66	0.8	0.93	1.6	2.1	2.6	3.3	3.9	
20	0.09	0.18	0.26	0.34	0.42	0.49	0.56	0.63	0.77	0.9	1.6	2.1	2.5	3.3	3.8	
21	0.09	0.17	0.25	0.33	0.4	0.47	0.54	0.61	0.74	0.87	1.5	2	2.5	3.2	3.8	
22	0.08	0.16	0.24	0.32	0.39	0.46	0.53	0.59	0.72	0.84	1.5	2	2.4	3.1	3.7	
23	0.08	0.16	0.23	0.31	0.38	0.44	0.51	0.58	0.7	0.82	1.4	1.9	2.4	3.1	3.6	
24	0.08	0.15	0.23	0.3	0.36	0.43	0.5	0.56	0.68	0.8	1.4	1.9	2.3	3	3.6	
25	0.07	0.15	0.22	0.29	0.35	0.42	0.48	0.54	0.66	0.78	1.4	1.9	2.3	3	3.5	

An "\*" in the table means an INDEX less than 0.005

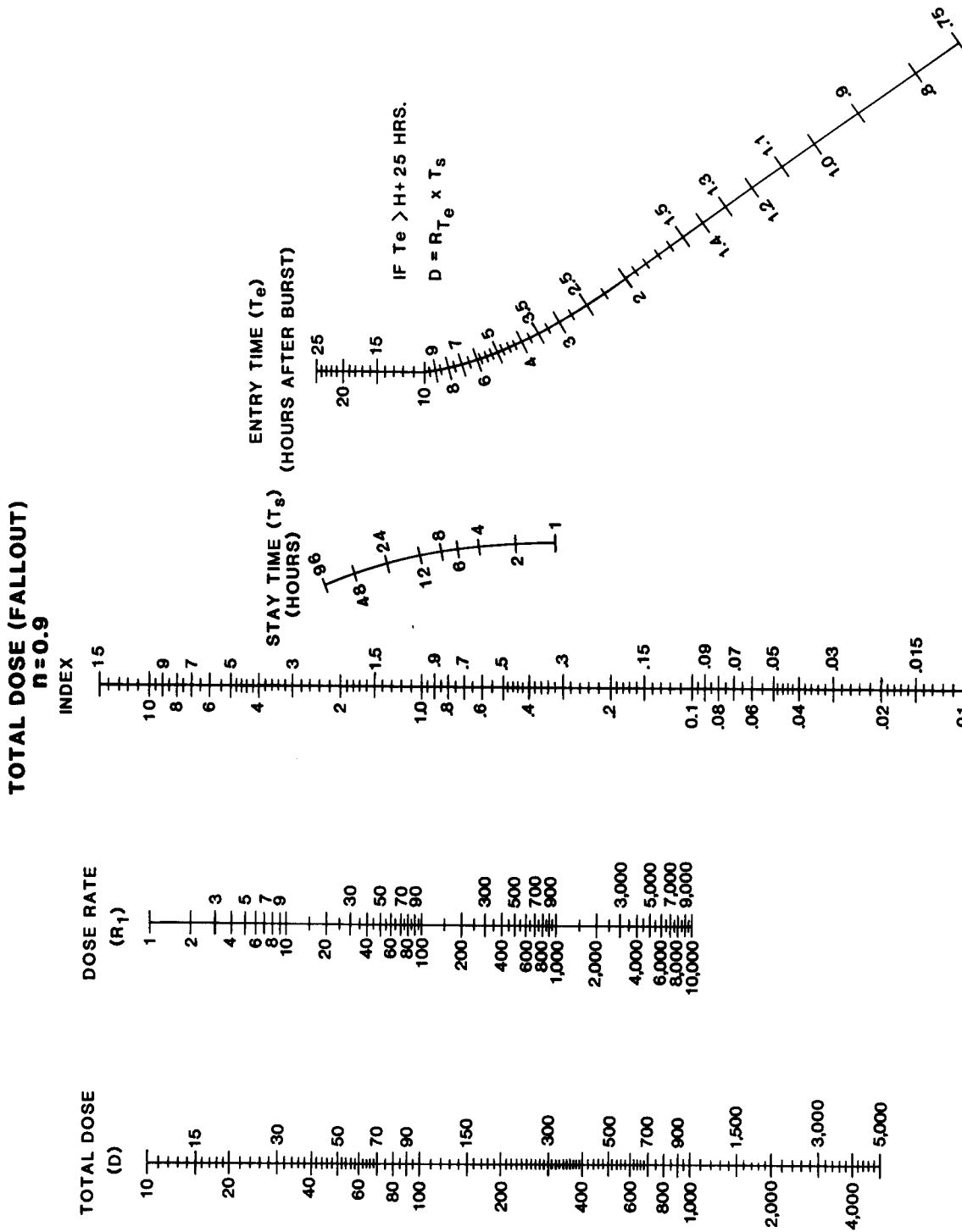

Figure E-33. Total dose (fallout) nomogram  $n = 0.9$ .

Table E-31. Index for total dose (fallout)  $n = 0.9$ .

Enter table with entry time (Te) and stay time (Ts) to find INDEX

Entry time hrs after burst (Te)	Stay time in hours (Ts)														
	1	2	3	4	5	6	7	8	10	12	24	36	48	72	96
0.75	0.86	1.4	1.7	2	2.2	2.4	2.6	2.7	3	3.2	4.1	4.6	5	5.6	6.1
0.8	0.83	1.3	1.7	1.9	2.1	2.3	2.5	2.7	2.9	3.1	4	4.6	5	5.6	6
0.9	0.77	1.2	1.6	1.8	2.1	2.2	2.4	2.6	2.8	3	3.9	4.5	4.9	5.5	5.9
1	0.72	1.2	1.5	1.8	2	2.2	2.3	2.5	2.7	2.9	3.8	4.4	4.8	5.4	5.8
1.1	0.67	1.1	1.4	1.7	1.9	2.1	2.2	2.4	2.6	2.8	3.7	4.3	4.7	5.3	5.7
1.2	0.64	1.1	1.4	1.6	1.8	2	2.2	2.3	2.6	2.8	3.6	4.2	4.6	5.2	5.6
1.3	0.6	1	1.3	1.6	1.8	1.9	2.1	2.2	2.5	2.7	3.6	4.1	4.5	5.1	5.5
1.4	0.57	0.96	1.3	1.5	1.7	1.9	2	2.2	2.4	2.6	3.5	4	4.4	5	5.5
1.5	0.55	0.92	1.2	1.4	1.6	1.8	2	2.1	2.4	2.6	3.4	4	4.4	5	5.4
1.6	0.52	0.90	1.2	1.4	1.6	1.8	1.9	2.1	2.3	2.5	3.4	3.9	4.3	4.9	5.3
1.7	0.5	0.85	1.1	1.4	1.6	1.7	1.9	2	2.2	2.5	3.3	3.8	4.2	4.8	5.3
1.8	0.48	0.82	1.1	1.3	1.5	1.7	1.8	2	2.2	2.4	3.2	3.8	4.2	4.8	5.2
1.9	0.46	0.8	1.1	1.3	1.5	1.6	1.8	1.9	2.2	2.4	3.2	3.7	4.1	4.7	5.2
2	0.44	0.77	1	1.2	1.4	1.6	1.7	1.9	2.1	2.3	3.1	3.7	4.1	4.7	5.1
2.25	0.41	0.71	0.96	1.2	1.4	1.5	1.7	1.8	2	2.2	3	3.6	4	4.5	5
2.5	0.38	0.66	0.9	1.1	1.3	1.4	1.6	1.7	1.9	2.1	2.9	3.5	3.8	4.4	4.9
2.75	0.35	0.62	0.85	1	1.2	1.4	1.5	1.6	1.8	2	2.8	3.4	3.8	4.3	4.8
3	0.33	0.58	0.8	0.99	1.2	1.3	1.4	1.6	1.8	2	2.7	3.3	3.7	4.2	4.7
3.25	0.31	0.55	0.76	0.94	1.1	1.2	1.4	1.5	1.7	1.9	2.7	3.2	3.6	4.2	4.6
3.5	0.29	0.52	0.72	0.9	1.1	1.2	1.3	1.4	1.6	1.8	2.6	3.1	3.5	4.1	4.5
3.75	0.27	0.5	0.69	0.86	1	1.1	1.3	1.4	1.6	1.8	2.5	3	3.4	4	4.4
4	0.26	0.48	0.66	0.82	0.97	1.1	1.2	1.3	1.5	1.7	2.5	3	3.4	3.9	4.4
4.5	0.24	0.44	0.61	0.76	0.9	1	1.1	1.3	1.4	1.6	2.4	2.9	3.2	3.8	4.2
5	0.22	0.4	0.57	0.71	0.84	0.96	1.1	1.2	1.4	1.5	2.3	2.8	3.1	3.7	4.1
5.5	0.2	0.37	0.53	0.67	0.79	0.91	1	1.1	1.3	1.5	2.2	2.7	3	3.6	4
6	0.19	0.35	0.49	0.63	0.75	0.86	0.96	1.1	1.2	1.4	2.1	2.6	2.9	3.5	3.9
6.5	0.17	0.33	0.47	0.59	0.71	0.81	0.91	1	1.2	1.3	2	2.5	2.9	3.4	3.8
7	0.16	0.31	0.44	0.56	0.67	0.78	0.87	0.96	1.1	1.3	2	2.4	2.8	3.3	3.8
7.5	0.15	0.29	0.42	0.53	0.64	0.74	0.83	0.92	1.1	1.2	1.9	2.4	2.7	3.3	3.7
8	0.15	0.28	0.4	0.51	0.61	0.71	0.8	0.88	1	1.2	1.8	2.3	2.6	3.2	3.6
8.5	0.14	0.26	0.38	0.49	0.59	0.68	0.77	0.85	1	1.1	1.8	2.2	2.6	3.1	3.5
9	0.13	0.25	0.36	0.47	0.56	0.65	0.74	0.82	0.97	1.1	1.7	2.2	2.5	3.1	3.5
9.5	0.13	0.24	0.35	0.45	0.54	0.63	0.71	0.79	0.93	1.1	1.7	2.1	2.5	3	3.4
10	0.12	0.23	0.33	0.43	0.52	0.61	0.69	0.76	0.9	1	1.6	2.1	2.4	3	3.4
11	0.11	0.21	0.31	0.4	0.49	0.57	0.64	0.71	0.85	0.97	1.6	2	2.3	2.9	3.3
12	0.1	0.2	0.29	0.37	0.45	0.53	0.6	0.67	0.8	0.92	1.5	1.9	2.2	2.8	3.2
13	0.1	0.19	0.27	0.35	0.43	0.5	0.57	0.63	0.76	0.87	1.4	1.8	2.2	2.7	3.1
14	0.09	0.18	0.26	0.33	0.4	0.47	0.54	0.6	0.72	0.83	1.4	1.8	2.1	2.6	3
15	0.08	0.17	0.24	0.31	0.38	0.45	0.51	0.57	0.69	0.79	1.3	1.7	2	2.5	2.9
16	0.08	0.16	0.23	0.3	0.36	0.43	0.49	0.55	0.66	0.76	1.3	1.7	2	2.5	2.8
17	0.08	0.15	0.22	0.28	0.35	0.41	0.47	0.52	0.63	0.73	1.2	1.6	1.9	2.4	2.8
18	0.07	0.14	0.21	0.27	0.33	0.39	0.45	0.5	0.6	0.7	1.2	1.6	1.9	2.3	2.7
19	0.07	0.14	0.2	0.26	0.32	0.37	0.43	0.48	0.58	0.67	1.1	1.5	1.8	2.3	2.7
20	0.07	0.13	0.19	0.25	0.3	0.36	0.41	0.46	0.56	0.65	1.1	1.5	1.8	2.2	2.6
21	0.06	0.12	0.18	0.24	0.29	0.35	0.4	0.44	0.54	0.63	1.1	1.4	1.7	2.2	2.5
22	0.06	0.12	0.18	0.23	0.28	0.33	0.38	0.43	0.52	0.61	1	1.4	1.7	2.1	2.5
23	0.06	0.11	0.17	0.22	0.27	0.32	0.37	0.41	0.5	0.59	1	1.4	1.6	2.1	2.4
24	0.06	0.11	0.16	0.21	0.26	0.31	0.36	0.4	0.49	0.57	0.99	1.3	1.6	2	2.4
25	0.05	0.11	0.16	0.21	0.25	0.3	0.34	0.39	0.47	0.55	0.96	1.3	1.6	2	2.4

An "\*" in the table means an INDEX less than 0.005

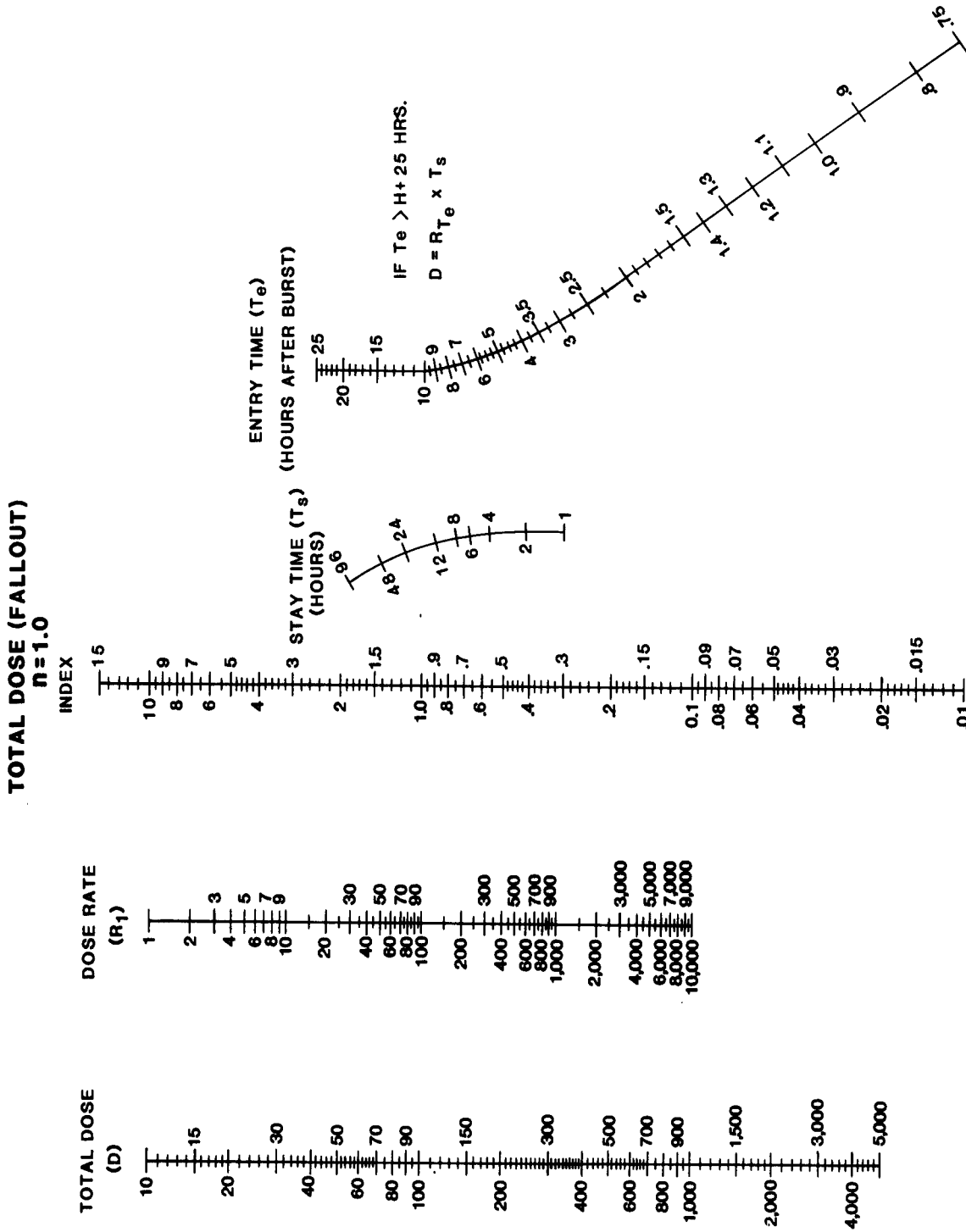

Figure E-34. Total dose (fallout) nomogram  $n = 1.0$ .

Table E-32. Index for total dose (fallout)  $n = 1.0$ .

Enter table with entry time (Te) and stay time (Ts) to find INDEX

Entry time hrs after burst (Te)	Stay time in hours (Ts)															
	1	2	3	4	5	6	7	8	10	12	24	36	48	72	96	
0.75	0.85	1.3	1.8	1.9	2	2.2	2.3	2.5	2.7	2.8	3.5	3.9	4.2	4.6	4.9	
0.8	0.81	1.3	1.8	1.8	2	2.1	2.3	2.4	2.6	2.8	3.4	3.8	4.1	4.5	4.8	
0.9	0.75	1.2	1.5	1.7	1.9	2	2.2	2.3	2.5	2.7	3.3	3.7	4	4.4	4.7	
1	0.69	1.1	1.4	1.6	1.8	2	2.1	2.2	2.4	2.6	3.2	3.6	3.9	4.3	4.6	
1.1	0.65	1	1.3	1.5	1.7	1.9	2	2.1	2.3	2.5	3.1	3.5	3.8	4.2	4.5	
1.2	0.61	0.98	1.3	1.5	1.6	1.8	1.9	2	2.2	2.4	3	3.4	3.7	4.1	4.4	
1.3	0.57	0.93	1.2	1.4	1.6	1.7	1.9	2	2.2	2.3	3	3.4	3.6	4	4.3	
1.4	0.54	0.89	1.2	1.4	1.5	1.7	1.8	1.9	2.1	2.3	2.9	3.3	3.6	4	4.2	
1.5	0.51	0.85	1.1	1.3	1.5	1.6	1.7	1.9	2	2.2	2.8	3.2	3.5	3.9	4.2	
1.6	0.49	0.81	1.1	1.3	1.4	1.6	1.7	1.8	2	2.1	2.8	3.2	3.4	3.8	4.1	
1.7	0.46	0.78	1	1.2	1.4	1.5	1.6	1.7	1.9	2.1	2.7	3.1	3.4	3.8	4.1	
1.8	0.44	0.75	0.98	1.2	1.3	1.5	1.6	1.7	1.9	2	2.7	3	3.3	3.7	4	
1.9	0.42	0.72	0.95	1.1	1.3	1.4	1.5	1.7	1.8	2	2.6	3	3.3	3.7	3.9	
2	0.41	0.69	0.92	1.1	1.3	1.4	1.5	1.6	1.8	2	2.6	2.9	3.2	3.6	3.9	
2.25	0.37	0.64	0.85	1	1.2	1.3	1.4	1.5	1.7	1.9	2.5	2.8	3.1	3.5	3.8	
2.5	0.34	0.59	0.79	0.98	1.1	1.2	1.3	1.4	1.6	1.8	2.4	2.7	3	3.4	3.7	
2.75	0.31	0.56	0.74	0.9	1	1.2	1.3	1.4	1.5	1.7	2.3	2.7	2.9	3.3	3.6	
3	0.29	0.51	0.69	0.85	0.98	1.1	1.2	1.3	1.5	1.6	2.2	2.6	2.8	3.2	3.5	
3.25	0.27	0.48	0.65	0.8	0.93	1.1	1.2	1.2	1.4	1.6	2.1	2.5	2.8	3.1	3.4	
3.5	0.25	0.45	0.62	0.76	0.89	1	1.1	1.2	1.4	1.5	2.1	2.4	2.7	3.1	3.4	
3.75	0.24	0.43	0.59	0.73	0.85	0.98	1.1	1.1	1.3	1.4	2	2.4	2.6	3	3.3	
4	0.22	0.41	0.56	0.69	0.81	0.92	1	1.1	1.3	1.4	2	2.3	2.6	2.9	3.2	
4.5	0.2	0.37	0.51	0.64	0.75	0.85	0.94	1	1.2	1.3	1.9	2.2	2.5	2.8	3.1	
5	0.18	0.34	0.47	0.59	0.69	0.79	0.88	0.96	1.1	1.2	1.8	2.1	2.4	2.7	3	
5.5	0.17	0.31	0.44	0.55	0.65	0.74	0.82	0.9	1	1.2	1.7	2	2.3	2.7	2.9	
6	0.15	0.29	0.41	0.51	0.61	0.69	0.77	0.85	0.96	1.1	1.6	2	2.2	2.6	2.8	
6.5	0.14	0.27	0.38	0.48	0.57	0.65	0.73	0.8	0.93	1.1	1.6	1.9	2.1	2.5	2.8	
7	0.13	0.25	0.36	0.45	0.54	0.62	0.69	0.76	0.89	1	1.5	1.8	2.1	2.4	2.7	
7.5	0.13	0.24	0.34	0.43	0.51	0.59	0.66	0.73	0.85	0.96	1.4	1.8	2	2.4	2.6	
8	0.12	0.22	0.32	0.41	0.49	0.56	0.63	0.69	0.81	0.92	1.4	1.7	2	2.3	2.6	
8.5	0.11	0.21	0.3	0.39	0.46	0.53	0.6	0.66	0.78	0.88	1.3	1.7	1.9	2.3	2.5	
9	0.11	0.2	0.29	0.37	0.44	0.51	0.58	0.64	0.75	0.85	1.3	1.6	1.9	2.2	2.5	
9.5	0.1	0.19	0.27	0.35	0.42	0.49	0.55	0.61	0.72	0.82	1.3	1.6	1.8	2.2	2.4	
10	0.1	0.18	0.26	0.34	0.41	0.47	0.53	0.59	0.69	0.79	1.2	1.5	1.8	2.1	2.4	
11	0.09	0.17	0.24	0.31	0.37	0.44	0.49	0.55	0.65	0.74	1.2	1.5	1.7	2	2.3	
12	0.08	0.15	0.22	0.29	0.35	0.41	0.46	0.51	0.61	0.69	1.1	1.4	1.6	2	2.2	
13	0.07	0.14	0.21	0.27	0.33	0.38	0.43	0.48	0.57	0.65	1.1	1.3	1.6	1.9	2.1	
14	0.07	0.13	0.19	0.25	0.31	0.36	0.41	0.45	0.54	0.62	1	1.3	1.5	1.8	2.1	
15	0.06	0.13	0.18	0.24	0.29	0.34	0.38	0.43	0.51	0.59	0.96	1.2	1.4	1.8	2	
16	0.06	0.12	0.17	0.22	0.27	0.32	0.36	0.41	0.49	0.56	0.92	1.2	1.4	1.7	2	
17	0.06	0.11	0.16	0.21	0.26	0.3	0.34	0.39	0.46	0.53	0.88	1.1	1.3	1.7	1.9	
18	0.05	0.11	0.15	0.2	0.25	0.29	0.33	0.37	0.44	0.51	0.85	1.1	1.3	1.6	1.9	
19	0.05	0.1	0.15	0.19	0.23	0.27	0.31	0.35	0.42	0.49	0.82	1.1	1.3	1.6	1.8	
20	0.05	0.1	0.14	0.18	0.22	0.26	0.3	0.34	0.41	0.47	0.79	1	1.2	1.5	1.8	
21	0.05	0.09	0.13	0.17	0.21	0.25	0.29	0.32	0.39	0.45	0.76	1	1.2	1.5	1.7	
22	0.04	0.09	0.13	0.17	0.2	0.24	0.28	0.31	0.37	0.44	0.74	0.97	1.2	1.5	1.7	
23	0.04	0.08	0.12	0.16	0.2	0.23	0.27	0.3	0.36	0.42	0.71	0.94	1.1	1.4	1.6	
24	0.04	0.08	0.12	0.15	0.19	0.22	0.26	0.29	0.35	0.41	0.69	0.92	1.1	1.4	1.6	
25	0.04	0.08	0.11	0.15	0.18	0.22	0.25	0.28	0.34	0.39	0.67	0.89	1.1	1.4	1.6	

An "\*" in the table means an INDEX less than 0.005



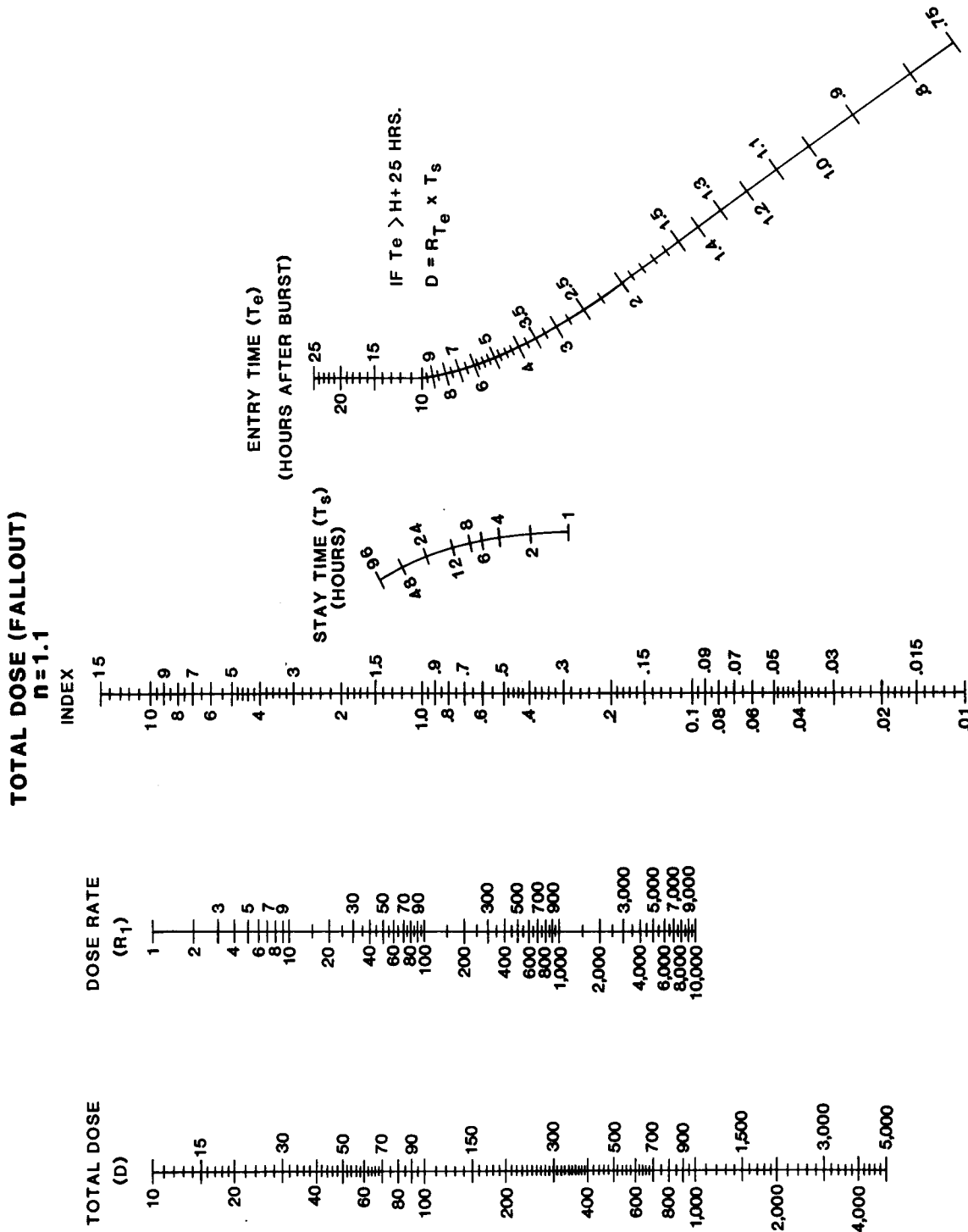

Figure E-35. total dose (fallout) nomogram  $n = 1.1$ .

Table E-33. Index for total dose (fallout)  $n = 1.1$ .

Enter table with entry time (Te) and stay time (Ts) to find INDEX

Entry time hrs after burst (Te)	Stay time in hours (Ts)														
	1	2	3	4	5	6	7	8	10	12	24	36	48	72	96
0.75	0.84	1.3	1.5	1.7	1.9	2	2.1	2.2	2.4	2.5	3	3.3	3.5	3.8	4
0.8	0.8	1.2	1.5	1.7	1.8	2	2.1	2.2	2.3	2.5	3	3.3	3.5	3.7	3.9
0.9	0.73	1.1	1.4	1.6	1.7	1.9	2	2.1	2.2	2.4	2.9	3.1	3.3	3.6	3.8
1	0.67	1	1.3	1.5	1.6	1.8	1.9	2	2.1	2.3	2.8	3	3.2	3.5	3.7
1.1	0.62	0.97	1.2	1.4	1.6	1.7	1.8	1.9	2	2.2	2.7	2.9	3.1	3.4	3.6
1.2	0.58	0.92	1.2	1.3	1.5	1.6	1.7	1.8	2	2.1	2.6	2.9	3.1	3.3	3.5
1.3	0.54	0.87	1.1	1.3	1.4	1.5	1.7	1.7	1.9	2	2.5	2.8	3	3.2	3.4
1.4	0.51	0.82	1.1	1.2	1.4	1.5	1.6	1.7	1.8	2	2.4	2.7	2.9	3.2	3.3
1.5	0.48	0.78	1	1.2	1.3	1.4	1.5	1.6	1.8	1.9	2.4	2.6	2.8	3.1	3.3
1.6	0.45	0.74	0.98	1.1	1.3	1.4	1.5	1.6	1.7	1.8	2.3	2.6	2.8	3	3.2
1.7	0.43	0.71	0.92	1.1	1.2	1.3	1.4	1.5	1.7	1.8	2.3	2.5	2.7	3	3.2
1.8	0.41	0.68	0.88	1	1.2	1.3	1.4	1.5	1.6	1.7	2.2	2.5	2.7	2.9	3.1
1.9	0.39	0.65	0.85	1	1.1	1.3	1.3	1.4	1.6	1.7	2.2	2.4	2.6	2.9	3.1
2	0.37	0.62	0.82	0.97	1.1	1.2	1.3	1.4	1.5	1.7	2.1	2.4	2.6	2.8	3
2.25	0.33	0.57	0.75	0.9	1	1.1	1.2	1.3	1.4	1.6	2	2.3	2.5	2.7	2.9
2.5	0.3	0.52	0.69	0.83	0.95	1.1	1.1	1.2	1.4	1.5	1.9	2.2	2.4	2.6	2.8
2.75	0.28	0.48	0.64	0.78	0.89	0.99	1.1	1.2	1.3	1.4	1.8	2.1	2.3	2.5	2.7
3	0.25	0.45	0.6	0.73	0.84	0.93	1	1.1	1.2	1.3	1.8	2	2.2	2.5	2.6
3.25	0.24	0.42	0.56	0.69	0.79	0.88	0.96	1	1.2	1.3	1.7	2	2.1	2.4	2.6
3.5	0.22	0.39	0.53	0.65	0.75	0.84	0.92	0.99	1.1	1.2	1.6	1.9	2.1	2.3	2.5
3.75	0.2	0.37	0.5	0.61	0.71	0.8	0.88	0.95	1.1	1.2	1.6	1.8	2	2.3	2.5
4	0.19	0.35	0.47	0.58	0.68	0.76	0.84	0.91	1	1.1	1.5	1.8	2	2.2	2.4
4.5	0.17	0.31	0.43	0.53	0.62	0.7	0.77	0.84	0.95	1.1	1.5	1.7	1.9	2.1	2.3
5	0.15	0.28	0.39	0.49	0.57	0.65	0.71	0.78	0.89	0.96	1.4	1.6	1.8	2	2.2
5.5	0.14	0.26	0.36	0.45	0.53	0.6	0.66	0.72	0.83	0.92	1.3	1.5	1.7	2	2.1
6	0.13	0.24	0.33	0.42	0.49	0.56	0.62	0.68	0.78	0.87	1.2	1.5	1.7	1.9	2.1
6.5	0.12	0.22	0.31	0.39	0.46	0.52	0.58	0.64	0.74	0.82	1.2	1.4	1.6	1.8	2
7	0.11	0.2	0.29	0.36	0.43	0.49	0.55	0.6	0.7	0.78	1.1	1.4	1.5	1.8	1.9
7.5	0.1	0.19	0.27	0.34	0.41	0.47	0.52	0.57	0.66	0.74	1.1	1.3	1.5	1.7	1.9
8	0.1	0.18	0.25	0.32	0.38	0.44	0.49	0.54	0.63	0.71	1.1	1.3	1.4	1.7	1.8
8.5	0.09	0.17	0.24	0.31	0.36	0.42	0.47	0.52	0.6	0.68	1	1.2	1.4	1.6	1.8
9	0.08	0.16	0.23	0.29	0.35	0.4	0.45	0.49	0.58	0.65	0.98	1.2	1.4	1.6	1.8
9.5	0.08	0.15	0.22	0.28	0.33	0.38	0.43	0.47	0.55	0.63	0.95	1.2	1.3	1.5	1.7
10	0.08	0.14	0.21	0.26	0.32	0.36	0.41	0.45	0.53	0.6	0.91	1.1	1.3	1.5	1.7
11	0.07	0.13	0.19	0.24	0.29	0.34	0.38	0.42	0.49	0.56	0.86	1.1	1.2	1.4	1.6
12	0.06	0.12	0.17	0.22	0.27	0.31	0.35	0.39	0.46	0.52	0.81	1	1.2	1.4	1.5
13	0.06	0.11	0.16	0.2	0.25	0.29	0.33	0.36	0.43	0.49	0.77	0.96	1.1	1.3	1.5
14	0.05	0.1	0.15	0.19	0.23	0.27	0.31	0.34	0.4	0.46	0.73	0.92	1.1	1.3	1.4
15	0.05	0.09	0.14	0.18	0.22	0.25	0.29	0.32	0.38	0.44	0.7	0.88	1	1.2	1.4
16	0.05	0.09	0.13	0.17	0.2	0.24	0.27	0.3	0.36	0.41	0.66	0.84	0.98	1.2	1.3
17	0.04	0.08	0.12	0.16	0.19	0.22	0.26	0.28	0.34	0.39	0.63	0.81	0.95	1.2	1.3
18	0.04	0.08	0.11	0.15	0.18	0.21	0.24	0.27	0.32	0.37	0.61	0.78	0.91	1.1	1.3
19	0.04	0.07	0.11	0.14	0.17	0.2	0.23	0.26	0.31	0.36	0.58	0.75	0.88	1.1	1.2
20	0.04	0.07	0.1	0.13	0.16	0.19	0.22	0.25	0.29	0.34	0.56	0.73	0.85	1.1	1.2
21	0.03	0.07	0.1	0.13	0.16	0.18	0.21	0.23	0.28	0.33	0.54	0.7	0.83	1	1.2
22	0.03	0.06	0.09	0.12	0.15	0.17	0.2	0.22	0.27	0.31	0.52	0.68	0.8	0.99	1.1
23	0.03	0.06	0.09	0.12	0.14	0.17	0.19	0.21	0.26	0.3	0.5	0.66	0.78	0.97	1.1
24	0.03	0.06	0.09	0.11	0.14	0.16	0.18	0.21	0.25	0.29	0.49	0.64	0.76	0.94	1.1
25	0.03	0.06	0.08	0.11	0.13	0.15	0.18	0.2	0.24	0.28	0.47	0.62	0.74	0.92	1.1

An "\*" in the table means an INDEX less than 0.005

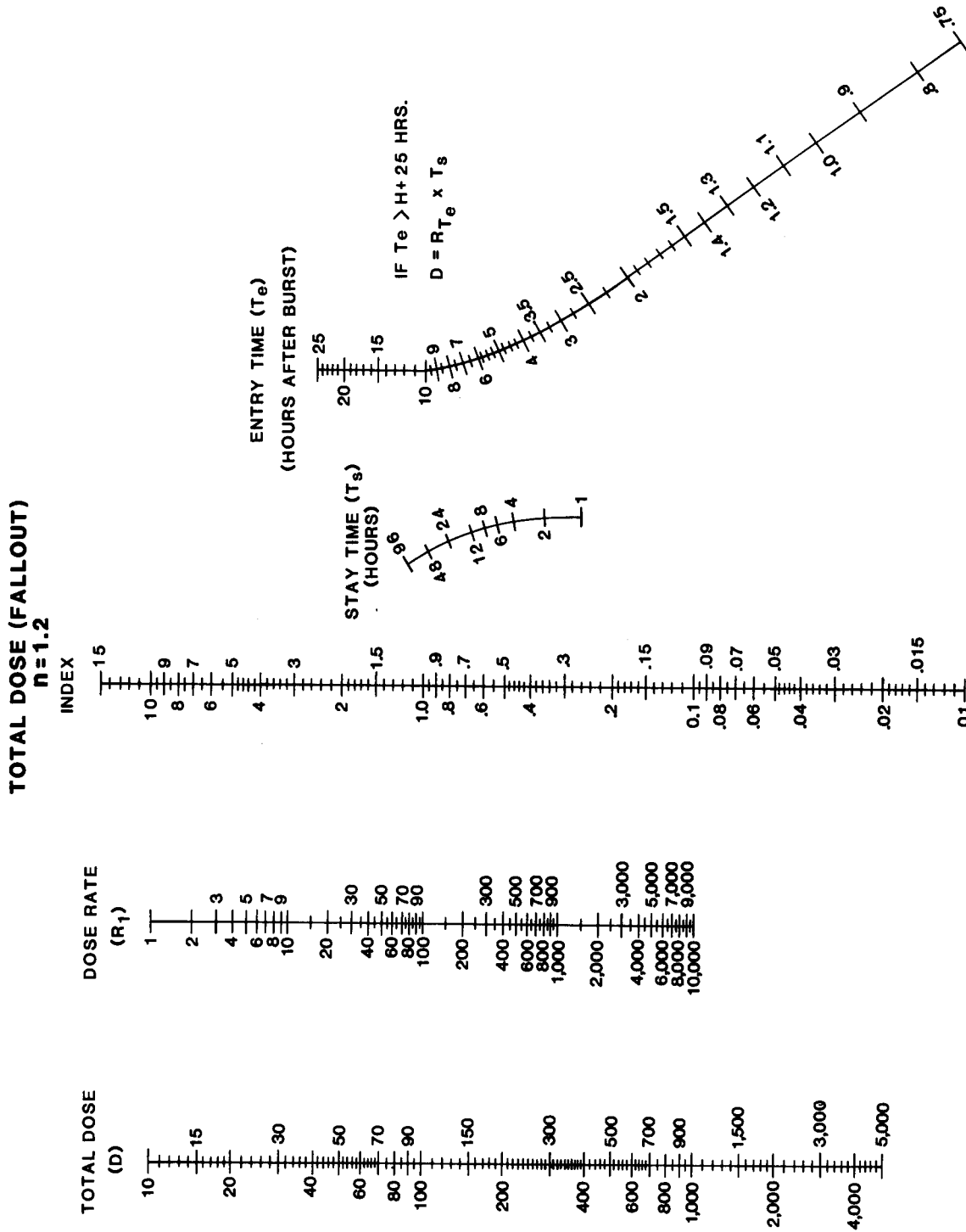

Figure E-36. Total dose (fallout) nomogram n = 1.2.

Table E-34. Index for total dose (fallout)  $n = 1.2$ .

Enter table with entry time (Te) and stay time (Ts) to find INDEX

Entry time hrs after burst (Te)	Stay time in hours (Ts)														
	1	2	3	4	5	6	7	8	10	12	24	36	48	72	96
0.75	0.83	1.2	1.5	1.6	1.8	1.9	2	2.1	2.2	2.3	2.7	2.9	3	3.2	3.3
0.8	0.78	1.2	1.4	1.6	1.7	1.8	1.9	2	2.1	2.2	2.6	2.8	2.9	3.1	3.2
0.9	0.71	1.1	1.3	1.5	1.6	1.7	1.8	1.9	2	2.1	2.5	2.7	2.8	3	3.1
1	0.65	0.99	1.2	1.4	1.5	1.6	1.7	1.8	1.9	2	2.4	2.6	2.7	2.9	3
1.1	0.6	0.92	1.1	1.3	1.4	1.5	1.6	1.7	1.8	1.9	2.3	2.5	2.6	2.8	2.9
1.2	0.55	0.86	1.1	1.2	1.4	1.5	1.5	1.6	1.7	1.8	2.2	2.4	2.5	2.7	2.8
1.3	0.51	0.81	1	1.2	1.3	1.4	1.5	1.5	1.7	1.8	2.1	2.3	2.5	2.6	2.7
1.4	0.48	0.78	0.96	1.1	1.2	1.3	1.4	1.5	1.6	1.7	2.1	2.3	2.4	2.6	2.7
1.5	0.45	0.72	0.91	1.1	1.2	1.3	1.4	1.4	1.5	1.6	2	2.2	2.3	2.5	2.6
1.6	0.42	0.68	0.87	1	1.1	1.2	1.3	1.4	1.5	1.6	1.9	2.1	2.3	2.4	2.6
1.7	0.4	0.65	0.83	0.97	1.1	1.2	1.3	1.3	1.4	1.5	1.9	2.1	2.2	2.4	2.5
1.8	0.38	0.62	0.79	0.93	1	1.1	1.2	1.3	1.4	1.5	1.8	2	2.2	2.3	2.5
1.9	0.36	0.59	0.76	0.89	1	1.1	1.2	1.2	1.4	1.4	1.8	2	2.1	2.3	2.4
2	0.34	0.56	0.73	0.86	0.96	1.1	1.1	1.2	1.3	1.4	1.8	1.9	2.1	2.2	2.4
2.25	0.3	0.51	0.68	0.79	0.89	0.97	1.1	1.1	1.2	1.3	1.7	1.8	2	2.1	2.3
2.5	0.27	0.46	0.61	0.72	0.82	0.9	0.96	1	1.2	1.2	1.6	1.8	1.9	2.1	2.2
2.75	0.25	0.42	0.56	0.67	0.76	0.84	0.91	0.97	1.1	1.2	1.5	1.7	1.8	2	2.1
3	0.22	0.39	0.52	0.63	0.71	0.79	0.86	0.92	1	1.1	1.4	1.6	1.7	1.9	2
3.25	0.21	0.36	0.48	0.59	0.67	0.75	0.81	0.87	0.97	1.1	1.4	1.6	1.7	1.8	2
3.5	0.19	0.34	0.45	0.55	0.63	0.7	0.77	0.82	0.92	1	1.3	1.5	1.6	1.8	1.9
3.75	0.18	0.31	0.43	0.52	0.6	0.67	0.73	0.78	0.86	0.96	1.3	1.4	1.6	1.7	1.9
4	0.17	0.3	0.4	0.49	0.57	0.63	0.69	0.75	0.84	0.92	1.2	1.4	1.5	1.7	1.8
4.5	0.15	0.28	0.36	0.44	0.51	0.56	0.63	0.68	0.77	0.85	1.1	1.3	1.4	1.6	1.7
5	0.13	0.24	0.33	0.4	0.47	0.53	0.58	0.63	0.71	0.79	1.1	1.2	1.4	1.5	1.6
5.5	0.12	0.21	0.3	0.37	0.43	0.49	0.54	0.58	0.67	0.73	1	1.2	1.3	1.5	1.6
6	0.11	0.2	0.27	0.34	0.4	0.45	0.5	0.54	0.62	0.69	0.96	1.1	1.2	1.4	1.5
6.5	0.1	0.18	0.25	0.31	0.37	0.42	0.47	0.51	0.58	0.65	0.91	1.1	1.2	1.4	1.5
7	0.09	0.17	0.23	0.29	0.35	0.39	0.44	0.48	0.55	0.61	0.87	1	1.1	1.3	1.4
7.5	0.08	0.15	0.22	0.27	0.32	0.37	0.41	0.45	0.52	0.58	0.83	0.99	1.1	1.3	1.4
8	0.08	0.14	0.2	0.26	0.31	0.35	0.39	0.43	0.49	0.55	0.8	0.95	1.1	1.2	1.3
8.5	0.07	0.13	0.19	0.24	0.29	0.33	0.37	0.4	0.47	0.53	0.77	0.92	1	1.2	1.3
9	0.07	0.13	0.18	0.23	0.27	0.31	0.35	0.38	0.45	0.5	0.74	0.89	0.99	1.2	1.3
9.5	0.06	0.12	0.17	0.22	0.26	0.3	0.33	0.37	0.43	0.48	0.71	0.86	0.96	1.1	1.2
10	0.06	0.11	0.16	0.21	0.25	0.28	0.32	0.35	0.41	0.46	0.68	0.83	0.94	1.1	1.2
11	0.05	0.1	0.15	0.19	0.22	0.26	0.29	0.32	0.38	0.42	0.64	0.78	0.88	1	1.1
12	0.05	0.09	0.13	0.17	0.2	0.24	0.27	0.3	0.35	0.39	0.6	0.74	0.84	0.96	1.1
13	0.04	0.08	0.12	0.16	0.19	0.22	0.25	0.27	0.32	0.37	0.57	0.7	0.8	0.94	1
14	0.04	0.08	0.11	0.14	0.17	0.2	0.23	0.25	0.3	0.34	0.53	0.66	0.76	0.9	1
15	0.04	0.07	0.1	0.13	0.16	0.19	0.21	0.24	0.28	0.32	0.51	0.63	0.73	0.86	0.96
16	0.03	0.07	0.1	0.13	0.15	0.18	0.2	0.22	0.27	0.3	0.48	0.6	0.7	0.83	0.93
17	0.03	0.06	0.09	0.12	0.14	0.17	0.19	0.21	0.25	0.29	0.46	0.58	0.67	0.8	0.89
18	0.03	0.06	0.09	0.11	0.13	0.16	0.18	0.2	0.24	0.27	0.44	0.55	0.64	0.77	0.87
19	0.03	0.05	0.08	0.1	0.13	0.15	0.17	0.19	0.23	0.26	0.42	0.53	0.62	0.75	0.84
20	0.03	0.05	0.08	0.1	0.12	0.14	0.16	0.18	0.21	0.25	0.4	0.51	0.6	0.72	0.81
21	0.03	0.05	0.07	0.09	0.11	0.13	0.15	0.17	0.2	0.24	0.38	0.49	0.58	0.7	0.79
22	0.02	0.05	0.07	0.09	0.11	0.13	0.14	0.16	0.19	0.22	0.37	0.47	0.56	0.68	0.77
23	0.02	0.04	0.06	0.08	0.1	0.12	0.14	0.15	0.19	0.22	0.36	0.46	0.54	0.66	0.75
24	0.02	0.04	0.06	0.08	0.1	0.12	0.13	0.15	0.18	0.21	0.34	0.44	0.52	0.64	0.73
25	0.02	0.04	0.06	0.08	0.09	0.11	0.13	0.14	0.17	0.2	0.33	0.43	0.51	0.62	0.71

An "\*" in the table means an INDEX less than 0.005

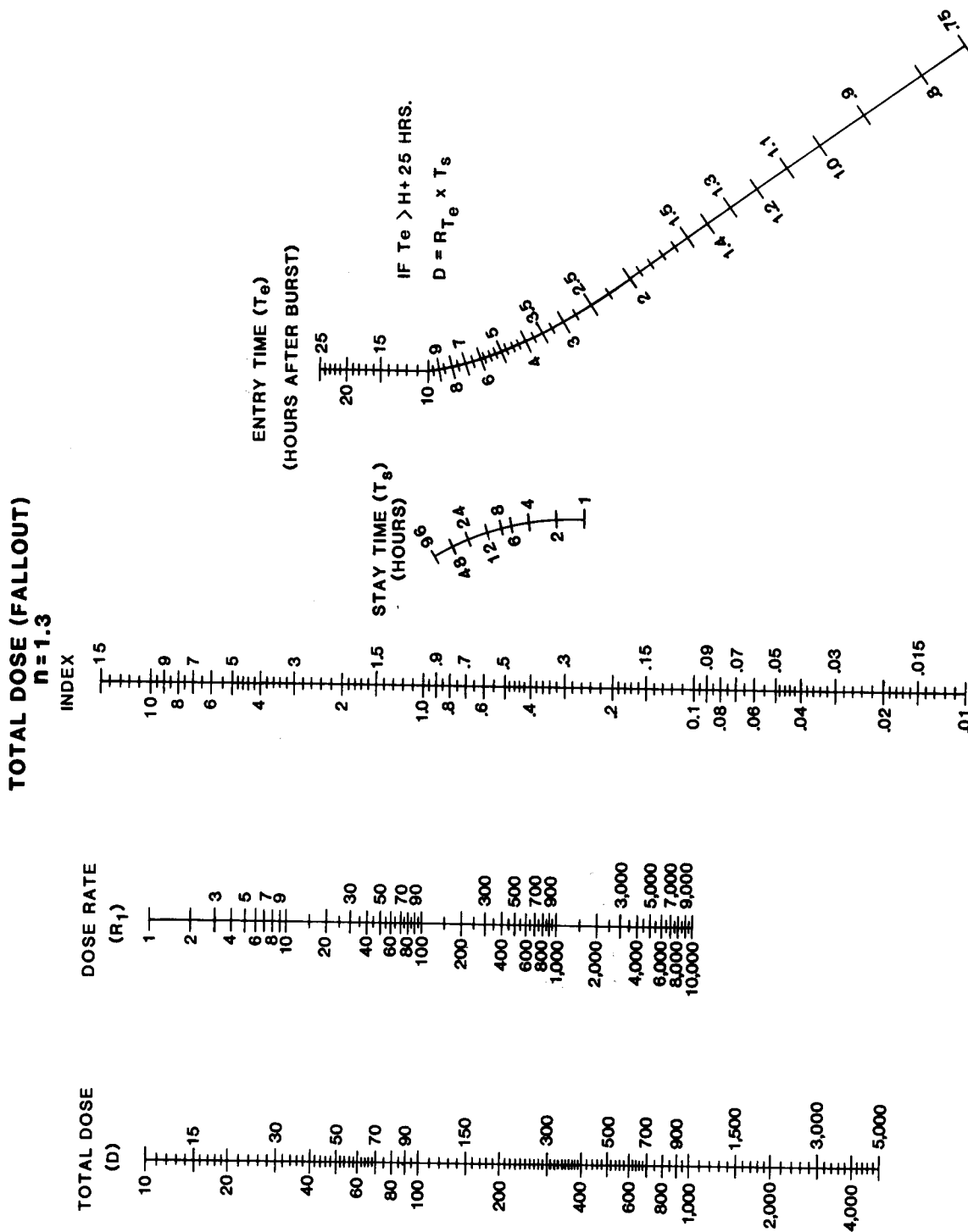

Figure E-37. Total dose (fallout) nomogram  $n = 1.3$ .

Table E-35. Index for total dose (fallout)  $n = 1.3$ .

Enter table with entry time (Te) and stay time (Ts) to find INDEX

Entry time hrs after burst (Te)	Stay time in hours (Ts)														
	1	2	3	4	5	6	7	8	10	12	24	36	48	72	96
0.75	0.82	1.2	1.4	1.6	1.7	1.8	1.8	1.9	2	2.1	2.4	2.5	2.6	2.7	2.8
0.8	0.77	1.1	1.3	1.5	1.6	1.7	1.8	1.8	1.9	2	2.3	2.4	2.5	2.6	2.7
0.9	0.69	1	1.2	1.4	1.5	1.6	1.7	1.7	1.8	1.9	2.2	2.3	2.4	2.5	2.6
1	0.63	0.94	1.1	1.3	1.4	1.5	1.6	1.6	1.7	1.8	2.1	2.2	2.3	2.4	2.5
1.1	0.57	0.87	1.1	1.2	1.3	1.4	1.5	1.5	1.6	1.7	2	2.1	2.2	2.3	2.4
1.2	0.52	0.8	0.99	1.1	1.2	1.3	1.4	1.4	1.5	1.6	1.9	2	2.1	2.2	2.3
1.3	0.48	0.75	0.93	1.1	1.2	1.2	1.3	1.4	1.5	1.6	1.8	2	2.1	2.2	2.2
1.4	0.45	0.7	0.88	1	1.1	1.2	1.3	1.3	1.4	1.5	1.8	1.9	2	2.1	2.2
1.5	0.42	0.66	0.83	0.95	1.1	1.1	1.2	1.3	1.4	1.4	1.7	1.8	1.9	2	2.1
1.6	0.39	0.63	0.79	0.91	1	1.1	1.2	1.2	1.3	1.4	1.6	1.8	1.9	2	2.1
1.7	0.37	0.59	0.75	0.87	0.96	1	1.1	1.2	1.3	1.3	1.6	1.7	1.8	1.9	2
1.8	0.35	0.56	0.71	0.83	0.92	0.99	1.1	1.1	1.2	1.3	1.5	1.7	1.8	1.9	2
1.9	0.33	0.53	0.68	0.79	0.88	0.96	1	1.1	1.2	1.2	1.5	1.6	1.7	1.8	1.9
2	0.31	0.51	0.65	0.76	0.85	0.92	0.98	1	1.1	1.2	1.5	1.6	1.7	1.8	1.9
2.25	0.27	0.45	0.59	0.69	0.77	0.84	0.9	0.96	1	1.1	1.4	1.5	1.6	1.7	1.8
2.5	0.24	0.41	0.53	0.63	0.71	0.78	0.84	0.9	0.97	1	1.3	1.4	1.5	1.6	1.7
2.75	0.22	0.37	0.48	0.58	0.66	0.72	0.78	0.83	0.91	0.97	1.2	1.4	1.4	1.6	1.6
3	0.2	0.34	0.45	0.54	0.61	0.67	0.73	0.77	0.85	0.92	1.2	1.3	1.4	1.5	1.6
3.25	0.18	0.31	0.42	0.5	0.57	0.63	0.68	0.73	0.81	0.87	1.1	1.2	1.3	1.4	1.5
3.5	0.17	0.29	0.39	0.47	0.53	0.59	0.64	0.69	0.76	0.82	1.1	1.2	1.3	1.4	1.5
3.75	0.15	0.27	0.36	0.44	0.5	0.56	0.61	0.65	0.72	0.78	1	1.1	1.2	1.3	1.4
4	0.14	0.25	0.34	0.41	0.47	0.53	0.58	0.62	0.69	0.75	0.97	1.1	1.2	1.3	1.4
4.5	0.12	0.22	0.3	0.37	0.43	0.48	0.52	0.56	0.63	0.69	0.9	1	1.1	1.2	1.3
5	0.11	0.2	0.27	0.33	0.39	0.43	0.48	0.51	0.58	0.63	0.84	0.96	1	1.2	1.2
5.5	0.1	0.18	0.24	0.3	0.35	0.4	0.44	0.47	0.53	0.59	0.79	0.91	0.99	1.1	1.2
6	0.09	0.16	0.22	0.28	0.32	0.37	0.4	0.44	0.5	0.55	0.75	0.86	0.94	1.1	1.1
6.5	0.08	0.15	0.2	0.25	0.3	0.34	0.37	0.41	0.46	0.51	0.71	0.82	0.9	1	1.1
7	0.07	0.14	0.19	0.24	0.28	0.32	0.35	0.38	0.43	0.48	0.67	0.78	0.86	0.96	1
7.5	0.07	0.12	0.17	0.22	0.26	0.29	0.33	0.36	0.41	0.45	0.64	0.75	0.82	0.92	0.99
8	0.06	0.12	0.16	0.2	0.24	0.28	0.31	0.34	0.39	0.43	0.61	0.72	0.79	0.89	0.96
8.5	0.06	0.11	0.15	0.19	0.23	0.26	0.29	0.32	0.37	0.41	0.58	0.69	0.76	0.86	0.93
9	0.05	0.1	0.14	0.18	0.21	0.24	0.27	0.3	0.35	0.39	0.56	0.66	0.73	0.83	0.9
9.5	0.05	0.09	0.13	0.17	0.2	0.23	0.26	0.28	0.33	0.37	0.53	0.64	0.71	0.81	0.87
10	0.05	0.09	0.13	0.16	0.19	0.22	0.25	0.27	0.31	0.35	0.51	0.61	0.68	0.78	0.85
11	0.04	0.08	0.11	0.14	0.17	0.2	0.22	0.25	0.29	0.32	0.48	0.57	0.64	0.74	0.8
12	0.04	0.07	0.1	0.13	0.16	0.18	0.2	0.22	0.26	0.3	0.44	0.54	0.61	0.7	0.76
13	0.03	0.06	0.09	0.12	0.14	0.17	0.19	0.21	0.24	0.28	0.42	0.51	0.57	0.67	0.73
14	0.03	0.06	0.09	0.11	0.13	0.15	0.17	0.19	0.23	0.26	0.39	0.48	0.54	0.63	0.7
15	0.03	0.05	0.08	0.1	0.12	0.14	0.16	0.18	0.21	0.24	0.37	0.45	0.52	0.61	0.67
16	0.03	0.05	0.07	0.09	0.11	0.13	0.15	0.17	0.2	0.22	0.35	0.43	0.49	0.58	0.64
17	0.02	0.05	0.07	0.09	0.11	0.12	0.14	0.16	0.18	0.21	0.33	0.41	0.47	0.56	0.62
18	0.02	0.04	0.06	0.08	0.1	0.12	0.13	0.15	0.17	0.2	0.31	0.39	0.45	0.54	0.6
19	0.02	0.04	0.06	0.08	0.09	0.11	0.12	0.14	0.16	0.19	0.3	0.38	0.48	0.52	0.58
20	0.02	0.04	0.06	0.07	0.09	0.1	0.12	0.13	0.16	0.18	0.29	0.36	0.42	0.5	0.56
21	0.02	0.04	0.05	0.07	0.08	0.1	0.11	0.12	0.15	0.17	0.27	0.35	0.4	0.48	0.54
22	0.02	0.03	0.05	0.06	0.08	0.09	0.1	0.12	0.14	0.16	0.26	0.33	0.39	0.47	0.52
23	0.02	0.03	0.05	0.06	0.07	0.09	0.1	0.11	0.13	0.15	0.25	0.32	0.37	0.45	0.51
24	0.02	0.03	0.04	0.06	0.07	0.08	0.09	0.11	0.13	0.15	0.24	0.31	0.36	0.44	0.49
25	0.01	0.03	0.04	0.06	0.07	0.08	0.09	0.1	0.12	0.14	0.23	0.3	0.35	0.42	0.48

An "\*" in the table means an INDEX less than 0.005

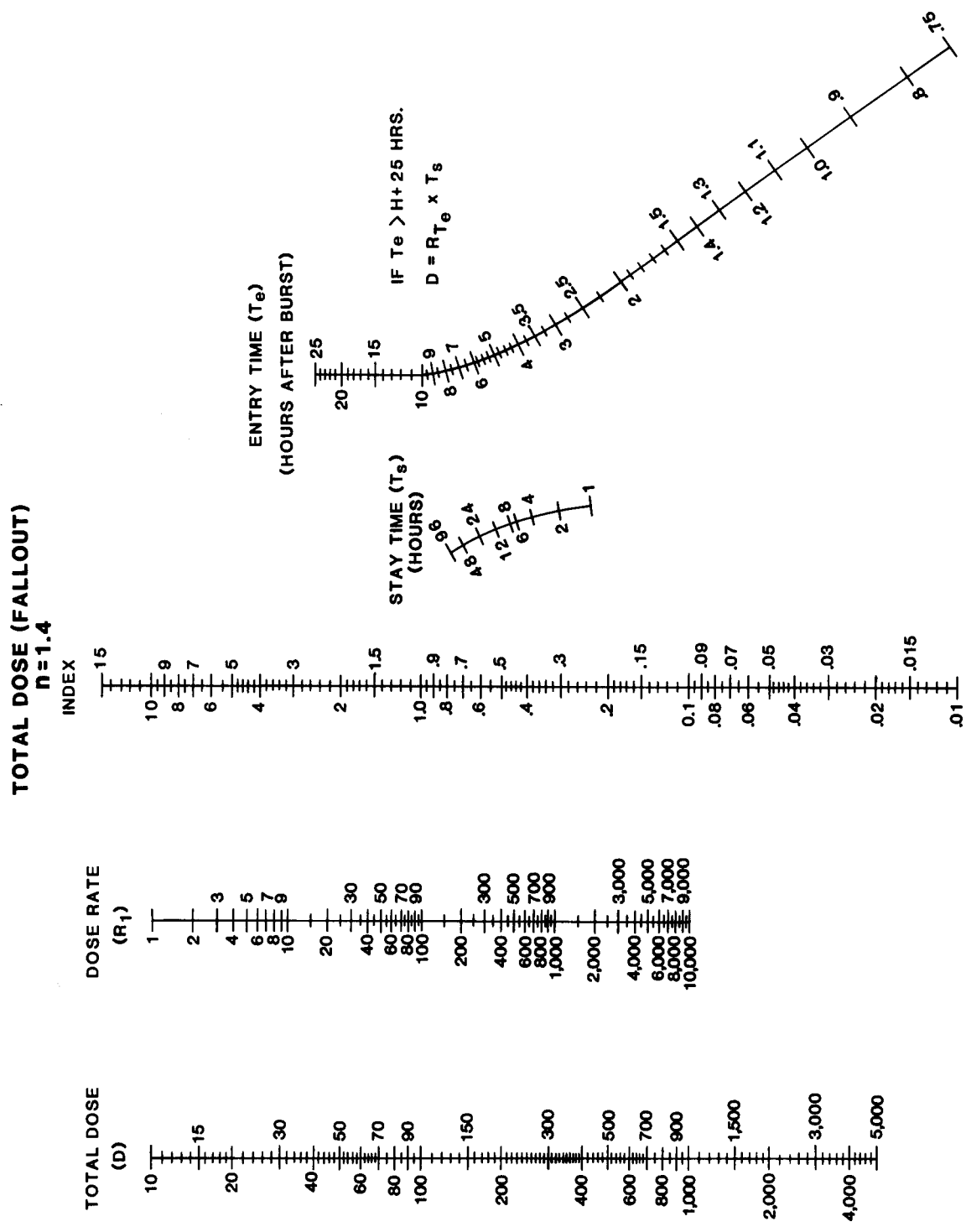

Figure E-38. Total dose (fallout) nomogram  $n = 1.4$ .

Table E-36. Index for total dose (fallout)  $n = 1.4$ .

Enter table with entry time (Te) and stay time (Ts) to find INDEX

Entry time hrs after burst (Te)	Stay time in hours (Ts)														
	1	2	3	4	5	6	7	8	10	12	24	36	48	72	96
0.75	0.81	1.1	1.3	1.5	1.6	1.6	1.7	1.8	1.8	1.9	2.1	2.2	2.3	2.4	2.4
0.8	0.76	1.1	1.3	1.4	1.5	1.6	1.6	1.7	1.8	1.8	2	2.1	2.2	2.3	2.3
0.9	0.67	0.97	1.2	1.3	1.4	1.5	1.5	1.6	1.7	1.7	1.9	2	2.1	2.2	2.2
1	0.61	0.89	1.1	1.2	1.3	1.4	1.4	1.5	1.5	1.6	1.8	1.9	2	2.1	2.1
1.1	0.55	0.82	0.98	1.1	1.2	1.3	1.3	1.4	1.5	1.5	1.7	1.8	1.9	2	2
1.2	0.5	0.75	0.92	1	1.1	1.2	1.3	1.3	1.4	1.4	1.6	1.7	1.8	1.9	1.9
1.3	0.46	0.7	0.86	0.97	1.1	1.1	1.2	1.2	1.3	1.3	1.4	1.6	1.7	1.7	1.8
1.4	0.42	0.65	0.8	0.91	1	1.1	1.1	1.2	1.2	1.3	1.5	1.6	1.7	1.7	1.8
1.5	0.39	0.61	0.76	0.86	0.94	1	1.1	1.1	1.2	1.2	1.4	1.5	1.6	1.7	1.7
1.6	0.37	0.57	0.71	0.82	0.9	0.96	1	1.1	1.1	1.2	1.4	1.5	1.6	1.6	1.7
1.7	0.34	0.54	0.68	0.78	0.85	0.92	0.97	1	1.1	1.1	1.3	1.4	1.5	1.5	1.6
1.8	0.32	0.51	0.64	0.74	0.81	0.88	0.93	0.97	1	1.1	1.3	1.4	1.5	1.5	1.6
1.9	0.3	0.48	0.61	0.7	0.78	0.84	0.89	0.93	1	1.1	1.3	1.4	1.4	1.5	1.5
2	0.28	0.46	0.58	0.67	0.75	0.81	0.86	0.9	0.97	1	1.2	1.3	1.4	1.5	1.5
2.25	0.25	0.41	0.52	0.61	0.68	0.73	0.78	0.82	0.89	0.94	1.1	1.2	1.3	1.4	1.4
2.5	0.22	0.36	0.47	0.55	0.62	0.67	0.72	0.76	0.82	0.86	1.1	1.2	1.2	1.3	1.3
2.75	0.19	0.33	0.43	0.5	0.57	0.62	0.66	0.7	0.76	0.82	1	1.1	1.2	1.2	1.3
3	0.18	0.3	0.39	0.46	0.52	0.57	0.62	0.65	0.71	0.76	0.84	1	1.1	1.2	1.2
3.25	0.16	0.27	0.36	0.43	0.49	0.53	0.57	0.61	0.67	0.72	0.80	0.86	1	1.1	1.2
3.5	0.14	0.25	0.33	0.4	0.45	0.5	0.54	0.57	0.63	0.68	0.85	0.94	1	1.1	1.1
3.75	0.13	0.23	0.31	0.37	0.42	0.47	0.51	0.54	0.6	0.64	0.81	0.9	0.96	1	1.1
4	0.12	0.21	0.29	0.35	0.4	0.44	0.48	0.51	0.57	0.61	0.78	0.86	0.92	0.99	1
4.5	0.11	0.19	0.25	0.31	0.35	0.39	0.43	0.46	0.51	0.56	0.72	0.8	0.86	0.93	0.97
5	0.09	0.17	0.23	0.28	0.32	0.36	0.39	0.42	0.47	0.51	0.66	0.75	0.8	0.87	0.92
5.5	0.08	0.15	0.2	0.25	0.29	0.32	0.35	0.38	0.43	0.47	0.62	0.7	0.76	0.83	0.87
6	0.07	0.13	0.18	0.23	0.26	0.3	0.32	0.35	0.4	0.43	0.58	0.66	0.71	0.78	0.83
6.5	0.07	0.12	0.17	0.21	0.24	0.27	0.3	0.32	0.37	0.4	0.55	0.62	0.68	0.75	0.79
7	0.06	0.11	0.15	0.19	0.22	0.25	0.28	0.3	0.34	0.38	0.51	0.59	0.64	0.71	0.76
7.5	0.05	0.1	0.14	0.18	0.21	0.23	0.26	0.28	0.32	0.35	0.49	0.56	0.62	0.68	0.73
8	0.05	0.09	0.13	0.16	0.19	0.22	0.24	0.26	0.3	0.33	0.46	0.54	0.59	0.65	0.7
8.5	0.05	0.09	0.12	0.15	0.18	0.2	0.23	0.25	0.28	0.32	0.44	0.51	0.56	0.63	0.67
9	0.04	0.08	0.11	0.14	0.17	0.19	0.21	0.23	0.27	0.3	0.42	0.49	0.54	0.61	0.65
9.5	0.04	0.07	0.11	0.13	0.16	0.18	0.2	0.22	0.25	0.28	0.4	0.47	0.52	0.59	0.63
10	0.04	0.07	0.1	0.13	0.15	0.17	0.19	0.21	0.24	0.27	0.39	0.45	0.5	0.57	0.61
11	0.03	0.06	0.09	0.11	0.13	0.15	0.17	0.19	0.22	0.24	0.36	0.42	0.47	0.53	0.57
12	0.03	0.06	0.08	0.1	0.12	0.14	0.16	0.17	0.2	0.22	0.33	0.39	0.44	0.5	0.54
13	0.03	0.05	0.07	0.09	0.11	0.13	0.14	0.16	0.18	0.21	0.31	0.37	0.41	0.47	0.51
14	0.02	0.05	0.07	0.08	0.1	0.12	0.13	0.14	0.17	0.19	0.29	0.35	0.39	0.45	0.49
15	0.02	0.04	0.06	0.08	0.09	0.11	0.12	0.13	0.16	0.18	0.27	0.33	0.37	0.43	0.47
16	0.02	0.04	0.05	0.07	0.08	0.1	0.11	0.12	0.15	0.17	0.25	0.31	0.35	0.41	0.45
17	0.02	0.04	0.05	0.07	0.08	0.09	0.1	0.12	0.14	0.15	0.24	0.29	0.33	0.39	0.43
18	0.02	0.03	0.05	0.06	0.07	0.09	0.1	0.11	0.13	0.15	0.23	0.28	0.32	0.37	0.41
19	0.02	0.03	0.04	0.06	0.07	0.08	0.09	0.1	0.12	0.14	0.21	0.27	0.3	0.36	0.4
20	0.01	0.03	0.04	0.05	0.06	0.08	0.09	0.09	0.11	0.13	0.2	0.25	0.29	0.34	0.38
21	0.01	0.03	0.04	0.05	0.06	0.07	0.08	0.09	0.11	0.12	0.19	0.24	0.28	0.33	0.37
22	0.01	0.02	0.04	0.05	0.06	0.07	0.08	0.08	0.1	0.12	0.19	0.23	0.27	0.32	0.36
23	0.01	0.02	0.03	0.04	0.05	0.06	0.07	0.08	0.1	0.11	0.18	0.22	0.26	0.31	0.34
24	0.01	0.02	0.03	0.04	0.05	0.06	0.07	0.08	0.09	0.1	0.17	0.22	0.25	0.3	0.33
25	0.01	0.02	0.03	0.04	0.05	0.06	0.06	0.07	0.09	0.1	0.16	0.21	0.24	0.29	0.32

An "\*" in the table means an INDEX less than 0.005



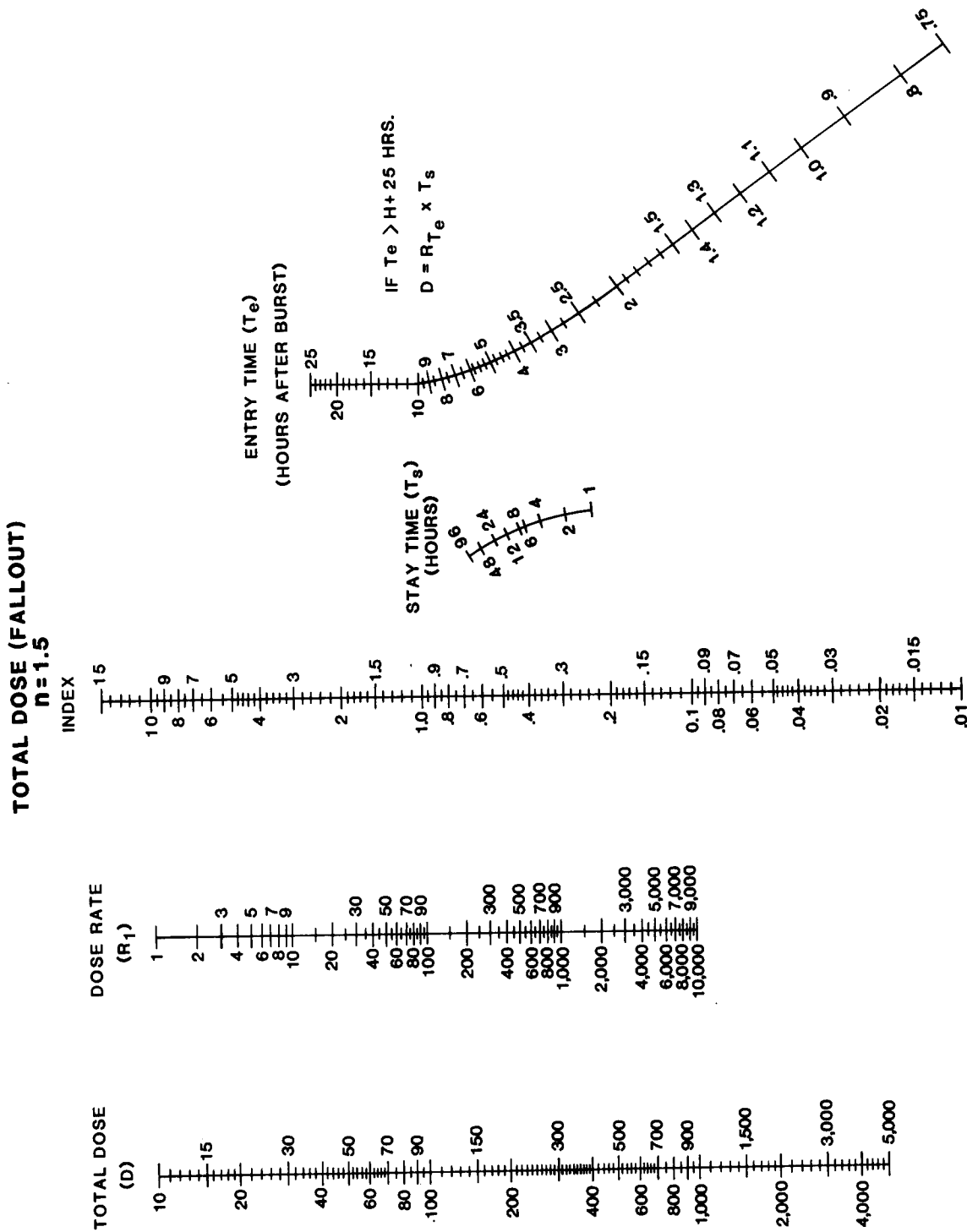

Figure E-39. Total dose (fallout) nomogram  $n = 1.5$ .

Table E-37. Index for total dose (fallout)  $n = 1.5$ .

Enter table with entry time (Te) and stay time (Ts) to find INDEX

Entry time hrs after burst (Te)	Stay time in hours (Ts)														
	1	2	3	4	5	6	7	8	10	12	24	36	48	72	96
0.75	0.8	1.1	1.3	1.4	1.5	1.5	1.6	1.6	1.7	1.8	1.9	2	2	2.1	2.1
0.8	0.75	1	1.2	1.3	1.4	1.5	1.5	1.6	1.6	1.7	1.8	1.9	2	2	2
0.9	0.66	0.93	1.1	1.2	1.3	1.4	1.4	1.4	1.5	1.6	1.7	1.8	1.8	1.9	1.9
1	0.59	0.85	1	1.1	1.2	1.2	1.3	1.3	1.4	1.5	1.6	1.7	1.7	1.8	1.8
1.1	0.53	0.77	0.92	1	1.1	1.2	1.2	1.2	1.3	1.4	1.5	1.6	1.6	1.7	1.7
1.2	0.48	0.71	0.85	0.95	1	1.1	1.1	1.2	1.2	1.3	1.4	1.5	1.5	1.6	1.6
1.3	0.44	0.65	0.79	0.89	0.96	1	1.1	1.1	1.2	1.2	1.4	1.4	1.5	1.5	1.6
1.4	0.4	0.61	0.74	0.83	0.9	0.96	1	1	1.1	1.1	1.3	1.4	1.4	1.5	1.5
1.5	0.37	0.56	0.69	0.78	0.85	0.9	0.95	0.95	1	1.1	1.2	1.3	1.4	1.4	1.4
1.6	0.34	0.53	0.65	0.74	0.8	0.86	0.9	0.94	0.99	1	1.2	1.3	1.3	1.4	1.4
1.7	0.32	0.49	0.61	0.7	0.76	0.81	0.86	0.89	0.95	0.99	1.1	1.2	1.3	1.3	1.3
1.8	0.3	0.46	0.58	0.66	0.72	0.77	0.82	0.85	0.91	0.95	1.1	1.2	1.2	1.3	1.3
1.9	0.28	0.44	0.55	0.63	0.69	0.74	0.78	0.82	0.87	0.91	1.1	1.1	1.2	1.2	1.3
2	0.26	0.41	0.52	0.6	0.66	0.71	0.75	0.78	0.84	0.88	1	1.1	1.1	1.2	1.2
2.25	0.22	0.36	0.46	0.53	0.59	0.64	0.68	0.71	0.76	0.8	0.94	1	1.1	1.1	1.1
2.5	0.2	0.32	0.41	0.48	0.53	0.58	0.62	0.65	0.7	0.74	0.86	0.94	0.98	1	1.1
2.75	0.17	0.29	0.37	0.44	0.49	0.53	0.57	0.6	0.65	0.69	0.82	0.86	0.93	0.97	1
3	0.15	0.26	0.34	0.4	0.45	0.49	0.52	0.55	0.6	0.64	0.77	0.83	0.87	0.92	0.95
3.25	0.14	0.24	0.31	0.37	0.41	0.45	0.48	0.51	0.56	0.6	0.73	0.79	0.83	0.88	0.91
3.5	0.13	0.22	0.28	0.34	0.38	0.42	0.45	0.48	0.52	0.56	0.69	0.75	0.79	0.84	0.87
3.75	0.12	0.2	0.26	0.31	0.36	0.39	0.42	0.45	0.49	0.53	0.65	0.72	0.75	0.8	0.83
4	0.11	0.18	0.24	0.29	0.33	0.37	0.4	0.42	0.47	0.5	0.62	0.68	0.72	0.77	0.8
4.5	0.09	0.16	0.21	0.26	0.29	0.33	0.35	0.38	0.42	0.45	0.57	0.63	0.67	0.71	0.74
5	0.08	0.14	0.19	0.23	0.26	0.29	0.32	0.34	0.36	0.41	0.52	0.58	0.62	0.67	0.7
5.5	0.07	0.12	0.17	0.2	0.24	0.26	0.29	0.31	0.34	0.37	0.48	0.54	0.58	0.63	0.65
6	0.06	0.11	0.15	0.18	0.21	0.24	0.26	0.28	0.32	0.35	0.45	0.51	0.54	0.59	0.62
6.5	0.05	0.1	0.14	0.17	0.19	0.22	0.24	0.26	0.29	0.32	0.42	0.48	0.51	0.56	0.59
7	0.05	0.09	0.12	0.15	0.18	0.2	0.22	0.24	0.27	0.3	0.4	0.45	0.49	0.53	0.56
7.5	0.04	0.08	0.11	0.14	0.16	0.19	0.21	0.22	0.25	0.28	0.37	0.43	0.46	0.51	0.53
8	0.04	0.07	0.1	0.13	0.15	0.17	0.19	0.21	0.24	0.26	0.35	0.41	0.44	0.48	0.51
8.5	0.04	0.07	0.1	0.12	0.14	0.16	0.18	0.19	0.22	0.24	0.34	0.39	0.42	0.46	0.49
9	0.03	0.06	0.09	0.11	0.13	0.15	0.17	0.18	0.21	0.23	0.32	0.37	0.4	0.44	0.47
9.5	0.03	0.06	0.08	0.1	0.12	0.14	0.16	0.17	0.2	0.22	0.3	0.35	0.39	0.43	0.45
10	0.03	0.06	0.08	0.1	0.12	0.13	0.15	0.16	0.19	0.21	0.29	0.34	0.37	0.41	0.44
11	0.03	0.05	0.07	0.09	0.1	0.12	0.13	0.14	0.17	0.19	0.26	0.31	0.34	0.38	0.41
12	0.02	0.04	0.06	0.08	0.09	0.11	0.12	0.13	0.15	0.17	0.24	0.29	0.32	0.36	0.38
13	0.02	0.04	0.05	0.07	0.08	0.1	0.11	0.12	0.14	0.15	0.23	0.27	0.3	0.34	0.36
14	0.02	0.03	0.05	0.06	0.08	0.09	0.1	0.11	0.13	0.14	0.21	0.25	0.28	0.32	0.34
15	0.02	0.03	0.04	0.06	0.07	0.08	0.09	0.1	0.12	0.13	0.2	0.24	0.26	0.3	0.33
16	0.01	0.03	0.04	0.05	0.06	0.07	0.08	0.09	0.11	0.12	0.18	0.22	0.25	0.29	0.31
17	0.01	0.03	0.04	0.05	0.06	0.07	0.08	0.09	0.1	0.11	0.17	0.21	0.24	0.27	0.3
18	0.01	0.02	0.03	0.05	0.05	0.06	0.07	0.08	0.09	0.11	0.16	0.2	0.23	0.26	0.28
19	0.01	0.02	0.03	0.04	0.05	0.06	0.07	0.07	0.09	0.1	0.15	0.19	0.21	0.25	0.27
20	0.01	0.02	0.03	0.04	0.05	0.05	0.06	0.07	0.08	0.09	0.15	0.18	0.2	0.24	0.26
21	0.01	0.02	0.03	0.04	0.04	0.05	0.06	0.07	0.08	0.09	0.14	0.17	0.2	0.23	0.25
22	0.01	0.02	0.03	0.03	0.04	0.05	0.06	0.06	0.07	0.08	0.13	0.16	0.19	0.22	0.24
23	0.01	0.02	0.02	0.03	0.04	0.05	0.05	0.06	0.07	0.08	0.13	0.16	0.18	0.21	0.23
24	0.01	0.02	0.02	0.03	0.04	0.04	0.05	0.05	0.07	0.07	0.12	0.15	0.17	0.2	0.23
25	0.01	0.02	0.02	0.03	0.03	0.04	0.05	0.05	0.06	0.07	0.11	0.14	0.17	0.2	0.22

An "\*" in the table means an INDEX less than 0.005

**TOTAL DOSE (FALLOUT)**  
**n = 1.6**

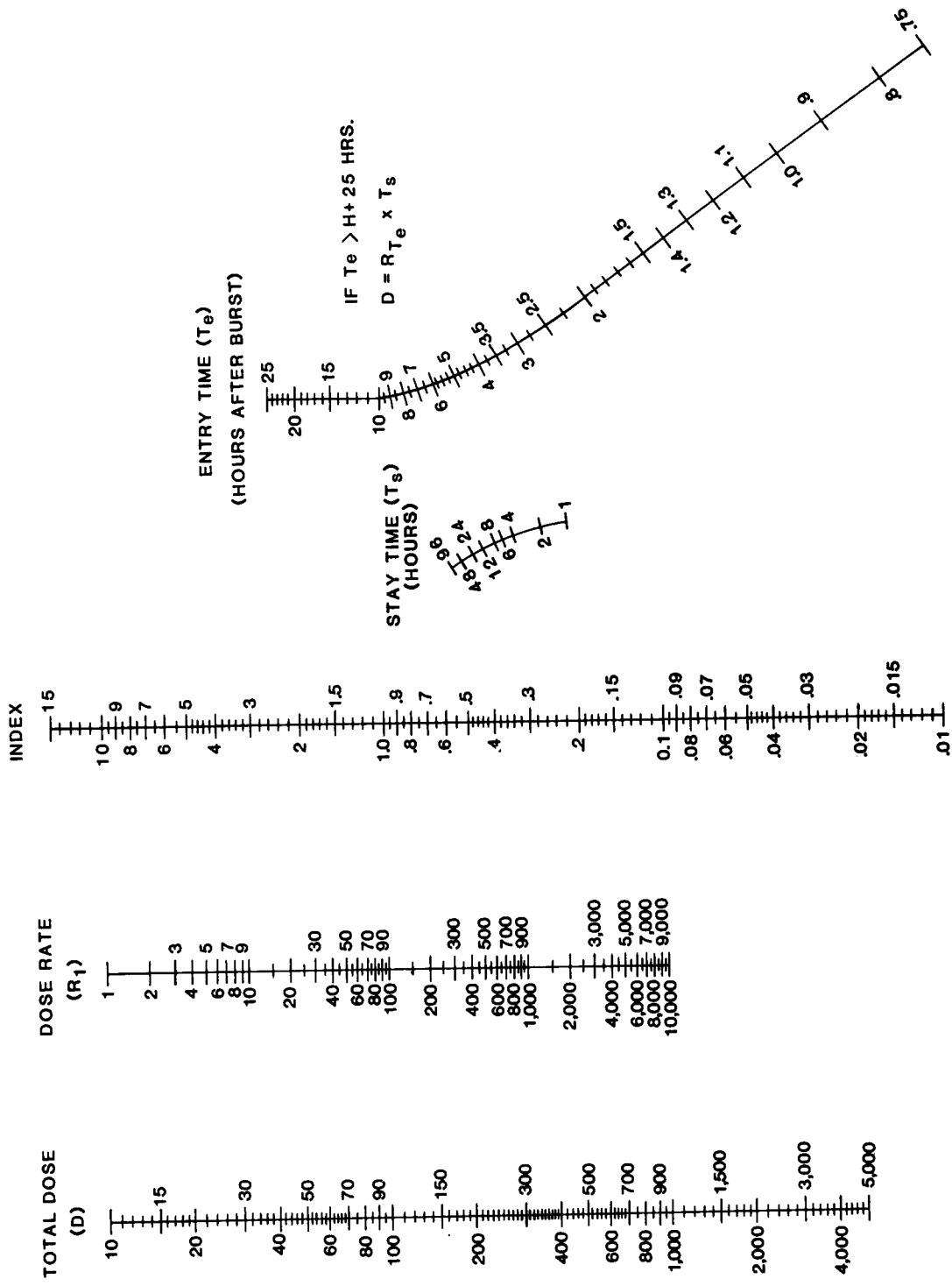

Figure E-40. Total dose (fallout) nomogram n = 1.6.

Table E-38. Index for total dose (fallout)  $n = 1.6$ .

Enter table with entry time (Te) and stay time (Ts) to find INDEX

Entry time hrs after burst (Te)	Stay time in hours (Ts)														
	1	2	3	4	5	6	7	8	10	12	24	36	48	72	96
0.75	0.79	1.1	1.2	1.3	1.4	1.5	1.5	1.5	1.6	1.6	1.7	1.8	1.8	1.9	1.9
0.8	0.73	1	1.2	1.3	1.3	1.4	1.4	1.5	1.5	1.5	1.7	1.7	1.7	1.8	1.8
0.9	0.64	0.9	1	1.1	1.2	1.3	1.3	1.3	1.4	1.4	1.5	1.6	1.6	1.7	1.7
1	0.57	0.8	0.94	1	1.1	1.2	1.2	1.2	1.3	1.3	1.4	1.5	1.5	1.5	1.6
1.1	0.51	0.73	0.86	0.95	1	1.1	1.1	1.1	1.2	1.2	1.3	1.4	1.4	1.5	1.5
1.2	0.48	0.66	0.79	0.87	0.94	0.98	1	1.1	1.1	1.1	1.3	1.3	1.3	1.4	1.4
1.3	0.41	0.61	0.73	0.81	0.87	0.92	0.96	0.99	1	1.1	1.2	1.2	1.3	1.3	1.3
1.4	0.38	0.56	0.68	0.76	0.81	0.86	0.9	0.93	0.97	1	1.1	1.2	1.2	1.2	1.3
1.5	0.34	0.52	0.63	0.71	0.76	0.81	0.85	0.88	0.92	0.96	1.1	1.1	1.2	1.2	1.2
1.6	0.32	0.48	0.59	0.66	0.72	0.76	0.8	0.83	0.87	0.91	1	1.1	1.1	1.1	1.2
1.7	0.29	0.45	0.55	0.63	0.68	0.72	0.76	0.79	0.83	0.87	0.97	1	1.1	1.1	1.1
1.8	0.27	0.42	0.52	0.59	0.64	0.69	0.72	0.75	0.79	0.83	0.93	0.96	1	1.1	1.1
1.9	0.25	0.4	0.49	0.56	0.61	0.65	0.68	0.71	0.76	0.79	0.9	0.95	0.97	1	1
2	0.24	0.37	0.47	0.53	0.58	0.62	0.65	0.68	0.72	0.76	0.86	0.91	0.94	0.97	0.99
2.25	0.2	0.33	0.41	0.47	0.52	0.55	0.59	0.61	0.65	0.69	0.79	0.84	0.87	0.9	0.92
2.5	0.18	0.29	0.36	0.42	0.46	0.5	0.53	0.56	0.6	0.63	0.73	0.78	0.8	0.84	0.86
2.75	0.15	0.25	0.32	0.38	0.42	0.45	0.48	0.51	0.55	0.58	0.68	0.72	0.75	0.78	0.8
3	0.14	0.23	0.29	0.34	0.38	0.42	0.44	0.47	0.5	0.53	0.63	0.68	0.7	0.74	0.76
3.25	0.12	0.21	0.27	0.31	0.35	0.38	0.41	0.43	0.47	0.5	0.59	0.64	0.66	0.7	0.72
3.5	0.11	0.19	0.24	0.29	0.32	0.35	0.38	0.4	0.44	0.46	0.56	0.6	0.63	0.66	0.68
3.75	0.1	0.17	0.22	0.27	0.3	0.33	0.35	0.37	0.41	0.44	0.53	0.57	0.6	0.63	0.65
4	0.09	0.16	0.21	0.25	0.28	0.31	0.33	0.35	0.38	0.41	0.5	0.54	0.57	0.6	0.62
4.5	0.08	0.13	0.18	0.21	0.24	0.27	0.29	0.31	0.34	0.37	0.45	0.5	0.52	0.55	0.57
5	0.07	0.12	0.16	0.19	0.22	0.24	0.26	0.28	0.31	0.33	0.41	0.46	0.48	0.51	0.53
5.5	0.06	0.1	0.14	0.17	0.19	0.21	0.23	0.25	0.28	0.3	0.38	0.42	0.45	0.48	0.5
6	0.05	0.09	0.12	0.15	0.17	0.19	0.21	0.23	0.25	0.27	0.35	0.39	0.42	0.45	0.46
6.5	0.04	0.08	0.11	0.14	0.16	0.18	0.19	0.21	0.23	0.25	0.33	0.37	0.39	0.42	0.44
7	0.04	0.07	0.1	0.12	0.14	0.16	0.18	0.19	0.21	0.23	0.31	0.34	0.37	0.4	0.42
7.5	0.04	0.07	0.09	0.11	0.13	0.15	0.16	0.18	0.2	0.22	0.29	0.32	0.35	0.38	0.39
8	0.03	0.06	0.08	0.1	0.12	0.14	0.15	0.16	0.18	0.2	0.27	0.31	0.33	0.36	0.38
8.5	0.03	0.05	0.08	0.1	0.11	0.13	0.14	0.15	0.17	0.19	0.26	0.29	0.31	0.34	0.36
9	0.03	0.05	0.07	0.09	0.1	0.12	0.13	0.14	0.16	0.18	0.24	0.28	0.3	0.33	0.34
9.5	0.03	0.05	0.07	0.08	0.1	0.11	0.12	0.13	0.15	0.17	0.23	0.26	0.29	0.31	0.33
10	0.02	0.04	0.06	0.08	0.09	0.1	0.11	0.12	0.14	0.16	0.22	0.25	0.27	0.3	0.32
11	0.02	0.04	0.05	0.07	0.08	0.09	0.1	0.11	0.13	0.14	0.2	0.23	0.25	0.28	0.29
12	0.02	0.03	0.05	0.06	0.07	0.08	0.09	0.1	0.11	0.13	0.18	0.21	0.23	0.26	0.27
13	0.02	0.03	0.04	0.05	0.06	0.07	0.08	0.09	0.1	0.12	0.17	0.2	0.22	0.24	0.26
14	0.01	0.03	0.04	0.05	0.06	0.07	0.07	0.08	0.09	0.11	0.15	0.18	0.2	0.23	0.24
15	0.01	0.02	0.03	0.04	0.05	0.06	0.07	0.07	0.09	0.1	0.14	0.17	0.19	0.21	0.23
16	0.01	0.02	0.03	0.04	0.05	0.05	0.06	0.07	0.08	0.09	0.13	0.16	0.18	0.2	0.22
17	0.01	0.02	0.03	0.04	0.04	0.05	0.06	0.06	0.07	0.08	0.12	0.15	0.17	0.19	0.21
18	0.01	0.02	0.03	0.03	0.04	0.05	0.05	0.06	0.07	0.08	0.12	0.14	0.16	0.18	0.2
19	0.01	0.02	0.02	0.03	0.04	0.04	0.05	0.05	0.06	0.07	0.11	0.13	0.15	0.17	0.19
20	0.01	0.02	0.02	0.03	0.03	0.04	0.05	0.05	0.06	0.07	0.1	0.13	0.14	0.17	0.18
21	0.01	0.01	0.02	0.03	0.03	0.04	0.04	0.05	0.06	0.06	0.1	0.12	0.14	0.16	0.17
22	0.01	0.01	0.02	0.02	0.03	0.04	0.04	0.04	0.05	0.06	0.09	0.12	0.13	0.15	0.17
23	0.01	0.01	0.02	0.02	0.03	0.03	0.04	0.04	0.05	0.06	0.09	0.11	0.12	0.15	0.16
24	0.01	0.01	0.02	0.02	0.03	0.03	0.04	0.04	0.05	0.05	0.08	0.1	0.12	0.14	0.15
25	0.01	0.01	0.02	0.02	0.03	0.03	0.03	0.04	0.04	0.05	0.08	0.1	0.11	0.13	0.15

An "\*" in the table means an INDEX less than 0.005

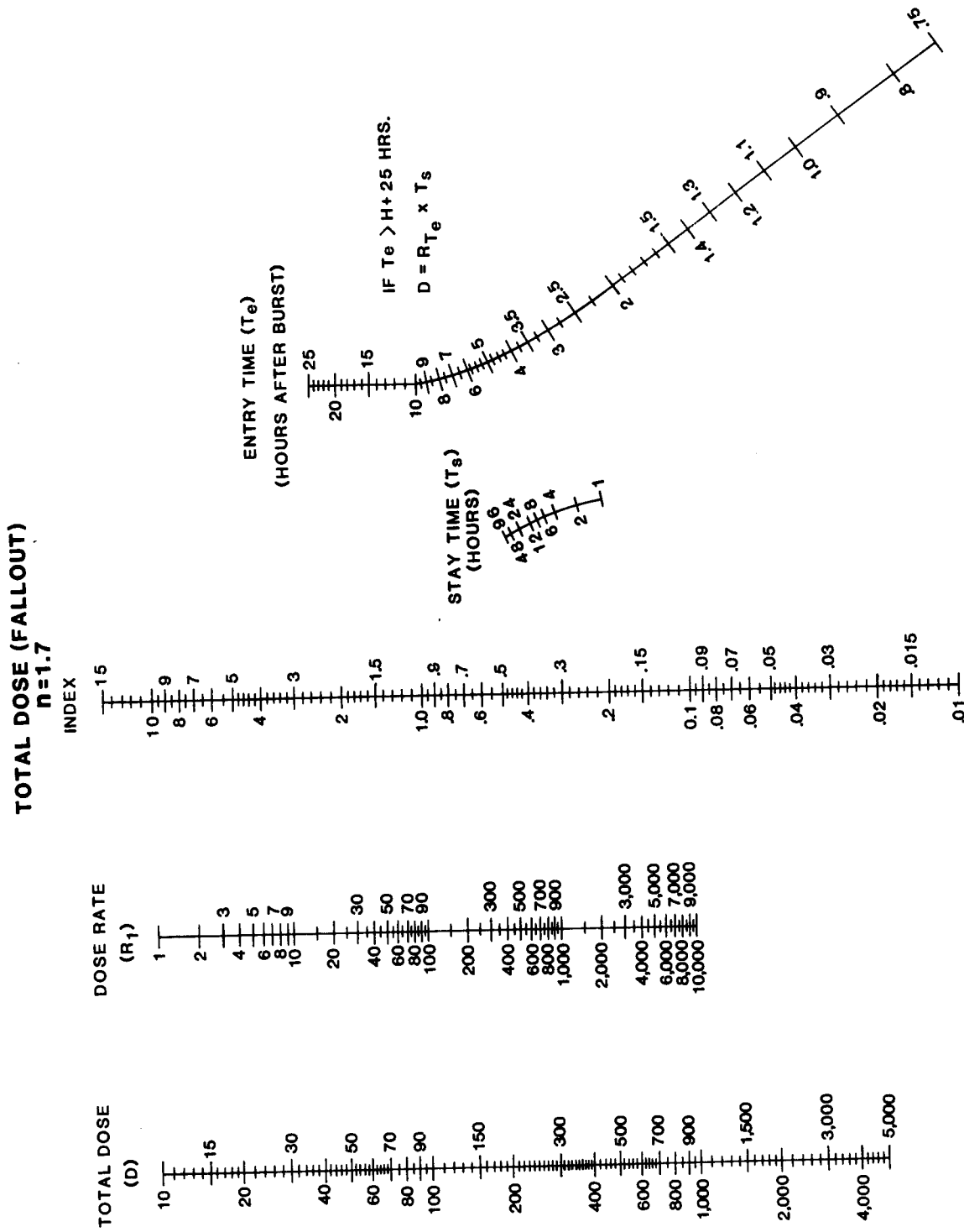

Figure E-41. Total dose (fallout) nomogram n = 1.7.

Table E-39. Index for total dose (fallout)  $n = 1.7$ .

Enter table with entry time (Te) and stay time (Ts) to find INDEX

Entry time hrs after burst (Te)	Stay time in hours (Ts)														
	1	2	3	4	5	6	7	8	10	12	24	36	48	72	96
0.75	0.76	1	1.2	1.3	1.3	1.4	1.4	1.4	1.5	1.5	1.6	1.6	1.7	1.7	1.7
0.8	0.72	0.96	1.1	1.2	1.3	1.3	1.3	1.4	1.4	1.4	1.5	1.6	1.6	1.6	1.6
0.9	0.63	0.86	0.99	1.1	1.1	1.2	1.2	1.2	1.3	1.3	1.4	1.4	1.4	1.5	1.5
1	0.55	0.77	0.89	0.97	1	1.1	1.1	1.1	1.2	1.2	1.3	1.3	1.3	1.4	1.4
1.1	0.49	0.69	0.8	0.86	0.93	0.97	1	1	1.1	1.1	1.2	1.2	1.2	1.3	1.3
1.2	0.43	0.62	0.73	0.81	0.86	0.9	0.93	0.96	0.99	1	1.1	1.1	1.2	1.2	1.2
1.3	0.39	0.57	0.67	0.74	0.8	0.83	0.86	0.89	0.93	0.96	1	1.1	1.1	1.1	1.1
1.4	0.35	0.52	0.62	0.69	0.74	0.78	0.81	0.83	0.87	0.9	0.96	1	1	1.1	1.1
1.5	0.32	0.48	0.58	0.64	0.69	0.73	0.76	0.78	0.82	0.84	0.83	0.96	0.98	1	1
1.6	0.3	0.45	0.54	0.6	0.65	0.68	0.71	0.73	0.77	0.8	0.86	0.92	0.94	0.96	0.97
1.7	0.27	0.41	0.5	0.56	0.61	0.64	0.67	0.69	0.73	0.76	0.84	0.87	0.89	0.91	0.93
1.8	0.25	0.39	0.47	0.53	0.57	0.61	0.63	0.66	0.69	0.72	0.8	0.83	0.85	0.86	0.89
1.9	0.23	0.36	0.44	0.5	0.54	0.58	0.6	0.62	0.66	0.69	0.77	0.8	0.82	0.84	0.85
2	0.22	0.34	0.42	0.47	0.51	0.55	0.57	0.59	0.63	0.65	0.73	0.77	0.79	0.81	0.82
2.25	0.18	0.29	0.36	0.41	0.45	0.48	0.51	0.53	0.56	0.59	0.66	0.7	0.72	0.74	0.75
2.5	0.16	0.25	0.32	0.37	0.4	0.43	0.46	0.48	0.51	0.53	0.61	0.64	0.66	0.68	0.69
2.75	0.14	0.22	0.28	0.33	0.36	0.39	0.41	0.43	0.46	0.49	0.56	0.59	0.61	0.63	0.65
3	0.12	0.2	0.25	0.3	0.33	0.36	0.38	0.4	0.42	0.45	0.52	0.55	0.57	0.59	0.6
3.25	0.11	0.18	0.23	0.27	0.3	0.32	0.35	0.36	0.39	0.41	0.48	0.52	0.54	0.56	0.57
3.5	0.1	0.16	0.21	0.25	0.27	0.3	0.32	0.34	0.36	0.38	0.45	0.49	0.5	0.53	0.54
3.75	0.09	0.15	0.19	0.23	0.25	0.28	0.3	0.31	0.34	0.36	0.43	0.46	0.48	0.5	0.51
4	0.08	0.13	0.18	0.21	0.23	0.26	0.27	0.29	0.32	0.34	0.4	0.43	0.45	0.47	0.48
4.5	0.07	0.11	0.15	0.18	0.2	0.22	0.24	0.25	0.28	0.3	0.36	0.39	0.41	0.43	0.44
5	0.06	0.1	0.13	0.16	0.18	0.2	0.21	0.23	0.25	0.27	0.33	0.36	0.37	0.39	0.41
5.5	0.05	0.08	0.11	0.14	0.16	0.17	0.19	0.2	0.22	0.24	0.3	0.33	0.35	0.37	0.38
6	0.04	0.07	0.1	0.12	0.14	0.16	0.17	0.18	0.2	0.22	0.28	0.3	0.32	0.34	0.35
6.5	0.04	0.07	0.09	0.11	0.13	0.14	0.15	0.17	0.18	0.2	0.25	0.28	0.3	0.32	0.33
7	0.03	0.06	0.08	0.1	0.11	0.13	0.14	0.15	0.17	0.18	0.24	0.26	0.28	0.3	0.31
7.5	0.03	0.05	0.07	0.09	0.1	0.12	0.13	0.14	0.16	0.17	0.22	0.25	0.26	0.28	0.29
8	0.03	0.05	0.07	0.08	0.1	0.11	0.12	0.13	0.14	0.16	0.21	0.23	0.25	0.27	0.28
8.5	0.02	0.04	0.06	0.08	0.09	0.1	0.11	0.12	0.13	0.15	0.19	0.22	0.23	0.25	0.26
9	0.02	0.04	0.06	0.07	0.08	0.09	0.1	0.11	0.12	0.14	0.18	0.21	0.22	0.24	0.25
9.5	0.02	0.04	0.05	0.06	0.06	0.09	0.09	0.1	0.12	0.13	0.17	0.2	0.21	0.23	0.24
10	0.02	0.03	0.05	0.06	0.07	0.08	0.09	0.1	0.11	0.12	0.16	0.19	0.2	0.22	0.23
11	0.02	0.03	0.04	0.05	0.06	0.07	0.08	0.08	0.1	0.11	0.15	0.17	0.18	0.2	0.21
12	0.01	0.03	0.04	0.05	0.05	0.06	0.07	0.08	0.09	0.1	0.13	0.16	0.17	0.19	0.2
13	0.01	0.02	0.03	0.04	0.05	0.06	0.06	0.07	0.08	0.09	0.12	0.14	0.16	0.17	0.18
14	0.01	0.02	0.03	0.04	0.04	0.05	0.06	0.06	0.07	0.08	0.11	0.13	0.15	0.16	0.17
15	0.01	0.02	0.03	0.03	0.04	0.05	0.05	0.06	0.06	0.07	0.1	0.12	0.14	0.15	0.16
16	0.01	0.02	0.02	0.03	0.04	0.04	0.05	0.05	0.06	0.07	0.1	0.12	0.13	0.14	0.15
17	0.01	0.01	0.02	0.03	0.03	0.04	0.04	0.05	0.05	0.06	0.09	0.11	0.12	0.13	0.14
18	0.01	0.01	0.02	0.02	0.03	0.03	0.04	0.04	0.05	0.06	0.08	0.1	0.11	0.13	0.14
19	0.01	0.01	0.02	0.02	0.03	0.03	0.04	0.04	0.05	0.05	0.08	0.1	0.11	0.12	0.13
20	0.01	0.01	0.02	0.02	0.03	0.03	0.03	0.04	0.04	0.05	0.07	0.09	0.1	0.12	0.12
21	0.01	0.01	0.02	0.02	0.02	0.03	0.03	0.03	0.04	0.05	0.07	0.09	0.1	0.11	0.12
22	0.01	0.01	0.01	0.02	0.02	0.03	0.03	0.03	0.04	0.04	0.07	0.08	0.09	0.1	0.11
23	*	0.01	0.01	0.02	0.02	0.02	0.03	0.03	0.04	0.04	0.06	0.08	0.09	0.1	0.11
24	*	0.01	0.01	0.02	0.02	0.02	0.03	0.03	0.03	0.04	0.06	0.07	0.08	0.1	0.1
25	*	0.01	0.01	0.01	0.02	0.02	0.02	0.03	0.03	0.04	0.06	0.07	0.08	0.09	0.1

An "\*" in the table means an INDEX less than 0.005

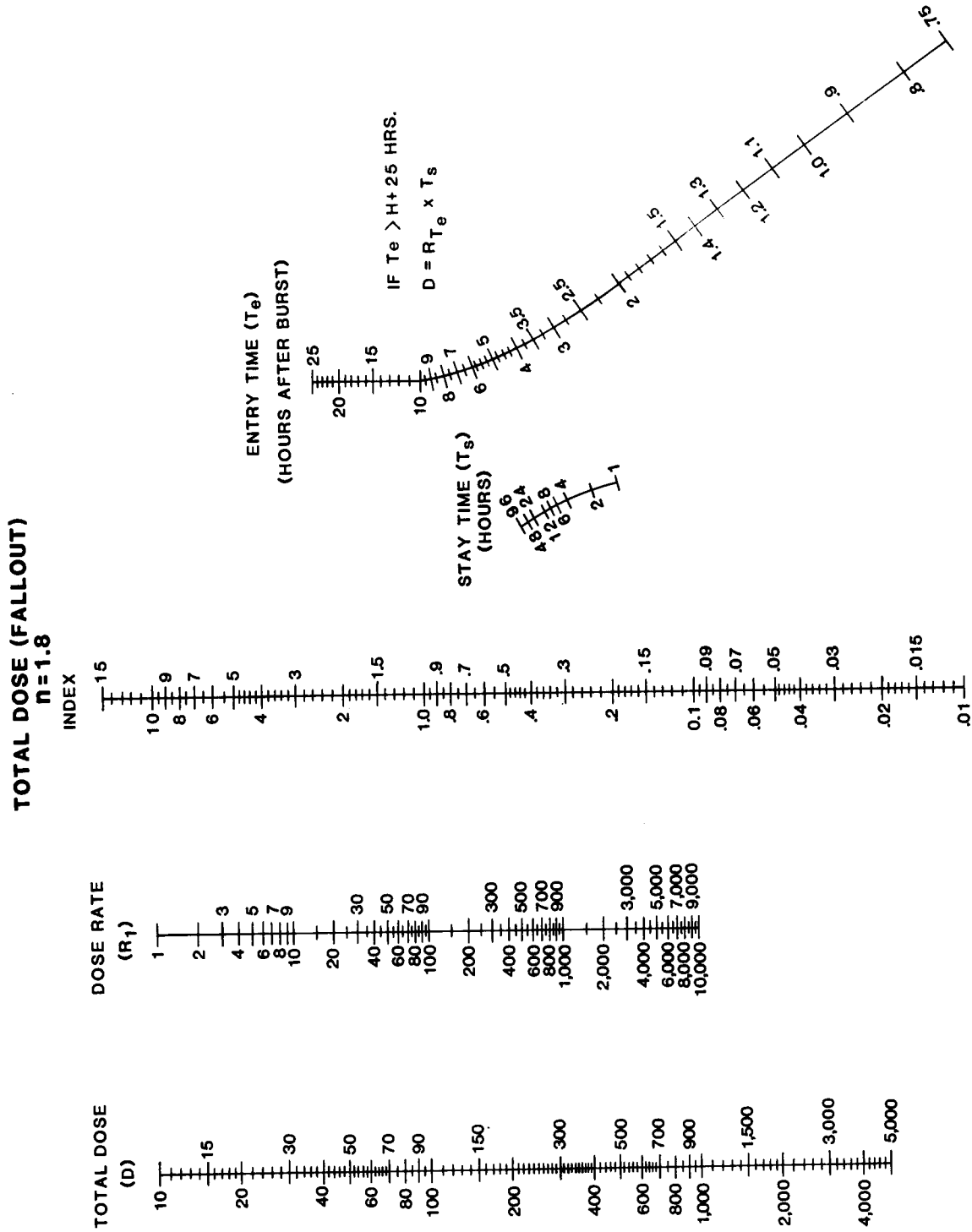

Figure E-42. Total dose (fallout) nomogram  $n = 1.8$ .

Table E-40. Index for total dose (fallout) n = 1.8.

Enter table with entry time (Te) and stay time (Ts) to find INDEX

Entry time hrs after burst (Te)	Stay time in hours (Ts)														
	1	2	3	4	5	6	7	8	10	12	24	36	48	72	96
0.75	0.77	1	1.1	1.2	1.3	1.3	1.3	1.4	1.4	1.4	1.5	1.5	1.5	1.5	1.5
0.8	0.71	0.95	1.1	1.1	1.2	1.2	1.3	1.3	1.3	1.3	1.4	1.4	1.4	1.5	1.5
0.9	0.61	0.83	0.94	1	1.1	1.1	1.1	1.1	1.2	1.2	1.3	1.3	1.3	1.3	1.3
1	0.53	0.73	0.84	0.91	0.95	0.99	1	1	1.1	1.1	1.2	1.2	1.2	1.2	1.2
1.1	0.47	0.65	0.75	0.82	0.86	0.9	0.92	0.94	0.98	1	1.1	1.1	1.1	1.1	1.1
1.2	0.42	0.59	0.68	0.75	0.79	0.82	0.85	0.87	0.9	0.92	0.99	1	1	1	1.1
1.3	0.37	0.53	0.62	0.68	0.73	0.76	0.78	0.8	0.83	0.86	0.92	0.94	0.96	0.97	0.98
1.4	0.33	0.49	0.57	0.63	0.67	0.7	0.73	0.75	0.78	0.8	0.86	0.89	0.9	0.91	0.92
1.5	0.3	0.44	0.53	0.58	0.62	0.65	0.68	0.7	0.73	0.75	0.81	0.83	0.85	0.86	0.87
1.6	0.28	0.41	0.49	0.54	0.58	0.61	0.63	0.65	0.68	0.7	0.76	0.79	0.8	0.82	0.83
1.7	0.25	0.38	0.46	0.51	0.54	0.57	0.6	0.61	0.64	0.66	0.72	0.75	0.76	0.78	0.79
1.8	0.23	0.35	0.42	0.47	0.51	0.54	0.56	0.58	0.61	0.63	0.69	0.71	0.73	0.74	0.75
1.9	0.21	0.33	0.4	0.45	0.48	0.51	0.53	0.55	0.58	0.6	0.66	0.68	0.69	0.71	0.72
2	0.2	0.31	0.37	0.42	0.45	0.48	0.5	0.52	0.55	0.57	0.63	0.65	0.66	0.68	0.69
2.25	0.17	0.28	0.32	0.36	0.4	0.42	0.44	0.46	0.48	0.5	0.56	0.59	0.6	0.61	0.62
2.5	0.14	0.23	0.28	0.32	0.35	0.37	0.39	0.41	0.43	0.45	0.51	0.53	0.55	0.56	0.57
2.75	0.12	0.2	0.25	0.29	0.31	0.34	0.35	0.37	0.39	0.41	0.47	0.49	0.5	0.52	0.52
3	0.11	0.17	0.22	0.26	0.28	0.3	0.32	0.34	0.36	0.38	0.43	0.45	0.47	0.48	0.49
3.25	0.09	0.16	0.2	0.23	0.26	0.28	0.29	0.31	0.33	0.35	0.4	0.42	0.43	0.45	0.46
3.5	0.08	0.14	0.18	0.21	0.23	0.25	0.27	0.28	0.3	0.32	0.37	0.39	0.41	0.42	0.43
3.75	0.07	0.13	0.16	0.19	0.21	0.23	0.25	0.26	0.28	0.3	0.35	0.37	0.38	0.39	0.4
4	0.07	0.11	0.15	0.18	0.2	0.21	0.23	0.24	0.26	0.28	0.33	0.35	0.36	0.37	0.38
4.5	0.06	0.1	0.13	0.15	0.17	0.18	0.2	0.21	0.23	0.24	0.29	0.31	0.32	0.34	0.34
5	0.05	0.08	0.11	0.13	0.15	0.16	0.17	0.18	0.2	0.22	0.26	0.28	0.29	0.31	0.31
5.5	0.04	0.07	0.09	0.11	0.13	0.14	0.15	0.16	0.18	0.19	0.24	0.26	0.27	0.28	0.29
6	0.03	0.06	0.08	0.1	0.11	0.13	0.14	0.15	0.16	0.17	0.22	0.24	0.25	0.26	0.27
6.5	0.03	0.05	0.07	0.09	0.1	0.11	0.12	0.13	0.15	0.16	0.2	0.22	0.23	0.24	0.25
7	0.03	0.05	0.07	0.08	0.09	0.1	0.11	0.12	0.13	0.14	0.18	0.2	0.21	0.23	0.23
7.5	0.02	0.04	0.06	0.07	0.08	0.09	0.1	0.11	0.12	0.13	0.17	0.19	0.2	0.21	0.22
8	0.02	0.04	0.05	0.07	0.08	0.09	0.09	0.1	0.11	0.12	0.16	0.18	0.19	0.2	0.21
8.5	0.02	0.04	0.05	0.06	0.07	0.08	0.09	0.09	0.1	0.11	0.15	0.17	0.18	0.19	0.2
9	0.02	0.03	0.04	0.05	0.06	0.07	0.08	0.09	0.1	0.11	0.14	0.16	0.17	0.18	0.19
9.5	0.02	0.03	0.04	0.05	0.06	0.07	0.08	0.09	0.1	0.11	0.13	0.15	0.16	0.17	0.18
10	0.01	0.03	0.04	0.05	0.05	0.06	0.07	0.07	0.08	0.09	0.12	0.14	0.15	0.16	0.17
11	0.01	0.02	0.03	0.04	0.05	0.05	0.06	0.07	0.07	0.08	0.11	0.13	0.14	0.15	0.15
12	0.01	0.02	0.03	0.04	0.04	0.05	0.05	0.06	0.07	0.07	0.1	0.11	0.12	0.14	0.14
13	0.01	0.02	0.02	0.03	0.04	0.04	0.05	0.05	0.06	0.07	0.09	0.11	0.11	0.12	0.13
14	0.01	0.02	0.02	0.03	0.03	0.04	0.04	0.05	0.05	0.06	0.08	0.1	0.11	0.12	0.12
15	0.01	0.01	0.02	0.02	0.03	0.03	0.04	0.04	0.05	0.05	0.08	0.09	0.1	0.11	0.11
16	0.01	0.01	0.02	0.02	0.03	0.03	0.03	0.04	0.04	0.05	0.07	0.08	0.09	0.1	0.11
17	0.01	0.01	0.02	0.02	0.02	0.03	0.03	0.03	0.04	0.05	0.07	0.08	0.09	0.1	0.1
18	0.01	0.01	0.01	0.02	0.02	0.03	0.03	0.03	0.04	0.04	0.06	0.07	0.08	0.09	0.1
19	*	0.01	0.01	0.02	0.02	0.02	0.03	0.03	0.03	0.04	0.06	0.07	0.08	0.08	0.09
20	*	0.01	0.01	0.02	0.02	0.02	0.02	0.03	0.03	0.04	0.05	0.06	0.07	0.08	0.09
21	*	0.01	0.01	0.01	0.02	0.02	0.02	0.02	0.03	0.03	0.05	0.06	0.07	0.08	0.08
22	*	0.01	0.01	0.01	0.02	0.02	0.02	0.02	0.03	0.03	0.05	0.06	0.06	0.07	0.08
23	*	0.01	0.01	0.01	0.01	0.02	0.02	0.02	0.03	0.03	0.04	0.05	0.06	0.07	0.07
24	*	0.01	0.01	0.01	0.01	0.02	0.02	0.02	0.03	0.04	0.05	0.06	0.07	0.07	0.07
25	*	0.01	0.01	0.01	0.01	0.02	0.02	0.02	0.03	0.04	0.05	0.05	0.06	0.07	0.07

An "\*" in the table means an INDEX less than 0.005



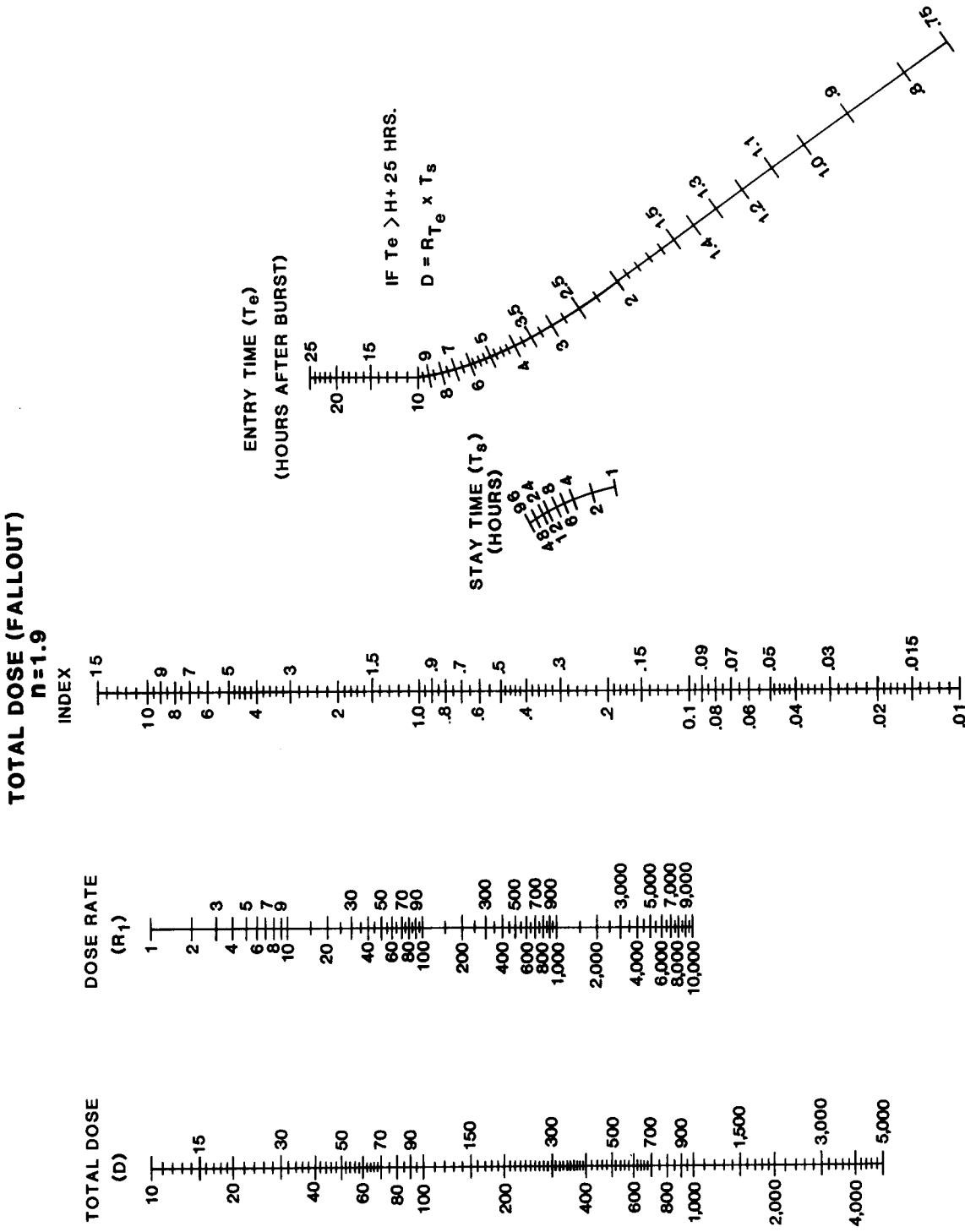

Figure E-43. Total dose (fallout) nomogram  $n = 1.9$ .

Table E-41. Index for total dose (fallout)  $n = 1.9$ .

Enter table with entry time (Te) and stay time (Ts) to find INDEX

Entry time hrs after burst (Te)	Stay time in hours (Ts)														
	1	2	3	4	5	6	7	8	10	12	24	36	48	72	96
0.75	0.77	0.99	1.1	1.2	1.2	1.2	1.3	1.3	1.3	1.3	1.4	1.4	1.4	1.4	1.4
0.8	0.7	0.92	1	1.1	1.1	1.2	1.2	1.2	1.3	1.3	1.3	1.3	1.3	1.3	1.3
0.9	0.6	0.8	0.9	0.96	1	1	1.1	1.1	1.1	1.1	1.2	1.2	1.2	1.2	1.2
1	0.52	0.7	0.79	0.85	0.89	0.92	0.94	0.96	0.98	1	1.1	1.1	1.1	1.1	1.1
1.1	0.45	0.62	0.71	0.76	0.8	0.83	0.85	0.87	0.89	0.91	0.96	0.98	0.99	1	1
1.2	0.4	0.55	0.64	0.69	0.73	0.75	0.78	0.79	0.82	0.83	0.88	0.9	0.91	0.92	0.92
1.3	0.35	0.5	0.56	0.63	0.67	0.69	0.71	0.73	0.75	0.77	0.82	0.83	0.84	0.85	0.86
1.4	0.32	0.45	0.53	0.58	0.61	0.64	0.66	0.67	0.7	0.71	0.76	0.78	0.79	0.8	0.8
1.5	0.28	0.41	0.48	0.53	0.57	0.59	0.61	0.62	0.65	0.66	0.71	0.73	0.74	0.75	0.75
1.6	0.26	0.38	0.45	0.49	0.52	0.55	0.57	0.58	0.61	0.62	0.67	0.69	0.69	0.7	0.71
1.7	0.23	0.35	0.41	0.46	0.49	0.51	0.53	0.55	0.57	0.58	0.63	0.65	0.66	0.67	0.67
1.8	0.21	0.32	0.38	0.43	0.46	0.48	0.5	0.51	0.53	0.55	0.6	0.61	0.62	0.63	0.64
1.9	0.2	0.3	0.36	0.4	0.43	0.45	0.47	0.48	0.5	0.52	0.56	0.58	0.59	0.6	0.61
2	0.18	0.26	0.33	0.37	0.4	0.42	0.44	0.46	0.48	0.49	0.54	0.55	0.56	0.57	0.58
2.25	0.15	0.23	0.29	0.32	0.35	0.37	0.39	0.4	0.42	0.43	0.48	0.49	0.5	0.51	0.52
2.5	0.13	0.2	0.25	0.28	0.31	0.33	0.34	0.35	0.37	0.39	0.43	0.45	0.45	0.46	0.47
2.75	0.11	0.17	0.22	0.25	0.27	0.29	0.3	0.32	0.33	0.35	0.39	0.41	0.41	0.42	0.43
3	0.09	0.15	0.19	0.22	0.24	0.26	0.27	0.28	0.3	0.32	0.36	0.37	0.38	0.39	0.4
3.25	0.08	0.13	0.17	0.2	0.22	0.23	0.25	0.26	0.28	0.29	0.33	0.34	0.35	0.36	0.37
3.5	0.07	0.12	0.15	0.18	0.2	0.21	0.23	0.24	0.25	0.27	0.3	0.32	0.33	0.34	0.34
3.75	0.06	0.11	0.14	0.16	0.18	0.2	0.21	0.22	0.23	0.25	0.28	0.3	0.31	0.32	0.32
4	0.06	0.1	0.13	0.15	0.17	0.18	0.19	0.2	0.22	0.23	0.26	0.28	0.29	0.3	0.3
4.5	0.05	0.08	0.11	0.13	0.14	0.15	0.16	0.17	0.19	0.2	0.23	0.25	0.26	0.26	0.27
5	0.04	0.07	0.09	0.11	0.12	0.13	0.14	0.15	0.16	0.17	0.21	0.22	0.23	0.24	0.24
5.5	0.03	0.06	0.08	0.09	0.11	0.12	0.13	0.13	0.15	0.16	0.19	0.2	0.21	0.22	0.22
6	0.03	0.05	0.07	0.08	0.09	0.1	0.11	0.12	0.13	0.14	0.17	0.18	0.19	0.2	0.2
6.5	0.02	0.04	0.06	0.07	0.08	0.09	0.1	0.11	0.12	0.13	0.15	0.17	0.18	0.18	0.19
7	0.02	0.04	0.05	0.06	0.07	0.08	0.09	0.1	0.11	0.11	0.14	0.16	0.16	0.17	0.18
7.5	0.02	0.03	0.05	0.06	0.07	0.07	0.08	0.09	0.1	0.1	0.13	0.14	0.15	0.16	0.16
8	0.02	0.03	0.04	0.05	0.06	0.07	0.07	0.08	0.09	0.1	0.12	0.13	0.14	0.15	0.15
8.5	0.02	0.03	0.04	0.05	0.06	0.06	0.07	0.07	0.08	0.09	0.11	0.13	0.13	0.14	0.14
9	0.01	0.03	0.04	0.04	0.05	0.06	0.06	0.07	0.08	0.08	0.11	0.12	0.12	0.13	0.14
9.5	0.01	0.02	0.03	0.04	0.05	0.05	0.06	0.06	0.07	0.08	0.1	0.11	0.12	0.13	0.13
10	0.01	0.02	0.03	0.04	0.04	0.05	0.05	0.06	0.06	0.07	0.09	0.1	0.11	0.12	0.12
11	0.01	0.02	0.03	0.03	0.04	0.04	0.05	0.05	0.06	0.06	0.08	0.09	0.1	0.11	0.11
12	0.01	0.02	0.02	0.03	0.03	0.04	0.04	0.04	0.05	0.06	0.07	0.08	0.09	0.1	0.1
13	0.01	0.01	0.02	0.02	0.03	0.03	0.04	0.04	0.04	0.05	0.07	0.08	0.08	0.09	0.09
14	0.01	0.01	0.02	0.02	0.02	0.03	0.03	0.03	0.04	0.04	0.06	0.07	0.08	0.08	0.09
15	0.01	0.01	0.01	0.02	0.02	0.03	0.03	0.03	0.04	0.04	0.06	0.06	0.07	0.08	0.08
16	*	0.01	0.01	0.02	0.02	0.02	0.03	0.03	0.03	0.04	0.05	0.06	0.07	0.07	0.08
17	*	0.01	0.01	0.02	0.02	0.02	0.02	0.03	0.03	0.03	0.05	0.06	0.06	0.07	0.07
18	*	0.01	0.01	0.01	0.02	0.02	0.02	0.02	0.03	0.03	0.04	0.05	0.06	0.06	0.07
19	*	0.01	0.01	0.01	0.01	0.02	0.02	0.02	0.02	0.03	0.04	0.05	0.05	0.06	0.06
20	*	0.01	0.01	0.01	0.01	0.02	0.02	0.02	0.02	0.03	0.04	0.05	0.05	0.06	0.06
21	*	0.01	0.01	0.01	0.01	0.01	0.02	0.02	0.02	0.02	0.04	0.04	0.05	0.05	0.06
22	*	0.01	0.01	0.01	0.01	0.01	0.01	0.02	0.02	0.02	0.03	0.04	0.04	0.05	0.05
23	*	*	0.01	0.01	0.01	0.01	0.01	0.01	0.02	0.02	0.03	0.04	0.04	0.05	0.05
24	*	*	0.01	0.01	0.01	0.01	0.01	0.01	0.01	0.02	0.03	0.04	0.04	0.05	0.05
25	*	*	0.01	0.01	0.01	0.01	0.01	0.01	0.01	0.02	0.03	0.04	0.04	0.05	0.05

An "\*" in the table means an INDEX less than 0.005

**TOTAL DOSE (FALLOUT)**  
**n = 2.0**

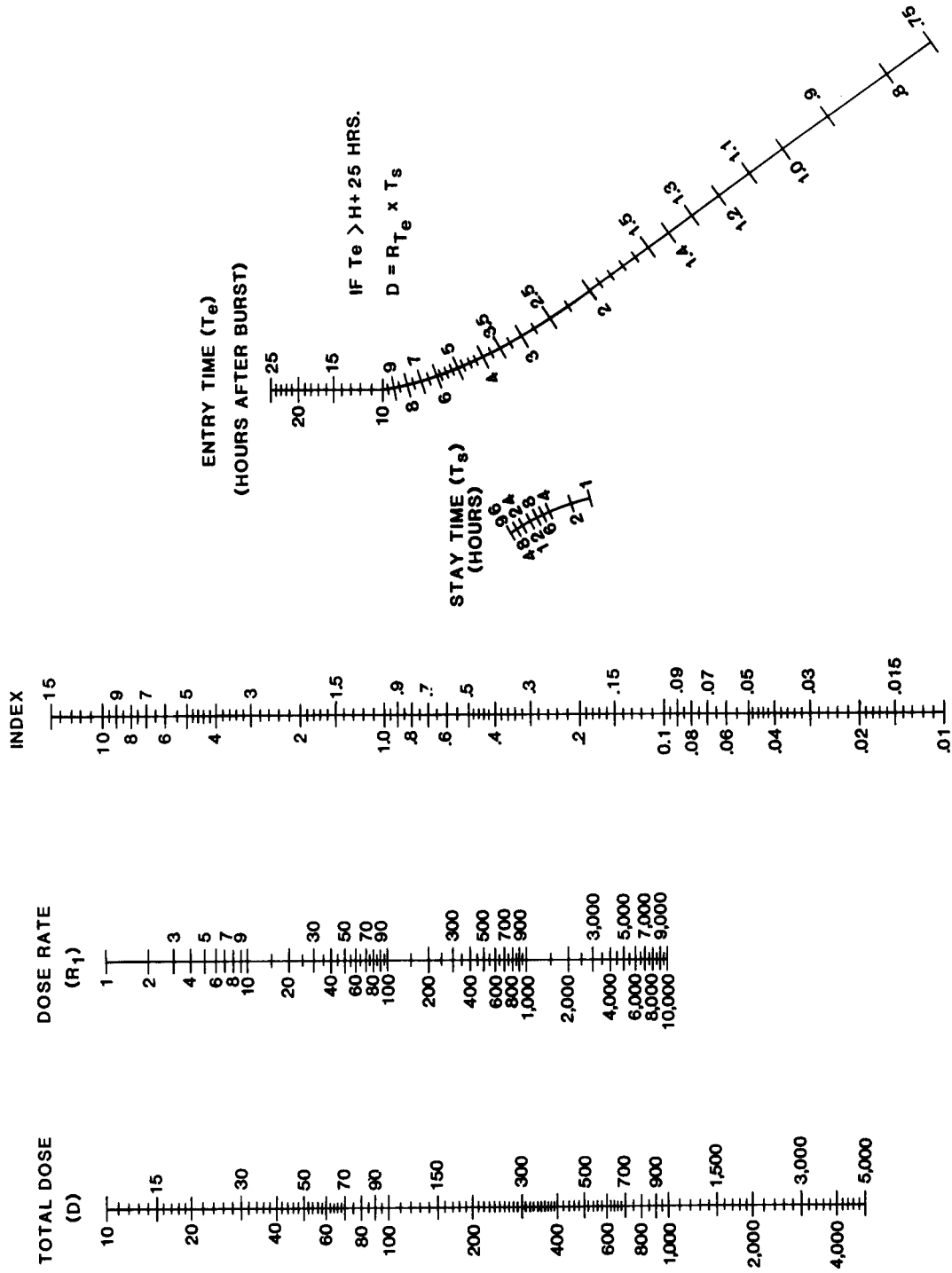

Figure E-44. Total dose (fallout) nomogram n = 2.0.

Table E-42. Index for total dose (fallout)  $n = 2.0$ .

Enter table with entry time (Te) and stay time (Ts) to find INDEX

Entry time hrs after burst (Te)	Stay time in hours (Ts)															
	1	2	3	4	5	6	7	8	10	12	24	36	48	72	96	
0.75	0.76	0.97	1.1	1.1	1.2	1.2	1.2	1.2	1.2	1.3	1.3	1.3	1.3	1.3	1.3	
0.8	0.69	0.90	0.99	1	1.1	1.1	1.1	1.1	1.2	1.2	1.2	1.2	1.2	1.2	1.2	
0.9	0.58	0.77	0.85	0.91	0.94	0.97	0.98	1	1	1	1.1	1.1	1.1	1.1	1.1	
1	0.5	0.67	0.75	0.8	0.83	0.86	0.86	0.89	0.91	0.92	0.96	0.97	0.96	0.99	0.99	
1.1	0.43	0.59	0.67	0.71	0.75	0.77	0.79	0.8	0.82	0.83	0.87	0.86	0.89	0.9	0.9	
1.2	0.36	0.52	0.6	0.64	0.67	0.69	0.71	0.72	0.74	0.76	0.79	0.81	0.81	0.82	0.82	
1.3	0.33	0.47	0.54	0.58	0.61	0.63	0.65	0.66	0.68	0.69	0.73	0.74	0.75	0.76	0.76	
1.4	0.3	0.42	0.49	0.53	0.56	0.58	0.6	0.61	0.63	0.64	0.67	0.69	0.69	0.7	0.7	
1.5	0.27	0.36	0.44	0.48	0.51	0.53	0.55	0.56	0.58	0.59	0.63	0.64	0.65	0.65	0.66	
1.6	0.24	0.35	0.41	0.45	0.47	0.49	0.51	0.52	0.54	0.55	0.59	0.6	0.6	0.61	0.61	
1.7	0.22	0.32	0.38	0.41	0.44	0.46	0.47	0.49	0.5	0.52	0.56	0.56	0.57	0.57	0.58	
1.8	0.2	0.29	0.36	0.38	0.41	0.43	0.44	0.45	0.47	0.48	0.52	0.53	0.54	0.54	0.55	
1.9	0.18	0.27	0.32	0.36	0.38	0.4	0.41	0.43	0.44	0.45	0.49	0.5	0.51	0.51	0.52	
2	0.17	0.25	0.3	0.33	0.36	0.38	0.39	0.4	0.42	0.43	0.46	0.47	0.48	0.49	0.49	
2.25	0.14	0.21	0.25	0.28	0.31	0.32	0.34	0.35	0.36	0.37	0.41	0.42	0.42	0.43	0.43	
2.5	0.11	0.18	0.22	0.25	0.27	0.28	0.29	0.3	0.32	0.33	0.36	0.37	0.38	0.39	0.39	
2.75	0.1	0.15	0.19	0.22	0.23	0.25	0.26	0.27	0.29	0.3	0.33	0.34	0.34	0.35	0.35	
3	0.08	0.13	0.17	0.19	0.21	0.22	0.23	0.24	0.26	0.27	0.3	0.31	0.31	0.32	0.32	
3.25	0.07	0.12	0.15	0.17	0.19	0.2	0.21	0.22	0.23	0.24	0.27	0.28	0.29	0.29	0.3	
3.5	0.06	0.1	0.13	0.15	0.17	0.18	0.19	0.2	0.21	0.22	0.25	0.26	0.27	0.27	0.28	
3.75	0.06	0.09	0.12	0.14	0.15	0.16	0.17	0.18	0.19	0.2	0.23	0.24	0.25	0.25	0.26	
4	0.05	0.08	0.11	0.13	0.14	0.15	0.16	0.17	0.18	0.19	0.21	0.23	0.23	0.24	0.24	
4.5	0.04	0.07	0.09	0.1	0.12	0.13	0.14	0.14	0.15	0.16	0.19	0.2	0.2	0.21	0.21	
5	0.03	0.06	0.08	0.09	0.1	0.11	0.12	0.12	0.13	0.14	0.17	0.18	0.18	0.19	0.19	
5.5	0.03	0.05	0.06	0.06	0.09	0.09	0.1	0.11	0.12	0.12	0.15	0.16	0.16	0.17	0.17	
6	0.02	0.04	0.06	0.07	0.08	0.08	0.09	0.1	0.1	0.11	0.13	0.14	0.15	0.15	0.16	
6.5	0.02	0.04	0.05	0.06	0.07	0.07	0.08	0.08	0.09	0.1	0.12	0.13	0.14	0.14	0.14	
7	0.02	0.03	0.04	0.05	0.06	0.07	0.07	0.08	0.08	0.09	0.11	0.12	0.12	0.13	0.13	
7.5	0.02	0.03	0.04	0.05	0.05	0.06	0.06	0.07	0.08	0.08	0.1	0.11	0.12	0.12	0.12	
8	0.01	0.02	0.03	0.04	0.05	0.05	0.06	0.06	0.07	0.08	0.09	0.1	0.11	0.11	0.12	
8.5	0.01	0.02	0.03	0.04	0.04	0.05	0.05	0.06	0.06	0.07	0.09	0.1	0.1	0.11	0.11	
9	0.01	0.02	0.03	0.03	0.04	0.04	0.05	0.05	0.06	0.06	0.08	0.09	0.09	0.1	0.1	
9.5	0.01	0.02	0.03	0.03	0.04	0.04	0.04	0.05	0.05	0.06	0.08	0.08	0.09	0.09	0.1	
10	0.01	0.02	0.02	0.03	0.03	0.04	0.04	0.04	0.05	0.05	0.07	0.08	0.08	0.09	0.09	
11	0.01	0.01	0.02	0.02	0.03	0.03	0.04	0.04	0.04	0.05	0.06	0.07	0.07	0.08	0.08	
12	0.01	0.01	0.02	0.02	0.02	0.03	0.03	0.03	0.04	0.04	0.06	0.06	0.07	0.07	0.07	
13	0.01	0.01	0.01	0.02	0.02	0.02	0.03	0.03	0.03	0.04	0.05	0.06	0.06	0.07	0.07	
14	*	0.01	0.01	0.02	0.02	0.02	0.02	0.03	0.03	0.03	0.05	0.05	0.06	0.06	0.06	
15	*	0.01	0.01	0.01	0.02	0.02	0.02	0.02	0.03	0.03	0.04	0.05	0.05	0.06	0.06	
16	*	0.01	0.01	0.01	0.01	0.02	0.02	0.02	0.02	0.03	0.04	0.04	0.05	0.05	0.05	
17	*	0.01	0.01	0.01	0.01	0.02	0.02	0.02	0.02	0.02	0.03	0.04	0.04	0.05	0.05	
18	*	0.01	0.01	0.01	0.01	0.01	0.02	0.02	0.02	0.02	0.03	0.04	0.04	0.04	0.05	
19	*	0.01	0.01	0.01	0.01	0.01	0.01	0.02	0.02	0.02	0.03	0.03	0.04	0.04	0.04	
20	*	*	0.01	0.01	0.01	0.01	0.01	0.01	0.02	0.02	0.03	0.03	0.04	0.04	0.04	
21	*	*	0.01	0.01	0.01	0.01	0.01	0.01	0.02	0.02	0.03	0.03	0.03	0.04	0.04	
22	*	*	0.01	0.01	0.01	0.01	0.01	0.01	0.01	0.02	0.02	0.03	0.03	0.03	0.04	
23	*	*	0.01	0.01	0.01	0.01	0.01	0.01	0.01	0.01	0.02	0.03	0.03	0.03	0.04	
24	*	*	*	0.01	0.01	0.01	0.01	0.01	0.01	0.01	0.02	0.03	0.03	0.03	0.03	
25	*	*	*	0.01	0.01	0.01	0.01	0.01	0.01	0.01	0.02	0.02	0.03	0.03	0.03	

An "\*" in the table means an INDEX less than 0.005



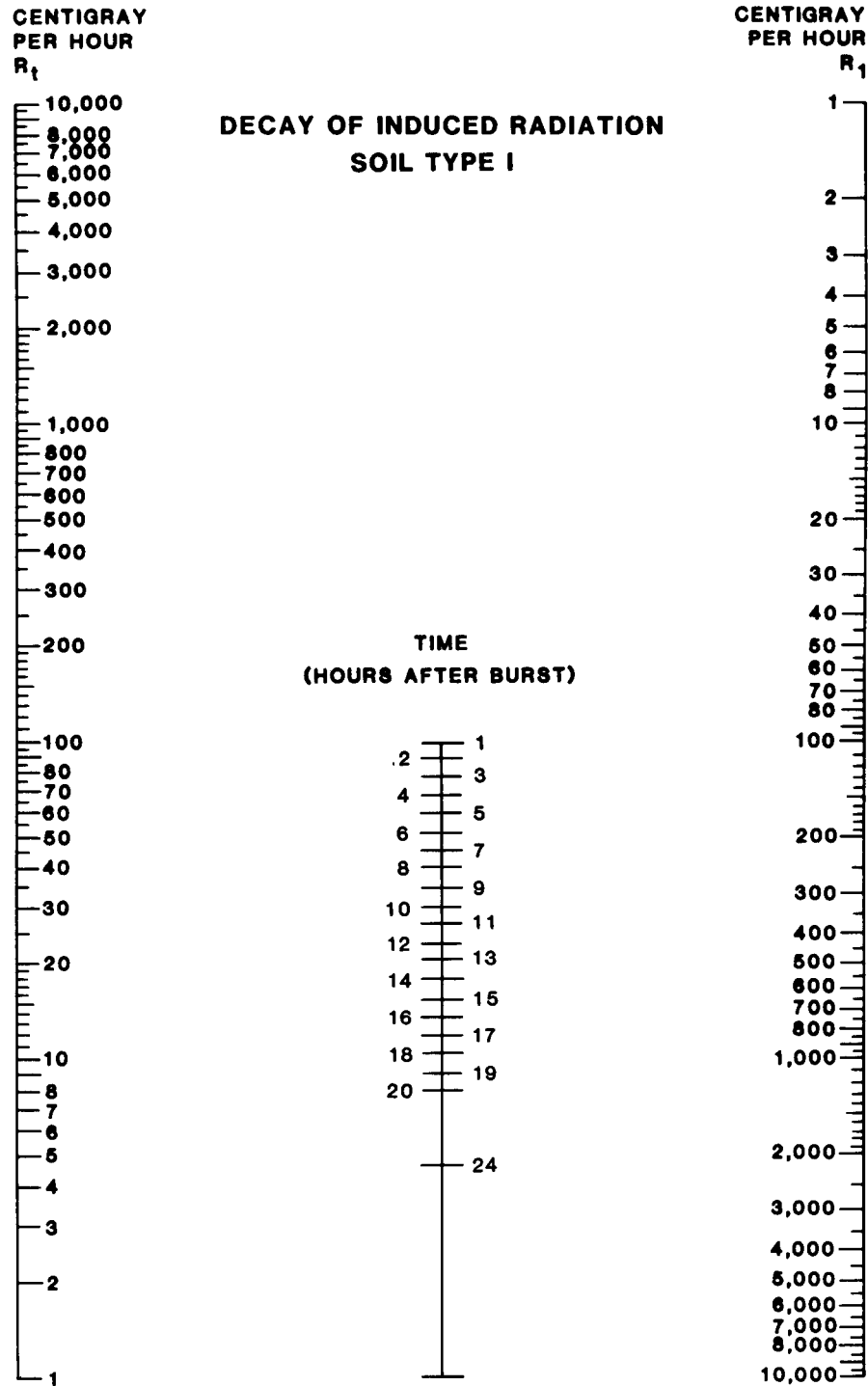

Figure 44. Soil Type I nomogram.

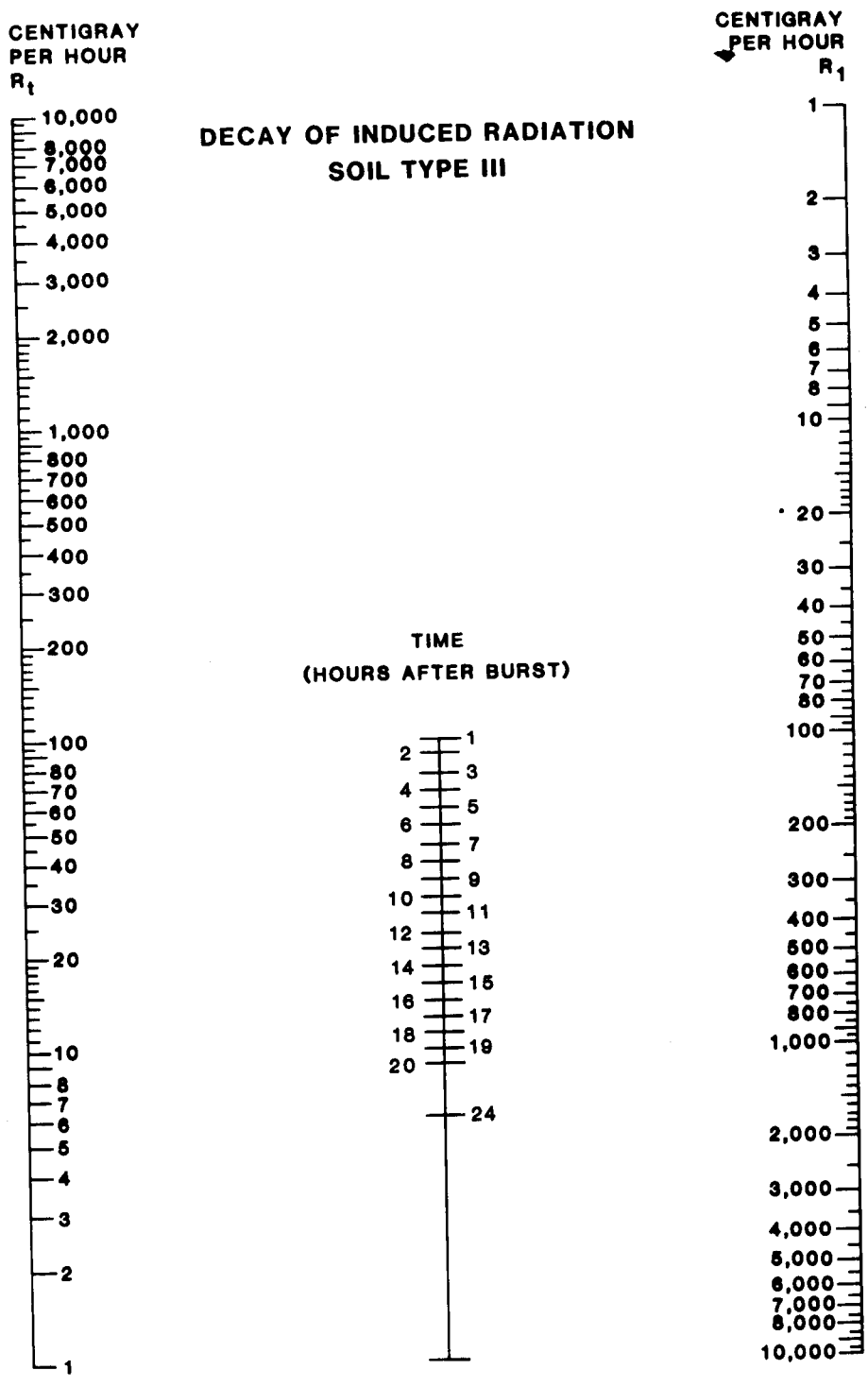

Figure E-45. Soil Type III nomogram.

Table E-46. Index for total dose NIGA, Soil Types I and III.

Enter table with entry time (Te) and stay time (Ts) to find INDEX

Entry time hrs after burst (Te)	Stay time in hours (Ts)																					
	0.1	0.15	0.2	0.3	0.4	0.5	0.6	0.7	0.8	0.9	1	1.5	2	3	4	5	6	7	8	9	10	INF
1	0.1	0.15	0.2	0.3	0.4	0.5	0.6	0.7	0.8	0.9	1	1.5	2	3	4	5	6	7	8	9	10	INF
2	0.08	0.11	0.15	0.22	0.29	0.36	0.42	0.48	0.55	0.61	0.67	0.74	0.81	0.88	0.95	1.02	1.09	1.16	1.23	1.30	1.37	1.44
3	0.06	0.09	0.11	0.17	0.22	0.27	0.32	0.37	0.42	0.47	0.51	0.56	0.61	0.66	0.71	0.76	0.81	0.86	0.91	0.96	1.01	1.06
4	0.04	0.07	0.09	0.13	0.17	0.21	0.25	0.29	0.33	0.37	0.41	0.45	0.49	0.53	0.57	0.61	0.65	0.69	0.73	0.77	0.81	0.85
5	0.03	0.05	0.07	0.1	0.13	0.16	0.19	0.22	0.25	0.28	0.31	0.34	0.37	0.4	0.43	0.46	0.49	0.52	0.55	0.58	0.61	0.64
6	0.03	0.04	0.05	0.08	0.1	0.12	0.15	0.17	0.19	0.21	0.23	0.25	0.27	0.29	0.31	0.33	0.35	0.37	0.39	0.41	0.43	0.45
7	0.02	0.03	0.04	0.06	0.08	0.1	0.12	0.14	0.16	0.18	0.2	0.22	0.24	0.26	0.28	0.3	0.32	0.34	0.36	0.38	0.4	0.42
8	0.02	0.02	0.03	0.04	0.06	0.07	0.09	0.1	0.11	0.12	0.14	0.15	0.17	0.18	0.2	0.22	0.24	0.26	0.28	0.3	0.32	0.34
9	0.01	0.02	0.02	0.03	0.04	0.05	0.07	0.08	0.09	0.1	0.11	0.12	0.14	0.15	0.17	0.18	0.2	0.22	0.24	0.26	0.28	0.3
10	0.01	0.01	0.02	0.03	0.03	0.04	0.05	0.06	0.07	0.07	0.08	0.1	0.11	0.12	0.14	0.15	0.17	0.18	0.2	0.22	0.24	0.26
11	0.01	0.01	0.01	0.02	0.03	0.03	0.04	0.05	0.05	0.06	0.07	0.08	0.09	0.1	0.11	0.12	0.14	0.15	0.17	0.18	0.2	0.22
12	0.01	0.01	0.01	0.02	0.02	0.03	0.03	0.04	0.04	0.05	0.05	0.06	0.07	0.08	0.09	0.1	0.11	0.12	0.14	0.15	0.17	0.18
13	0	0.01	0.01	0.01	0.02	0.02	0.03	0.03	0.04	0.04	0.05	0.05	0.06	0.07	0.08	0.09	0.1	0.11	0.12	0.14	0.15	0.17
14	0	0	0.01	0.01	0.01	0.02	0.02	0.03	0.03	0.04	0.04	0.05	0.05	0.06	0.07	0.08	0.09	0.1	0.11	0.12	0.14	0.15
15	0	0	0	0.01	0.01	0.01	0.02	0.02	0.03	0.03	0.04	0.04	0.05	0.05	0.06	0.07	0.08	0.09	0.1	0.11	0.12	0.14
20	0	0	0	0	0	0	0	0.01	0.01	0.01	0.02	0.02	0.03	0.03	0.04	0.04	0.05	0.05	0.06	0.07	0.08	0.09
25	0	0	0	0	0	0	0	0	0	0	0.01	0.01	0.01	0.02	0.02	0.02	0.03	0.03	0.03	0.03	0.03	0.03
30	0	0	0	0	0	0	0	0	0	0	0	0	0	0.01	0.01	0.01	0.01	0.01	0.01	0.01	0.01	0.01
35	0	0	0	0	0	0	0	0	0	0	0	0	0	0	0	0	0	0	0	0	0	0
40	0	0	0	0	0	0	0	0	0	0	0	0	0	0	0	0	0	0	0	0	0	0
45	0	0	0	0	0	0	0	0	0	0	0	0	0	0	0	0	0	0	0	0	0	0
50	0	0	0	0	0	0	0	0	0	0	0	0	0	0	0	0	0	0	0	0	0	0
55	0	0	0	0	0	0	0	0	0	0	0	0	0	0	0	0	0	0	0	0	0	0
60	0	0	0	0	0	0	0	0	0	0	0	0	0	0	0	0	0	0	0	0	0	0
65	0	0	0	0	0	0	0	0	0	0	0	0	0	0	0	0	0	0	0	0	0	0
70	0	0	0	0	0	0	0	0	0	0	0	0	0	0	0	0	0	0	0	0	0	0
75	0	0	0	0	0	0	0	0	0	0	0	0	0	0	0	0	0	0	0	0	0	0
80	0	0	0	0	0	0	0	0	0	0	0	0	0	0	0	0	0	0	0	0	0	0
85	0	0	0	0	0	0	0	0	0	0	0	0	0	0	0	0	0	0	0	0	0	0
90	0	0	0	0	0	0	0	0	0	0	0	0	0	0	0	0	0	0	0	0	0	0
95	0	0	0	0	0	0	0	0	0	0	0	0	0	0	0	0	0	0	0	0	0	0
100	0	0	0	0	0	0	0	0	0	0	0	0	0	0	0	0	0	0	0	0	0	0

INF stands for infinite stay time (occupation of the NIGA area).



Table E-47. NIGA decay table, Soil Types I and III

Centigray per hour (R1)	TIME (HOURS AFTER BURST)																					
	2	3	4	5	6	7	8	9	10	11	12	13	14	15	16	17	18	19	20	22	24	30
1	1	1	0	0	0	0	0	0	0	0	0	0	0	0	0	0	0	0	0	0	0	0
2	2	1	1	1	1	0	0	0	0	0	0	0	0	0	0	0	0	0	0	0	0	0
3	2	2	1	1	1	1	0	0	0	0	0	0	0	0	0	0	0	0	0	0	0	0
4	3	2	2	1	1	1	1	0	0	0	0	0	0	0	0	0	0	0	0	0	0	0
5	4	3	2	2	1	1	1	1	0	0	0	0	0	0	0	0	0	0	0	0	0	0
6	5	4	3	2	2	1	1	1	1	0	0	0	0	0	0	0	0	0	0	0	0	0
7	5	4	3	2	2	1	1	1	1	0	0	0	0	0	0	0	0	0	0	0	0	0
8	6	5	4	3	2	2	1	1	1	1	0	0	0	0	0	0	0	0	0	0	0	0
9	7	5	4	3	2	2	1	1	1	1	0	0	0	0	0	0	0	0	0	0	0	0
10	8	6	4	3	3	2	2	1	1	1	1	0	0	0	0	0	0	0	0	0	0	0
15	11	9	7	5	4	3	2	2	1	1	1	1	0	0	0	0	0	0	0	0	0	0
20	15	12	9	7	5	4	3	2	2	1	1	1	1	0	0	0	0	0	0	0	0	0
25	19	15	11	9	7	5	4	3	2	2	1	1	1	1	0	0	0	0	0	0	0	0
30	23	18	13	10	8	6	5	4	3	2	2	1	1	1	1	0	0	0	0	0	0	0
35	27	20	16	12	9	7	5	4	3	2	2	1	1	1	1	1	0	0	0	0	0	0
40	31	23	18	14	10	8	6	5	4	3	2	2	1	1	1	1	0	0	0	0	0	0
45	34	26	20	15	12	9	7	5	4	3	2	2	1	1	1	1	1	0	0	0	0	0
50	38	29	22	17	13	10	8	6	5	3	3	2	2	1	1	1	1	0	0	0	0	0
60	46	35	27	21	16	12	9	7	5	4	3	2	2	1	1	1	1	1	0	0	0	0
70	54	41	31	24	18	14	11	8	6	5	4	3	2	2	1	1	1	1	0	0	0	0
80	61	47	36	27	21	16	12	9	7	6	4	3	3	2	2	1	1	1	1	0	0	0
90	69	53	40	31	24	18	14	11	8	6	5	4	3	2	2	1	1	1	1	0	0	0
100	78	59	45	34	26	20	15	12	9	7	5	4	3	2	2	1	1	1	1	0	0	0
150	115	88	67	51	39	30	23	18	14	10	8	6	5	4	3	2	2	1	1	1	0	0
200	153	117	90	69	52	40	31	24	18	14	11	8	6	5	4	3	2	2	1	1	1	0
250	191	146	112	86	66	50	39	30	23	17	13	10	8	6	5	4	3	2	2	1	1	0
300	229	178	134	103	79	60	46	35	27	21	16	12	10	7	6	4	3	3	2	1	1	0
350	268	205	157	120	92	70	54	41	32	24	19	14	11	9	7	5	4	3	2	2	1	0
400	308	234	179	137	105	80	62	47	36	28	21	16	13	10	8	6	5	4	3	2	1	0
450	344	263	202	154	118	90	69	53	41	31	24	19	14	11	9	7	5	4	3	2	1	0
500	382	293	224	171	131	100	77	59	45	35	27	21	16	12	10	7	6	5	4	2	1	1
550	421	322	246	189	144	111	85	65	50	38	29	23	17	13	10	8	6	5	4	2	2	1
600	459	351	269	206	157	121	92	71	54	42	32	25	19	15	11	9	7	5	4	3	2	1
650	497	380	291	223	171	131	100	77	59	45	35	27	21	16	12	10	7	6	5	3	2	1
700	535	410	313	240	184	141	108	83	63	49	37	29	22	17	13	10	8	6	5	3	2	1
750	574	439	336	257	197	151	116	89	68	52	40	31	24	18	14	11	9	7	5	3	2	1
800	612	468	358	274	210	161	123	94	72	56	43	33	25	20	15	12	9	7	6	4	2	1
850	650	497	381	291	223	171	131	100	77	59	45	35	27	21	16	13	10	8	6	4	3	1
900	688	527	403	308	236	181	139	106	82	63	48	37	29	22	17	13	10	8	6	4	3	1
950	727	556	425	326	249	191	146	112	86	66	51	39	30	23	18	14	11	9	7	4	3	1
1000	765	585	448	343	262	201	154	118	91	70	53	41	32	25	19	15	12	9	7	5	3	1
1100	841	644	493	377	289	221	169	130	100	77	59	45	35	27	21	16	13	10	8	5	3	1
1200	918	702	537	411	315	241	185	142	109	83	64	49	38	29	23	18	14	11	9	5	4	1
1300	994	761	582	446	341	261	200	153	118	90	70	54	41	32	25	19	15	12	9	6	4	1
1400	1071	819	627	480	367	281	216	165	127	97	75	58	44	34	27	21	16	13	10	6	4	2
1500	1147	878	672	514	394	301	231	177	136	104	80	62	48	37	29	22	17	14	11	7	4	2
1600	1224	936	716	548	420	322	246	189	145	111	86	66	51	39	30	24	18	14	11	7	5	2
1700	1300	995	761	583	446	342	262	201	154	118	91	70	54	42	32	25	20	15	12	8	5	2
1800	1377	1053	806	617	472	362	277	213	163	125	96	74	57	44	34	27	21	16	13	8	5	2
1900	1453	1112	851	651	499	382	293	224	172	132	102	78	60	47	36	28	22	17	14	9	6	2
2000	1530	1170	896	685	525	402	308	236	181	139	107	82	64	49	38	30	23	18	14	9	6	2
2500	1912	1463	1119	857	656	502	385	295	226	174	134	103	79	61	48	37	29	23	18	11	7	3
3000	2295	1756	1343	1028	787	603	462	354	272	209	160	124	95	74	57	44	35	27	21	14	9	3
3500	2677	2048	1567	1200	918	703	539	413	317	244	187	144	111	86	67	52	40	32	25	16	10	4
4000	3060	2341	1791	1371	1050	804	616	472	362	278	214	165	127	98	76	59	46	36	28	18	12	4
4500	3442	2633	2015	1542	1181	904	693	531	408	313	241	185	143	110	86	66	52	41	32	20	13	5
5000	3825	2926	2239	1714	1312	1005	770	590	453	348	267	206	159	123	95	74	58	45	36	23	15	5

Rt in Centigray per hour

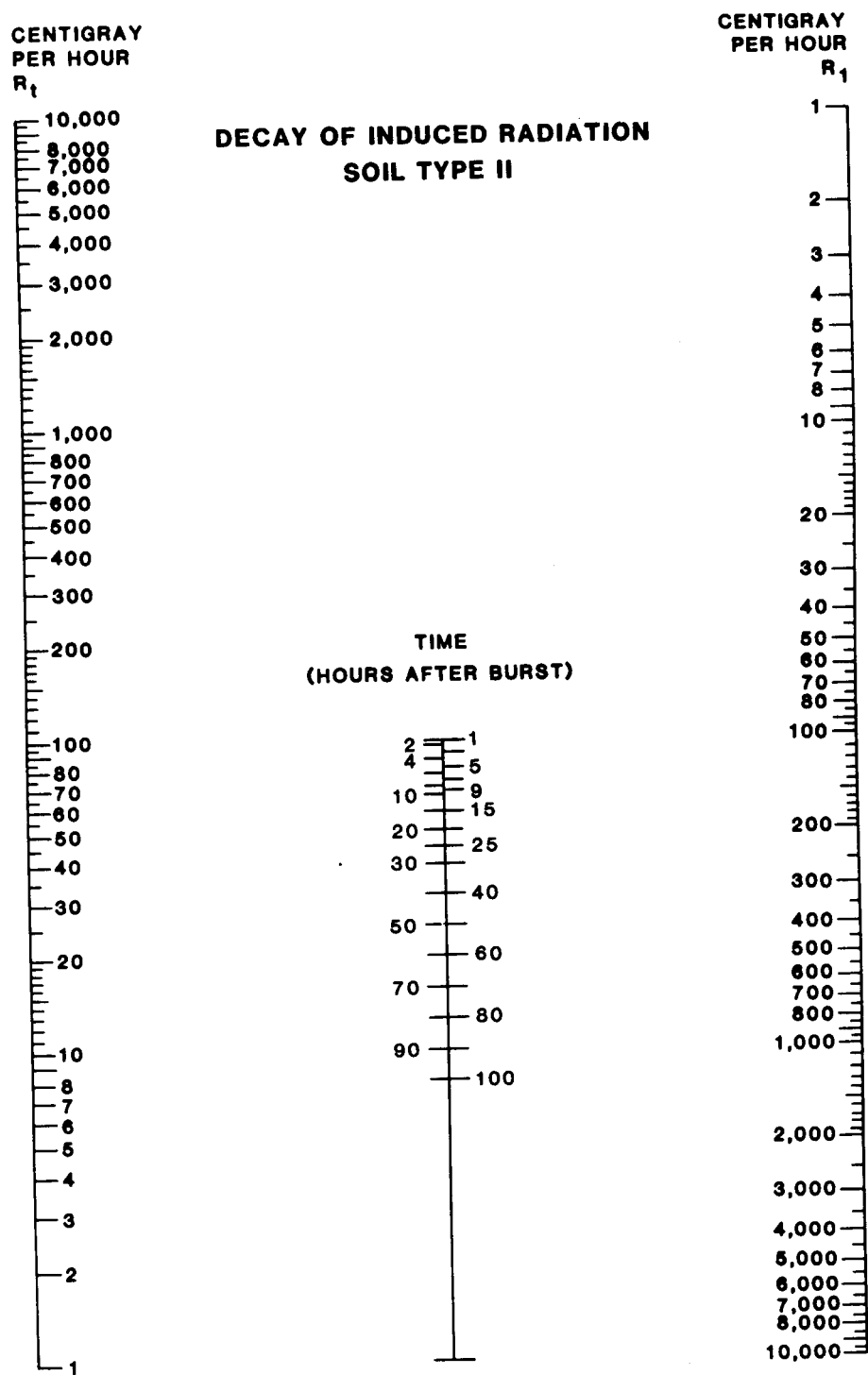

Figure E-48. Soil Type II nomogram.

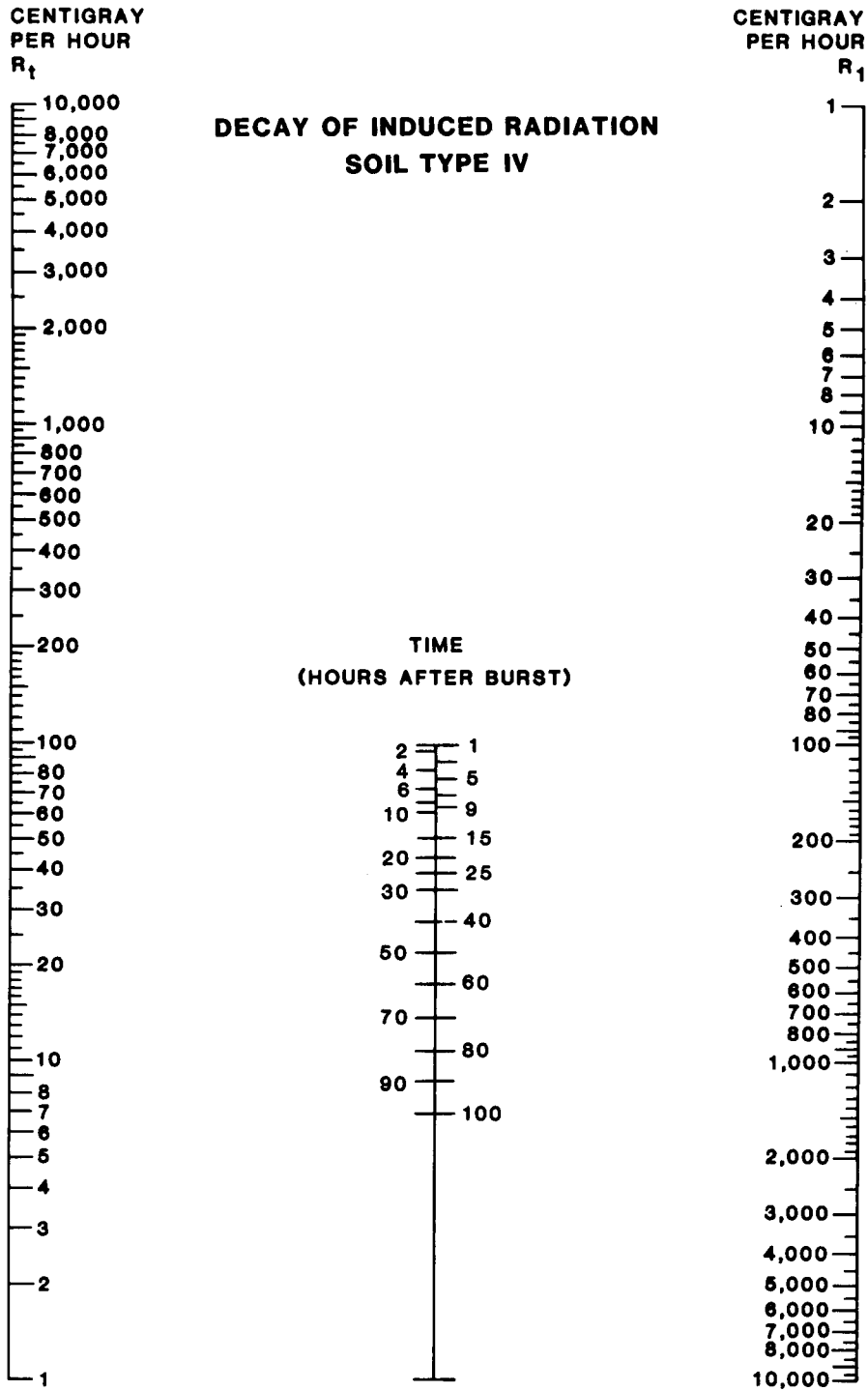

Figure E-49. Soil Type IV nomogram.

Table E-50. Index for total dose, NIGA, Soil Types II and IV.

Enter table with entry time (Te) and stay time (Ts) to find INDEX

Entry time hrs after burst (Te)	Stay time in hours (Ts)																					
	0.1	0.15	0.2	0.3	0.4	0.5	0.6	0.7	0.8	0.9	1	1.5	2	3	4	5	6	7	8	9	10	INF
1	0.1	0.15	0.2	0.28	0.36	0.46	0.56	0.67	0.76	0.85	0.94	1.37	1.78	2.53	3.21	3.84	4.41	4.95	5.44	5.91	6.35	15.09
2	0.09	0.13	0.17	0.23	0.31	0.43	0.51	0.6	0.68	0.76	0.84	1.22	1.59	2.27	2.9	3.47	4.01	4.5	4.97	5.41	5.82	14.15
3	0.08	0.12	0.16	0.23	0.31	0.39	0.49	0.59	0.68	0.76	0.85	1.1	1.44	2.06	2.64	3.17	3.67	4.13	4.57	4.98	5.37	13.31
4	0.07	0.11	0.14	0.21	0.28	0.35	0.42	0.49	0.56	0.62	0.68	1	1.31	1.86	2.42	2.91	3.38	3.82	4.23	4.62	4.99	12.56
5	0.06	0.1	0.13	0.19	0.26	0.32	0.38	0.44	0.5	0.56	0.62	0.82	1.1	1.73	2.23	2.71	3.13	3.55	3.94	4.3	4.65	11.87
6	0.06	0.09	0.12	0.18	0.24	0.29	0.35	0.41	0.48	0.52	0.58	0.85	1.11	1.61	2.07	2.51	2.92	3.31	3.68	4.03	4.38	11.25
7	0.06	0.08	0.11	0.16	0.22	0.27	0.32	0.38	0.43	0.48	0.53	0.79	1.03	1.5	1.93	2.35	2.74	3.1	3.45	3.79	4.1	10.87
8	0.05	0.08	0.1	0.15	0.2	0.25	0.3	0.35	0.4	0.45	0.5	0.73	0.98	1.4	1.81	2.2	2.57	2.92	3.25	3.57	3.87	10.14
9	0.05	0.07	0.1	0.14	0.19	0.24	0.28	0.33	0.37	0.42	0.47	0.69	0.9	1.32	1.7	2.07	2.42	2.75	3.07	3.37	3.66	9.64
10	0.04	0.07	0.09	0.13	0.18	0.22	0.27	0.31	0.35	0.39	0.44	0.65	0.85	1.24	1.61	1.96	2.29	2.6	2.91	3.19	3.46	9.18
11	0.04	0.06	0.08	0.13	0.17	0.21	0.25	0.29	0.33	0.37	0.41	0.61	0.8	1.17	1.52	1.85	2.17	2.47	2.75	3.03	3.29	8.74
12	0.04	0.06	0.08	0.12	0.16	0.2	0.24	0.27	0.31	0.35	0.39	0.58	0.78	1.11	1.44	1.76	2.08	2.34	2.61	2.87	3.12	8.33
13	0.04	0.06	0.08	0.11	0.15	0.19	0.22	0.26	0.3	0.33	0.37	0.55	0.72	1.05	1.37	1.67	1.95	2.22	2.48	2.73	2.97	7.94
14	0.04	0.05	0.07	0.11	0.14	0.18	0.21	0.25	0.28	0.32	0.35	0.52	0.68	1	1.3	1.59	1.88	2.12	2.38	2.6	2.82	7.57
15	0.03	0.05	0.07	0.1	0.13	0.17	0.2	0.23	0.27	0.3	0.33	0.49	0.65	0.95	1.23	1.51	1.77	2.01	2.25	2.47	2.69	7.22
20	0.03	0.04	0.05	0.08	0.11	0.13	0.16	0.18	0.21	0.23	0.26	0.38	0.51	0.74	0.97	1.18	1.39	1.58	1.77	1.95	2.12	5.71
25	0.02	0.03	0.04	0.06	0.08	0.1	0.12	0.14	0.16	0.18	0.2	0.3	0.4	0.59	0.77	0.94	1.1	1.25	1.4	1.54	1.68	4.53
30	0.02	0.02	0.03	0.05	0.07	0.08	0.1	0.11	0.13	0.15	0.18	0.24	0.32	0.47	0.61	0.74	0.87	0.98	1.11	1.22	1.33	3.59
35	0.01	0.02	0.03	0.04	0.05	0.07	0.08	0.09	0.1	0.12	0.13	0.18	0.25	0.37	0.49	0.59	0.69	0.79	0.88	0.97	1.06	2.85
40	0.01	0.02	0.02	0.03	0.04	0.05	0.06	0.07	0.08	0.09	0.1	0.15	0.2	0.29	0.38	0.47	0.56	0.63	0.7	0.77	0.84	2.28
45	0.01	0.01	0.02	0.02	0.03	0.04	0.05	0.06	0.07	0.08	0.09	0.12	0.16	0.23	0.3	0.37	0.44	0.5	0.56	0.61	0.66	1.8
50	0.01	0.01	0.01	0.02	0.03	0.04	0.05	0.06	0.07	0.08	0.09	0.1	0.13	0.18	0.24	0.29	0.35	0.39	0.44	0.49	0.53	1.43
55	0.01	0.01	0.01	0.02	0.03	0.04	0.05	0.06	0.07	0.08	0.09	0.1	0.15	0.19	0.23	0.27	0.31	0.35	0.39	0.42	0.45	1.13
60	0	0.01	0.01	0.01	0.02	0.03	0.04	0.05	0.06	0.07	0.08	0.1	0.15	0.19	0.23	0.27	0.31	0.35	0.39	0.42	0.45	0.9
65	0	0	0.01	0.01	0.01	0.02	0.03	0.04	0.05	0.06	0.07	0.1	0.15	0.19	0.23	0.27	0.31	0.35	0.39	0.42	0.45	0.71
70	0	0	0.01	0.01	0.01	0.02	0.03	0.04	0.05	0.06	0.07	0.1	0.15	0.19	0.23	0.27	0.31	0.35	0.39	0.42	0.45	0.57
75	0	0	0	0.01	0.01	0.01	0.02	0.03	0.04	0.05	0.06	0.07	0.1	0.15	0.19	0.23	0.27	0.31	0.35	0.39	0.42	0.45
80	0	0	0	0	0.01	0.01	0.01	0.02	0.03	0.04	0.05	0.06	0.07	0.1	0.15	0.19	0.23	0.27	0.31	0.35	0.39	0.45
85	0	0	0	0	0.01	0.01	0.01	0.02	0.03	0.04	0.05	0.06	0.07	0.1	0.15	0.19	0.23	0.27	0.31	0.35	0.39	0.45
90	0	0	0	0	0	0.01	0.01	0.01	0.02	0.03	0.04	0.05	0.06	0.07	0.1	0.15	0.19	0.23	0.27	0.31	0.35	0.45
95	0	0	0	0	0	0	0.01	0.01	0.01	0.02	0.03	0.04	0.05	0.06	0.07	0.1	0.15	0.19	0.23	0.27	0.31	0.45
100	0	0	0	0	0	0	0	0.01	0.01	0.01	0.02	0.03	0.04	0.05	0.06	0.07	0.1	0.15	0.19	0.23	0.27	0.45

INF stands for infinite stay time (occupation of the NIGA area).

Table E-51. NIGA decay table, Soil Type II.

Centigray per hour (R1)	TIME (HOURS AFTER BURST)																			
	2	3	4	5	6	7	8	9	10	15	20	25	30	40	50	60	70	80	90	100
1	1	1	1	1	1	1	1	0	0	0	0	0	0	0	0	0	0	0	0	0
2	2	2	1	1	1	1	1	1	1	1	1	0	0	0	0	0	0	0	0	0
3	3	2	2	2	2	2	2	1	1	1	1	1	0	0	0	0	0	0	0	0
4	4	3	3	3	2	2	2	2	2	1	1	1	1	0	0	0	0	0	0	0
5	4	4	4	3	3	3	3	2	2	2	1	1	1	1	0	0	0	0	0	0
6	5	5	4	4	4	3	3	3	3	2	2	1	1	1	0	0	0	0	0	0
7	6	6	5	5	4	4	4	3	3	2	2	1	1	1	0	0	0	0	0	0
8	7	6	6	5	5	4	4	4	4	3	2	2	1	1	1	0	0	0	0	0
9	8	7	6	6	5	5	5	4	4	3	2	2	1	1	1	0	0	0	0	0
10	9	8	7	7	6	6	5	5	5	3	3	2	2	1	1	0	0	0	0	0
15	13	12	11	10	9	8	8	7	7	5	4	3	2	2	1	1	0	0	0	0
20	18	16	14	13	12	11	10	10	9	7	5	4	3	2	1	1	1	0	0	0
25	22	20	18	16	15	14	13	12	11	9	7	5	4	3	2	1	1	0	0	0
30	27	24	21	20	18	17	15	14	14	10	8	6	5	3	2	1	1	0	0	0
35	31	28	25	23	21	19	18	17	16	12	9	7	6	4	2	1	1	1	0	0
40	35	32	29	26	24	22	21	19	18	14	11	8	7	4	3	2	1	1	0	0
45	40	36	32	29	27	25	23	22	20	15	12	9	7	5	3	2	1	1	0	0
50	44	40	36	33	30	28	26	24	23	17	13	10	8	5	3	2	1	1	1	0
60	53	48	43	39	36	33	31	29	27	20	16	13	10	6	4	2	2	1	1	0
70	62	55	50	46	42	39	36	34	32	24	19	15	12	7	5	3	2	1	1	0
80	71	63	57	52	48	44	41	38	36	27	21	17	13	8	5	3	2	1	1	1
90	80	71	64	59	54	50	46	43	41	31	24	19	15	9	6	4	2	1	1	1
100	89	79	72	65	60	55	51	48	45	34	27	21	17	10	7	4	3	2	1	1
150	133	119	107	98	90	83	77	72	68	51	40	31	25	16	10	6	4	2	2	1
200	177	158	143	130	120	111	103	96	90	68	53	42	33	21	13	8	5	3	2	1
250	221	198	179	163	150	138	129	120	113	85	66	52	42	26	16	10	7	4	3	2
300	268	238	215	196	180	166	154	144	135	102	80	63	50	31	20	12	8	5	3	2
350	310	277	250	228	210	194	180	168	158	119	93	73	58	37	23	15	9	6	4	2
400	354	317	286	261	240	221	206	192	180	136	106	84	66	42	26	17	10	7	4	3
450	398	356	322	293	269	249	232	216	203	153	120	94	75	47	30	19	12	7	5	3
500	443	396	358	326	299	277	257	240	225	170	133	105	83	52	33	21	13	8	5	3
550	487	436	394	359	329	304	283	264	248	187	146	115	91	58	36	23	14	9	6	4
600	531	475	429	391	359	332	309	288	271	204	159	126	100	63	40	25	16	10	6	4
650	575	515	465	424	389	360	335	313	293	221	173	136	108	68	43	27	17	11	7	4
700	620	554	501	456	419	387	360	337	316	238	186	147	116	73	46	29	18	12	7	5
750	664	594	537	489	449	415	386	361	338	255	199	157	125	78	49	31	20	12	8	5
800	708	634	572	522	479	443	412	385	361	272	213	168	133	84	53	33	21	13	8	5
850	752	673	608	554	509	471	437	409	383	289	226	178	141	89	56	35	22	14	9	6
900	797	713	644	587	539	498	463	433	406	307	239	189	150	94	59	37	24	15	9	6
950	841	752	680	619	569	526	489	457	428	324	252	199	158	99	63	39	25	16	10	6
1000	885	792	715	652	599	554	515	481	451	341	266	210	166	105	66	42	26	16	10	7
1100	974	871	787	717	659	609	566	529	496	375	292	231	183	115	73	46	29	18	11	7
1200	1062	950	859	782	719	664	618	577	541	409	319	252	199	126	79	50	31	20	12	8
1300	1151	1030	930	848	778	720	669	625	586	443	346	273	216	136	86	54	34	21	13	9
1400	1239	1109	1002	913	838	775	721	673	631	477	372	294	233	146	92	58	37	23	15	9
1500	1328	1188	1073	978	898	830	772	721	676	511	399	315	249	157	99	62	39	25	16	10
1600	1416	1267	1145	1043	958	886	823	769	722	545	425	336	266	167	105	66	42	26	17	10
1700	1505	1346	1216	1108	1018	941	875	817	767	579	452	357	283	178	112	71	44	28	18	11
1800	1593	1425	1288	1174	1078	996	926	865	812	613	478	378	299	188	119	75	47	30	19	12
1900	1682	1505	1359	1239	1138	1052	978	914	857	647	505	399	316	199	125	79	50	31	20	12
2000	1770	1584	1431	1304	1198	1107	1029	962	902	681	532	420	332	209	132	83	52	33	21	13
2500	2213	1980	1789	1630	1497	1384	1287	1202	1127	851	664	524	416	262	165	104	65	41	26	16
3000	2656	2376	2146	1956	1796	1661	1544	1442	1353	1022	797	629	499	314	198	125	78	49	31	20
3500	3098	2772	2504	2282	2096	1937	1801	1683	1578	1192	930	734	582	366	231	145	92	58	36	23
4000	3541	3168	2862	2608	2395	2214	2059	1923	1804	1362	1063	839	665	419	264	166	105	66	42	26
4500	3983	3564	3220	2934	2695	2491	2316	2164	2029	1533	1196	944	748	471	297	187	118	74	47	29
5000	4426	3960	3577	3260	2994	2768	2573	2404	2255	1703	1329	1049	831	523	330	208	131	82	52	33

Rt in Centigray per hour

Table E-52. NIGA decay table, Soil Type IV.

Centigray per hour (R1)	TIME (HOURS AFTER BURST)																			
	2	3	4	5	6	7	8	9	10	15	20	25	30	40	50	60	70	80	90	100
1	1	1	1	1	1	0	0	0	0	0	0	0	0	0	0	0	0	0	0	0
2	2	1	1	1	1	1	1	1	1	1	0	0	0	0	0	0	0	0	0	0
3	3	2	2	2	2	1	1	1	1	1	1	0	0	0	0	0	0	0	0	0
4	3	3	3	2	2	2	2	2	1	1	1	1	0	0	0	0	0	0	0	0
5	4	4	3	3	3	2	2	2	2	1	1	1	1	0	0	0	0	0	0	0
6	5	4	4	3	3	3	3	2	2	2	1	1	1	0	0	0	0	0	0	0
7	6	5	5	4	4	3	3	3	3	2	1	1	1	1	0	0	0	0	0	0
8	7	6	5	5	4	4	3	3	3	2	2	1	1	1	0	0	0	0	0	0
9	8	7	6	5	5	4	4	4	3	2	2	1	1	1	0	0	0	0	0	0
10	9	7	7	6	5	5	4	4	4	3	2	2	1	1	1	0	0	0	0	0
15	13	11	10	9	8	7	6	6	5	4	3	2	2	1	1	0	0	0	0	0
20	17	15	13	12	10	9	9	8	7	5	4	3	3	2	1	1	0	0	0	0
25	21	19	16	14	13	12	11	10	9	7	5	4	3	2	1	1	0	0	0	0
30	26	22	20	17	16	14	13	12	11	8	6	5	4	2	2	1	1	0	0	0
35	30	26	23	20	18	16	15	14	13	9	7	6	4	3	2	1	1	0	0	0
40	34	30	26	23	21	19	17	16	15	11	8	6	5	3	2	1	1	1	0	0
45	39	33	29	26	23	21	19	18	16	12	9	7	6	4	2	1	1	1	0	0
50	43	37	33	29	26	23	21	20	18	13	10	8	6	4	3	2	1	1	0	0
60	51	45	39	35	31	28	26	24	22	16	12	10	8	5	3	2	1	1	0	0
70	60	52	46	40	36	33	30	28	26	19	14	11	9	6	4	2	1	1	1	0
80	69	59	52	46	41	38	34	32	29	21	16	13	10	6	4	3	2	1	1	0
90	77	67	59	52	47	42	38	35	33	24	18	14	11	7	5	3	2	1	1	0
100	86	74	65	58	52	47	43	39	36	26	20	16	13	8	5	3	2	1	1	0
150	128	111	98	87	78	70	64	59	55	40	31	24	19	12	8	5	3	2	1	1
200	171	148	130	116	104	94	86	79	73	53	41	32	25	16	10	6	4	3	2	1
250	214	186	163	144	130	117	107	98	91	66	51	40	32	20	13	8	5	3	2	1
300	257	223	195	173	155	141	128	118	109	79	61	48	38	24	15	9	6	4	2	1
350	300	260	228	202	181	164	150	138	128	93	71	56	44	28	18	11	7	4	3	2
400	343	297	261	231	207	188	171	158	146	106	82	64	51	32	20	13	8	5	3	2
450	385	334	293	260	233	211	193	177	164	119	92	72	57	36	23	14	9	6	4	2
500	428	371	326	289	259	235	214	197	182	132	102	80	63	40	25	16	10	6	4	2
550	471	408	358	318	285	258	236	217	201	146	112	88	70	44	28	17	11	7	4	3
600	514	445	391	347	311	281	257	236	219	159	122	96	76	48	30	19	12	8	5	3
650	557	483	423	376	337	305	278	256	237	172	132	104	82	52	33	21	13	8	5	3
700	599	520	456	405	363	328	300	276	255	185	143	112	89	56	35	22	14	9	6	3
750	642	557	488	433	389	352	321	295	273	199	153	120	95	60	38	24	15	9	6	4
800	685	594	521	462	415	375	343	315	292	212	163	128	101	64	40	25	16	10	6	4
850	728	631	554	491	440	399	364	335	310	225	173	136	108	68	43	27	17	11	7	4
900	771	668	586	520	466	422	385	354	328	238	183	144	114	72	45	28	18	11	7	4
950	814	705	619	549	492	446	407	374	346	252	194	152	120	76	48	30	19	12	8	5
1000	856	742	651	578	518	469	428	394	365	265	204	160	127	80	50	32	20	13	8	5
1100	942	817	716	636	570	516	471	433	401	291	224	176	139	88	55	35	22	14	9	5
1200	1028	891	782	693	622	563	514	473	437	318	245	192	152	96	60	38	24	15	9	6
1300	1113	965	847	751	674	610	557	512	474	344	265	208	165	104	65	41	26	16	10	6
1400	1199	1039	912	809	725	657	599	551	510	371	285	224	177	112	70	44	28	18	11	7
1500	1285	1114	977	867	777	704	642	591	547	397	306	240	190	119	75	47	30	19	12	7
1600	1370	1188	1042	925	829	750	685	630	583	424	326	256	203	127	80	51	32	20	13	8
1700	1456	1262	1107	982	881	797	728	670	620	450	346	272	215	135	85	54	34	21	13	8
1800	1541	1336	1172	1040	933	844	771	709	656	477	367	288	228	143	90	57	36	23	14	9
1900	1627	1411	1237	1098	984	891	814	748	693	503	387	304	241	151	95	60	38	24	15	9
2000	1713	1485	1303	1156	1036	938	856	788	729	530	408	320	253	159	100	63	40	25	16	10
2500	2141	1856	1628	1445	1295	1173	1071	985	911	662	509	400	317	199	125	79	50	31	20	12
3000	2569	2227	1954	1734	1554	1407	1285	1182	1094	794	611	480	380	239	151	95	60	38	24	15
3500	2997	2598	2280	2023	1814	1642	1499	1378	1276	927	713	560	443	279	176	111	70	44	28	17
4000	3425	2969	2605	2312	2073	1876	1713	1575	1458	1059	815	640	506	319	201	126	80	50	32	20
4500	3854	3341	2931	2600	2332	2111	1927	1772	1641	1192	917	720	570	358	226	142	90	56	36	22
5000	4282	3712	3256	2889	2591	2345	2141	1969	1823	1324	1019	800	633	398	251	158	100	63	40	25

Rt in Centigray per hour

Table E-53. Fission yield/total yield adjustment factor.

Weapon Yield (KT)	FY/TY RATIO																											
	0.001	0.002	0.004	0.006	0.008	0.01	0.015	0.02	0.025	0.03	0.04	0.05	0.06	0.07	0.08	0.09	0.1	0.15	0.2	0.3	0.4	0.5	0.6	0.7	0.8	0.9	1	
10	0.1	0.1	0.1	0.1	0.1	0.1	0.1	0.11	0.12	0.13	0.15	0.16	0.2	0.22	0.24	0.26	0.28	0.35	0.42	0.53	0.62	0.7	0.77	0.84	0.89	0.95	1	
20	0.1	0.1	0.1	0.1	0.1	0.1	0.11	0.12	0.13	0.15	0.16	0.2	0.22	0.25	0.27	0.29	0.3	0.38	0.45	0.55	0.64	0.72	0.79	0.85	0.9	0.95	1	
30	0.1	0.1	0.1	0.1	0.1	0.1	0.11	0.13	0.14	0.16	0.18	0.21	0.24	0.26	0.28	0.3	0.38	0.4	0.48	0.57	0.65	0.73	0.79	0.85	0.9	0.95	1	
40	0.1	0.1	0.1	0.1	0.1	0.1	0.12	0.14	0.15	0.17	0.2	0.22	0.26	0.27	0.29	0.31	0.39	0.41	0.47	0.56	0.63	0.73	0.8	0.85	0.91	0.95	1	
50	0.1	0.1	0.1	0.1	0.1	0.1	0.12	0.14	0.16	0.17	0.2	0.23	0.26	0.28	0.3	0.38	0.4	0.48	0.49	0.56	0.67	0.74	0.8	0.85	0.91	0.95	1	
60	0.1	0.1	0.1	0.1	0.1	0.1	0.13	0.15	0.16	0.18	0.21	0.24	0.28	0.29	0.31	0.39	0.41	0.48	0.49	0.56	0.67	0.74	0.8	0.85	0.91	0.95	1	
70	0.1	0.1	0.1	0.1	0.1	0.1	0.13	0.15	0.17	0.19	0.22	0.25	0.29	0.31	0.39	0.41	0.48	0.49	0.56	0.67	0.74	0.81	0.86	0.91	0.95	1		
80	0.1	0.1	0.1	0.1	0.1	0.1	0.13	0.15	0.17	0.19	0.22	0.25	0.29	0.31	0.39	0.41	0.48	0.49	0.56	0.67	0.74	0.81	0.86	0.91	0.95	1		
90	0.1	0.1	0.1	0.1	0.1	0.1	0.13	0.15	0.17	0.19	0.22	0.25	0.29	0.31	0.39	0.41	0.48	0.49	0.56	0.67	0.74	0.81	0.86	0.91	0.95	1		
100	0.1	0.1	0.1	0.1	0.1	0.1	0.14	0.16	0.18	0.19	0.23	0.25	0.29	0.31	0.39	0.41	0.48	0.49	0.56	0.67	0.74	0.81	0.86	0.91	0.95	1		
200	0.1	0.1	0.1	0.1	0.1	0.1	0.14	0.16	0.18	0.2	0.23	0.25	0.29	0.31	0.39	0.41	0.48	0.49	0.56	0.67	0.74	0.81	0.86	0.91	0.95	1		
300	0.1	0.1	0.1	0.1	0.1	0.1	0.14	0.16	0.19	0.21	0.23	0.25	0.29	0.31	0.39	0.41	0.48	0.49	0.56	0.67	0.74	0.81	0.86	0.91	0.95	1		
400	0.1	0.1	0.1	0.1	0.1	0.1	0.14	0.17	0.19	0.22	0.23	0.27	0.3	0.32	0.35	0.37	0.39	0.4	0.48	0.54	0.63	0.71	0.77	0.82	0.87	0.92	0.95	1
500	0.1	0.1	0.1	0.1	0.1	0.1	0.15	0.17	0.2	0.22	0.24	0.27	0.3	0.33	0.35	0.37	0.39	0.4	0.48	0.54	0.64	0.71	0.78	0.83	0.88	0.92	0.95	1
600	0.1	0.1	0.1	0.1	0.1	0.1	0.15	0.18	0.2	0.23	0.25	0.28	0.31	0.33	0.36	0.38	0.4	0.48	0.54	0.64	0.71	0.78	0.83	0.88	0.92	0.95	1	
700	0.1	0.1	0.1	0.1	0.1	0.1	0.15	0.18	0.21	0.23	0.25	0.28	0.31	0.34	0.36	0.38	0.4	0.48	0.54	0.64	0.71	0.78	0.83	0.88	0.92	0.95	1	
800	0.1	0.1	0.1	0.1	0.1	0.1	0.16	0.19	0.21	0.24	0.26	0.29	0.32	0.34	0.37	0.39	0.41	0.49	0.55	0.65	0.72	0.79	0.84	0.89	0.93	0.96	1	
900	0.1	0.1	0.1	0.1	0.1	0.1	0.16	0.19	0.21	0.24	0.26	0.29	0.32	0.35	0.37	0.39	0.41	0.49	0.55	0.65	0.72	0.79	0.84	0.89	0.93	0.96	1	
1000	0.1	0.1	0.1	0.1	0.1	0.1	0.16	0.19	0.22	0.24	0.26	0.29	0.32	0.35	0.37	0.39	0.41	0.49	0.55	0.65	0.72	0.79	0.84	0.89	0.93	0.96	1	
2000	0.1	0.1	0.1	0.1	0.1	0.1	0.18	0.21	0.24	0.26	0.29	0.31	0.34	0.37	0.39	0.41	0.49	0.55	0.65	0.73	0.79	0.84	0.89	0.93	0.96	1		
3000	0.1	0.1	0.1	0.1	0.1	0.1	0.18	0.22	0.25	0.27	0.3	0.32	0.35	0.37	0.39	0.41	0.49	0.55	0.65	0.73	0.79	0.84	0.89	0.93	0.96	1		
4000	0.1	0.1	0.1	0.1	0.1	0.1	0.19	0.22	0.25	0.27	0.3	0.32	0.35	0.38	0.4	0.42	0.44	0.48	0.58	0.67	0.74	0.8	0.85	0.89	0.93	0.97	1	
5000	0.1	0.1	0.1	0.1	0.1	0.1	0.2	0.23	0.26	0.28	0.3	0.33	0.36	0.39	0.41	0.43	0.45	0.48	0.58	0.68	0.75	0.8	0.85	0.89	0.93	0.97	1	
6000	0.1	0.1	0.1	0.1	0.1	0.1	0.2	0.23	0.26	0.29	0.31	0.34	0.37	0.39	0.41	0.43	0.45	0.48	0.58	0.68	0.75	0.81	0.85	0.89	0.93	0.97	1	
7000	0.1	0.1	0.1	0.1	0.1	0.1	0.2	0.24	0.27	0.29	0.31	0.34	0.37	0.4	0.42	0.44	0.48	0.58	0.68	0.75	0.81	0.85	0.89	0.93	0.97	1		
8000	0.1	0.1	0.1	0.1	0.1	0.1	0.21	0.24	0.27	0.29	0.31	0.34	0.37	0.4	0.42	0.44	0.48	0.58	0.68	0.75	0.81	0.85	0.89	0.93	0.97	1		
9000	0.1	0.1	0.1	0.1	0.1	0.1	0.21	0.24	0.27	0.29	0.31	0.34	0.37	0.4	0.42	0.44	0.48	0.58	0.68	0.75	0.81	0.85	0.89	0.93	0.97	1		
10000	0.1	0.1	0.1	0.1	0.1	0.1	0.21	0.24	0.27	0.3	0.32	0.35	0.38	0.41	0.43	0.45	0.47	0.49	0.59	0.68	0.75	0.81	0.85	0.89	0.93	0.97	1	
15000	0.1	0.1	0.1	0.1	0.1	0.1	0.25	0.27	0.3	0.32	0.35	0.38	0.41	0.43	0.45	0.47	0.49	0.59	0.68	0.75	0.81	0.85	0.89	0.93	0.97	1		
20000	0.1	0.1	0.1	0.1	0.1	0.1	0.26	0.29	0.31	0.33	0.36	0.39	0.42	0.44	0.46	0.48	0.5	0.57	0.62	0.7	0.76	0.82	0.85	0.89	0.93	0.97	1	
25000	0.1	0.1	0.1	0.1	0.1	0.1	0.26	0.29	0.31	0.33	0.36	0.39	0.42	0.44	0.46	0.48	0.5	0.57	0.62	0.7	0.77	0.82	0.85	0.89	0.93	0.97	1	
30000	0.1	0.1	0.1	0.1	0.1	0.1	0.27	0.3	0.32	0.34	0.37	0.4	0.43	0.45	0.47	0.49	0.51	0.57	0.63	0.71	0.77	0.82	0.85	0.89	0.93	0.97	1	
40000	0.1	0.1	0.1	0.1	0.1	0.1	0.28	0.31	0.33	0.35	0.38	0.41	0.44	0.46	0.48	0.5	0.57	0.63	0.71	0.78	0.83	0.87	0.91	0.94	0.97	1		
60000	0.1	0.1	0.1	0.1	0.1	0.1	0.29	0.32	0.34	0.36	0.39	0.42	0.45	0.47	0.49	0.51	0.57	0.64	0.72	0.78	0.83	0.87	0.91	0.94	0.97	1		
80000	0.1	0.1	0.1	0.1	0.1	0.1	0.29	0.32	0.35	0.37	0.4	0.43	0.46	0.48	0.5	0.57	0.61	0.68	0.76	0.82	0.87	0.91	0.94	0.97	1			
100000	0.1	0.1	0.1	0.1	0.1	0.1	0.3	0.33	0.35	0.37	0.41	0.43	0.46	0.48	0.5	0.57	0.61	0.68	0.76	0.82	0.87	0.91	0.94	0.97	1			

Table E-54. Height of burst fallout correction factor.

Weapon Yield (KT)	HEIGHT OF BURST (FEET)																											
	10	20	30	40	50	60	70	80	90	100	200	300	400	500	600	700	800	900	1000	2000	3000	4000	5000	6000	7000	8000	10000	
0.5	0.99	0.78	0.69	0.67	0.47	0.39	0.3	0.22	0.16	0.1	0	0	0	0	0	0	0	0	0	0	0	0	0	0	0	0	0	0
1	0.92	0.83	0.75	0.67	0.59	0.52	0.46	0.39	0.31	0.25	0	0	0	0	0	0	0	0	0	0	0	0	0	0	0	0	0	0
2	0.94	0.87	0.81	0.75	0.69	0.63	0.57	0.51	0.46	0.41	0.04	0	0	0	0	0	0	0	0	0	0	0	0	0	0	0	0	0
4	0.96	0.9	0.86	0.81	0.76	0.72	0.67	0.63	0.59	0.54	0.17	0	0	0	0	0	0	0	0	0	0	0	0	0	0	0	0	0
6	0.96	0.92	0.89	0.84	0.8	0.76	0.72	0.69	0.64	0.6	0.27	0.06	0	0	0	0	0	0	0	0	0	0	0	0	0	0	0	0
8	0.96	0.93	0.89	0.86	0.82	0.79	0.75	0.71	0.68	0.64	0.33	0.1	0	0	0	0	0	0	0	0	0	0	0	0	0	0	0	0
10	0.97	0.93	0.9	0.87	0.83	0.8	0.77	0.74	0.71	0.67	0.39	0.15	0.02	0	0	0	0	0	0	0	0	0	0	0	0	0	0	0
20	0.97	0.95	0.92	0.9	0.87	0.85	0.82	0.8	0.78	0.75	0.52	0.31	0.14	0.04	0	0	0	0	0	0	0	0	0	0	0	0	0	0
30	0.98	0.96	0.94	0.91	0.89	0.87	0.85	0.83	0.81	0.79	0.69	0.4	0.24	0.11	0.03	0	0	0	0	0	0	0	0	0	0	0	0	0
40	0.98	0.96	0.94	0.92	0.9	0.89	0.87	0.85	0.83	0.81	0.63	0.46	0.3	0.19	0.09	0.02	0	0	0	0	0	0	0	0	0	0	0	0
50	0.98	0.96	0.95	0.93	0.91	0.9	0.89	0.88	0.84	0.83	0.69	0.5	0.35	0.23	0.12	0.05	0.01	0	0	0	0	0	0	0	0	0	0	0
60	0.98	0.97	0.95	0.93	0.92	0.9	0.89	0.87	0.85	0.84	0.69	0.53	0.39	0.27	0.16	0.09	0.03	0	0	0	0	0	0	0	0	0	0	0
70	0.98	0.97	0.95	0.94	0.92	0.91	0.9	0.89	0.88	0.85	0.7	0.69	0.42	0.3	0.2	0.11	0.05	0.01	0	0	0	0	0	0	0	0	0	0
80	0.98	0.97	0.96	0.94	0.93	0.91	0.9	0.89	0.87	0.86	0.71	0.69	0.45	0.33	0.23	0.14	0.07	0.03	0	0	0	0	0	0	0	0	0	0
90	0.99	0.97	0.96	0.94	0.93	0.92	0.9	0.89	0.87	0.86	0.73	0.6	0.47	0.36	0.26	0.17	0.1	0.04	0.01	0	0	0	0	0	0	0	0	0
100	0.99	0.97	0.96	0.95	0.93	0.92	0.91	0.9	0.89	0.88	0.74	0.61	0.49	0.38	0.28	0.19	0.12	0.06	0.02	0	0	0	0	0	0	0	0	0
200	0.99	0.98	0.97	0.96	0.95	0.94	0.93	0.92	0.91	0.9	0.8	0.7	0.61	0.52	0.43	0.35	0.28	0.21	0.16	0	0	0	0	0	0	0	0	0
300	0.99	0.98	0.97	0.97	0.96	0.95	0.94	0.93	0.92	0.91	0.83	0.75	0.67	0.59	0.51	0.44	0.37	0.3	0.24	0	0	0	0	0	0	0	0	0
400	0.99	0.98	0.98	0.97	0.96	0.95	0.95	0.94	0.93	0.92	0.85	0.77	0.7	0.63	0.56	0.49	0.43	0.36	0.31	0	0	0	0	0	0	0	0	0
500	0.99	0.98	0.98	0.97	0.96	0.96	0.95	0.94	0.94	0.93	0.86	0.79	0.73	0.66	0.69	0.63	0.47	0.41	0.36	0.01	0	0	0	0	0	0	0	0
600	0.99	0.98	0.98	0.97	0.97	0.96	0.95	0.95	0.94	0.94	0.87	0.81	0.74	0.68	0.62	0.56	0.5	0.45	0.39	0.03	0	0	0	0	0	0	0	0
700	0.99	0.98	0.98	0.98	0.97	0.96	0.96	0.95	0.95	0.94	0.88	0.82	0.76	0.7	0.64	0.59	0.53	0.48	0.43	0.05	0	0	0	0	0	0	0	0
800	0.99	0.98	0.98	0.98	0.97	0.96	0.96	0.95	0.95	0.94	0.89	0.83	0.77	0.72	0.66	0.61	0.55	0.5	0.45	0.08	0	0	0	0	0	0	0	0
900	0.99	0.98	0.98	0.98	0.97	0.96	0.96	0.95	0.95	0.94	0.89	0.84	0.78	0.73	0.69	0.62	0.57	0.52	0.48	0.1	0	0	0	0	0	0	0	0
1000	0.99	0.98	0.98	0.98	0.97	0.96	0.96	0.95	0.95	0.94	0.89	0.84	0.79	0.74	0.69	0.64	0.59	0.54	0.5	0.12	0	0	0	0	0	0	0	0
2000	1	0.99	0.99	0.98	0.98	0.98	0.97	0.97	0.97	0.96	0.92	0.88	0.84	0.8	0.76	0.72	0.69	0.65	0.61	0.28	0.05	0	0	0	0	0	0	0
4000	1	0.99	0.99	0.99	0.98	0.98	0.98	0.98	0.97	0.97	0.94	0.91	0.89	0.86	0.82	0.79	0.76	0.73	0.7	0.43	0.2	0.05	0	0	0	0	0	0
6000	1	0.99	0.99	0.99	0.99	0.99	0.98	0.98	0.98	0.97	0.95	0.92	0.91	0.87	0.85	0.82	0.8	0.77	0.75	0.51	0.3	0.13	0.03	0	0	0	0	0
8000	1	1	0.99	0.99	0.99	0.99	0.98	0.98	0.98	0.98	0.95	0.92	0.91	0.89	0.86	0.84	0.82	0.8	0.77	0.56	0.36	0.2	0.08	0.01	0	0	0	0
10000	1	1	0.99	0.99	0.99	0.99	0.98	0.98	0.98	0.98	0.95	0.94	0.92	0.9	0.87	0.85	0.83	0.81	0.79	0.59	0.41	0.25	0.12	0.04	0	0	0	0
20000	1	1	0.99	0.99	0.99	0.99	0.99	0.99	0.99	0.99	0.97	0.95	0.94	0.92	0.9	0.89	0.87	0.86	0.84	0.69	0.54	0.4	0.28	0.18	0.09	0.03	0	0
40000	1	1	1	0.99	0.99	0.99	0.99	0.99	0.99	0.99	0.98	0.96	0.95	0.94	0.93	0.92	0.9	0.89	0.88	0.76	0.65	0.54	0.43	0.33	0.25	0.17	0.06	0
60000	1	1	1	1	0.99	0.99	0.99	0.99	0.99	0.99	0.98	0.97	0.96	0.95	0.94	0.93	0.92	0.91	0.9	0.8	0.7	0.6	0.51	0.42	0.34	0.26	0.14	0
80000	1	1	1	1	1	0.99	0.99	0.99	0.99	0.99	0.98	0.97	0.96	0.95	0.94	0.93	0.92	0.91	0.9	0.82	0.73	0.64	0.56	0.48	0.4	0.33	0.2	0
100000	1	1	1	1	1	1	0.99	0.99	0.99	0.99	0.98	0.97	0.96	0.95	0.94	0.93	0.92	0.91	0.9	0.83	0.75	0.67	0.59	0.52	0.45	0.38	0.25	0



**TOTAL DOSE RECEIVED IN AN INDUCED AREA**

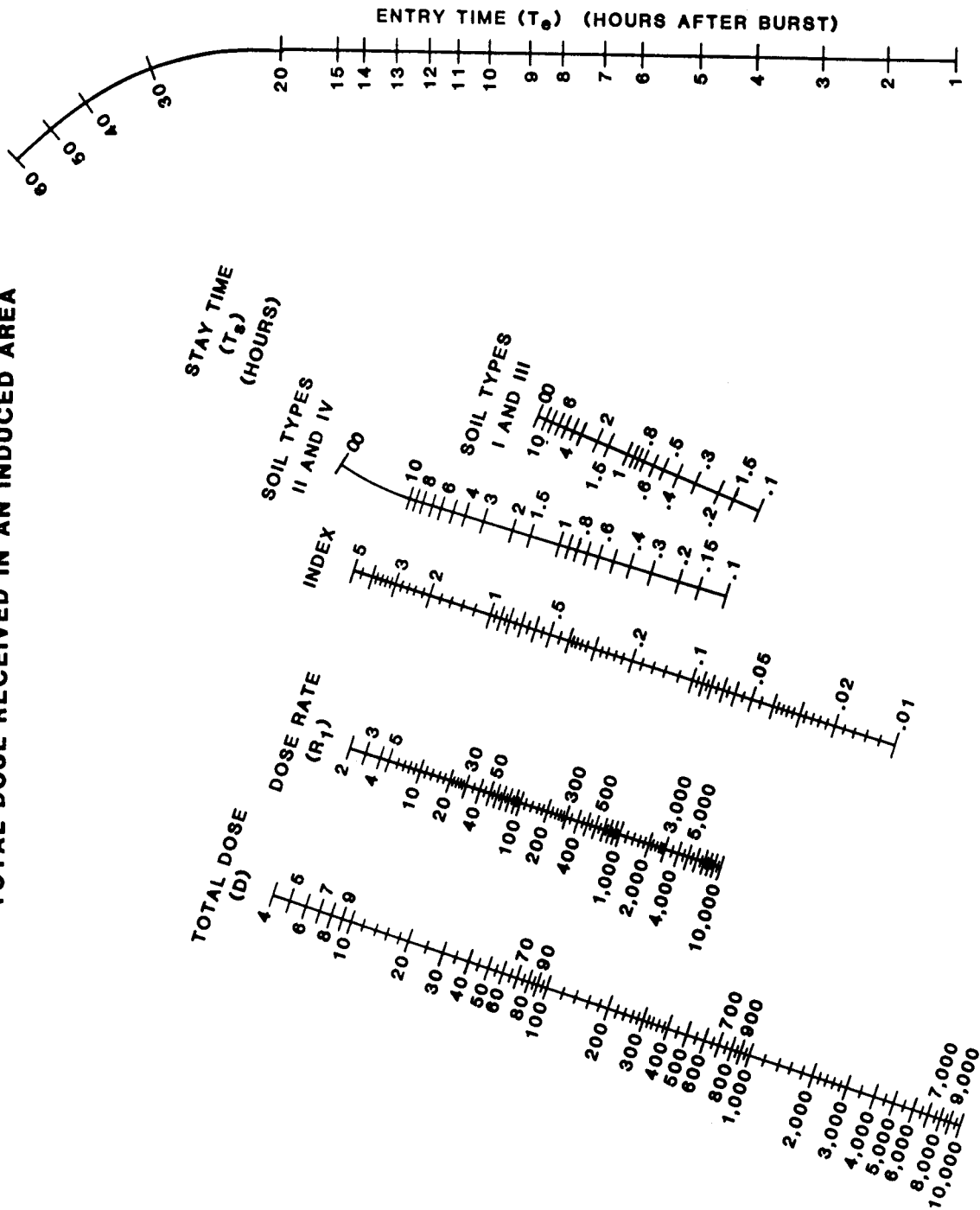

Figure E-50. Total dose nomogram.

## Appendix F

# Additional Calculations

This appendix gives more detailed procedures for working radiological fallout and decay problems discussed in Chapter 6.

## Determining Decay Rate

### Pocket Calculator Method

Assume that you are required to find the logarithm of 12.85. Reading down Column A in Table 6-4, you find that a value exists for 12.8 and 12.9, but not 12.85. How do you find the log of 12.85?

Set the problem up like this: 12.85 log = 1.109 enter 12.85 hit log = 1.109.

### Graphical Method

When a sequence of dose rates (NBC 4 nuclear series reports) from one location is plotted on log-log graph paper, the decay rate of the contamination causes the line plotted to be a straight line, inclined at a slope (n) to the axes of the graph.

Suppose you have readings from a set of NBC 4 nuclear series reports (Table F-1) are received for decay-rate determination. H-hour is known or determined to be 0930.

Figure F-1 (next page) shows this data plotted on log-log graph paper. The time is used as the number of hours past H-hour. Three lines are drawn through the points. The slope of these three parallel lines is n, the decay exponent.

Remember, this is an example to demonstrate a procedure. In actual practice, the points will not likely fall

exactly in straight lines. In actual practice, the best straight line is fitted to the points. The value of n may then be determined for each location and an average n determined as follows:

Place a piece of acetate, overlay paper, or other transparent material over Figure F-2 (page F-2) and trace it. Next, orient the transparent material over the log-log paper. Position the arrow on the transparent device at the point where the slope intersects the x-axis. Holding this position, align the y-axis indicator so that it is parallel with the y-axis of the log-log paper.

Note which slope on the transparency most closely matches the slope on the log-log paper. The slope which most closely matches has an n value printed along the left side of the transparency. This is the decay rate for these plotted dose rates.

Decay rate may be calculated from the plotted slope by measuring each axis in centimeters and using the formula

$$n = \frac{\text{Delta } Y}{\text{Delta } X}. \text{ (Greek letter Delta = percent of change.)}$$

Once the decay rate (n) is determined, the radiological reading may be normalized to H + 1 readings. This reading is commonly referred to as the R<sub>1</sub> reading. This is nothing more than determining, mathematically what the dose rate reading was at any given location, one hour after the burst. Survey teams and monitors enter an area and take readings at various times after the burst (H-hour). These readings may be 15 minutes or 10 hours after the burst.

Any reading that is not recorded 1 hour (H + 1) after a burst is commonly referred to as an R<sub>t</sub> reading. To perform radiological calculations and make decisions on the nuclear battlefield, all readings must be represented using the same time reference. If this is not done, the radioactive elements will decay and a true representation of the hazard, past and present, cannot be made.

**Table F-1. Example dose-rate readings.**

Location	Time of Reading				
	1000	1030	1100	1130	1200
Dose Rate (cGyph)					
A	40	21	14	11	9
B		12	8	6	5
C			79	60	50

## Determining Dose Rates

**Situation 1:** A monitor reports a dose rate of 100 cGyph 5 hours after the burst. The decay rate is unknown so the monitor assumes standard decay ( $n = 1.2$ ). What was the dose rate at the monitor's location at  $H + ?$

This can be determined mathematically, using a hand-held pocket calculator that as a power function, which is represented by a button labeled either "Y<sup>X</sup>" or "X<sup>Y</sup>".

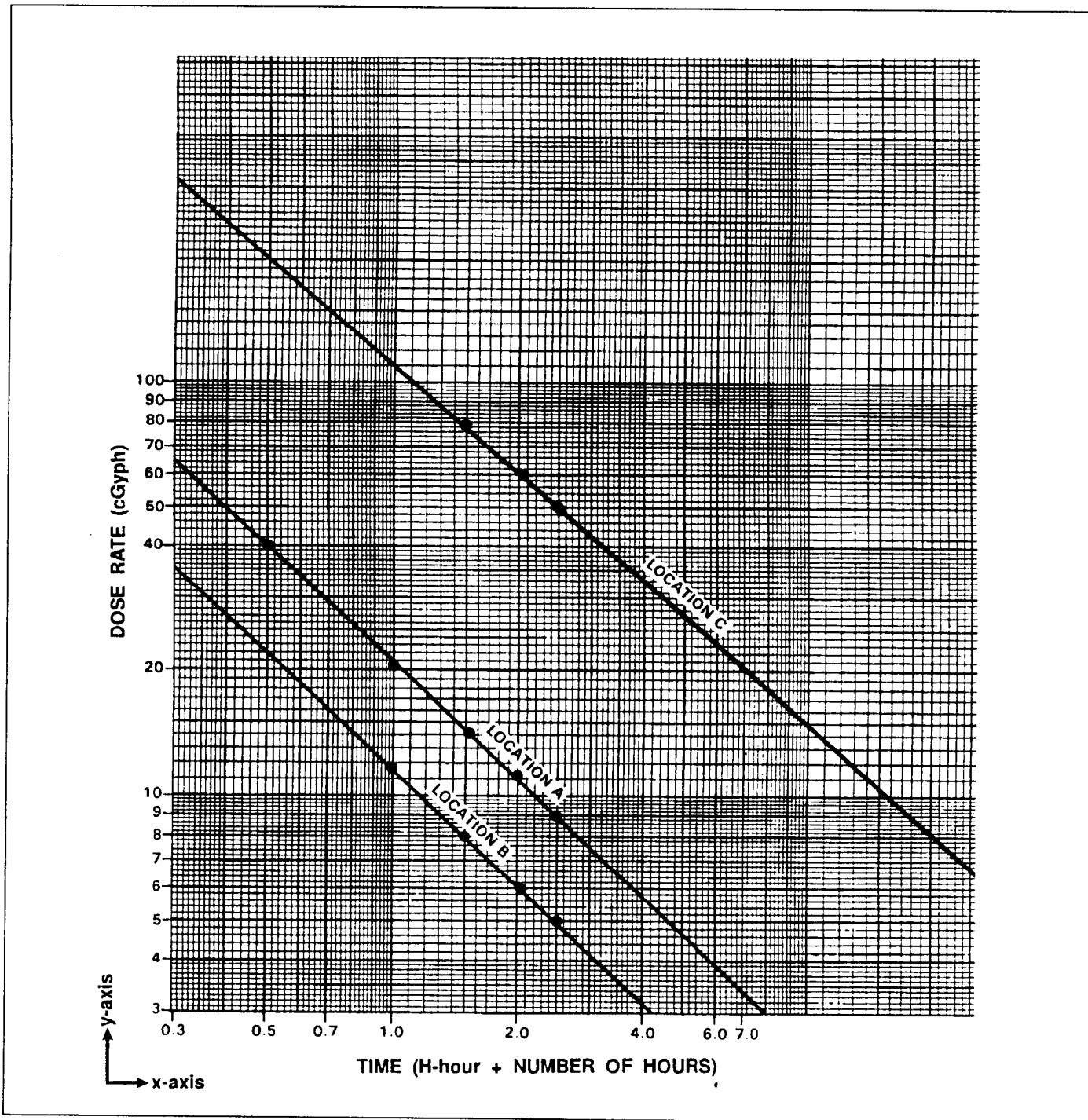

Figure F-1. Example of decay rate determination by slope measurement.

The following formula is used to solve the problem mathematically:

$$R_1 = R_t \div t (Y^n) n \ +/-.$$

( $R_1$  may be calculated by  $R_1 = R_t \times t y^{1/n}$ .)

**Step 1.** Turn on calculator; and punch in the  $R_t$  reading of 100 cGyph; press the  $\div$  key.

**Step 2.** Push 5 (for H + 5 when the reading was taken). Push  $Y^n$  or  $X^n$  function key, then the  $n$  value of 1.2.

**Step 3.** Press the  $\pm$  key, and then the equals (=) key. The answer should be 689.86, or 690 cGyph.

This method is the most accurate. The answer may be slightly different from that found using the nomogram

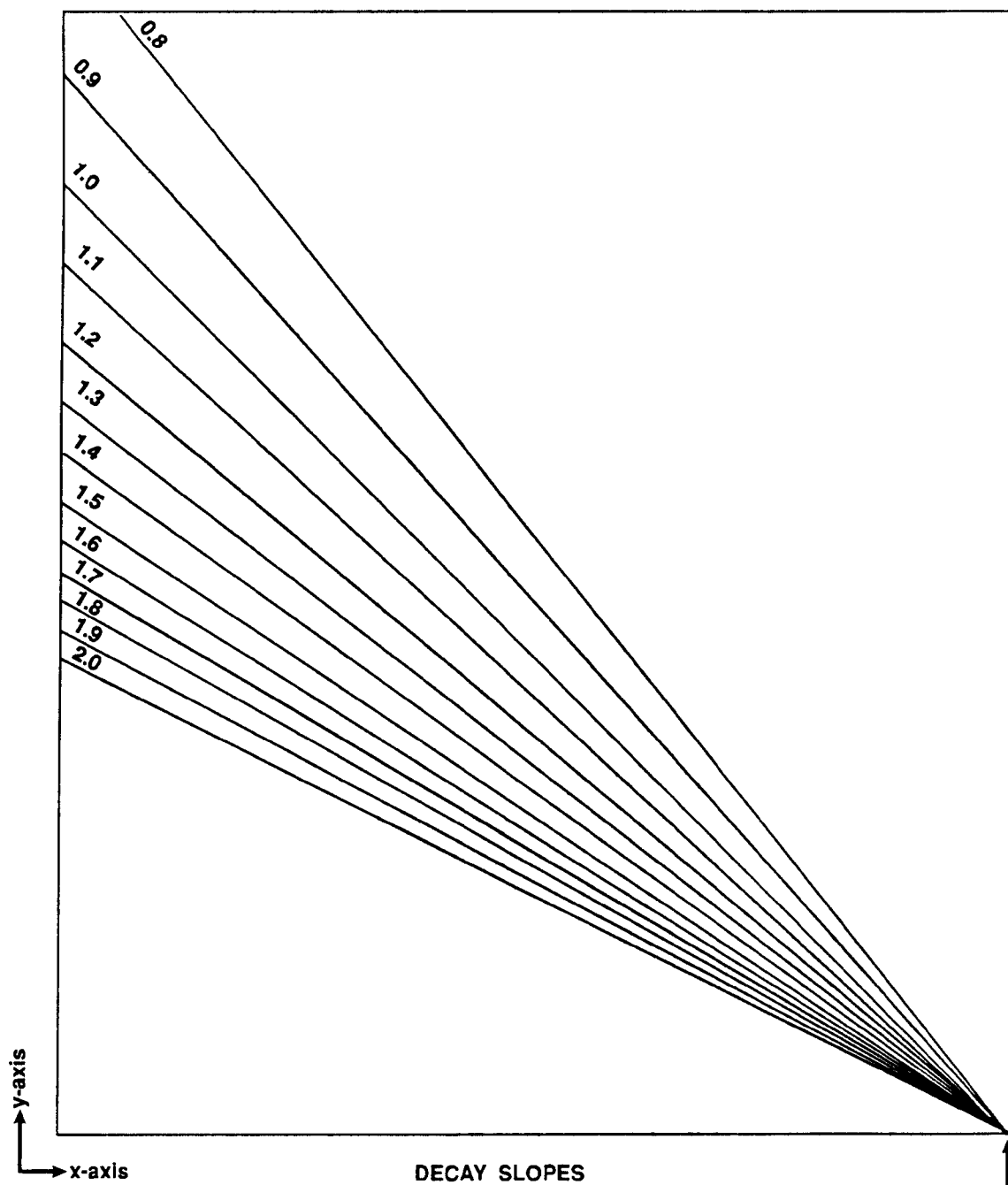

Figure F-2. Decay slopes.

method discussed in Chapter 6. That is because nomograms are subject to operator error and interpretation.

**Situation 2.** Further monitoring determines the decay rate to be 0.9. The monitor's reading, using the procedure of Situation 1, is normalized to a new  $R_1$  ( $H + 1$ ) of 426 cGyph. The commander wants to know what the reading will be at the monitor's location at  $H + 8$  hours.

The formula used in Situation 1 also can be written or used as  $R_2 = R_1 \times t (Y^n) n (+/-)$ .

**Step 1.** Turn on calculator, and punch in the  $R_1$  reading of 426 cGyph; press the multiplication key (x).

**Step 2.** Push 8 (for  $H + 8$ ). Press the  $Y^x$  or  $X^y$  key, and enter the  $n$  value of 0.9.

**Step 3.** Press the +/- key and then equals (=). The answer should be 66 cGyph.

## Normalizing Factors

To compute normalizing factors without using the table of values method discussed in Chapter 6, use either the mathematical or graphical method.

### Mathematical Method

The normalizing factor is the ratio of the ground dose rate at a reference time to the ground dose rate at any other known time. It can be expressed as—

$$NF = \frac{\text{ground dose rate at ref time } (R_1)}{\text{ground dose rate at any other time } (R_2)}$$

The normalizing factor is computed using the Kaufman equation,  $R_1 T_1^n = R_2 T_2^n$ . This is the mathematical method. Subscript 1 denotes the reference time, and subscript 2 denotes any other known time a dose rate is determined.

Since:

a.  $NF = (T_2)^n$ , when the reference time is  $H + 1$ .

b.  $NF = \frac{(T_2)^n}{(T_1)^n}$  when the reference time is  $H + 48$ .

### Graphical Method

The graphical method is used when it is necessary to determine a large number of normalizing factors or to extend the time scope of an existing table. You have to know both  $n$  and  $H$ -hour.

Figure F-3 (page F-4) shows NF plots for  $H + 1$  and  $H + 48$  hours. To use these plots, enter the bottom of the plot with time the dose rate was measured. Read up to the appropriate decay slope. At this intersection, read left to the left-hand scale for the NF.

## Multiple Burst Procedures

### Calculating Fallout of One Burst

Fallout has been received from two detonations, one at 0800Z and one at 1100Z, resulting in the readings shown in Figure F-4.

Predict the dose rates for the 0800Z burst at this location 24 hours after the burst. Sufficient data is available to separate the two bursts.

Time	Dose Rate (cGyph)
0900	100 Peak
0930	61
1000	44
1030	33
1100	27
1130	451 Peak
1200	219
1300	108

Figure F-4. Sample dose-rate

### Calculator Method

Use this method if your calculator has a logarithm function, or log button and a power key, or  $X^y$ , or  $Y^x$  button.

**Step 1.** Calculate the decay exponent for the first burst. Divide 100 by 27 and

push the log button on your calculator. Store this information in memory. Divide 3 by 1; push the log button. Divide the log of  $100 \div 27$  (stored in memory) by the log of  $3 \div 1$ . The answer is 1.1918.

**Step 2.** Determine the decay rate for the second burst.

First determine the contribution of the first burst dose rate to the 1200 hour reading of 219 cGyph. This is determined with the formula  $R_1 \div t^n = R_2$ ;

$R_1 = H + 1$  reading for the first burst

$t =$  time in hours from the  $H = 1$  value of the first burst to  $H + 1$  for the second burst

$n =$  decay rate for the first burst calculated in Step 1

$Y^x =$  power button on calculator

$100 \div 4Y^x 1.2 = 1.9$  cGyph.

To determine the reference or peak reading of the second burst—

$219 \text{ cGyph} - 19 \text{ cGyph} = 200 \text{ cGyph}$  at 1200 from the second burst

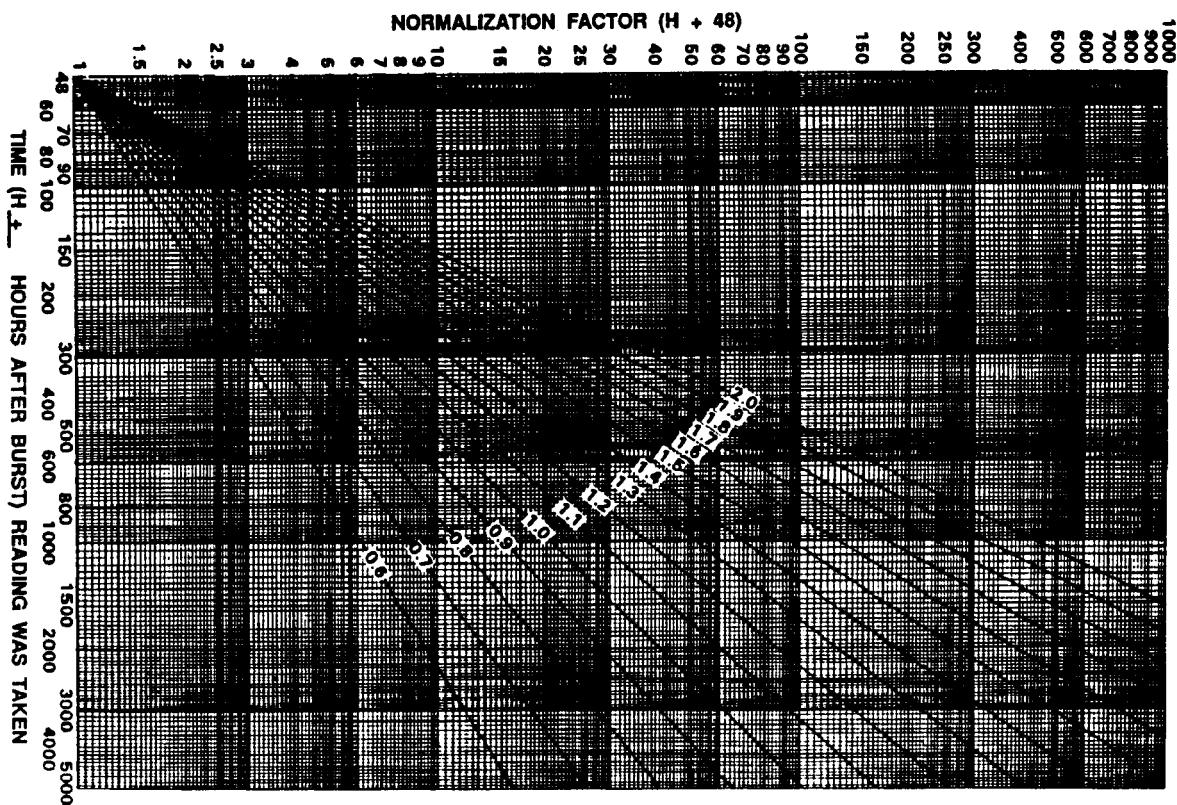
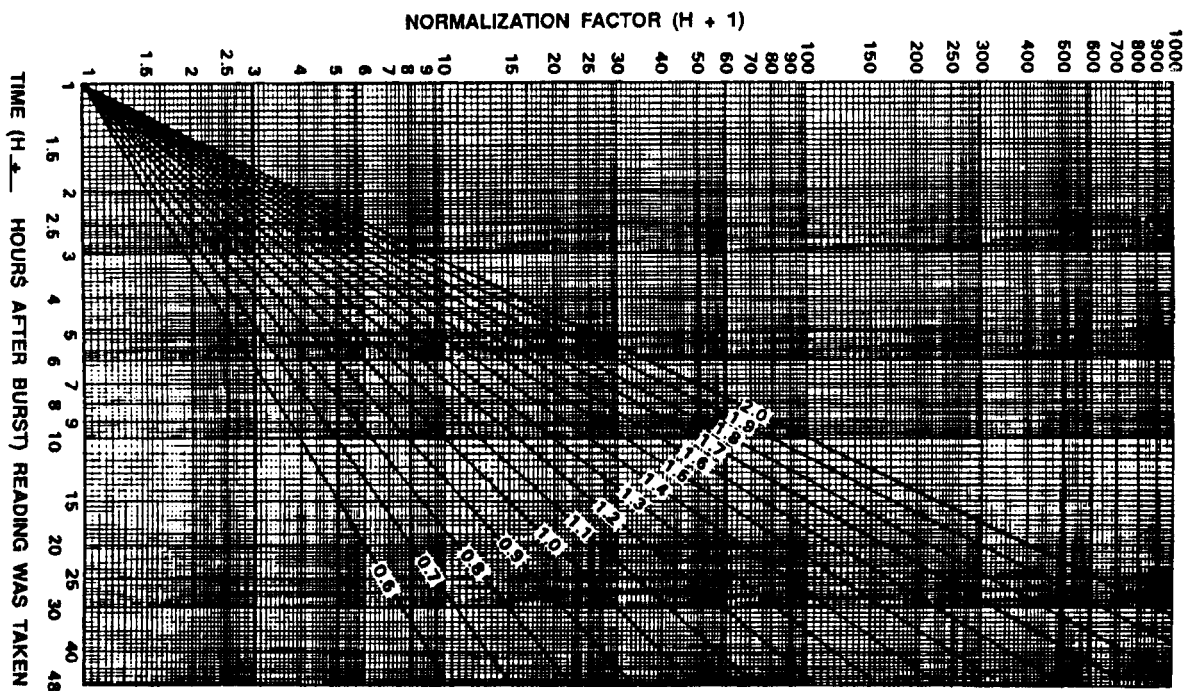

Figure F-3. Graphical method for determining normalization factor.

$$\frac{\log\left(\frac{R_a}{R_b}\right)}{\log\left(\frac{T_b}{T_a}\right)}$$

$R_a$  = H + 1 reading of second burst  
 $R_b$  = Last reading minus contribution from first burst  
 $T_b$  = Time, in hours, of last reading from detonation time of second burst

$T_a$  = Time, in hours, of reference reading for second burst

$$\frac{\log\frac{200}{108 - R_t}}{\log\frac{2}{1}}$$

$$R_t \text{ value for the first burst: } R_t = (R_1 \div ty^n) = (100 \div 5y^{1.2}) = R_t = 14.5 \text{ cGyph.}$$

The  $R_t$  value in this case is 100 cGyph. Use the value of 5 hours for  $t$ , because the reading of 108 cGyph occurred at 1300, which is 5 hours after the first burst. Push the  $y^x$  power key on the calculator, then the decay rate of 1.2 for the first burst. The answer, in this case, is 14.5 cGyph contribution from the first burst.

$$\frac{\log\left(\frac{200}{108 - 14.5}\right)}{\log\left(\frac{2}{1}\right)} = \frac{\log(2.1390)}{\log(2)}$$

Using the log button on the calculator, find the log of the top and bottom numbers, then divide 0.3302 by 0.3010; and your answer is 1.097, or 1.1.

The decay rate, therefore, after rounding to the nearest tenth, for the second burst is 1.1.

**Step 3.** Calculate the 0800Z dose rate 24 hours after the first burst. Remember, the  $T_b$  for 1.1 is only 5 hrs. You have to use 1.2 or get another series report.

$$R_{24_x} = R_1 \div 24Y^{1.2}$$

$R_{24_x}$  = rate 24 hours after first burst

$R_1$  =  $R_1$  reading for first burst

$Y^x$  = power key

$$R_{24_x} = 100 \div 24y^{1.2}$$

$$R_{24_x} = 2.2067 \text{ cGyph}$$

$$R_{21_y} = R_1 \div y^x, 1.1$$

$R_{21_y}$  = rate of second burst at 0800Z

$R_1$  =  $R_1$  or reference reading for the second burst

21 = 0800Z is 21 hours after the detonation time of the second burst

$Y^x$  = power key on calculator

1.1 = decay rate for second burst

$$R_{21_y} = 7.02 \text{ cGyph}$$

$$R_{21_y} = 7.02 \text{ cGyph.}$$

Add the reading for 24 hours after the first burst to the reading 21 hours after the second burst:

$$2.2067 + 7.02 = 0.23, \text{ or } 9 \text{ cGyph.}$$

By using these procedures you can determine any dose rate, at any particular time with your calculator.

$$R_t = Rt(t) y^n$$

$$R_t = R_1 \div ty^n$$

$$t = Rt \div R_1 = \text{INV } y^n t / -.$$

To solve for  $t$  is a little more complicated than the other procedures.

Given:

$$R_t = 7$$

$$R_1 = 200$$

$$n = 1.1$$

Find:  $t$ .

Divide 7 by 200. Push equals. Push the INV button, then 1.1, then the +/- button; then the equals button. In other words,  $t = R_t \div R_1 = \text{INV } Y^n + 1 -$ .

### Graphical Method

Use the graphical method when sufficient data is not available to separate the multiple burst readings.

Fallout has been received from two detonations. Dose-rate measurements were made at the intervals shown in Figure F-5. The time of the second burst is 0800. Time of the first burst is not known.

After receiving the measurement made at 1100, predict the dose rate at that location at 2000 on the following day (36 hours after the burst). After receiving each succeeding dose-rate measurement, update this prediction. Sufficient data are not available to separate the two bursts.

**Step 1.** Plot on log-graph paper the 0900 and 1100 dose-rate measurements against the time after the second burst.

**Step 2.** Draw a straight line through these points and extrapolate the line past H + 36 hours (see Figure F-6, next page).

**Step 3.** As a first approximation, determine a dose rate of 28.0 cGyph for 2000 on the day following the burst ( $R_{20}$ ) directly from the graph.

**Step 4.** Upon receiving the 1300 measurement, plot this reading on the graph.

**Step 5.** Draw a new straight line through the 1100 and 1300 points; and extrapolate the line past H + 36 hours.

**Step 6.** As a second (and better) approximation, determine a dose rate of 20.5 cGyph for H + 36 hours directly from the second extrapolation.

**Step 7.** Repeat the procedure described in steps 4 through 6. Upon receipt of the

Time	Dose Rate (cGyph)
0900	360
1100	165
1300	108
1500	80
0200	30
1200	17.5

Figure F-5. Sample dose-rate readings.

1500, 0200, and 1200 measurements, update the prediction for  $R_{36}$  to 18.0, 14.5, and 12.5 cGyph, respectively.

**Step 8.** See Figure F-6 for an illustration of the dose-rate calculation. Reading from this figure, the true dose rate encountered at  $H + 36$  hours at that location is 12.5 cGyph.

### Calculating Overlapping Fallout

H-hour is known for each burst. At 251500, a 20-KT nuclear weapon was detonated on the surface "near" your position. Sometime later, fallout arrived on your position. At 1630, a peak dose rate of 126 cGyph was measured. Subsequent readings indicated that  $n = 1.4$ . At 251700, another weapon was detonated close to your area, and fallout arrived soon after. At 251730, a second peak dose rate of 300 cGyph was measured.

Assuming that  $n = 1.2$  for the second weapon, what will the dose rate be at 1900? This may be calculated using Step 3 of the calculator method for determining an  $R_1$  value.

When H-hour for each detonation is known, calculate the dose or dose rate for each event and add them together to get the total dose or dose rate received.

**Step 1.** Find  $R_1$  for the first detonation.

$$R_1 = [R_t(t) \cdot Y^n]$$

$$R_1 = [126 (1.5) Y^{1.4}]$$

$$R_1 = 222.3 \text{ cGyph.}$$

**Step 2.** Find  $R_1$  at 1730 for first fallout only.

$$R_1 = R_1 \cdot Y^{-t} \cdot Y^n$$

$$R_1 = 222.3 \div 2.5 Y^{1.4}$$

$$R_1 = 61.6, \text{ or } 62 \text{ cGyph.}$$

**Step 3.** Find the dose rate contribution at 1730 from the second burst.

$$R_{1a} = R_1 - R_{1i}$$

$$R_{1a} = 300 \text{ cGyph} - 62 \text{ cGyph}$$

$$R_{1a} = 238 \text{ cGyph.}$$

**Step 4.** Find  $R_{1a}$  for the second burst only.

$$R_1 = R_1(t) \cdot Y^{-t} \cdot Y^n$$

$$R_1 = 238 (0.5) \cdot Y^{1.2}$$

$$R_1 = 103.5, \text{ or } 104 \text{ cGyph.}$$

**Step 5.** Find  $R_1$  at 1900 for each burst. For the first burst—

$$R_1 = 222 \text{ cGyph}$$

$$t = H + 4 \text{ hours}$$

$$R_1 = (R_1 \cdot Y^{-t} \cdot Y^n)$$

$$R_1 = 222 \cdot Y^{-4} \cdot Y^{1.4}$$

$$R_1 = 31.8, \text{ or } 32 \text{ cGyph.}$$

For the second burst—

$$R_1 = 104 \text{ cGyph}$$

$$t = H + 2$$

$$R_1 = R_1 \cdot Y^{-t} \cdot Y^n$$

$$R_1 = 104 \cdot Y^{-2} \cdot Y^{1.2}$$

$$R_1 = 45.3, \text{ or } 45 \text{ cGyph.}$$

**Step 6.** Find the total dose rate at 1900. Total dose rate is the sum of dose rates at that time.

$$R \text{ total} = R_1 + R_{12}$$

$$R \text{ total} = 32 + 45$$

$$R \text{ total} = 77 \text{ cGyph.}$$

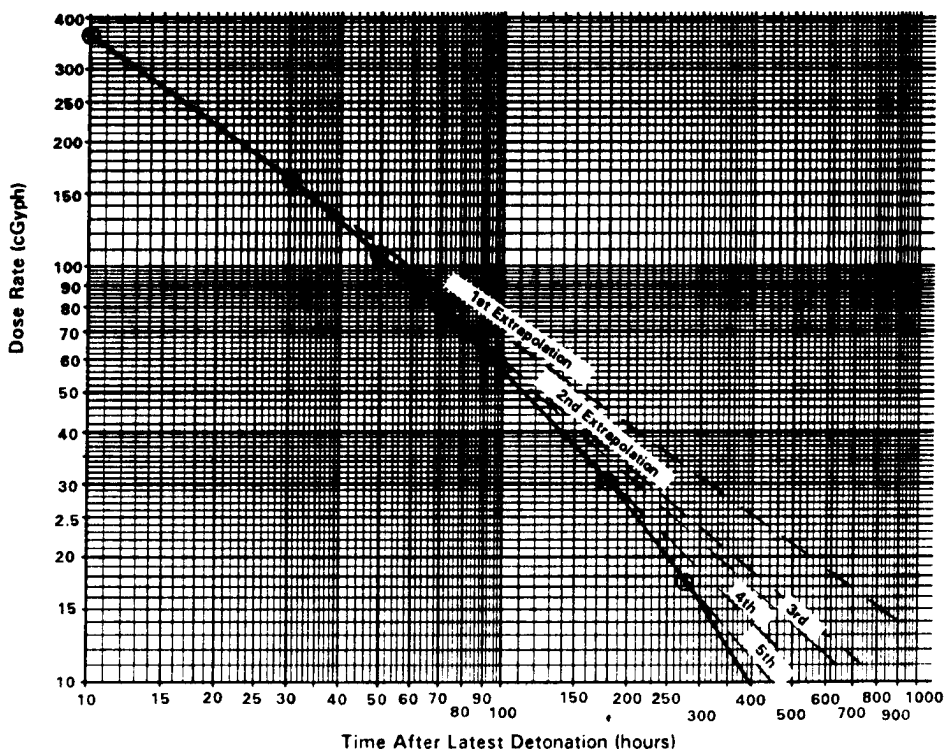

Figure F-6. Sample extrapolations with periodic revisions.



# Glossary

## A

**ABCA allies**— American, British, Canadian, and Australian allies

**active defense measures**— steps taken to find and destroy either the munitions or the delivery systems of an NBC attack.

**ADA**— air defense artillery

**air-ground correlation factor (AGCF)**— the ratio of a dose-rate reading taken at survey height to a ground dose rate taken one meter above the surface.

**APC**— armored personnel carrier

**ARR**— aerial radiological recon

**AWS**— Air Weather Service

## C

**CF**— correlation factor

**CFA**— covering force area

**cGy**— centigray

**cGyph**— centigray per hour

**COMMZ**— communications zone

## D

**dose**— amount of radiation received at any given time.

**dose rate**— amount of radiation emitted from a single source at a specific time.

**D<sub>tb</sub>**— turnback dose

## E

**ECM**— electronic countermeasures

**ECCM**— electronic counter-countermeasures

**electromagnetic pulse (EMP)**— a nonuniform electric field resulting from a nuclear explosion, causing the emission of energy in the form of electromagnetic radiation.

**EW**— electronic warfare

## F

**FDC**— fire direction center

**FEBA**— forward edge of the battle area

**FLOT**— forward line of troops

**FOMET**— fallout meteorological message

**FSE**— fire support element

**FSOP**— field standing operating procedures

## G

**GN**— grid north.

**GMT**— Greenwich mean time

**GRR**— ground radiological recon

**GZ**— ground zero

## H

**half-thickness**— the thickness of any material that reduces the dose rate of gamma radiation to one-half its unshielded value.

**HN**— host nation. Allied nation in which US forces are operating.

## K

**km**— kilometer

**KT**— kiloton

## M

**METT-T**— mission, enemy, terrain, troops, and time available

**MEV**— million electron volts. Used to measure energy levels of radiation.

**minimum safe distance**— distance corresponding to a degree of protection needed to remain in the area.

**MSD**— minimum safe distance

## N

**NATO**— North Atlantic Treaty Organization

**NAV EDM**— US naval effective downwind message

**NBC**— nuclear, biological, and/or chemical

**NBCC**— NBC center

**NBCWRS**— NBC Warning and Reporting System

**NF**— normalizing factor

**NIGA**— neutron-induced gamma activity

## O

**OCF**— overall correlation factor

**OEG**— operational exposure guidance

**OPSEC**— operational security

**OPORD**— operational order

**OPLAN**— operations plan

**OPCON**— operational control

**P**

**passive defense measures**— measures taken to reduce possibilities of (or effects of) NBC attack  
**POW**— prisoner of war

**R**

**RES**— radiation exposure status  
**R<sub>th</sub>**— tumbback dose rate  
**RADIAC**— radiation detection, identification, and computation  
**rainout**— see washout

**S**

**SALUTE**— size, activity, location, unit, time, equipment  
**shielding**— protection from gamma rays and Xrays by use of dense materials such as metal, concrete, or certain soils.  
**SIGSEC**— signal security  
**SITREP**— situation report  
**SOP**— standing operating procedures  
**STRIKWARN**— warning of a friendly force's nuclear strike

**T**

**TARR**— time of arrival  
**Tcomp**— time of completion

**TF**— transmission factor

**TOB**— time of burst

**total dose**— total amount of radiation received

**T<sub>p</sub>**— projected in time (time of validity)

**transmission factor**— measure of the degree of shielding afforded by a structure, vehicle, fortification, or a set of specified shielding conditions.

**TREE**— transient radiation effects on electronics

**U**

**universal transverse mercator**— meridians and parallels of latitudes appearing as lines crossing at right angles.

**USMC**— US Marine Corps

**USMTF**— US message text format

**UTM**— universal transverse mercator

**V**

**VCF**— vehicle correlation factor

**W**

**washout/rainout**— the removal of radiological fallout particles from the air by precipitation passing through the radiation (cloud).

# Index

## A

Aerial Survey, 5-13—5-26  
 ANBACIS, 2-11, 6-31  
 Automated NBC Information System, 2-11

## C

Calculator, M4A1 Nuclear Yield, 3-6—3-7  
 Checklists, Nuclear Operations, G-1  
 Civilian Radiation Hazards, 8-0  
 Cloud Bottom Height, Stabilized, 3-11  
 Cloud Top Height, Stabilized, 3-11  
 Cloud Width, Nuclear Burst Angular, 3-11  
 Clouds, Nuclear, 3-2—3-5  
 Contamination Marking, 5-28—5-30  
 Correlation Factor, 5-2—5-4, 5-30  
 Crossing a Fallout Area, 6-23—6-31

## D

Decay Rate, 6-8—6-9, 7-6  
   determining, 6-9, F-1—F-3  
   graphical method, F-0  
   pocket calculator method, F-0  
 Detailed Fallout Prediction, NBC 3 Report, 4-0  
   actual fallout production, 4-14  
   from NAV NBC 3 nuclear report, 4-13  
   multiple Burst Procedures, 6-18—6-23  
   NBCC procedures, 4-3—4-11  
   unit procedures, 4-11—4-13  
 Dose Rate, 6-9—6-31, 7-2—7-3, 7-7  
   multiple bursts, F-3

## E

Effective Downwind Message, 3-16—3-29  
   examples, 3-17, 3-18, 3-25  
   naval, 3-19  
   preparation of, 3-19—3-29  
 Electronics. *See* Electromagnetic Pulse  
 Electromagnetic Pulse, C-1  
   basic planning, C-4  
   high-altitude, C-2  
   mitigation techniques, C-6  
   recovery operations, C-12  
   surface, C-1—C-2  
   tactical equipment, C-3  
 Exit Time (from fallout areas), 6-1, 6-3, 7-7

## F

Fallout Ashore Versus at Sea, 3-7  
 Fallout Direction, 4-14  
 Fallout Effects on Ships at Sea, 3-2  
 Fallout Prediction. *See* Detailed Fallout Prediction  
 Fallout Prediction Worksheet (Sample), 4-2  
 Fallout Predictor, M5A2, 3-21—3-24, example, 3-22  
 Fallout Template, Ship, 3-24—3-29  
 Flash-to-Bang Time, 3-7—3-9  
 Friendly Nuclear Attack Warning, 2-7

## G

Ground Survey, 5-26—5-27  
 Ground Zero, Location of, 3-5, 3-10, 3-11

## H

H-Hour, Calculation of, 6-4—6-8

## I

Illumination Time, 3-12  
 Induced Radiation, 7-1  
 Intelligent Preparation of the Battlefield, 1-0

## M

M5A1 Fallout Predictor, 3-21—3-24  
 Marking Contamination. *See* Contamination Marking  
 Monitoring, 5-1—5-8  
   direct method, 5-2  
   indirect method, 5-2—5-4  
   recording and reporting, 5-4—5-8  
 Multiple Burst Procedures. *See* Detailed Fallout Procedures

## N

NBC Warning and Reporting System, 2-0—2-11  
   designated observer system, 2-6—2-7  
   evaluating nuclear information, 2-4—2-5  
   friendly nuclear attack, 2-7—2-11  
   managing, 2-4  
   standard NBC reports, 2-0—2-4  
   transmitting nuclear information, 2-5—2-6  
 NBC 1 Nuclear Report 2-1—2-2, examples, 3-8  
 NBC 2 Nuclear Report, 2-2—2-3, 3-13—3-16, example, 3-13

## FM 3-3-1

NBC 3 Nuclear Report, 2-3, examples, 4-12  
NBC 3 Report, 2-3. *See also* Detailed Fallout Prediction—  
NBC Report  
NBC 4 Report, 2-3, examples, 5-6  
NBC 5 Report, 2-3—2-4  
NBCC Procedures, Nuclear, 3-9  
Neutron-Induced Radiation Areas, 7-0—7-7  
    crossing a, 7-4  
    decay of, 7-2—7-2  
    dose rate calculations, 7-2—7-4  
    transmission factors, 7-6  
Nomograms and Tables, E-1—E-99  
Normalizing Factors, 6-14, F-3  
    graphical method, F-3  
    mathematical method, F-3  
Normalizing Readings to H+1, 6-9, 6-14. *See also* Dose Rate,  
    Total Dose  
Nuclear Clouds, 3-2—3-5  
Nuclear Operations, 3-0  
Nuclear Weapons Effects, 3-0—3-2  
Nuclear Threat Status, 1-2

### O

Operational Exposure Guidance, A-1—A-7

### R

Radiological Calculations. *See* Nomograms and Tables  
Radiation Effects, Initial, 3-1  
Radiation Effects, Residual, 3-1  
Radiation Exposure, Categories of, A-1  
Radiation Exposure Records, A-2  
Radioactive Areas. *See* Neutron-Induced Radiation Areas  
Radiological Data Sheet for monitoring (sample), 5-5  
Radiological Monitoring. *See* Monitoring  
Reconnaissance, 5-27—5-34  
    aerial, 5-33—5-34  
    ground, 5-30—5-33  
Recording and Reporting Nuclear Burst Data, 3-9

### S

Shielding, B-0  
    materials, B-0  
    mathematical method of determining, B-0  
    Transmission Factors, B-3  
STRIKWARN Messages, 2-8  
    examples of, 2-9  
Surveys, 5-8—5-17  
    aerial, 5-13—5-26  
    ground, 5-26  
STANAG 2984, 1-2—1-4

### T

Time and Burst of Attack, 3-9  
Total Dose Procedures, 6-14—6-18, 7-3—7-4  
Transmission Factors, 6-3, 7-6, B-3

### V

Vulnerability Analysis, 1-0  
    friendly Unit, 1-8  
    nuclear, 1-4  
    vulnerability reduction, 1-9—1-11

### W

Wind Vector Plotting, D-1—D-14  
    manual methods, D-2—2-4, D-11—D-13  
    plotting scale methods, D-5—5-6, D-9—D-11  
    upper air wind data, D-1  
    procedures, D-2—D-13

### Y

Yield Estimation, 3-6—3-7, 3-11  
Yield Estimation from Radar Data, 3-12  
Yield, Resolved, 3-12