

# EL, EL4, EL6

## Horizontal, End-Suction Centrifugal Pumps

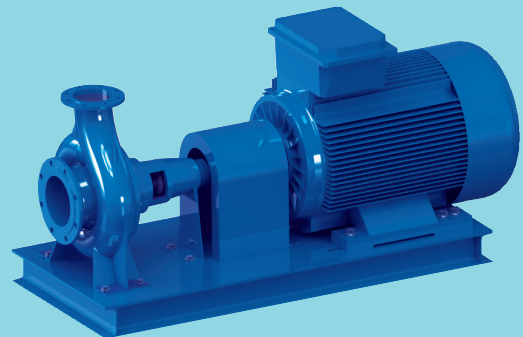

### CONSTRUCTION

Single-stage end-suction centrifugal pumps, with bearing bracket. Nominal duty points and main dimensions in accordance with EN 733. Back Pull-Out construction, for simple and quick dismantling and reassembly.

Rated speed of rotation (50 Hz):

**EL** = 2900 rpm

**EL4** = 1450 rpm

**Connections:** PN 16 flanges EN 1092-2.

Max. working pressure 10 (16) bar

#### Shaft sealing

- Standardized mechanical seal in accordance with ISO 3069.
- Stuffing box seal or different mechanical seals (on request).

### APPLICATIONS

- For clean liquids, without abrasives, which are non-aggressive for the pump materials (contents of solids up to 0.2%).
- For water supply.
- For heating, air conditioning, cooling and circulation plants.
- For civil and industrial applications and for agriculture.
- For fire fighting applications.
- For irrigation.

### OPERATING CONDITIONS

Liquid temperature from -10°C to +120°C. (standard mechanical seal)

Ambient temperature up to 40°C.

Total suction lift up to 7 m.

Maximum permissible working pressure up to 10/16 bar.

### PUMP-MOTOR UNIT

EL, EL4 pump connected to a standard electric motor in B3 construction form (IEC 72), IP 54 protection, three-phase 400 V, 50 Hz by means of a baseplate, driven by a flexible coupling and with coupling protection.

### SPECIAL FEATURES ON REQUEST

- Extra support foot for bearing housing.
- Special mechanical seal.
- Different construction materials for specific applications.
- Higher or lower liquid or ambient temperatures.
- Other motor protection.
- Explosion proof motor.
- Motor for other voltage.
- Frequency 60 Hz (as per 60 Hz data sheet).

### MATERIALS

Pump casing	GG 25
Lantern bracket	(Optional GGG 40 / AISI 304 / AISI 316 / Bronze)
Impeller	
Pump shaft	AISI 420 (Optional AISI 304 / AISI 316)
Mechanical seal	Silicon Carbide / Carbon Graphite*
Baseplate	DIN 17100 - St 37, epoxy coated
Coupling guard	EN 294 / DIN 31001, epoxy coated

\* Different mechanical seals are available upon request.

# EL

## Horizontal, End-Suction Centrifugal Pumps

2900 1/min

**EL 32-125**

**EL 32-160**

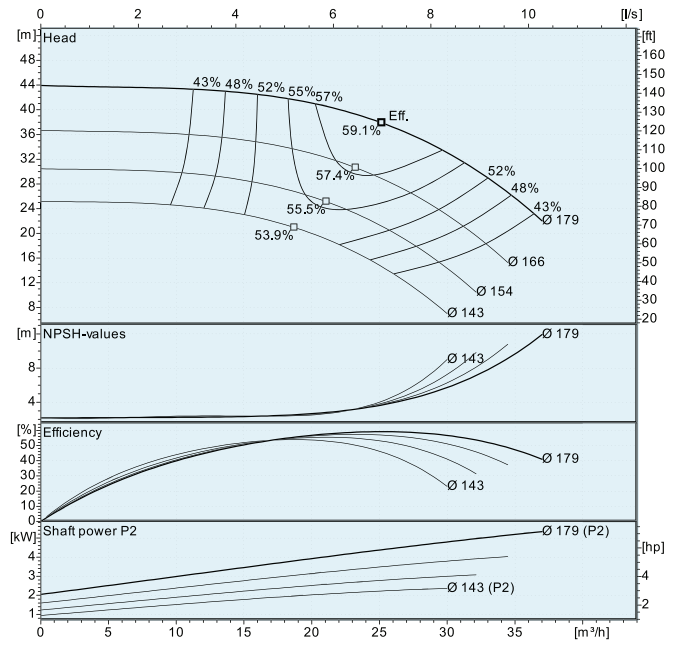
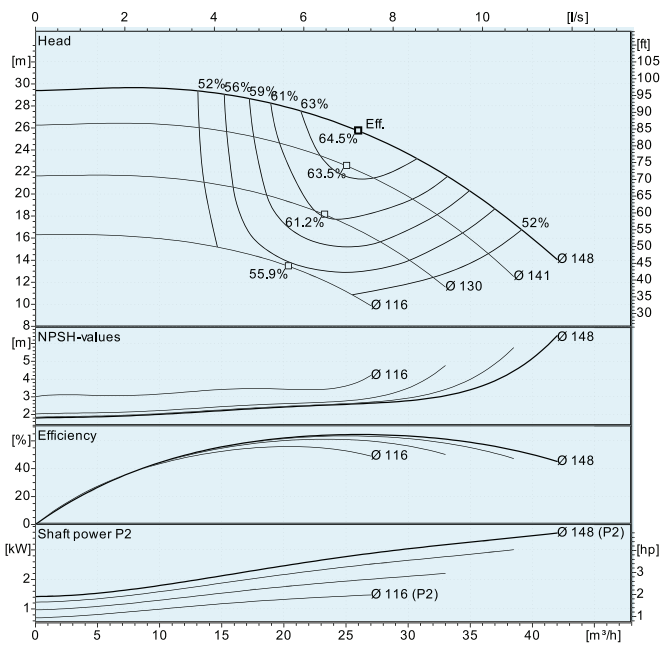

**EL 32-200**

**EL 32-250**

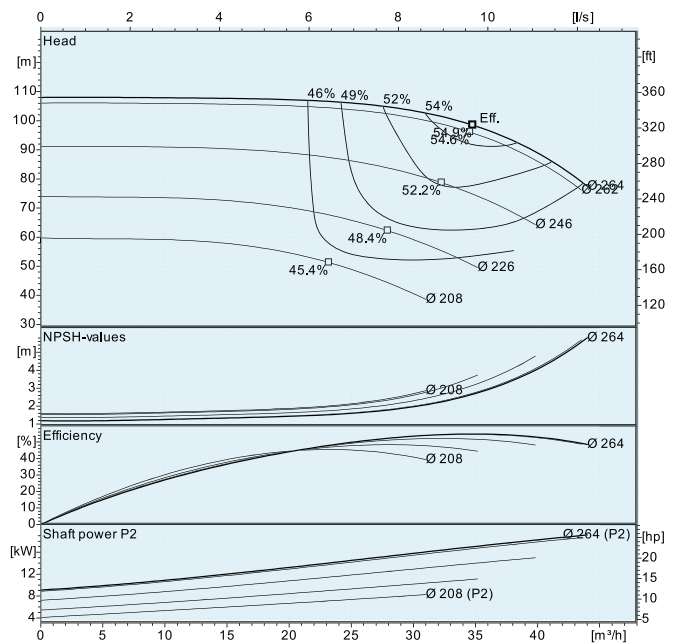
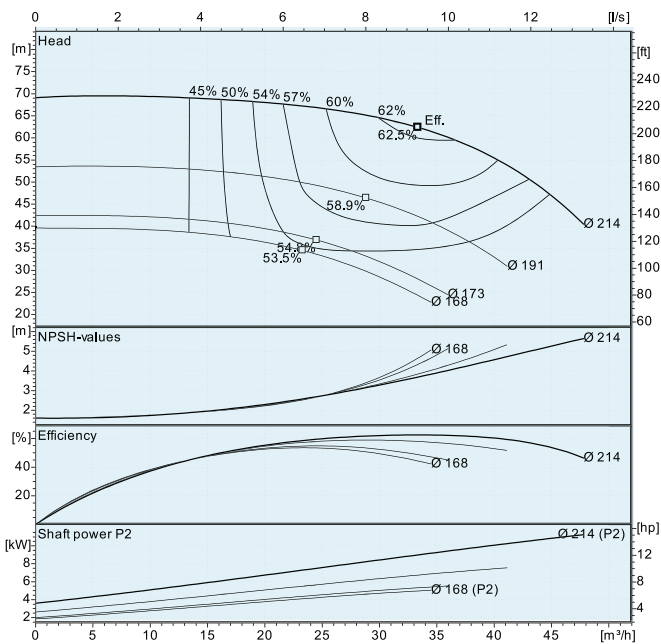

# EL

## Horizontal, End-Suction Centrifugal Pumps

2900 1/min

**EL 40-125**

**EL 40-160**

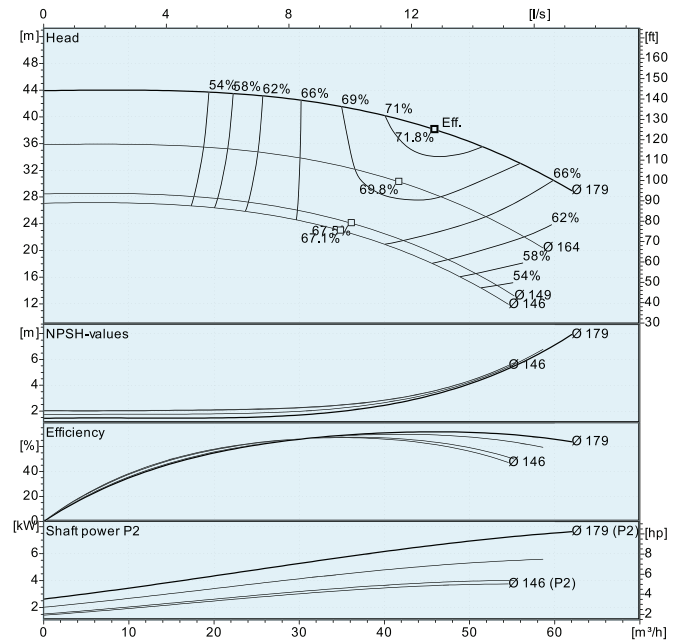
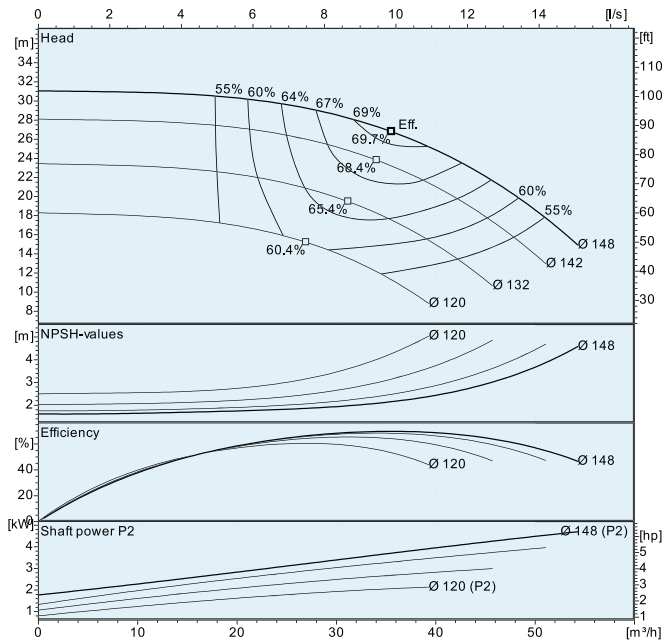

**EL 40-200**

**EL 40-250**

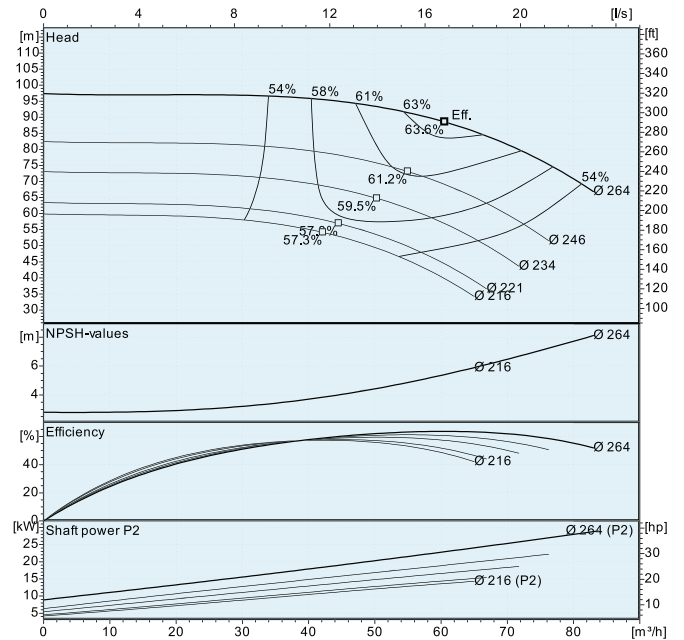
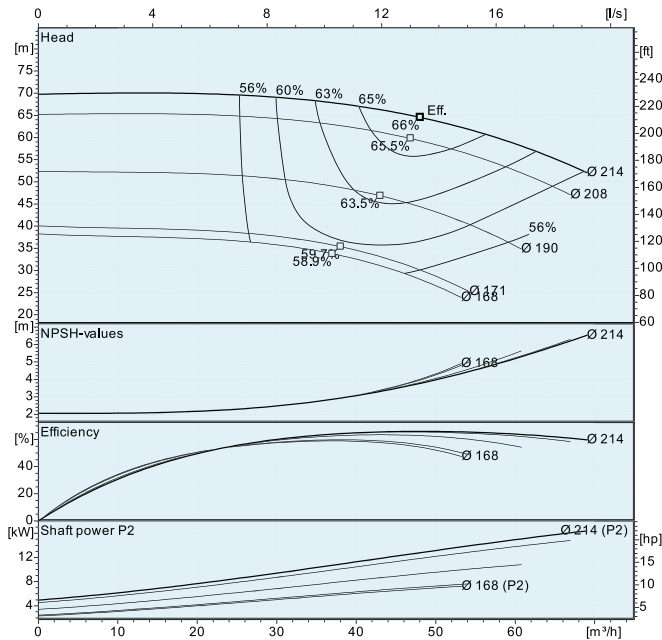

# EL

## Horizontal, End-Suction Centrifugal Pumps

2900 1/min

**EL 40-315**

**EL 50-125**

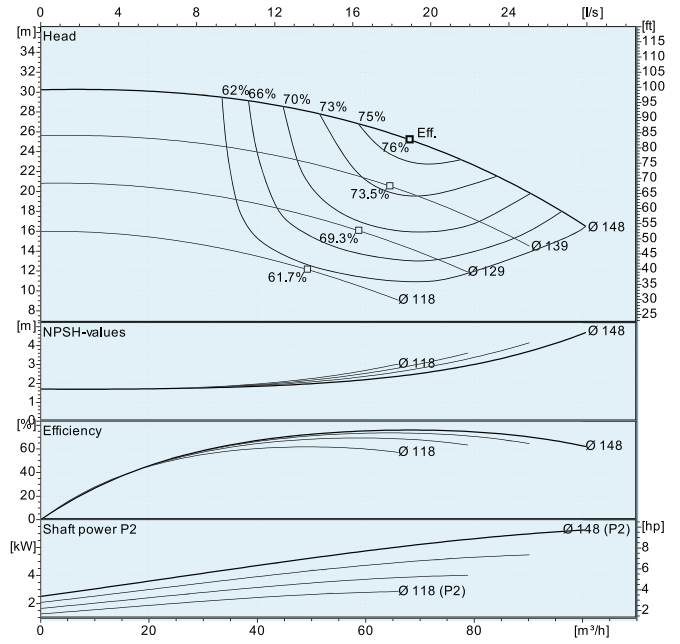
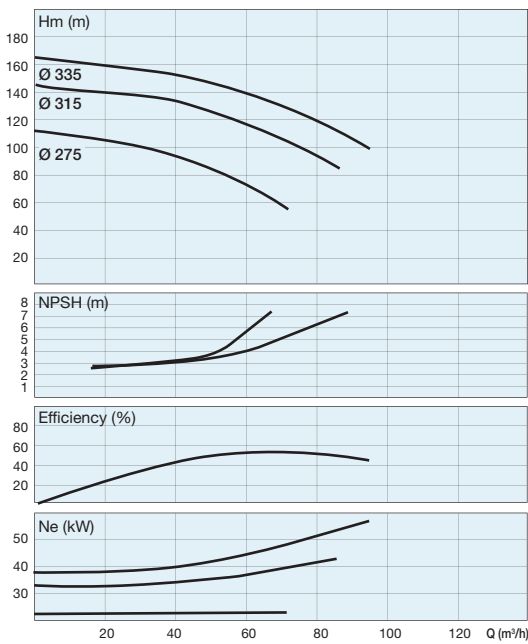

**EL 50-160**

**EL 50-200**

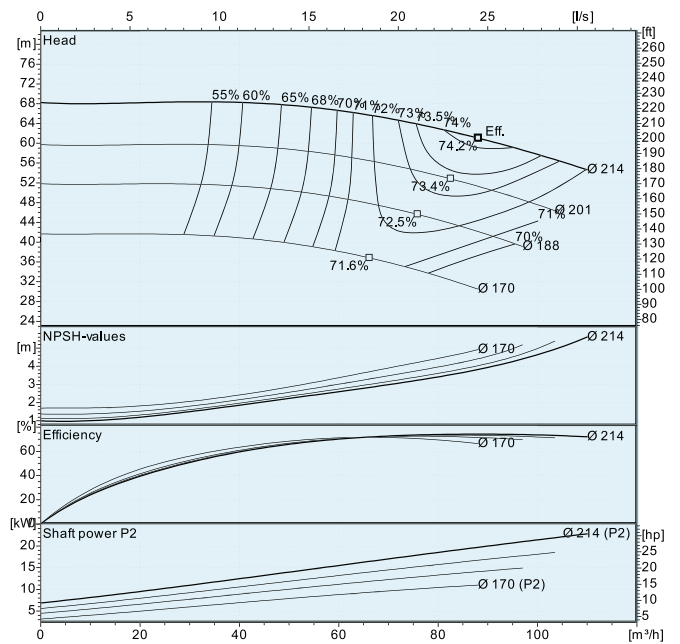
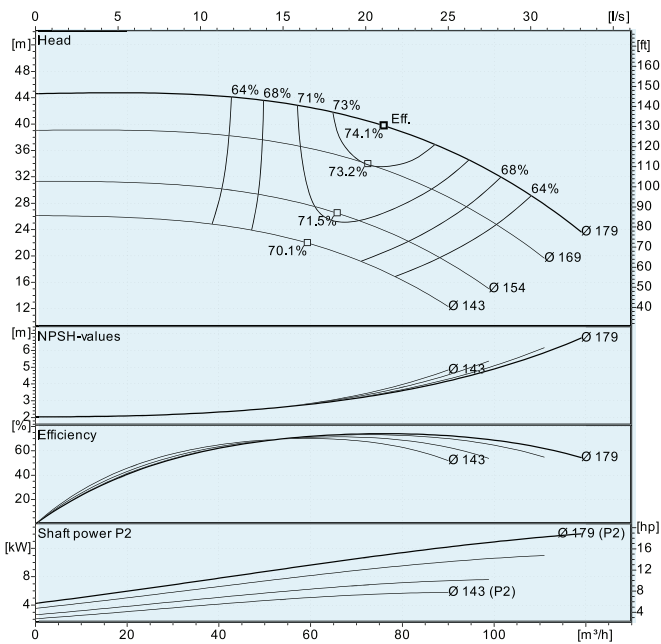



# EL

## Horizontal, End-Suction Centrifugal Pumps

2900 1/min

### EL 50-250

### EL 50-315

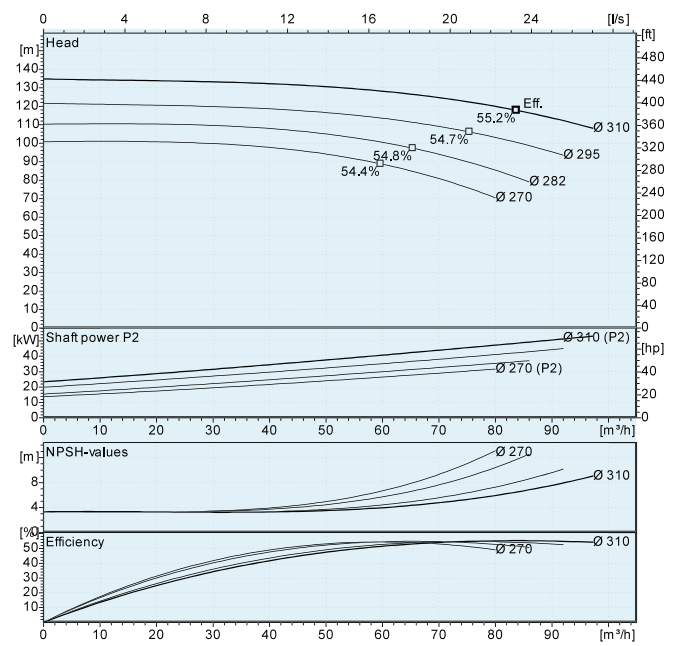
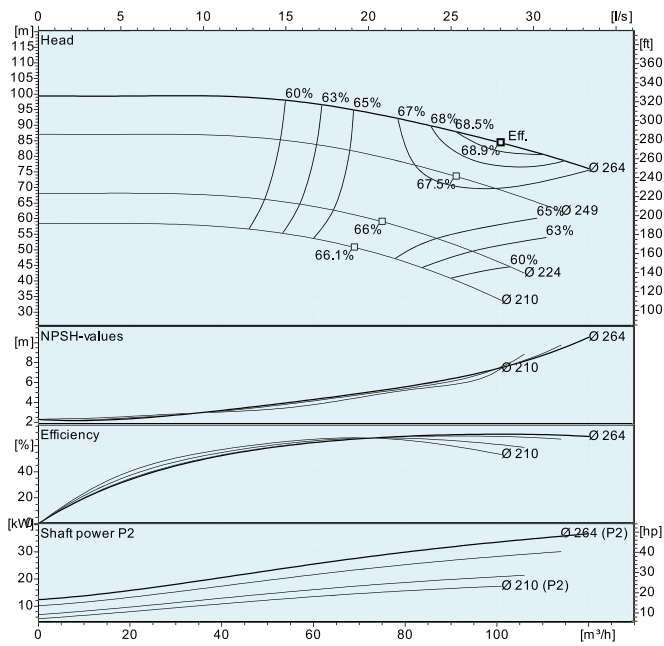

### EL 65-125

### EL 65-160

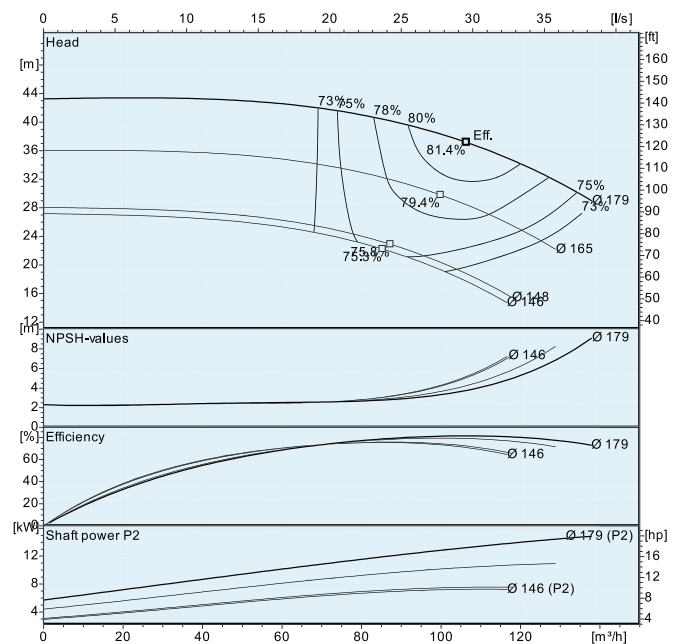
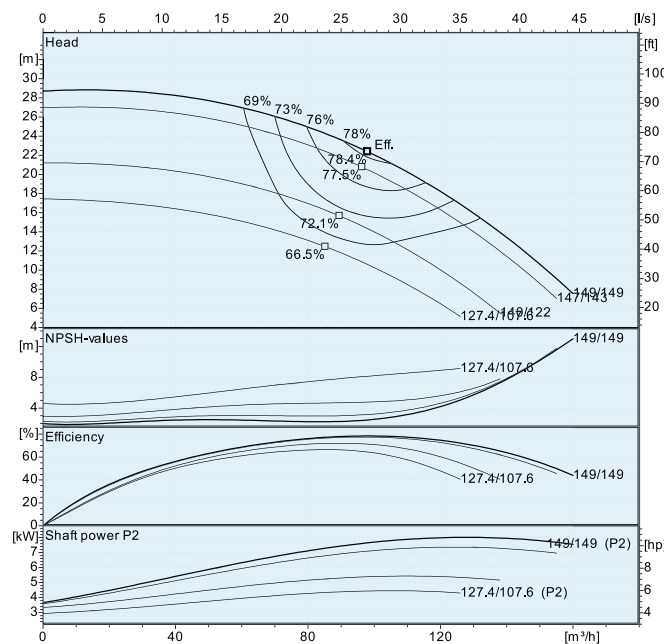



# EL

## Horizontal, End-Suction Centrifugal Pumps

2900 1/min

### EL 80-200

### EL 80-250

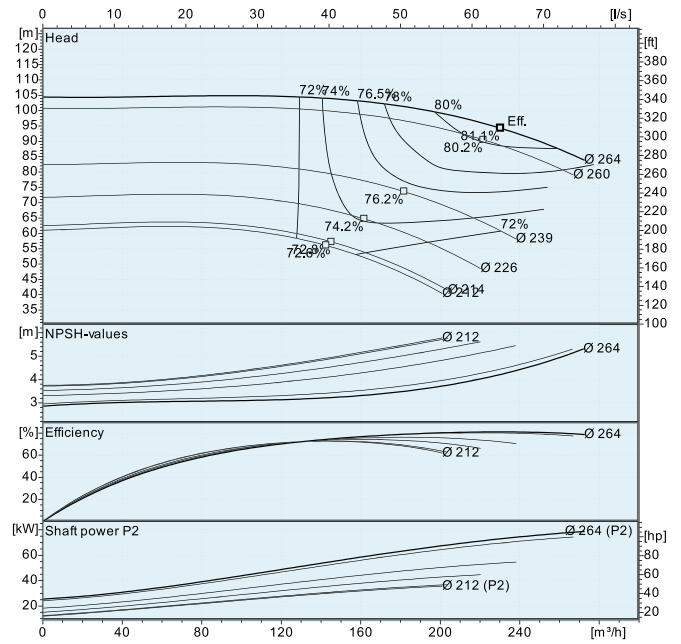
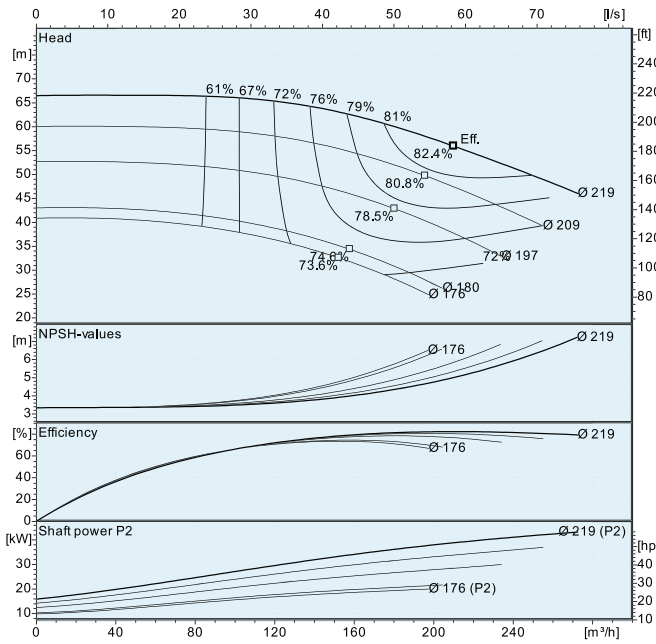

### EL 80-315

### EL 100-160

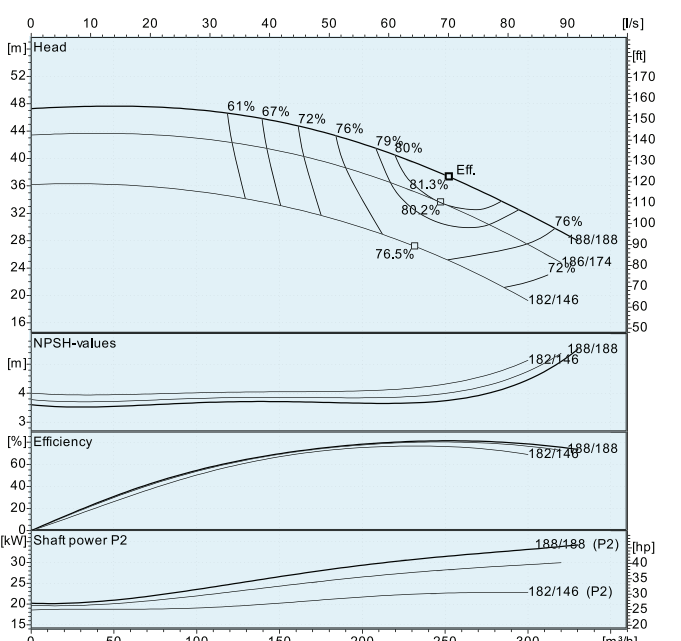
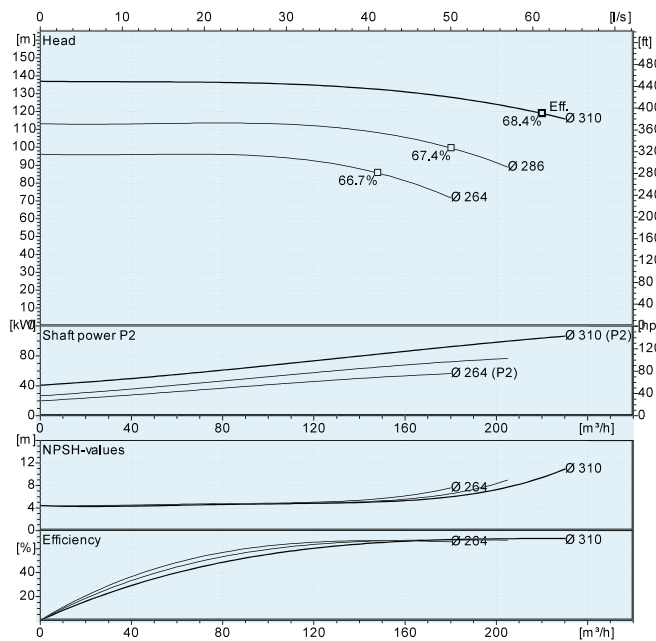

# EL

## Horizontal, End-Suction Centrifugal Pumps

2900 1/min

**EL 100-200**

**EL 100-250**

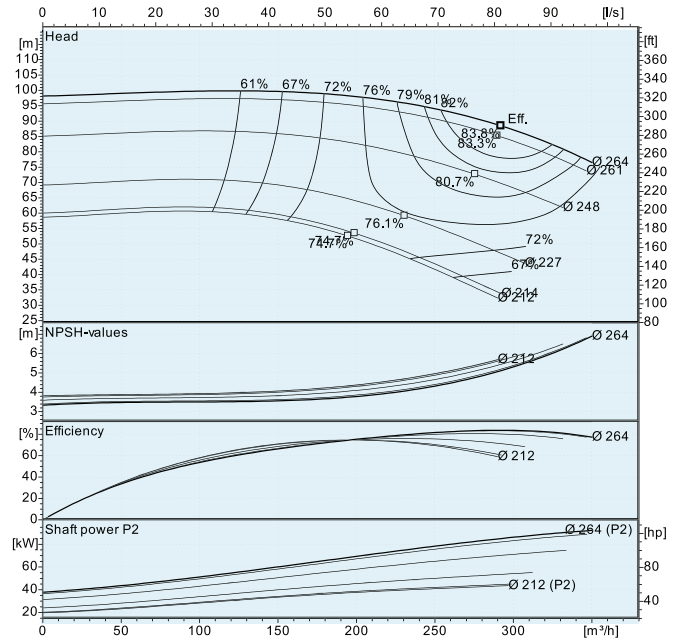
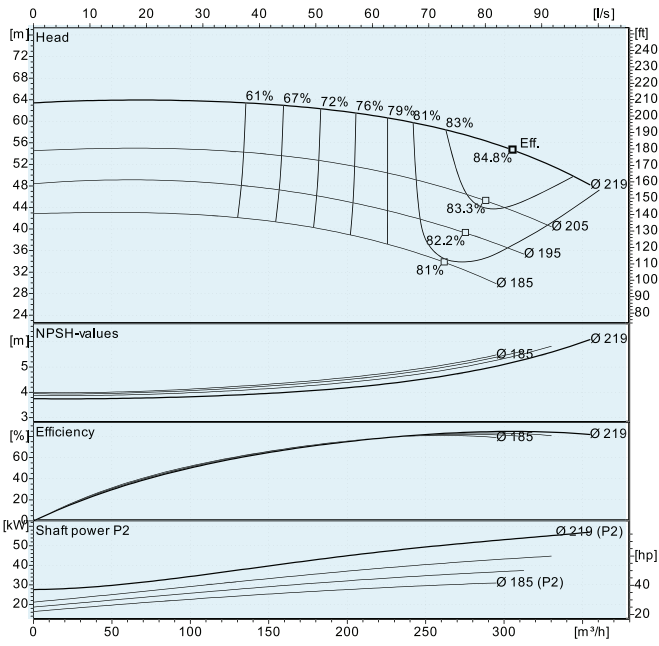

**EL 100-315**

**EL 125-200**

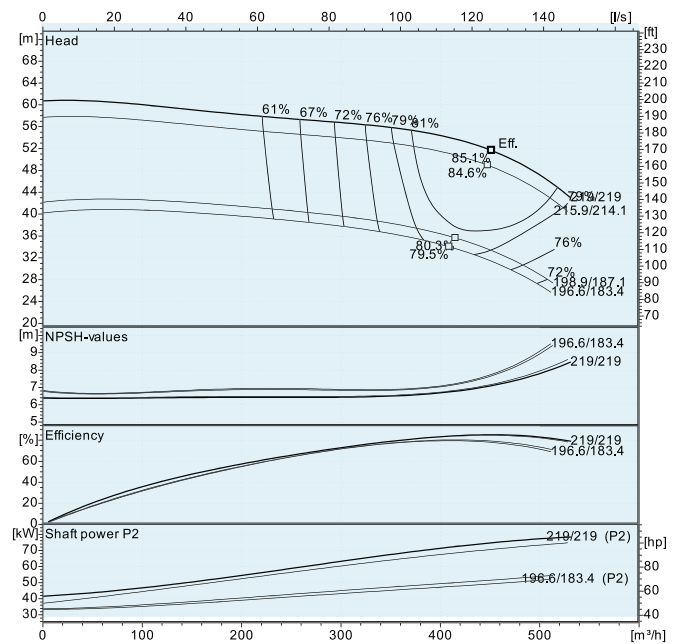
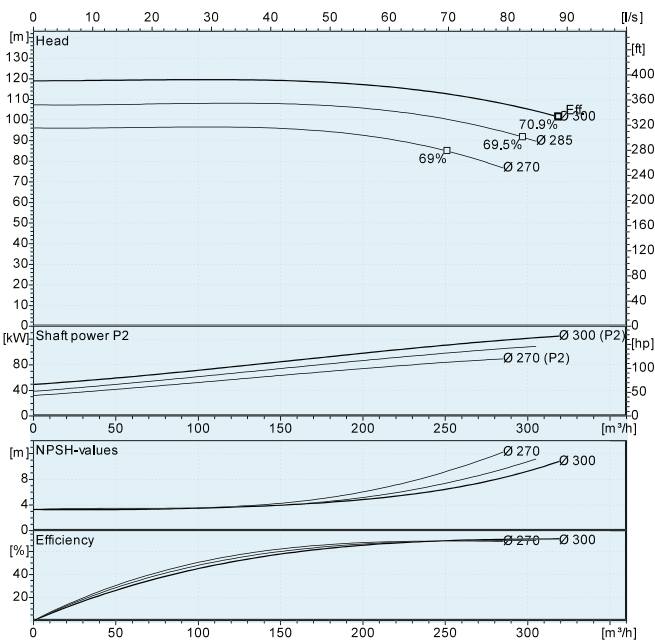

# EL

## Horizontal, End-Suction Centrifugal Pumps

2900 1/min

### EL 125-250

### EL 125-300

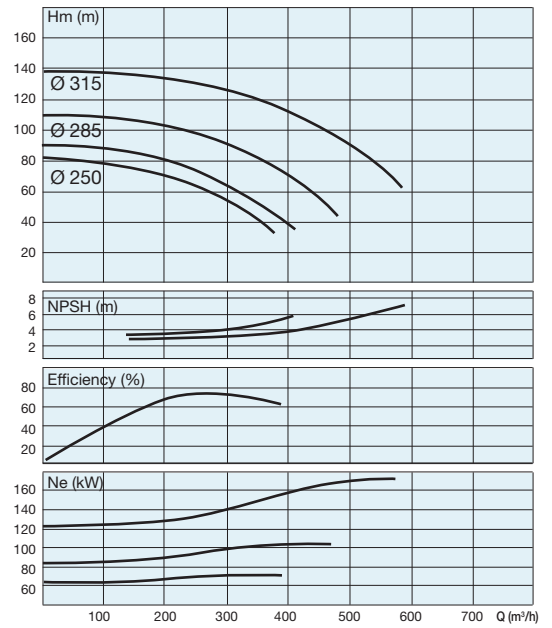
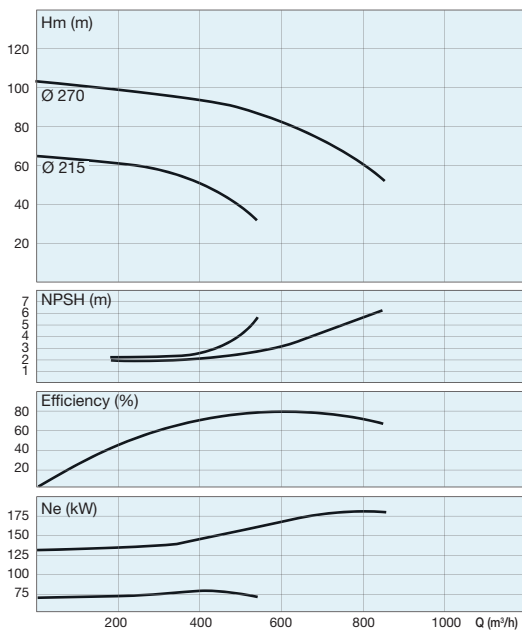

### EL 125-315

### EL 150-315

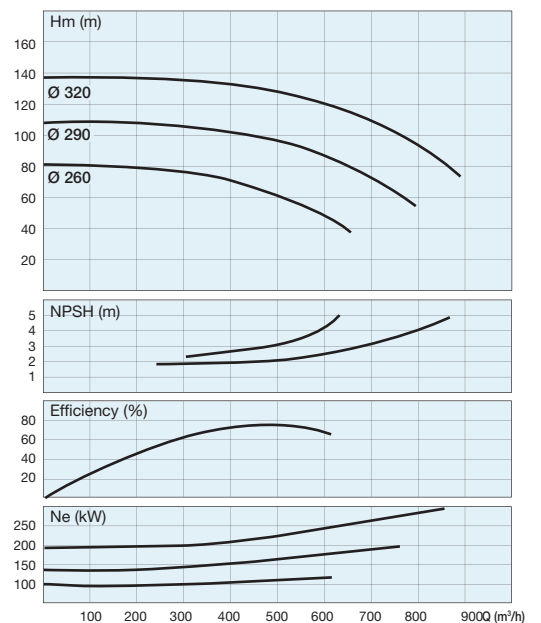
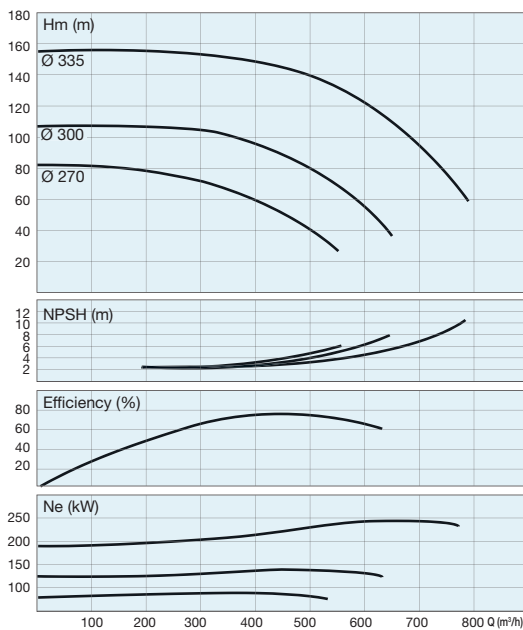

# EL4

## Horizontal, End-Suction Centrifugal Pumps

1450 1/min

### EL4 32-125

### EL4 32-160

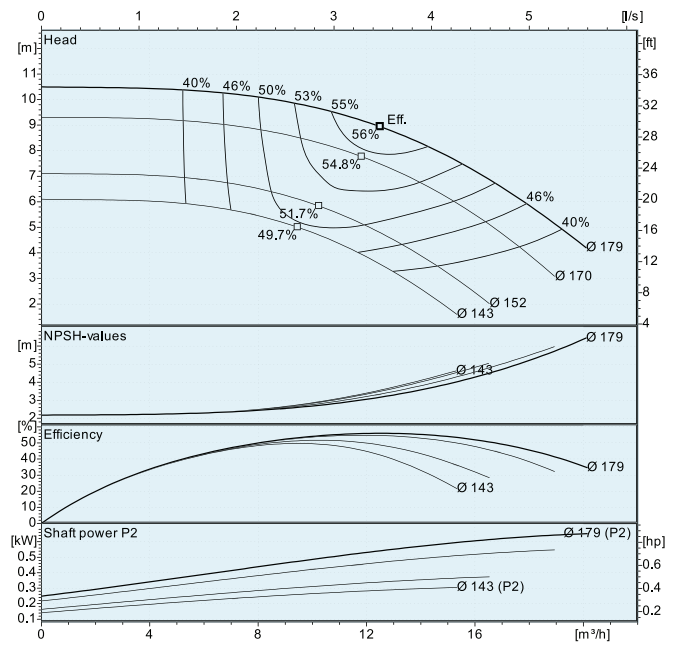
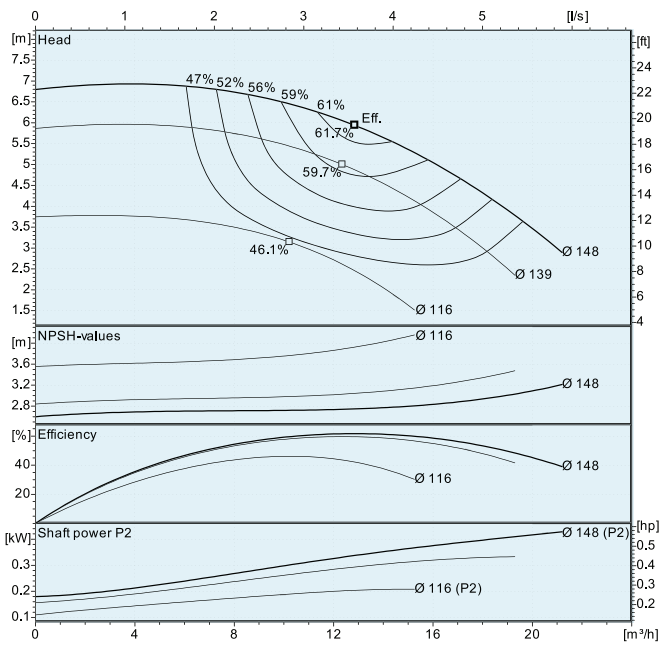

### EL4 32-200

### EL4 32-250

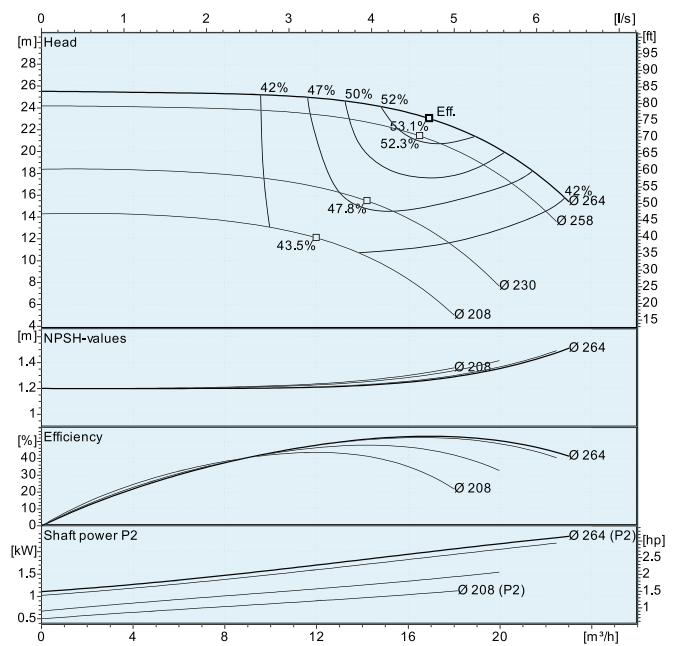
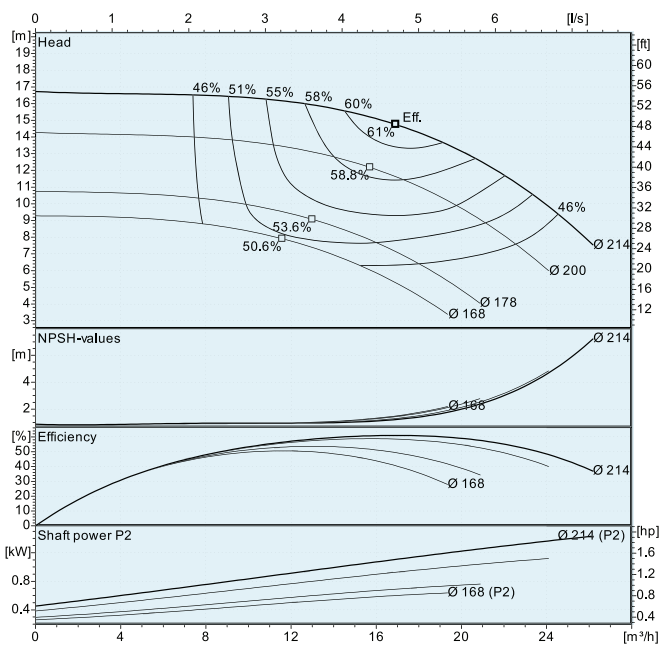

# EL4

## Horizontal, End-Suction Centrifugal Pumps

1450 1/min

### EL4 40-125

### EL4 40-160

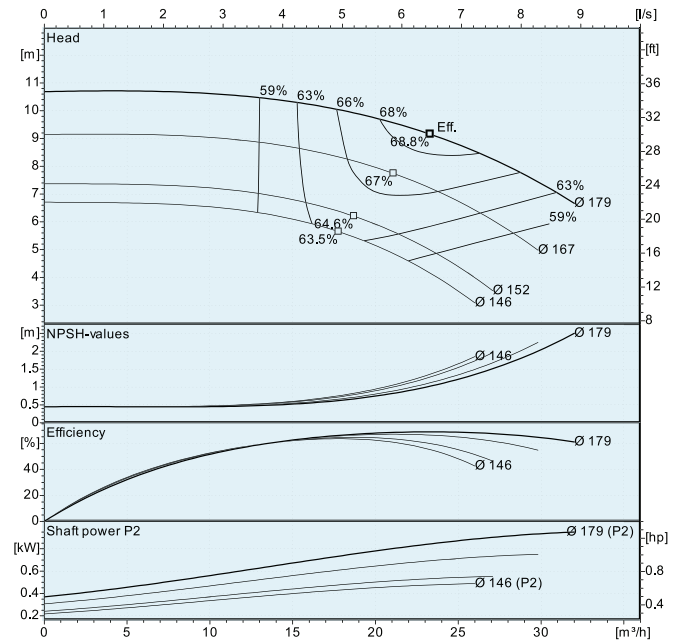
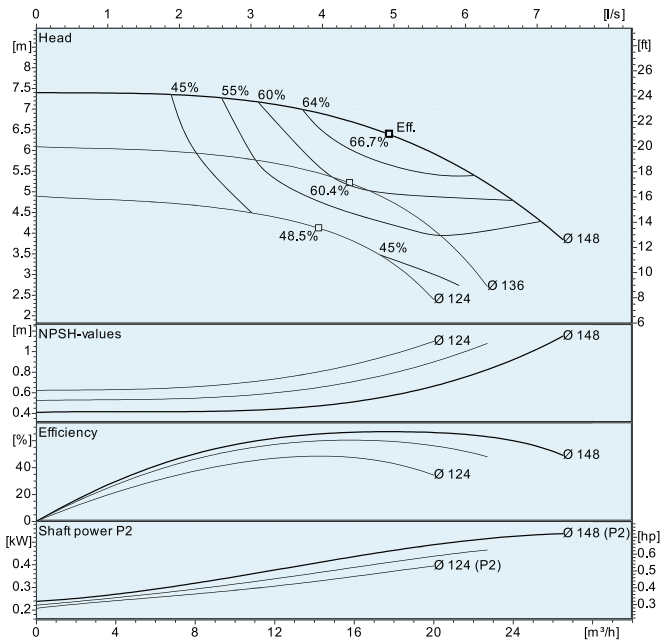

### EL4 40-200

### EL4 40-250

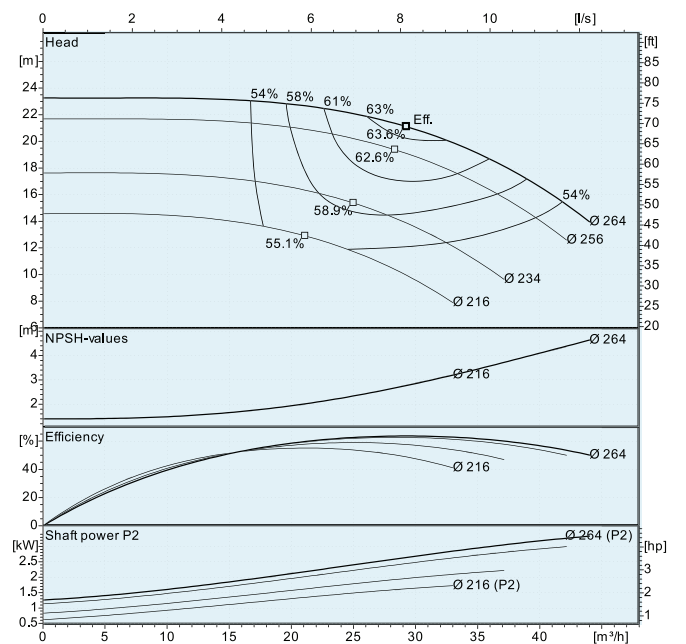
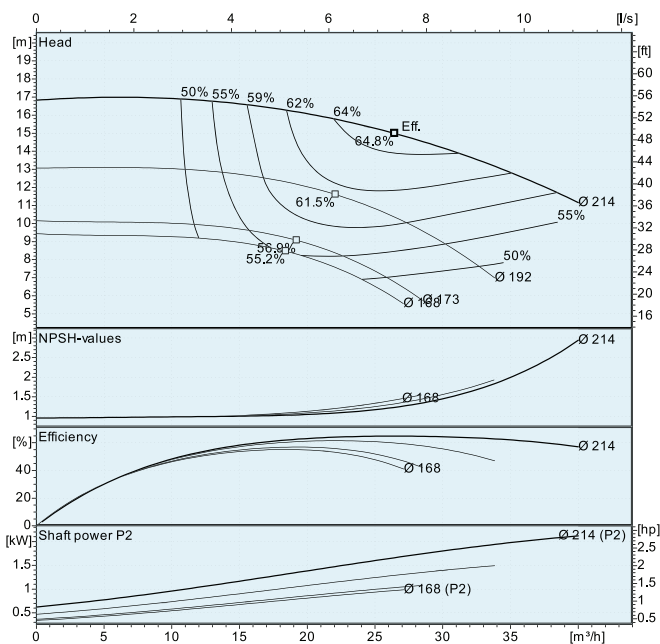

# EL4

## Horizontal, End-Suction Centrifugal Pumps

1450 1/min

### EL4 40-315

### EL4 50-125

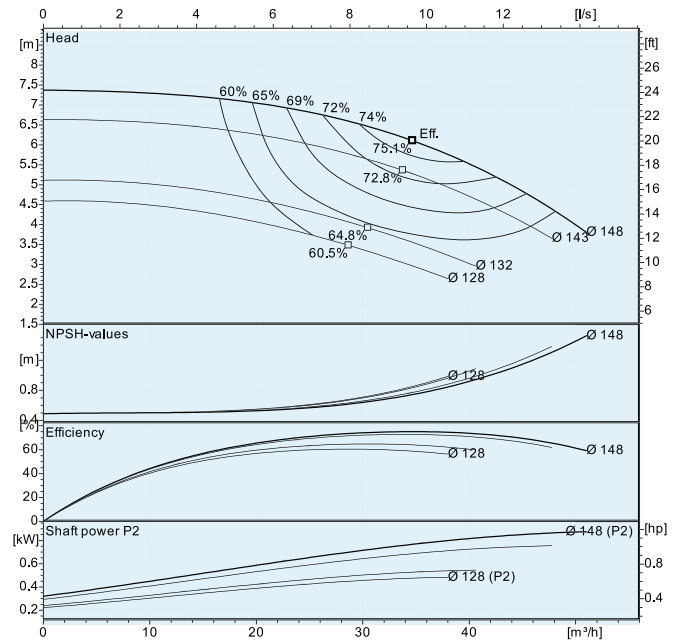
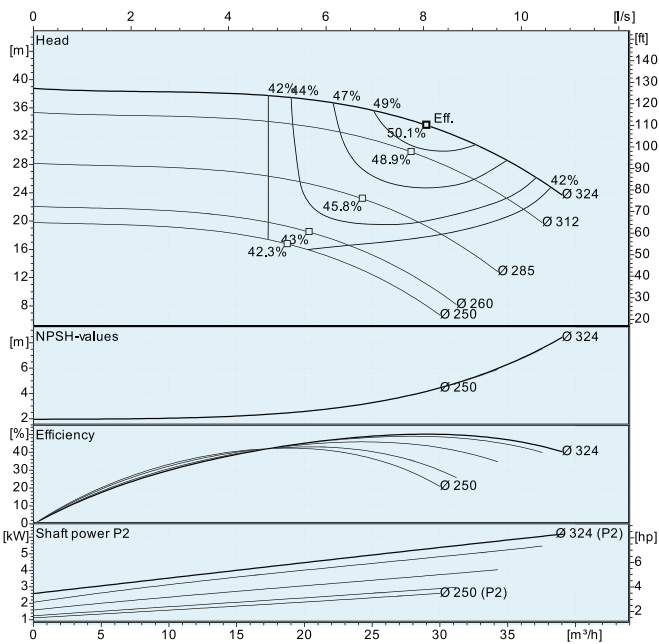

### EL4 50-160

### EL4 50-200

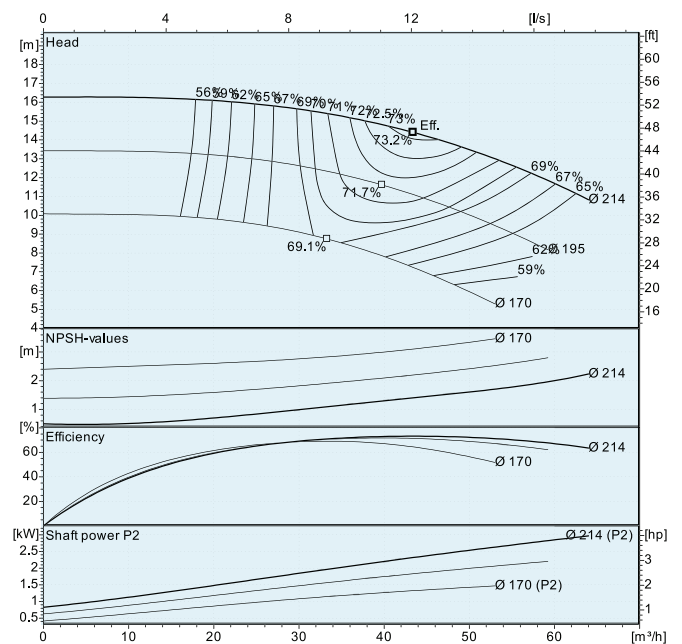
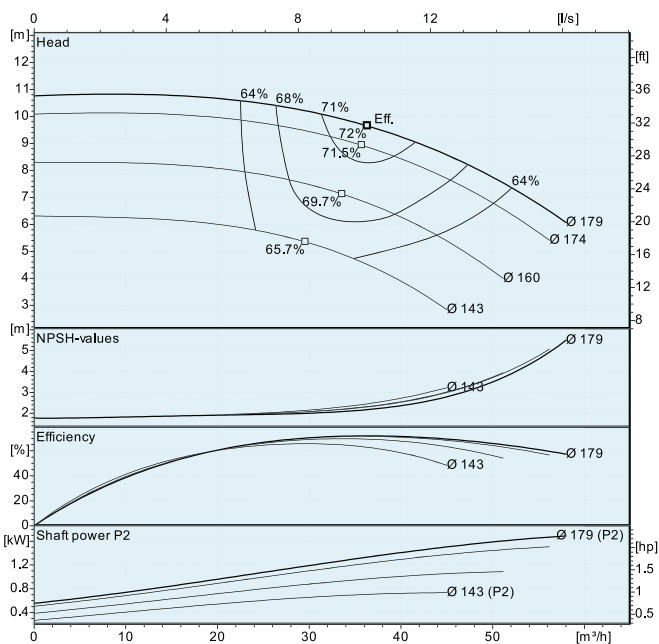



# EL4

## Horizontal, End-Suction Centrifugal Pumps

1450 1/min

### EL4 50-250

### EL4 50-315

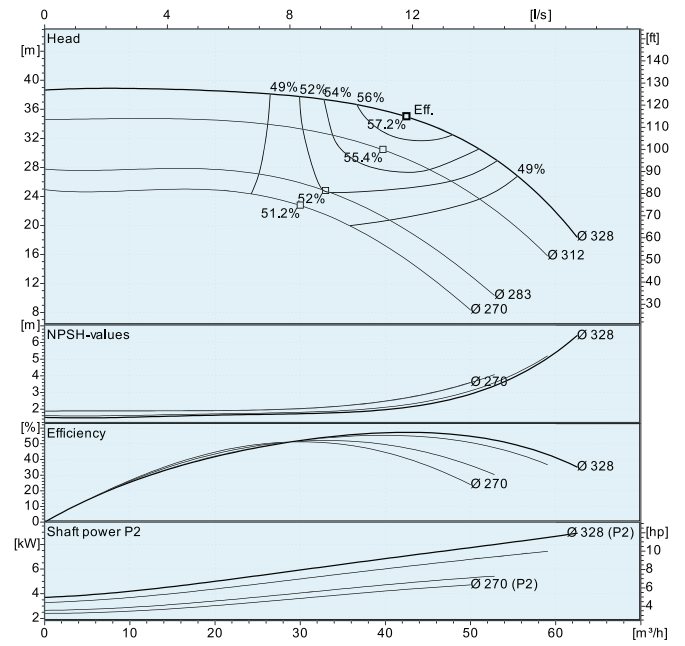
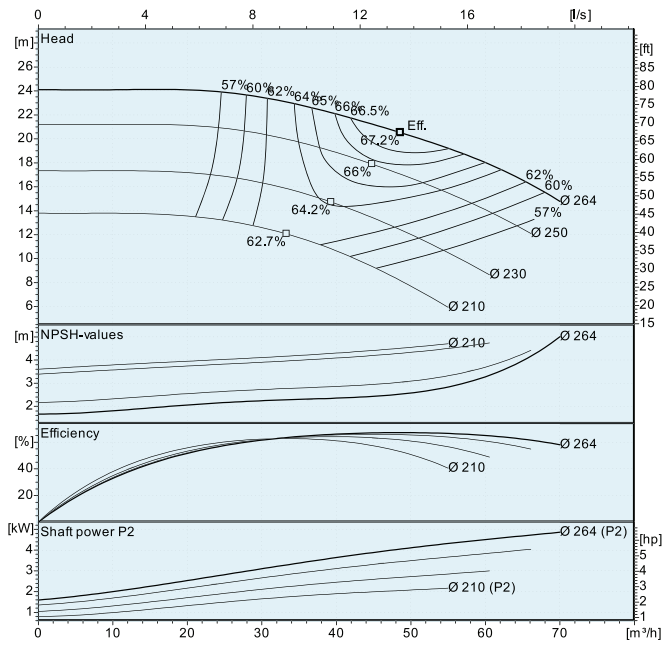

### EL4 65-125

### EL4 65-160

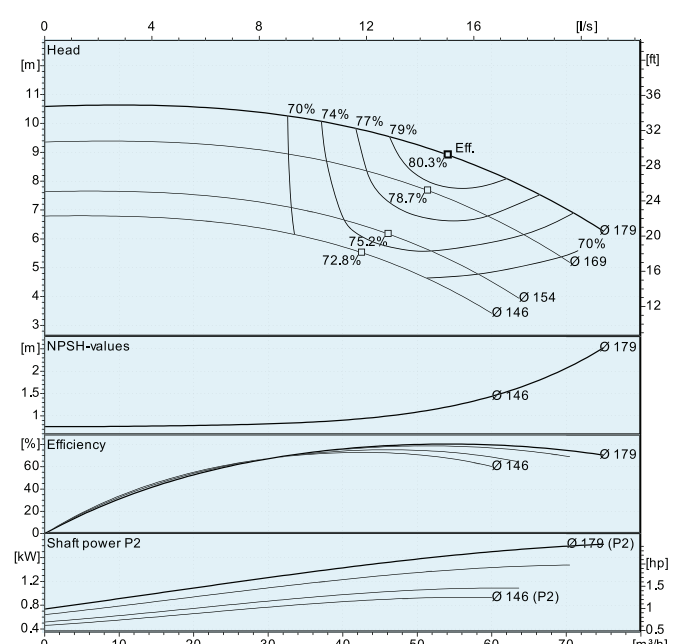
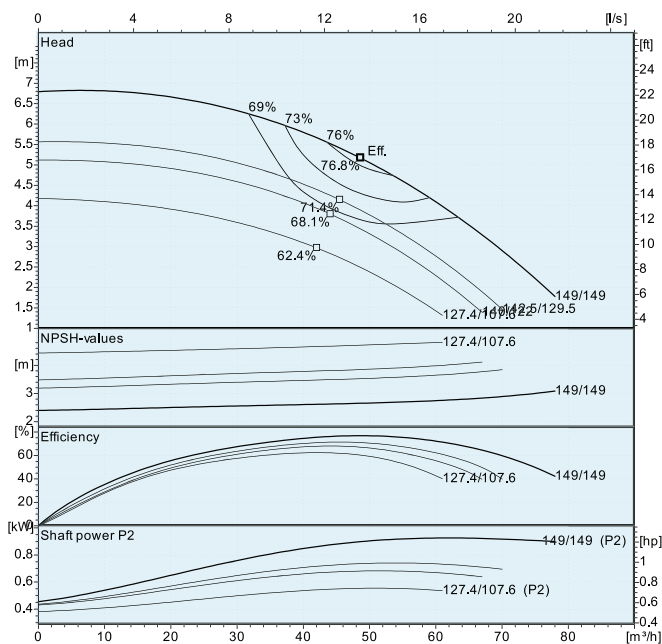

# EL4

## Horizontal, End-Suction Centrifugal Pumps

1450 1/min

### EL4 65-200

### EL4 65-250

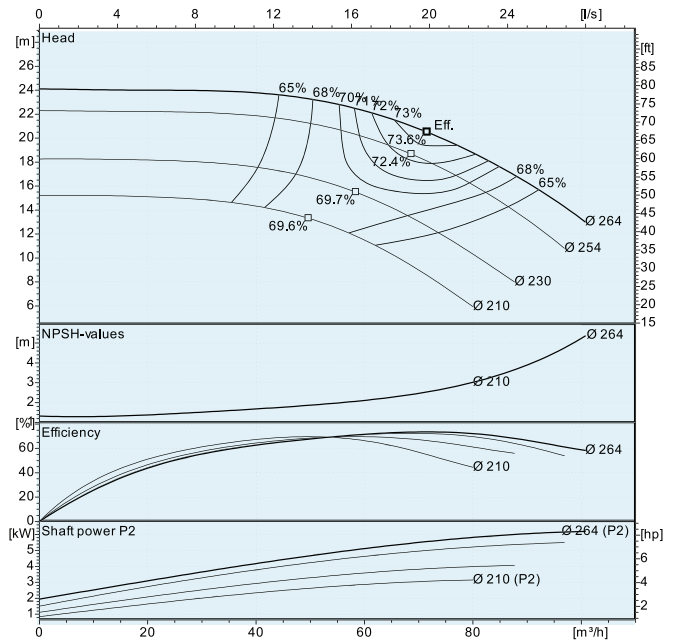
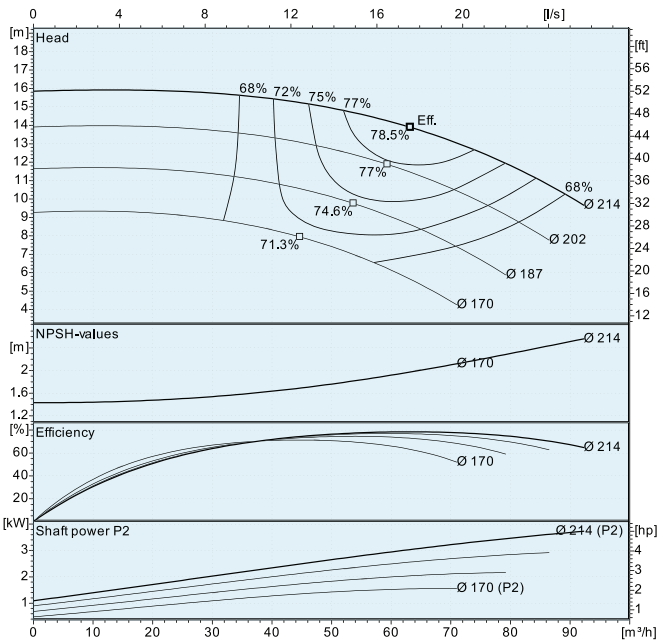

### EL4 65-315

### EL4 65-400

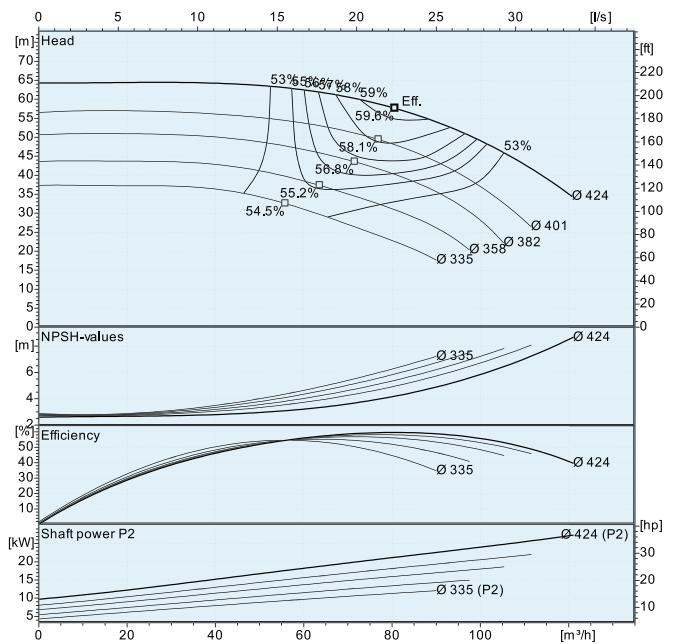
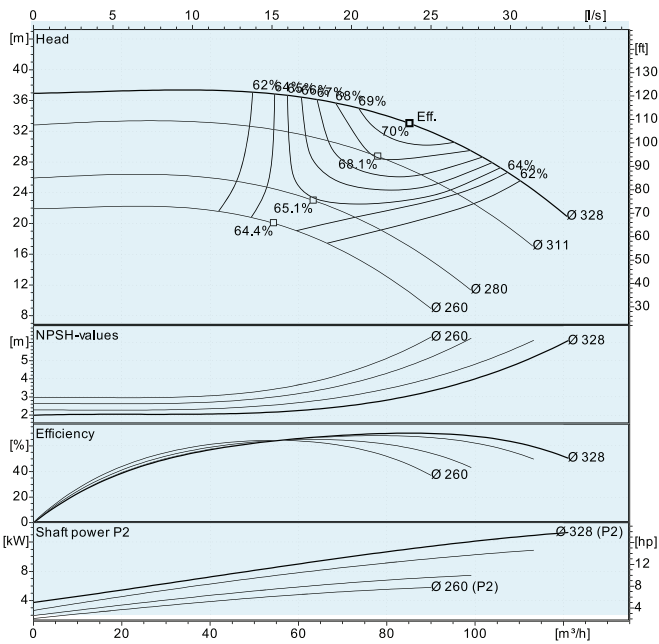

# EL4

## Horizontal, End-Suction Centrifugal Pumps

1450 1/min

### EL4 80-160

### EL4 80-200

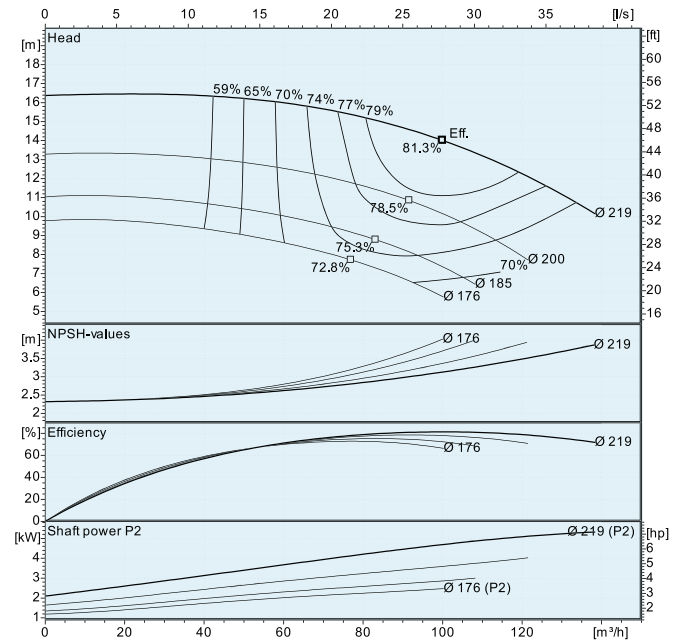
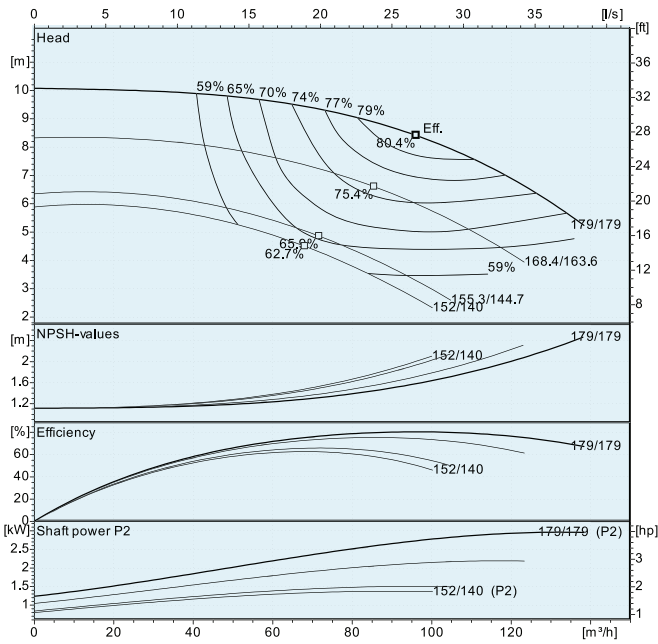

### EL4 80-250

### EL4 80-315

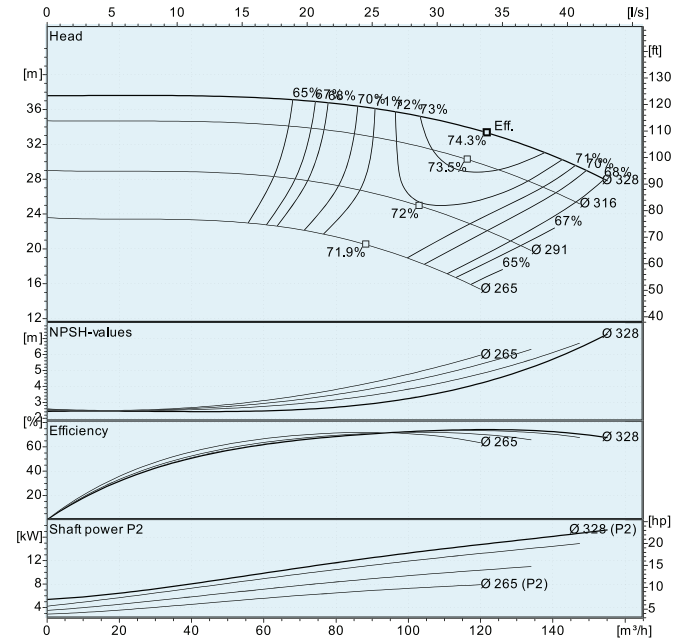
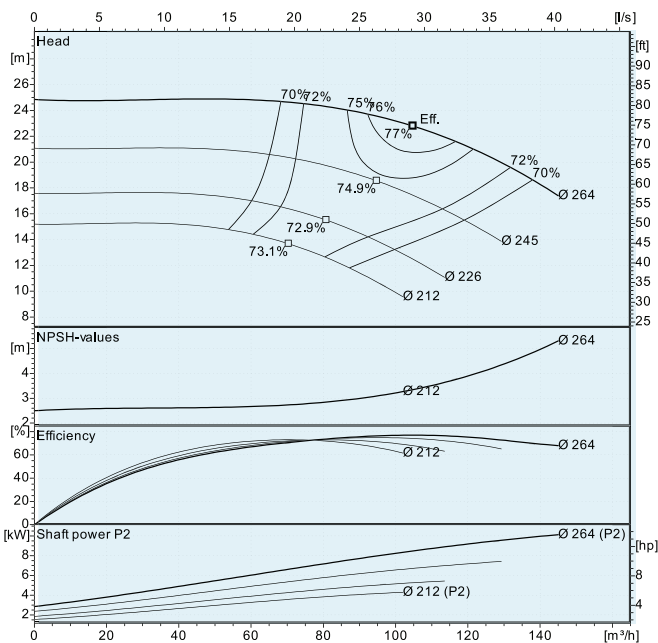

# EL4

## Horizontal, End-Suction Centrifugal Pumps

1450 1/min

**EL4 80-315B**

**EL4 80-400**

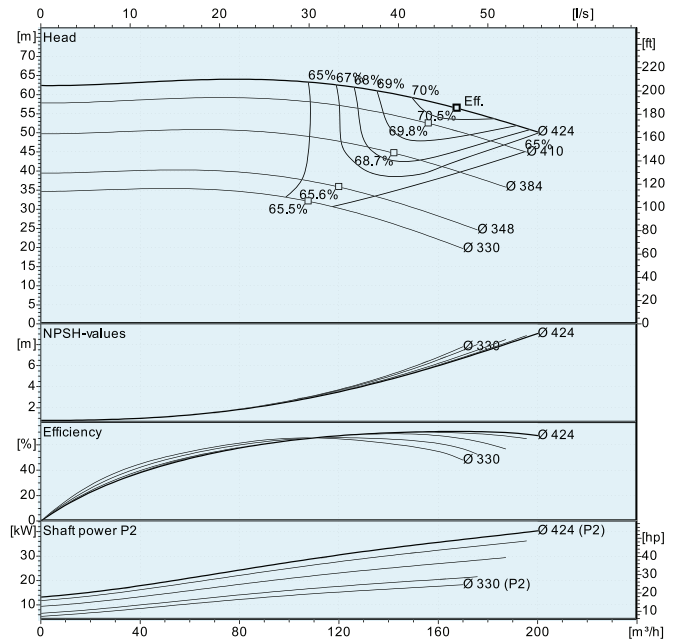
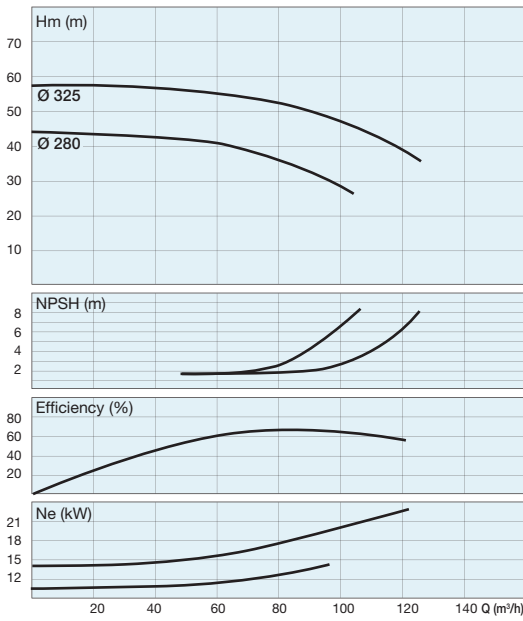

**EL4 100-160**

**EL4 100-200**

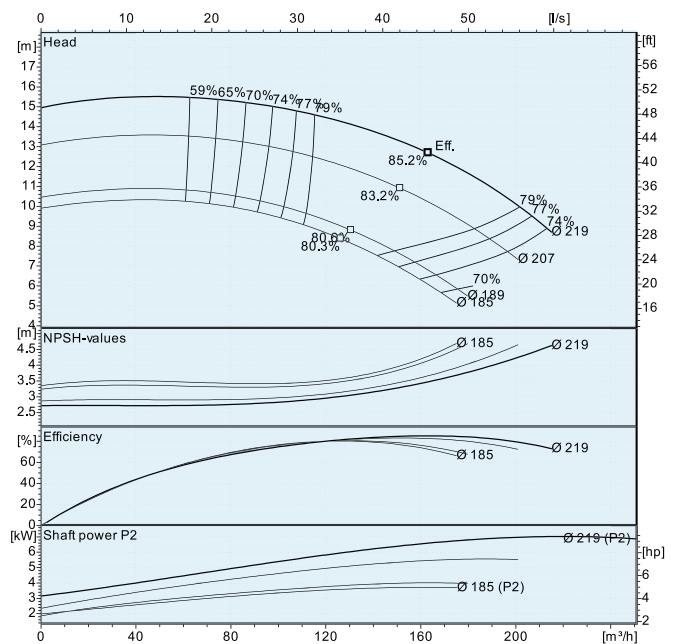
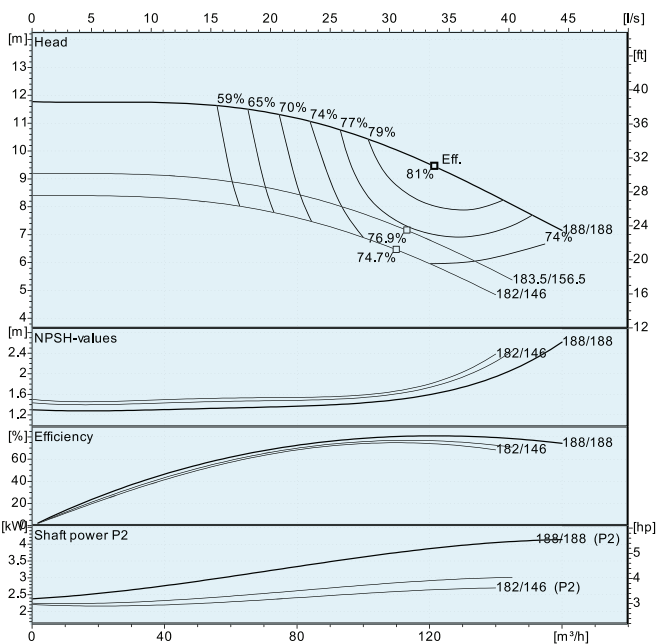

# EL4

## Horizontal, End-Suction Centrifugal Pumps

1450 1/min

### EL4 100-250

### EL4 100-315

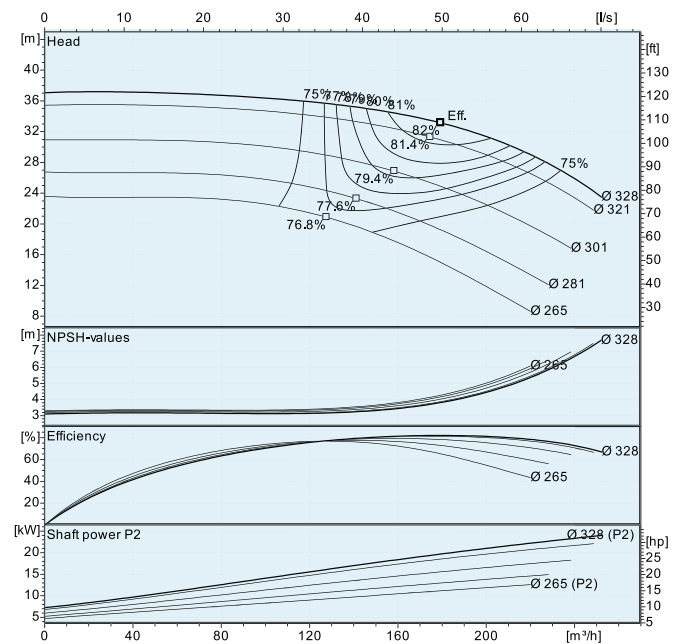
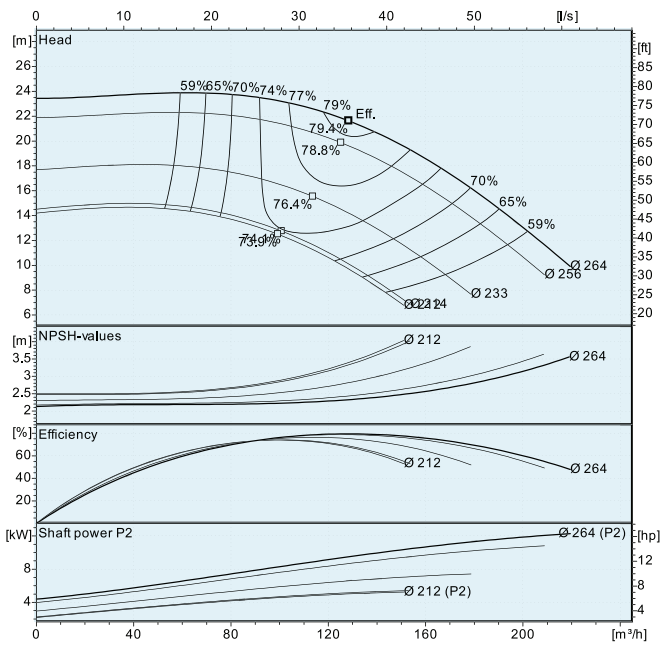

### EL4 100-400

### EL4 100-400B

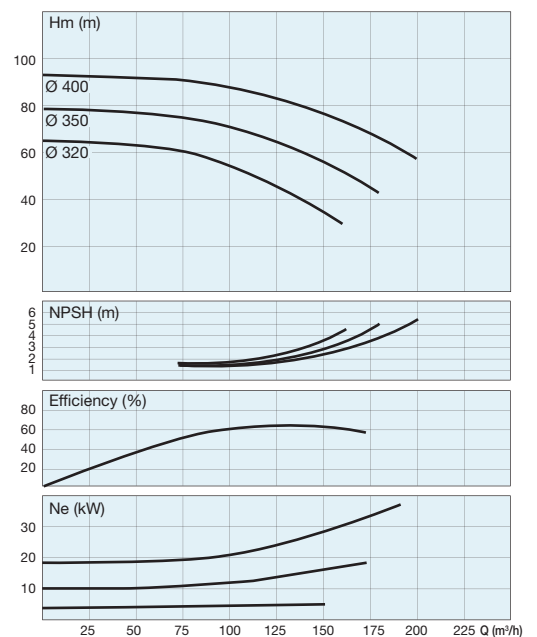
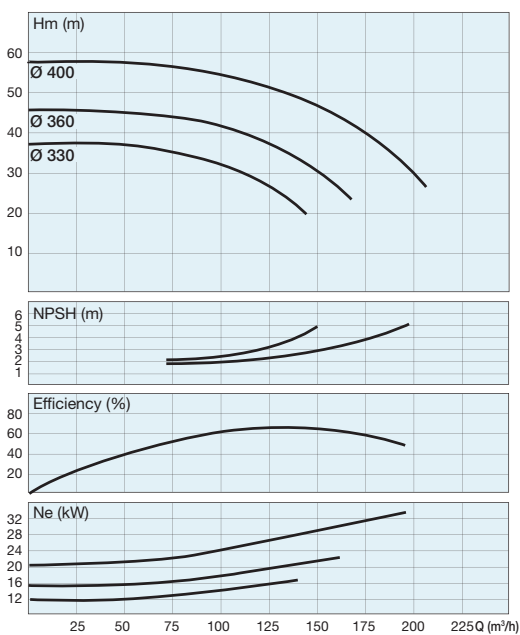

# EL4

## Horizontal, End-Suction Centrifugal Pumps

1450 1/min

### EL4 125-200

### EL4 125-250

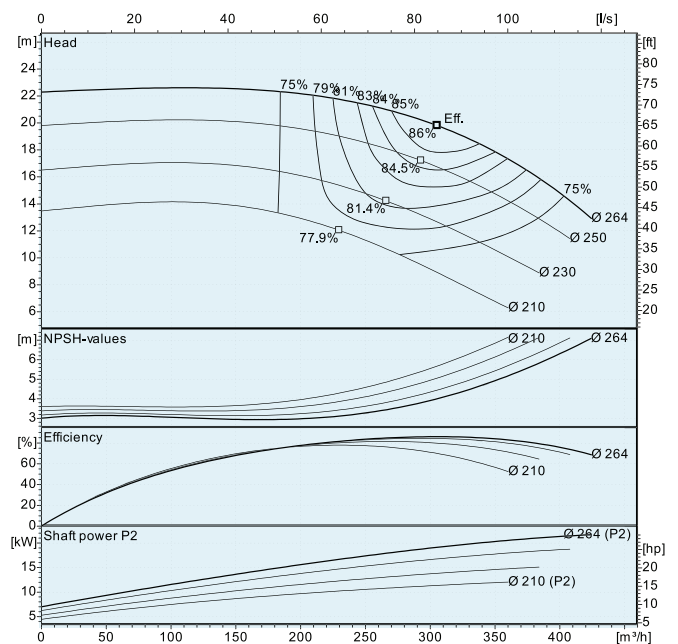
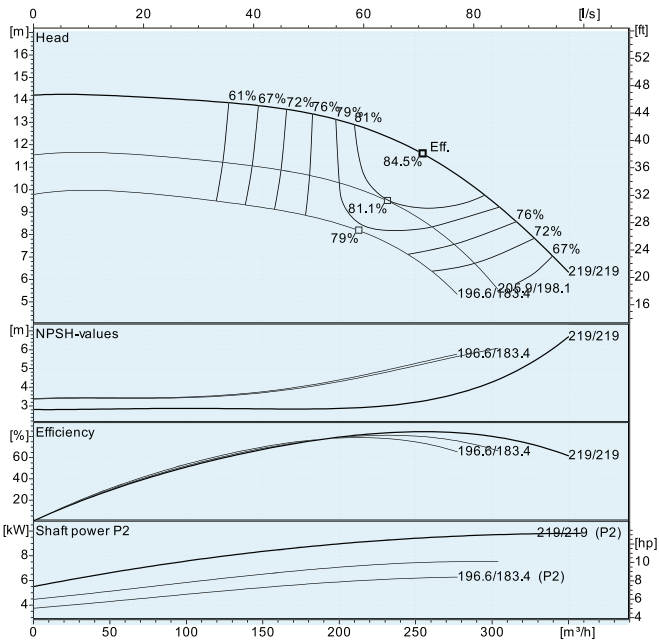

### EL4 125-315

### EL4 125-330

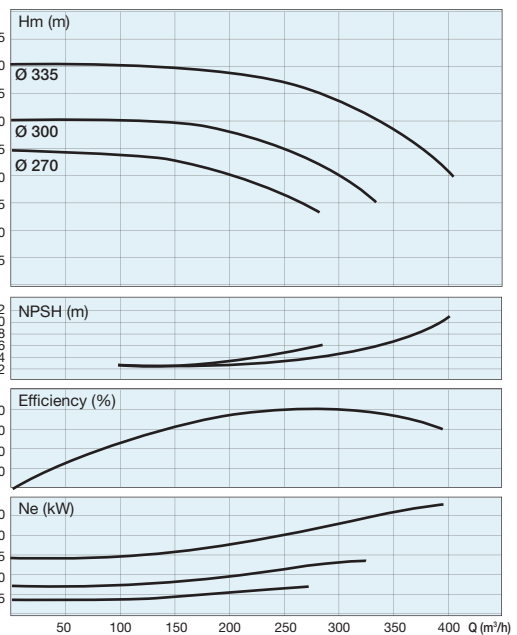
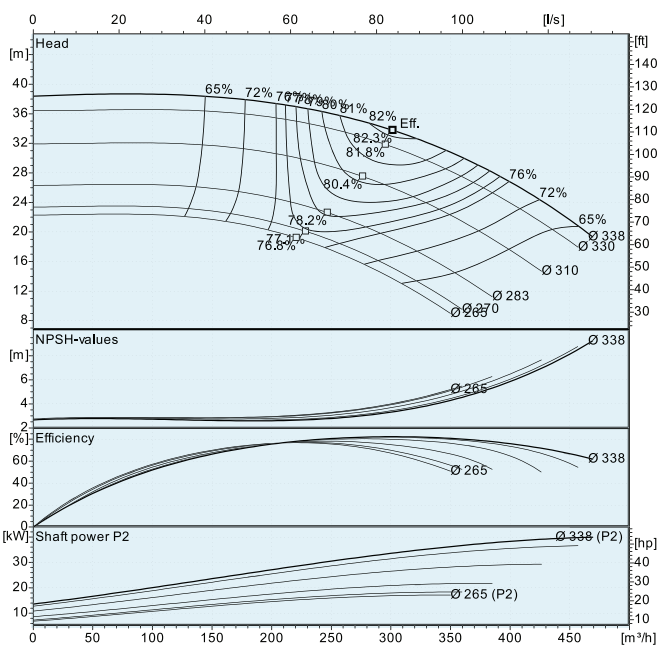

# EL4

## Horizontal, End-Suction Centrifugal Pumps

1450 1/min

### EL4 125-400

### EL4 125-400B

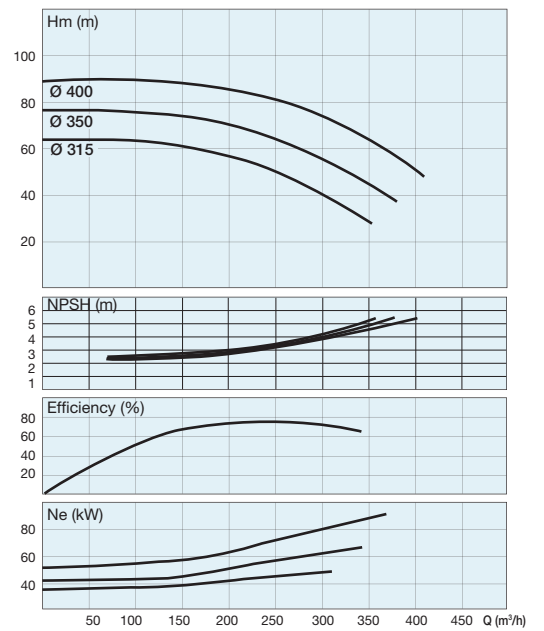
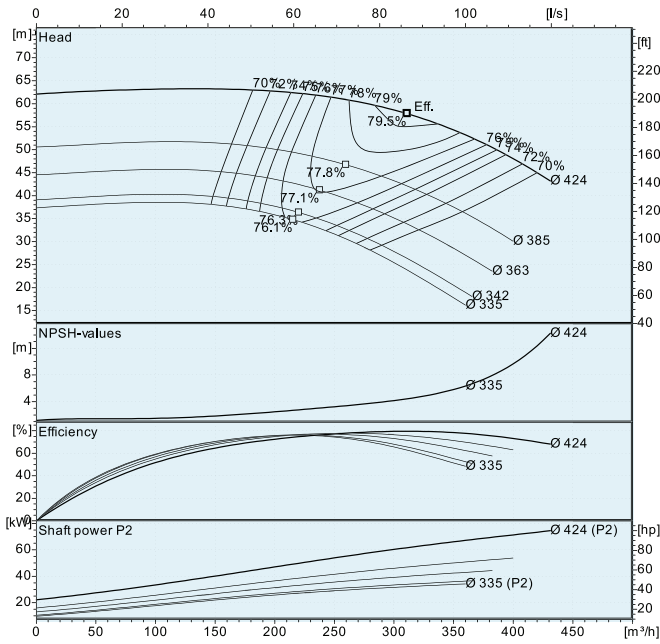

### EL4 150-200

### EL4 150-250

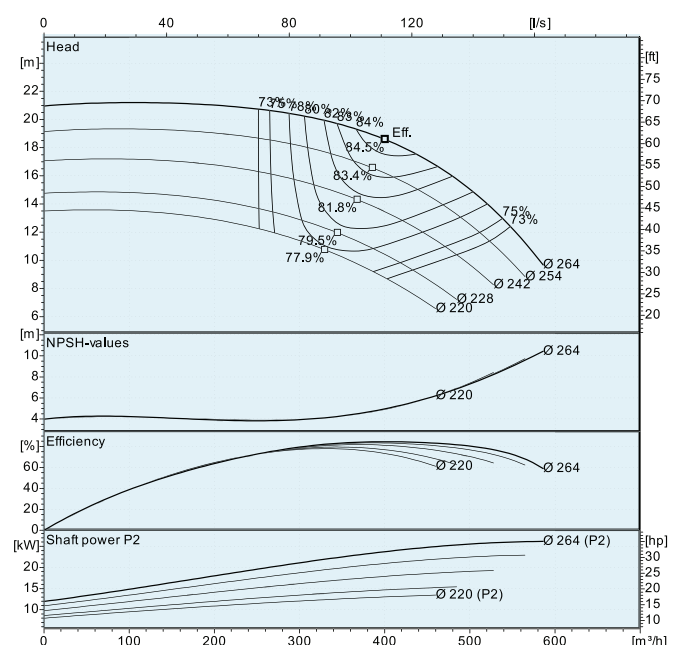
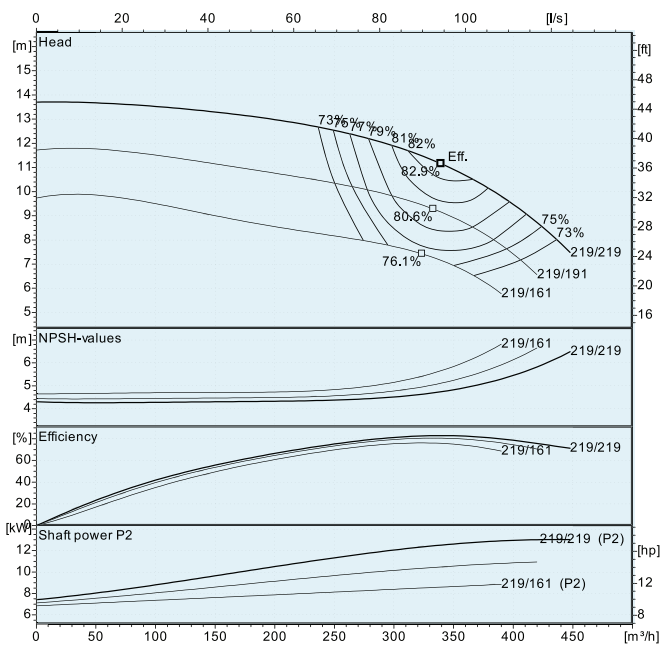

# EL4

## Horizontal, End-Suction Centrifugal Pumps

1450 1/min

### EL4 150-315

### EL4 150-330

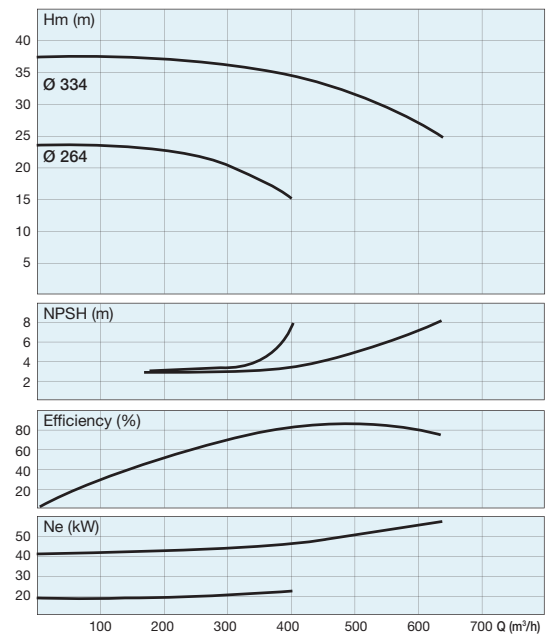
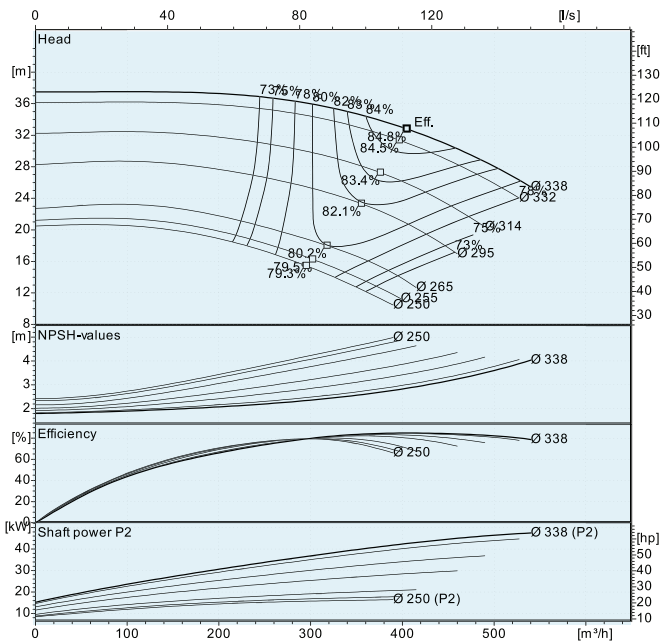

### EL4 150-400

### EL4 150-500

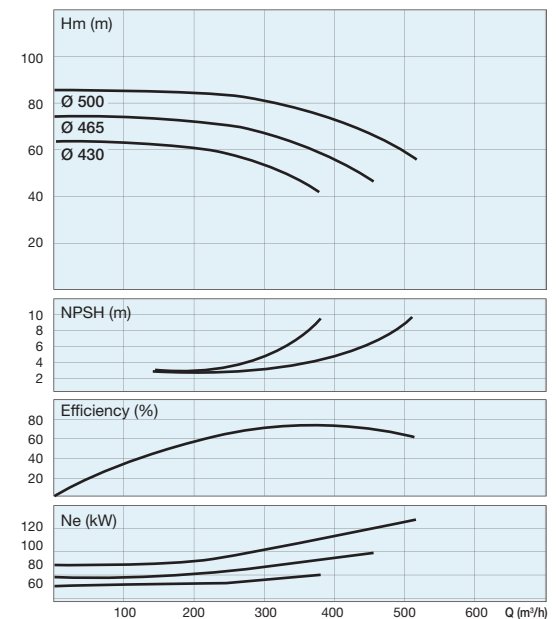
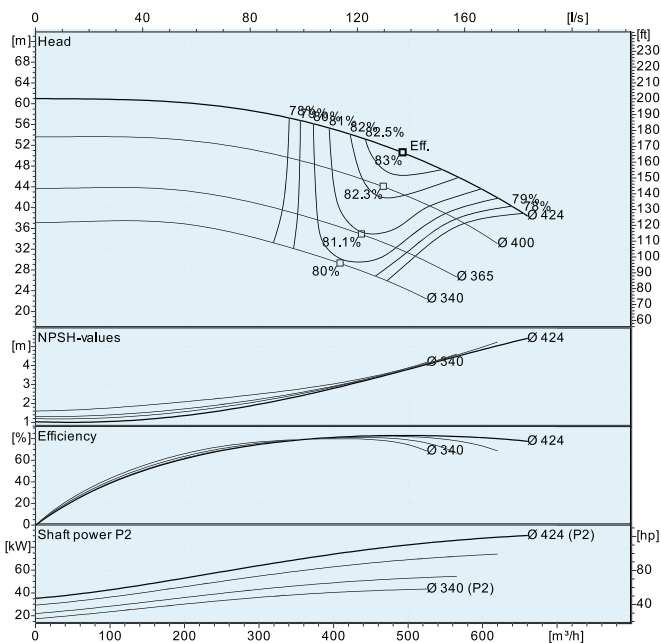



# EL4

## Horizontal, End-Suction Centrifugal Pumps

1450 1/min

### EL4 150-510

### EL4 150-560

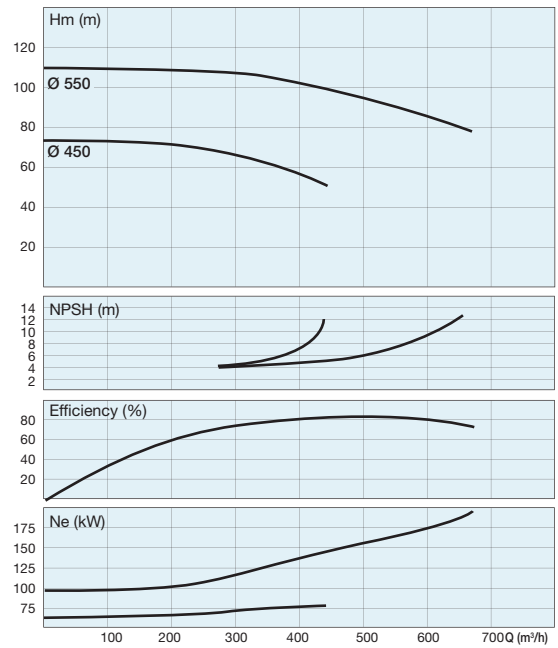
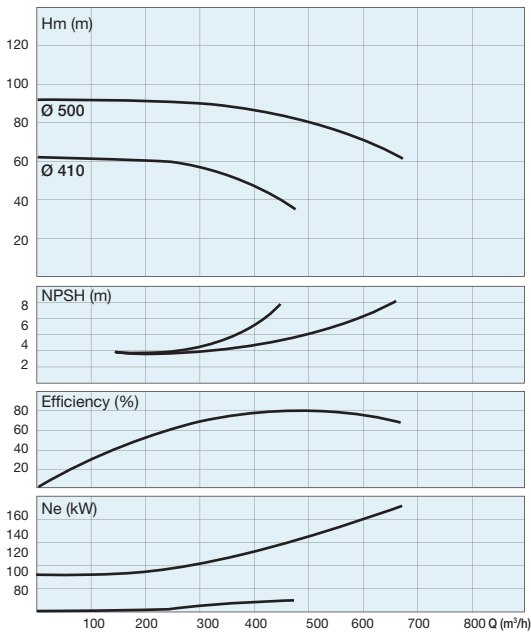

### EL4 200-260

### EL4 200-315

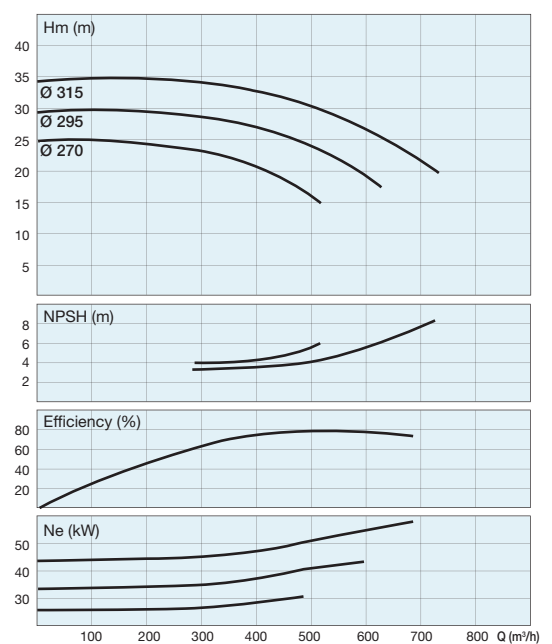
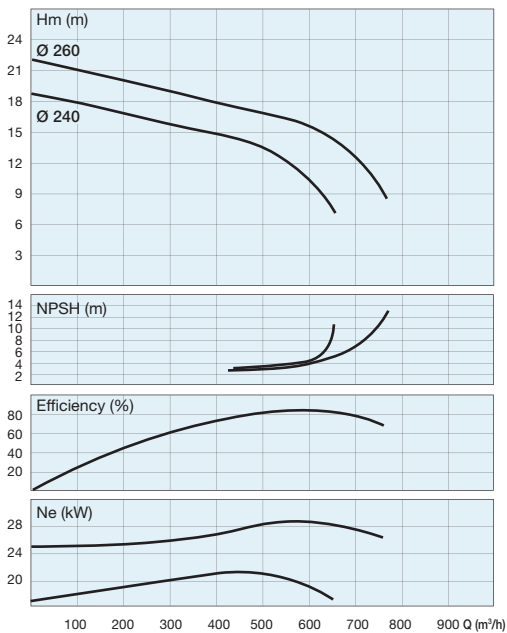

# EL4

## Horizontal, End-Suction Centrifugal Pumps

1450 1/min

### EL4 200-330

### EL4 200-400

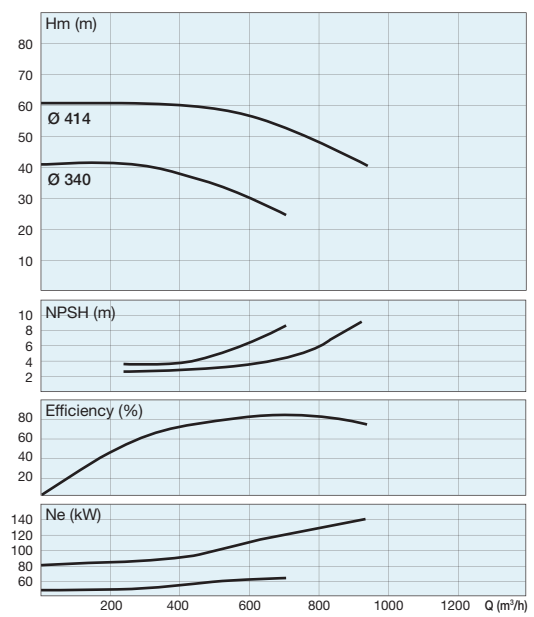
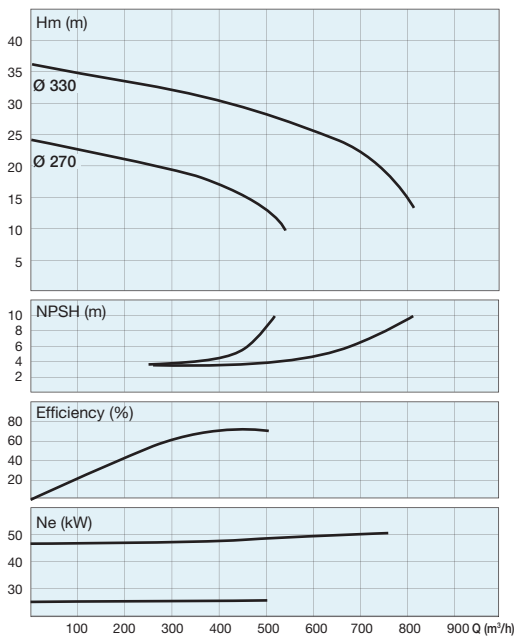

### EL4 200-500

### EL4 250-300

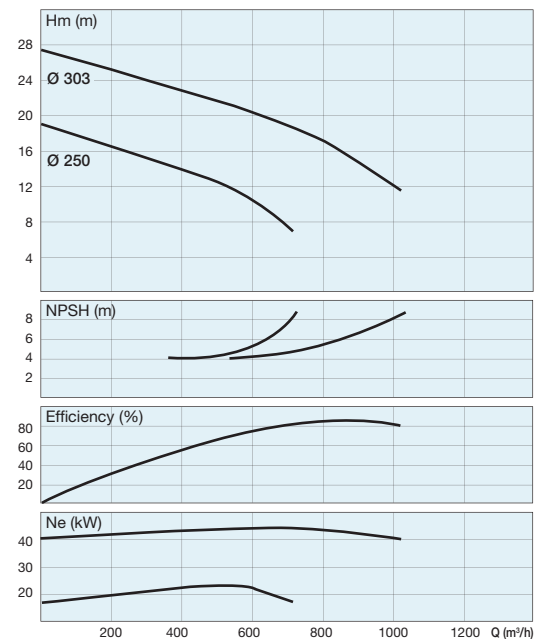
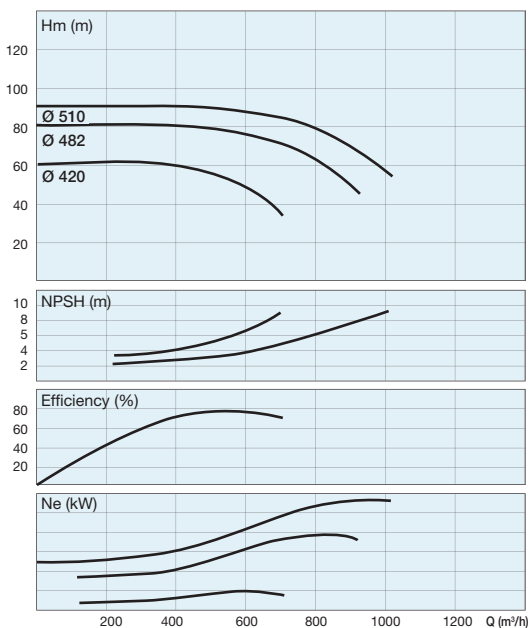

# EL4

## Horizontal, End-Suction Centrifugal Pumps

1450 1/min

### EL4 250-315

### EL4 250-400

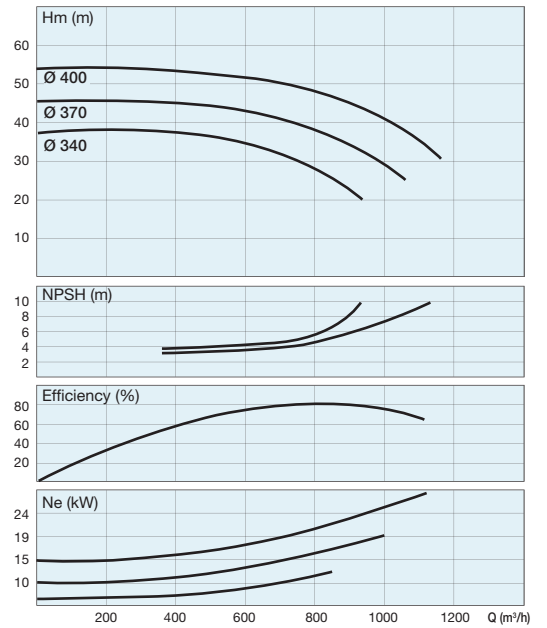
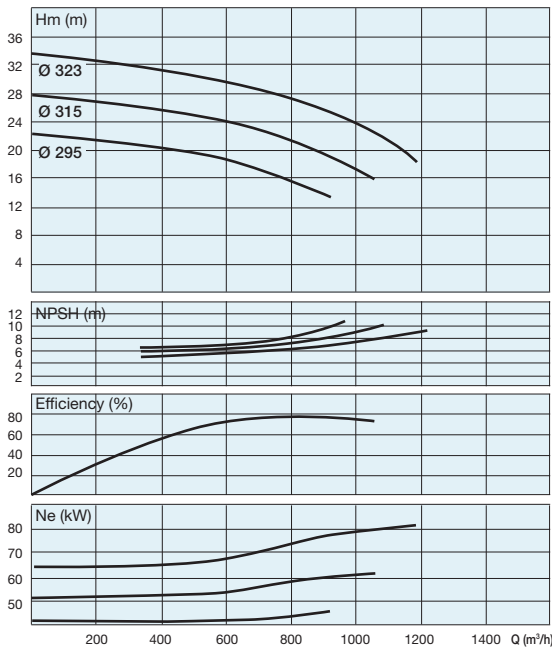

### EL4 250-450

### EL4 250-500

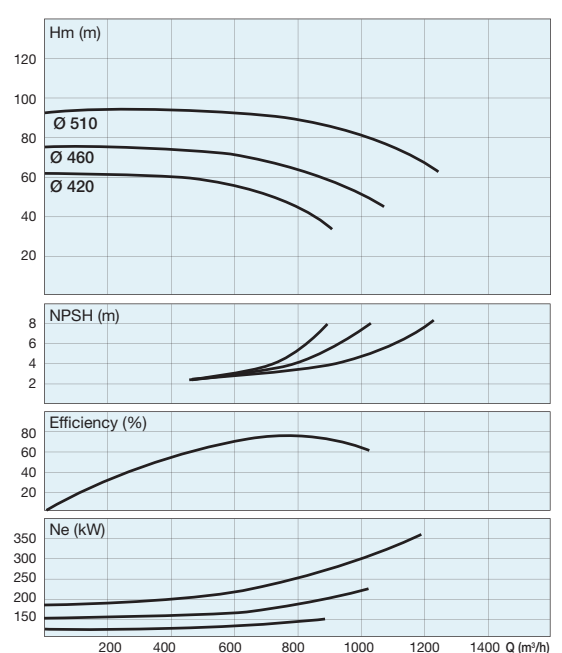
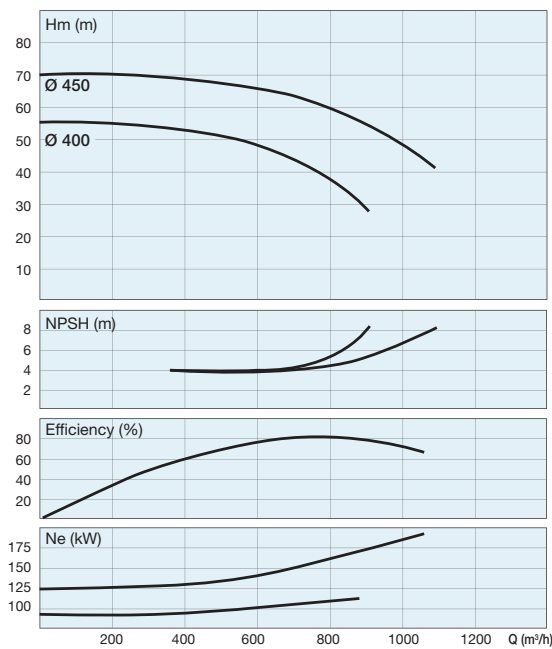

# EL4

## Horizontal, End-Suction Centrifugal Pumps

1450 1/min

### EL4 250-510

### EL4 300-315

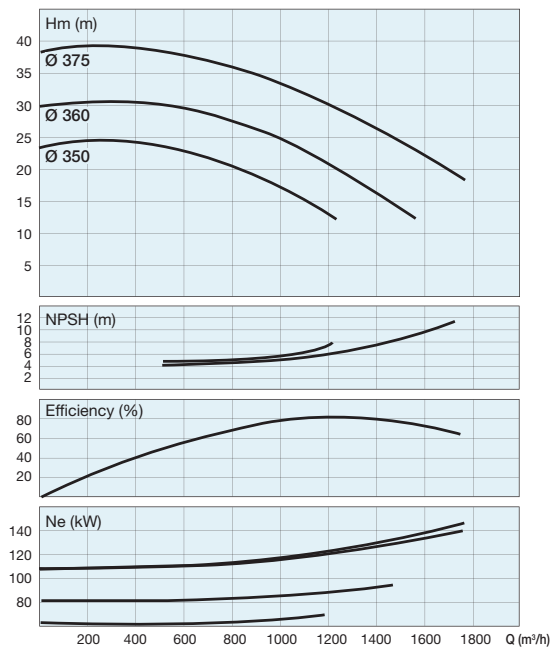
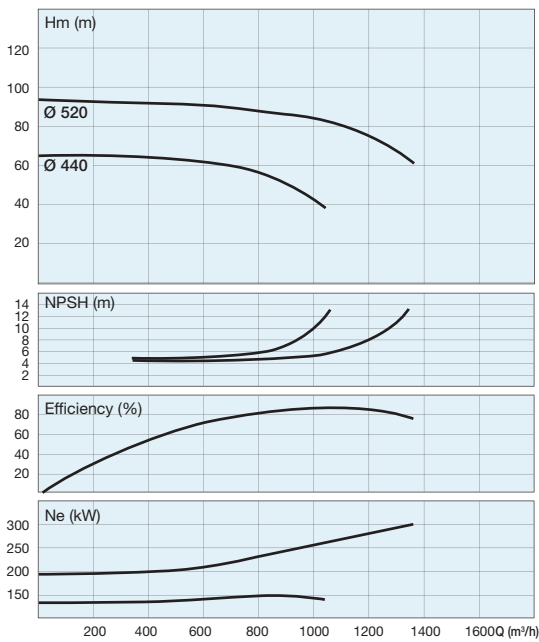

### EL4 300-360

### EL4 300-400

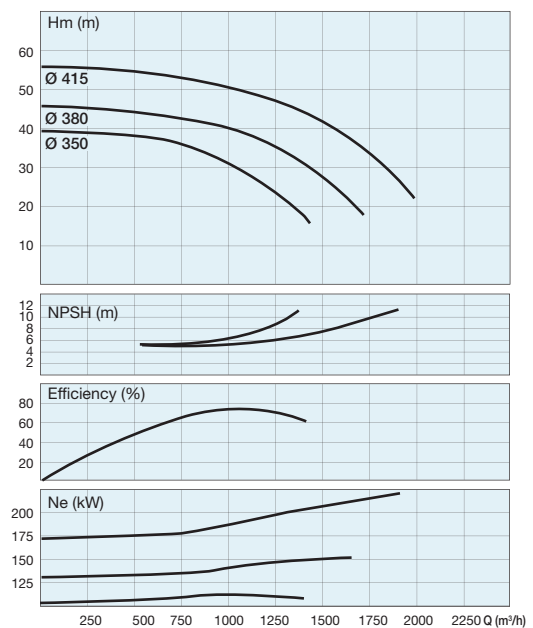
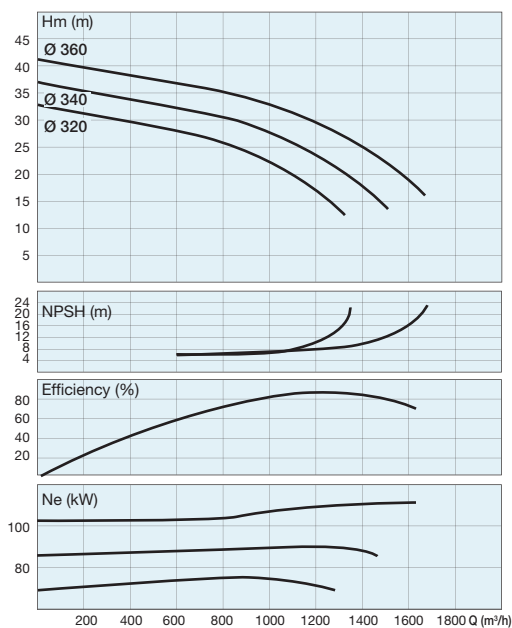

# EL4

## Horizontal, End-Suction Centrifugal Pumps

1450 1/min

### EL4 300-450

### EL4 300-500

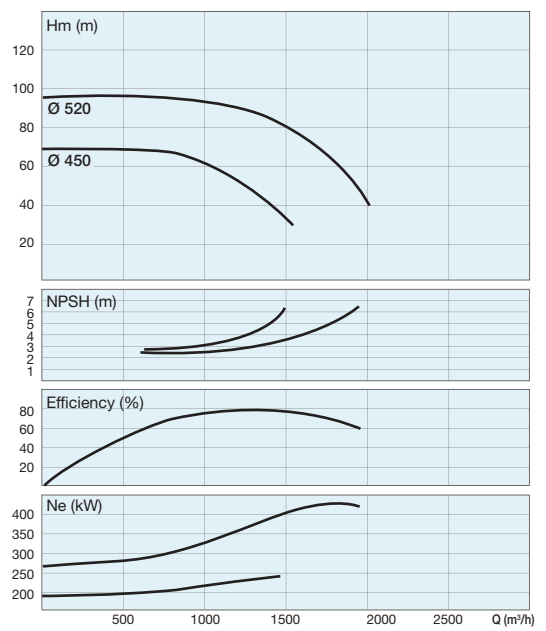
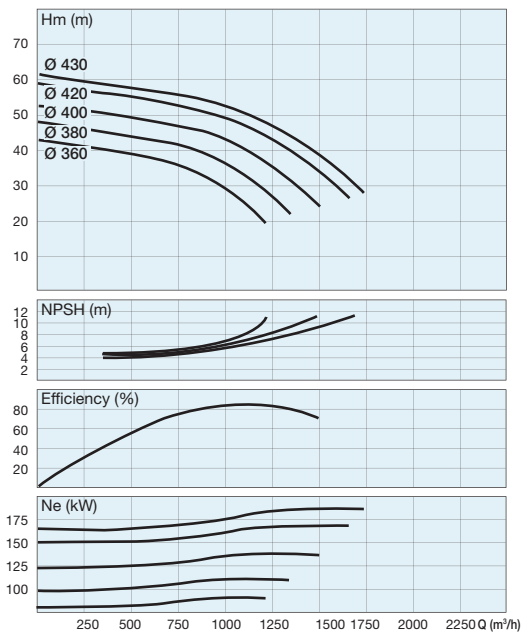

### EL4 300-560

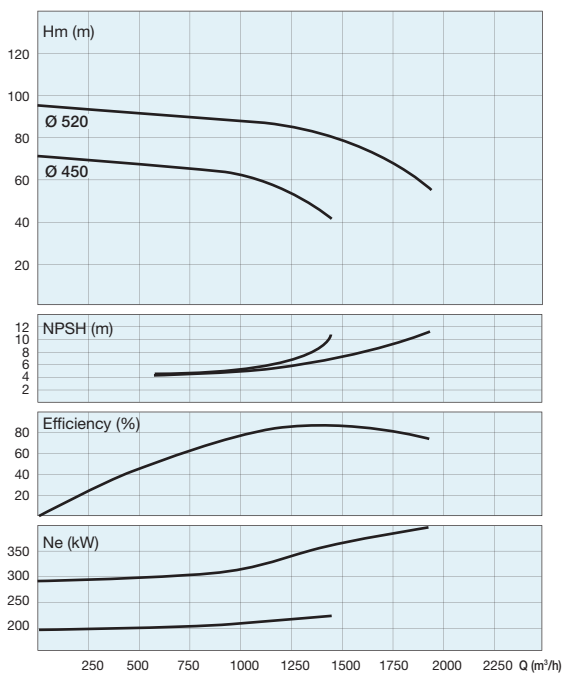

# EL6

## Horizontal, End-Suction Centrifugal Pumps

1000 1/min

### EL6 100-250

### EL6 100-400

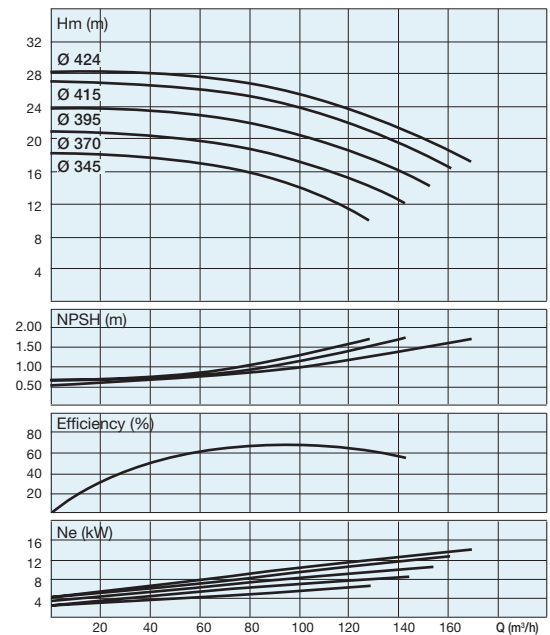
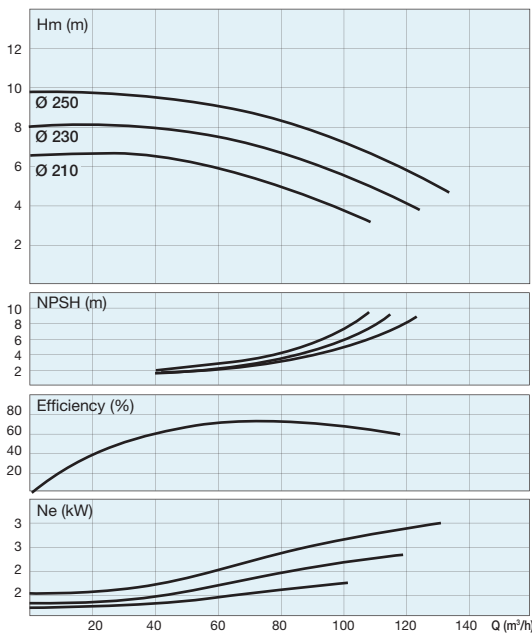

### EL6 125-315

### EL6 125-400

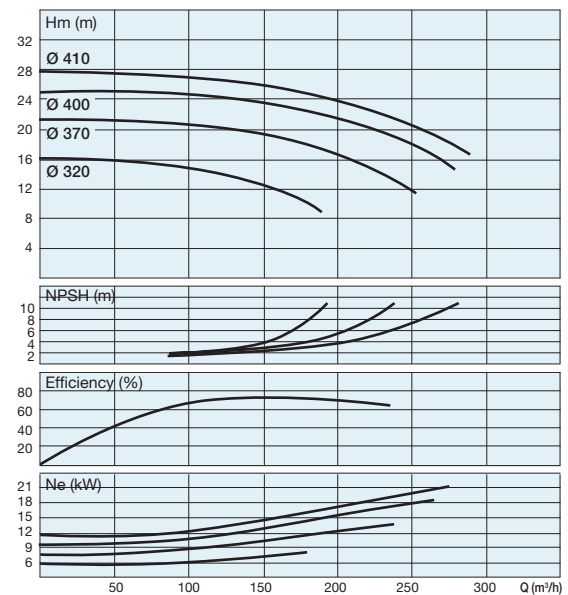
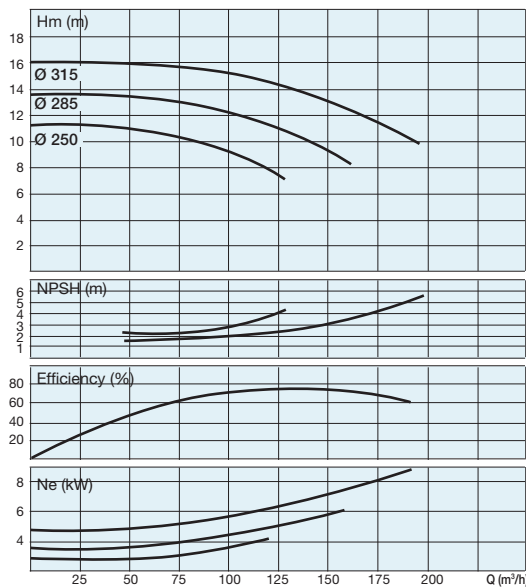

# EL6

## Horizontal, End-Suction Centrifugal Pumps

1000 1/min

### EL6 125-420

### EL6 150-315

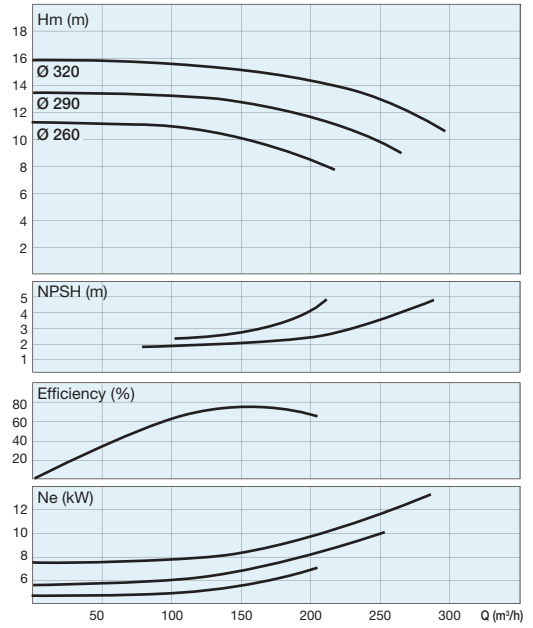
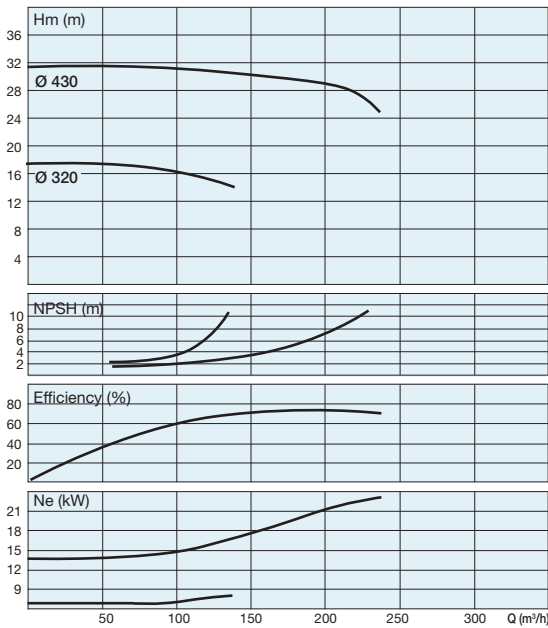

### EL6 150-400

### EL6 150-500

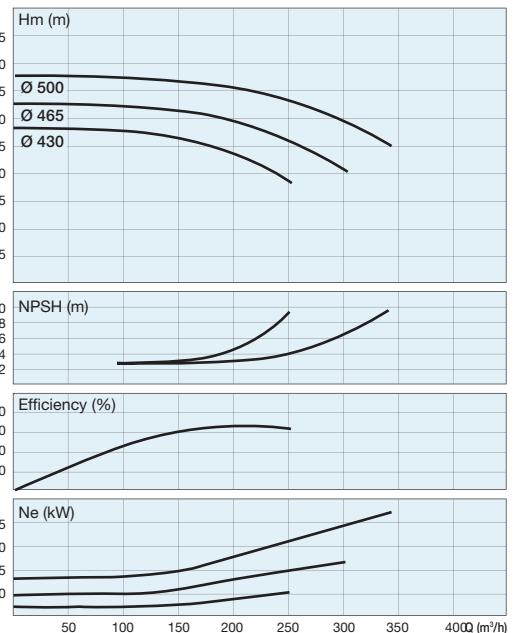
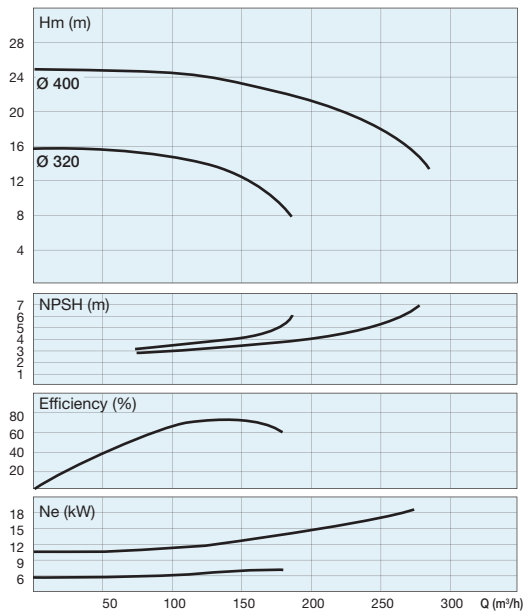

# EL6

## Horizontal, End-Suction Centrifugal Pumps

1000 1/min

### EL6 150-560

### EL6 200-260

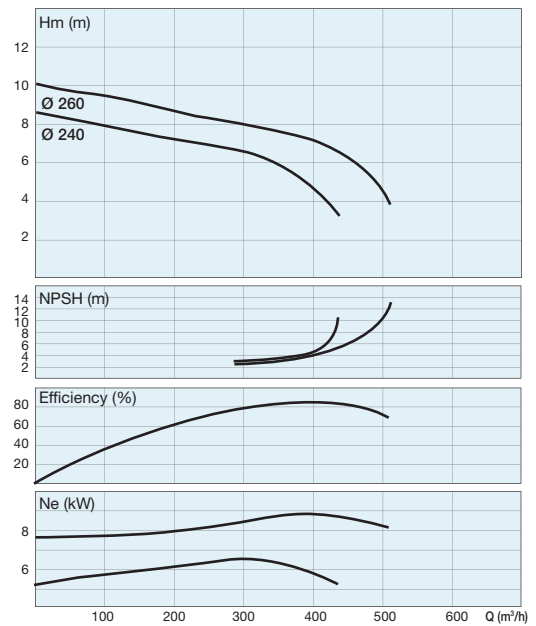
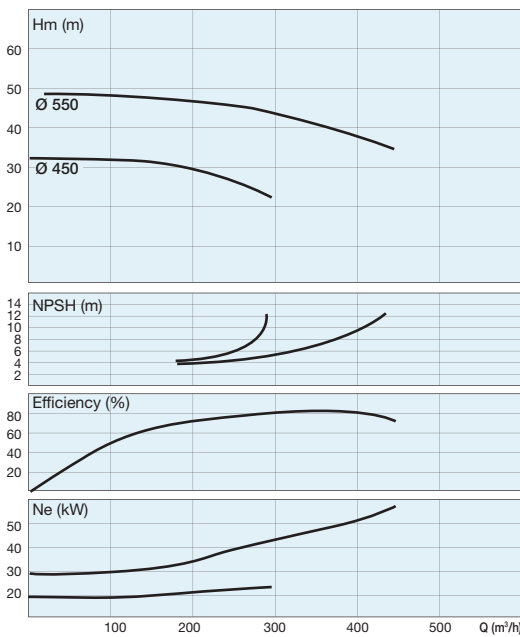

### EL6 200-315

### EL6 200-330

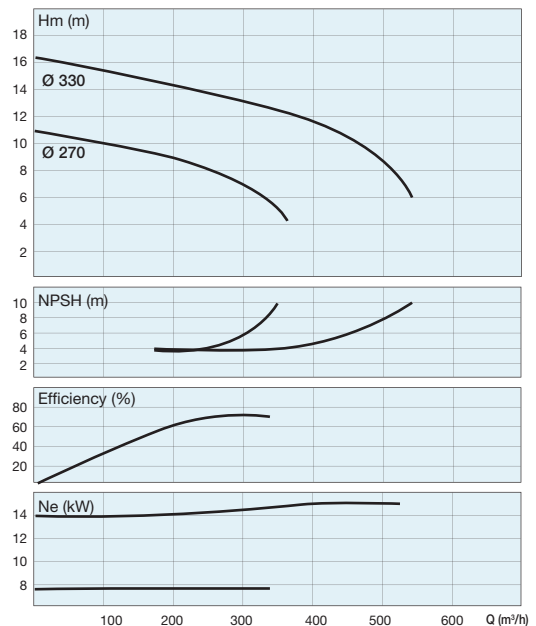
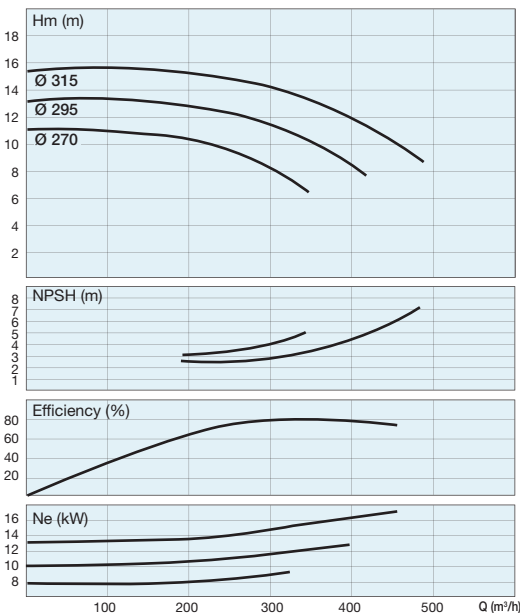



# EL6

## Horizontal, End-Suction Centrifugal Pumps

1000 1/min

### EL6 200-400

### EL6 200-500

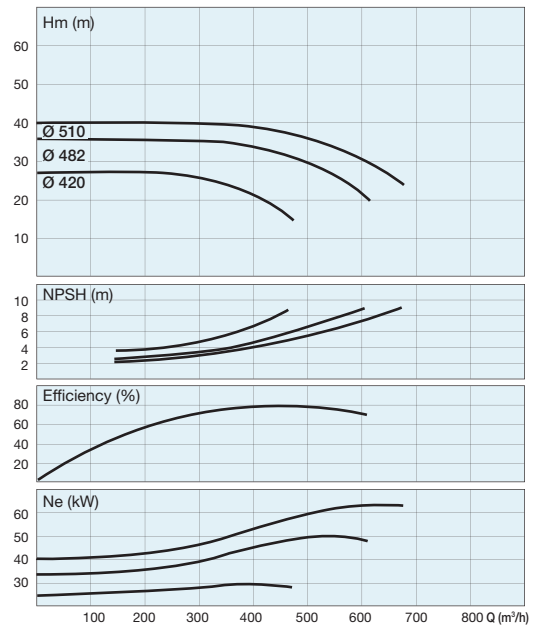
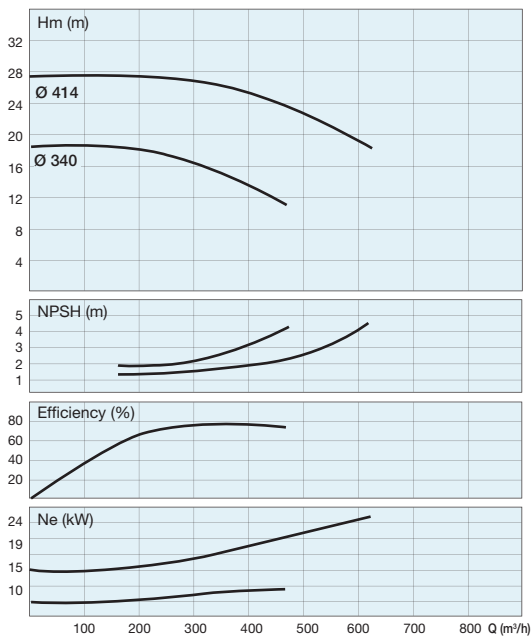

### EL6 250-300

### EL6 250-315

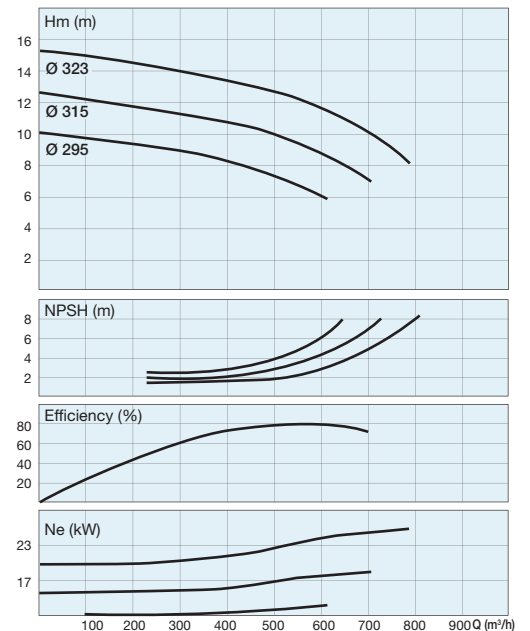
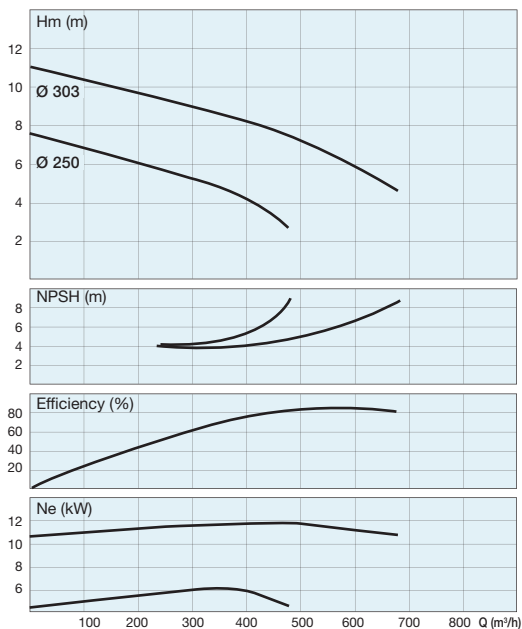

# EL6

## Horizontal, End-Suction Centrifugal Pumps

1000 1/min

**EL6 250-400**

**EL6 250-450**

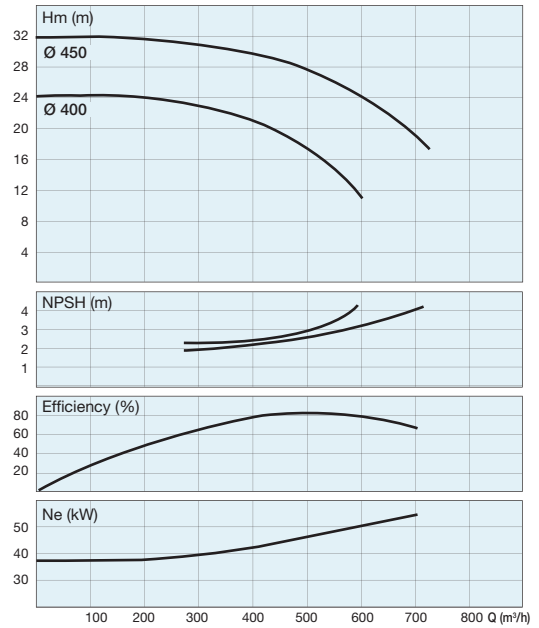
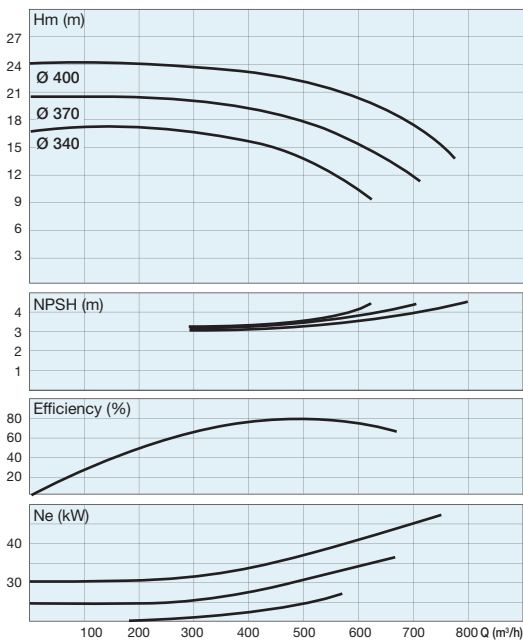

**EL6 250-500**

**EL6 300-315**

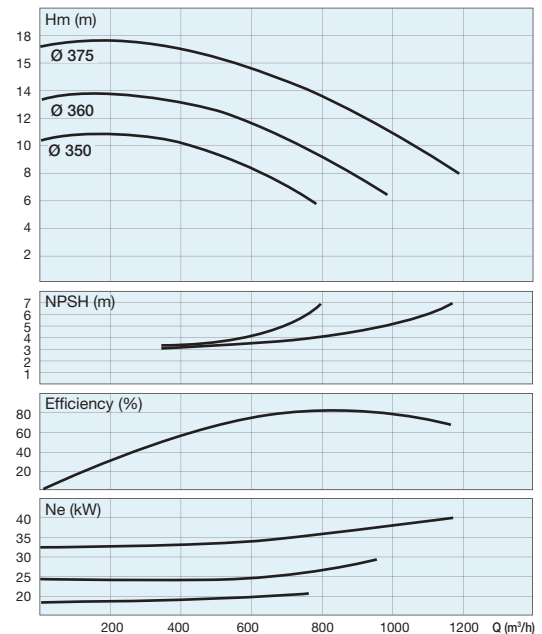
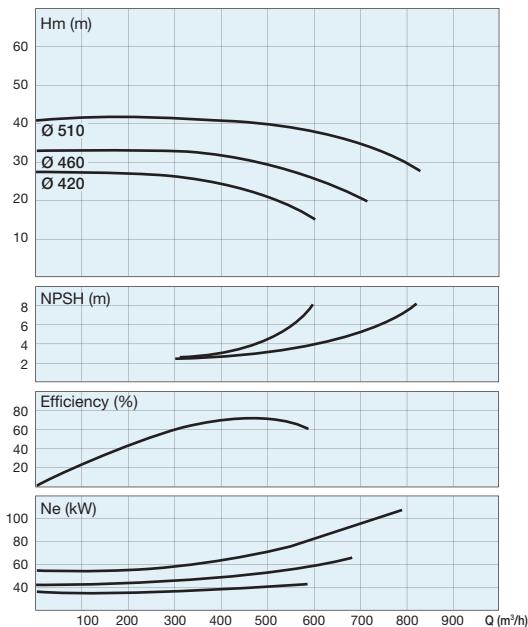

# EL6

## Horizontal, End-Suction Centrifugal Pumps

1000 1/min

### EL6 300-360

### EL6 300-400

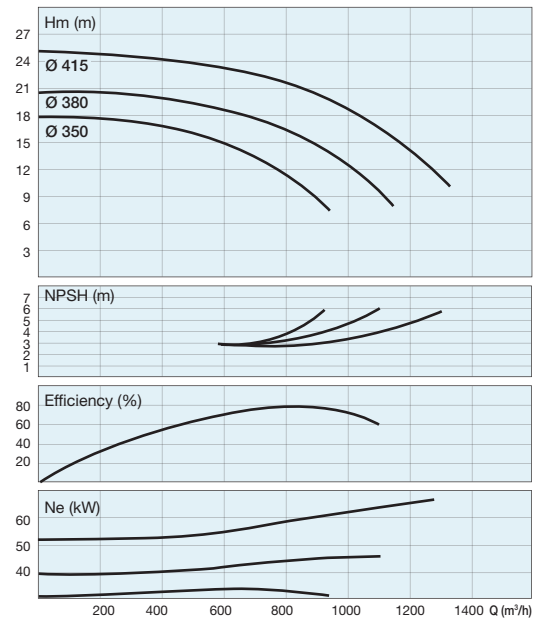
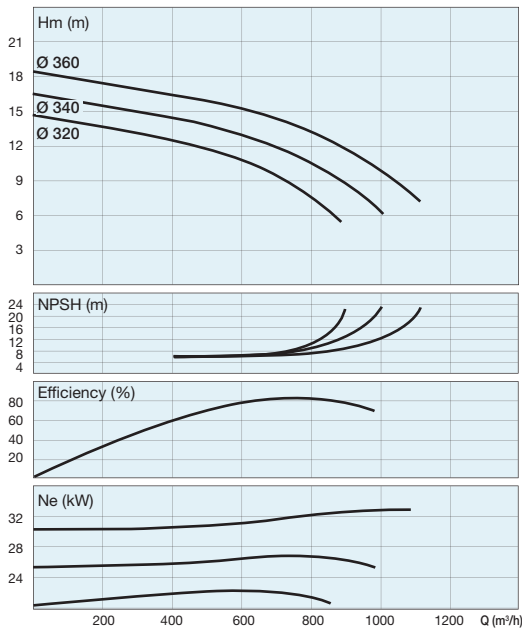

### EL6 300-500

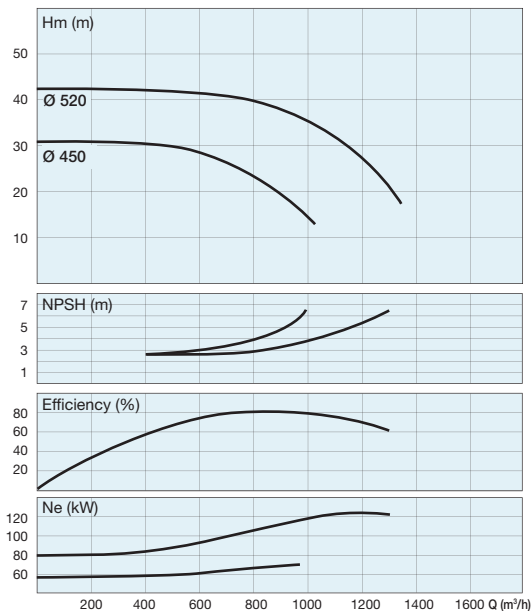

# EL

## Horizontal, End-Suction Centrifugal Pumps

### Dimensions

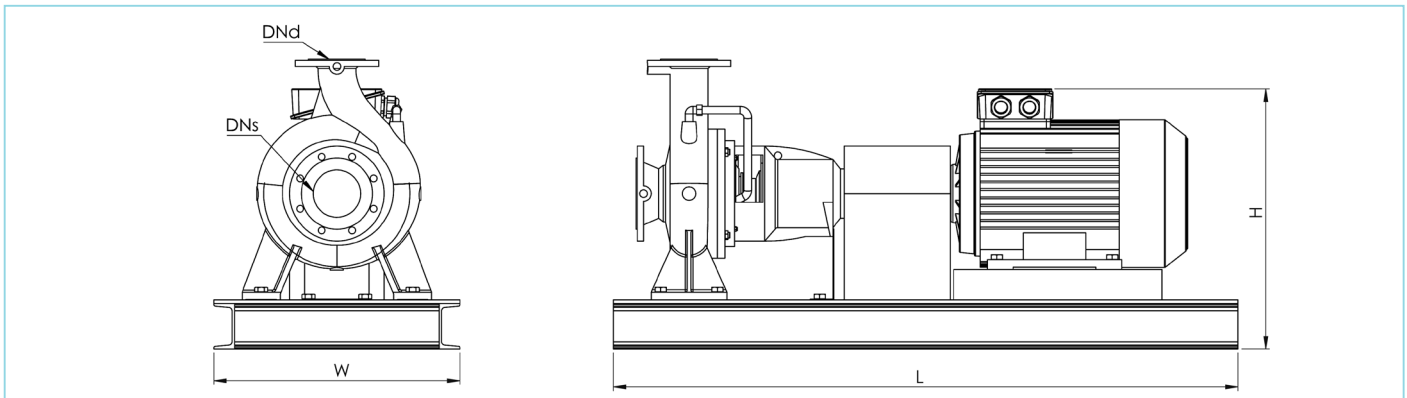

Pump Model	kW	rpm	DNs	DNd	kg	w	l	h
EL 32-125	1,5	3000	DN50	DN32	94,3 KG	500	950	300
EL 32-125	2,2	3000	DN50	DN32	96,5 KG	500	950	300
EL 32-125	3	3000	DN50	DN32	100,5 KG	500	1050	300
EL 32-125	4	3000	DN50	DN32	106,5 KG	500	1050	300
EL 32-160	2,2	3000	DN50	DN32	103,5 KG	500	950	300
EL 32-160	3	3000	DN50	DN32	107,5 KG	500	1050	300
EL 32-160	4	3000	DN50	DN32	113,5 KG	500	1050	300
EL 32-160	5,5	3000	DN50	DN32	126,5 KG	500	1100	300
EL 32-200	5,5	3000	DN50	DN32	128,5 KG	500	1100	400
EL 32-200	7,5	3000	DN50	DN32	134,5 KG	500	1100	400
EL 32-200	11	3000	DN50	DN32	184,5 KG	500	1250	500
EL 32-250	7,5	3000	DN50	DN32	146,5 KG	500	1100	500
EL 32-250	11	3000	DN50	DN32	196,5 KG	500	1250	500
EL 32-250	15	3000	DN50	DN32	206,5 KG	500	1250	500
EL 32-250	18,5	3000	DN50	DN32	225,5 KG	500	1300	500
EL 32-250	22	3000	DN50	DN32	270,2 KG	500	1300	500
EL 40-125	2,2	3000	DN65	DN40	97,5 KG	500	950	300
EL 40-125	3	3000	DN65	DN40	101,5 KG	500	1050	300
EL 40-125	4	3000	DN65	DN40	107,5 KG	500	1050	300
EL 40-125	5,5	3000	DN65	DN40	120,5 KG	500	1100	300
EL 40-160	4	3000	DN65	DN40	114,5 KG	500	1050	400
EL 40-160	5,5	3000	DN65	DN40	127,5 KG	500	1100	400
EL 40-160	7,5	3000	DN65	DN40	133,5 KG	500	1100	400
EL 40-200	7,5	3000	DN65	DN40	138,5 KG	500	1100	400
EL 40-200	11	3000	DN65	DN40	188,5 KG	500	1250	500
EL 40-200	15	3000	DN65	DN40	198,5 KG	500	1250	500
EL 40-200	18,5	3000	DN65	DN40	217,5 KG	500	1300	500
EL 40-250	15	3000	DN65	DN40	210,5 KG	500	1250	500
EL 40-250	18,5	3000	DN65	DN40	229,5 KG	500	1300	500
EL 40-250	22	3000	DN65	DN40	274,2 KG	500	1300	500
EL 40-250	30	3000	DN65	DN40	349,8 KG	550	1350	600
EL 40-315	22	3000	DN65	DN40	284,2 KG	500	1300	500
EL 40-315	30	3000	DN65	DN40	359,8 KG	550	1350	600

# EL

## Horizontal, End-Suction Centrifugal Pumps

### Dimensions

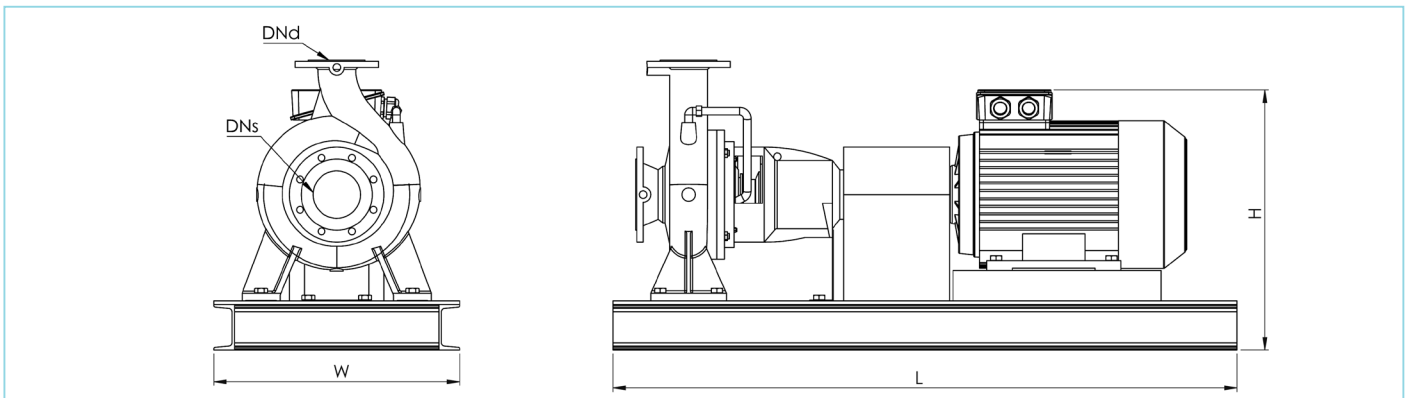

Pump Model	kW	rpm	DNs	DNd	kg	w	l	h
EL 40-315	37	3000	DN65	DN40	369,8 KG	550	1350	600
EL 40-315	45	3000	DN65	DN40	423,8 KG	600	1400	650
EL 50-125	3	3000	DN65	DN50	102,5 KG	500	1050	300
EL 50-125	4	3000	DN65	DN50	108,5 KG	500	1050	300
EL 50-125	5,5	3000	DN65	DN50	121,5 KG	500	1100	400
EL 50-125	7,5	3000	DN65	DN50	127,5 KG	500	1100	400
EL 50-160	5,5	3000	DN65	DN50	129,5 KG	500	1100	500
EL 50-160	7,5	3000	DN65	DN50	135,5 KG	500	1100	500
EL 50-160	11	3000	DN65	DN50	185,5 KG	500	1250	500
EL 50-160	15	3000	DN65	DN50	195,5 KG	500	1250	500
EL 50-200	11	3000	DN65	DN50	191,5 KG	500	1250	500
EL 50-200	15	3000	DN65	DN50	201,5 KG	500	1250	500
EL 50-200	18,5	3000	DN65	DN50	220,5 KG	500	1300	500
EL 50-200	22	3000	DN65	DN50	265,2 KG	500	1300	500
EL 50-250	18,5	3000	DN65	DN50	229,5 KG	500	1300	500
EL 50-250	22	3000	DN65	DN50	274,2 KG	500	1300	500
EL 50-250	30	3000	DN65	DN50	349,8 KG	550	1350	600
EL 50-250	37	3000	DN65	DN50	359,8 KG	550	1350	600
EL 50-315	11	3000	DN65	DN50	236,5 KG	500	1400	600
EL 50-315	15	3000	DN65	DN50	246,5 KG	500	1400	600
EL 50-315	18,5	3000	DN65	DN50	265,5 KG	500	1450	600
EL 50-315	22	3000	DN65	DN50	310,2 KG	500	1450	600
EL 50-315	30	3000	DN65	DN50	385,8 KG	550	1500	600
EL 50-315	37	3000	DN65	DN50	395,8 KG	550	1500	600
EL 50-315	45	3000	DN65	DN50	449,8 KG	600	1550	650
EL 65-125	5,5	3000	DN80	DN65	127,5 KG	500	1100	500
EL 65-125	7,5	3000	DN80	DN65	133,5 KG	500	1100	500
EL 65-125	11	3000	DN80	DN65	183,5 KG	500	1250	500
EL 65-160	7,5	3000	DN80	DN65	139,5 KG	500	1100	500
EL 65-160	11	3000	DN80	DN65	189,5 KG	500	1250	500
EL 65-160	15	3000	DN80	DN65	199,5 KG	500	1250	500
EL 65-200	15	3000	DN80	DN65	204,5 KG	500	1250	500
EL 65-200	18,5	3000	DN80	DN65	223,5 KG	500	1300	500
EL 65-200	22	3000	DN80	DN65	268,2 KG	500	1300	600

# EL

## Horizontal, End-Suction Centrifugal Pumps

### Dimensions

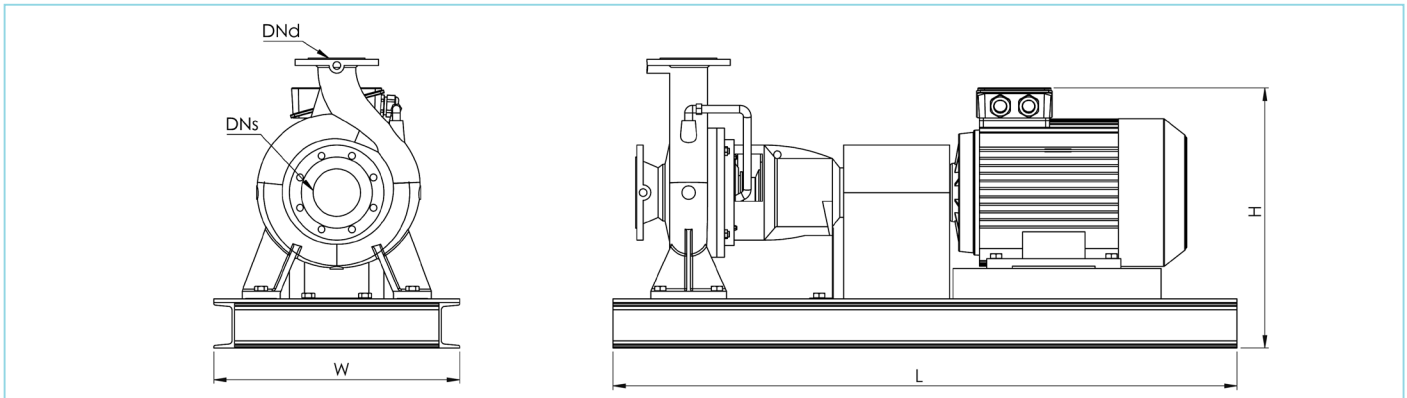

Pump Model	kW	rpm	DNs	DNd	kg	w	l	h
EL 65-200	30	3000	DN80	DN65	343,8 KG	550	1350	600
EL 65-250	30	3000	DN80	DN65	386,8 KG	550	1450	600
EL 65-250	37	3000	DN80	DN65	396,8 KG	550	1450	600
EL 65-250	45	3000	DN80	DN65	448,8 KG	600	1500	650
EL 65-250	55	3000	DN80	DN65	479,8 KG	650	1600	700
EL 65-315	22	3000	DN80	DN65	325,2 KG	500	1450	600
EL 65-315	30	3000	DN80	DN65	400,8 KG	550	1500	600
EL 65-315	37	3000	DN80	DN65	410,8 KG	550	1500	600
EL 65-315	45	3000	DN80	DN65	464,8 KG	600	1550	650
EL 65-315	55	3000	DN80	DN65	496,8 KG	650	1650	700
EL 65-315	75	3000	DN80	DN65	709,8 KG	700	1850	750
EL 80-160	11	3000	DN100	DN80	195,5 KG	500	1400	500
EL 80-160	15	3000	DN100	DN80	205,5 KG	500	1400	500
EL 80-160	18,5	3000	DN100	DN80	224,5 KG	500	1450	500
EL 80-160	22	3000	DN100	DN80	269,2 KG	500	1450	600
EL 80-160	30	3000	DN100	DN80	344,8 KG	550	1500	600
EL 80-200	22	3000	DN100	DN80	287,2 KG	500	1550	600
EL 80-200	30	3000	DN100	DN80	361,8 KG	550	1600	600
EL 80-200	37	3000	DN100	DN80	371,8 KG	550	1600	600
EL 80-200	45	3000	DN100	DN80	424,8 KG	600	1650	650
EL 80-250	37	3000	DN100	DN80	403,8 KG	550	1600	600
EL 80-250	45	3000	DN100	DN80	456,8 KG	600	1650	650
EL 80-250	55	3000	DN100	DN80	490,8 KG	650	1750	700
EL 80-250	75	3000	DN100	DN80	699,8 KG	700	1850	750
EL 80-250	90	3000	DN100	DN80	734,8 KG	700	1850	750
EL 80-315	37	3000	DN100	DN80	433,8 KG	550	1600	700
EL 80-315	45	3000	DN100	DN80	486,8 KG	600	1650	700
EL 80-315	55	3000	DN100	DN80	520,8 KG	650	1750	700
EL 80-315	75	3000	DN100	DN80	729,8 KG	700	1850	750
EL 80-315	90	3000	DN100	DN80	764,8 KG	700	1850	750
EL 80-315	110	3000	DN100	DN80	931,8 KG	800	2000	950
EL 80-315	132	3000	DN100	DN80	996,8 KG	800	2000	950
EL 100-160	22	3000	DN125	DN100	304,2 KG	500	1550	600
EL 100-160	30	3000	DN125	DN100	378,8 KG	550	1600	600

# EL4

## Horizontal, End-Suction Centrifugal Pumps

### Dimensions

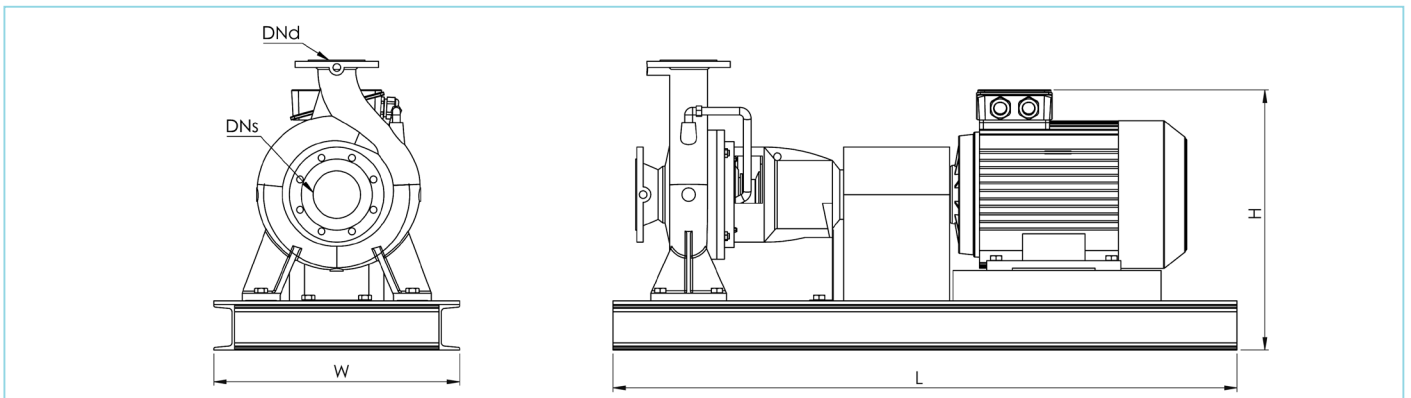

Pump Model	kW	rpm	DNs	DNd	kg	w	l	h
EL 100-160	37	3000	DN125	DN100	388,8 KG	550	1600	600
EL 100-200	30	3000	DN125	DN100	385,8 KG	550	1600	600
EL 100-200	37	3000	DN125	DN100	395,8 KG	550	1600	600
EL 100-200	45	3000	DN125	DN100	448,8 KG	600	1650	650
EL 100-200	55	3000	DN125	DN100	482,8 KG	650	1750	700
EL 100-250	45	3000	DN125	DN100	461,8 KG	600	1650	650
EL 100-250	55	3000	DN125	DN100	495,8 KG	650	1750	700
EL 100-250	75	3000	DN125	DN100	704,8 KG	700	1850	750
EL 100-250	90	3000	DN125	DN100	739,8 KG	700	1850	750
EL 100-315	55	3000	DN125	DN100	525,8 KG	650	1750	700
EL 100-315	75	3000	DN125	DN100	734,8 KG	700	1850	750
EL 100-315	90	3000	DN125	DN100	769,8 KG	700	1850	750
EL 100-315	110	3000	DN125	DN100	936,8 KG	800	2000	950
EL 100-315	132	3000	DN125	DN100	1001,8 KG	800	2000	950
EL 125-200	55	3000	DN150	DN125	492,8 KG	650	1750	700
EL 125-200	75	3000	DN150	DN125	701,8 KG	700	1850	750
EL 125-200	90	3000	DN150	DN125	736,8 KG	700	1850	750
EL 125-250	75	3000	DN150	DN125	714,8 KG	700	1850	750
EL 125-250	90	3000	DN150	DN125	749,8 KG	700	1850	750
EL 125-250	110	3000	DN150	DN125	916,8 KG	800	2000	950
EL 125-250	132	3000	DN150	DN125	981,8 KG	800	2000	950
EL 125-250	160	3000	DN150	DN125	1051,8 KG	800	2000	1000
EL 125-300	75	3000	DN150	DN125	716,8 KG	700	1900	750
EL 125-300	90	3000	DN150	DN125	751,8 KG	700	1900	750
EL 125-300	110	3000	DN150	DN125	918,8 KG	800	2050	950
EL 125-300	132	3000	DN150	DN125	983,8 KG	800	2050	950
EL 125-300	160	3000	DN150	DN125	1053,8 KG	800	2050	1000
EL 125-315	90	3000	DN150	DN125	821,8 KG	700	1900	750
EL 125-315	110	3000	DN150	DN125	988,8 KG	800	2050	950
EL 125-315	132	3000	DN150	DN125	1053,8 KG	800	2050	950
EL 125-315	200	3000	DN150	DN125	1266,8 KG	900	2100	1000
EL 150-315	132	3000	DN200	DN150	1055,8 KG	800	2100	950
EL 150-315	160	3000	DN200	DN150	1125,8 KG	800	2100	1000
EL 150-315	200	3000	DN200	DN150	1273,8 KG	900	2300	1000
EL 150-315	250	3000	DN200	DN150	1536,5 KG	900	2300	1150

# EL4

## Horizontal, End-Suction Centrifugal Pumps

### Dimensions

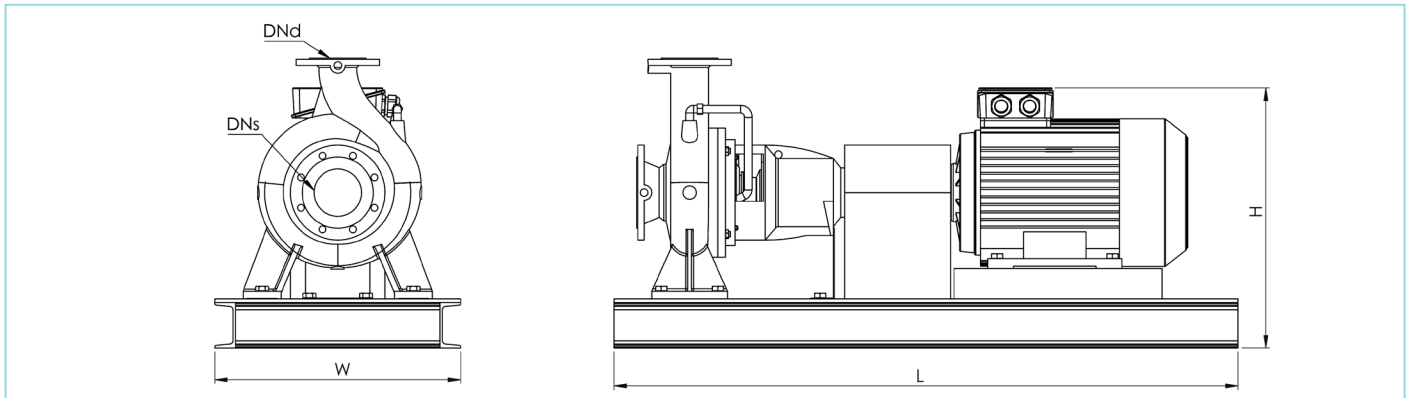

Pump Model	kW	rpm	DNs	DNd	kg	w	l	h
EL4 32-125	0,37	1450	DN50	DN32	88,6	500	900	250
EL4 32-125	0,55	1450	DN50	DN32	89,2	500	900	250
EL4 32-160	0,37	1450	DN50	DN32	95,6	500	900	250
EL4 32-160	0,55	1450	DN50	DN32	96,2	500	900	250
EL4 32-200	0,55	1450	DN50	DN32	98,2	500	900	250
EL4 32-200	0,75	1450	DN50	DN32	102,2	500	950	300
EL4 32-200	1,1	1450	DN50	DN32	104,3	500	950	300
EL4 32-250	1,1	1450	DN50	DN32	116,3	500	950	300
EL4 32-250	1,5	1450	DN50	DN32	119,3	500	950	300
EL4 32-250	2,2	1450	DN50	DN32	121,3	500	950	300
EL4 32-250	3	1450	DN50	DN32	128,8	500	1050	300
EL4 40-125	0,37	1450	DN65	DN40	89,6	500	900	300
EL4 40-125	0,55	1450	DN65	DN40	90,2	500	900	300
EL4 40-160	0,55	1450	DN65	DN40	97,2	500	900	300
EL4 40-160	0,75	1450	DN65	DN40	101,2	500	950	300
EL4 40-160	1,1	1450	DN65	DN40	103,3	500	950	300
EL4 40-200	1,1	1450	DN65	DN40	108,3	500	950	300
EL4 40-200	1,5	1450	DN65	DN40	111,3	500	950	400
EL4 40-200	2,2	1450	DN65	DN40	113,3	500	950	400
EL4 40-250	2,2	1450	DN65	DN40	125,3	500	950	400
EL4 40-250	3	1450	DN65	DN40	132,8	500	1050	400
EL4 40-250	4	1450	DN65	DN40	138,8	500	1050	400
EL4 40-315	3	1450	DN65	DN40	142,8	500	1050	450
EL4 40-315	4	1450	DN65	DN40	148,8	500	1050	450
EL4 40-315	5,5	1450	DN65	DN40	164,8	500	1100	450
EL4 40-315	7,5	1450	DN65	DN40	164,8	500	1100	450
EL4 50-125	0,55	1450	DN65	DN50	91,2	500	900	250
EL4 50-125	0,75	1450	DN65	DN50	95,2	500	900	300
EL4 50-125	1,1	1450	DN65	DN50	97,3	500	950	300
EL4 50-160	0,75	1450	DN65	DN50	103,2	500	950	300
EL4 50-160	1,1	1450	DN65	DN50	105,3	500	950	300
EL4 50-160	1,5	1450	DN65	DN50	108,3	500	950	300
EL4 50-160	2,2	1450	DN65	DN50	110,3	500	950	300
EL4 50-200	1,5	1450	DN65	DN50	114,3	500	950	400



# EL4

## Horizontal, End-Suction Centrifugal Pumps

### Dimensions

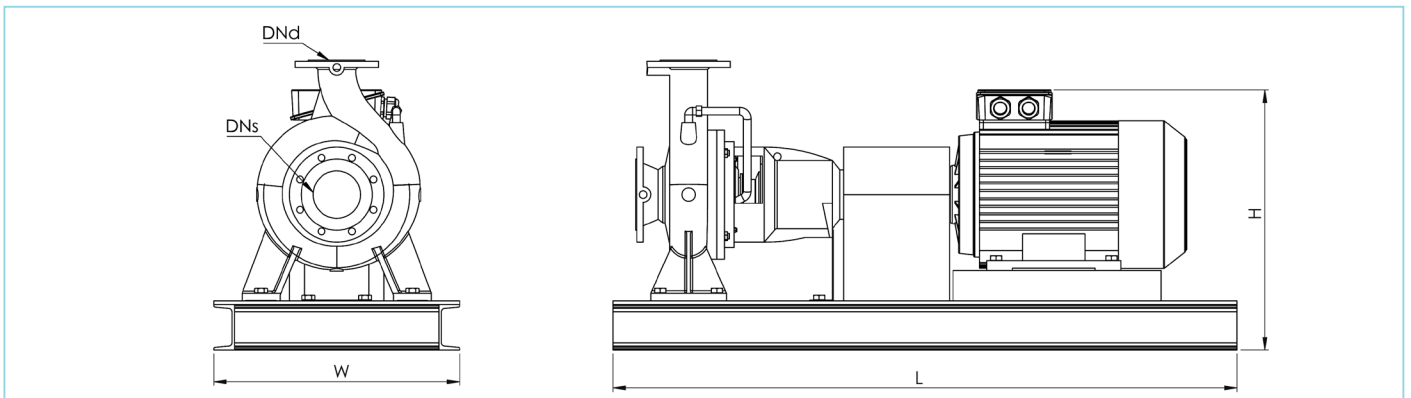

Pump Model	kW	rpm	DNs	DNd	kg	w	l	h
EL4 50-200	2,2	1450	DN65	DN50	116,3	500	950	400
EL4 50-200	3	1450	DN65	DN50	123,8	500	1050	400
EL4 50-250	2,2	1450	DN65	DN50	125,3	500	950	400
EL4 50-250	3	1450	DN65	DN50	132,8	500	1050	400
EL4 50-250	4	1450	DN65	DN50	138,8	500	1050	450
EL4 50-250	5,5	1450	DN65	DN50	162,8	500	1100	450
EL4 50-315	5,5	1450	DN65	DN50	199,8	500	1300	500
EL4 50-315	7,5	1450	DN65	DN50	207,8	500	1300	500
EL4 50-315	11	1450	DN65	DN50	262,8	500	1400	550
EL4 65-125	0,75	1450	DN80	DN65	101,2	500	950	300
EL4 65-125	1,1	1450	DN80	DN65	103,3	500	950	350
EL4 65-160	1,1	1450	DN80	DN65	109,3	500	950	350
EL4 65-160	1,5	1450	DN80	DN65	112,3	500	950	400
EL4 65-160	2,2	1450	DN80	DN65	114,3	500	950	400
EL4 65-200	1,5	1450	DN80	DN65	117,3	500	950	400
EL4 65-200	2,2	1450	DN80	DN65	119,3	500	950	400
EL4 65-200	3	1450	DN80	DN65	126,8	500	1050	400
EL4 65-200	4	1450	DN80	DN65	132,8	500	1050	450
EL4 65-250	3	1450	DN80	DN65	169,8	500	1200	450
EL4 65-250	4	1450	DN80	DN65	175,8	500	1200	450
EL4 65-250	5,5	1450	DN80	DN65	198,8	500	1250	450
EL4 65-250	7,5	1450	DN80	DN65	206,8	500	1250	450
EL4 65-315	5,5	1450	DN80	DN65	213,8	500	1250	500
EL4 65-315	7,5	1450	DN80	DN65	221,8	500	1250	500
EL4 65-315	11	1450	DN80	DN65	291,8	500	1400	550
EL4 65-315	15	1450	DN80	DN65	311,8	500	1400	550
EL4 65-400	15	1450	DN80	DN65	336,8	500	1400	550
EL4 65-400	18,5	1450	DN80	DN65	366,8	500	1450	550
EL4 65-400	22	1450	DN80	DN65	383,2	500	1450	600
EL4 65-400	30	1450	DN80	DN65	429,8	550	1500	600
EL4 80-160	1,5	1450	DN100	DN80	115,3	500	1000	400
EL4 80-160	2,2	1450	DN100	DN80	117,3	500	1000	400
EL4 80-160	3	1450	DN100	DN80	125,8	500	1100	400
EL4 80-200	3	1450	DN100	DN80	142,8	500	1200	400

# EL4

## Horizontal, End-Suction Centrifugal Pumps

### Dimensions

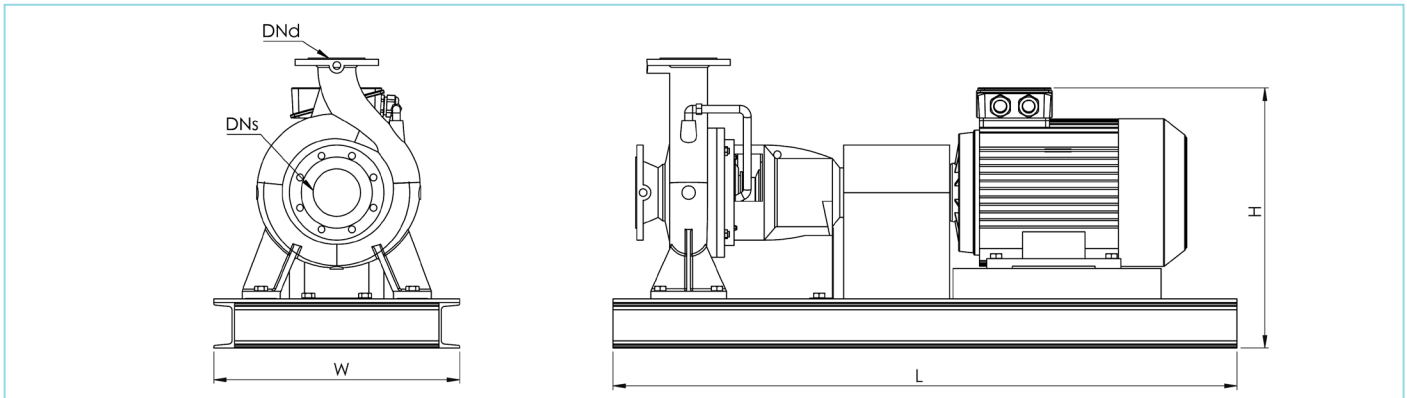

Pump Model	kW	rpm	DNs	DNd	kg	w	l	h
EL4 80-200	4	1450	DN100	DN80	148,8	500	1200	400
EL4 80-200	5,5	1450	DN100	DN80	171,8	500	1250	450
EL4 80-250	4	1450	DN100	DN80	180,8	500	1200	450
EL4 80-250	5,5	1450	DN100	DN80	203,8	500	1250	450
EL4 80-250	7,5	1450	DN100	DN80	211,8	500	1250	450
EL4 80-250	11	1450	DN100	DN80	281,8	500	1400	500
EL4 80-315	11	1450	DN100	DN80	311,8	500	1400	550
EL4 80-315	15	1450	DN100	DN80	331,8	500	1400	550
EL4 80-315	18,5	1450	DN100	DN80	361,8	500	1450	600
EL4 80-315B	11	1450	DN100	DN80	311,8	500	1400	550
EL4 80-315B	15	1450	DN100	DN80	331,8	500	1400	550
EL4 80-315B	18,5	1450	DN100	DN80	361,8	500	1450	600
EL4 80-400	18,5	1450	DN100	DN80	411,8	500	1500	650
EL4 80-400	22	1450	DN100	DN80	428,2	500	1500	700
EL4 80-400	30	1450	DN100	DN80	480,2	550	1600	700
EL4 80-400	37	1450	DN100	DN80	569,2	550	1600	700
EL4 80-400	45	1450	DN100	DN80	590,2	600	1700	700
EL4 100-160	3	1450	DN125	DN100	156,8	500	1100	400
EL4 100-160	4	1450	DN125	DN100	165,8	500	1200	400
EL4 100-200	4	1450	DN125	DN100	172,8	500	1200	450
EL4 100-200	5,5	1450	DN125	DN100	195,8	500	1250	500
EL4 100-200	7,5	1450	DN125	DN100	203,8	500	1250	500
EL4 100-250	5,5	1450	DN125	DN100	208,8	500	1250	500
EL4 100-250	7,5	1450	DN125	DN100	216,8	500	1250	500
EL4 100-250	11	1450	DN125	DN100	286,8	500	1400	550
EL4 100-250	15	1450	DN125	DN100	306,8	500	1400	550
EL4 100-315	15	1450	DN125	DN100	336,8	500	1400	600
EL4 100-315	18,5	1450	DN125	DN100	366,8	500	1450	650
EL4 100-315	22	1450	DN125	DN100	383,2	500	1500	650
EL4 100-315	30	1450	DN125	DN100	436,2	550	1600	650
EL4 100-400	11	1450	DN125	DN100	371,8	600	1450	500
EL4 100-400	15	1450	DN125	DN100	391,8	600	1450	500
EL4 100-400	18,5	1450	DN125	DN100	422,8	600	1500	550
EL4 100-400	22	1450	DN125	DN100	439,2	600	1500	600

# EL4

## Horizontal, End-Suction Centrifugal Pumps

### Dimensions

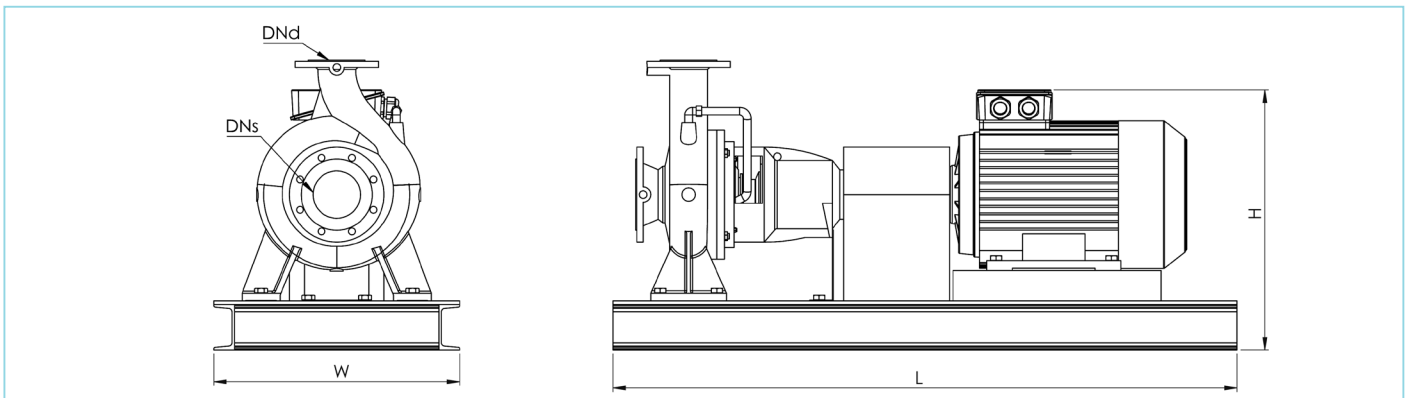

Pump Model	kW	rpm	DNs	DNd	kg	w	l	h
EL4 100-400	30	1450	DN125	DN100	489,2	600	1600	600
EL4 100-400B	11	1450	DN125	DN100	371,8	600	1450	650
EL4 100-400B	15	1450	DN125	DN100	391,8	600	1450	500
EL4 100-400B	18,5	1450	DN125	DN100	421,8	600	1450	550
EL4 100-400B	22	1450	DN125	DN100	438,2	600	1500	600
EL4 100-400B	30	1450	DN125	DN100	488,8	600	1600	650
EL4 125-200	7,5	1450	DN150	DN125	213,8	500	1300	550
EL4 125-200	11	1450	DN150	DN125	278,8	500	1400	600
EL4 125-250	15	1450	DN150	DN125	316,8	500	1400	650
EL4 125-250	18,5	1450	DN150	DN125	346,8	500	1450	650
EL4 125-250	22	1450	DN150	DN125	363,2	500	1500	650
EL4 125-315	18,5	1450	DN150	DN125	482,8	600	1500	650
EL4 125-315	22	1450	DN150	DN125	439,2	600	1550	650
EL4 125-315	30	1450	DN150	DN125	489,2	600	1600	650
EL4 125-315	37	1450	DN150	DN125	578,2	600	1600	700
EL4 125-315	45	1450	DN150	DN125	595,2	600	1650	700
EL4 125-330	15	1450	DN150	DN125	367,8	600	1450	650
EL4 125-330	18,5	1450	DN150	DN125	392,8	600	1500	650
EL4 125-330	22	1450	DN150	DN125	424,2	600	1550	650
EL4 125-330	30	1450	DN150	DN125	489,2	600	1600	650
EL4 125-400	37	1450	DN150	DN125	578,2	600	1600	700
EL4 125-400	45	1450	DN150	DN125	595,2	600	1650	700
EL4 125-400	55	1450	DN150	DN125	687,2	650	1750	750
EL4 125-400	75	1450	DN150	DN125	853,2	700	2000	800
EL4 125-400B	37	1450	DN150	DN125	489,2	600	1600	700
EL4 125-400B	45	1450	DN150	DN125	594,2	600	1650	700
EL4 125-400B	55	1450	DN150	DN125	716,2	650	1750	750
EL4 125-400B	75	1450	DN150	DN125	853,2	700	2000	800
EL4 150-200	11	1450	DN200	DN150	337,8	600	1400	600
EL4 150-200	15	1450	DN200	DN150	362,8	600	1400	600
EL4 150-250	15	1450	DN200	DN150	372,8	600	1400	600
EL4 150-250	18,5	1450	DN200	DN150	402,8	600	1450	650
EL4 150-250	22	1450	DN200	DN150	419,2	600	1500	650
EL4 150-250	30	1450	DN200	DN150	468,2	600	1550	680

# EL4

## Horizontal, End-Suction Centrifugal Pumps

### Dimensions

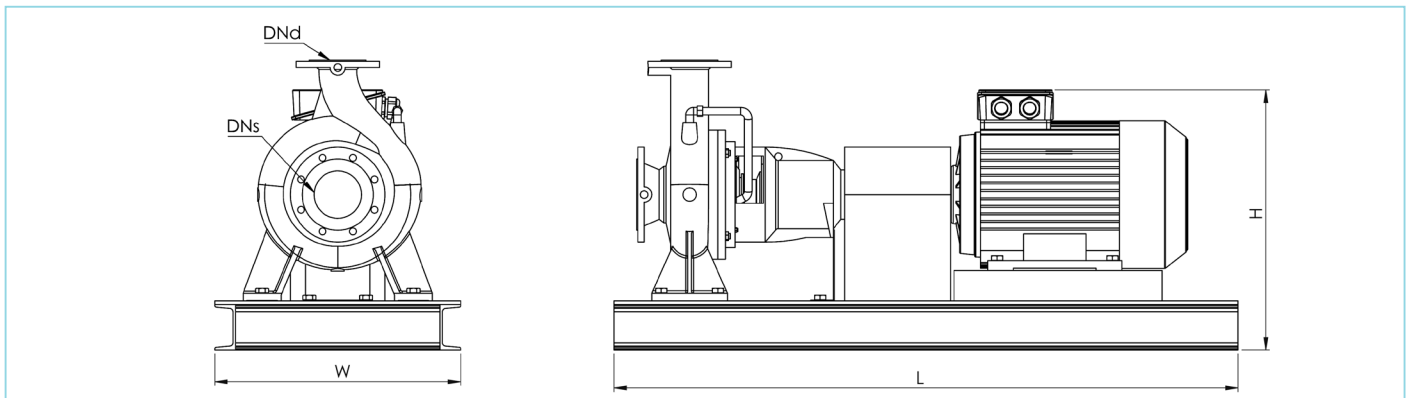

Pump Model	kW	rpm	DNs	DNd	kg	w	l	h
EL4 150-315	18,5	1450	DN200	DN150	435,8	650	1500	650
EL4 150-315	22	1450	DN200	DN150	453,2	650	1550	650
EL4 150-315	30	1450	DN200	DN150	502,2	650	1550	680
EL4 150-315	37	1450	DN200	DN150	591,2	650	1600	680
EL4 150-315	45	1450	DN200	DN150	607,2	650	1650	680
EL4 150-315	55	1450	DN200	DN150	726,2	650	1750	720
EL4 150-330	22	1450	DN200	DN150	457,2	650	1550	650
EL4 150-330	30	1450	DN200	DN150	502,2	650	1550	680
EL4 150-330	37	1450	DN200	DN150	591,2	650	1600	680
EL4 150-330	45	1450	DN200	DN150	607,2	650	1650	680
EL4 150-330	55	1450	DN200	DN150	726,2	650	1750	750
EL4 150-400	45	1450	DN200	DN150	644,2	650	1650	700
EL4 150-400	55	1450	DN200	DN150	770,2	700	1750	750
EL4 150-400	75	1450	DN200	DN150	902,2	700	1900	780
EL4 150-400	90	1450	DN200	DN150	967,2	700	1900	780
EL4 150-500	110	1450	DN200	DN150	1399,2	800	2300	950
EL4 150-500	132	1450	DN200	DN150	1476,2	800	2300	950
EL4 150-500	160	1450	DN200	DN150	1525,2	800	2300	950
EL4 150-510	75	1450	DN200	DN150	1163,2	800	2200	1000
EL4 150-510	90	1450	DN200	DN150	1228,2	800	2200	1000
EL4 150-510	110	1450	DN200	DN150	1399,2	800	2300	1150
EL4 150-510	132	1450	DN200	DN150	1476,2	800	2300	1150
EL4 150-510	160	1450	DN200	DN150	1525,2	800	2300	1150
EL4 150-560	75	1450	DN200	DN150	1163,2	800	2200	1000
EL4 150-560	90	1450	DN200	DN150	1228,2	800	2200	1000
EL4 150-560	110	1450	DN200	DN150	1399,2	800	2300	1150
EL4 150-560	132	1450	DN200	DN150	1476,2	800	2300	1150
EL4 150-560	160	1450	DN200	DN150	1525,2	800	2300	1150
EL4 150-560	200	1450	DN200	DN150	1662,2	900	2300	1150
EL4 200-260	18,5	1450	DN250	DN200	526,8	650	1600	700
EL4 200-260	22	1450	DN250	DN200	543,2	650	1650	700
EL4 200-260	30	1450	DN250	DN200	592,2	650	1650	750
EL4 200-315	30	1450	DN250	DN200	612,2	650	1650	750
EL4 200-315	37	1450	DN250	DN200	702,2	650	1700	750

# EL4

## Horizontal, End-Suction Centrifugal Pumps

### Dimensions

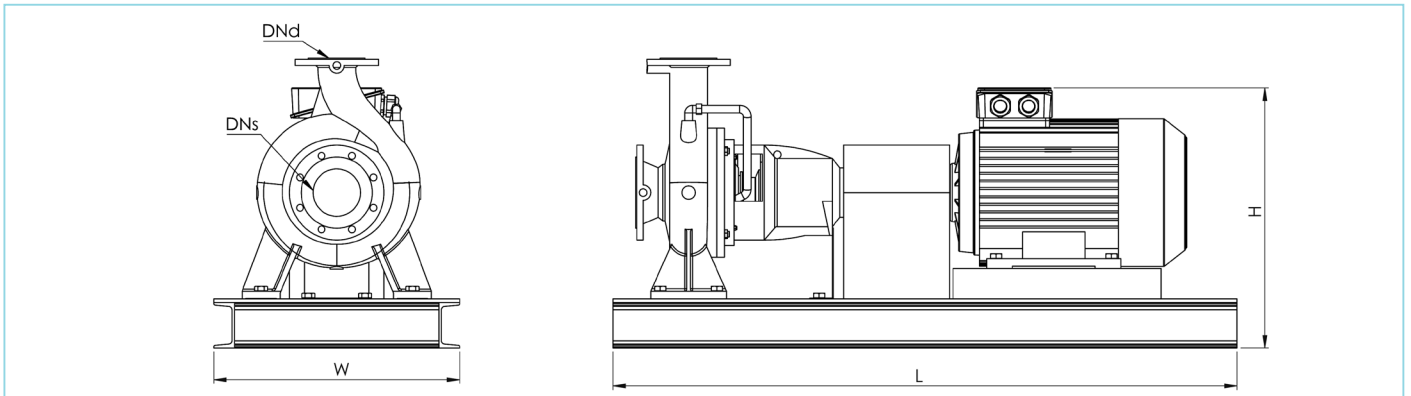

Pump Model	kW	rpm	DNs	DNd	kg	w	l	h
EL4 200-315	45	1450	DN250	DN200	718,2	650	1750	750
EL4 200-315	55	1450	DN250	DN200	838,2	650	1850	800
EL4 200-315	75	1450	DN250	DN200	973,2	700	2000	850
EL4 200-330	30	1450	DN250	DN200	612,2	650	1650	750
EL4 200-330	37	1450	DN250	DN200	702,2	650	1700	750
EL4 200-330	45	1450	DN250	DN200	719,2	650	1800	750
EL4 200-400	75	1450	DN250	DN200	1034,2	700	2050	880
EL4 200-400	90	1450	DN250	DN200	1099,2	700	2050	880
EL4 200-400	110	1450	DN250	DN200	1278,2	800	2200	1050
EL4 200-400	132	1450	DN250	DN200	1355,2	800	2200	1050
EL4 200-400	160	1450	DN250	DN200	1405,2	800	2250	1050
EL4 200-500	132	1450	DN250	DN200	1639,2	800	2500	1050
EL4 200-500	160	1450	DN250	DN200	1689,2	800	2500	1050
EL4 200-500	185	1450	DN250	DN200	1741,2	800	2600	1050
EL4 200-500	200	1450	DN250	DN200	1833,2	900	2600	1050
EL4 200-500	250	1450	DN250	DN200	2198,2	900	2700	1170
EL4 200-500	315	1450	DN250	DN200	2220,2	900	2700	1170
EL4 250-300	22	1450	DN300	DN250	660,2	800	1800	750
EL4 250-300	30	1450	DN300	DN250	706,2	800	1850	800
EL4 250-300	37	1450	DN300	DN250	796,2	800	1950	800
EL4 250-300	45	1450	DN300	DN250	812,2	800	2000	800
EL4 250-315	45	1450	DN300	DN250	812,2	800	2000	830
EL4 250-315	55	1450	DN300	DN250	942,2	800	2100	880
EL4 250-315	75	1450	DN300	DN250	1074,2	800	2200	900
EL4 250-400	75	1450	DN300	DN250	1144,2	800	2200	900
EL4 250-400	90	1450	DN300	DN250	1209,2	800	2200	900
EL4 250-400	110	1450	DN300	DN250	1380,2	800	2400	1050
EL4 250-400	132	1450	DN300	DN250	1457,2	800	2400	1050
EL4 250-450	90	1450	DN300	DN250	1210,2	800	2300	900
EL4 250-450	110	1450	DN300	DN250	1382,2	800	2500	1050
EL4 250-450	132	1450	DN300	DN250	1459,2	800	2500	1050
EL4 250-450	160	1450	DN300	DN250	1481,2	800	2600	1050
EL4 250-500	132	1450	DN300	DN250	1659,2	800	2500	1100
EL4 250-500	160	1450	DN300	DN250	1712,2	800	2700	1100

# EL4

## Horizontal, End-Suction Centrifugal Pumps

### Dimensions

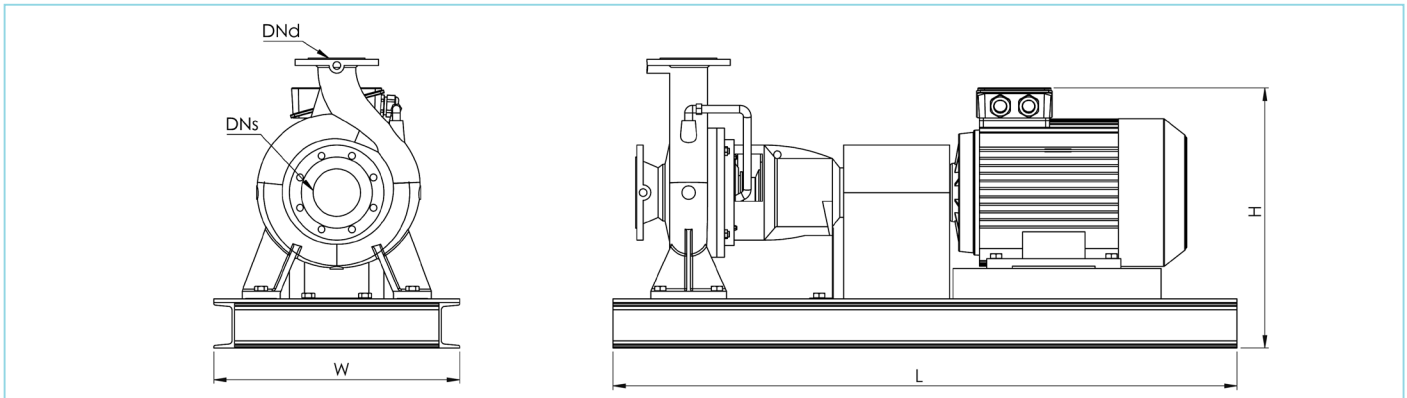

Pump Model	kW	rpm	DNs	DNd	kg	w	l	h
EL4 250-500	200	1450	DN300	DN250	1854,2	900	2700	1100
EL4 250-500	250	1450	DN300	DN250	2219,2	900	2800	1250
EL4 250-500	315	1450	DN300	DN250	2241,2	900	2800	1250
EL4 250-500	315	1450	DN300	DN250	2241,2	900	2800	1250
EL4 250-510	355	1450	DN300	DN250	2279,2	900	2800	1250
EL4 300-315	75	1450	DN350	DN300	684,2	800	2200	950
EL4 300-315	90	1450	DN350	DN300	749,2	800	2200	950
EL4 300-315	110	1450	DN350	DN300	920,2	800	2400	1100
EL4 300-315	132	1450	DN350	DN300	997,2	800	2400	1100
EL4 300-360	75	1450	DN350	DN300	685,2	800	2300	900
EL4 300-360	90	1450	DN350	DN300	750,2	800	2300	900
EL4 300-360	110	1450	DN350	DN300	922,2	800	2500	1050
EL4 300-400	110	1450	DN350	DN300	922,2	800	2500	1050
EL4 300-400	132	1450	DN350	DN300	999,2	800	2500	1050
EL4 300-400	160	1450	DN350	DN300	1058,2	800	2700	1050
EL4 300-400	200	1450	DN350	DN300	1200,2	900	2700	1050
EL4 300-450	90	1450	DN350	DN300	750,2	800	2300	950
EL4 300-450	110	1450	DN350	DN300	922,2	800	2500	1100
EL4 300-450	132	1450	DN350	DN300	999,2	800	2500	1100
EL4 300-450	160	1450	DN350	DN300	1058,2	800	2700	1100
EL4 300-500	160	1450	DN350	DN300	1058,2	800	2700	1100
EL4 300-500	200	1450	DN350	DN300	1200,2	900	2700	1100
EL4 300-500	250	1450	DN350	DN300	1567,2	900	2800	1250
EL4 300-500	315	1450	DN350	DN300	1589,2	900	2800	1250
EL4 300-500	355	1450	DN350	DN300	1627,2	900	2800	1250
EL4 300-500	400	1450	DN350	DN300	1831,2	900	2900	1250
EL4 300-500	450	1450	DN350	DN300	1932,2	900	2900	1250
EL4 300-560	160	1450	DN350	DN300	1067,2	900	2700	1100
EL4 300-560	200	1450	DN350	DN300	1204,2	900	2700	1100
EL4 300-560	250	1450	DN350	DN300	1567,2	900	2800	1250
EL4 300-560	315	1450	DN350	DN300	1589,2	900	2800	1250
EL4 300-560	355	1450	DN350	DN300	1627,2	900	2800	1250
EL4 300-560	400	1450	DN350	DN300	1531,2	900	2900	1250

# EL6

## Horizontal, End-Suction Centrifugal Pumps

### Dimensions

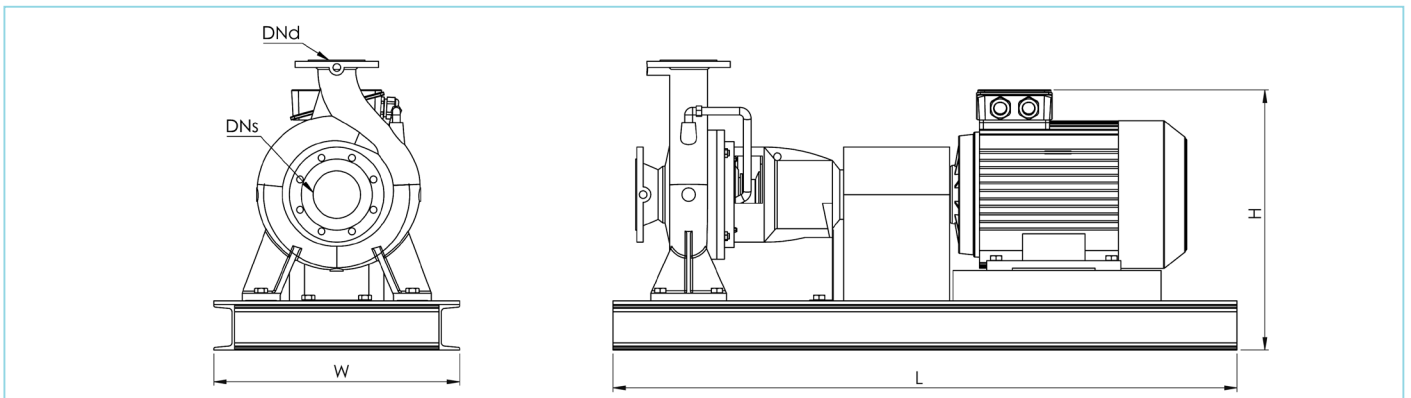

Pump Model	kW	rpm	DNs	DNd	kg	w	l	h
EL6 100-250	0,75	1000	DN125	DN100	206,8	650	1100	700
EL6 100-250	1,1	1000	DN125	DN100	210	650	1100	700
EL6 100-250	1,5	1000	DN125	DN100	217,5	650	1150	700
EL6 100-250	2,2	1000	DN125	DN100	227,2	650	1200	700
EL6 100-250	3	1000	DN125	DN100	236,3	650	1250	700
EL6 100-400	2,2	1000	DN125	DN100	315,2	750	1250	850
EL6 100-400	3	1000	DN125	DN100	323,3	750	1300	850
EL6 100-400	4	1000	DN125	DN100	330,8	750	1350	850
EL6 100-400	5,5	1000	DN125	DN100	339,3	750	1350	850
EL6 100-400	7,5	1000	DN125	DN100	394,3	750	1450	850
EL6 100-400	11	1000	DN125	DN100	418,8	750	1500	850
EL6 125-315	3	1000	DN150	DN125	323,3	750	1300	850
EL6 125-315	4	1000	DN150	DN125	330,8	750	1350	850
EL6 125-315	5,5	1000	DN150	DN125	339,3	750	1350	850
EL6 125-315	7,5	1000	DN150	DN125	394,3	750	1450	850
EL6 125-400	5,5	1000	DN150	DN125	359,3	750	1350	950
EL6 125-400	7,5	1000	DN150	DN125	414,3	750	1450	950
EL6 125-400	11	1000	DN150	DN125	438,8	750	1500	950
EL6 125-400	15	1000	DN150	DN125	486,8	750	1550	950
EL6 125-400	18,5	1000	DN150	DN125	521,8	750	1600	950
EL6 150-315	5,5	1000	DN200	DN150	356,3	800	1400	900
EL6 150-315	7,5	1000	DN200	DN150	410,3	800	1500	900
EL6 150-315	11	1000	DN200	DN150	432,8	800	1500	900
EL6 150-400	5,5	1000	DN200	DN150	396,3	800	1400	950
EL6 150-400	7,5	1000	DN200	DN150	450,3	800	1500	950
EL6 150-400	11	1000	DN200	DN150	472,8	800	1500	950
EL6 150-400	15	1000	DN200	DN150	520,8	800	1600	950
EL6 150-500	18,5	1000	DN200	DN150	850,8	950	1900	1150
EL6 150-500	22	1000	DN200	DN150	866,8	950	1850	1150
EL6 150-500	30	1000	DN200	DN150	936,8	950	1950	1150
EL6 150-500	37	1000	DN200	DN150	1023,8	950	2000	1150

# EL6

## Horizontal, End-Suction Centrifugal Pumps

### Dimensions

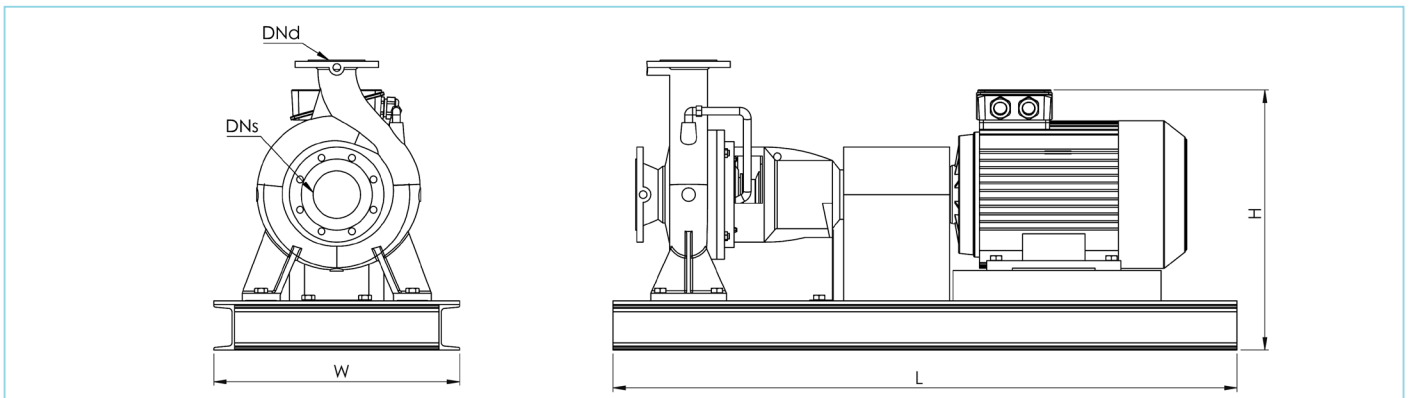

Pump Model	kW	rpm	DNs	DNd	kg	w	l	h
EL6 200-260	5,5	1000	DN250	DN200	474,3	850	1500	1000
EL6 200-260	7,5	1000	DN250	DN200	530,3	850	1600	1000
EL6 200-315	7,5	1000	DN250	DN200	550,3	850	1600	1000
EL6 200-315	11	1000	DN250	DN200	573,8	850	1650	1000
EL6 200-315	15	1000	DN250	DN200	621,8	850	1700	1000
EL6 200-400	15	1000	DN250	DN200	687,8	850	1800	1100
EL6 200-400	18,5	1000	DN250	DN200	721,8	850	1850	1100
EL6 200-400	22	1000	DN250	DN200	738,8	850	1850	1100
EL6 200-400	30	1000	DN250	DN200	808,8	850	1950	1100
EL6 200-400	37	1000	DN250	DN200	894,8	850	2000	1100
EL6 200-500	22	1000	DN250	DN200	1036,7	950	2050	1150
EL6 200-500	30	1000	DN250	DN200	1107,7	950	2150	1150
EL6 200-500	37	1000	DN250	DN200	1194,7	950	2200	1150
EL6 200-500	45	1000	DN250	DN200	1321,7	950	2300	1150
EL6 200-500	55	1000	DN250	DN200	1371,7	950	2300	1150
EL6 250-300	5,5	1000	DN300	DN250	567,8	950	1650	1150
EL6 250-300	7,5	1000	DN300	DN250	569,8	950	1750	1150
EL6 250-300	11	1000	DN300	DN250	694,8	950	1800	1150
EL6 250-300	15	1000	DN300	DN250	742,8	950	1850	1150
EL6 250-300	18,5	1000	DN300	DN250	776,8	950	1900	1150
EL6 250-300	22	1000	DN300	DN250	793,8	950	1900	1150
EL6 250-400	22	1000	DN300	DN250	863,8	950	1900	1150
EL6 250-400	30	1000	DN300	DN250	932,8	950	2000	1150
EL6 250-400	37	1000	DN300	DN250	1018,8	950	2050	1150
EL6 250-500	37	1000	DN300	DN250	1054,7	950	2250	1300
EL6 250-500	45	1000	DN300	DN250	1178,7	950	2350	1300
EL6 250-500	55	1000	DN300	DN250	1228,7	950	2350	1300
EL6 250-500	75	1000	DN300	DN250	1333,7	950	2500	1300
EL6 250-500	90	1000	DN300	DN250	1405,7	950	2500	1300