

# NCL, NCLD

## Inline, Dry Running Circulation Pumps

**ebitt**  
FLUID TECHNOLOGIES

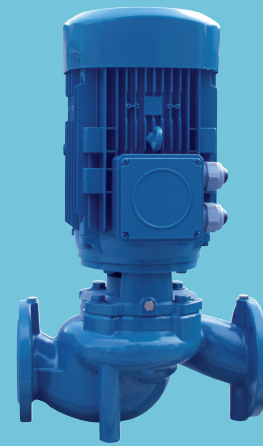

Twin Execution

### FEATURE

- Vertical, single-stage volute casing type, close-coupled in-line centrifugal pumps with closed impeller. Close-coupled by means of an adaptor bracket with an impeller keyed directly to the specific motor shaft extension.
- The NCL-NCLD series have a "Backpull-out" design impeller, adaptor and motor can be extracted without disconnecting the pump body from the piping system.
- NCL-NCLD 40-120 / 320 - 1,5
  - NCL: Single Head
  - NCLD: Twin Head (Double pump in one housing). The two pumps are hydraulically separated by silent-operating valve.
  - 40: Diameter nominal of the pipe connection
  - 120: Nominal diameter of impeller
  - 320: Dimension between inlet and outlet flange
  - 1,5: Nominal motor power P2 in kW
- High-efficiency motors as standard
- High corrosion protection thanks to cathoretic coating
- Standard condensate drainage holes in the motor housing and lanterns
- The pumps are equipped with interchangeable mechanical seals
- Fluid temperature: -20°C / +120°C
- Maximum operating pressure: 10 Bar (PN10)
- IP55 protection, insulation class F
- Mains connection 3 ~ 400V, 50 Hz
- For bigger than 0,75 kw motors, Efficiency Class IE3

### Materials

Pump Housing and Lantern: Cast Iron  
Impeller: Reinforced Glass PPO up to 5,5 kW (not included)  
Cast Iron: 5,5 kW - 7,5 kW  
Mechanical Seal: AQ1EGG  
Shaft: X20Cr (AISI420)

### Applications

NCL-NCLD pumps are designed for clean or slightly contaminated liquids with low viscosity.

- District heating systems
- Heating systems
- Air-conditioning systems
- District cooling systems
- Water supply
- Industrial processes
- Industrial cooling
- Liquid transfer in ventilation systems
- Pressure boosting in commercial buildings

# NCL, NCLD

## Inline, Dry Running Circulation Pumps

### Performance Table

Model	A	Q (m <sup>3</sup> /h)	1	2	3	4	5	6	7					
NCL 25-70/180-0,12	0,36	H (mWC)	5,4	5,2	4,6	4	2,7	1,8						
NCL 25-80/180-0,12	0,36		7,1	6,8	6,4	5,6	4,8	3,8	2,7					
NCL 25-85/180-0,18	0,5		8,2	8	7,6	6,9	6	5,1	4					
NCL 25-90/180-0,25	0,6		10,3	10	9,6	9	8	7	6					
Model	A	Q (m <sup>3</sup> /h)	1	2	3	4	5	6	7	8				
NCL 30-70/180-0,12	0,36	H (mWC)	5,5	5,2	4,7	4	3,2	2,2						
NCL 30-80/180-0,12	0,36		7,1	6,8	6,4	5,6	4,8	3,8	2,8					
NCL 30-85/180-0,18	0,5		8,3	8	7,6	6,8	6	5,2	4					
NCL 30-90/180-0,25	0,6		10,4	10,1	9,6	9	8,1	7,3	6	4,8				
Model	A	Q (m <sup>3</sup> /h)	2	4	6	8	10	12	14					
NCL 32-90/260-0,37	0,91	H (mWC)	8,1	7,8	6,9	5,3								
NCL 32-100/260-0,55	1,33		12	12,7	11	9	6,3	3						
NCL 32-110/260-0,75	1,7		14,4	14	13,5	12,5	10,5	7,7						
NCL 32-130/260-1,1	2,4		19	18,8	18,5	17,8	16	14	11					
Model	A	Q (m <sup>3</sup> /h)	2	4	6	8	10	12	14	16	18	20	22	
NCL 32-160/260-1,1	2,4	H (mWC)	28	26,2	24	21,8	18	13,8	8	2				
NCL 32-165/320-3	5,8			32,5	32,2	32	31,5	30,8	29,8	28,8	26	23		
NCL 32-175/320-4	7,7				40,5	40	39,8	39	38	37	34	31	27,5	
Model	A	Q (m <sup>3</sup> /h)	4	8	12	16	20	24	28	32				
NCL 40-70/220-0,12	0,36	H (mWC)	3,5	2,8	1,7									
NCL 40-90/250-0,37	0,91		7,6	6,8	4,8									
NCL 40-115/250-0,55	1,33		12,3	11,5	10	7,5								
NCL 40-120/320-1,5	3,3		18,4	18,2	17,9	17	15,7	13,9	11,5	9				
Model	A	Q (m <sup>3</sup> /h)	4	8	12	16	20	24	28	32	36	40	44	
NCL 40-130/320-2,2	4,5	H (mWC)	21,8	22	22,6	21	19,8	18,1	16,1	13,8	11			
NCL 40-150/320-3	5,8				28	28	27,5	26,8	25,5	24	22	19	16,5	
NCL 40-160/320-4	7,7				31,3	31,1	30,8	30,5	29,5	28	26	24	21	18
NCL 40-165/340-4	7,7				33,3	33,1	32,7	32	31	29,8	28	26,5		
Model	A	Q (m <sup>3</sup> /h)	8	12	16	20	24	28	32	36	40	44		
NCL 40-175/340-5,5	10,2	H (mWC)	41	41	40,5	40	39	38	36,8	35	33	31		
Model	A	Q (m <sup>3</sup> /h)	8	16	20	24	28	36	44	48	52			
NCL 50-115/280-0,75	1,7	H (mWC)	12,1	10,5	9,3	7,5	5,5							
NCL 50-120/340-1,5	3,3		14,7	14,3	13,7	13,2	12,3	10,3	7,5					
NCL 50-130/340-2,2	4,5		18,5	18,3	18	17,5	16,8	14,7	12	10,2	8,8			
NCL 50-140/340-3	5,8		22	21,8	21,5	21	20,5	19	16,8	15	13,7			
Model	A	Q (m <sup>3</sup> /h)	8	16	20	24	28	36	44	48	52	56		
NCL 50-150/340-4	7,7	H (mWC)	26,8	26,5	26,1	25,8	25,3	23,9	21,8	20	18,7	16,8		
NCL 50-155/340-4	7,7		27,9	27,5	27,3	27,2	27	26	24,5	23,6	22			
NCL 50-165/340-5,5	10,2		32,5	32,1	32	31,2	30,8	29	26,7	25	23,5	21,4		
NCL 50-175/340-5,5	10,2			37,9	37,5	37,2	37							
Model	A	Q (m <sup>3</sup> /h)	8	16	20	24	28	36	44	48	52	56		
NCL 50-175/340-7,5	13,7	H (mWC)	38,1	37,9	37,8	37,1	37	35,7	34	32,3	32	30		

# NCL, NCLD

## Inline, Dry Running Circulation Pumps

### Performance Table

Model	A	Q (m <sup>3</sup> /h)	8	16	20	24	28	36	44	48	52	56	60	70	80
NCL 65-115/340-1,5	3,3	H (mWC)	14	13,5	13	12,6	12	10,5	8	6,5	4,7				
NCL 65-120/340-2,2	4,5		15	14,7	14,5	14,2	13,8	13	11,5	11	10,2	9,2	8,2		
NCL 65-130/340-3	5,8		17,9	17,6	17,5	17,1	16,9	16,3	15,1	14,3	14	13,3	12		
NCL 65-140/340-4	7,7		21,9	21,7	21,4	21	20,9	20,5	19	18,3	18	17	16,5	14	10,5

Model	A	Q (m <sup>3</sup> /h)	16	20	24	28	36	44	48	52	56	60	70	80
NCL 65-145/340-5,5	10,2	H (mWC)	21	21,3	21,4	21,3	21	20,7	20,5	20,4	20	19,5	18,3	16,5
NCL 65-155/340-7,5	13,7		26,3	26,4	26,5	26,6	26,5	26,3	26,2	26	25,9	25,5	24,5	23

Model	A	Q (m <sup>3</sup> /h)	10	20	30	40	50	60	70	80	90	100	110	120
NCL 80-115/360-2,2	4,5	H (mWC)	15,2	14,7	13,5	12,4	11	9,5	7,5	5				
NCL 80-130/360-3	5,8		14,7	14,3	13,7	13	12,3	11,1	10	8,5	6,5			
NCL 80-140/360-4	7,7			18	17,5	16,8	15,8	14,8	13,5	12	10,3	8,8	6,7	
NCL 80-145/400-5,5	10,2			18,2	18,3	18,4	18,3	18	17,5	17	16	15	13,8	12,5

Model	A	Q (m <sup>3</sup> /h)	20	30	40	50	60	70	80	90	100	110	120	130
NCL 80-155/400-7,5	13,7	H (mWC)	22,5	22,6	22,7	22,6	22,5	22,3	22	21	20,3	19,4	18	16,8

Model	A	Q (m <sup>3</sup> /h)	2	4	6	8	10	12	14					
NCLD 32-90/260-0,37	0,91	H (mWC)	8	7,5	6,2	4								
NCLD 32-100/260-0,55	1,33		11,1	10,9	9,5	7	4							
NCLD 32-110/260-0,75	1,7		15	14,2	13	11	8	3,8						
NCLD 32-130/260-1,1	2,4		19,5	18,7	17,8	16	13	9,5	5					

Model	A	Q (m <sup>3</sup> /h)	2	4	6	8	10	12	14	16	18	20	22	24
NCLD 32-160/260-1,1	2,4	H (mWC)	28	26	23	19	14	9	3					
NCLD 32-165/320-3	5,8			32,5	32	31	30	29	27	26	24	22	20	
NCLD 32-175/320-4	7,7				40	39	38	37	36	34	32	30	28	26

Model	A	Q (m <sup>3</sup> /h)	2	4	6	8	10	12	14	16	18	20	24	28	30
NCLD 40-90/250-0,37	0,91	H (mWC)	8	7,8	7,2	6,4	5,4	4,2	2,9						
NCLD 40-115/250-0,55	1,33		12,3	12,1	11,7	11	10,3	9,7	8	6,5	5				
NCLD 40-120/320-1,5	3,3			18,4	18,5	18,3	18	17,5	17	16,3	15,5	14,5	12,5	9,7	
NCLD 40-130/320-2,2	4,5			22,1	22,2	22	21,8	21,5	21	20,2	19,5	18,5	16	13,5	12

Model	A	Q (m <sup>3</sup> /h)	4	8	12	16	20	24	28	32	36	40	44
NCLD 40-150/320-3	5,8	H (mWC)	28	28,1	28	27,2	26	24	22	19			
NCLD 40-160/320-4	7,7			31,2	31	30,5	29,5	28	26	23,5	20,5	17	13
NCLD 40-165/340-4	7,7			32,9	32,8	32	31,8	30	28	26	24		
NCLD 40-175/340-5,5	10,2			40,8	41	40,8	40,1	38,8	37	35,7	33	30,8	

Model	A	Q (m <sup>3</sup> /h)	4	8	12	16	20	24	28	32	36	40
NCLD 50-115/280-0,75	1,7	H (mWC)	10,7	10	9,4	8	6,5	4,7				
NCLD 50-120/340-1,5	3,3		14	13,9	13,7	13,5	12,9	12,3	11,2			
NCLD 50-130/340-2,2	4,5			17,5	17,4	17,2	16,7	16,1	15	13,9	12,3	
NCLD 50-140/340-3	5,8			21,5	21,4	21,2	20,8	20	19	18,7	17	15

# NCL, NCLD

## Inline, Dry Running Circulation Pumps

### Performance Table

Model	A	Q (m <sup>3</sup> /h)	10	15	20	25	30	35	40	45	50	55	60		
NCLD 50-150/340-4	7,7	H (mWC)	26,1	26	25,5	24,7	23,8	22,2	20,5	18,4	15,5				
NCLD 50-155/340-4	7,7		28	27,9	27,8	27,5	26	25	24	22					
NCLD 50-165/340-5,5	10,2		32,1	32	31,9	31	29,8	28	26,5	24	22	20	16,8		
NCLD 50-175/340-5,5	10,2		38,2	38,1	38	37,9									

Model	A	Q (m <sup>3</sup> /h)	10	20	30	40	50	60							
NCLD 50-175/340-7,5	13,7	H (mWC)	38,3	38	37	35	31	26							

Model	A	Q (m <sup>3</sup> /h)	10	20	30	40	50	60	70						
NCLD 65-115/340-1,5	3,3	H (mWC)	13,8	12,8	11	8,5	4								
NCLD 65-120/340-2,2	4,5		15	14,5	13,5	12	10	7,5							
NCLD 65-130/340-3	5,8		17,8	17,1	16,5	15,3	13,9	11,5	8,5						
NCLD 65-140/340-4	7,7		21,6	21	20,5	19,5	18	15,8	12,8						

Model	A	Q (m <sup>3</sup> /h)	20	30	40	50	60	70	80	90					
NCLD 65-145/340-5,5	10,2	H (mWC)	21	21,1	20,8	20	19	17,5	15,8						
NCLD 65-155/340-7,5	13,7		26,2	26,1	26	25,9	25	24	22,5	20					

Model	A	Q (m <sup>3</sup> /h)	10	20	30	40	50	60	70	80	90	100	110		
NCLD 80-115/360-2,2	4,5	H (mWC)	14,9	14	13	11,8	10	8,2	6						
NCLD 80-130/360-3	5,8			14	13,5	12,7	11,7	10	9	7,5	5,5				
NCLD 80-140/360-4	7,7			17,6	17	16,1	15	14	12,8	11,2	9,5	7,8	5,8		
NCLD 80-145/400-5,5	10,2			18,2	18,1	18	17,7	17,2	16,5	15,5	14	12,8	11		

Model	A	Q (m <sup>3</sup> /h)	20	40	60	80	100	120							
NCLD 80-155/400-7,5	13,7	H (mWC)	22,6	22,5	22	20,5	18,2	15							

# NCL

## Inline, Dry Running Circulation Pumps

**NCL 25-70/180**

**NCL 25-80/180**

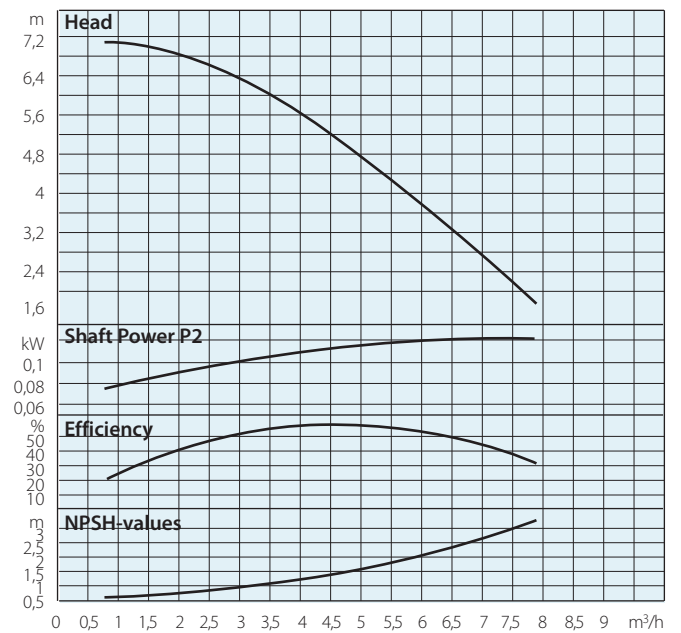
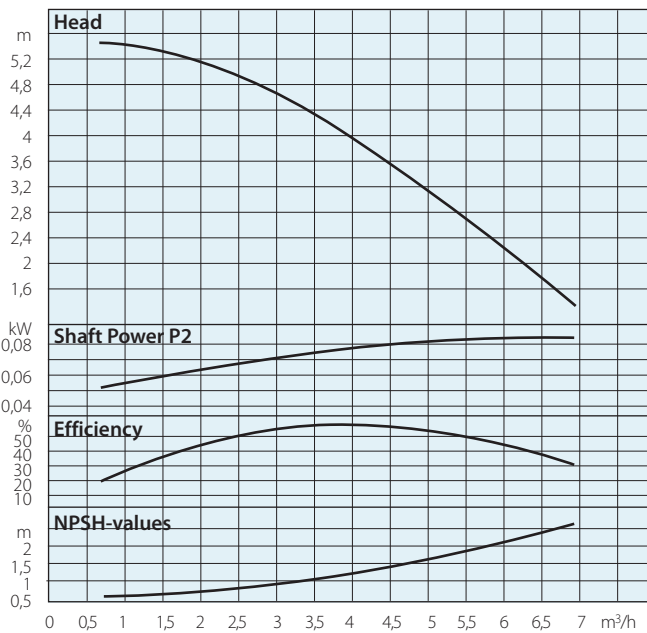

**NCL 25-85/180**

**NCL 25-90/180**

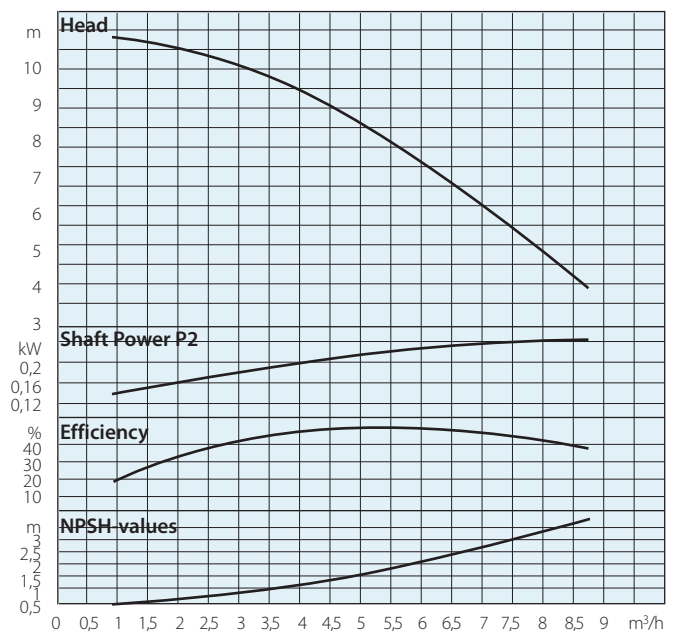
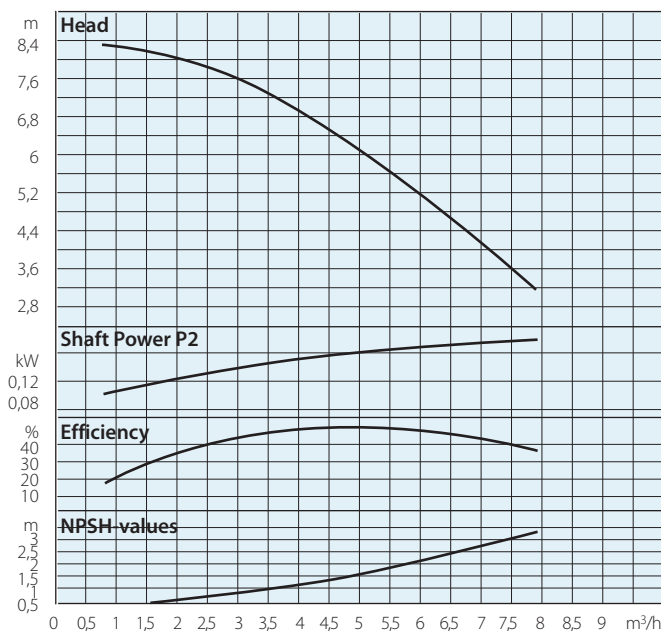

# NCL

## Inline, Dry Running Circulation Pumps

**NCL 30-70/180**

**NCL 30-80/180**

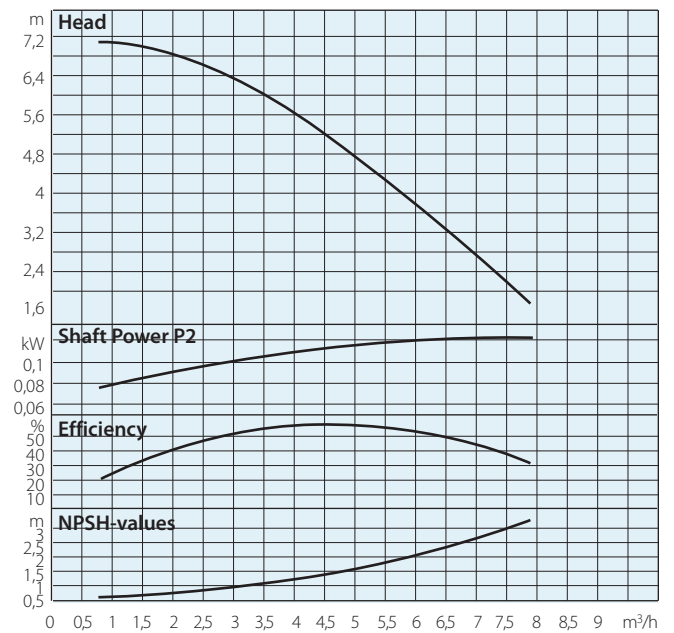
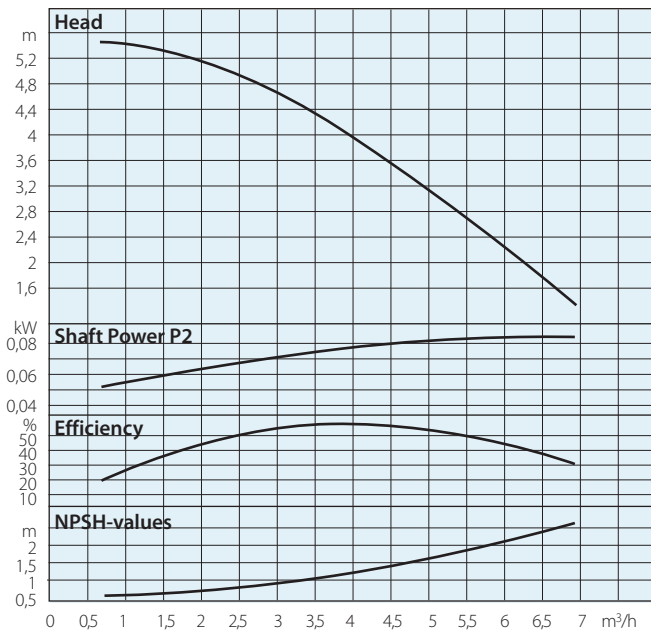

**NCL 30-85/180**

**NCL 30-90/180**

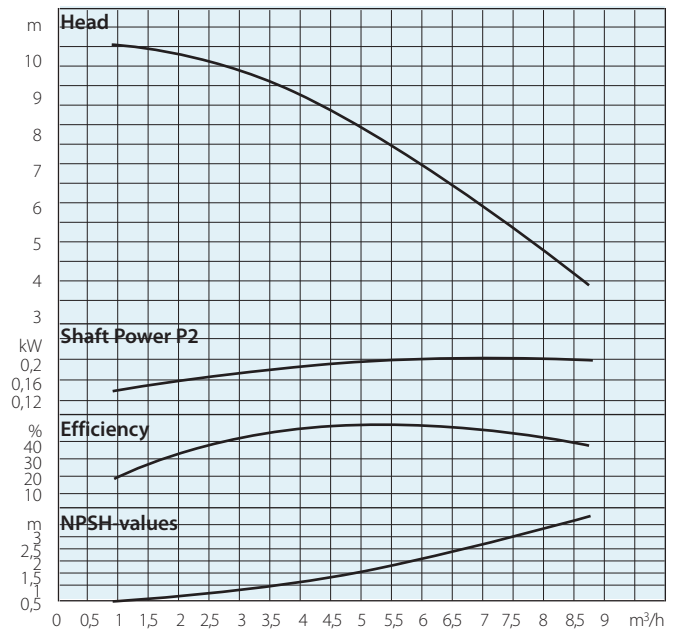
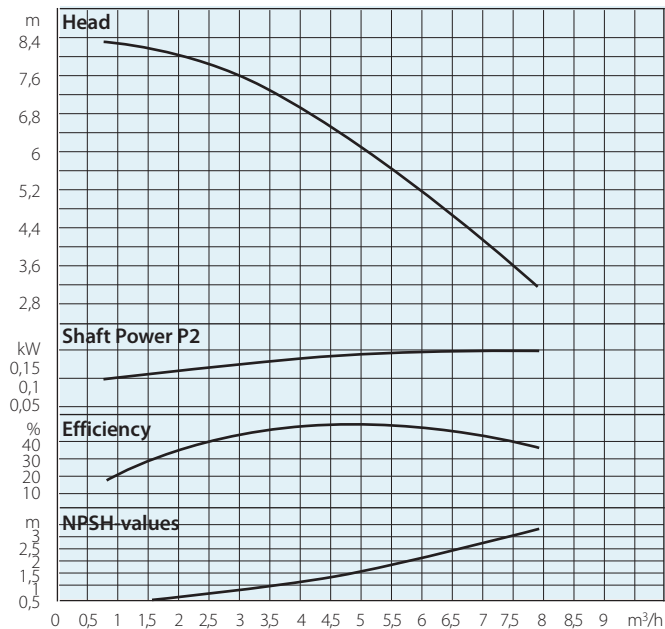

# NCL

## Inline, Dry Running Circulation Pumps

**NCL 32-90/260**

**NCL 32-100/260**

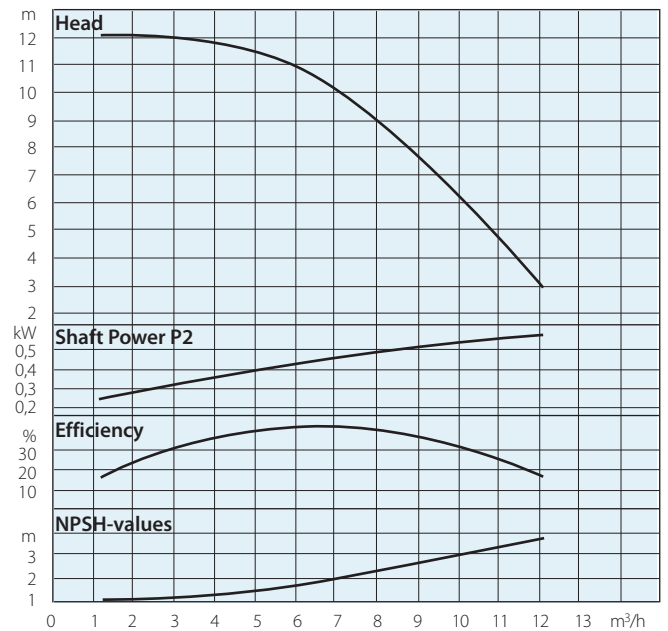
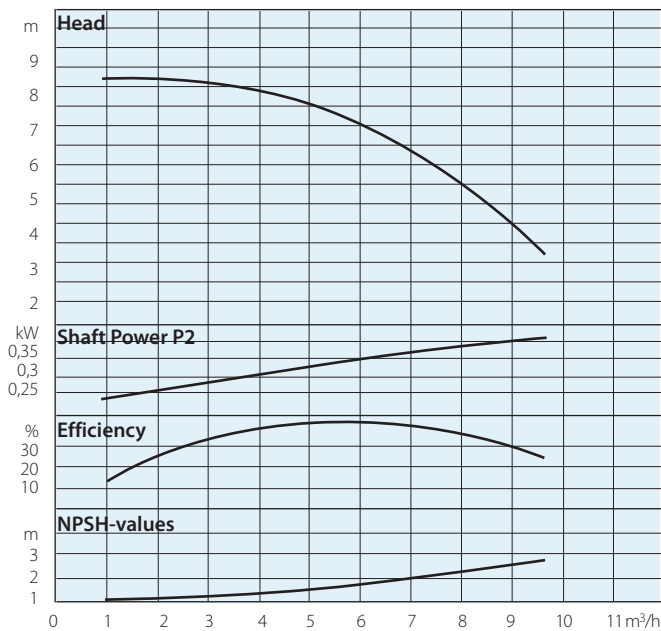

**NCL 32-110/260**

**NCL 32-130/260**

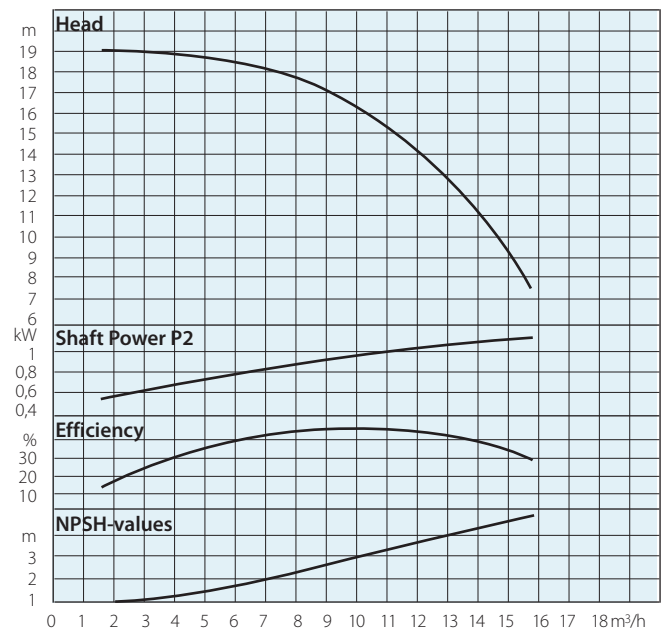
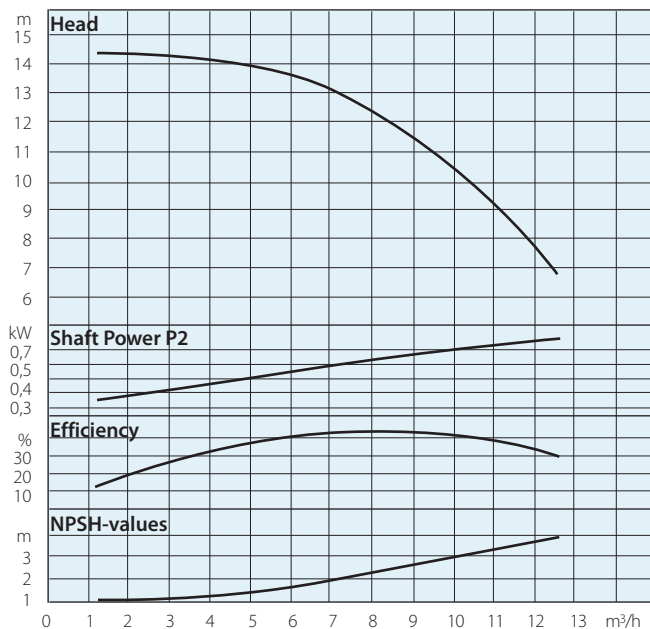

# NCL

## Inline, Dry Running Circulation Pumps

**NCL 32-160/260**

**NCL 32-165/320**

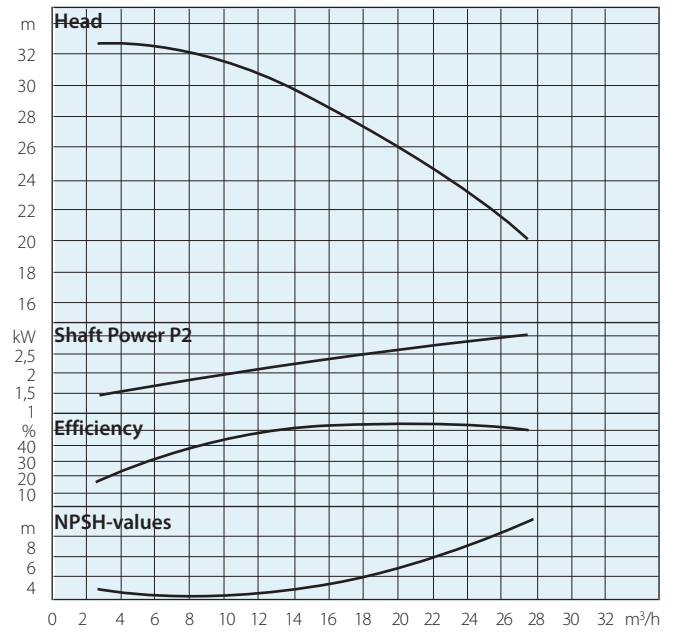
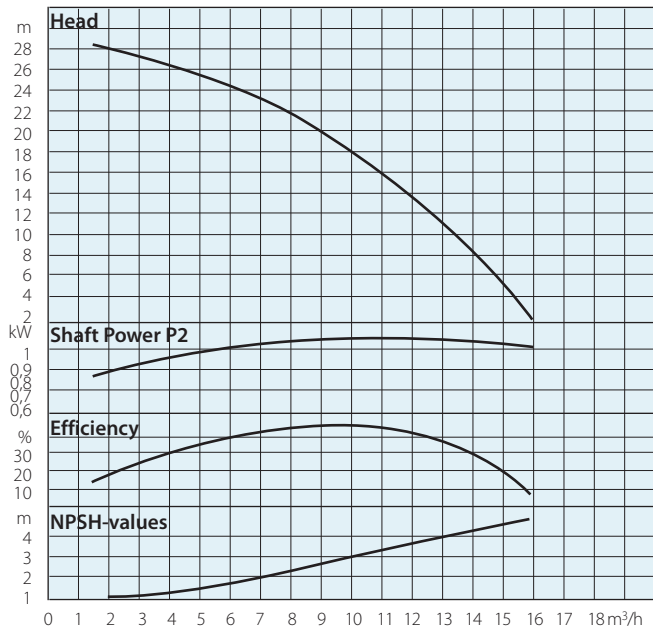

**NCL 32-175/320**

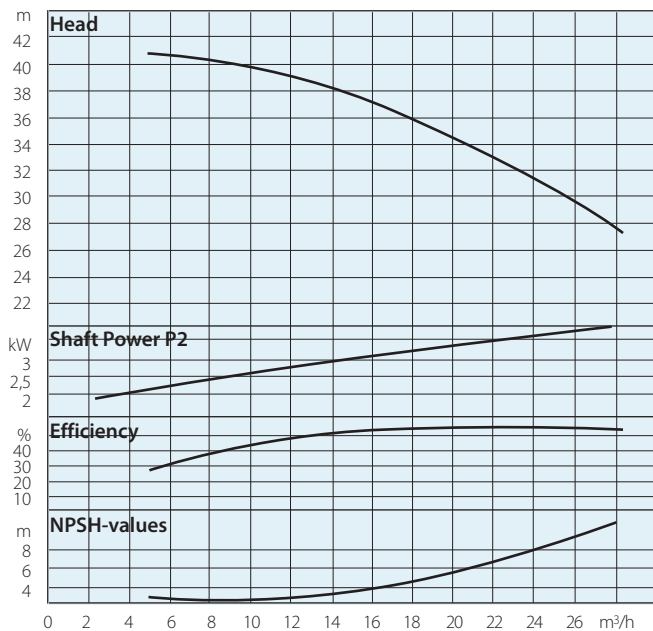



# NCL

## Inline, Dry Running Circulation Pumps

**NCL 40-70/220**

**NCL 40-90/250**

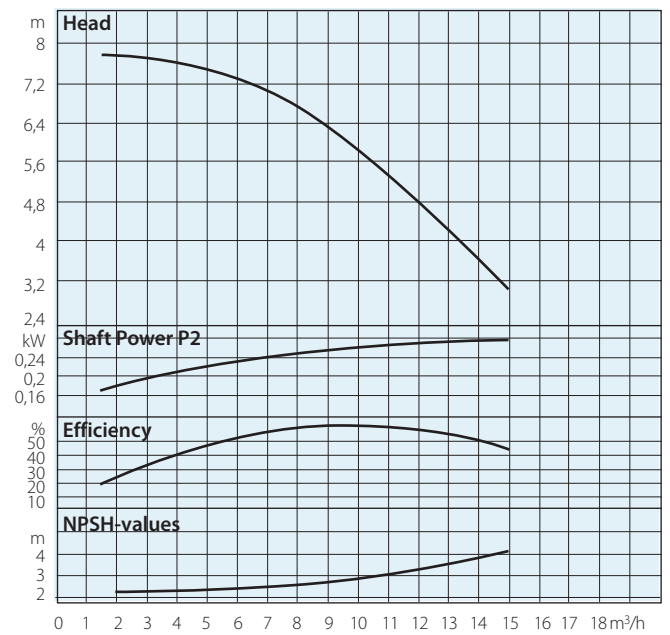
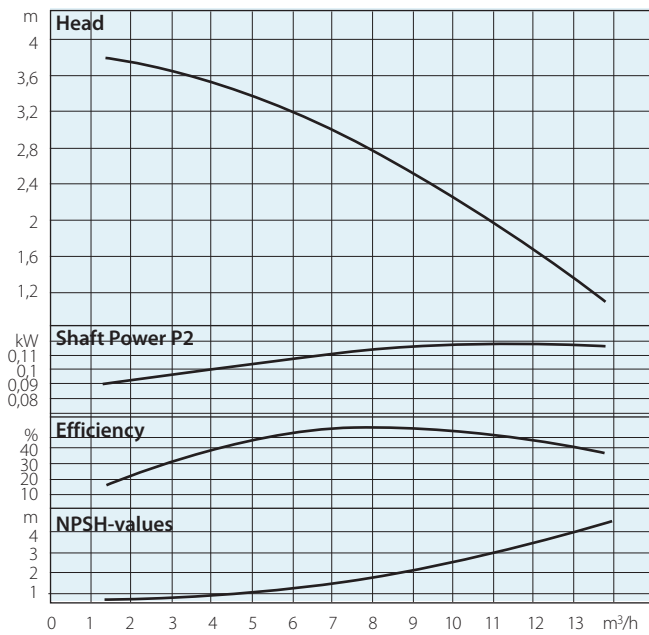

**NCL 40-115/250**

**NCL 40-120/320**

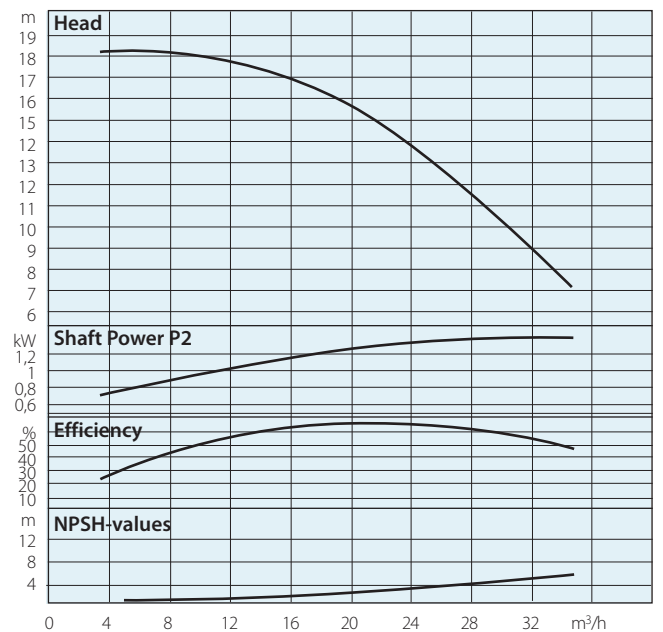
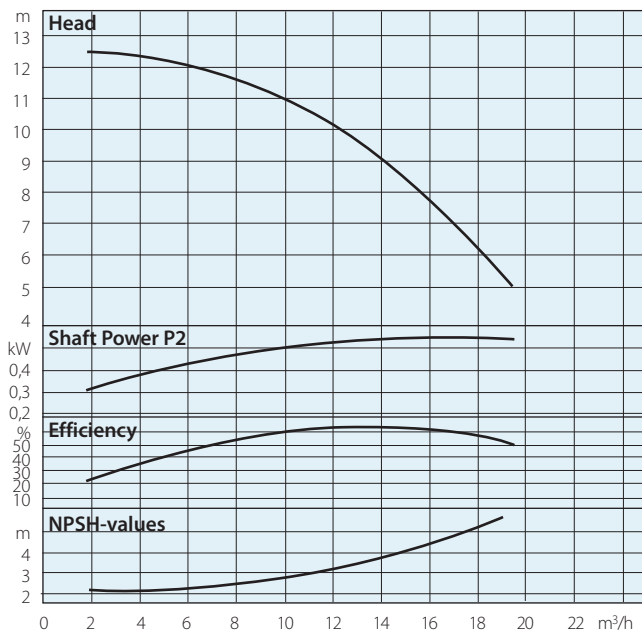

# NCL

## Inline, Dry Running Circulation Pumps

**NCL 40-130/320**

**NCL 40-150/320**

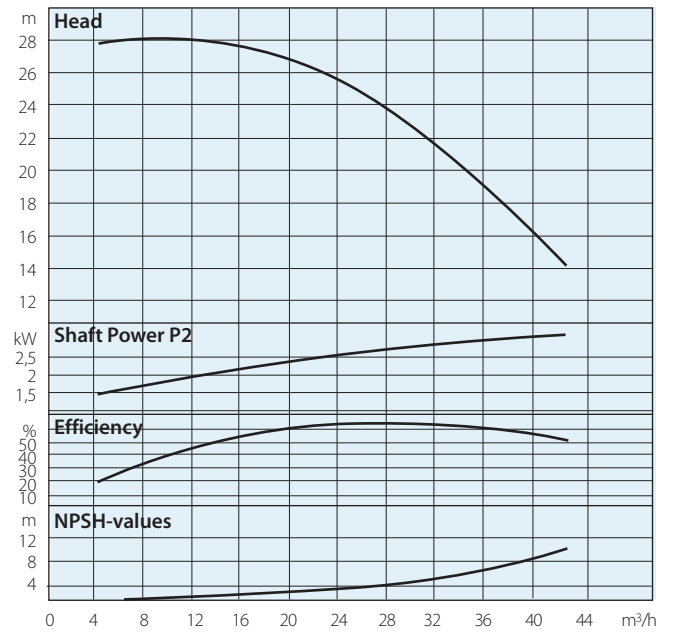
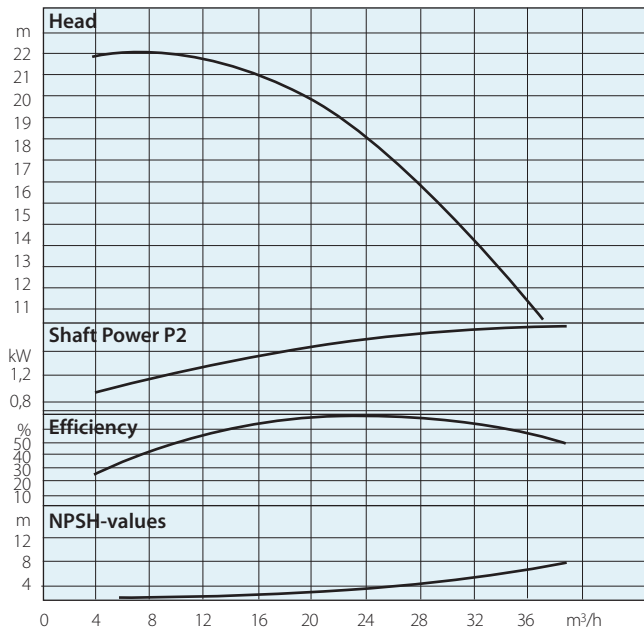

**NCL 40-160/320**

**NCL 40-165/340**

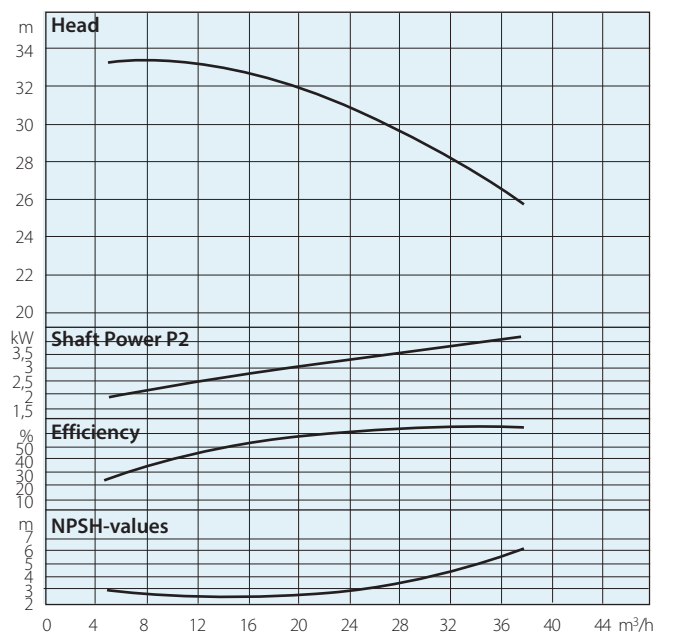
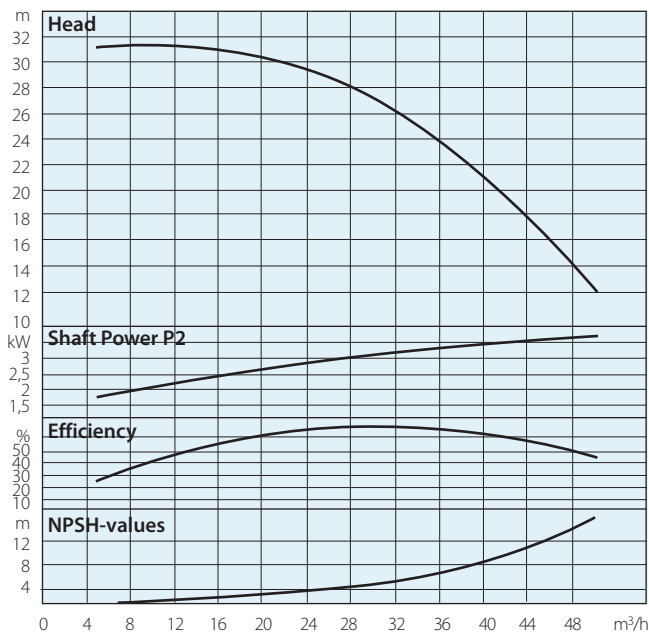

# NCL

## Inline, Dry Running Circulation Pumps

**NCL 40-175/340**

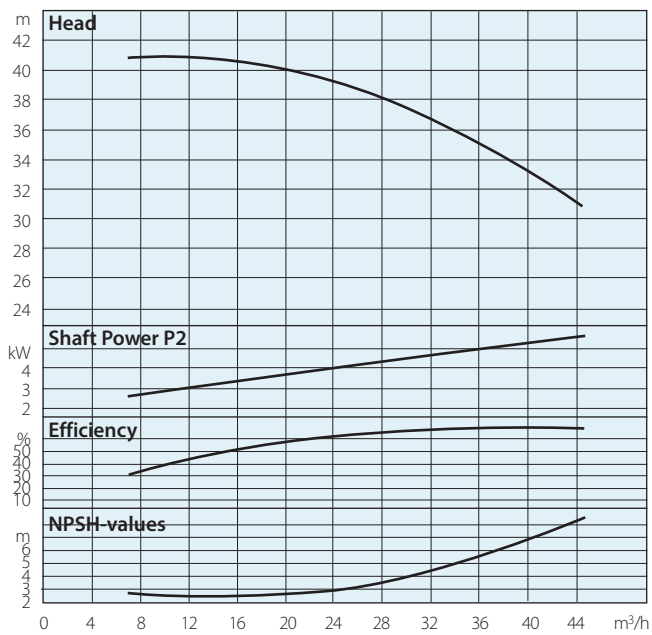

# NCL

## Inline, Dry Running Circulation Pumps

**NCL 50-115/280**

**NCL 50-120/340**

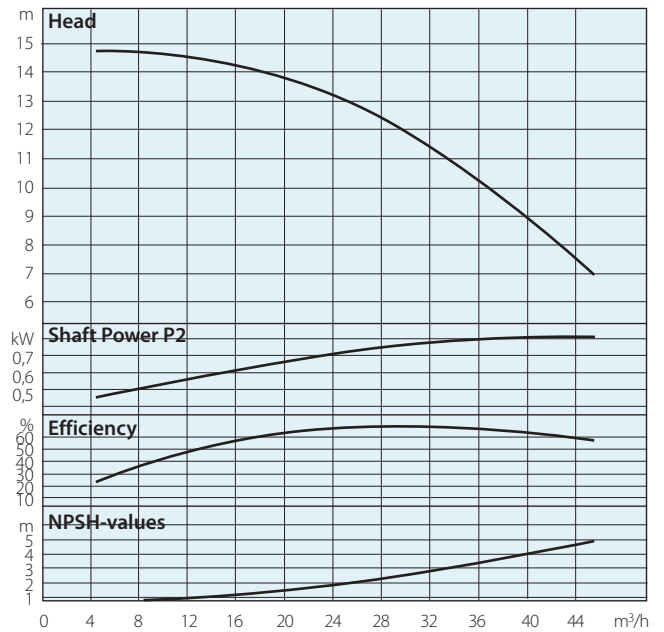
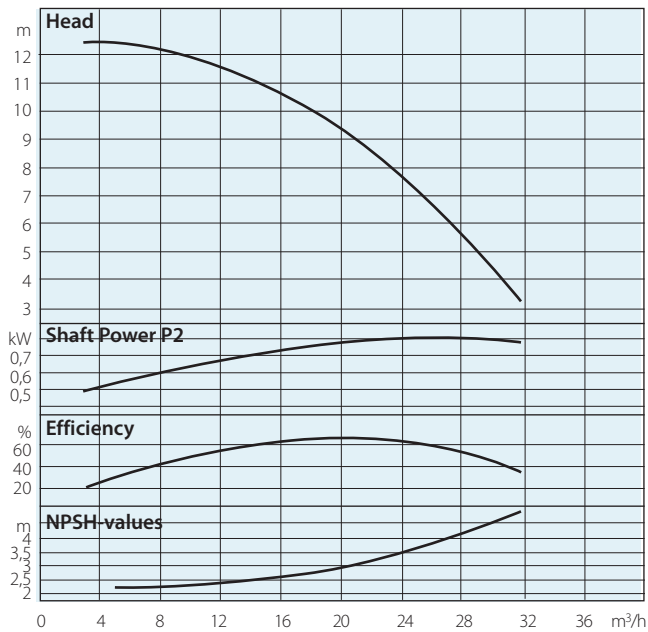

**NCL 50-130/340**

**NCL 50-140/340**

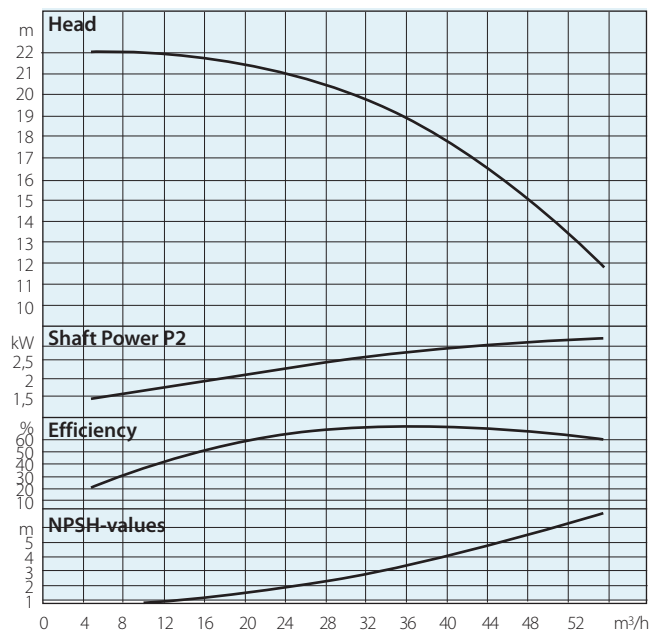
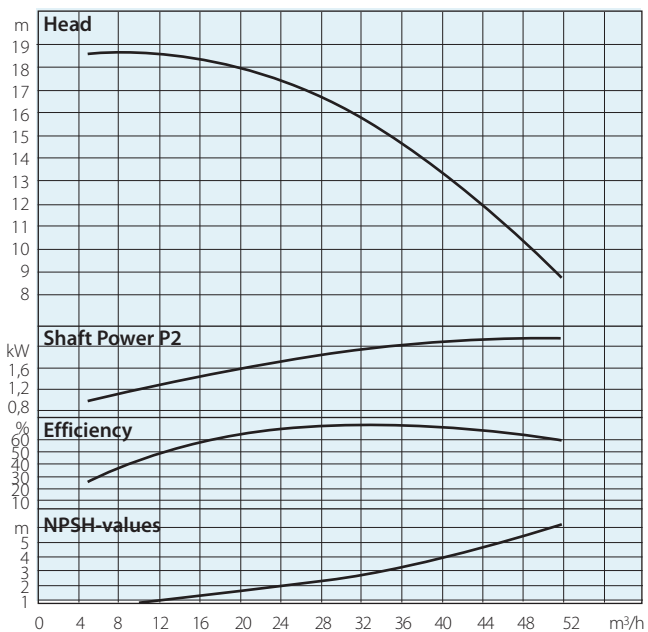

# NCL

## Inline, Dry Running Circulation Pumps

**NCL 50-150/340**

**NCL 50-155/340**

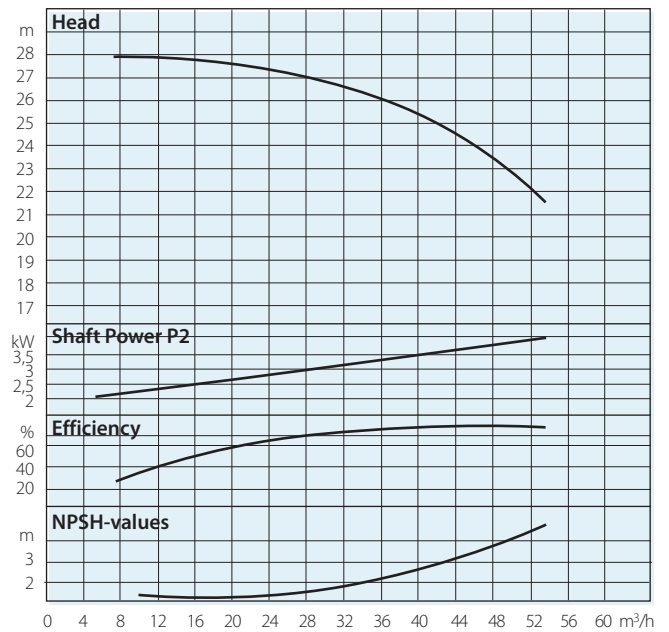
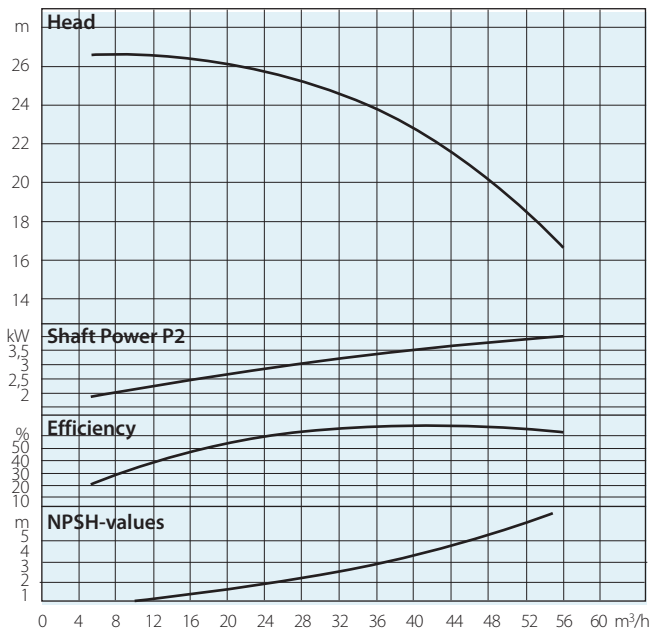

**NCL 50-165/340**

**NCL 50-175/340**

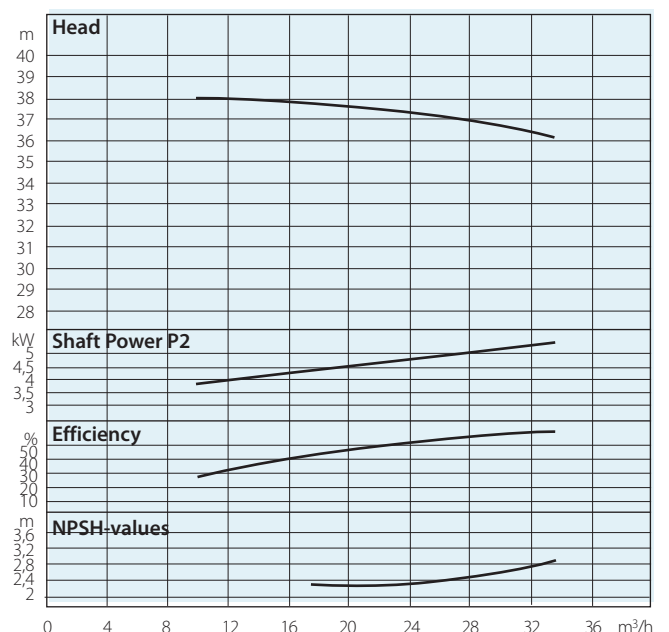
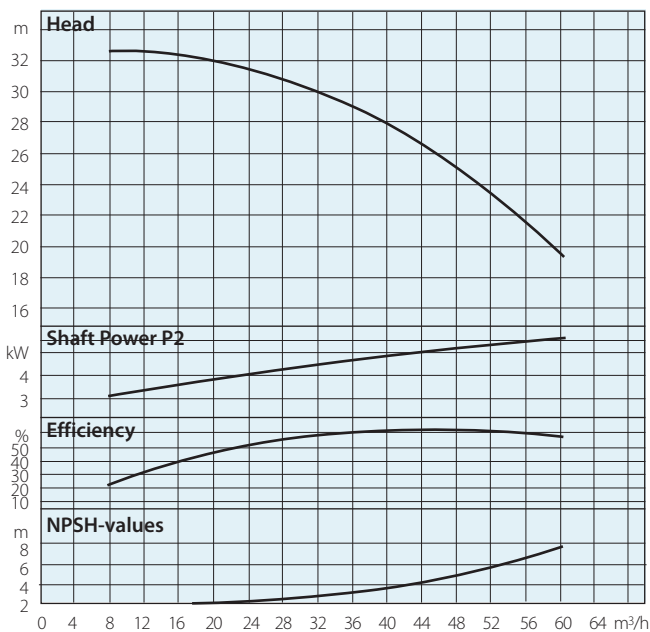

# NCL

## Inline, Dry Running Circulation Pumps

**NCL 50-175/340**

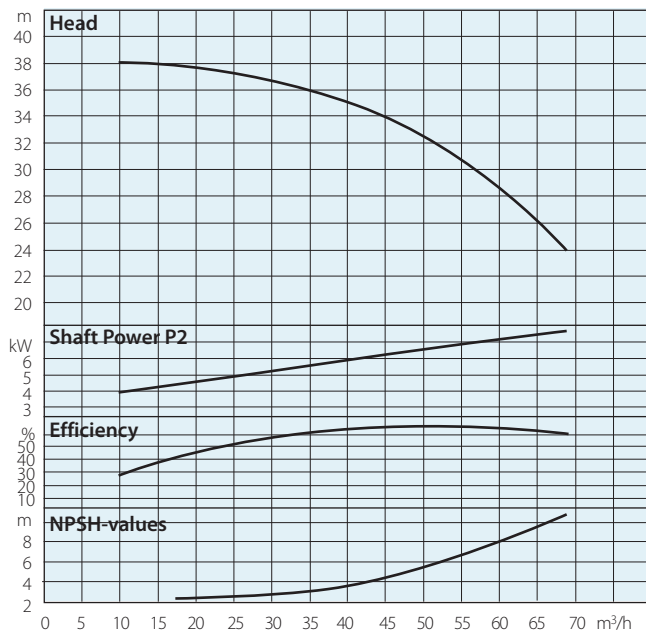

# NCL

## Inline, Dry Running Circulation Pumps

**NCL 65-115/340**

**NCL 65-120/340**

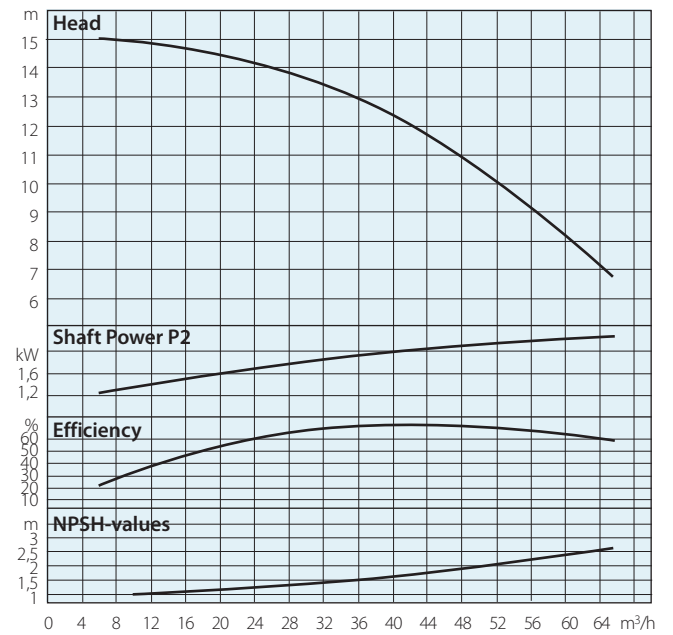
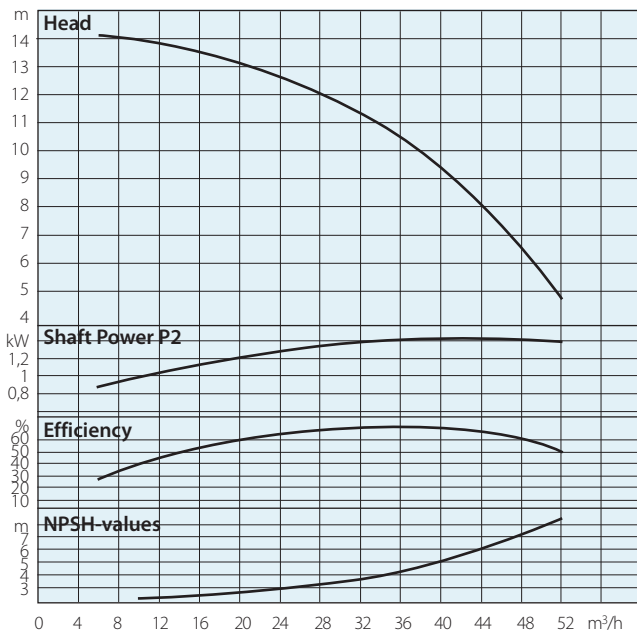

**NCL 65-130/340**

**NCL 65-140/340**

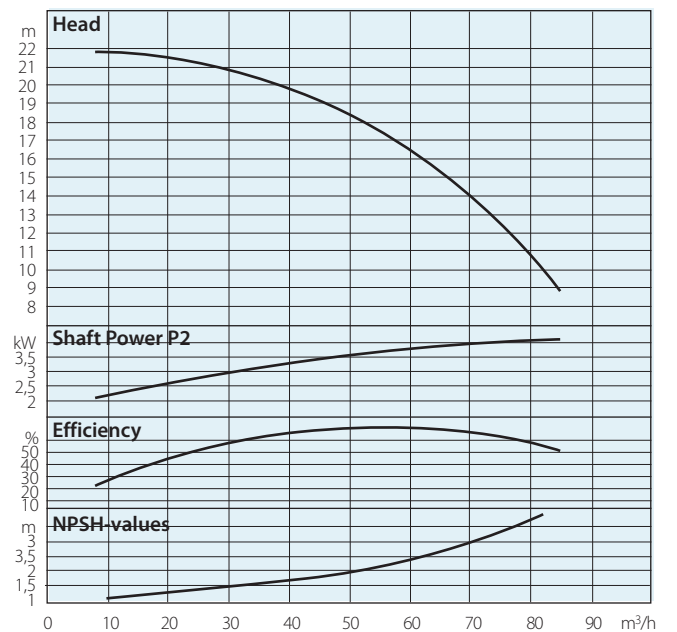
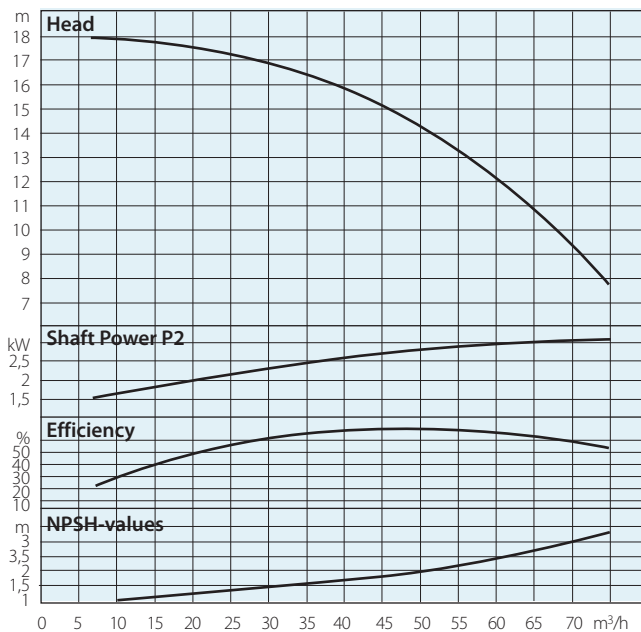

# NCL

## Inline, Dry Running Circulation Pumps

**NCL 65-145/340**

**NCL 65-155/340**

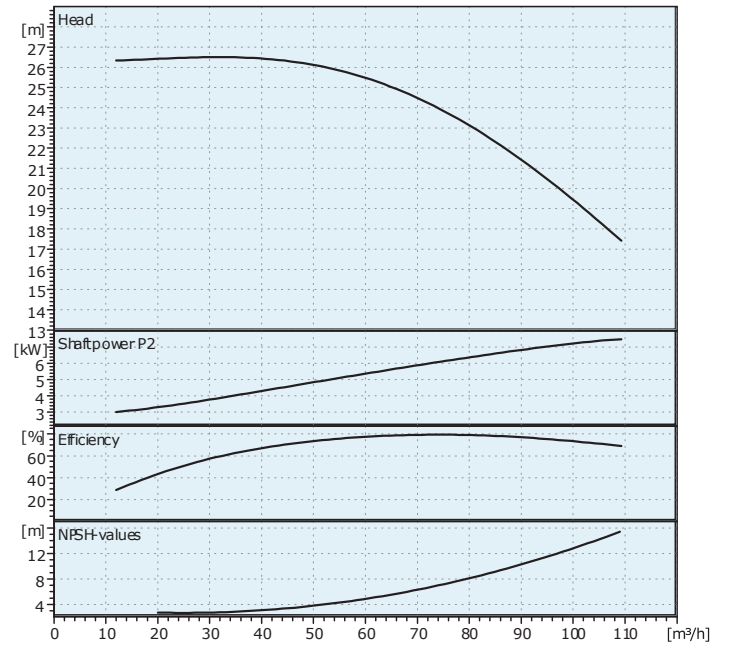
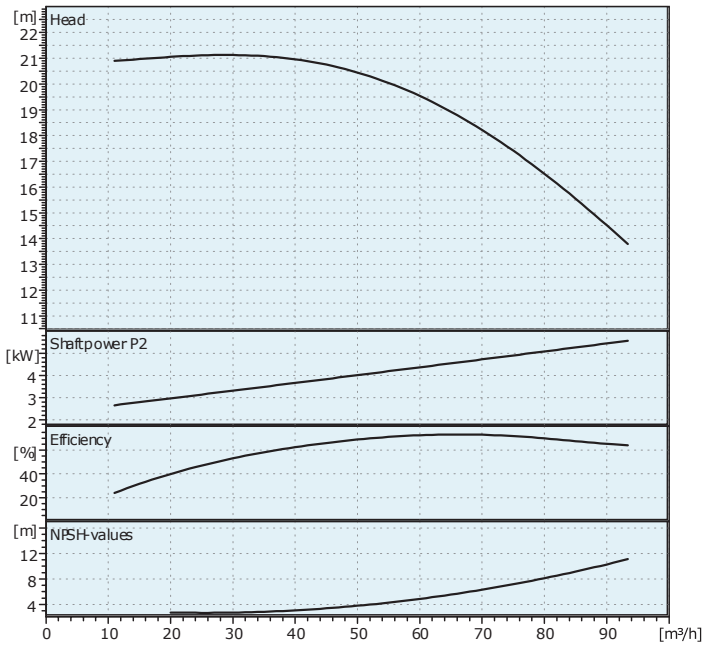



# NCL

## Inline, Dry Running Circulation Pumps

**NCL 80-115/360**

**NCL 80-130/360**

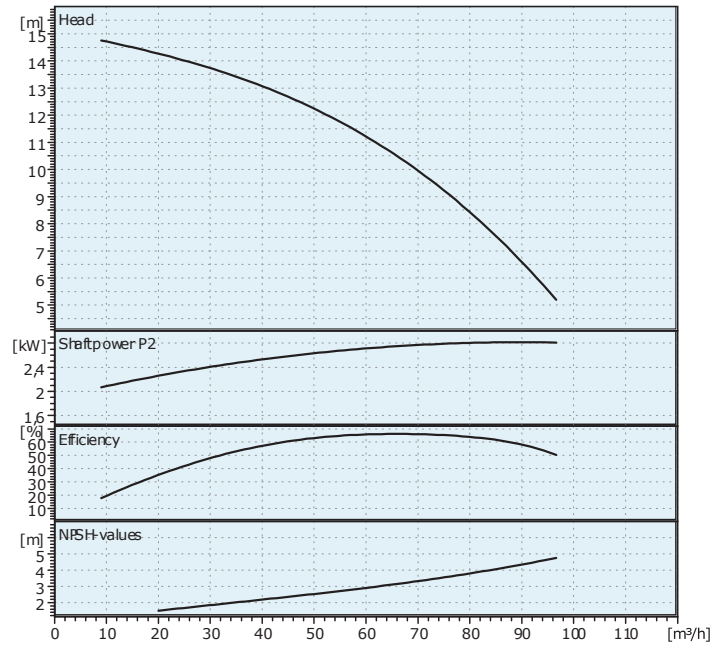
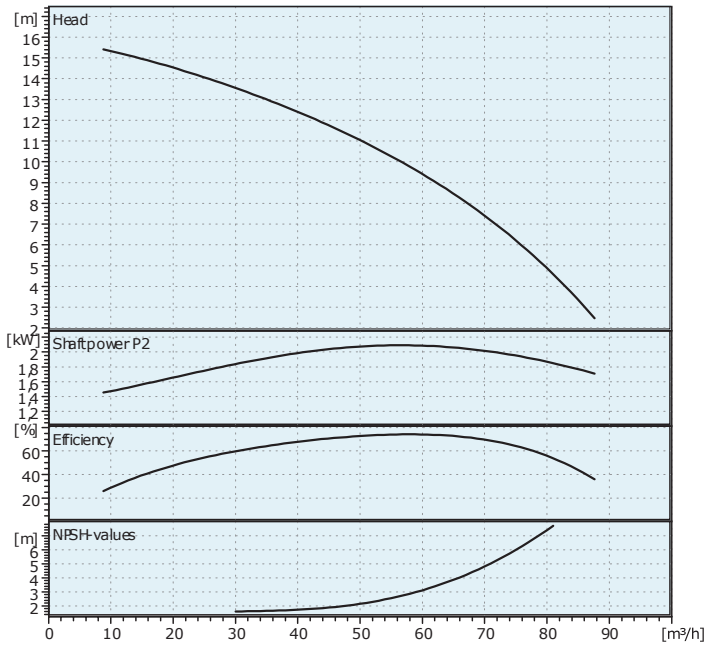

**NCL 80-140/360**

**NCL 80-145/400**

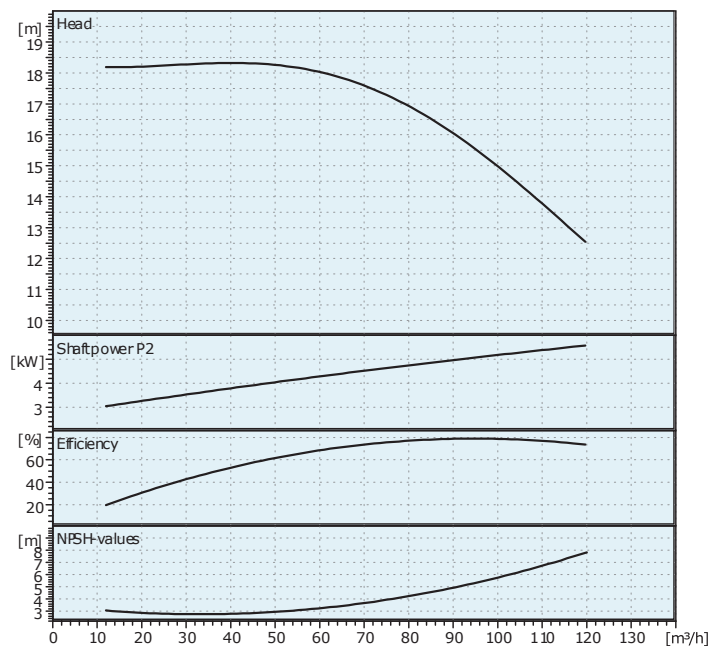
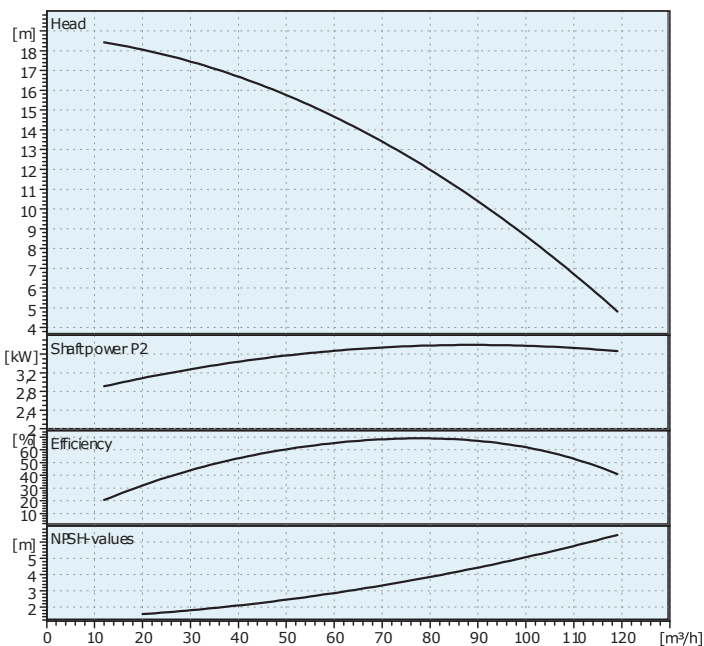

# NCL

## Inline, Dry Running Circulation Pumps

**NCL 80-155/400**

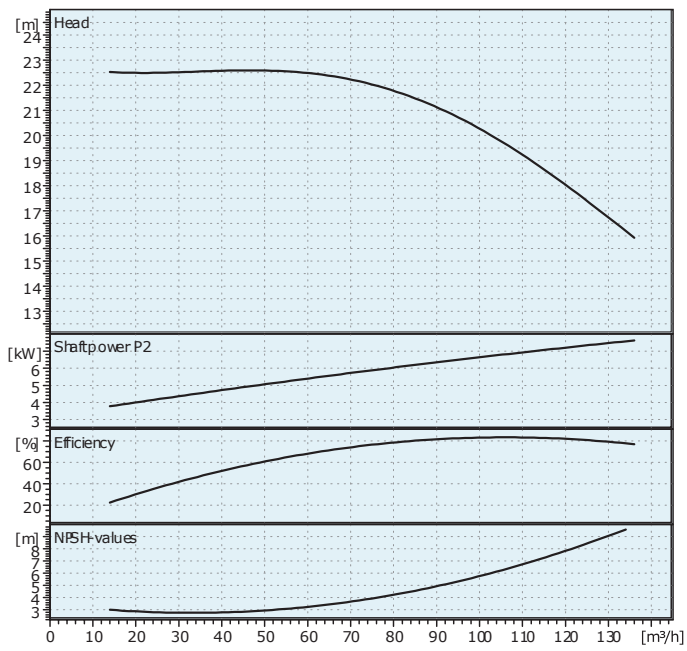

# NCLD

## Inline, Dry Running Circulation Pumps

**NCLD 32-90/260**

**NCLD 32-100/260**

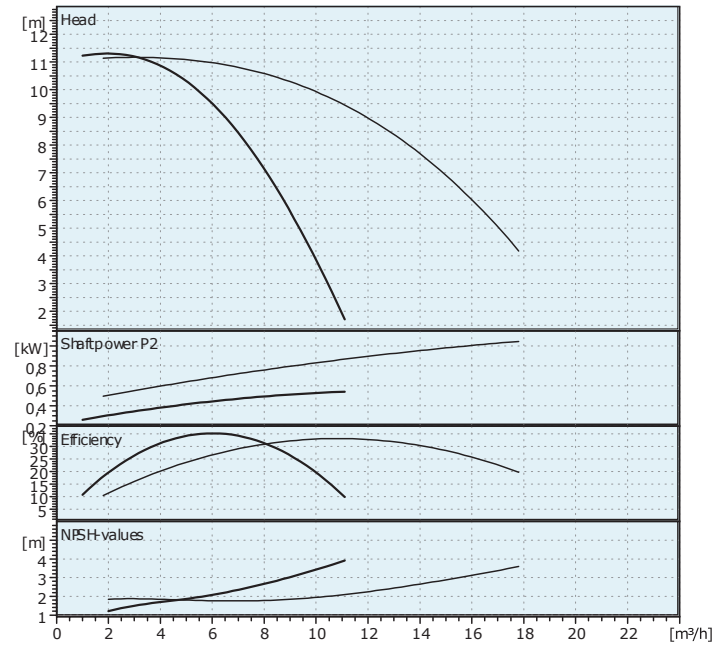
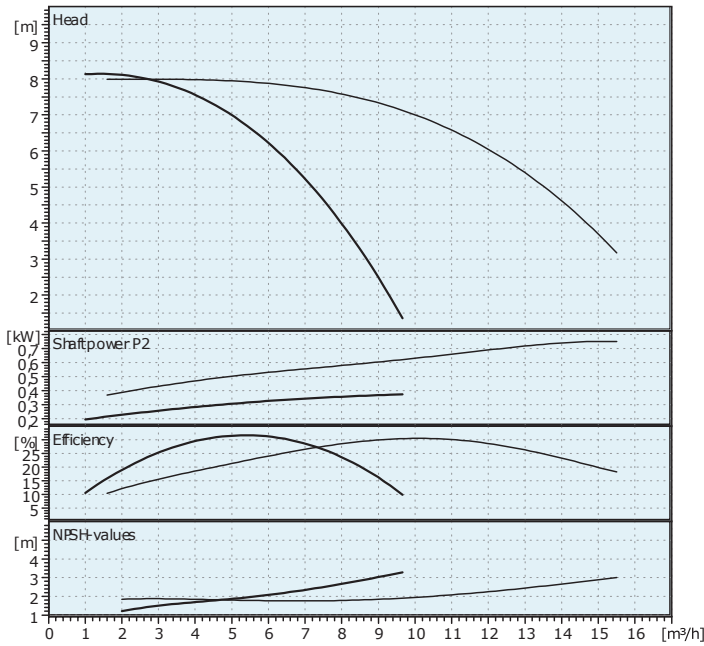

**NCLD 32-110/260**

**NCLD 32-130/260**

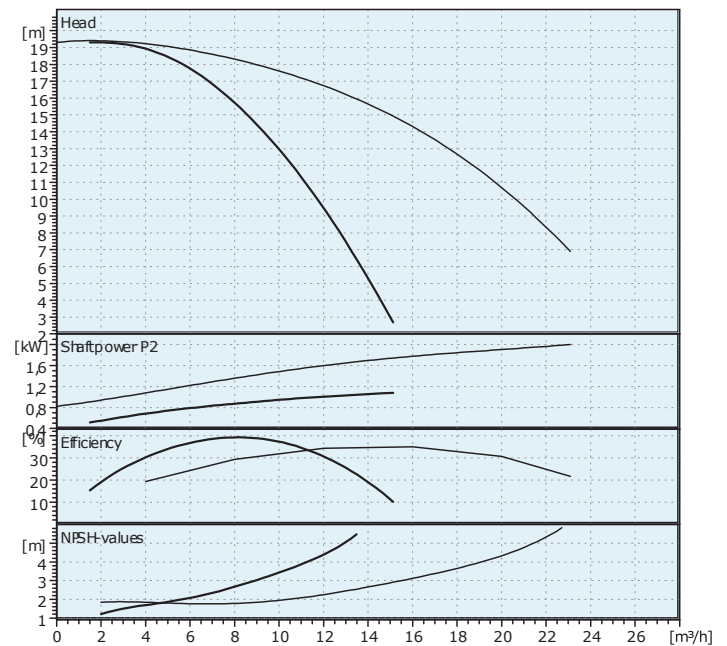
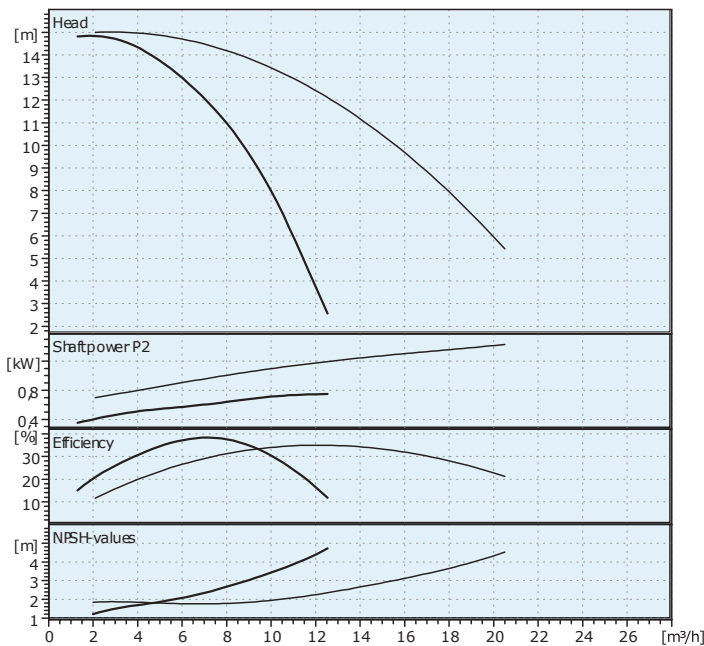

# NCLD

## Inline, Dry Running Circulation Pumps

**NCLD 32-160/260**

**NCLD 32-165/320**

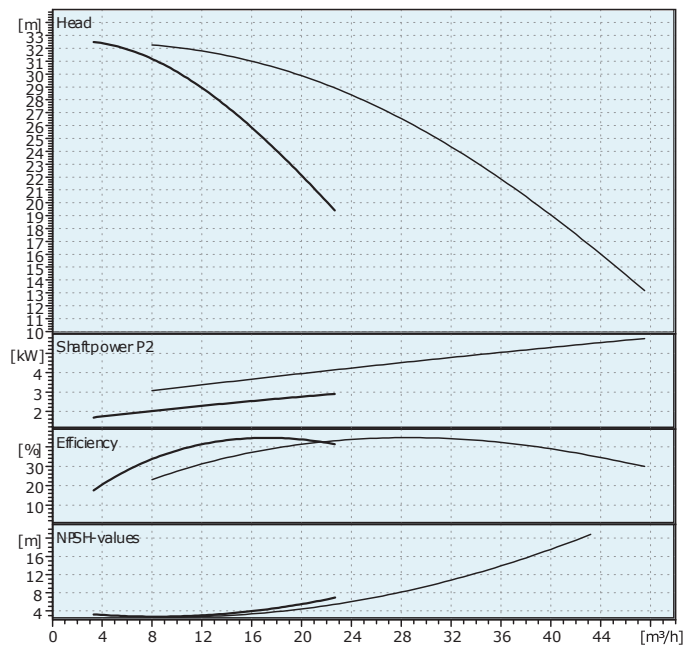
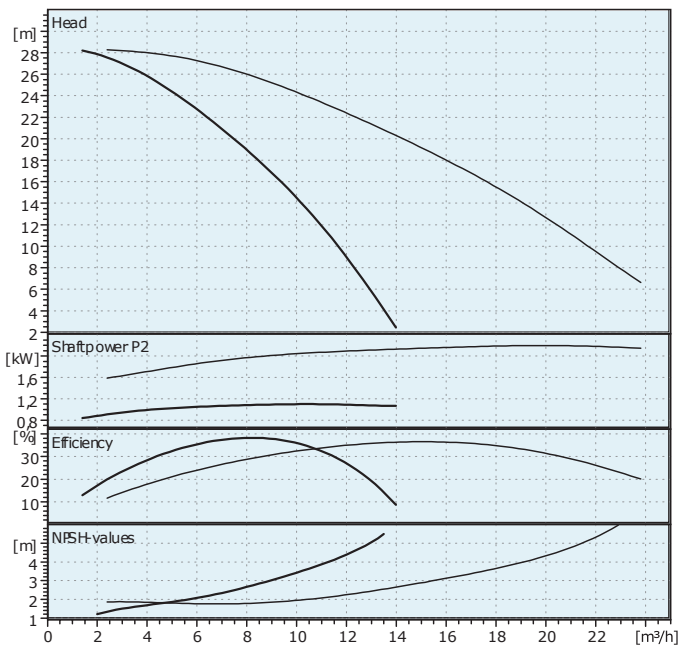

**NCLD 32-175/320**

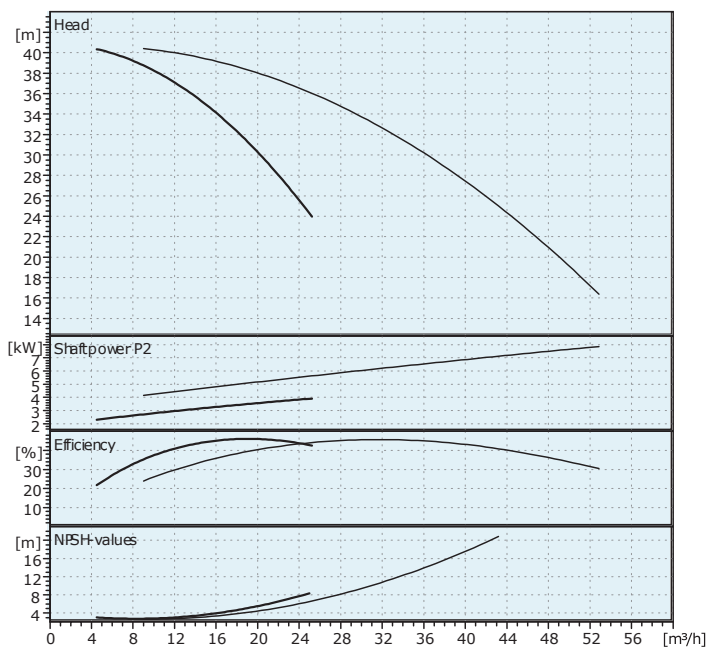

# NCLD

## Inline, Dry Running Circulation Pumps

**NCLD 40-90/250**

**NCLD 40-115/250**

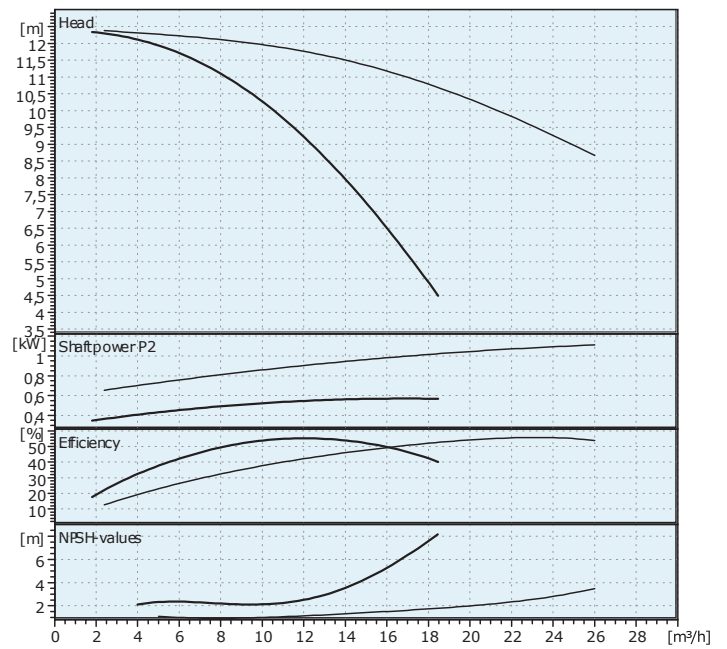
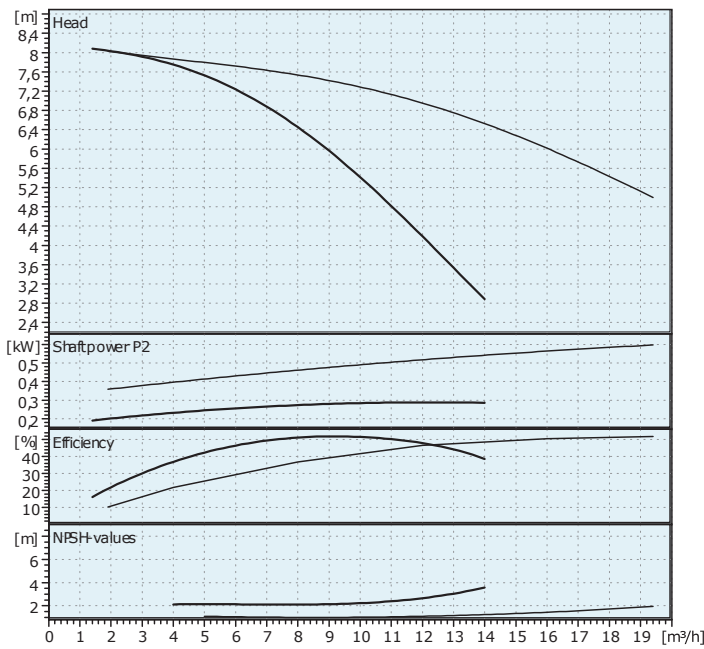

**NCLD 40-120/320**

**NCLD 40-130/320**

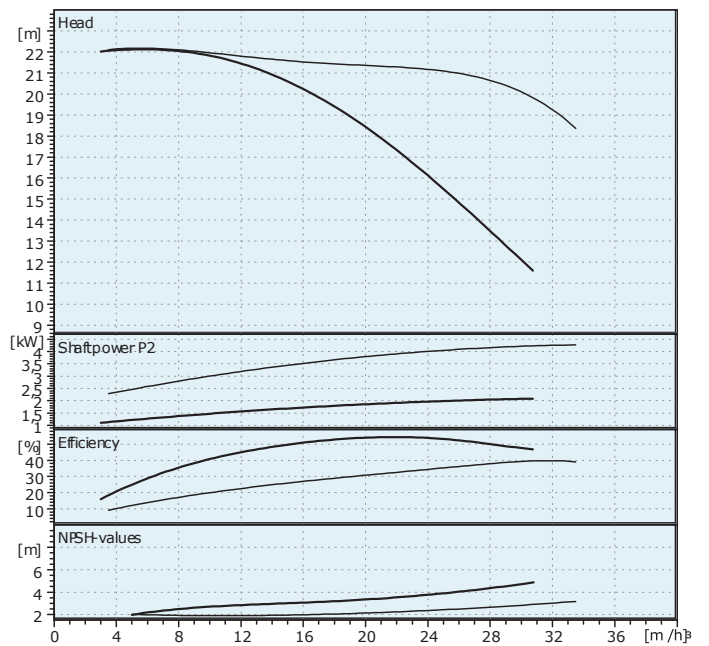
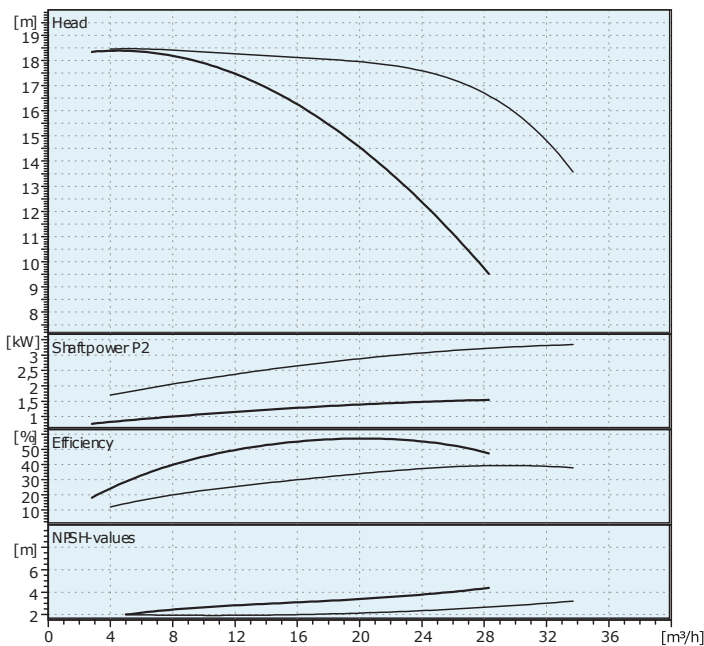

# NCLD

## Inline, Dry Running Circulation Pumps

**NCLD 40-150/320**

**NCLD 40-160/320**

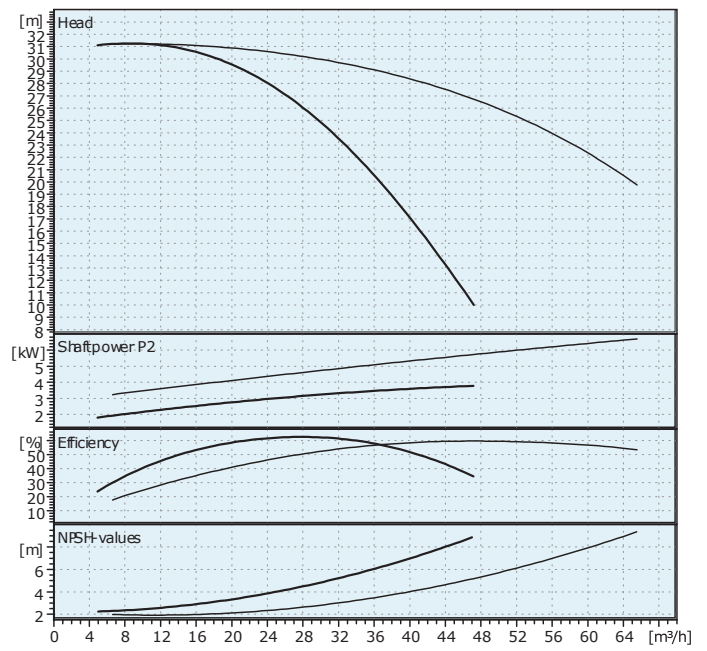
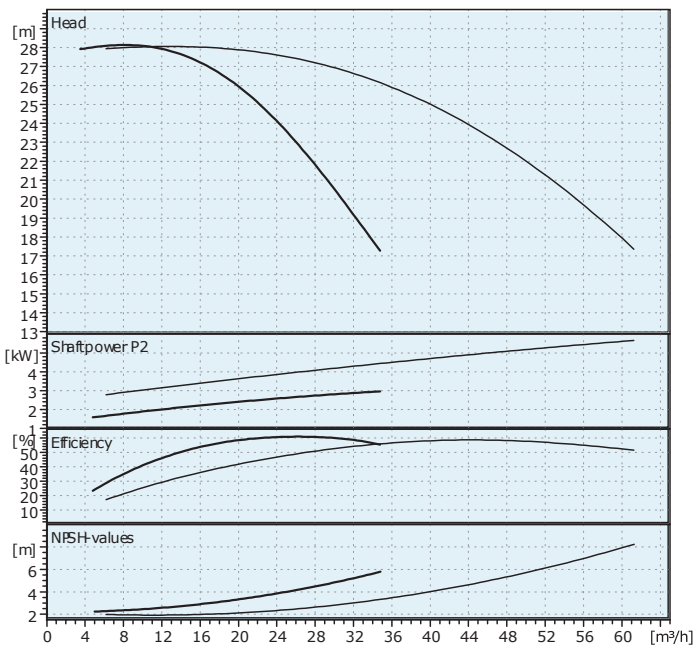

**NCLD 40-165/340**

**NCLD 40-175/340**

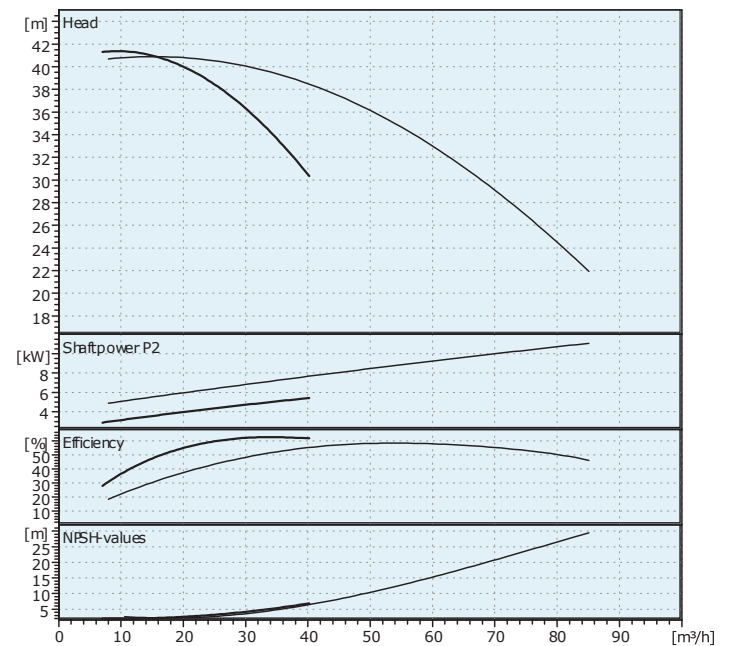
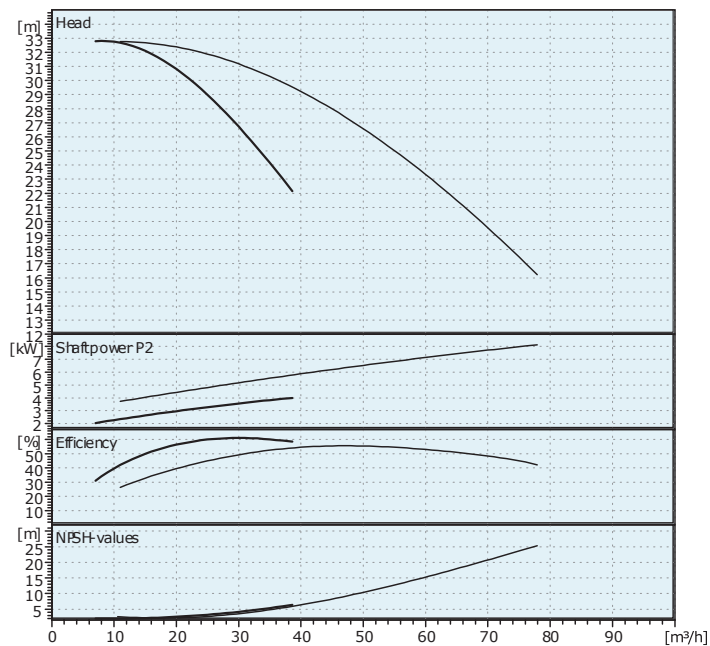

# NCLD

## Inline, Dry Running Circulation Pumps

**NCLD 50-115/280**

**NCLD 50-120/340**

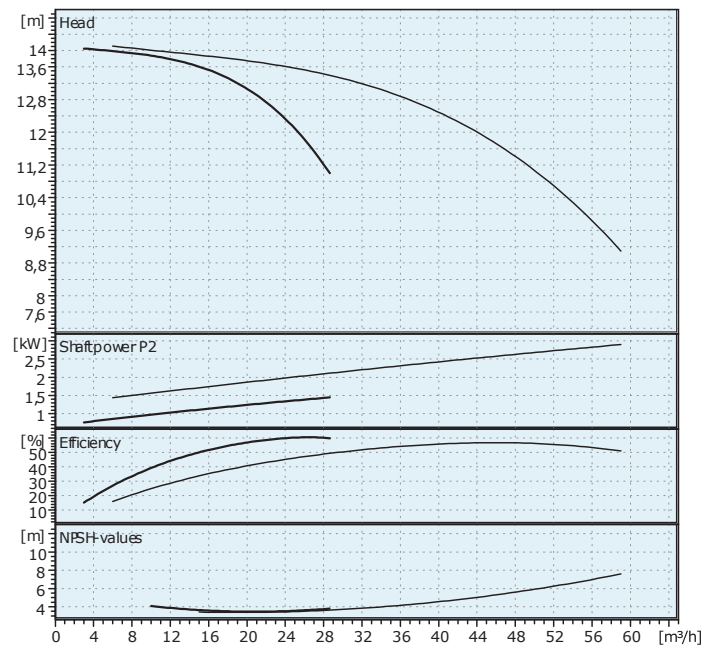
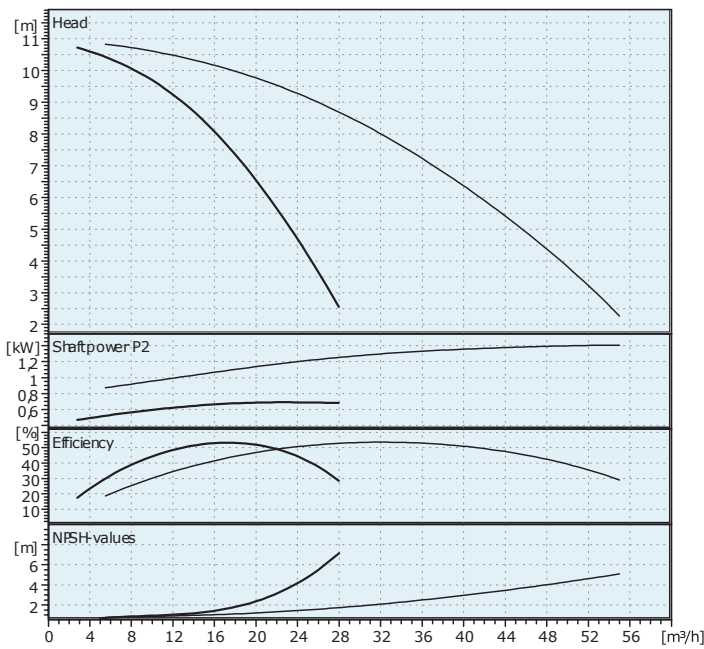

**NCLD 50-130/340**

**NCLD 50-140/340**

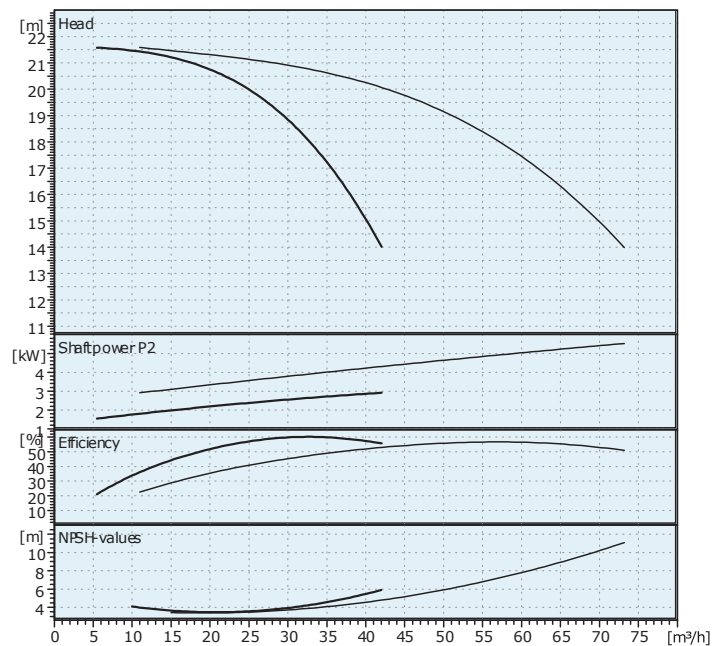
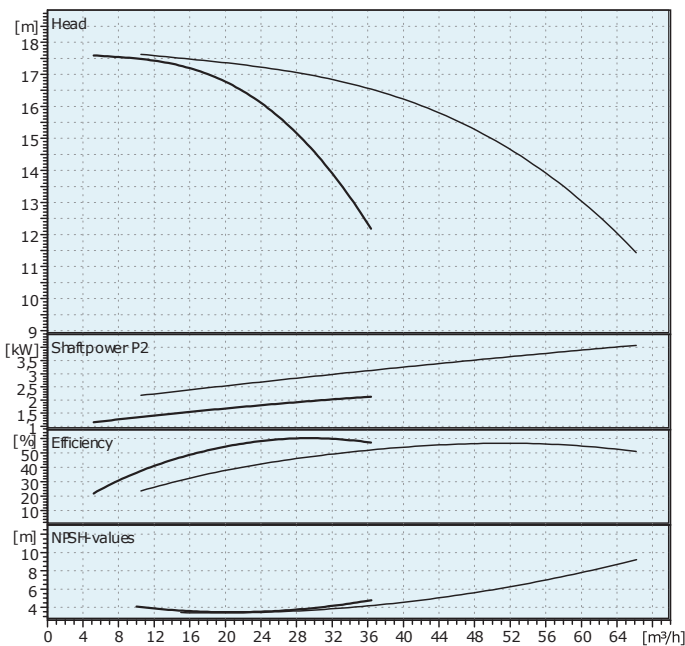

# NCLD

## Inline, Dry Running Circulation Pumps

**NCLD 50-150/340**

**NCLD 50-155/340**

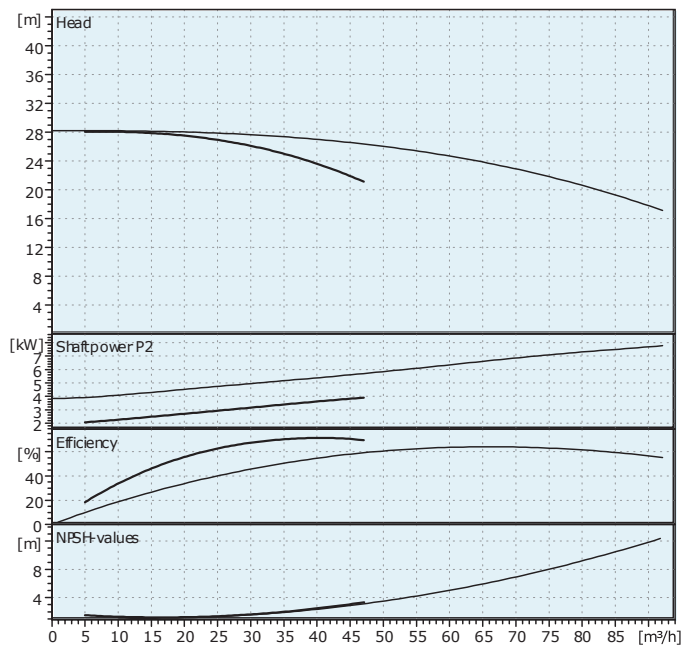
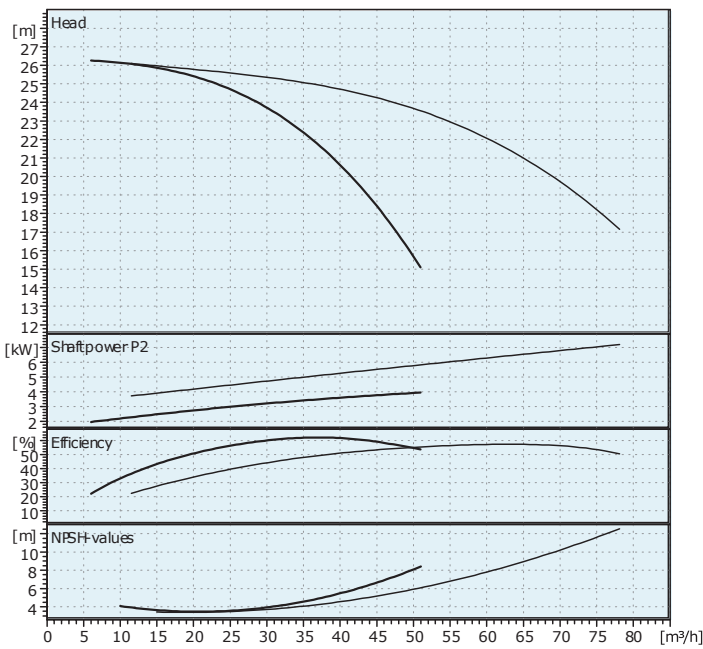

**NCLD 50-165/340**

**NCLD 50-175/340**

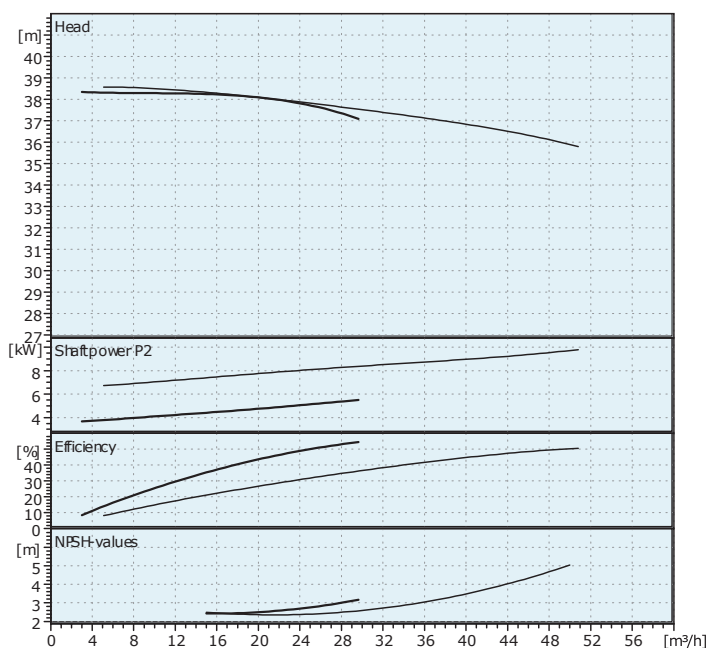
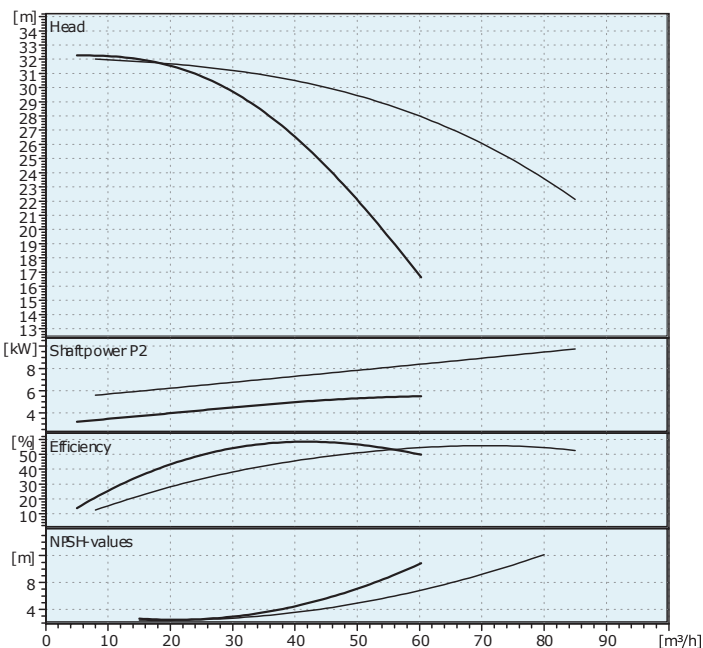



# NCLD

## Inline, Dry Running Circulation Pumps

**NCLD 50-175/340**

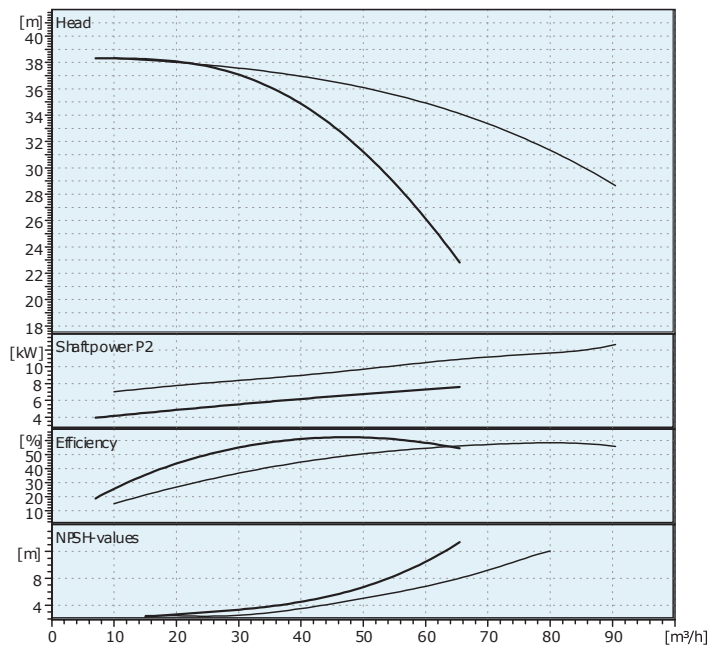

# NCLD

## Inline, Dry Running Circulation Pumps

**NCLD 65-115/340**

**NCLD 65-120/340**

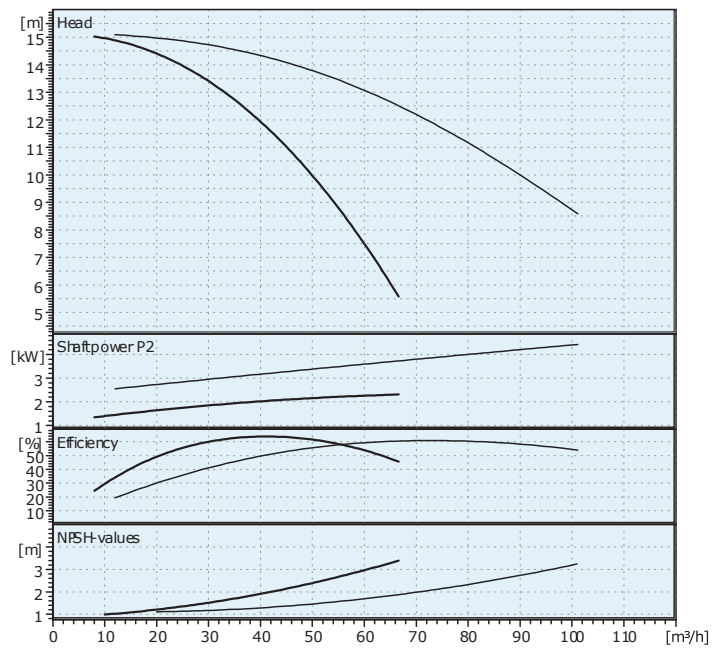
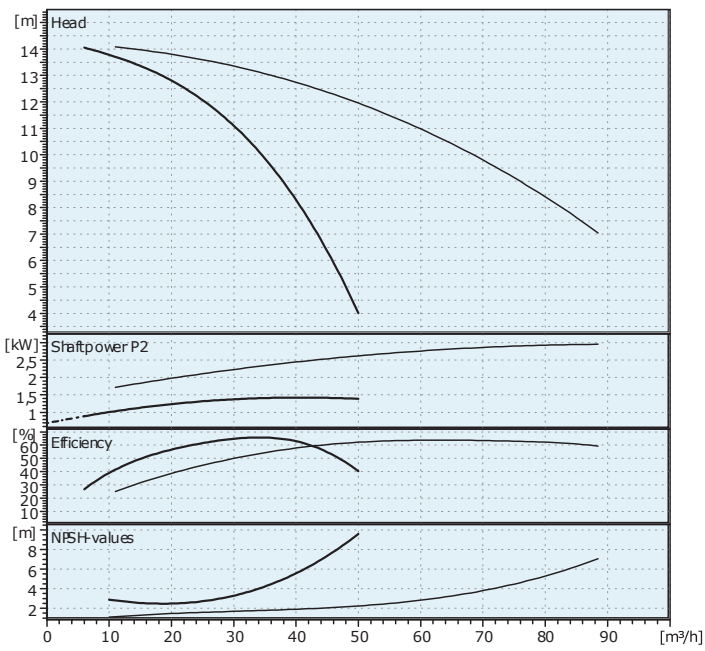

**NCLD 65-130/340**

**NCLD 65-140/340**

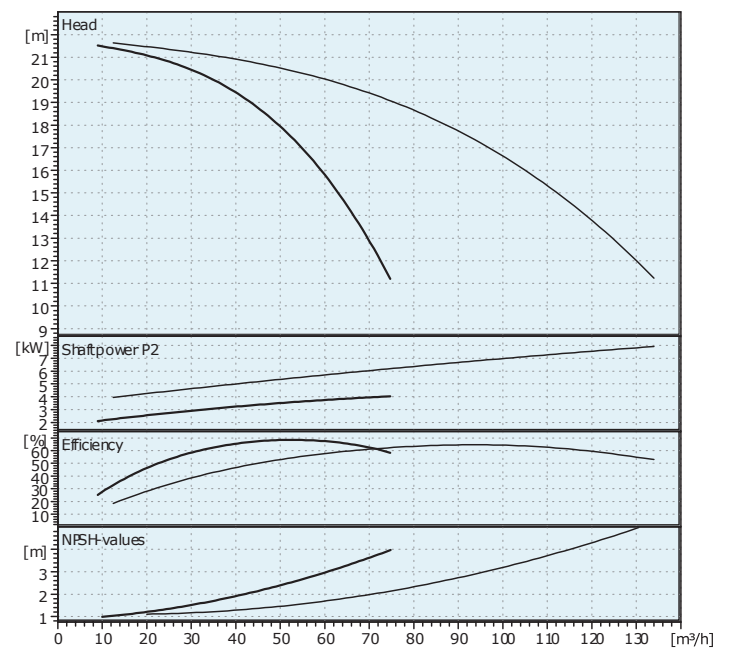
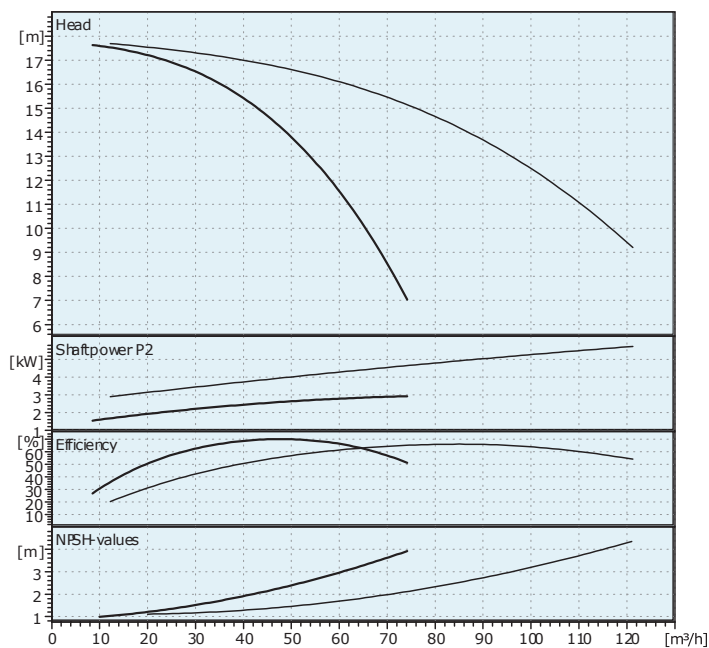

# NCLD

## Inline, Dry Running Circulation Pumps

**NCLD 65-145/340**

**NCLD 65-155/340**

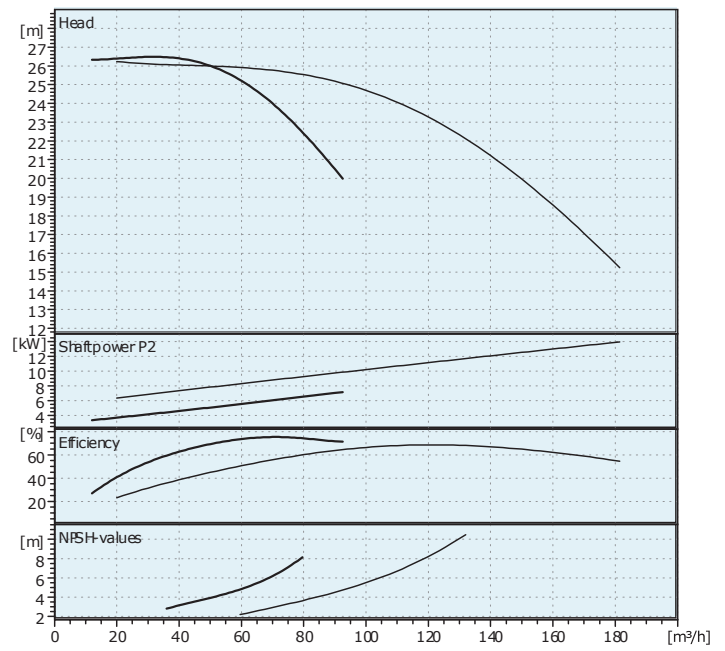
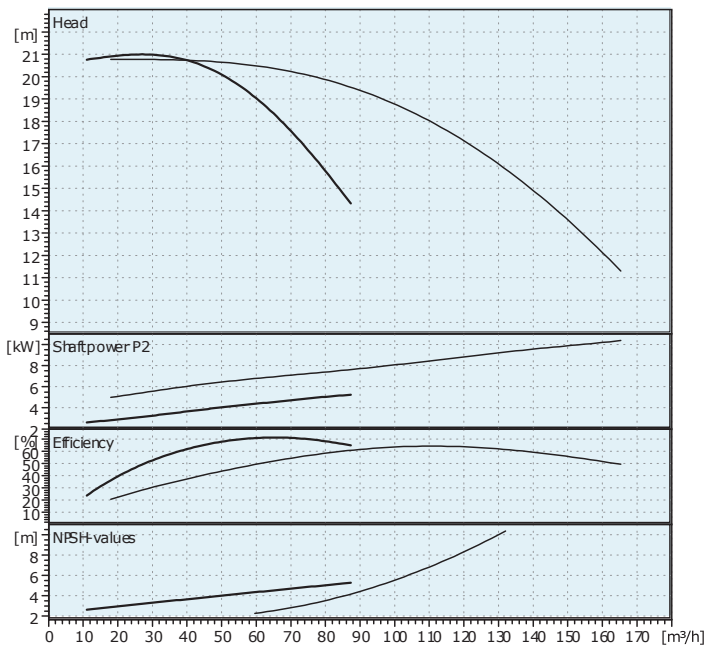

# NCLD

## Inline, Dry Running Circulation Pumps

**NCLD 80-115/360**

**NCLD 80-130/360**

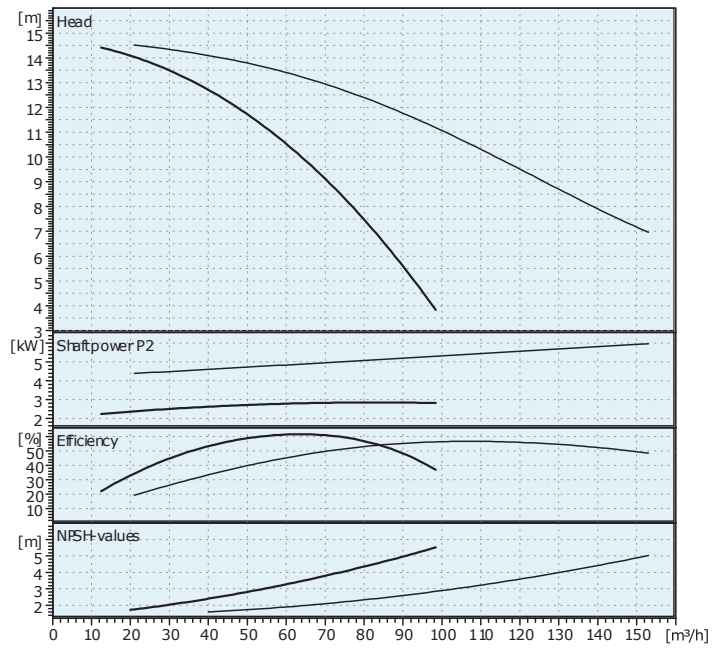
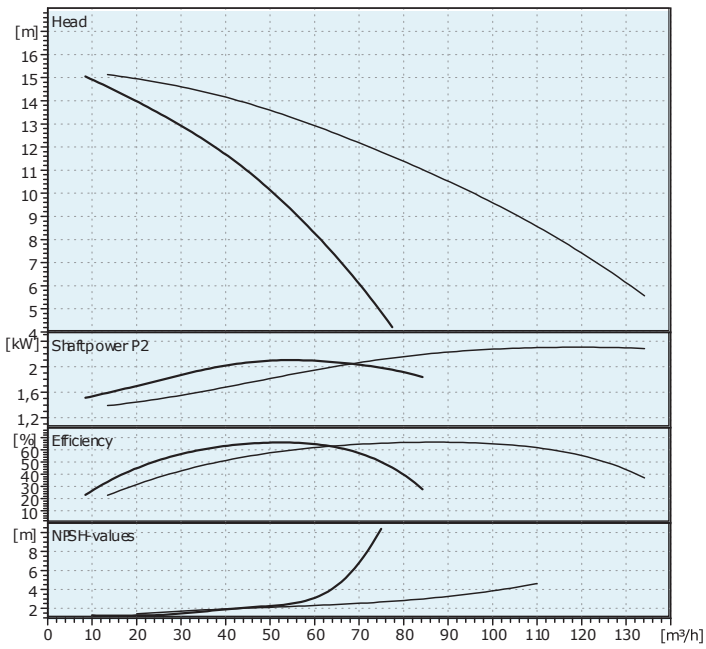

**NCLD 80-140/360**

**NCLD 80-145/400**

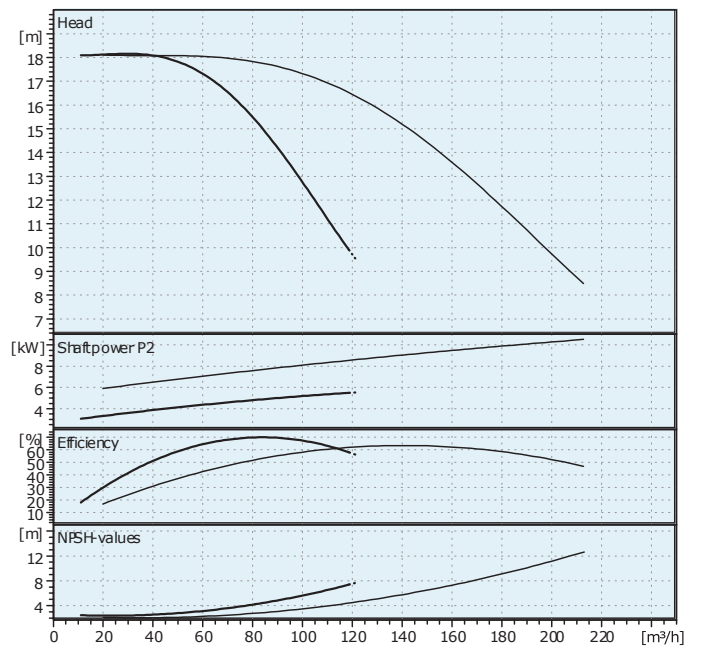
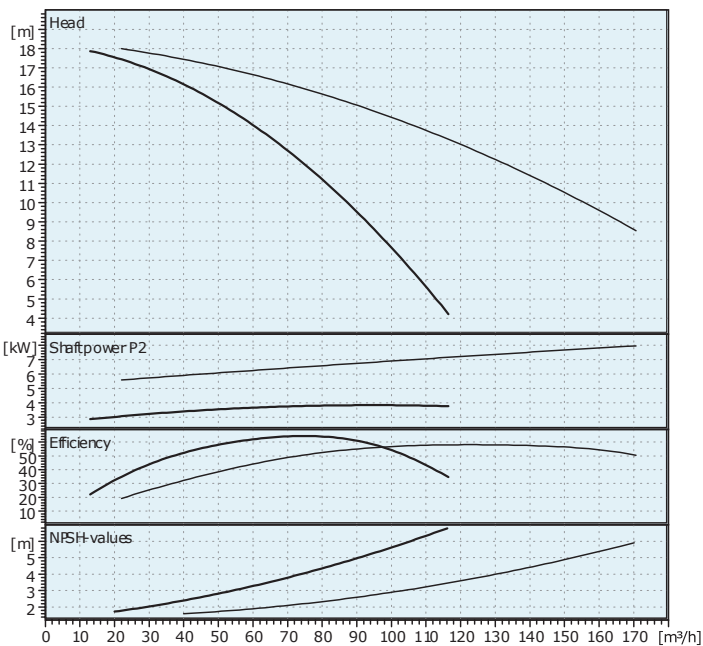

# NCLD

## Inline, Dry Running Circulation Pumps

### NCLD 80-155/400

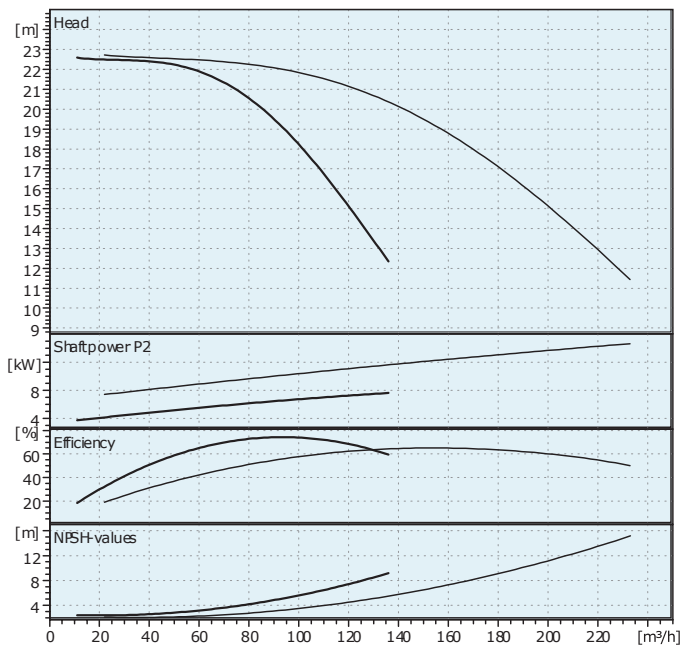

# NCLD

## Inline, Dry Running Circulation Pumps

### Sectional Drawing

**NCL**

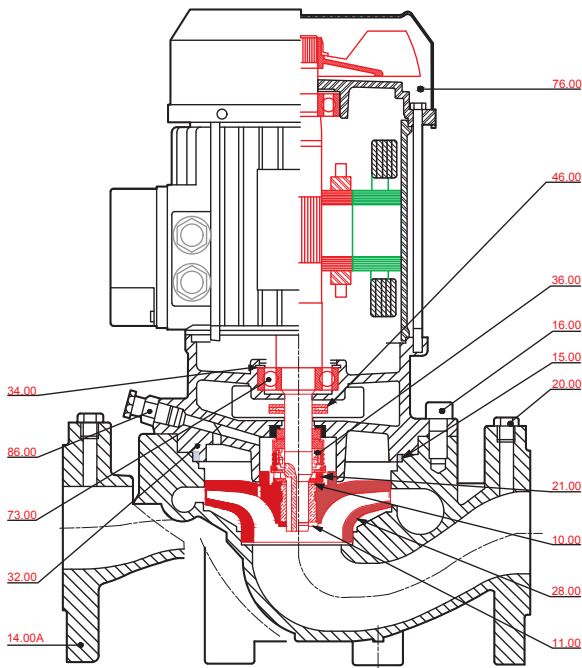

**NCLD**

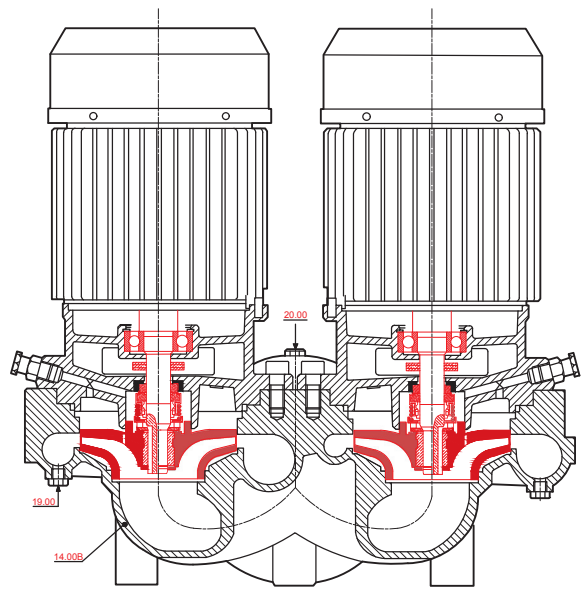

**MECHANICAL SEAL**

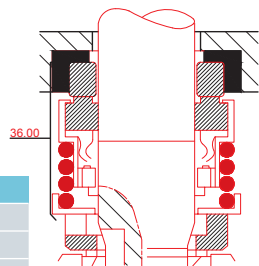

**MECHANICAL SEAL**

**DETAILS OF OUTLET**

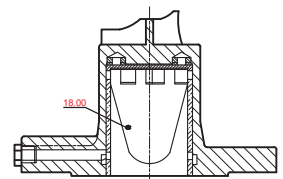
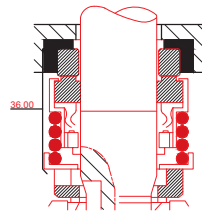

**List**

14.00A	Single pump housing
14.00B	Double pump housing
28.00	Impeller
46.00	Deflector
73.00	Guide bearing
32.00	Bearing lantern
36.00	Mechanical seal
15.00	O-ring pump housing
11.00	Snap ring on shaft
10.00	Snap ring on shaft
34.00	Circlip of bearing
76.00	Electric motor
20.00	Plug for pressure gauge take-off
19.00	Drain plugs (NCLD)
86.00	Air release plug
18.00	Outlet valve (NCLD)
16.00	Bearing lantern retaining screw
21.00	Axial bearing of mechanical seal
Spare parts recommended	

**List**

14.00A	Single pump housing
14.00B	Double pump housing
28.00	Impeller
46.00	Deflector
73.00	Guide bearing
32.00	Bearing lantern
36.00	Mechanical seal
15.00	O-ring pump housing
11.00	Snap ring on shaft
10.00	Snap ring on shaft
34.00	Circlip of bearing
76.00	Electric motor
20.00	Plug for pressure gauge take-off
19.00	Drain plugs (NCLD)
86.00	Air release plug
18.00	Outlet valve (NCLD)
16.00	Bearing lantern retaining screw
21.00	Axial bearing of mechanical seal
Spare parts recommended	

# NCL

## Inline, Dry Running Circulation Pumps

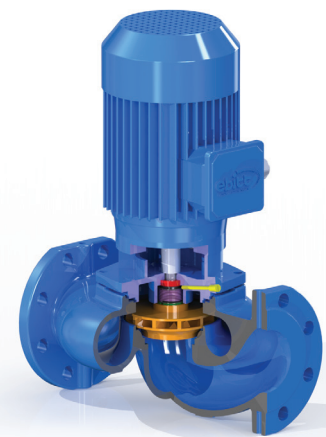
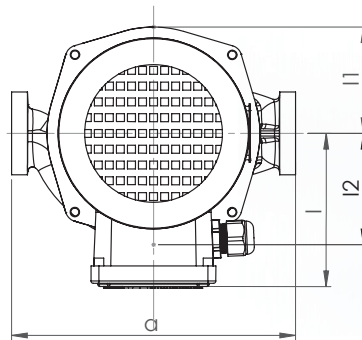
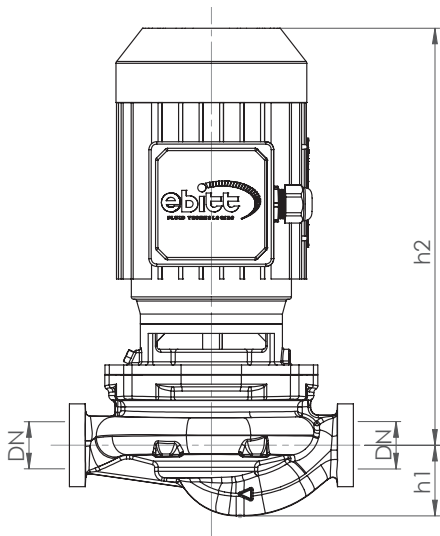

Model	DN	a	l	l1	l2	h1	h2	f	x	M-	b	b1	kg
NCL 25-70/180-0,12	1"/G 1½	180	76	66	57	34	247	281	100	M10			7
NCL 25-80/180-0,12	1"/G 1½	180	76	66	57	52	247	299	100	M10			7
NCL 25-85/180-0,18	1"/G 1½	180	107	69	68	52	251	303	150	M10			8,7
NCL 25-90/180-0,25	1"/G 1½	180	107	69	68	52	251	303	150	M10			9,4
NCL 30-70/180-0,12	1¼"/G 2	180	76	66	57	34	247	281	100	M10			7
NCL 30-80/180-0,12	1¼"/G 2	180	76	66	57	52	247	299	100	M10			7
NCL 30-85/180-0,18	1¼"/G 2	180	107	69	68	52	251	303	150	M10			8,7
NCL 30-90/180-0,25	1¼"/G 2	180	107	69	68	52	251	303	150	M10			9,4
NCL 32-90/260-0,37	32	260	121	101	106	70	321	391	150	M10	90	90	20,5
NCL 32-100/260-0,55	32	260	121	101	106	70	321	391	150	M10	90	90	21,5
NCL 32-110/260-0,75	32	260	128	101	106	70	341	411	150	M10	90	90	25,5
NCL 32-130/260-1,1	32	260	128	101	106	70	341	411	150	M10	90	90	26,1
NCL 32-160/260-1,1	32	260	128	101	106	70	341	391	150	M10	90	90	26,1
NCL 32-165/320-3	32	320	160	112	124	100	396	496	90	M10	200	120	46,1
NCL 32-175/320-4	32	320	168	112	124	100	412	512	90	M10	200	120	53,4
NCL 40-70/220-0,12	40	220	76	75	84	65	259	324	150	M10			12,5
NCL 40-90/250-0,37	40	250	121	80	90	65	320	385	150	M10			19
NCL 40-115/250-0,55	40	250	121	80	90	65	320	385	150	M10			20,1
NCL 40-120/320-1,5	40	320	151	113	121	75	373	448	150	M10	90	90	29,5
NCL 40-130/320-2,2	40	320	151	113	121	75	374	449	150	M10	90	90	31,5
NCL 40-150/320-3	40	320	160	113	121	75	386	461	150	M10	90	90	37,5
NCL 40-160/320-4	40	320	168	113	121	75	419	494	150	M10	90	90	43,5
NCL 40-165/340-4	40	340	168	113	129	82	426	508	150	M10	207	130	57,3

# NCL

## Inline, Dry Running Circulation Pumps

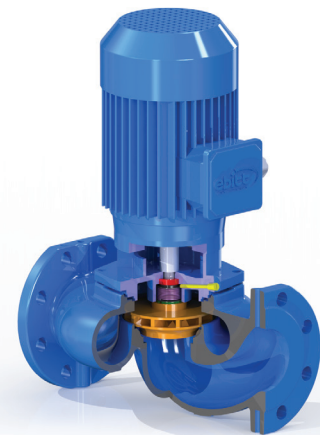
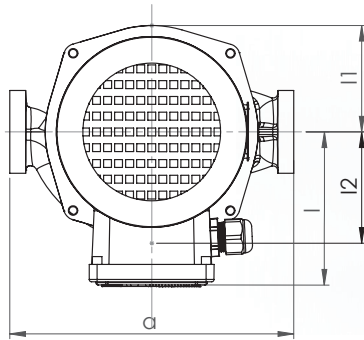
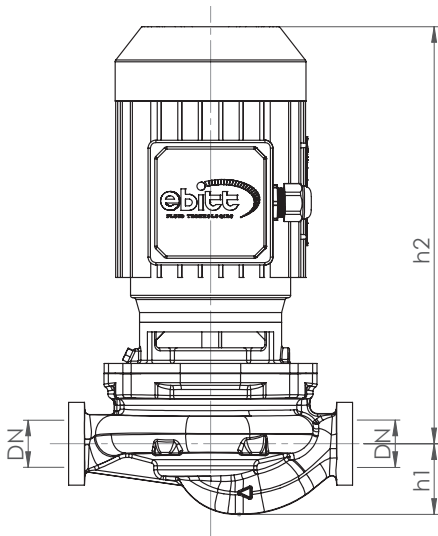

Model	DN	a	l	l1	l2	h1	h2	f	x	M-	b	b1	kg
NCL 40-175/340-5,5	40	340	182	113	129	82	511	593	150	M10	207	130	68,6
NCL 50-115/280-0,75	50	280	128	91	101	75	346	421	150	M10	250		23
NCL 50-120/340-1,5	50	340	151	116	131	86	375	461	150	M10	90	104	36
NCL 50-130/340-2,2	50	340	151	116	131	86	375	461	150	M10	90	104	37
NCL 50-140/340-3	50	340	160	116	131	86	388	474	150	M10	90	104	42
NCL 50-150/340-4	50	340	168	116	131	86	422	508	150	M10	90	104	49
NCL 50-155/340-4	50	340	168	102	119	105	463	568	150	M10	170	140	66
NCL 50-165/340-5,5	50	340	188	120	138	103	526	629	150	M10	191	164	77
NCL 50-175/340-5,5	50	340	188	120	138	103	526	629	150	M10	191	164	77
NCL 50-175/340-7,5	50	340	188	120	138	103	526	629	150	M10	191	164	84
NCL 65-115/340-1,5	65	340	151	100	118	80	387	467	150	M10	310		35
NCL 65-120/340-2,2	65	340	151	119	138	93	381	474	150	M10	95	135	37
NCL 65-130/340-3	65	340	160	119	138	93	394	487	150	M10	95	135	43
NCL 65-140/340-4	65	340	168	119	138	93	427	520	150	M10	95	135	49
NCL 65-145/340-5,5	65	340	188	112	134	120	531	651	150	M12	200	140	75
NCL 65-155/340-7,5	65	340	188	112	134	120	531	651	150	M12	200	140	83
NCL 80-115/360-2,2	80	360	151	110	133	98	389	487	150	M10	330		42
NCL 80-130/360-3	80	360	160	125	153	105	400	505	150	M10	95	135	47
NCL 80-140/360-4	80	360	168	125	153	105	433	538	150	M10	95	135	53
NCL 80-145/400-5,5	80	360	188	123	151	105	548	653	150	M12	230	180	81
NCL 80-155/400-7,5	80	360	188	123	151	105	548	653	150	M12	230	180	89



# NCLD

## Inline, Dry Running Circulation Pumps

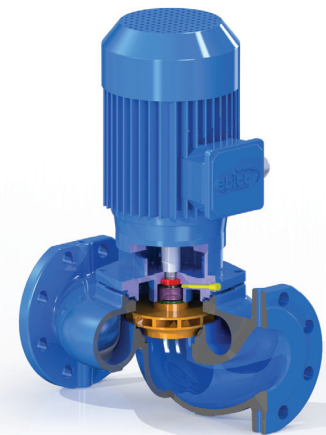
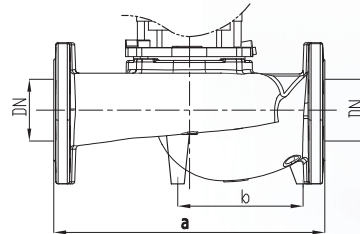
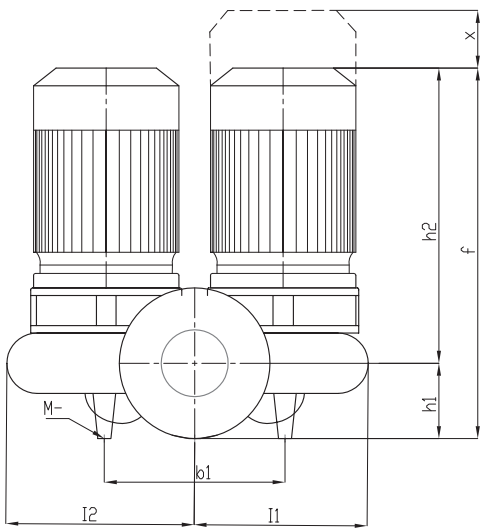

Model	DN	a	l	l1	l2	h1	h2	f	x	M-	b	b1	kg
NCLD 32-90/260-0,37	32	260	121	205	205	70	321	391	150	M10	162	225	36
NCLD 32-100/260-0,55	32	260	121	205	205	70	321	391	150	M10	162	225	38
NCLD 32-110/260-0,75	32	260	128	205	205	70	341	411	150	M10	162	225	46
NCLD 32-130/260-1,1	32	260	128	205	205	70	341	411	150	M10	162	225	48
NCLD 32-160/260-1,1	32	260	128	205	205	70	341	391	150	M10	162	225	43
NCLD 32-165/320-3	32	320	160	270	270	100	396	496	90	M10	180	360	95
NCLD 32-175/320-4	32	320	168	270	270	100	412	512	90	M10	180	360	105
NCLD 40-90/250-0,37	40	250	121	175	175	65	320	385	150	M10	132	225	39
NCLD 40-115/250-0,55	40	250	121	175	175	65	320	385	150	M10	132	225	41
NCLD 40-120/320-1,5	40	320	151	228	228	75	373	448	150	M10	180	240	63
NCLD 40-130/320-2,2	40	320	151	228	228	75	374	449	150	M10	180	240	63
NCLD 40-150/320-3	40	320	160	228	228	75	386	461	150	M10	180	240	75
NCLD 40-160/320-4	40	320	168	228	228	75	419	494	150	M10	180	240	87
NCLD 40-165/340-4	40	340	168	294	294	82	426	508	150	M10	197	400	110
NCLD 40-175/340-5,5	40	340	182	310	310	82	511	593	150	M10	197	400	132
NCLD 50-115/280-0,75	50	280	128	195	195	75	346	421	150	M10	157	228	50
NCLD 50-120/340-1,5	50	340	151	250	250	86	375	461	150	M10	180	240	60
NCLD 50-130/340-2,2	50	340	151	250	250	86	375	461	150	M10	180	240	64
NCLD 50-140/340-3	50	340	160	250	250	86	388	474	150	M10	180	240	76

# NCLD

## Inline, Dry Running Circulation Pumps

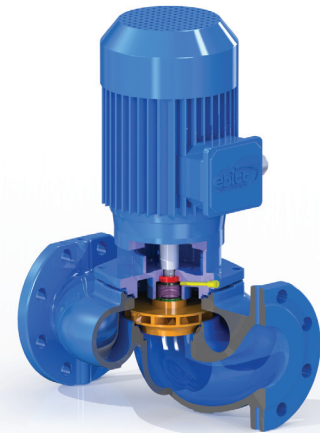
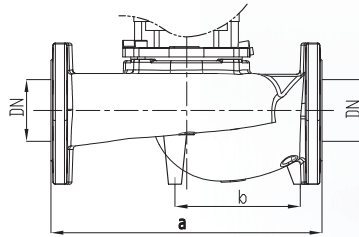
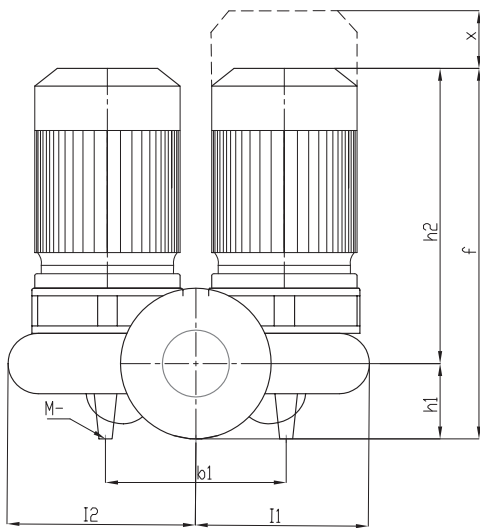

Model	DN	a	l	l1	l2	h1	h2	f	x	M-	b	b1	kg
NCLD 50-150/340-4	50	340	168	250	250	86	422	508	150	M10	180	240	88
NCLD 50-155/340-4	50	340	168	266	266	105	463	568	150	M10	200	360	107
NCLD 50-165/340-5,5	50	340	188	310	310	103	526	629	150	M10	180	360	144
NCLD 50-175/340-5,5	50	340	188	310	310	103	526	629	150	M10	180	360	144
NCLD 50-175/340-7,5	50	340	188	310	310	103	526	629	150	M10	180	360	148
NCLD 65-115/340-1,5	65	340	151	216	216	80	387	467	150	M10	162	225	66
NCLD 65-120/340-2,2	65	340	151	275	275	93	381	474	150	M10	180	240	72
NCLD 65-130/340-3	65	340	160	275	275	93	394	487	150	M10	180	240	84
NCLD 65-140/340-4	65	340	168	275	275	93	427	520	150	M10	180	240	96
NCLD 65-145/340-5,5	65	340	188	310	310	120	531	651	150	M12	200	400	145
NCLD 65-155/340-7,5	65	340	188	310	310	120	531	651	150	M12	200	400	162
NCLD 80-115/360-2,2	80	360	151	240	240	98	389	487	150	M10	180	240	76
NCLD 80-130/360-3	80	360	160	300	300	105	400	505	150	M10	180	240	87
NCLD 80-140/360-4	80	360	168	300	300	105	433	538	150	M10	180	240	99
NCLD 80-145/400-5,5	80	360	188	315	315	105	548	653	150	M12	240	400	160
NCLD 80-155/400-7,5	80	360	188	315	315	105	548	653	150	M12	240	400	176