



SX PROTECH

ELEGANT LIGHTING CATALOGUE

CMF120WS



LED Moving Head Wash + Spot Light

Power supply: AC100-240V, 50/60Hz
 Power consumption: 120W
 Light source: 6×8W RGBW 4-in-1 LEDs +1×60W white LED
 Life time: 60000 hours
 Beam angle: Wash 40° / Gobo 13°
 Color wheel: 7 colors + white light, flowing effect, reverse and reverse rotation
 Fixed gobo wheel: 7 gobos + white light, flowing effect, dithering effect, reverse and reverse rotation
 Prism: A honeycomb prism can rotates

Pan: 540°
 Tilt: 210°
 Control panel: 4 digital tubes + 4 buttons
 Control mode: Auto, master-slave, DMX512, voice-activated
 Channel: 16CH
 DMX connector: 2 × Rj45 (input and output)
 Dimming: 0-100% linear dimming
 Strobe: up to 20 times / second
 Working environment: up to 40 °C
 Protection rate: IP20
 Product size: 165×315mm
 Packing size: 360×260×320mm

CMF100B



LED Moving Head Beam Light

Power supply: AC100-240V, 50/60Hz
 Power consumption: 100W
 Light source: 1×90W white LED
 Life time: 60000 hours
 Beam angle: 2°
 Color Wheel: 7 colors + white light, water effect, can be reversed
 Gobo wheel: 11 gobos + white light, water effect, jitter effect, can be reversed and reversed
 Prism: 1 honeycomb prism can rotate

Working environment: up to 40 °C
 Protection rate: IP20
 Pan: 540°
 Tilt: 210°
 Control panel: 4 digital tubes + 4 buttons
 Control Mode: voice-activated, Auto, Master-slave, DMX512
 Channel: 10CH
 DMX connector: 2 × Rj45 (input and output)
 Dimmer: 0-100% linear dimming
 Strobe: up to 20 times / second
 Dimension size: 165×336mm
 Package size: 360×260×320mm

CMF120Z



LED Moving Head Zoom Light

Power supply: AC100-240V, 50/60Hz
 Power consumption: 120W
 Light source: 4×40W RGBW 4-in-1 LEDs
 Life time: 60000 hours
 Pan: 540°
 Tilt: 210°
 Control panel: 4 digital tubes + 4 buttons
 Control mode: Auto, master-slave, DMX512, voice-activated

Channel: 13CH
 DMX connector: 2 × Rj45 (input and output)
 Dimming: 0-100% linear dimming
 Strobe: up to 20 times / second
 Working environment: up to 40 °C
 Protection rate: IP20
 Product size: 165×315mm
 Packing size: 360×260×320mm

MF75WS

LED Moving Head Wash + Spot

Power supply: Adapter (Input AC100-240V, 50/60Hz, Output DC24V, 3.5A)
 Light source: LED 30W White + 6×8W (RGBW 4-in-1) LEDs
 Pan: 450°
 Tilt: 110°
 Control panel: 4 digital tubes + 4 buttons
 Control mode: voice-activated, Auto, Master-slave, DMX512
 Channel: 17CH
 DMX connector: 2 × Rj45 (input and output)
 Dimming: 0-100% linear dimming
 Strobe: up to 20 times / second
 Working environment: up to 40 °C
 Protection rate: IP20
 Gobo wheel: 8 Gobos + White
 Color wheel: 6 colors + White
 Product Size: φ178mm × 258mm
 Packing size: 230 × 230 × 305mm (1pc)
 N.W.: 2.2kg/1pc
 G.W.: 3kg

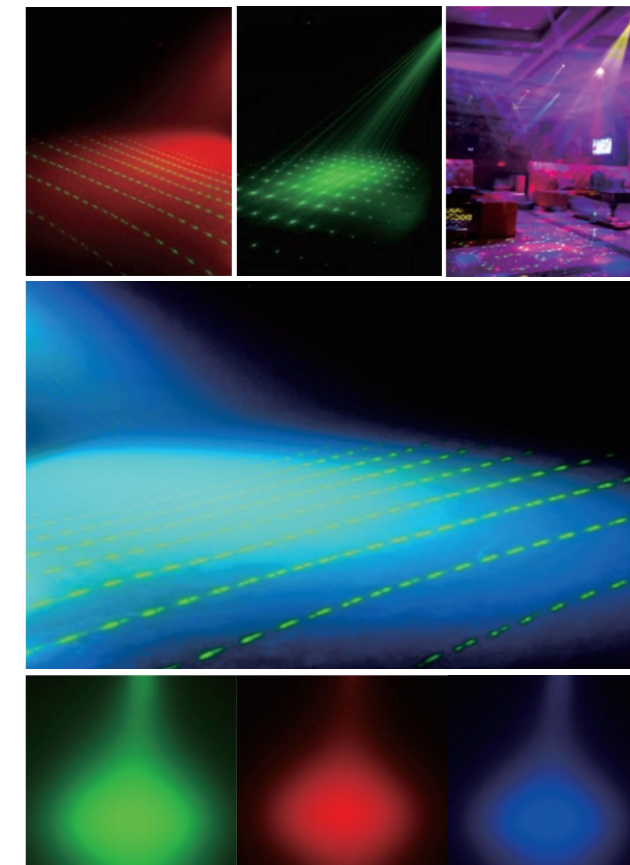

CMF100WS

LED Moving Head Wash + Spot

Power supply: Adapter (Input AC100-240V,50/60Hz, Output DC32V,3A ,DC12V/2A)
 Power consumption: 108W
 Light source: 8×8W RGBW 4-in-1LEDs + 1×60W white LED
 Pan: 540°
 Tilt :150°, speed of rotation can be adjustable
 Control panel: 4 digital tubes + 4 buttons
 Control mode: voice-activated, Auto, Master-slave,DMX512
 Channel: 19CH
 DMX connector: 2 × Rj45 (input and output) 2x XLR
 Dimming: 0-100% linear dimming
 Strobe: up to 20 times / second
 Working environment: up to 40 °C
 Protection rate: IP20
 Gobo wheel: 7 Gobos+White ,water effect, jitter effect, can be reversed and reversed
 Color wheel: 7 colors+White ,water effect, jitter effect, can be reversed and reversed
 Prism: 3 prism ,can be rotated forward and reverse
 Product Size: φ176mmx248mm
 Packing size: 260 × 260 × 395mm
 N.W.: 3.5kg
 G.W.:4.3kg



CMF90B

LED Moving Head Beam Light

Power supply: Input AC100-240V,50/60Hz
 Power consumption: 96W
 Light source: 1×90W white LED
 Life time: 60,000 hours
 Beam angle: 2°
 Color temperature: 7500K
 Pan: 540°
 Tilt :150°, speed of rotation can be adjustable
 Control panel: 4 digital tubes + 4 buttons
 Control mode: voice-activated, Auto, Master-slave,DMX512
 Channel: 10CH
 DMX connector: 2 × Rj45 (input and output) 2x XLR
 Dimming: 0-100% linear dimming
 Strobe: up to 20 times / second
 Working environment: up to 40 °C
 Protection rate: IP20
 Gobo wheel: 15 Gobos+White ,water effect, jitter effect, can be reversed and reversed
 Color wheel: 7 colors+White ,water effect, jitter effect, can be reversed and reversed
 Prism: one honeycomb prism ,can be rotated forward and reverse
 Product Size: φ176mmx300mm
 Packing size: 260 × 260 × 395mm
 N.W.: 4.3kg
 G.W.:5.1kg

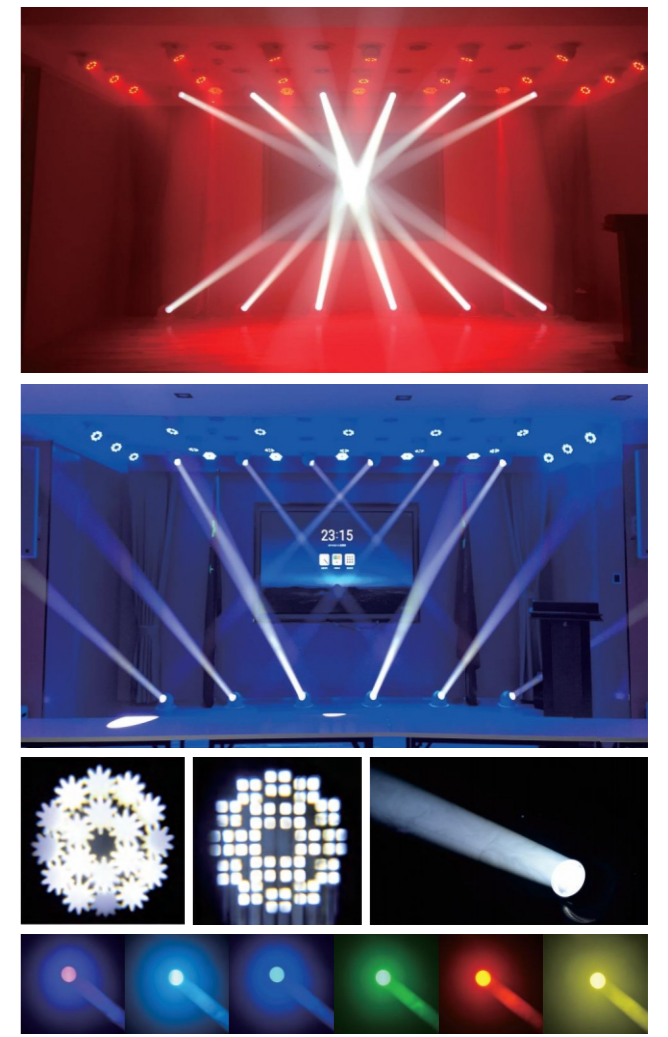

CMF65WL

LED Bee Eye+ Green Laser

Power supply: AC100-240V,50/60Hz

Power consumption: 70W

Light source:5×15W RGBW 4-in-1LED s

Laser source:515nm 60mw

Life time: 60,000 hours

Pan:540°

Tilt :150°, speed of rotation can be adjustable

Control panel: 4 digital tubes + 4 buttons

Control mode: voice-activated, Auto,

Master-slave,DMX512

Channel: 15CH

DMX connector: 2 × Rj45 (input and output) 2x

XLR

Dimming: 0-100% linear dimming

Strobe: up to 20 times / second

Working environment: up to 40 °C

Protection rate: IP20

Product Size: φ176mmx266mm

Packing size: 260 × 260 × 395mm

N.W.: 3.2kg

GW.:4kg

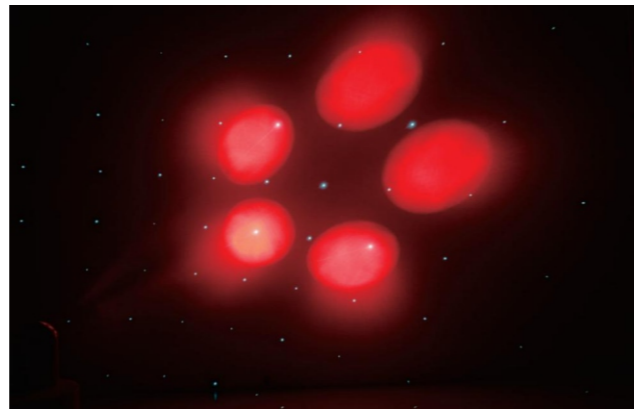
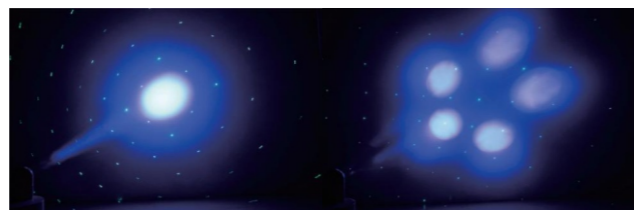
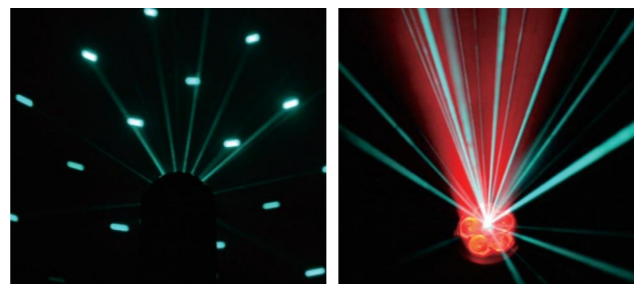

CMF75WZ

LED Moving Head Zoom Light

Power supply: AC100-240V,50/60Hz

Power consumption: 70W

Light source:5×15W RGBW 4-in-1LED s

Life time: 60,000 hours

Beam angle: 9-55°

Pan:540°

Tilt :150°, speed of rotation can be adjustable

Control panel:4 digital tubes + 4 buttons

Control mode:voice-activated, Auto,

Master-slave,DMX512

Channel: 14CH

DMX connector: 2 × Rj45 (input and output) 2x

XLR

Dimming: 0-100% linear dimming

Strobe: up to 20 times / second

Working environment: up to 40 °C

Protection rate: IP20

Product Size: φ176mmx266mm

Packing size: 260 × 260 × 395mm

N.W.: 3.2kg

GW.:4kg

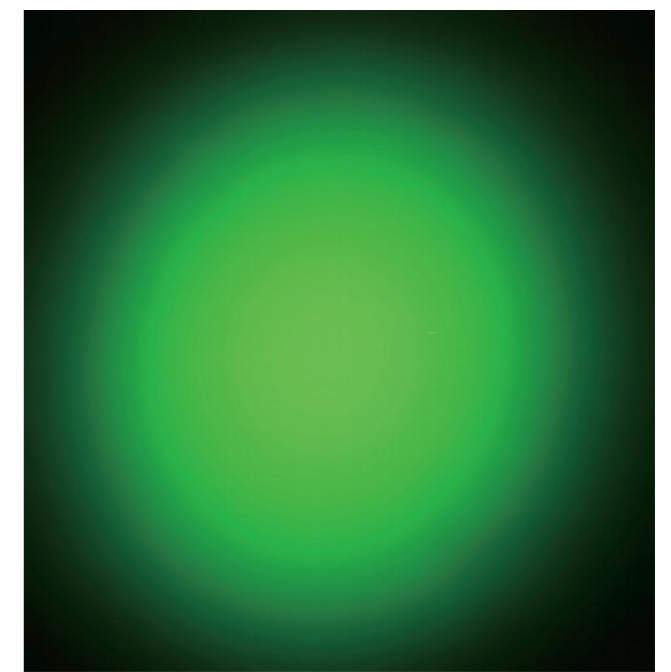
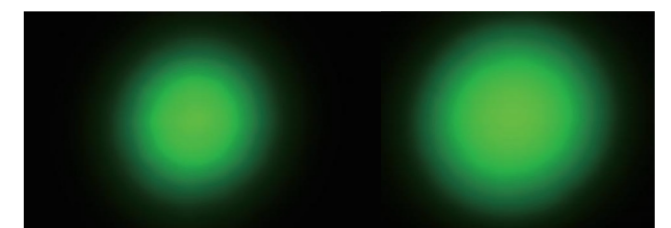
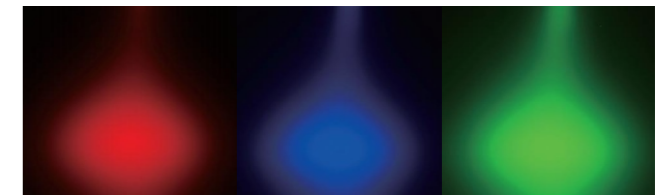

CMF150S

LED Moving Head Spot Light

Power Supply: AC100-240V, 50/60Hz
 Power consumption: 150W
 Light source: 1 x150W white LED
 Life time: 60,000 hours
 Beam Angle: 13 °
 Color Temperature: 8500K
 Gobo wheel :8Gobos+White ,water effect, jitter effect, can be reversed and reversed
 Rotate gobo wheel: 6 glass gobos+white,water effect, jitter effect, can be reversed and reversed
 Color wheel:7 colors+White ,water effect, jitter effect, can be reversed and reversed
 Prism: 3 prism can rotate
 Pan: 540 °
 Tilt : 150 ° with adjustable rotation speed
 Control panel: 4 digital tubes + 4 buttons
 Control mode:Auto, Master-slave,DMX512
 Channel: 13CH
 DMX connector: 2 × Rj45 (input and output), 2 × XLR (input & output)
 Dimming: 0-100% linear dimming
 Strobe: up to 20 times / second
 Working environment: up to 40 °C
 Protection rate: IP20
 Product Size: 280x358mm
 Packing size: 330 × 330 × 475mm
 N.W.: 6.5kg
 G.W.: 8.5kg

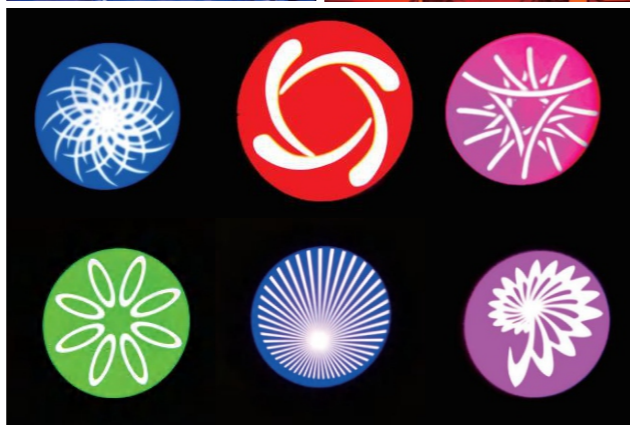
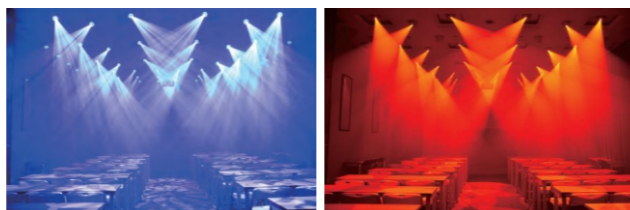

CMF150B

LED Moving Head Beam Light

Power Supply: AC100-240V, 50/60Hz
 Power consumption: 150W
 Light source: 1 x120W white LED
 Life time: 60,000 hours
 Beam Angle: 3 °
 Color Temperature: 7500K
 Gobo wheel :12Gobos+White ,water effect, jitter effect, can be reversed and reversed
 Color wheel: 13 colors+White ,water effect, jitter effect, can be reversed and reversed
 Prism: A honeycomb prism can rotates back-wards and forwards
 Automization: An atomizing lens that can be superimposed with a prism to expand the atomizing effect
 Pan: 540 °
 Tilt : 150 ° with adjustable rotation speed
 Control panel:4 digital tubes + 4 buttons
 Control mode:Auto, Master-slave,DMX512
 Channel: 13CH
 DMX connector: 2 × Rj45 (input and output), 2 × XLR (input & output)
 Dimming: 0-100% linear dimming
 Strobe: up to 20 times / second
 Working environment: up to 40 °C
 Protection rate: IP20
 Product Size: 280x380mm
 Packing size: 330 × 330 × 475mm
 N.W.: 8kg
 G.W.: 10kg

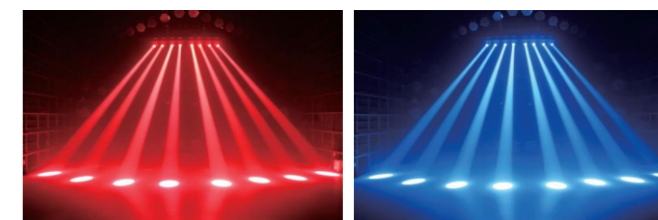
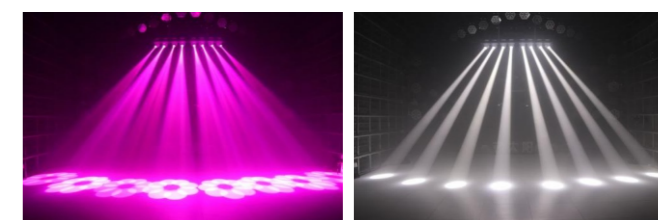

CMF70WZ

Flexible Moving head Zoom Wash

Power supply: AC100-240V, 50/60Hz

Power consumption: 70W

Light source: 5×15W RGBW 4-in-1 LEDs

Life time: 60000 hours

Beam angle: 9-55°

Control panel: 4 digital tubes+4 buttons

Control mode: Auto, Master-slave,DMX-

512,voice-activated

Channel: 15CH

Pan: 540°

Tilt: 150° rotation speed can be adjusted

DMX connector: 2×Rj45 (input and output),

2×XLR (input and output)

Dimmer: 0-100% linear dimming

Strobe: up to 20 times / second

Working environment: up to 40°C

Protection rate: IP20

Product size: Φ285×278mm

Packing size: 340×340×390mm

700×355×410mm (2 pcs)

N.W: 5.45kg

G.W: 6.65kg

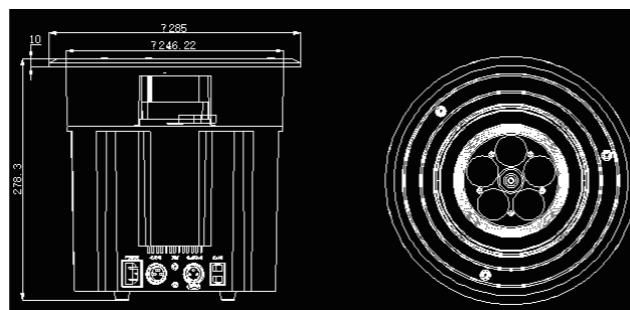
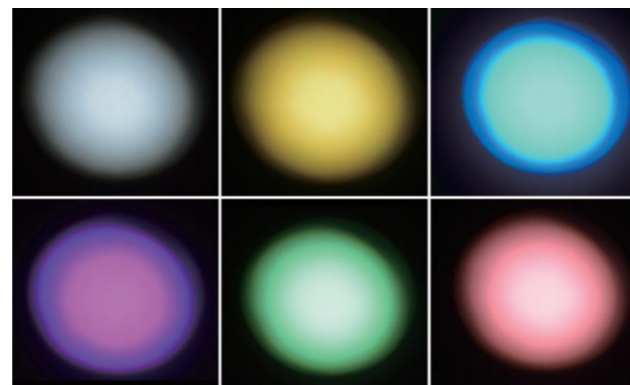

CMF150WL

Flexible Moving head Bee -Eye + Laser

Power Supply: AC100-240V, 50/60Hz

Power consumption: 150W

Light source: 1 x120W white LED

Life time: 60,000 hours

Beam Angle: 3°

Color Temperature: 7500K

Gobo wheel: 12Gobos+White ,water effect,

jitter effect, can be reversed and reversed

Color wheel: 13 colors+White ,water effect,

jitter effect, can be reversed and reversed

Prism: A honeycomb prism can rotates back-

wards and forwards

Automization: An atomizing lens that can be

superimposed with a prism to expand the

atomizing effect

Pan: 540°

Tilt : 150° with adjustable rotation speed

Control panel:4 digital tubes + 4 buttons

Control mode:Auto, Master-slave,DMX512

Channel: 13CH

DMX connector: 2 × Rj45 (input and output), 2

× XLR (input & output)

Dimming: 0-100% linear dimming

Strobe: up to 20 times / second

Working environment: up to 40 °C

Protection rate: IP20

Product Size: 280x380mm

Packing size: 330 × 330 × 475mm

N.W.: 8kg

G.W.: 10kg

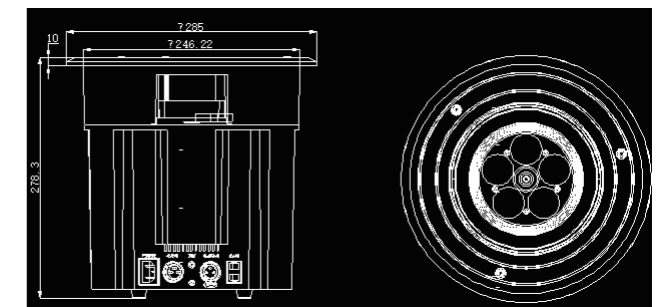

CMF170C4

Moving Head Zoom Light

Power Supply: AC100-240V, 50/60Hz

Power consumption: 170W

Light source: 6 x40W RGBW 4-in-1 LEDs

Life time: 60,000 hours

Beam Angle: 9-45 °

Pan: 540 °

Tilt : 150 ° with adjustable rotation speed

Control panel: 4 digital tubes + 4 buttons

Control mode: Auto, Master-slave,DMX512

Channel: 15CH

DMX connector: 2 × Rj45 (input and output), 2 × XLR (input & output)

Dimming: 0-100% linear dimming

Strobe: up to 20 times / second

Working environment: up to 40 °C

Protection rate: IP20

Product Size: 230x330mm

Packing size: 330 × 330 × 475mm

N.W.:5.7 kg

G.W.: 7.7kg

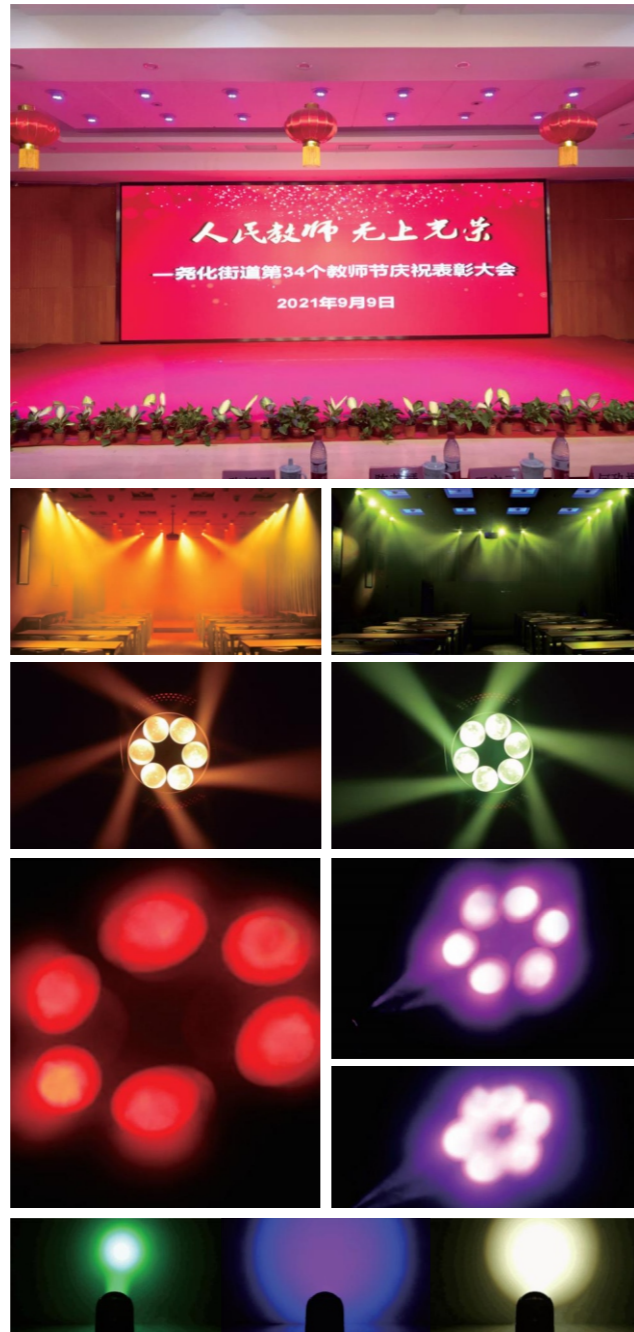

CMF125PC4

LED PAR Light 61X 3W RGBW 4IN1 LEDs

Power Supply: AC100-240V, 50/60Hz

Power consumption: 125W

Light source: 61 X 3W RGBW 4-in-1 LEDs

Life time: 60,000 hours

Beamangle: 25 °

Control panel: 4 digital tubes + 4 buttons

Control mode: Auto, Master-slave,DMX-

512,voice-activated

Channel: 5CH/8CH

DMX connector: 2 × Rj45 (input and output), 2 × XLR (input & output)

Dimmer: 0-100% linear dimming

Strobe: up to 20 times / second

Working environment: up to 40 °C

Protection rate: IP20

Product Size: 229x211x240mm

Packing size: 330 × 330 × 305mm

N.W.: 2.2kg

G.W.: 4.1kg

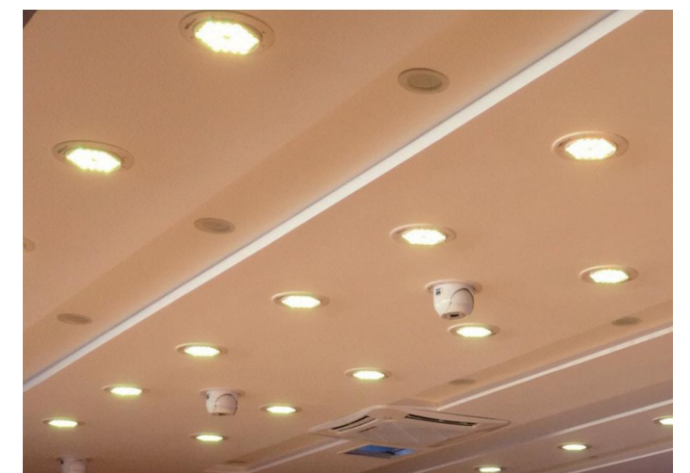

CSF120PC4

LED PAR Light 61x 3W RGBW LEDs

Power Supply: AC100-240V, 50/60Hz

Power consumption: 117W

Light source: 61 X 3W R21, G14, B14,W12 LEDs

Life time: 60,000 hours

Beamangle: 25°

Control panel: 4 digital tubes + 4 buttons

Control mode: Auto, Master-slave,DMX-

512,voice-activated

Channel: 5CH/8CH

DMX connector: 2 × Rj45 (input and output), 2

× XLR (input & output)

Dimmer: 0-100% linear dimming

Strobe: up to 20 times / second

Working environment: up to 40 °C

Protection rate: IP20

Product Size: 229x211x240mm

Packing size: 330 × 330 × 305mm

N.W.: 2.2kg

G.W.: 4.1kg



CSF120WS



LED Moving Head Wash + Spot Light

Power Supply: AC100-240V, 50/60Hz

Power consumption: 117W

Light source: 54 X 3W R18 G12, B12,W12 LEDs

Life time: 60,000 hours

Beamangle: 25°

Control panel: 4 digital tubes + 4 buttons

Control mode: Auto, Master-slave,DMX512,voice-activated

Channel: 5CH/8CH

DMX connector: 2 × Rj45 (input and output), 2 × XLR (input & output)

Dimmer: 0-100% linear dimming

Strobe: up to 20 times / second

Working environment: up to 40 °C

Protection rate: IP20

Product Size: 229x211x240mm

Packing size: 330 × 330 × 305mm

N.W.: 2.2kg

G.W.: 4.1kg

CMF120WS

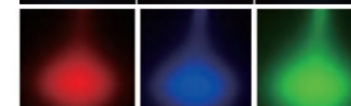
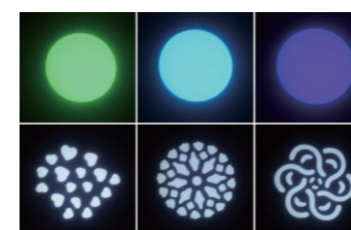

Flexible + Cryptic Ceiling Moving Head Wash + Spot

Power supply: AC100-240V, 50/60Hz

Power consumption: 120W

Light source: 8x8W RGBW 4-in-1 LEDs + 1 x60W white LED

Life time: 60000 hours

Wash angle: 40°

Gobo angle: 18°

Color temperature: 7500K

Color plate: 7 colors + open

Gobo plate: 7 gobo + open

Prism: 3 prism can be rotated forwards and backwards

Control panel: 4 digital tubes + 4 buttons

Control mode: Auto, Master-slave,DMX512,voice-activated

Channel: 20CH

Pan: 540°

Tilt: 150° rotation speed can be adjusted

DMX connector: 2 × Rj45 (input and output), 2 × XLR (input and output)

Dimming: 0-100% linear dimming

Strobe: up to 20 times / second

Working environment : up to 40 °C

Protection rate: IP20

Surface material: fire-resistant ABS plastic, white

Product size: Φ285 × 278mm

Package size: 340 × 340 × 390mm 700 × 355 × 410mm (2pcs)

N.W: 5.85kg

G.W: 7.05kg

CSF110PC4

LED PAR Colorful

Power supply: AC100-240V, 50/60Hz

Power consumption: 110W

Light source: 36x4W RGBW 4-in-1 LEDs

Life time: 60,000 hours

Light angle: 45°

Control panel: 4 digital tubes + 4 buttons

Control mode: Auto, Master-slave, DMX512

Channel: 5CH/8CH

DMX connector: 2 × RJ45 (input and output) 2x

XLR

Dimming: 0-100% linear dimming

Strobe: up to 20 times / second

Working environment: up to 40 °C

Protection rate: IP20

Product Size: 187*170*197mm

Packing size: 270 × 270 × 280mm

N.W.: 1.5kg

G.W.: 2.3kg

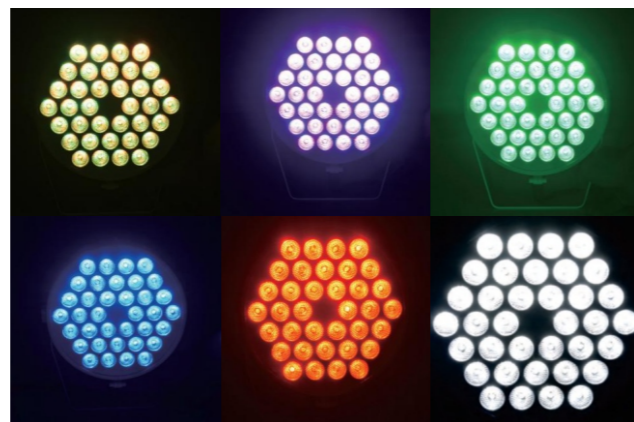

CSF90PC1

LED PAR Light

Power supply: AC100-240V, 50/60Hz

Power consumption: 90W

Light source: 36x3W white LEDs (24x3200K

WW LEDs+ 12x5600K CW LEDs)

Life time: 60,000 hours

Light angle: 45°

Control panel: 4 digital tubes + 4 buttons

Control mode: Auto, Master-slave, DMX512

Channel: 5CH/8CH

DMX connector: 2 × RJ45 (input and output) 2x

XLR

Dimming: 0-100% linear dimming

Strobe: up to 20 times / second

Working environment: up to 40 °C

Protection rate: IP20

Product Size: 187*170*197mm

Packing size: 270 × 270 × 280mm

N.W.: 1.5kg

G.W.: 2.3kg

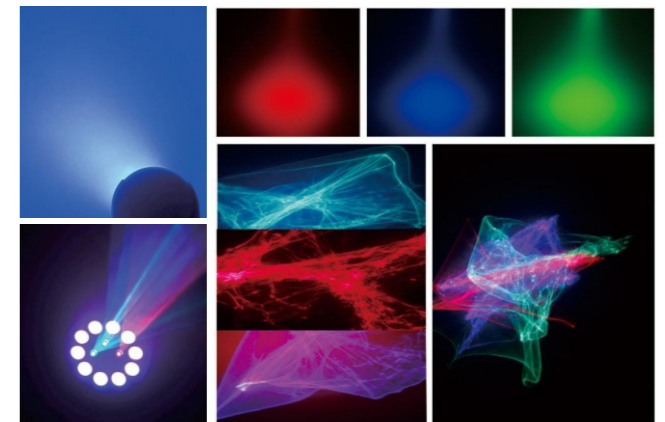

CSF100PC2

LED COB PAR Light (Cool+ Warm White)

Power supply: AC100-240V,50/60Hz

Power consumption: 100W

Light source: 1x100W (WW3200K+CW5600K)

COB LED

Light time: 50000 hour

Light angle:60°

CRI: Ra≥95

Control panel:4 digital tubes + 4 buttons

Control mode: Auto, Master-slave,DMX512

Channel: 5CH

DMX connector: 2 × Rj45 (input and output) 2x

XLR

Dimming: 0-100% linear dimming

Strobe: up to 20 times / second

Working environment: up to 40 °C

Protection rate: IP20

Product Size: 187*170*233mm

Packing size: 270 × 270 × 350mm

N.W.: 1.5kg

G.W.: 2.3kg



CSF50PC4

Bee eye + Laser

Power Supply: i AC100-240V, 50/60Hz

Power consumption: 48W

Light source: 6 x 8W RGBW 4-in -1 LEDs

Life time: 60,000 hours

Laser source: 515 nm, 40 mW

Laser Effect: Gypsophila

Control panel: 4 digital tubes + 4 buttons

Control mode: Auto, Master-slave,DMX512

Channel: 12CH

DMX connector: 2 × Rj45 (input and output), 2

× XLR (input & output)

Dimmer: 0-100% linear dimming

Strobe: up to 20 times / second

Working environment: up to 40 °C

Protection rate: IP20

Product Size: 187*170*233mm

Packing size: 270 × 270 × 350mm

N.W.: 1.4kg

G.W.: 2.2kg

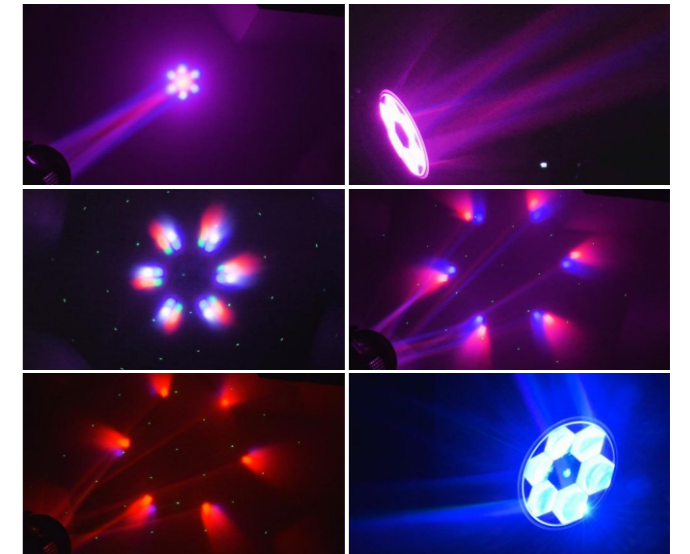

CSF 45LC

Colorful Dynamic Laser Light

Power supply: AC100-240V, 50/60Hz

Laser source: 1x 2W RGB 3-in-1 laser diode

Life time: 10,000 hours

Scanning system: 15K scanning speed, $\pm 20^\circ$

Control panel: 4 digital tubes + 4 buttons

Control mode: Auto, Master-slave, DMX-

512, voice-activated

Channel: 13CH

DMX connector: 2 \times Rj45 (input and output), 2

\times XLR (input & output)

Strobe: up to 20 times / second

Working environment: up to 40 $^\circ\text{C}$

Protection rate: IP20

Product Size: 187*170*197mm

Packing size: 270 \times 270 \times 280mm

N.W.: 1.65kg

G.W.: 2.6kg

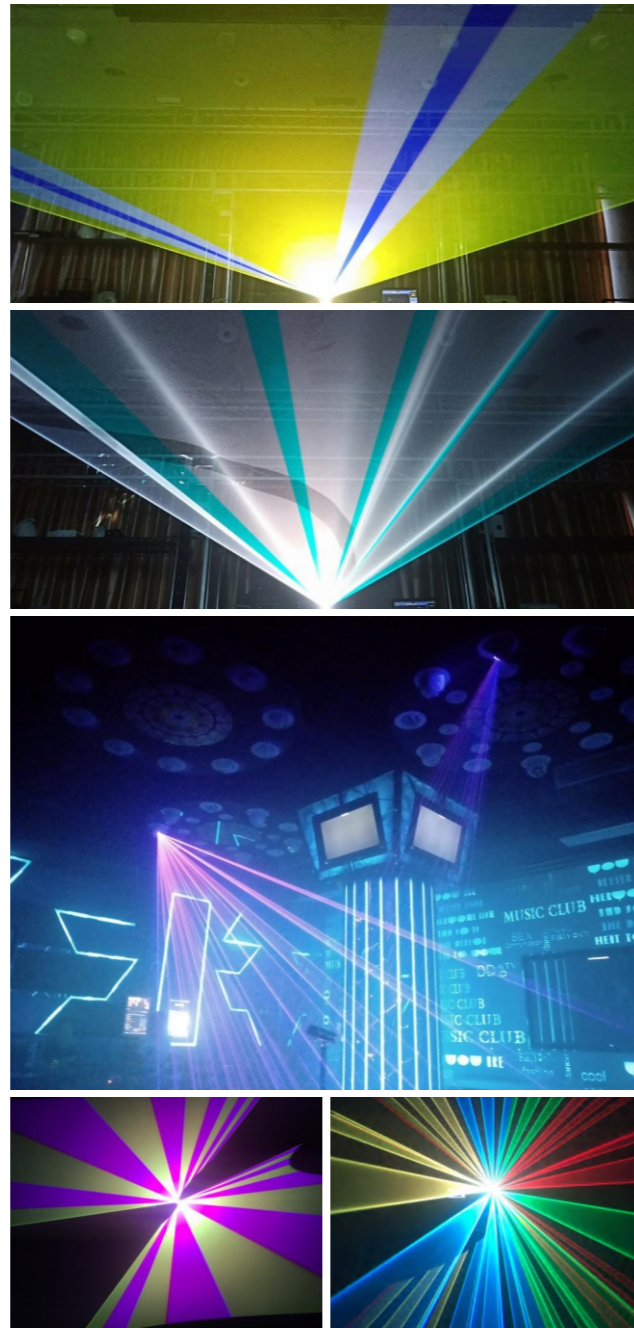

CSF 40LC

Colorful Dynamic Laser Light

Power supply: AC100-240V, 50/60Hz

Laser source: 1x 1W RGB 3-in-1 laser diode

Life time: 10,000 hours

Scanning system: 15K scanning speed, $\pm 20^\circ$

Control panel: 4 digital tubes + 4 buttons

Control mode: Auto, Master-slave, DMX-

512, voice-activated

Channel: 13CH

DMX connector: 2 \times Rj45 (input and output), 2

\times XLR (input & output)

Strobe: up to 20 times / second

Working environment: up to 40 $^\circ\text{C}$

Protection rate: IP20

Product Size: 187*170*197mm

Packing size: 270 \times 270 \times 280mm

N.W.: 1.65kg

G.W.: 2.6kg





SX PROTECH

Email: info@sxprotech.com | Website: www.sxprotech.com