

Full Size Bed (54 x 75)

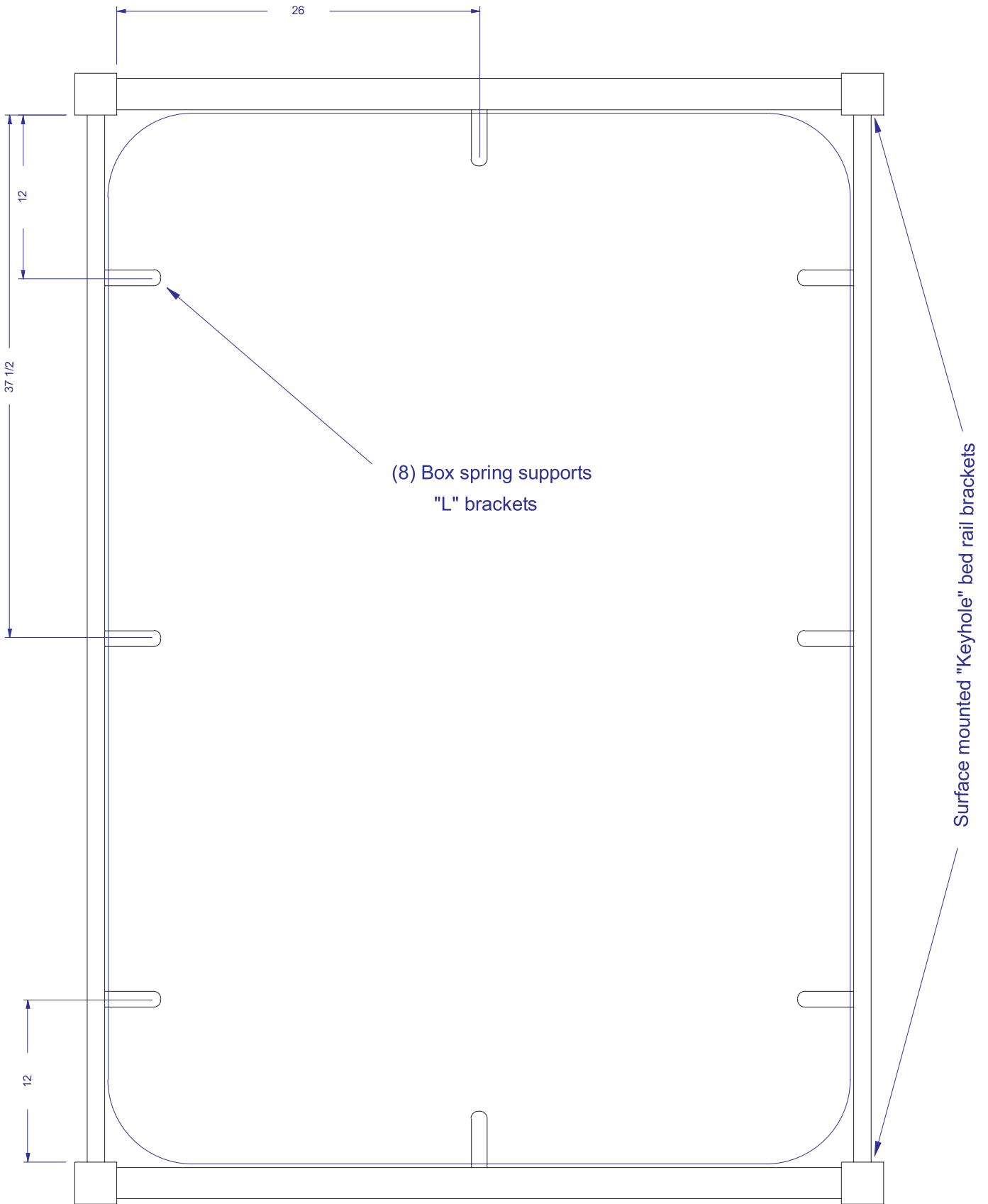

Headboard

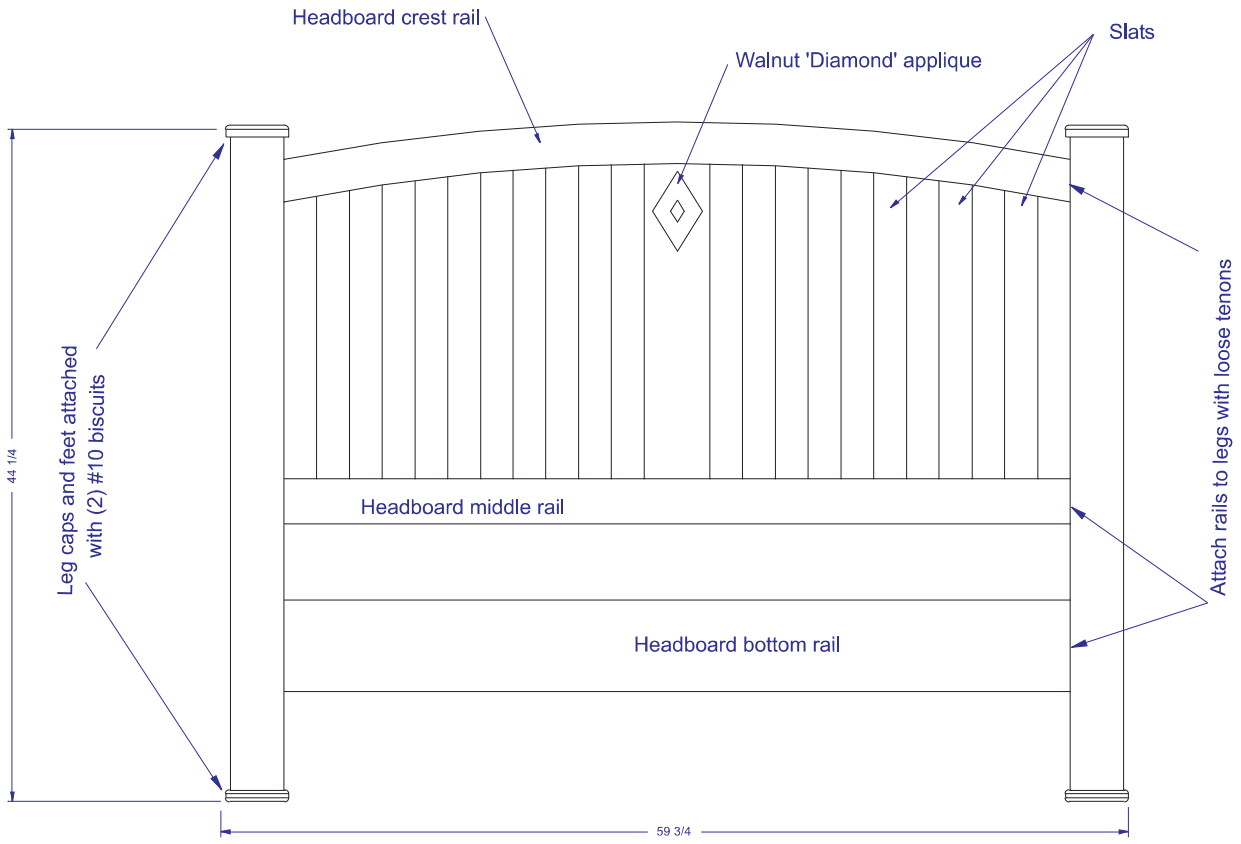

Footboard

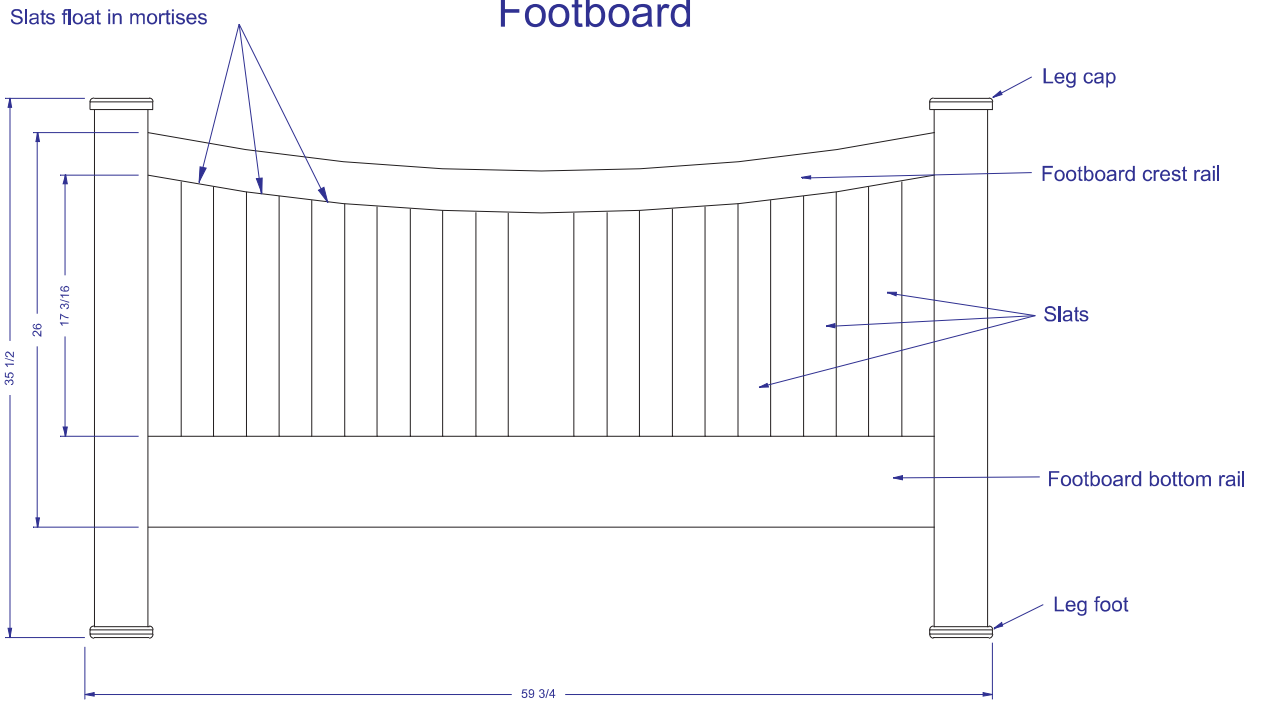

(2) Headboard Legs (Left leg shown)

Make from solid, lamination, or box construction

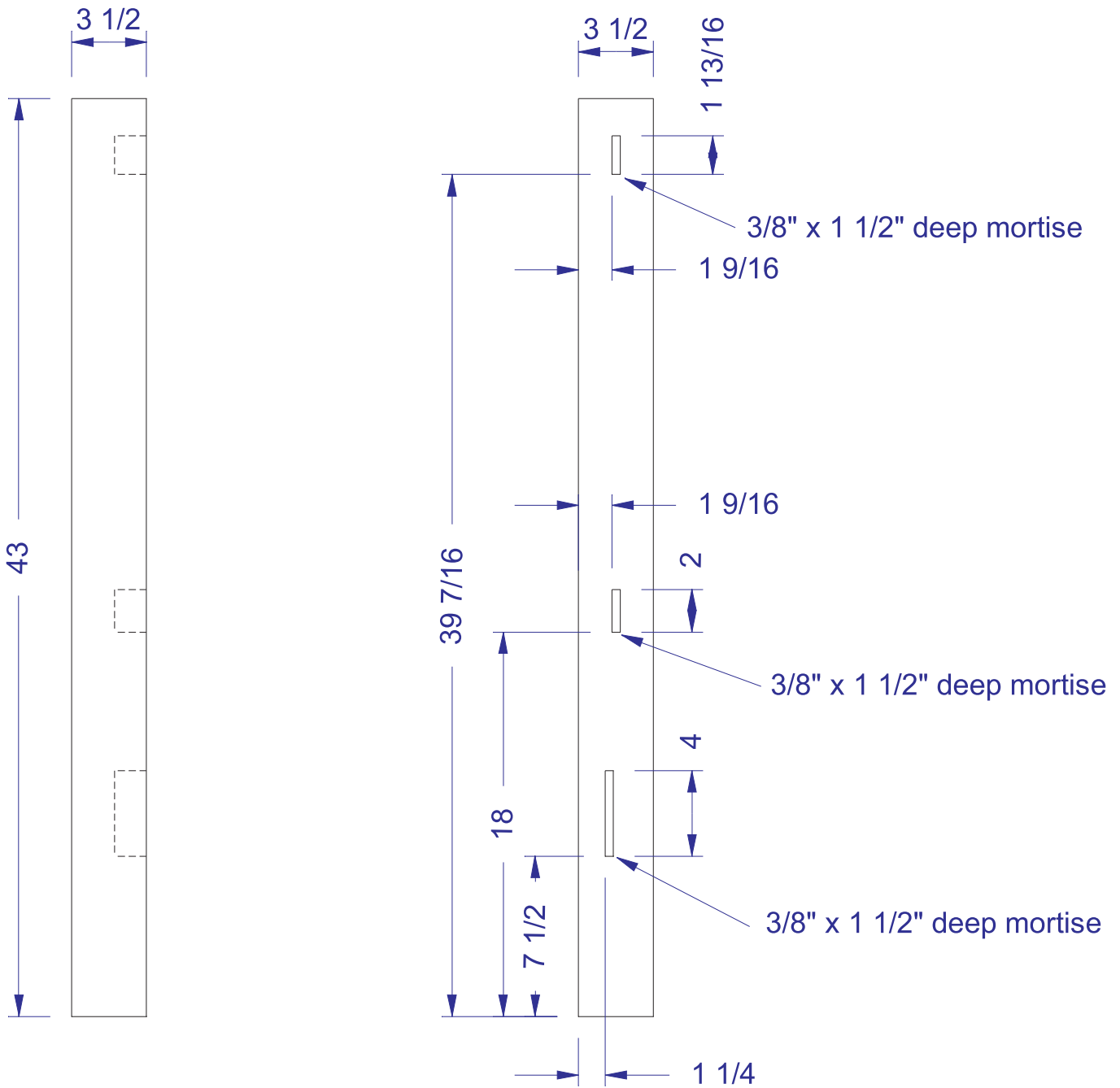
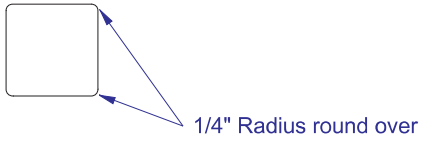

(2) Footboard Legs (Left leg shown)

Make from solid, lamination, or box construction

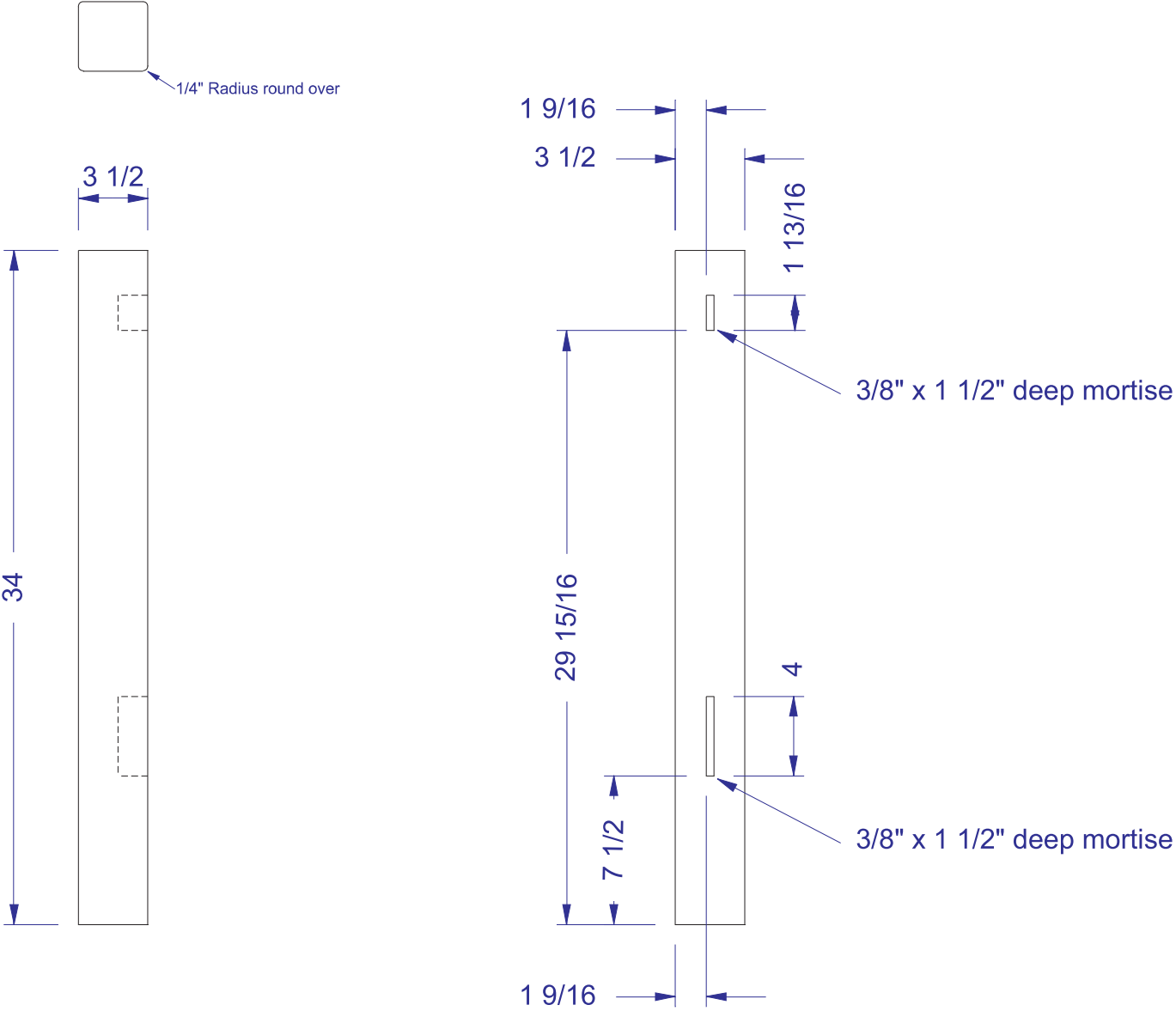

Headboard Crest Rail

Construct as a lamination

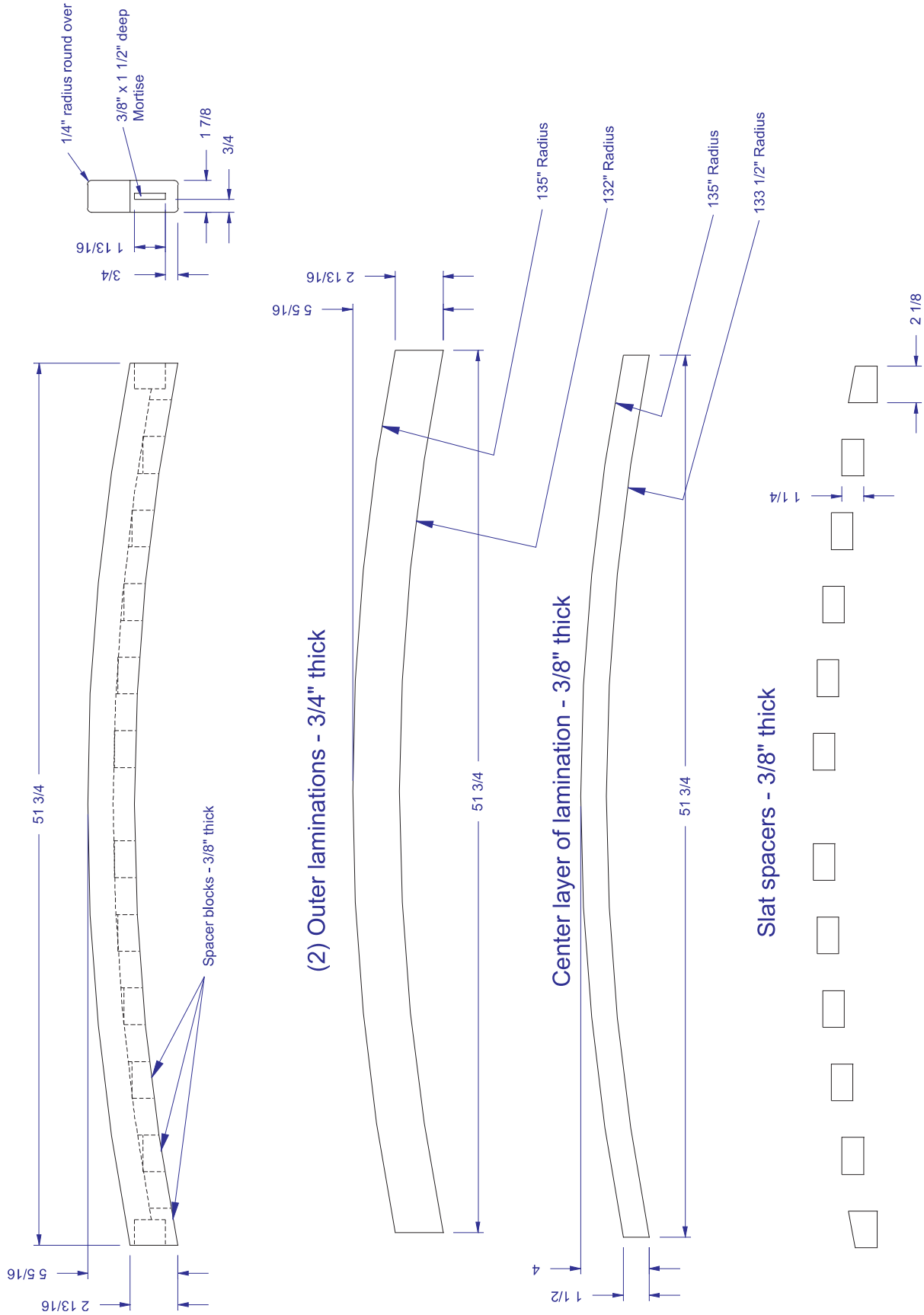

Headboard Middle Rail

Construct as a lamination

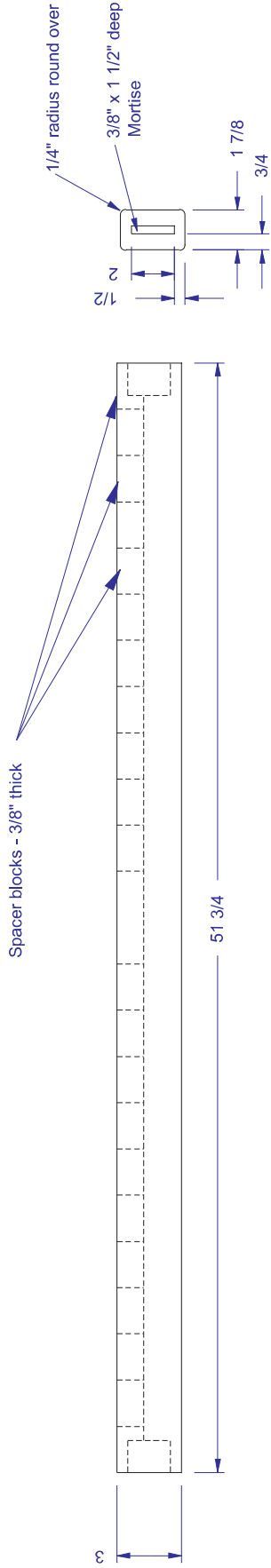

(2) Outer laminations - $\frac{3}{4}$ " thick



(1) Center lamination - $\frac{3}{8}$ " thick

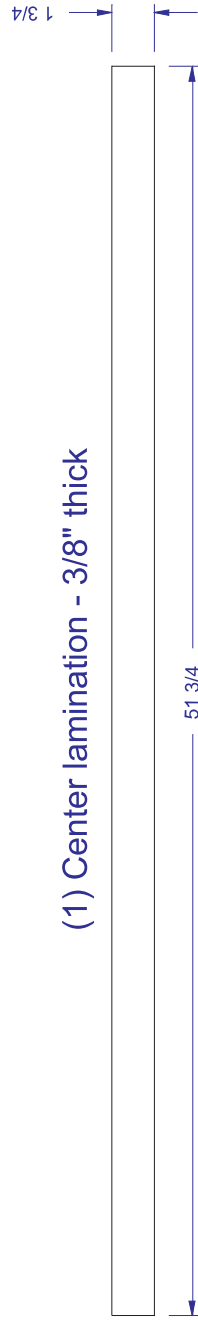

Slat spacers - $\frac{3}{8}$ " thick

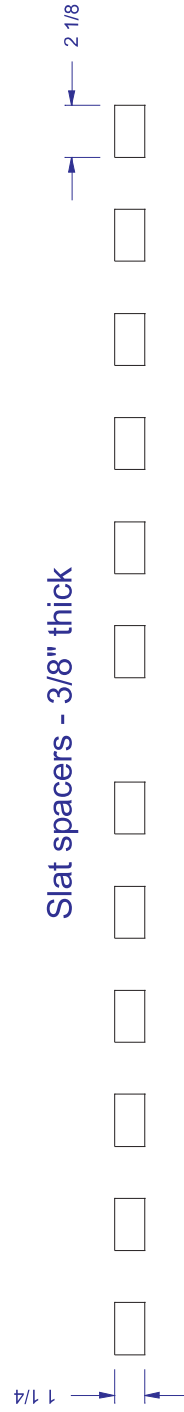

(1) Headboard bottom rail

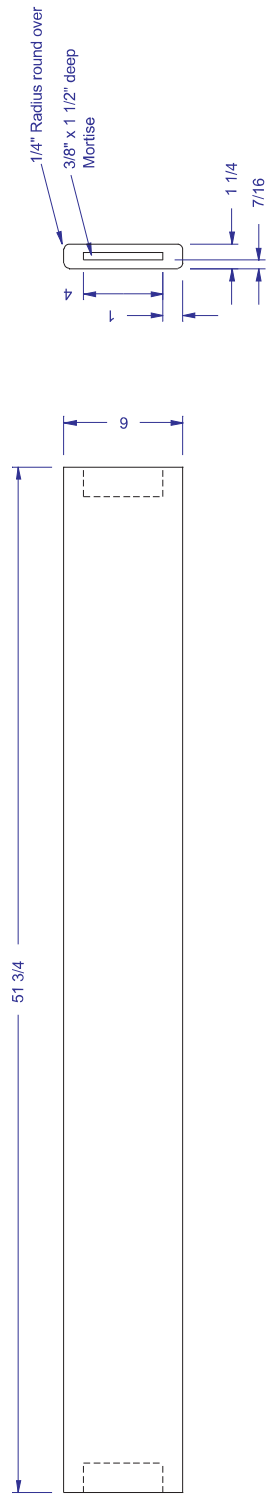

(2) Side Rails

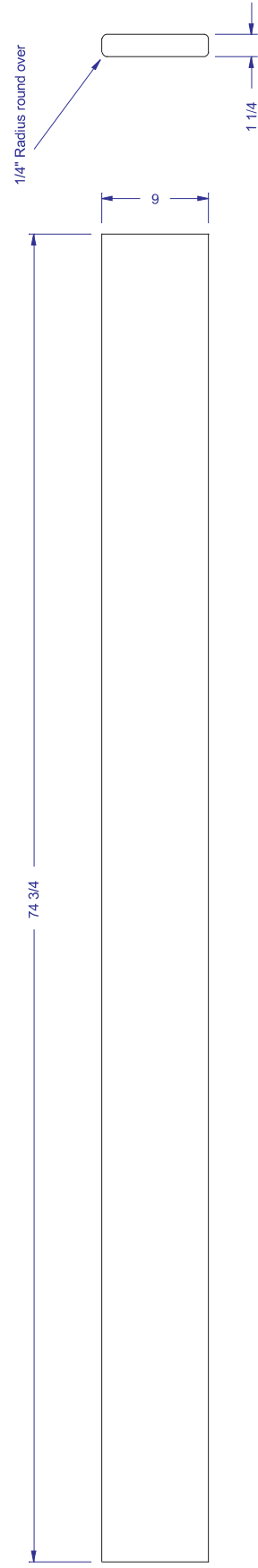

Footboard Crest Rail

Construct as a lamination

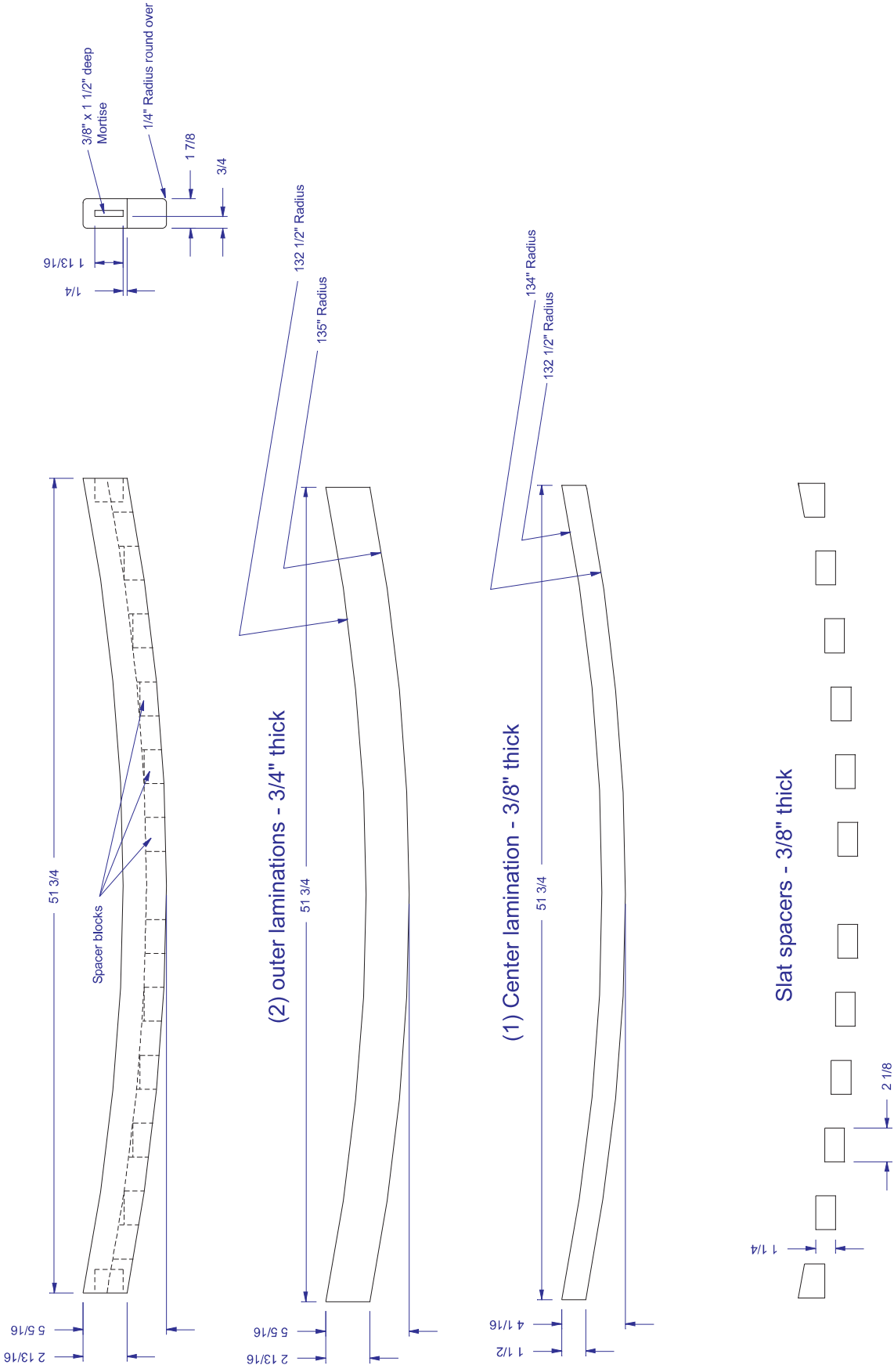

Footboard Lower Rail

Construct as a lamination

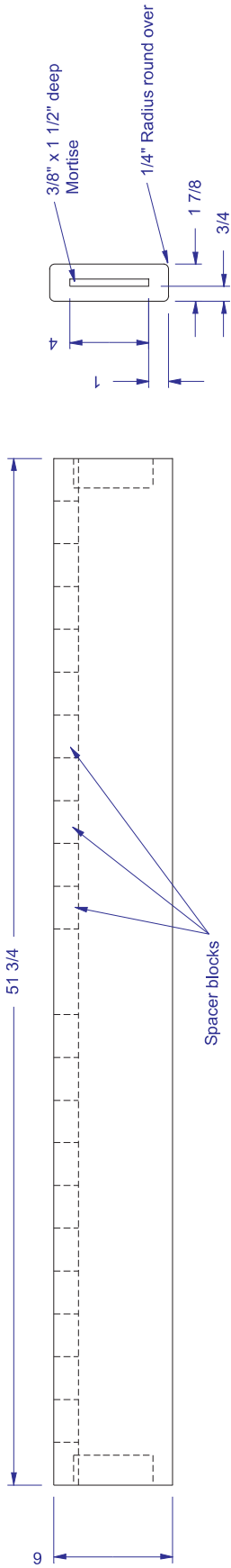

(2) Outer laminations - $3/4$ " thick

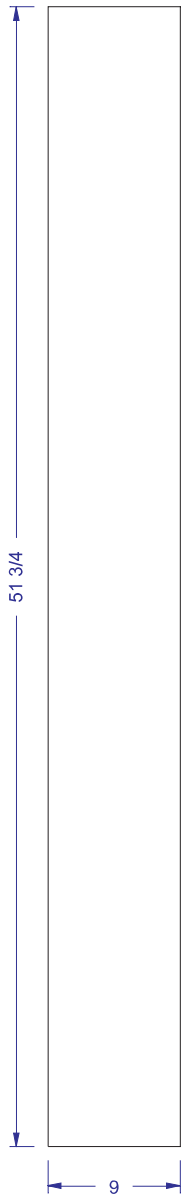

(1) Center lamination - $3/8$ " thick

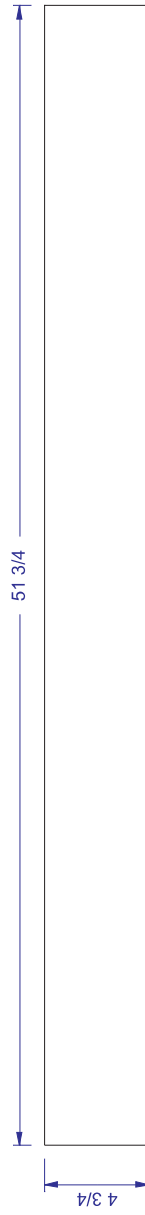

Slat spacers - $3/8$ " thick

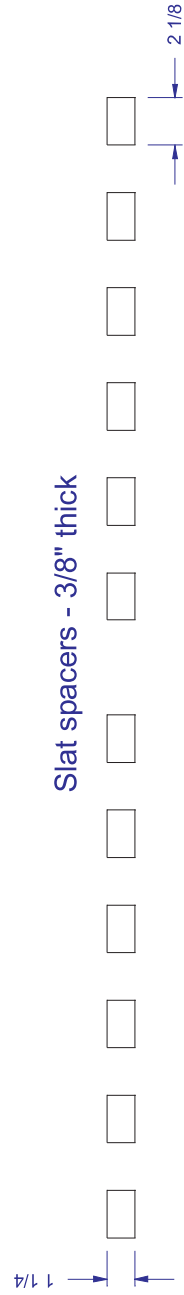

(20) Head / Footboard Slats

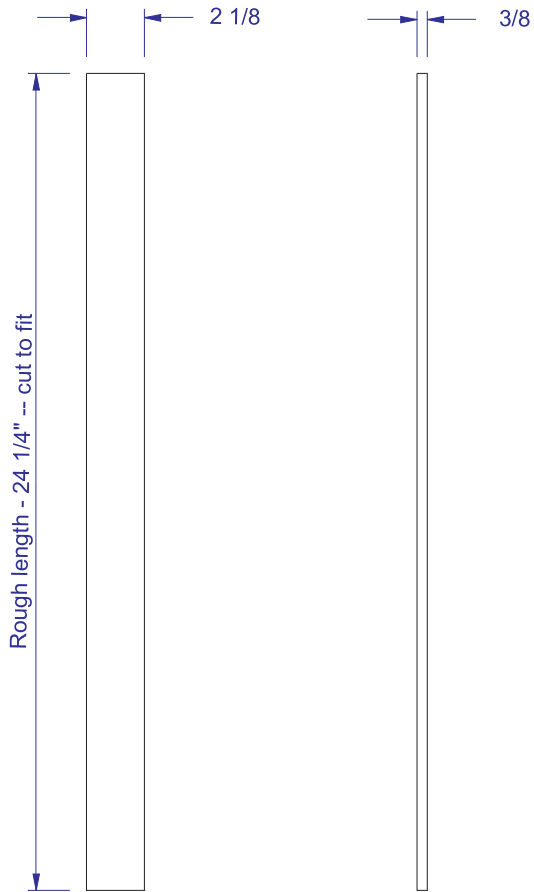

(2) Head / Footboard Slats - Center

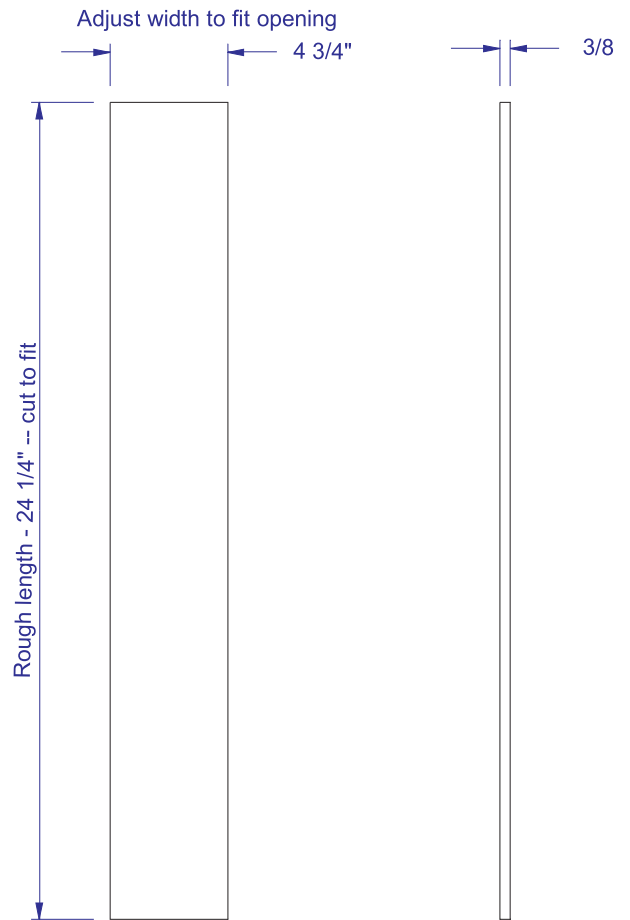

Walnut "Diamond" Applique

'X' dim. same in 3 places

Edge of top rail

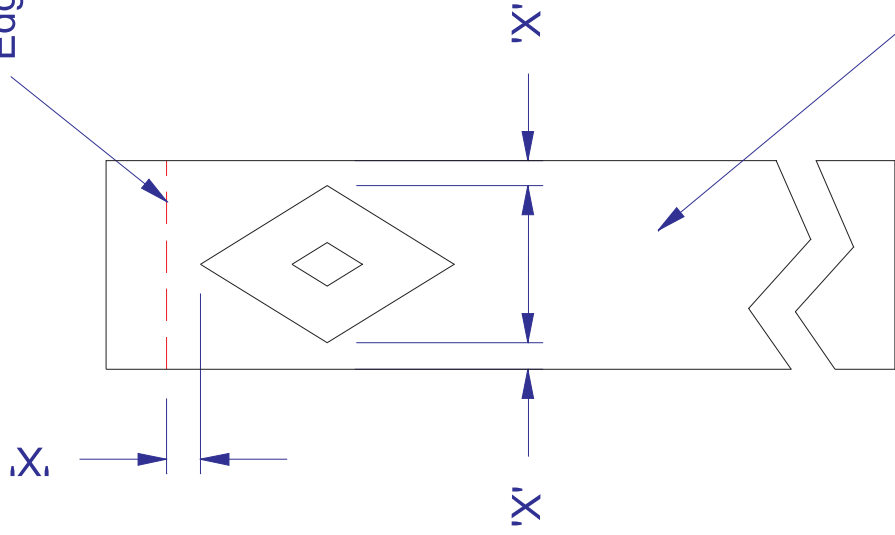

Headboard center slat

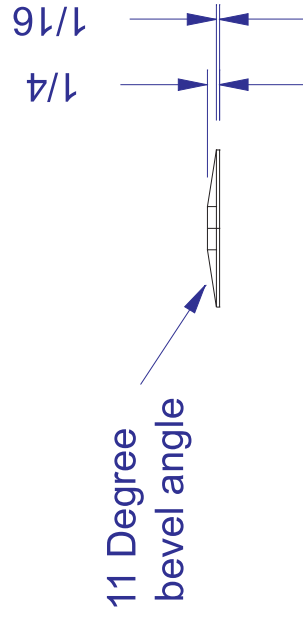
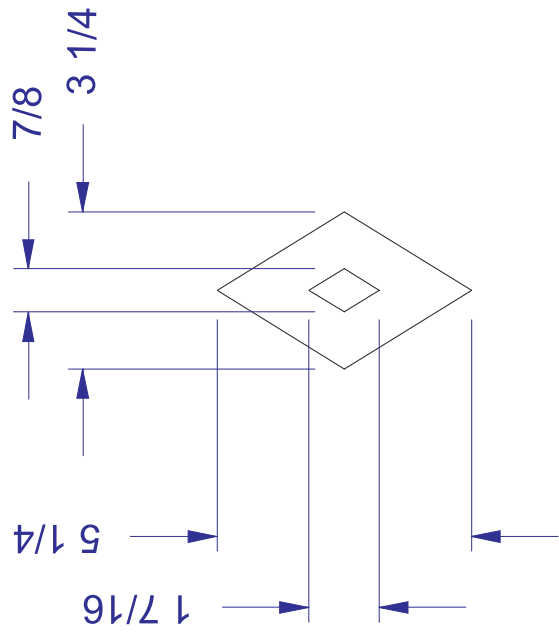

(4) Feet

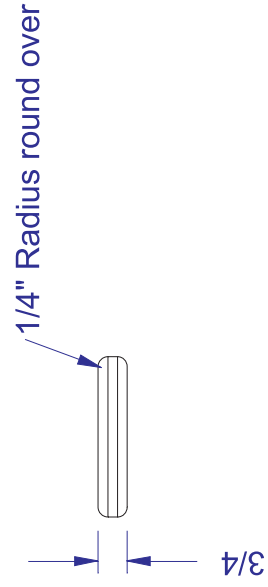
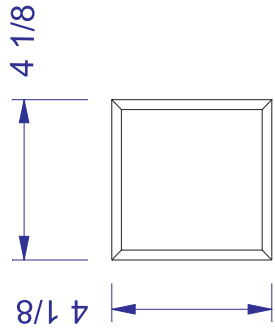

(4) Leg caps

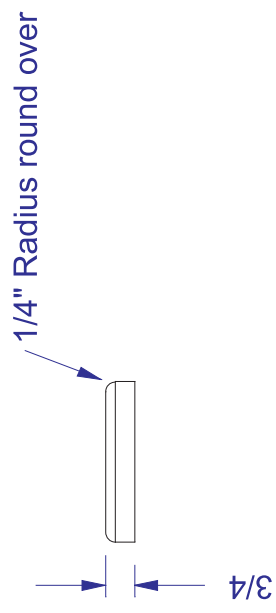
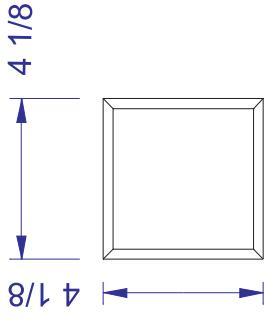

Fasten to legs using (2) #10 biscuits

1/2" Cherry for Slats
Plane to 3/8"

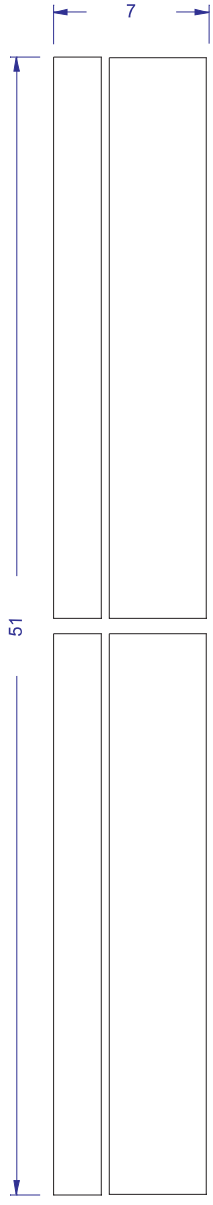
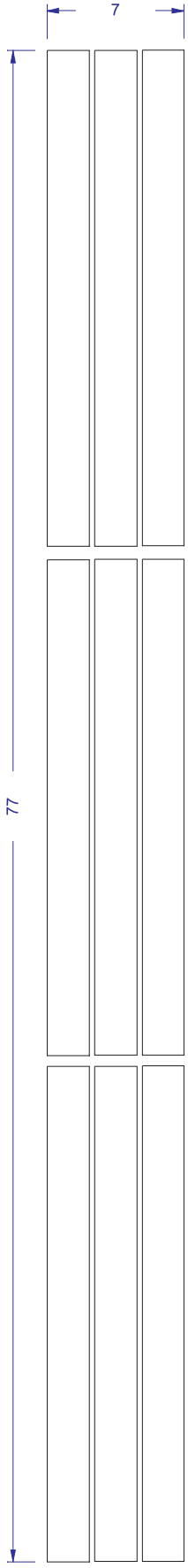
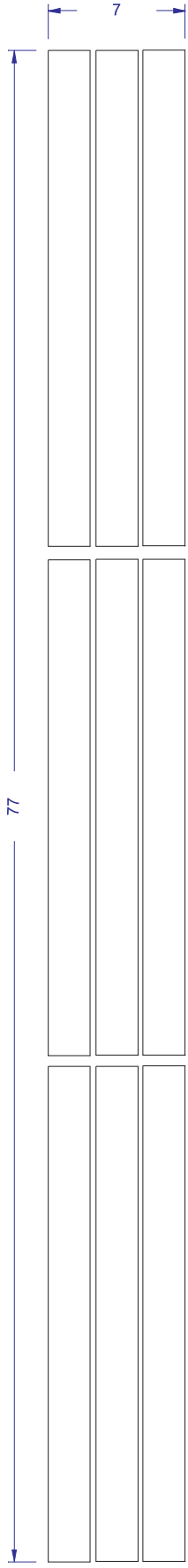

1 1/4" Cherry for side rails and lower headboard rail
Or, laminate from 3 pieces of 1" stock as shown in video

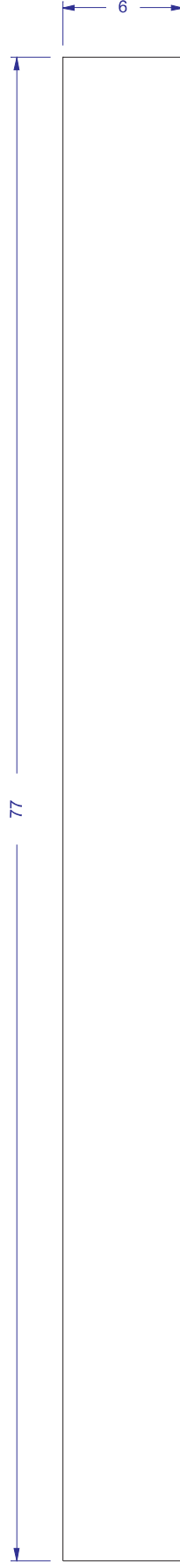
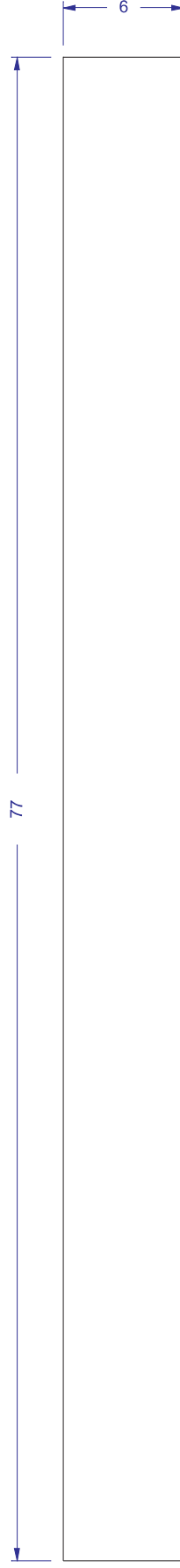
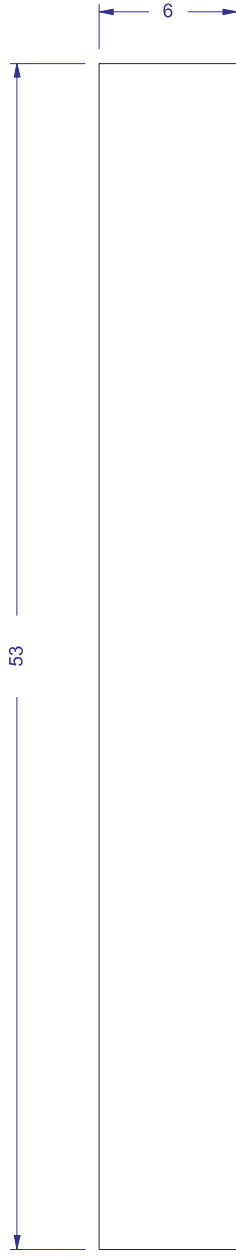

4" Square Cherry - Legs
Plane to 3 1/2" square

Or build up from 3/4" stock as shown in the video

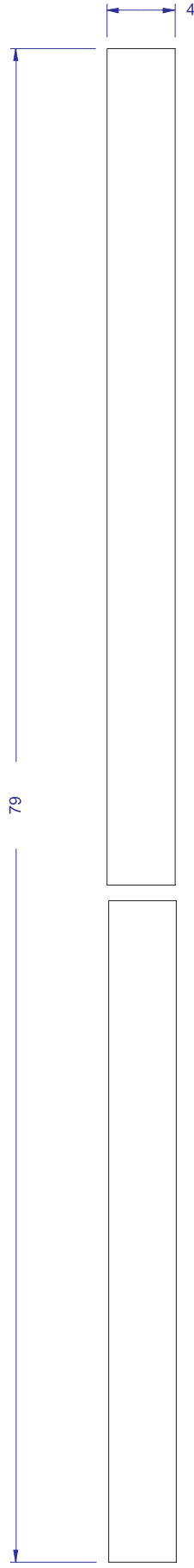
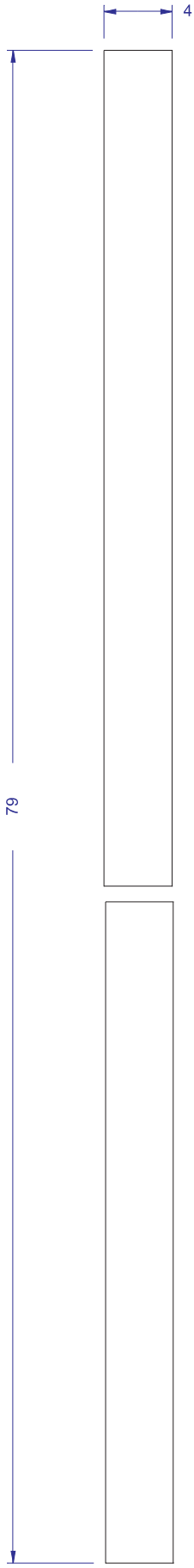

1/2" Cherry to be planed to 3/8" thick

Upper and lower rails to join slats

You will need additional material for the slat spacers

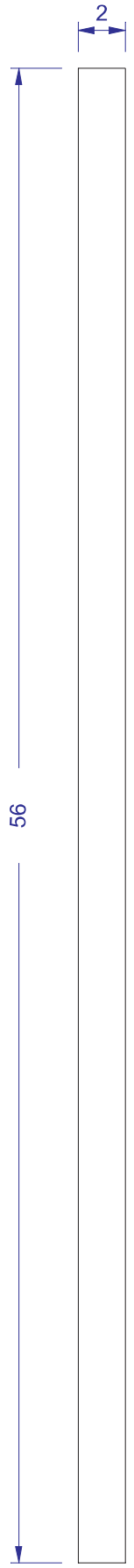
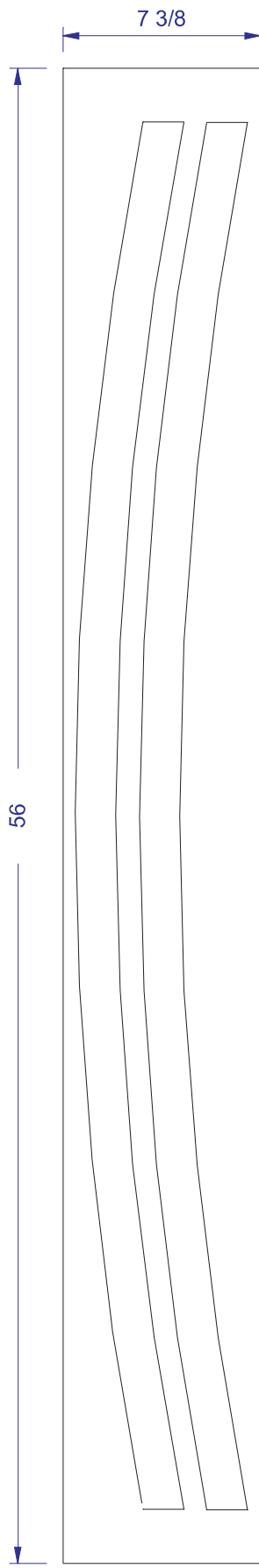
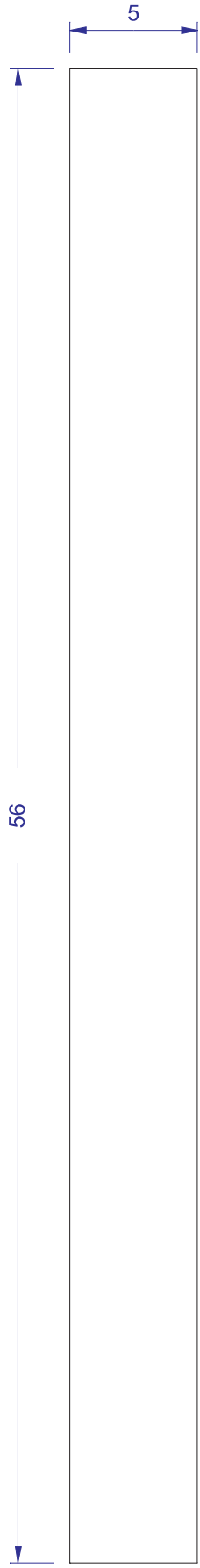

3/4" Thick Cherry - upper and lower rails to join slats

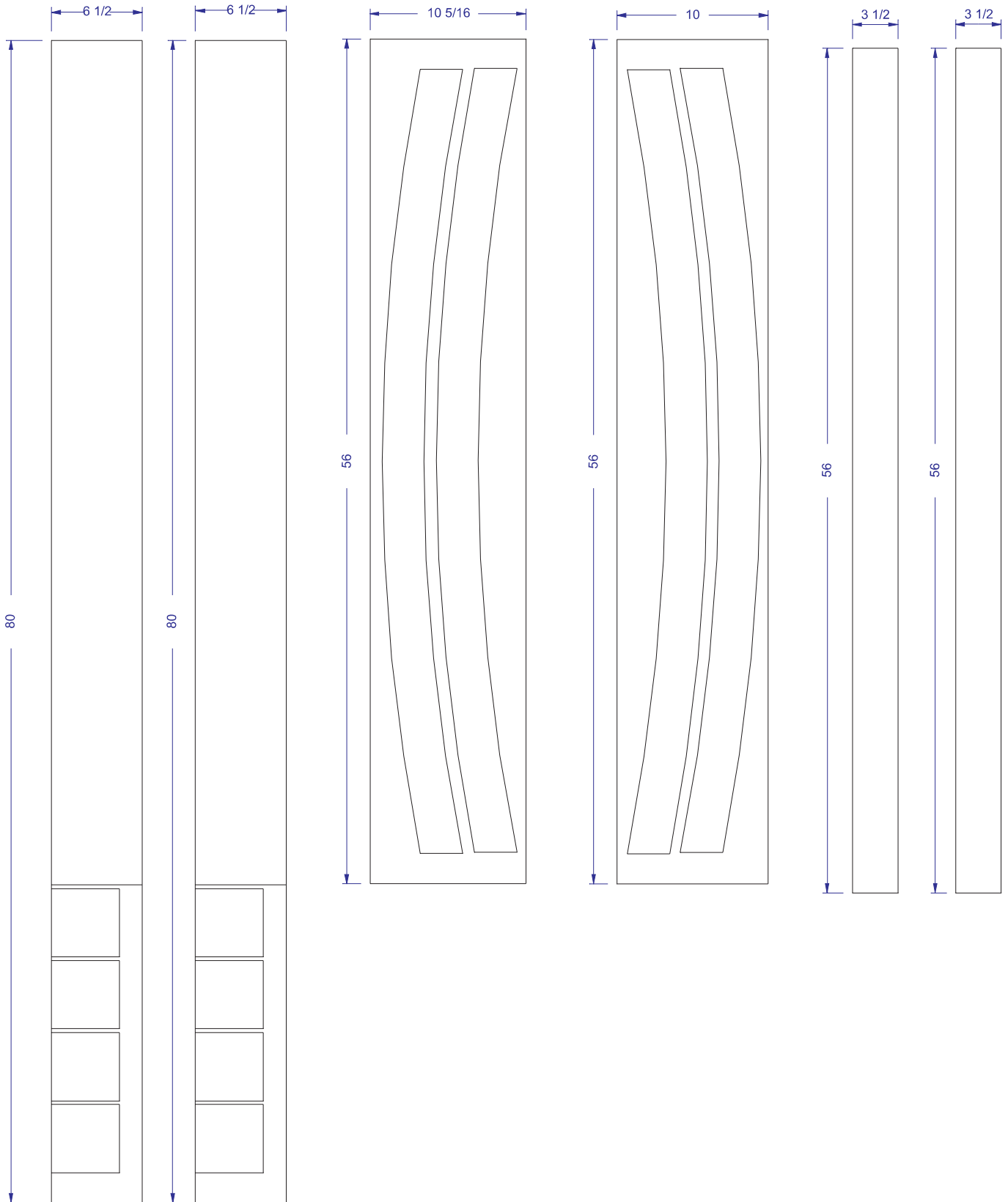

Other materials needed:

- (8) Box spring fasteners (Angle brackets)
- (1 set) Surface mounted keyhole bed rail brackets (90 degree)
- Walnut for applique if desired