

(1) Top - 3/4" Oak

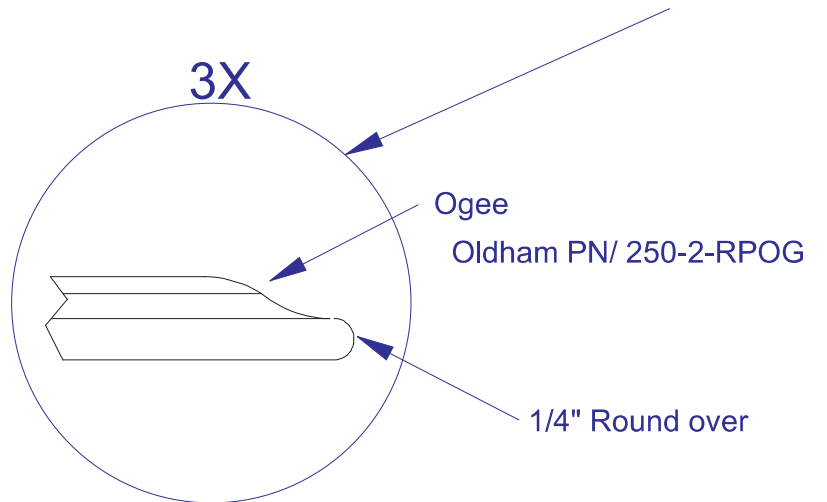

Top Edge Profile

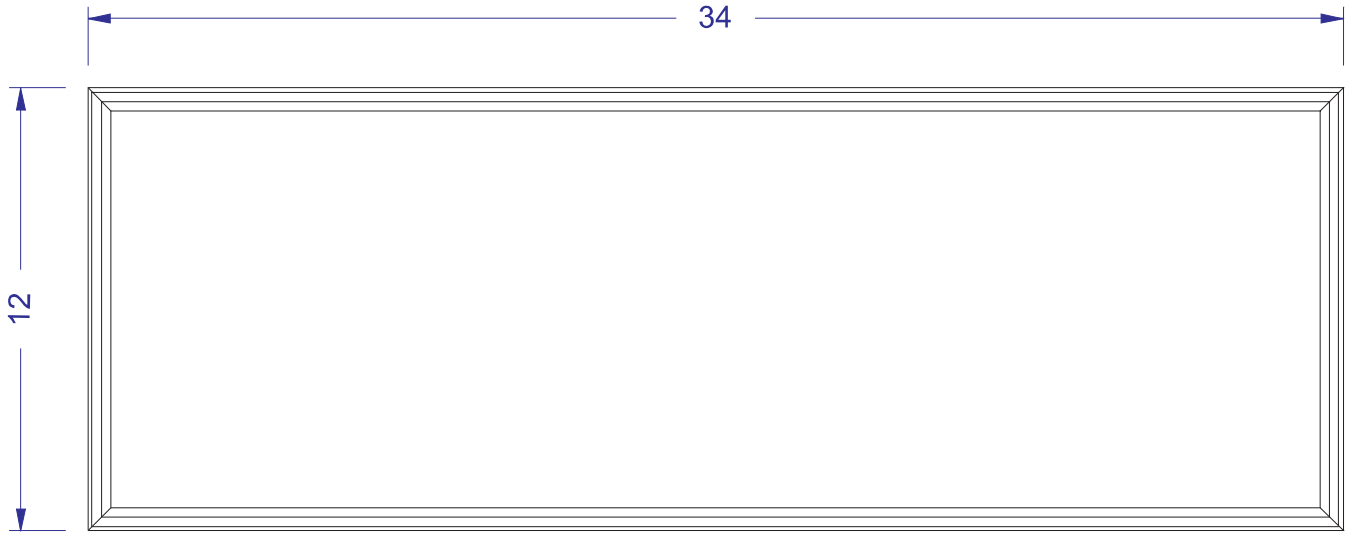
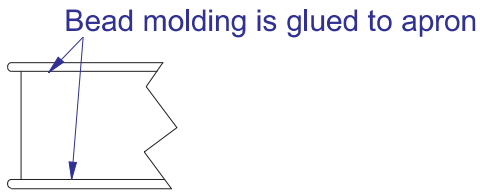

(2) Aprons - 5/8" Oak

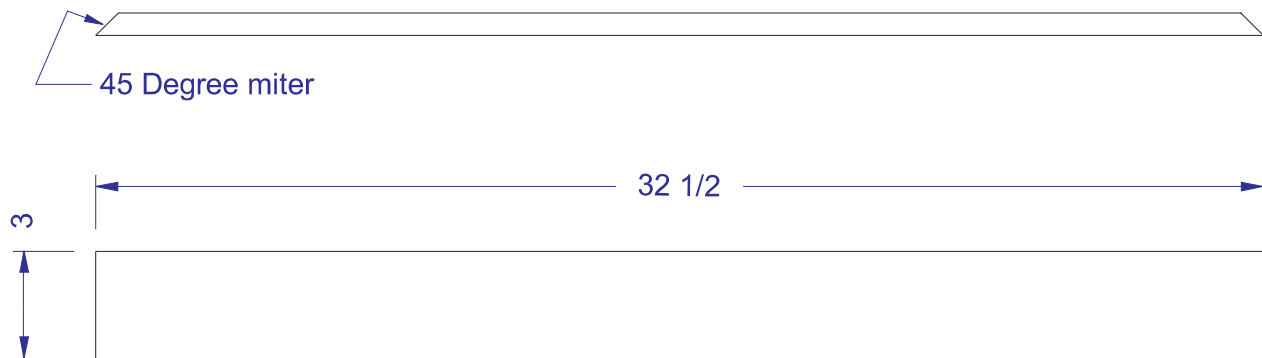

(2) Beaded molding

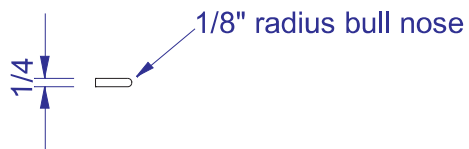
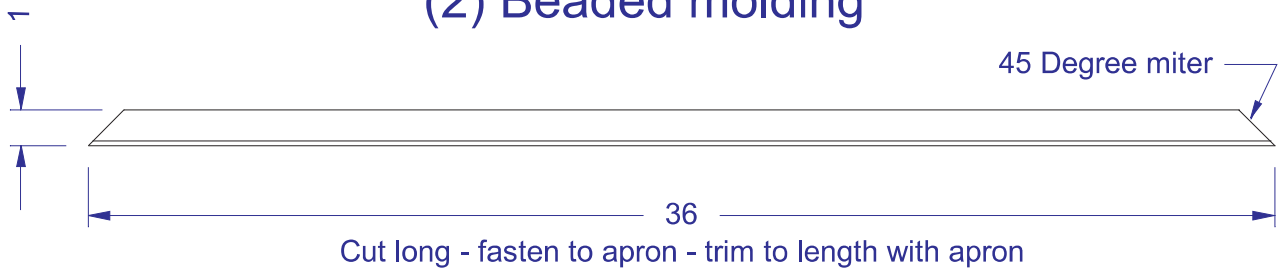

(2) Aprons - 5/8" Oak

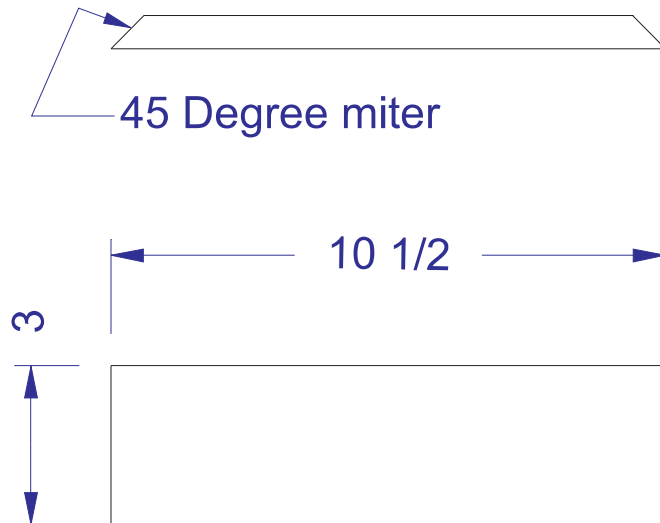

(2) Beaded molding

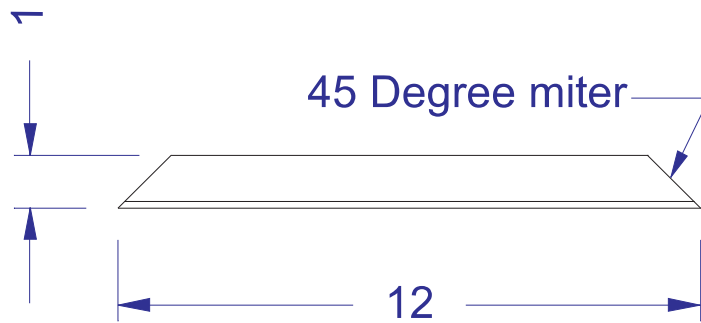

Cut long - fasten to apron - trim to length with apron

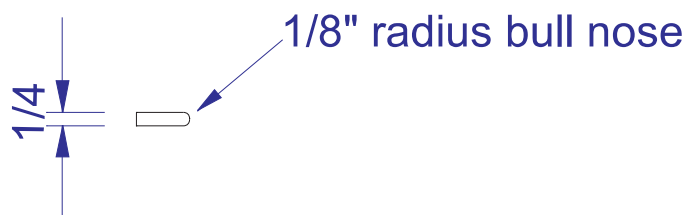

(4) Legs - 1 1/4" Oak

Right front leg shown

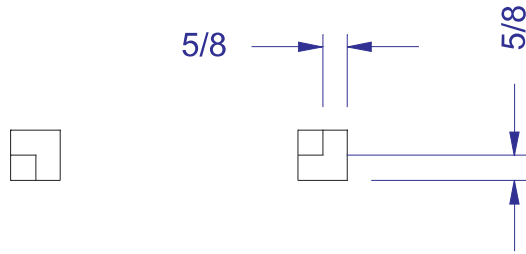

Left side view

Front view

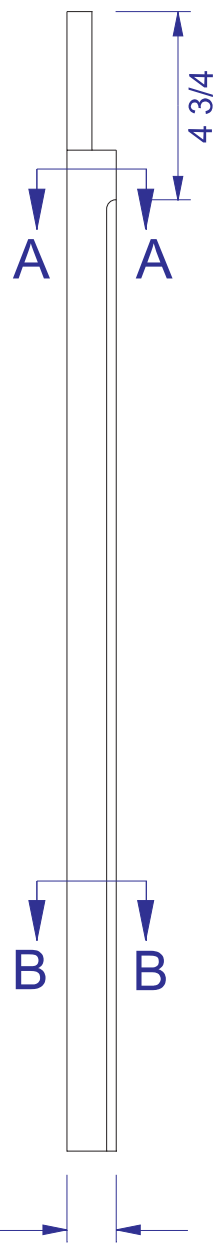
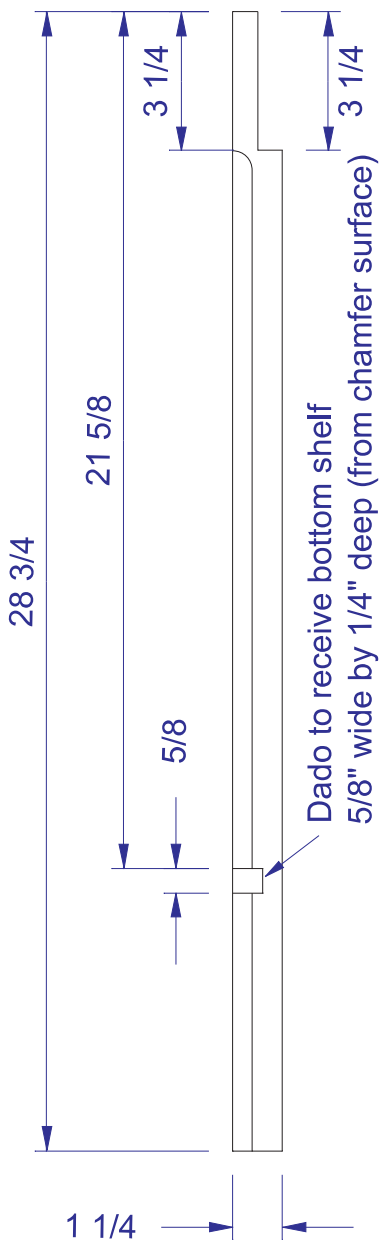

Section A-A

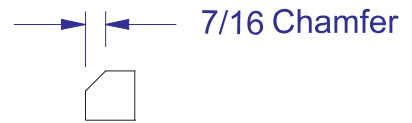

Section B-B

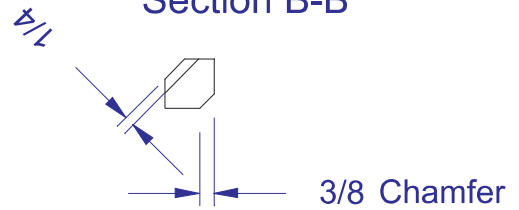

(1) Bottom shelf - 5/8" Oak

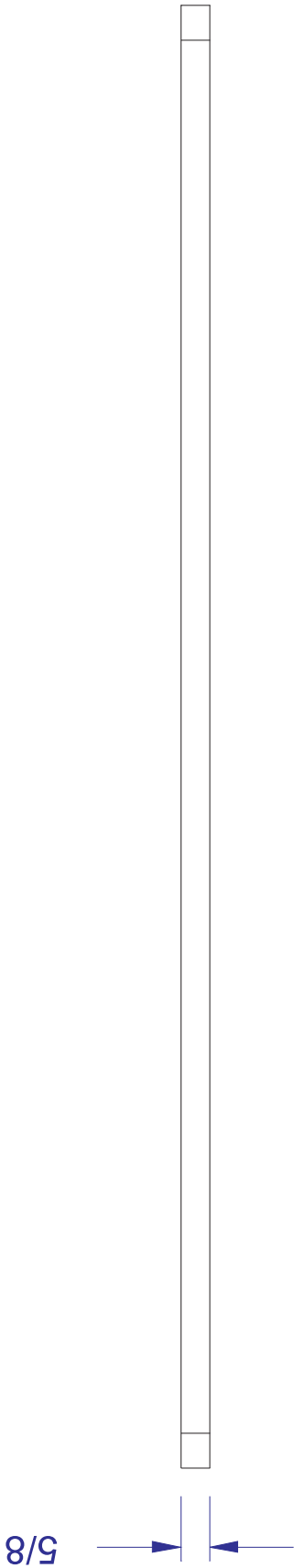
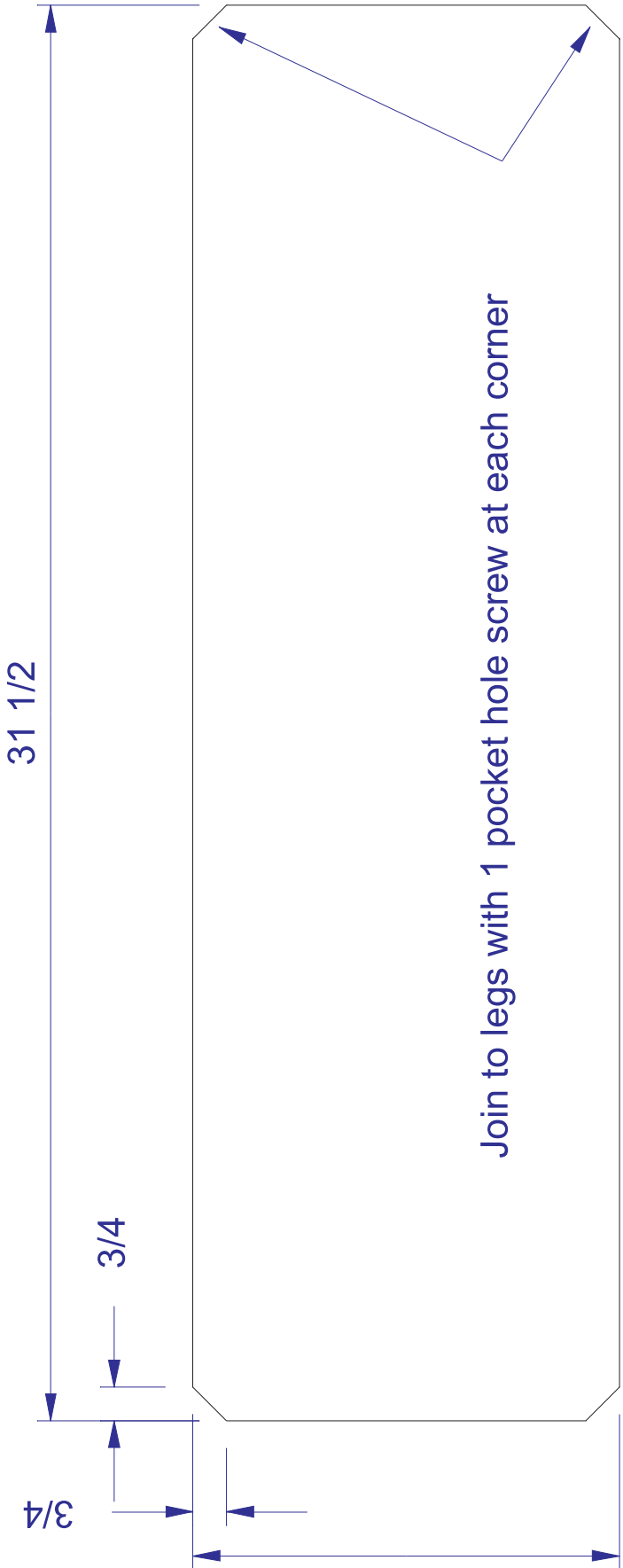

(8) Corner Brackets
1/2" Oak

