

(1) Top panel - 3/4" Birch plywood

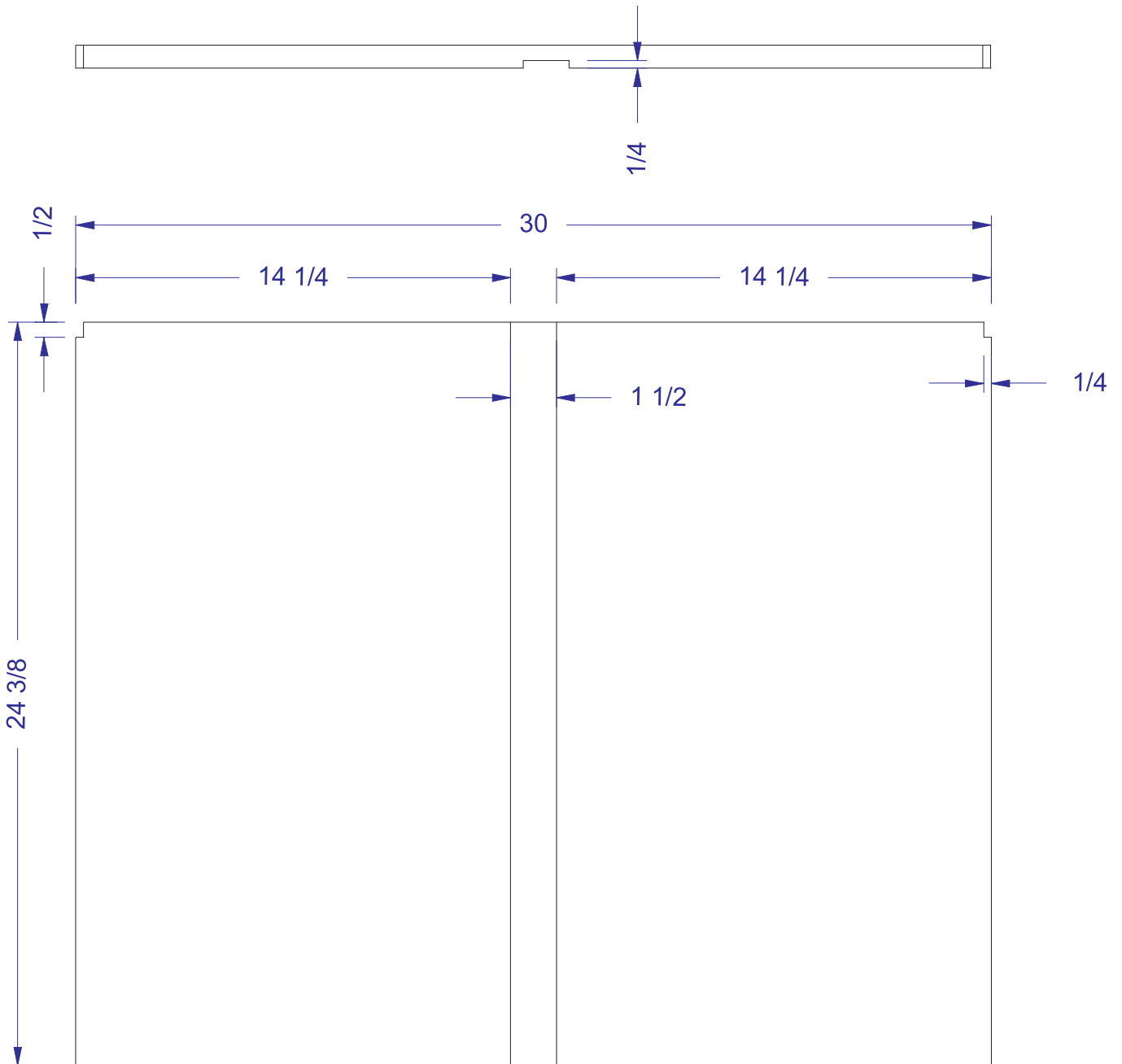

(1) Bottom panel - 3/4" Birch plywood

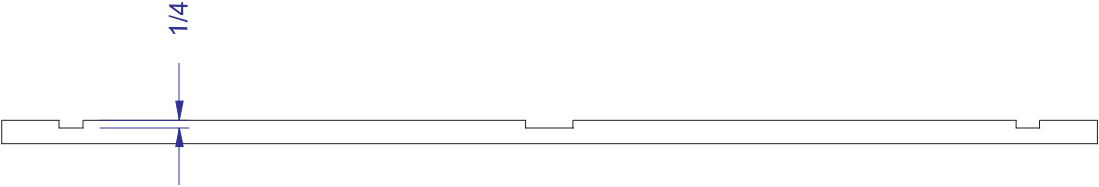
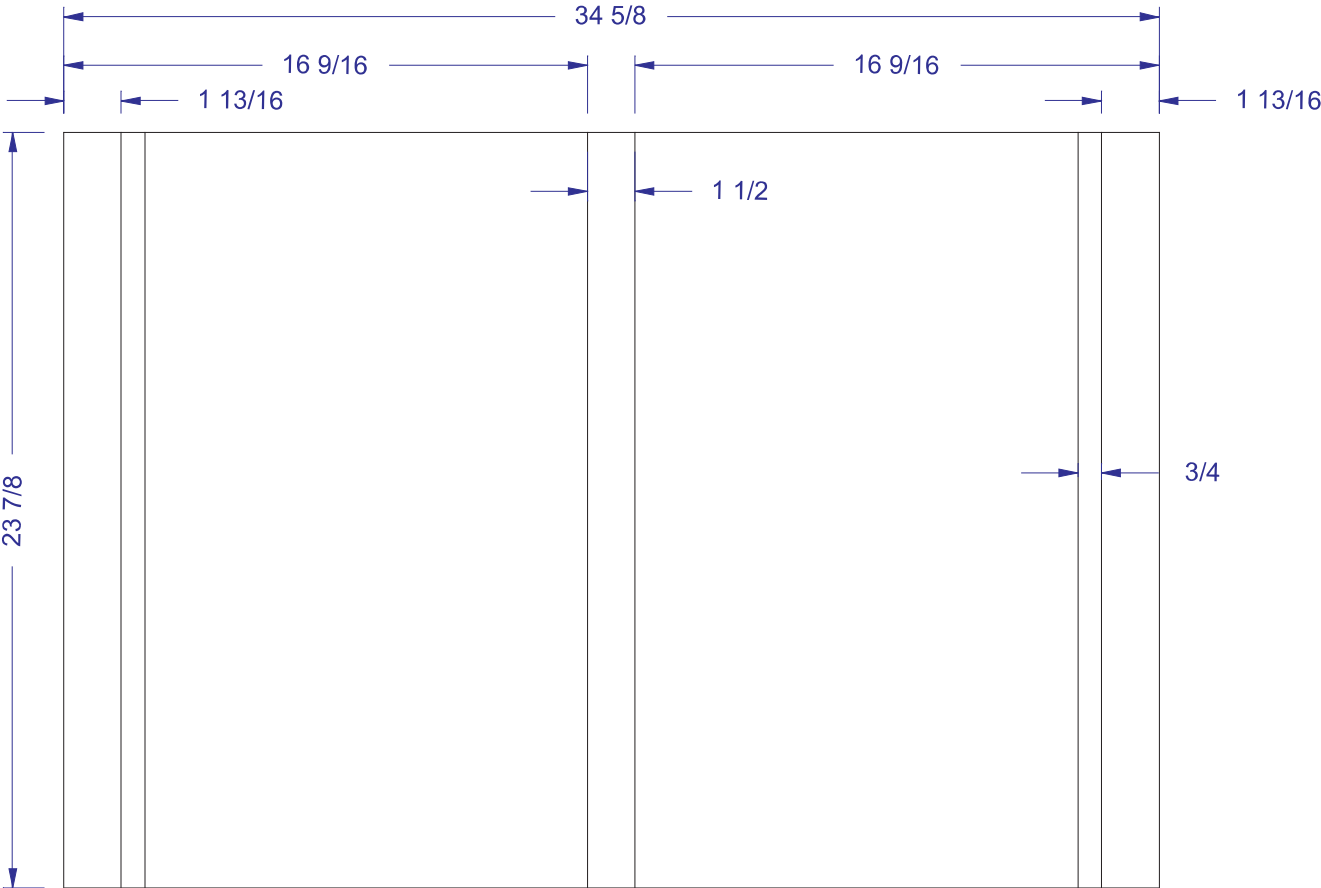

(2) Side panels - 1/2" Birch plywood

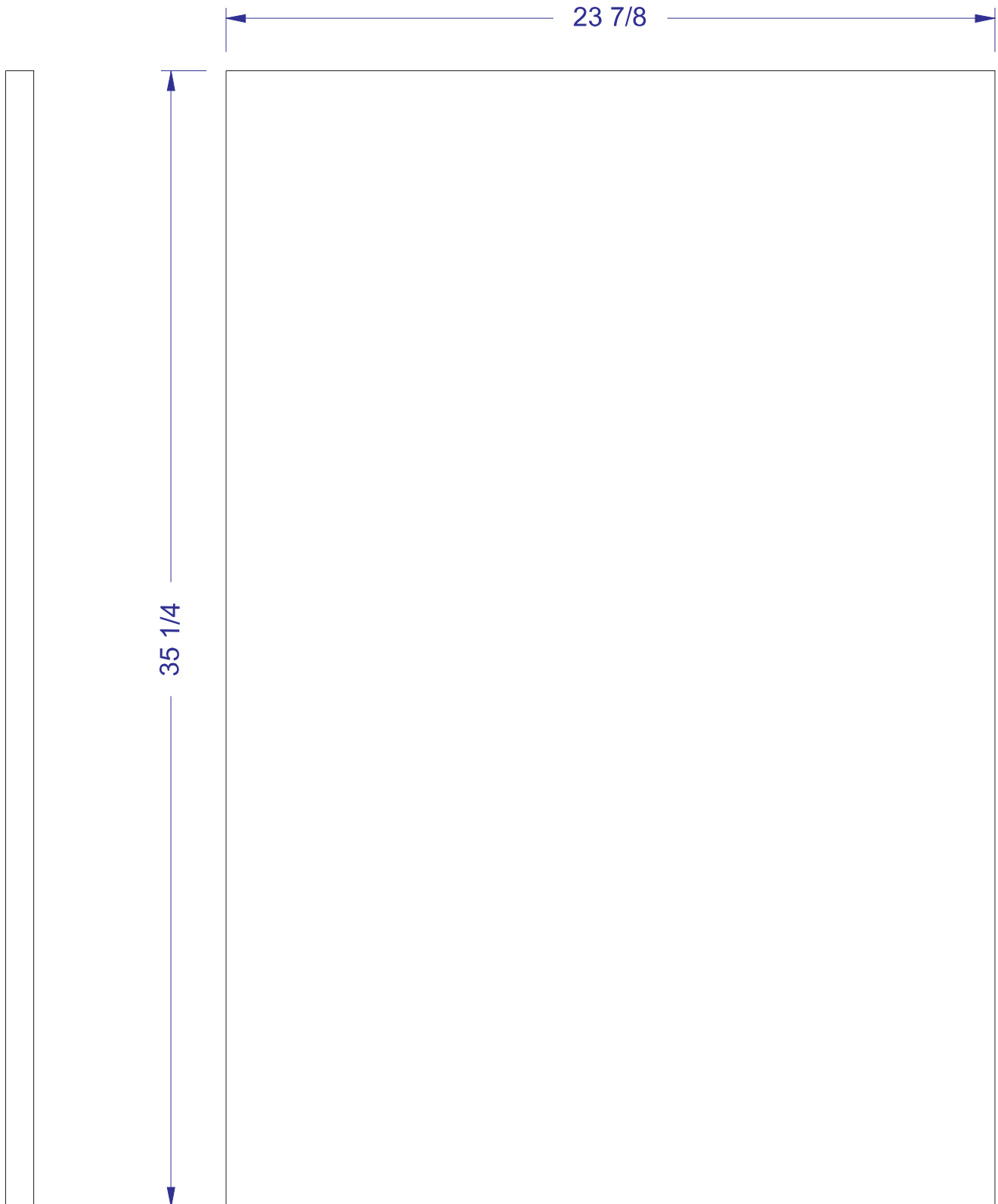

(2) Outside drawer support panels - 3/4" Birch plywood

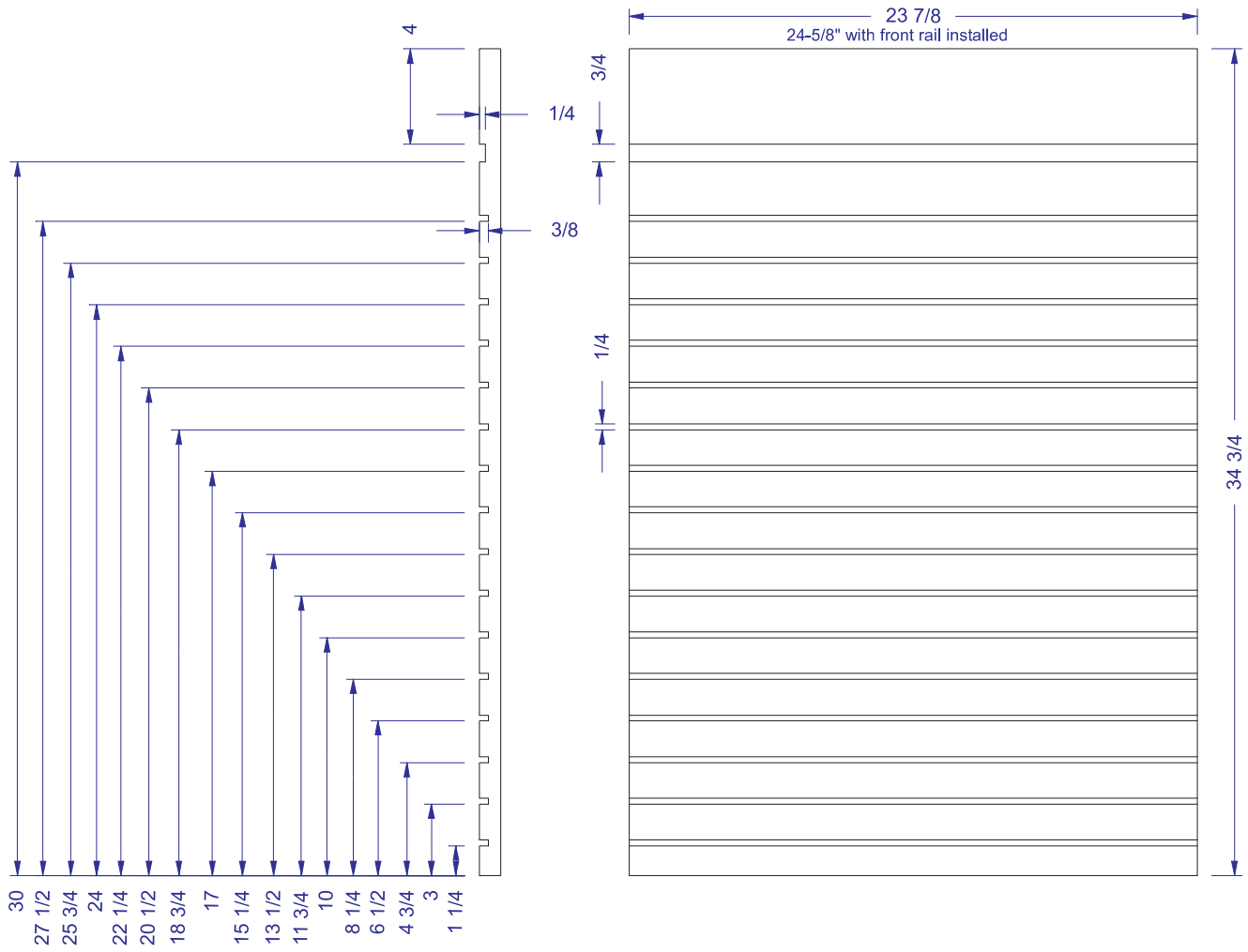

(2) Center drawer support panels - 3/4" Birch plywood

Laminate together

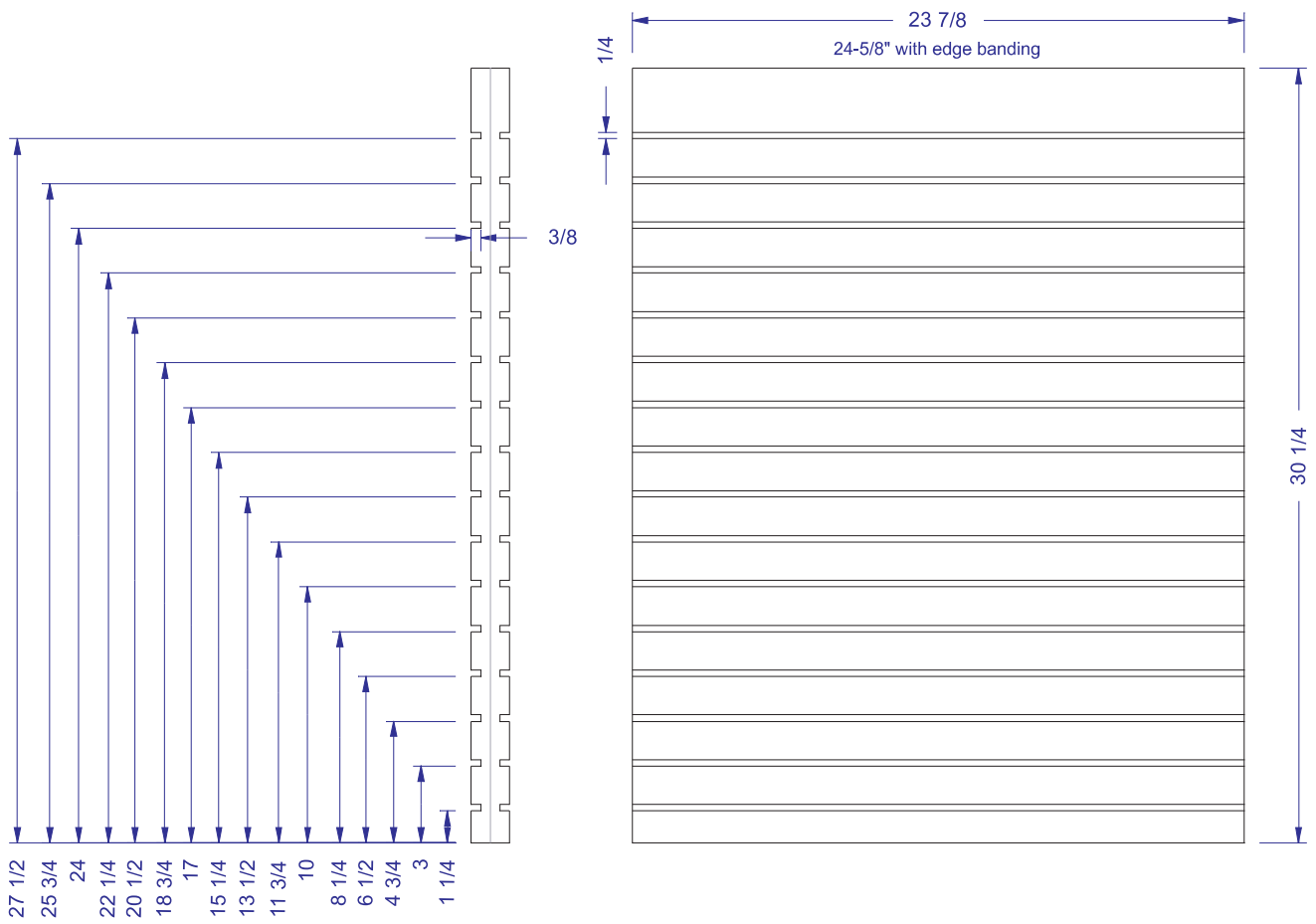



(2) Trim pieces - 3/4" Birch

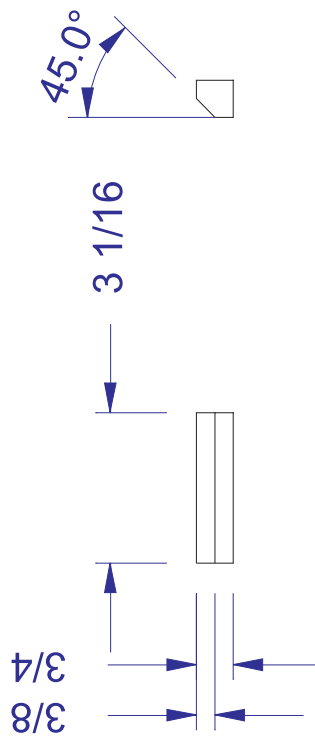

(2) Tops - 3/4" Birch

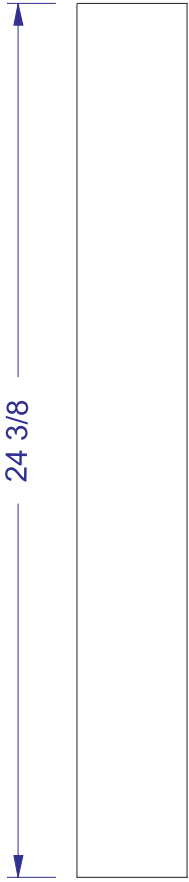

(2) Stiles - 3/4" Birch

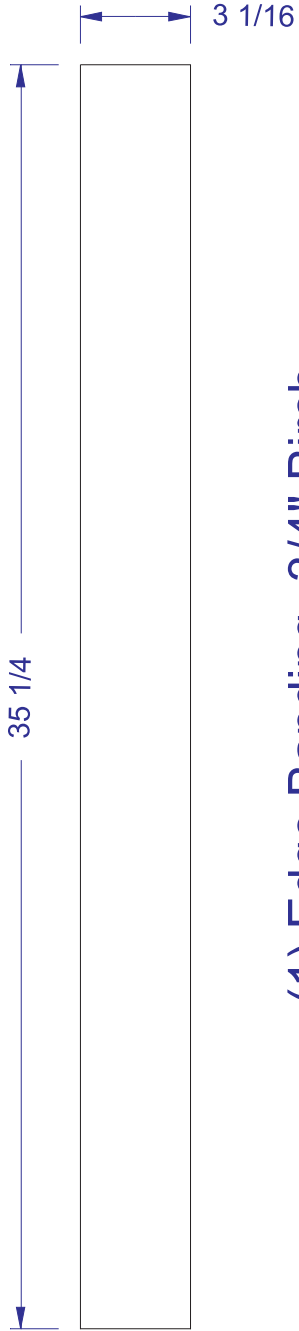

(1) Edge Banding- 3/4" Birch

Center Drawer Carrier Panel



(6) Side panel spacers - 3/4 Birch plywood

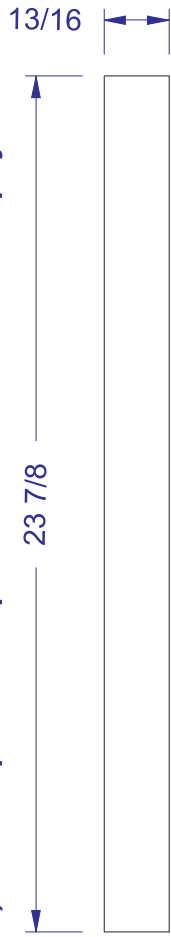

Center drawer support panel assembly

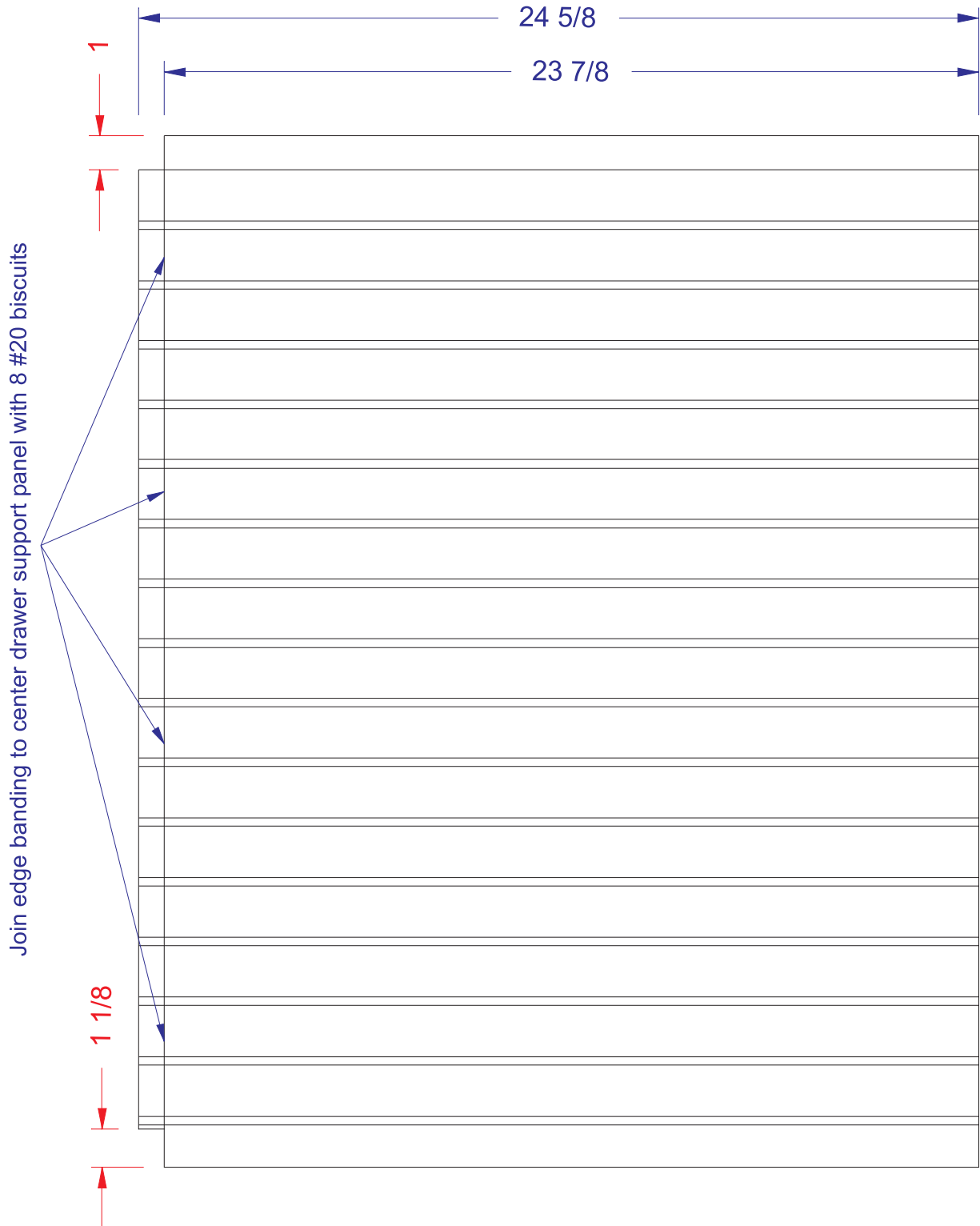

Side subassembly - left side shown - view from front

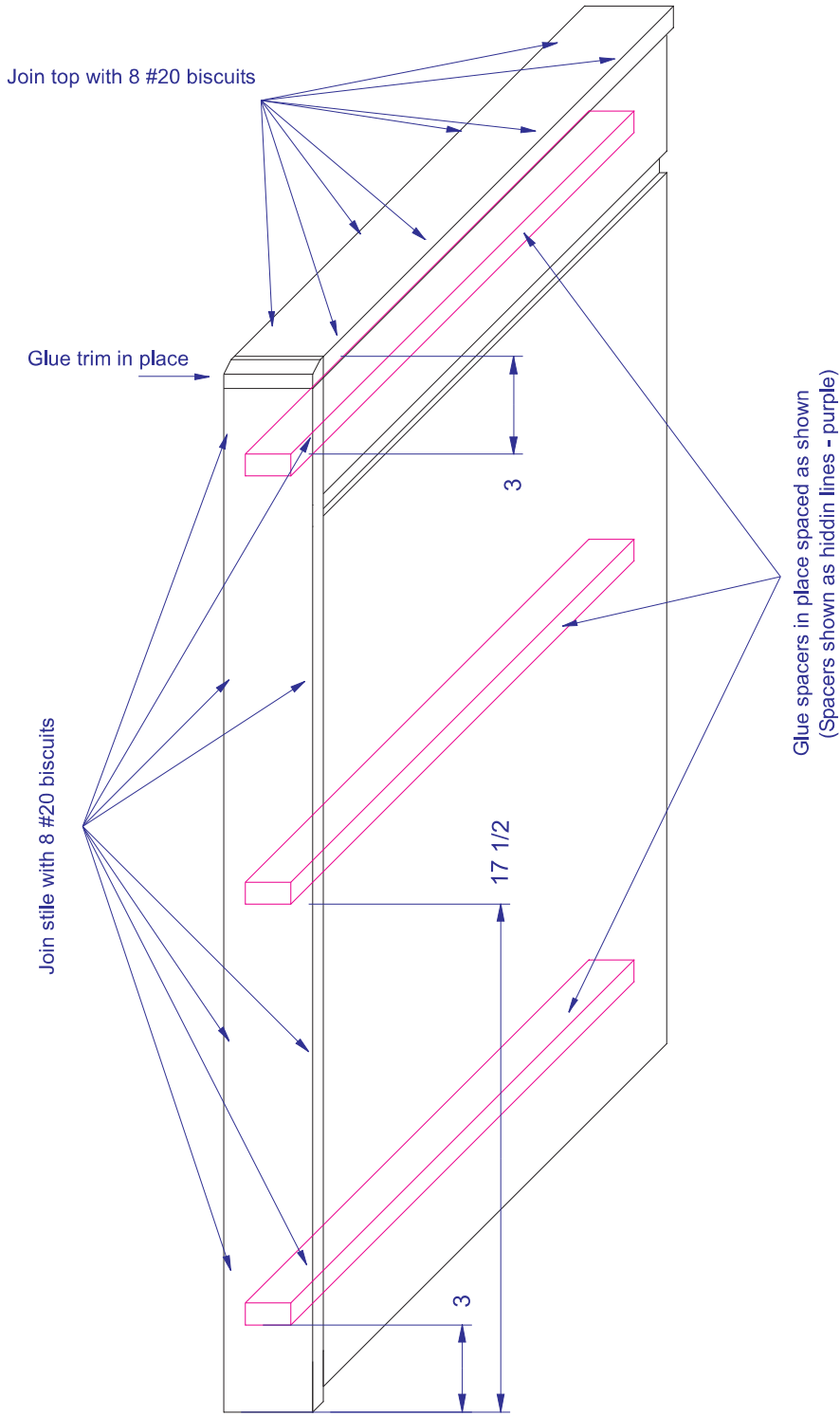

These dimensions will help with machining the dados for the drawers supports

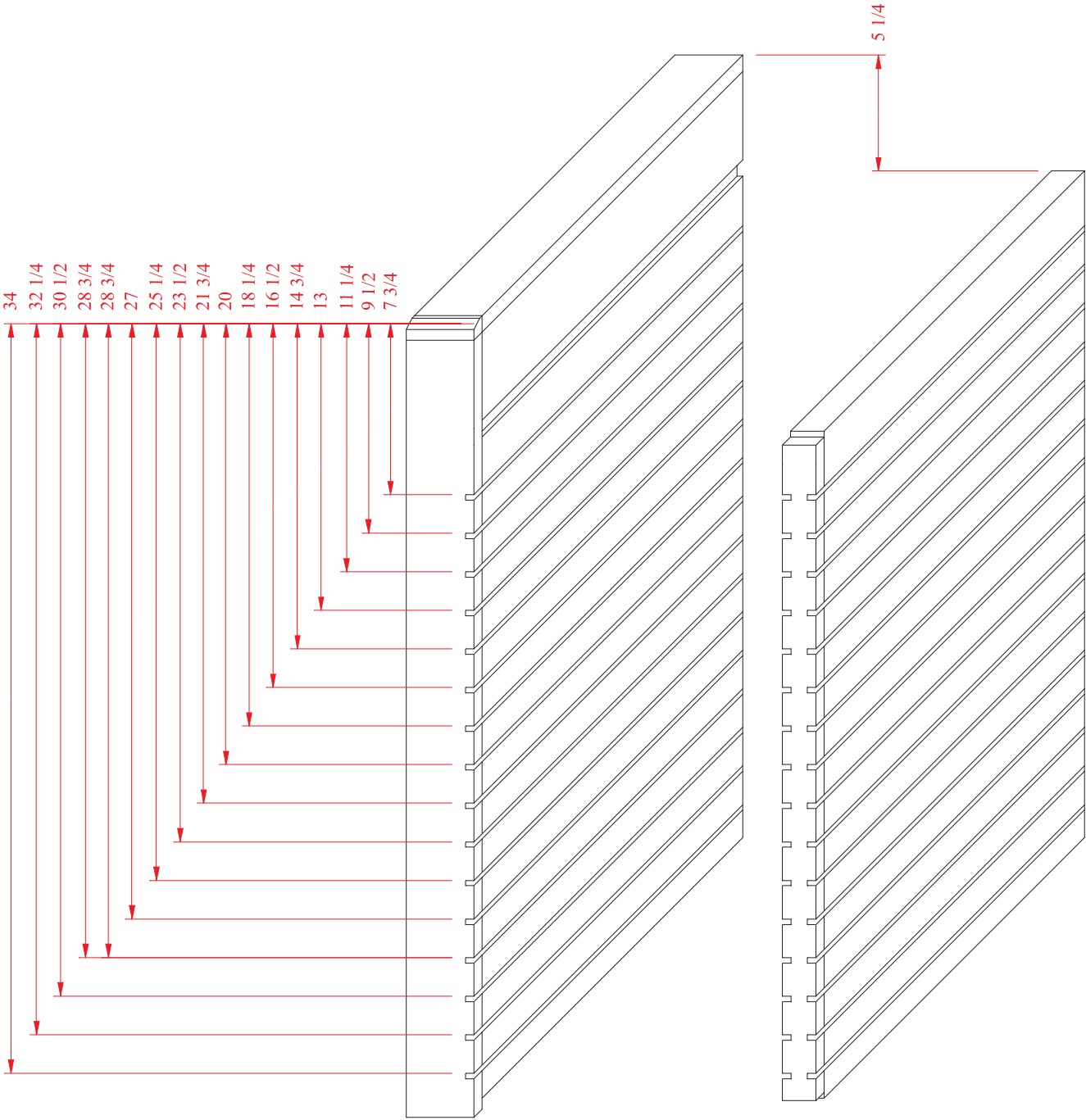

(1) Back panel - 1/2" Birch plywood

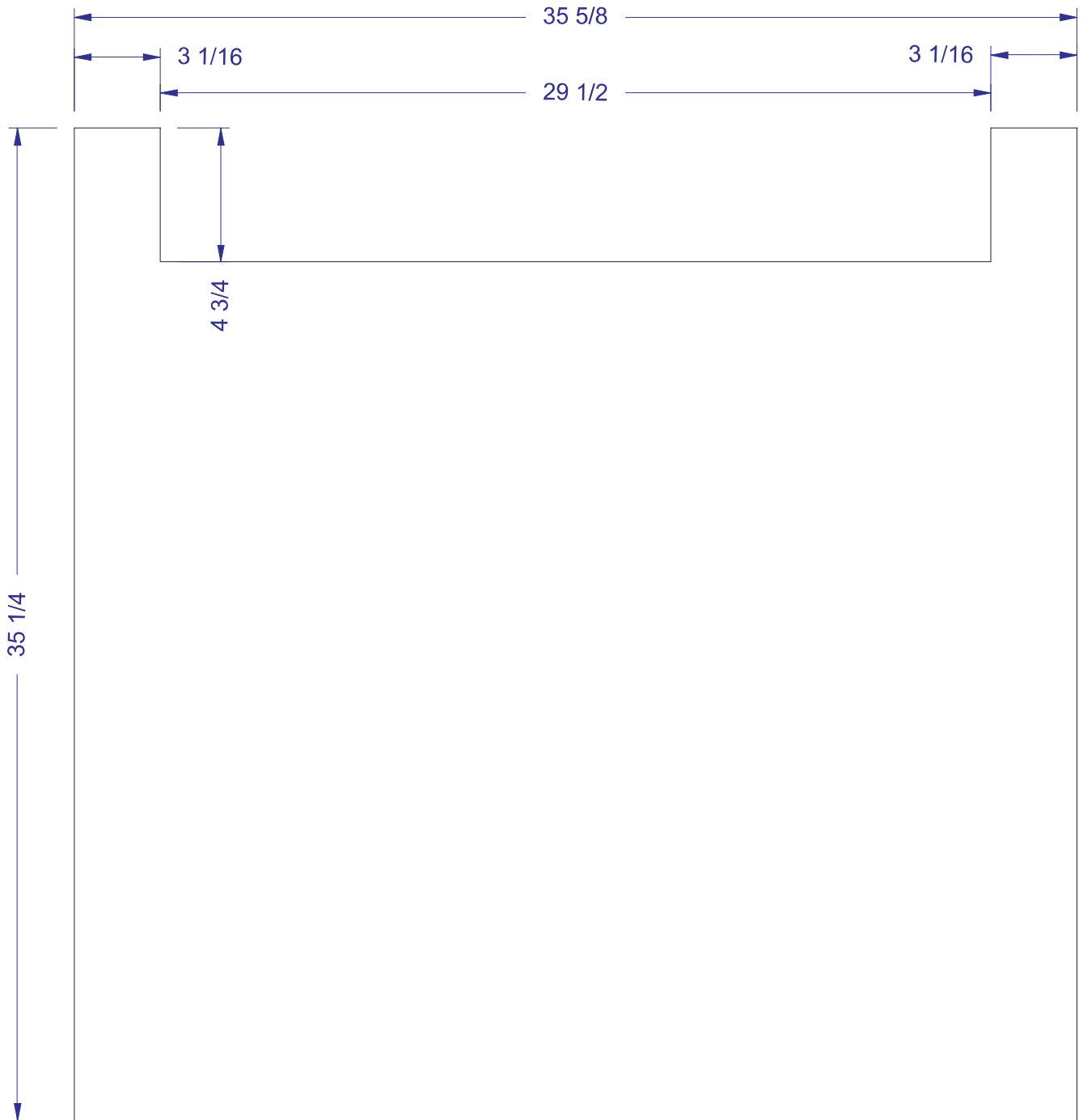

Case Assembly

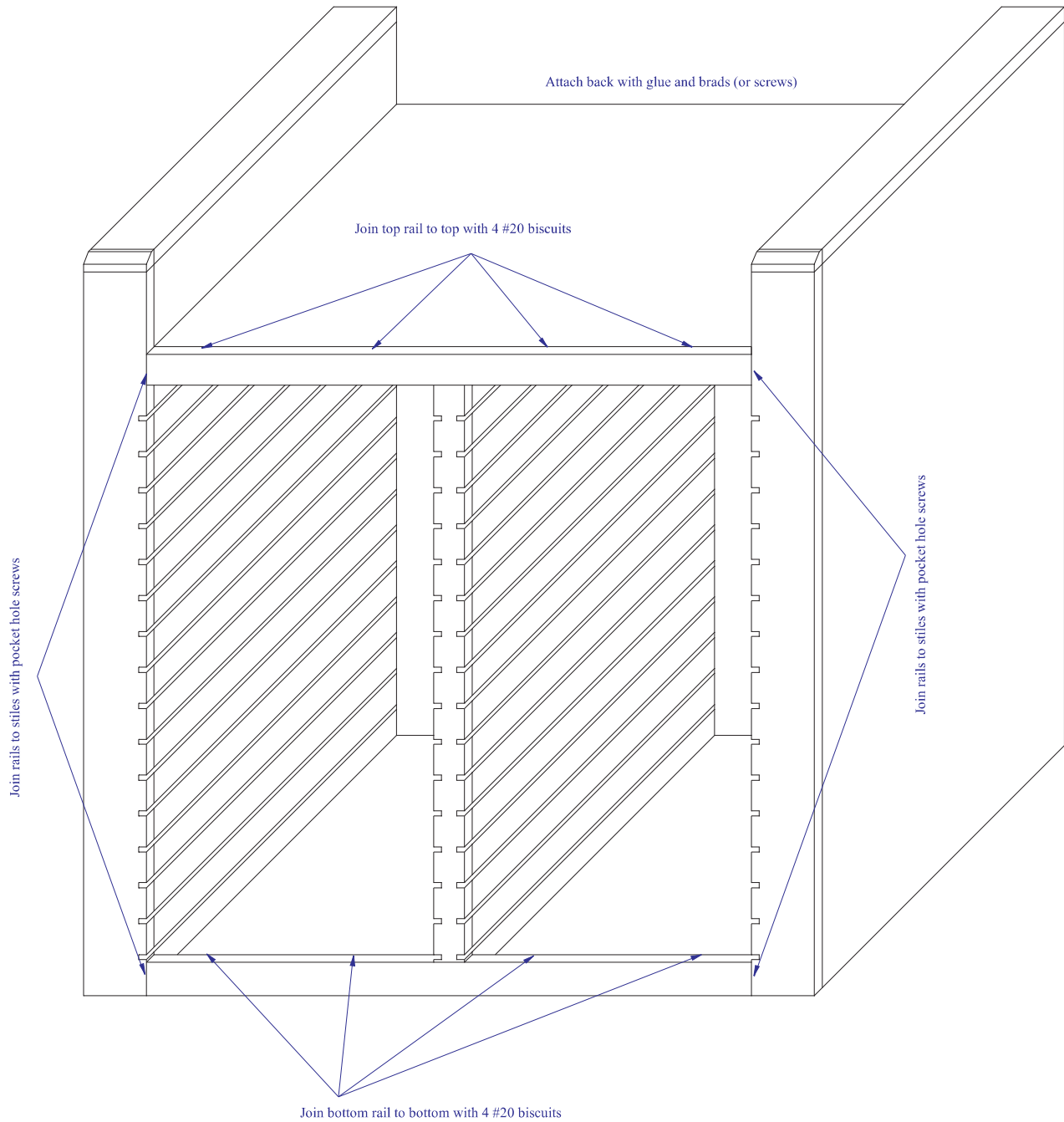

Mobility Solutions:

- (4) 3" swivel casters
- (16) 5/16-18 x 1 1/2" hex head bolts
- (16) 5/16-18 nuts
- (32) 5/16" washers

Drawer Details & Assembly

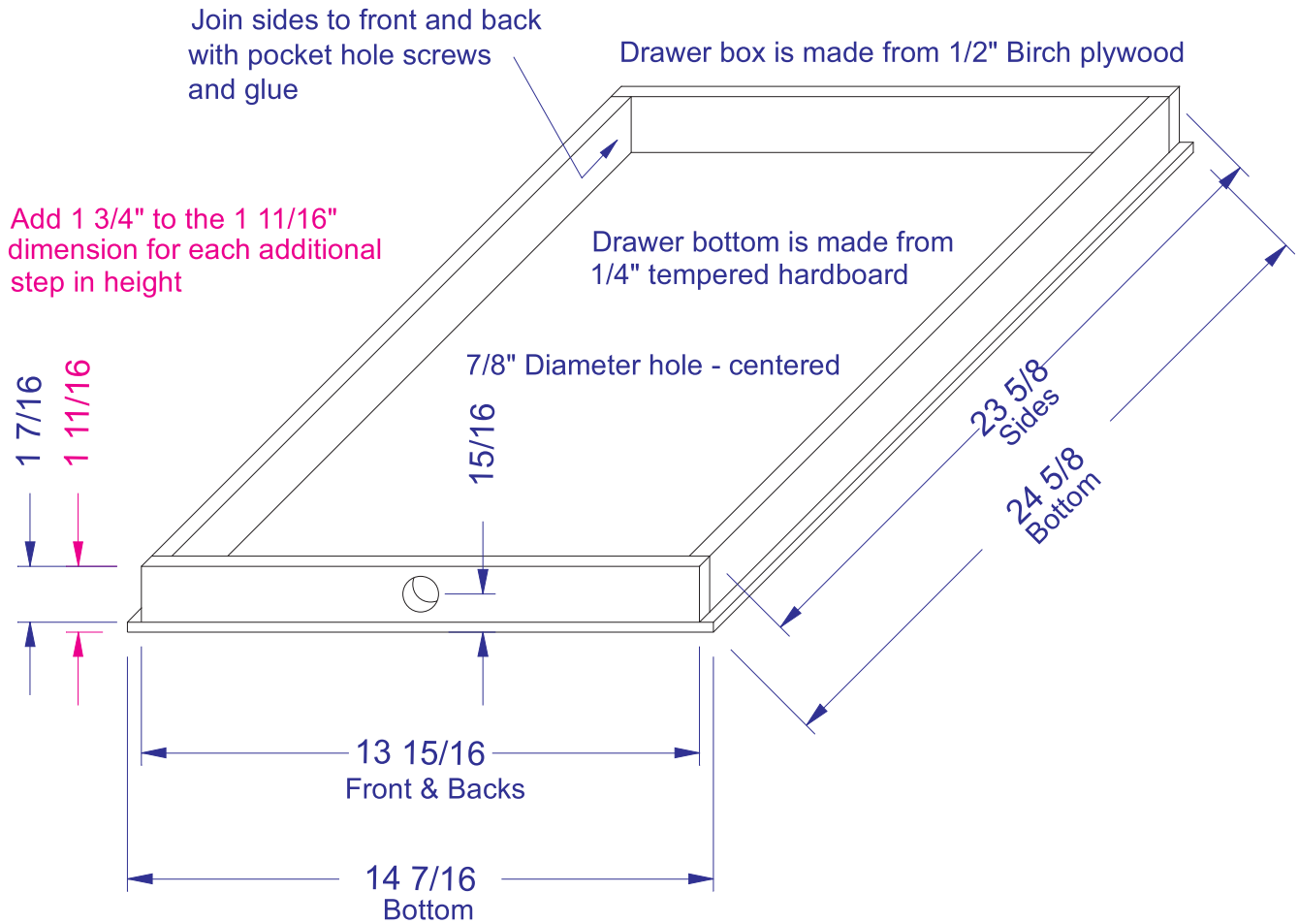

Join bottom to drawer box with glue and 3/4" brads - 6~8" apart.
 Install (2) #8 x 1" screws through bottom into front on either side of finger hole.
 Install (2) #8 x 1" screws through bottom into sides - 1 inch in from back edge.

Work Support Detail & Assembly

Right side shown - two required (left and right)

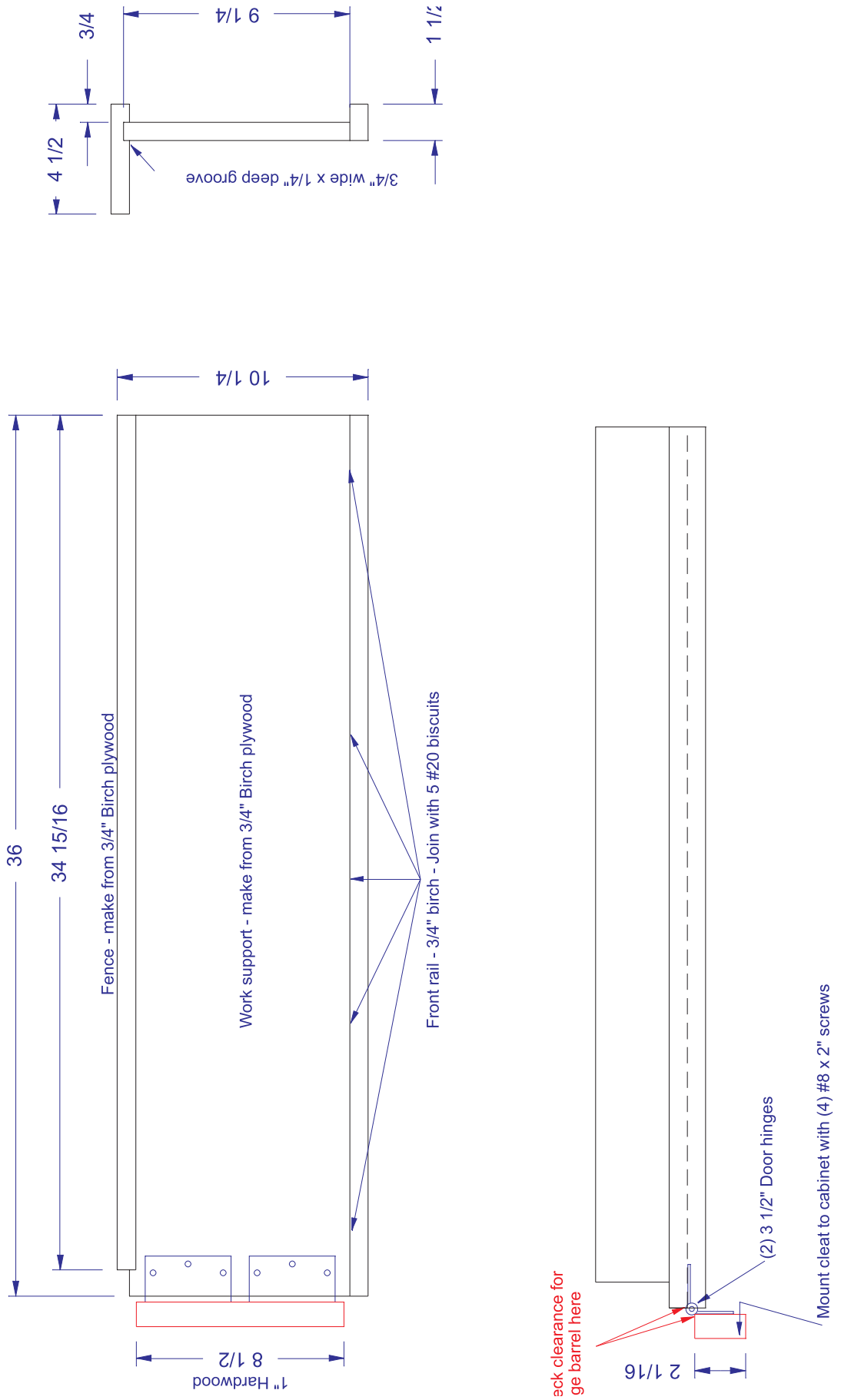

(4) Brace Stops - 3/4" Birch plywood

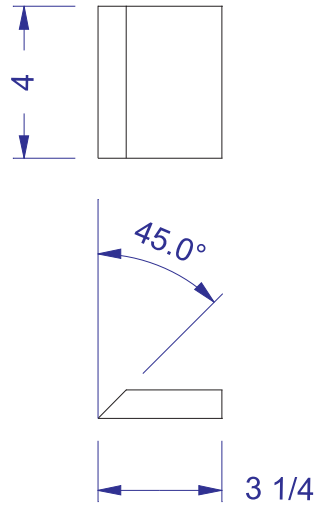

(2) Braces - 3/4" Birch plywood



Work Support Brace Assembly

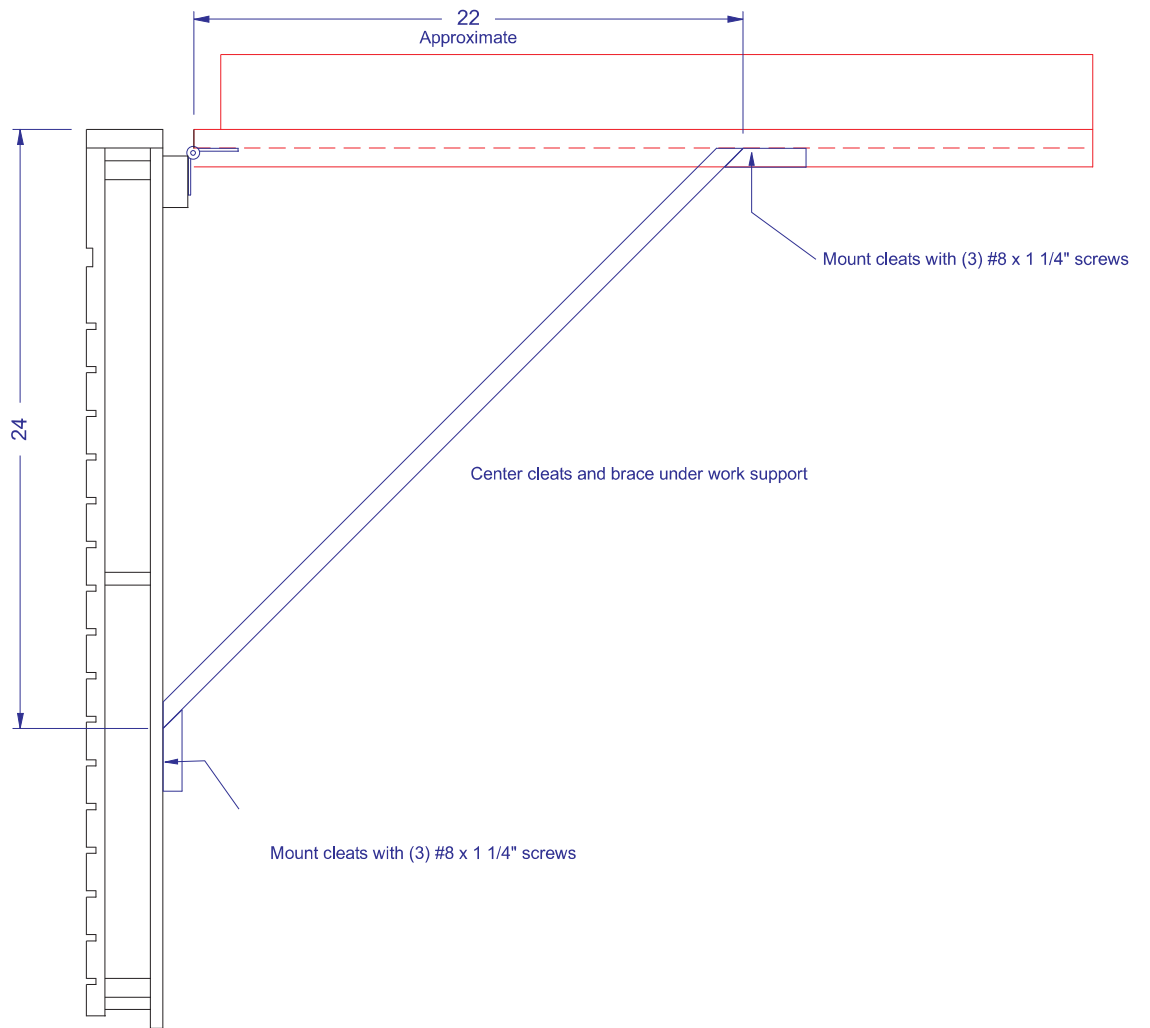

3/4" x 48" x 96" Birch plywood

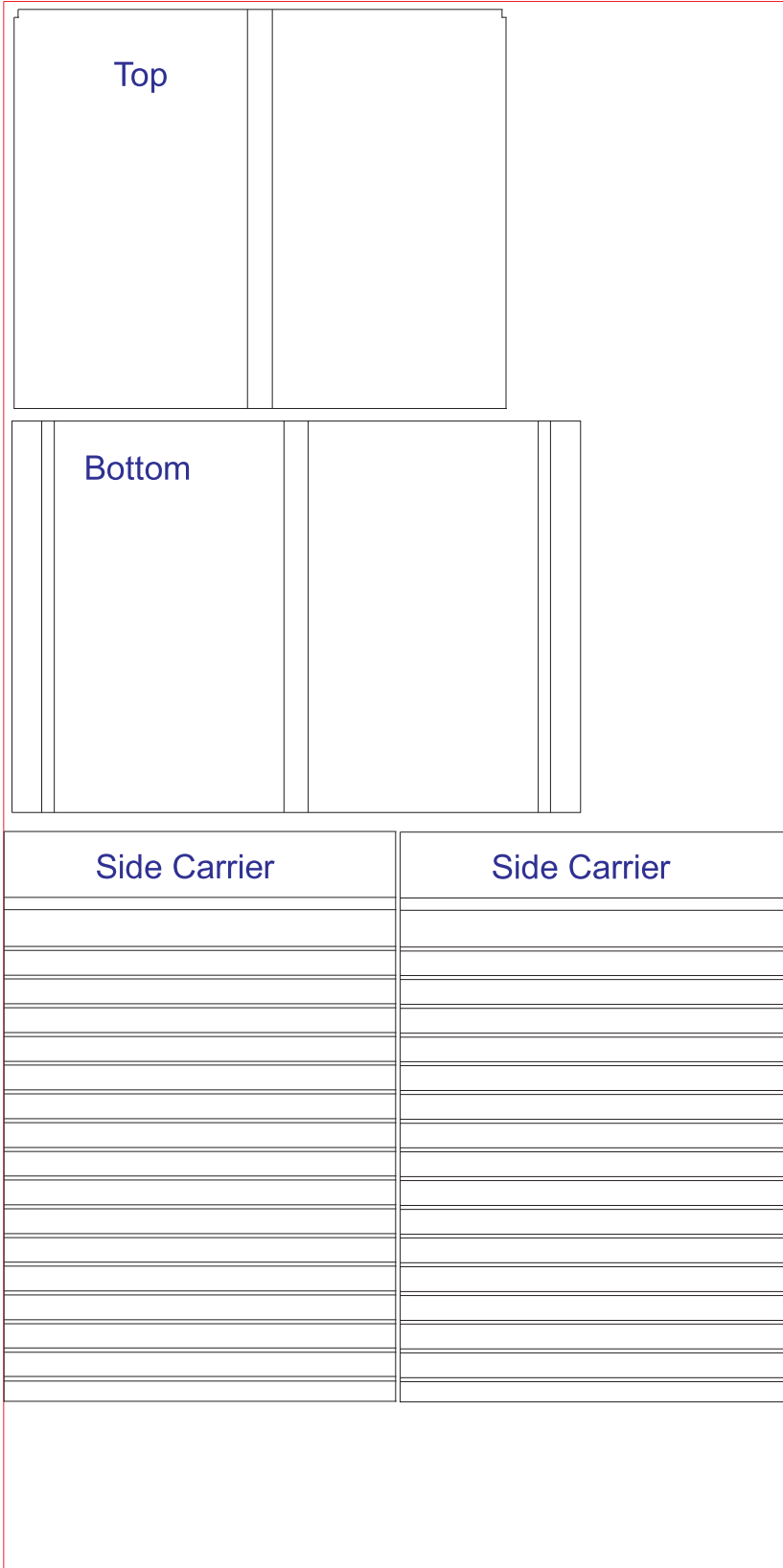

3/4" x 48" x 96" Birch plywood

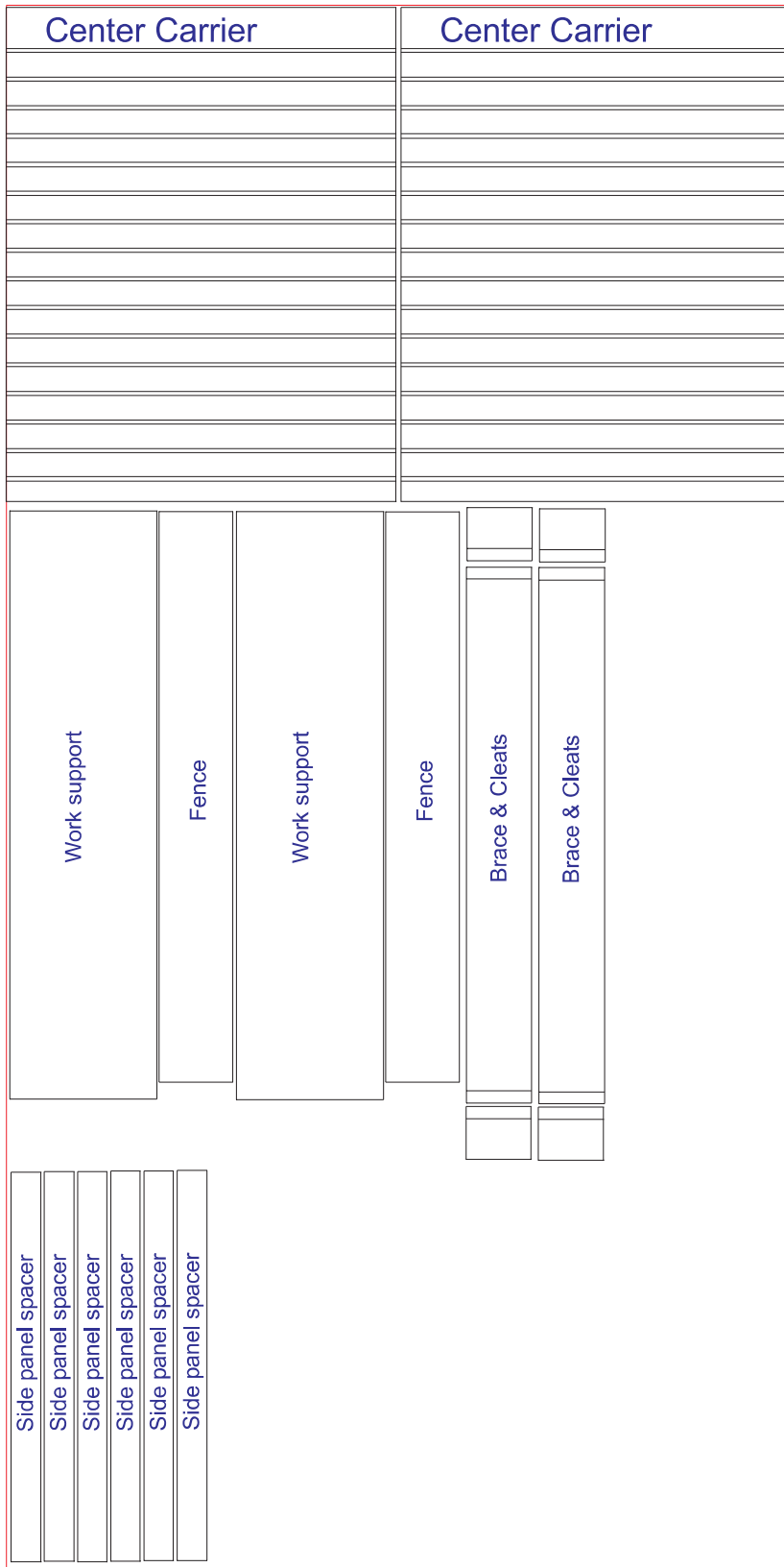

1/2" x 48" x 96" Birch plywood

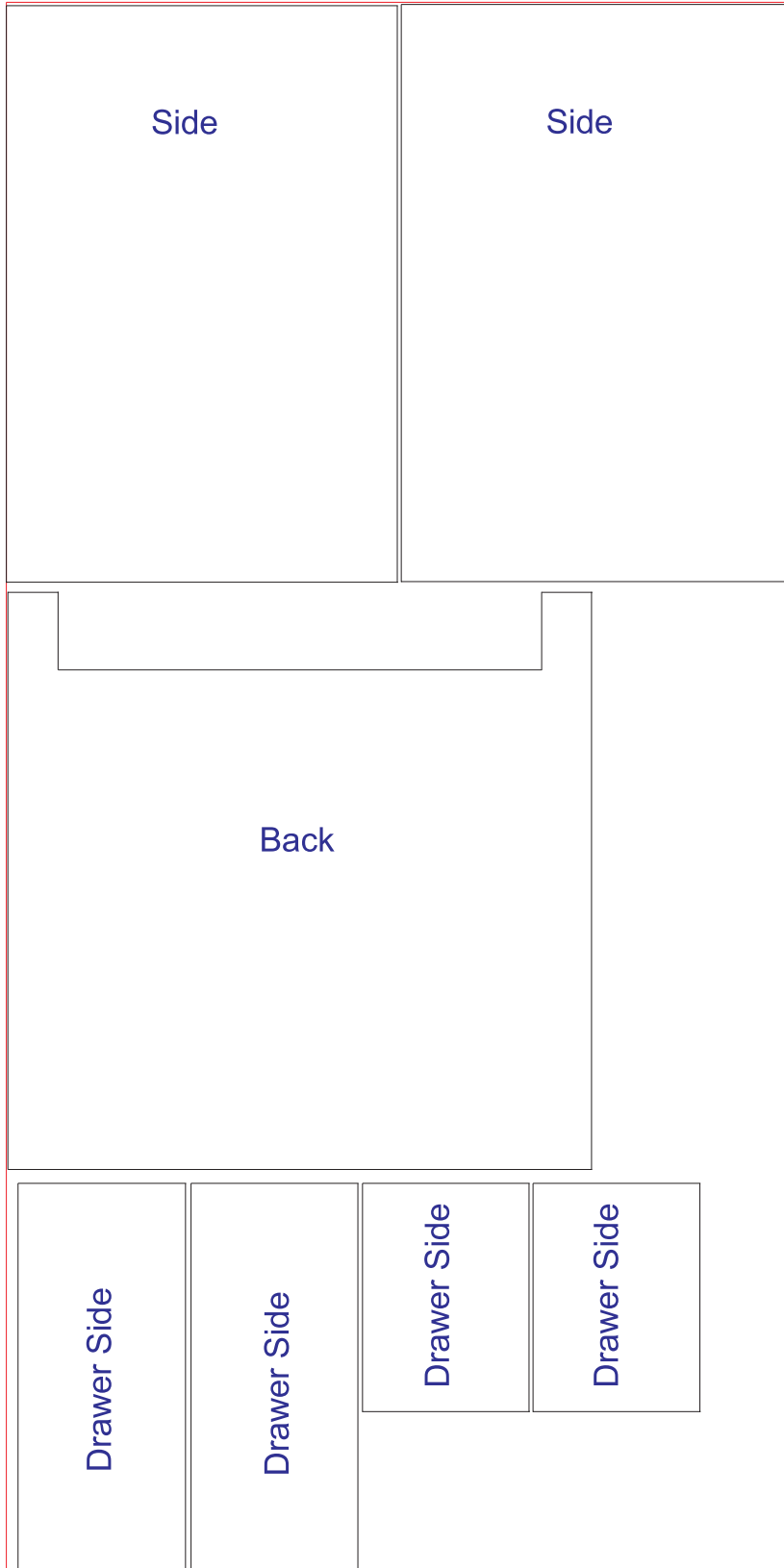

1/2" x 48" x 96" Birch plywood
Drawer Sides

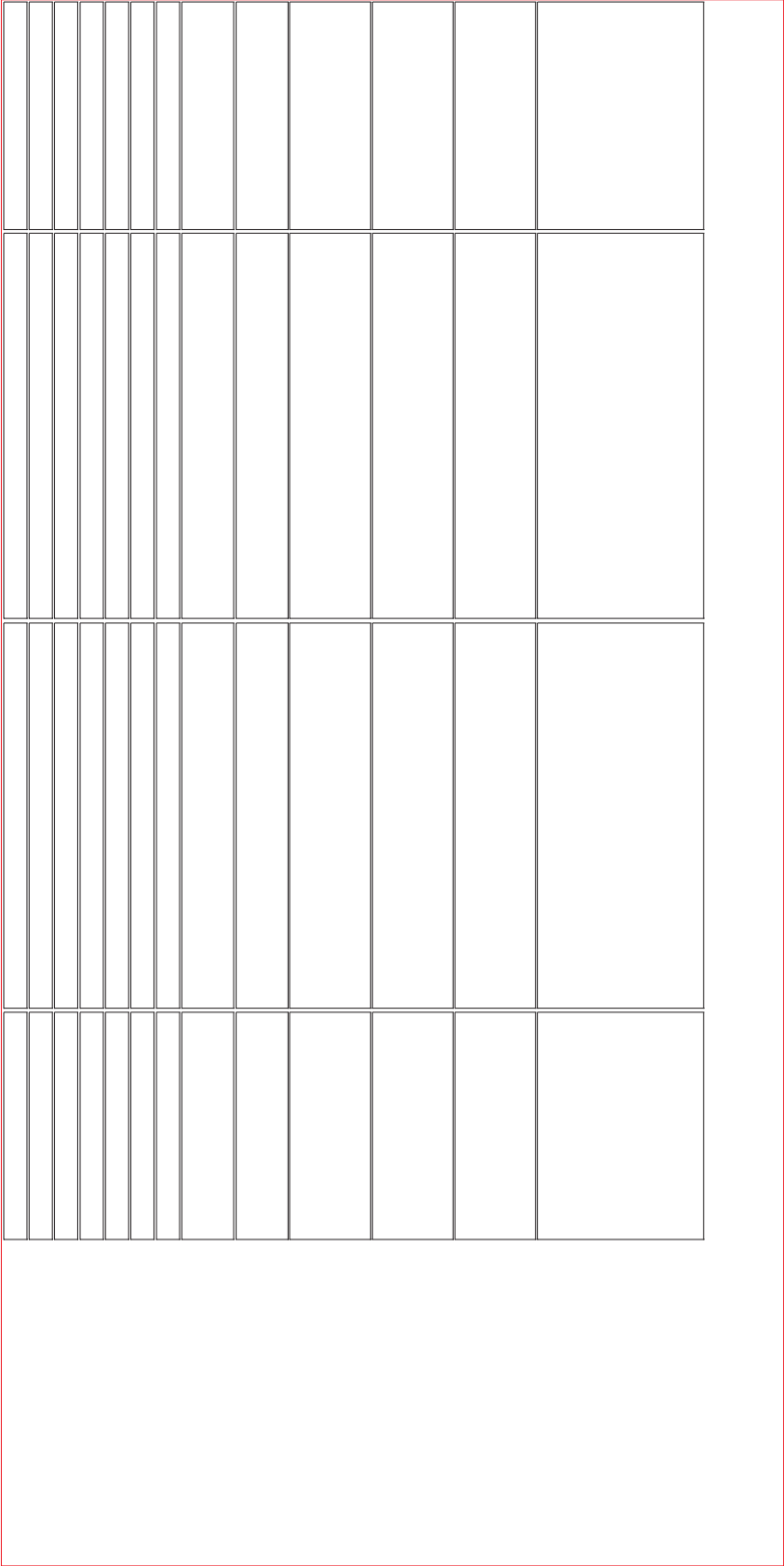

1/4" x 48" x 96" hardboard - tempered if available

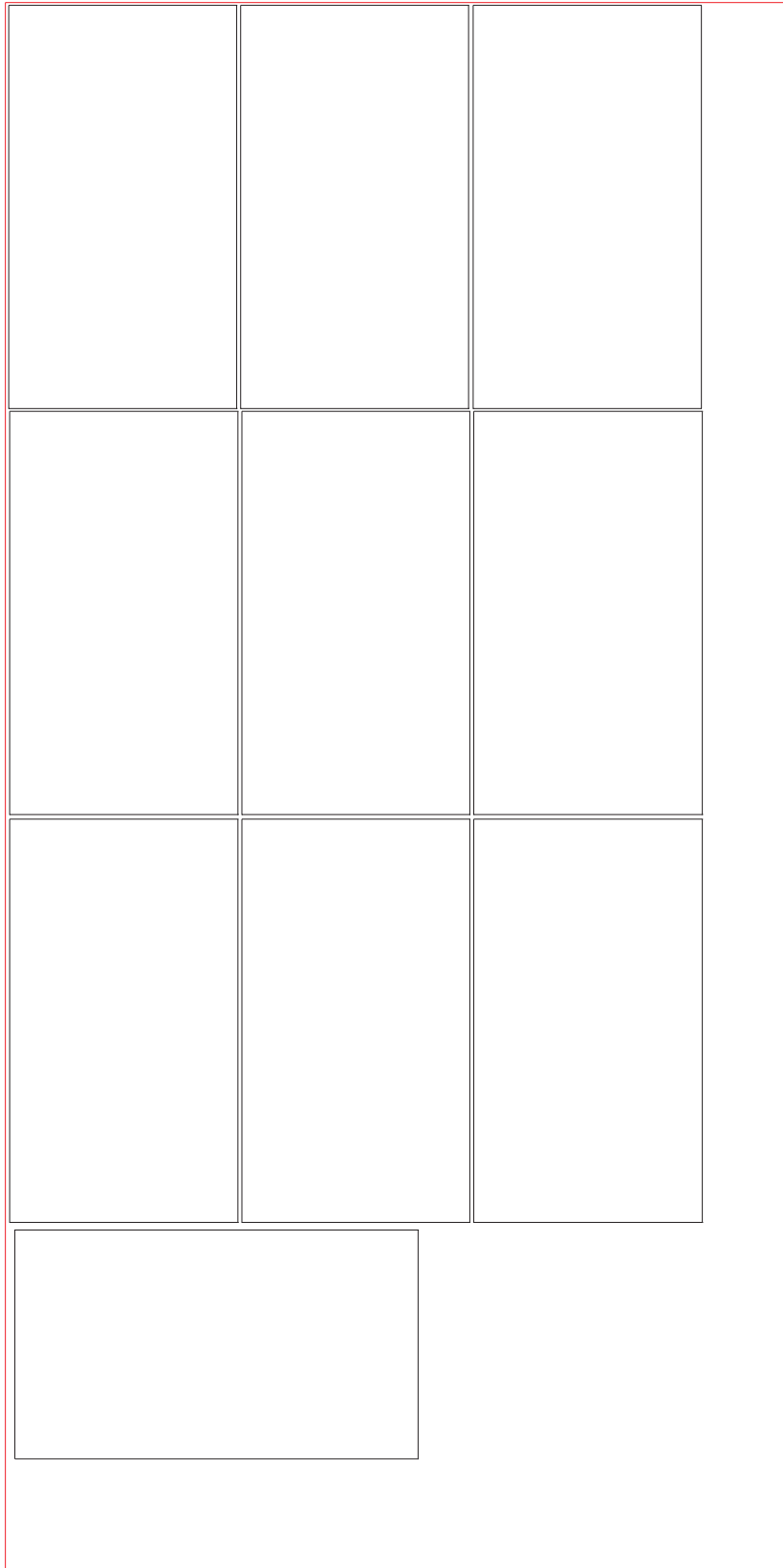

1/4" x 48" x 96" hardboard - tempered if available

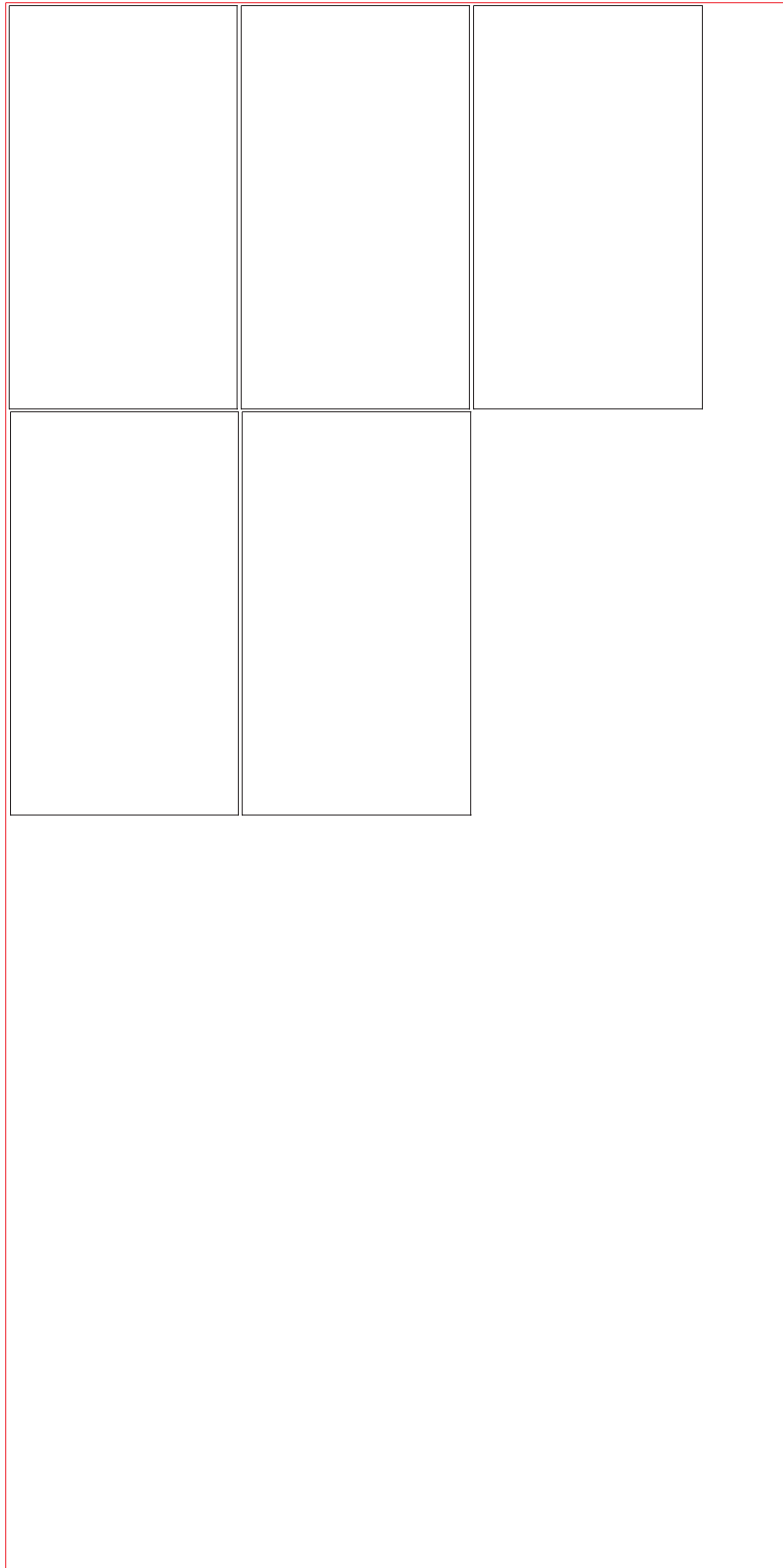

3/4" x 9" x 96" Birch hardwood - for all solid wood pieces

