

CELEBRATE TABLE  
SHEET 01

PLAN VIEW

D. REILLY JULY 2006

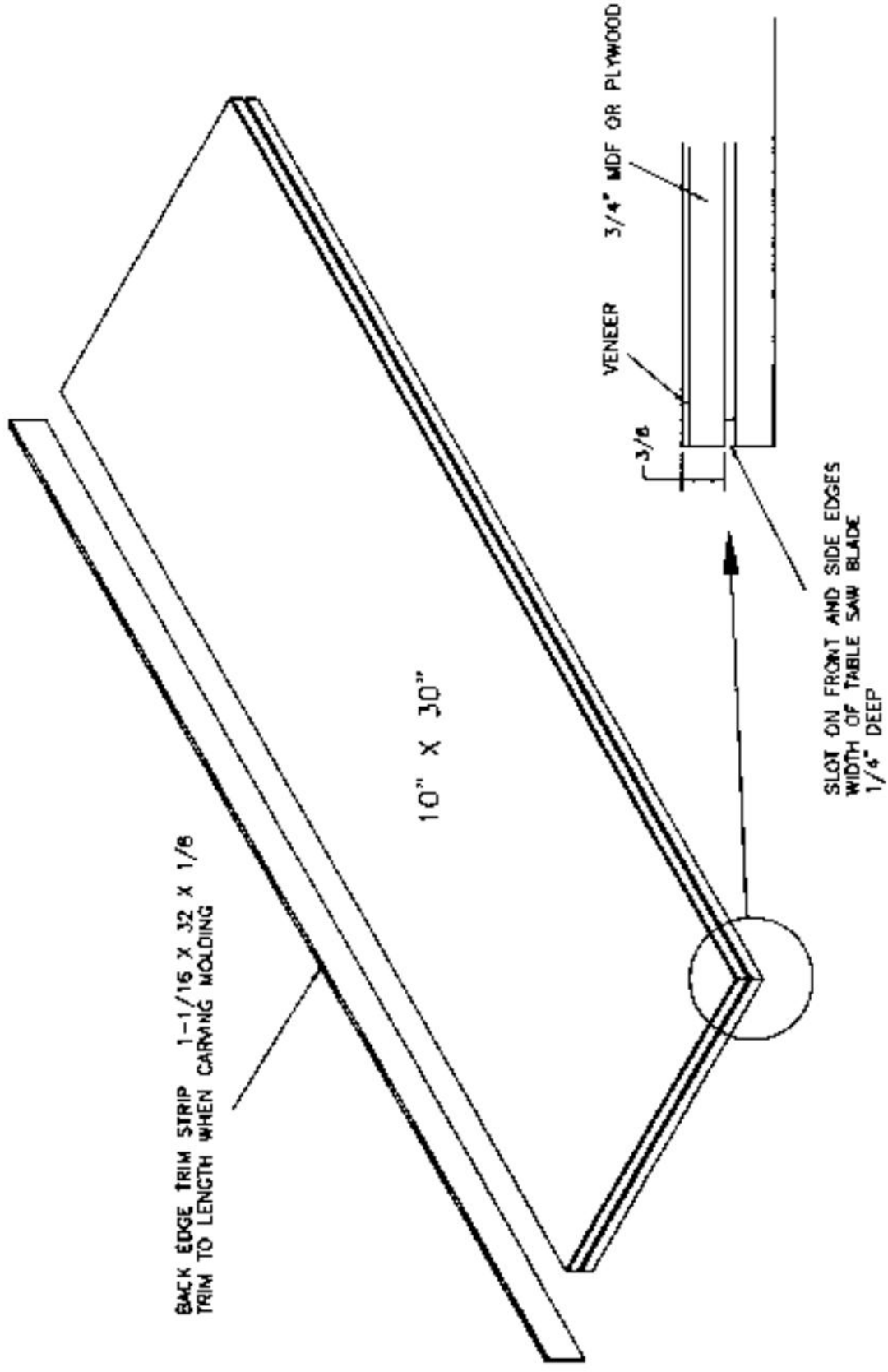

BACK EDGE TRIM STRIP 1-1/16 X 3/2 X 1/8  
TRIM TO LENGTH WHEN CARVING MOLDING

10" X 30"

3/4" MDF OR PLYWOOD  
VENEER  
3/8"

SLOT ON FRONT AND SIDE EDGES  
WIDTH OF TABLE SAW BLADE  
1/4" DEEP

CELEBRATE TABLE  
SHEET 02

TOP

D. REILLY JULY 2006

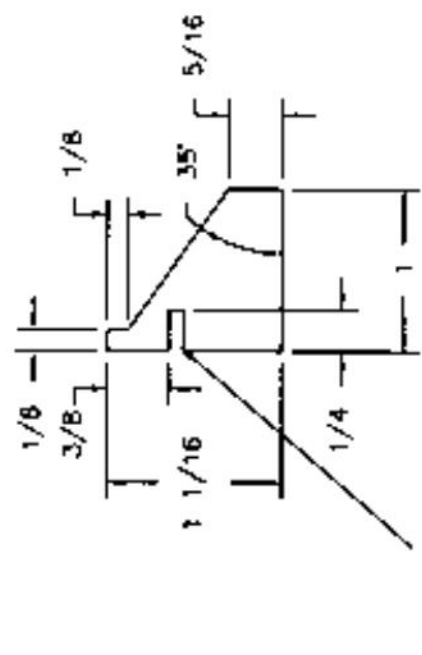

MOLDING CROSS SECTION

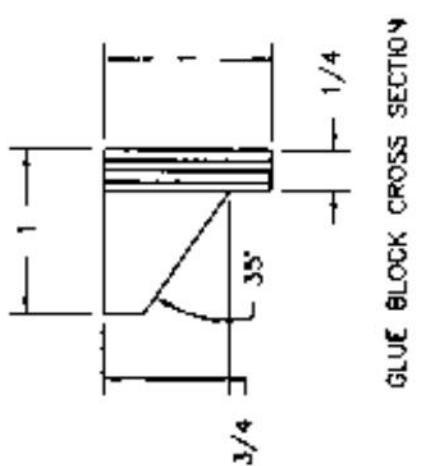

GLUE BLOCK CROSS SECTION

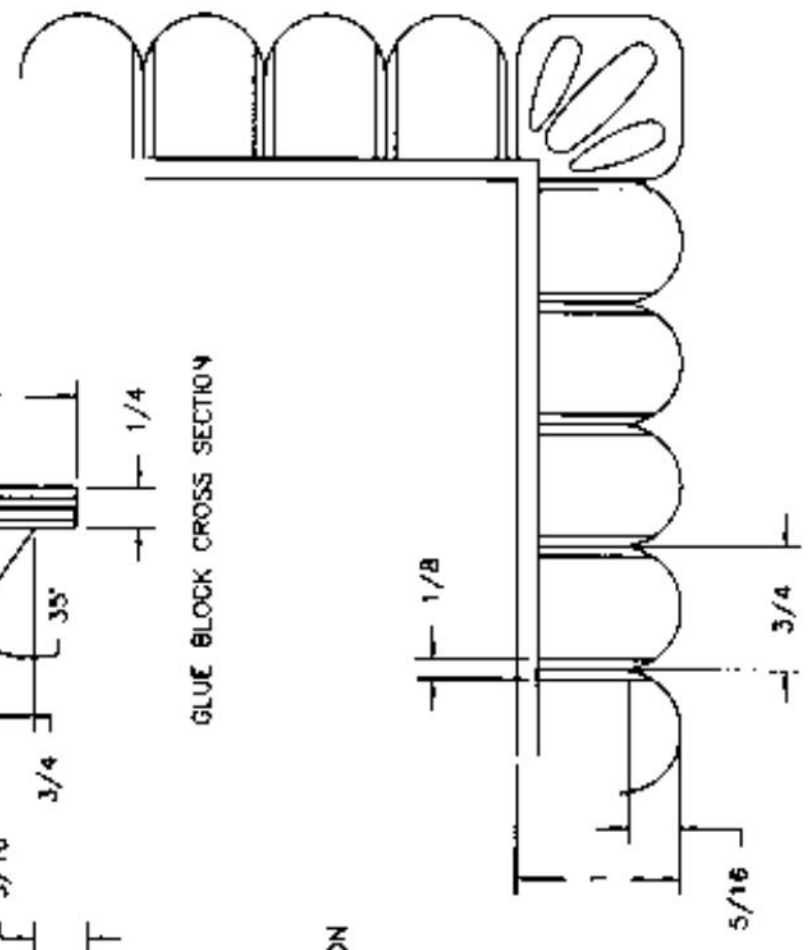

CELEBRATE TABLE  
SHEET 03  
MOLDING  
O. REILLY JULY 2006

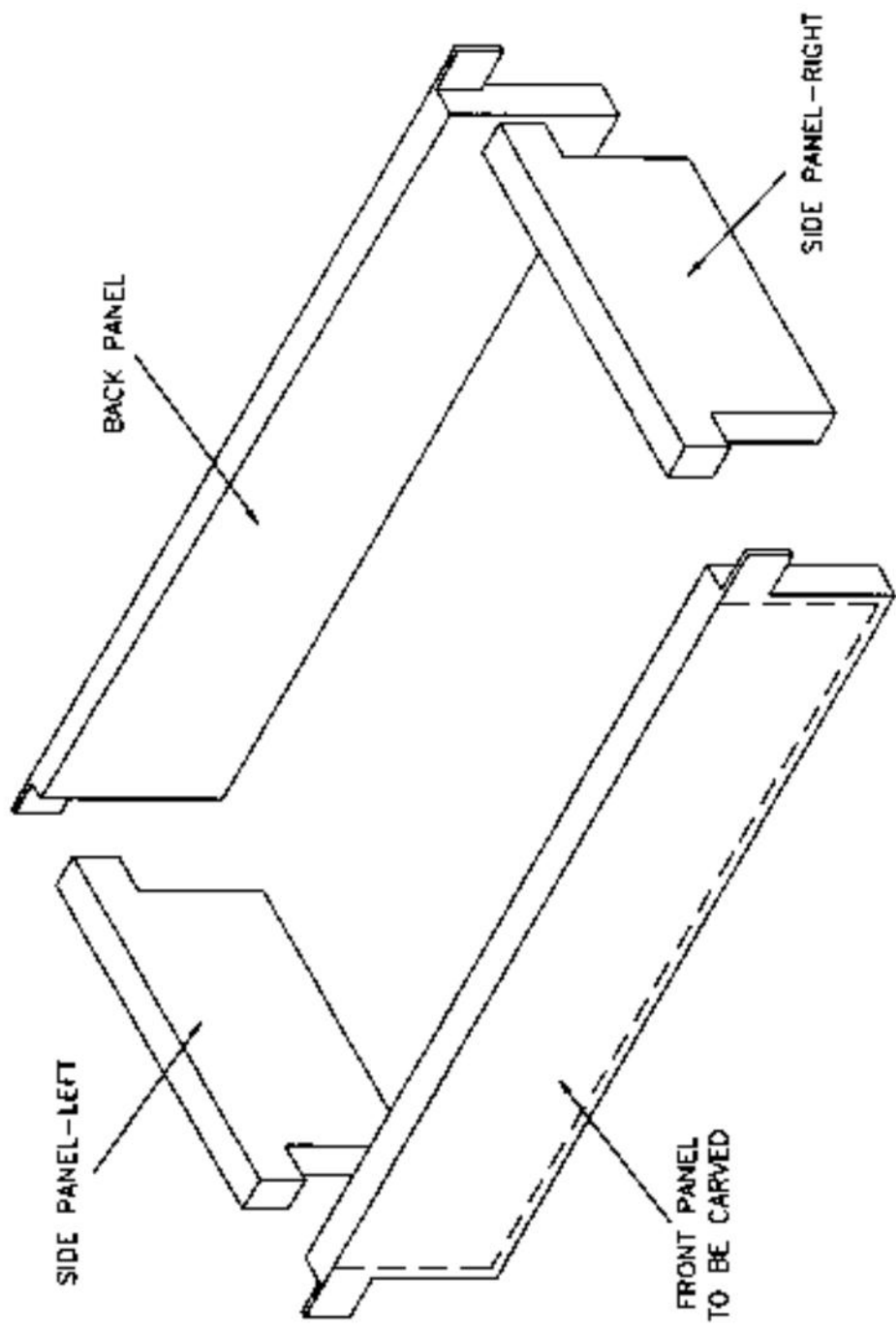

CELEBRATE TABLE  
SHEET 04

FRAME ASSEMBLY

D. REILLY JULY 2006

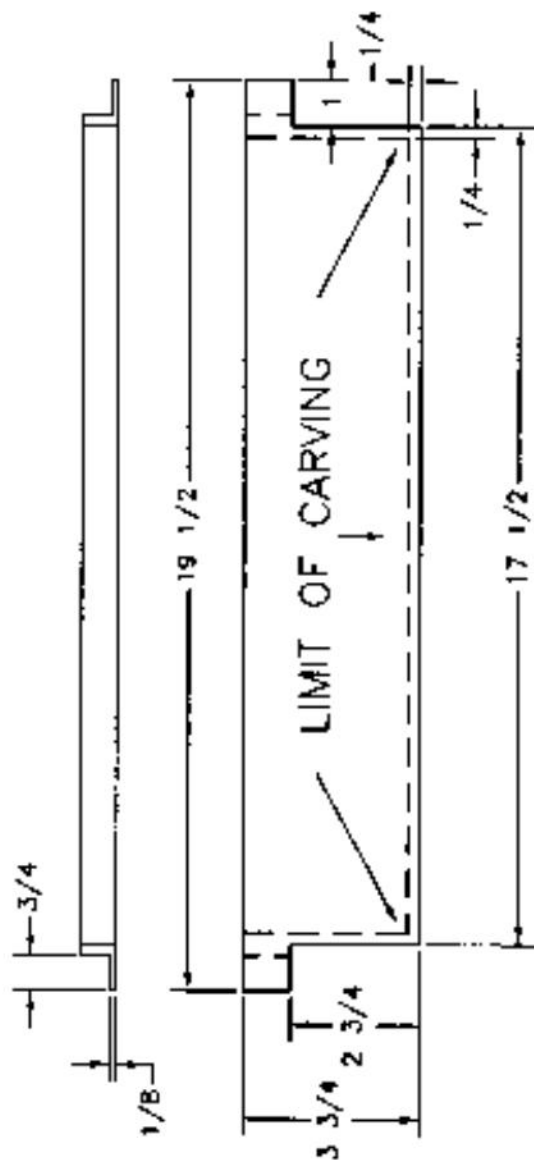
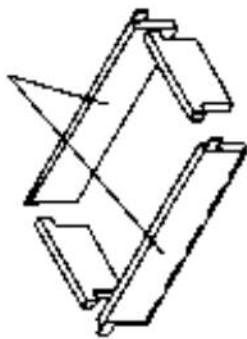

FRONT PANEL

CHARACTER

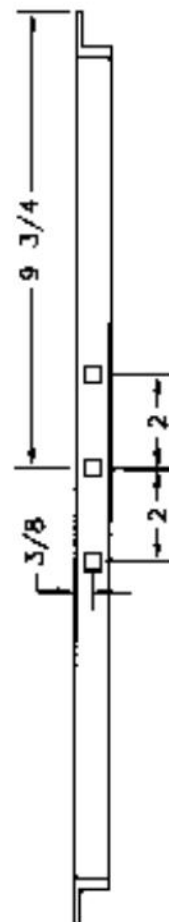
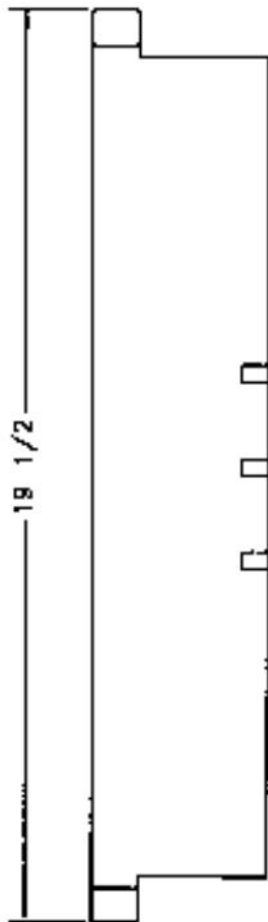

3 TENONS  
3/8 X 3/8 X 9/16 DEEP  
ON 2" CENTERS

REAR PANEL

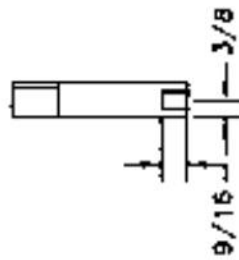

CELEBRATE TABLE  
SHEET 05  
FRONT & REAR APRONS  
D. REILLY JULY 2006

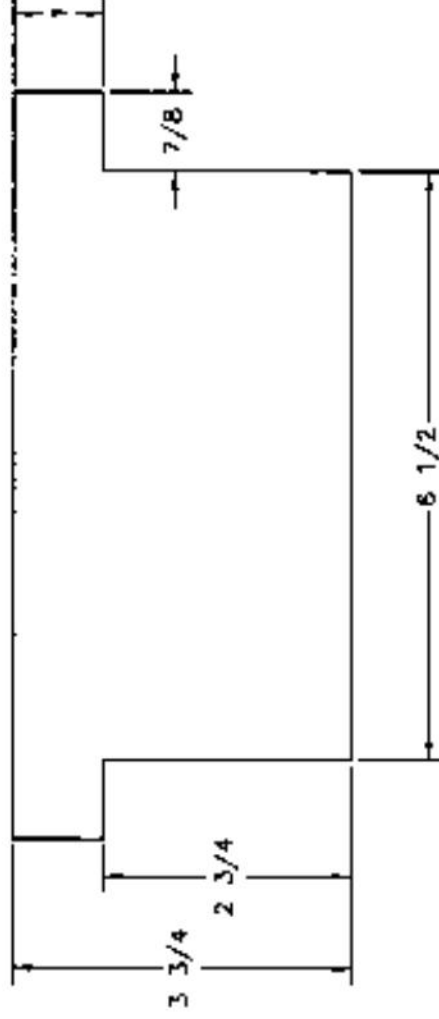
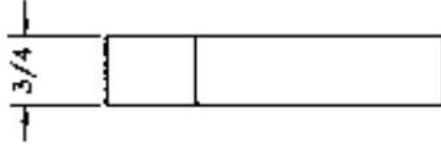
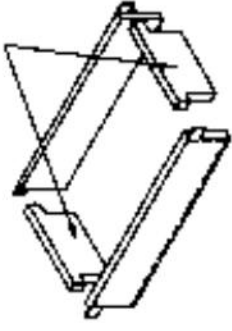

2 REQUIRED

CELEBRATE TABLE  
SHEET 06

SIDE APRONS

D. REILLY JULY 2006

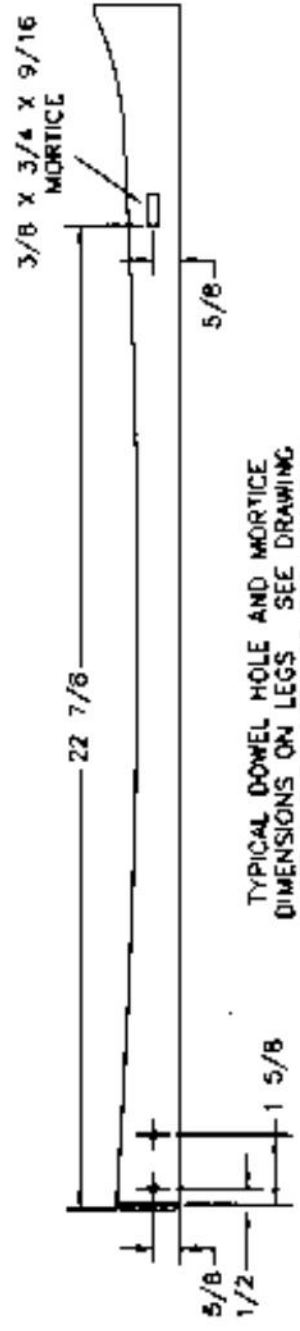
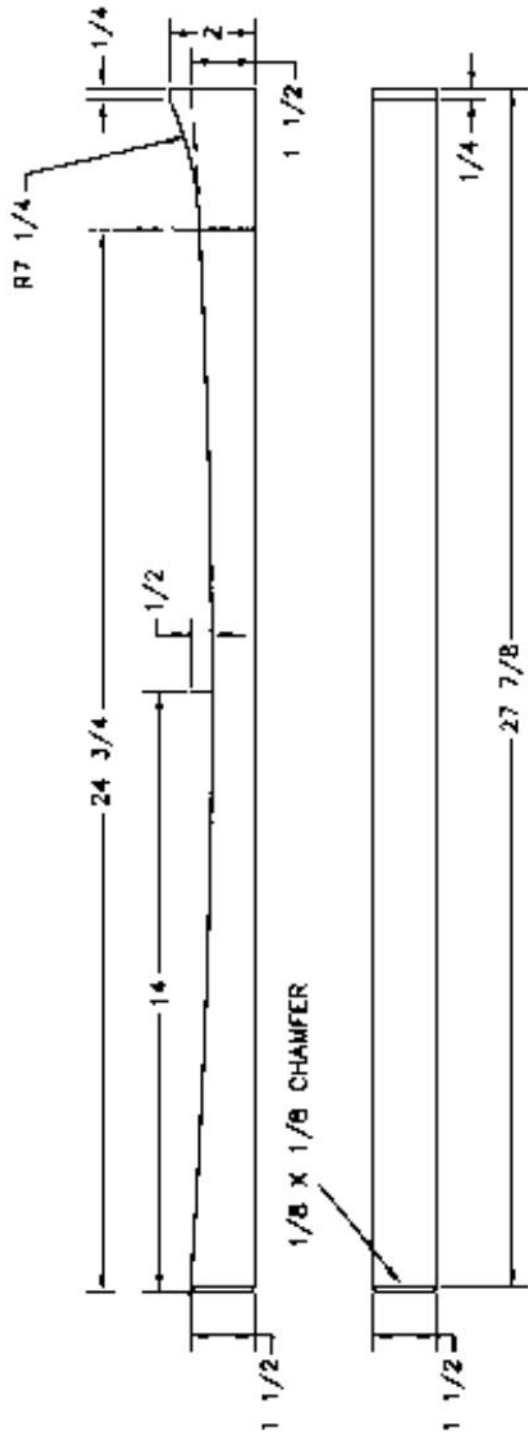

TYPICAL DOWEL HOLE AND MORTISE  
 DIMENSIONS ON LEGS. SEE DRAWING  
 SHEET 6 "LEG DETAILS" FOR LOCATION  
 ON EACH LEG.

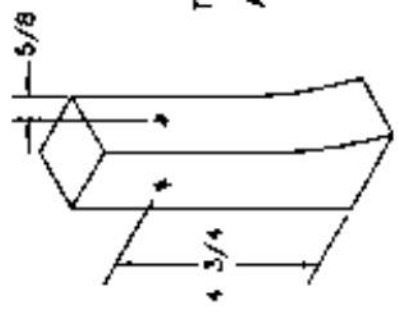

TYPICAL LOCATIONS OF PLUG  
 HOLE AT BASE OF LEGS.  
 ALL OTHER PLUGS TO PLUG  
 DOWEL HOLES.

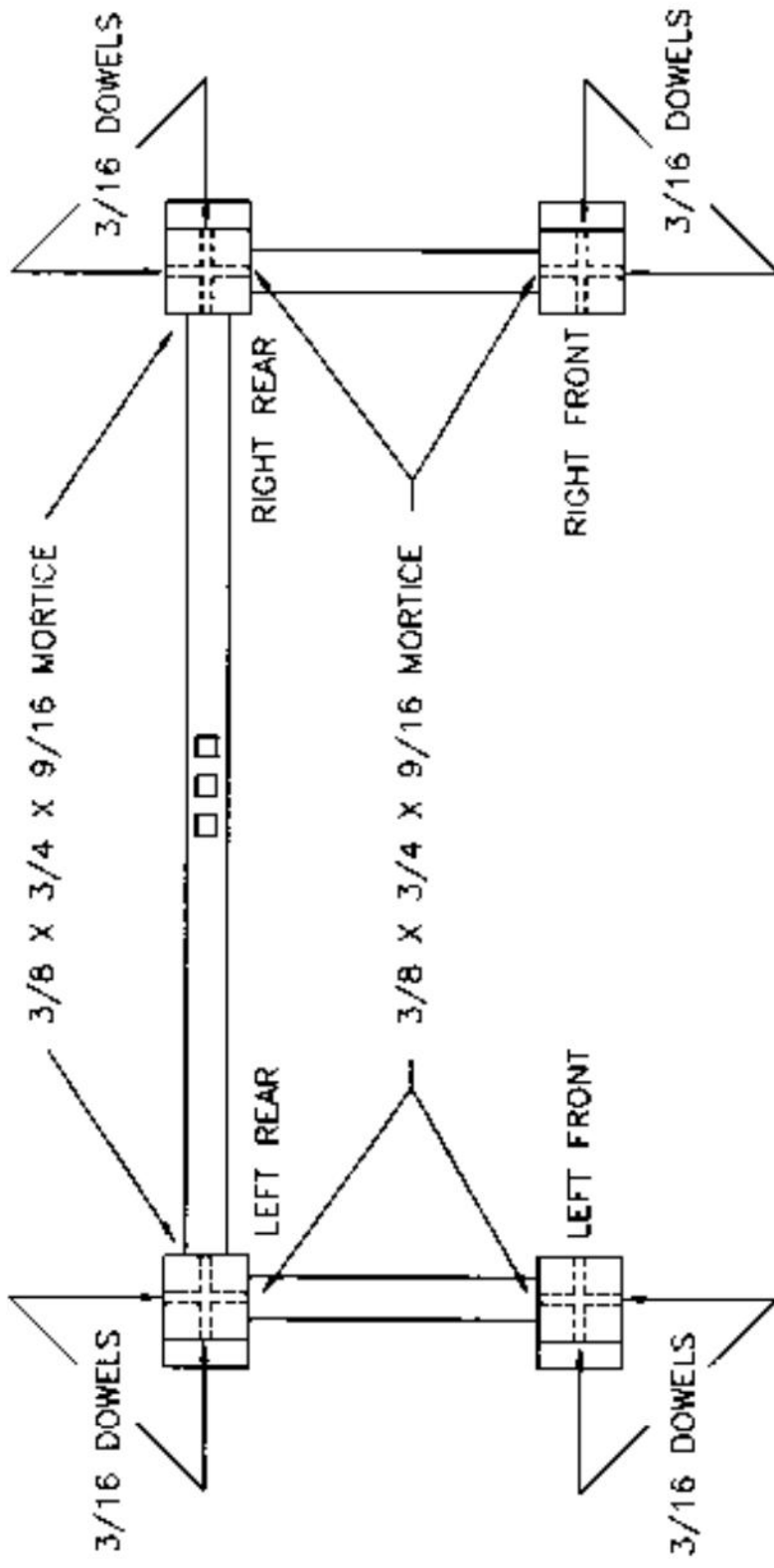

NOT TO SCALE

CELEBRATE TABLE  
SHEET 08  
LEG ASSEMBLY  
D. REILLY JULY 2006



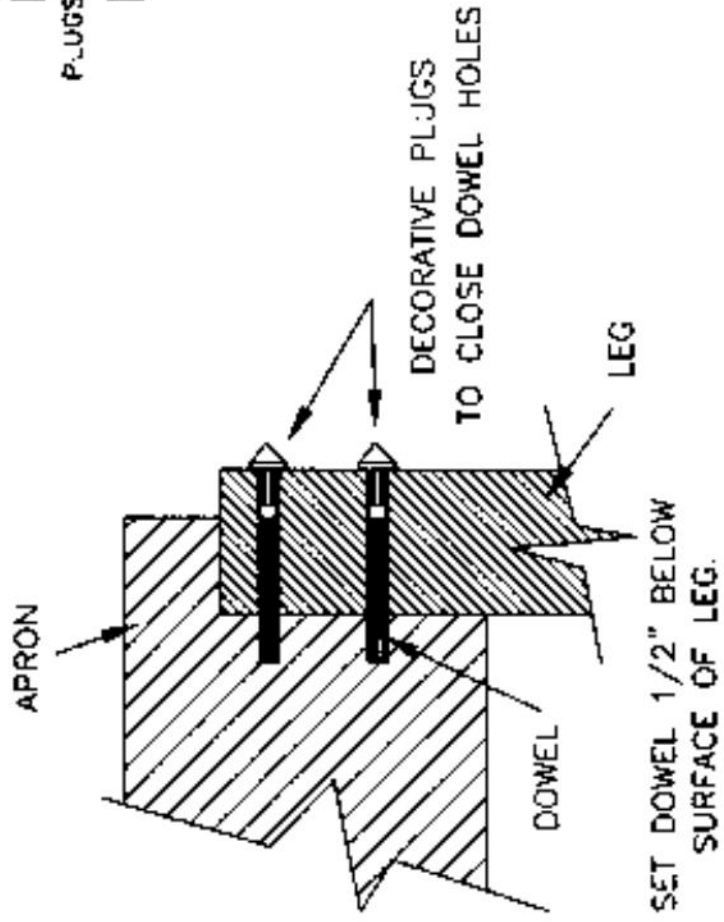
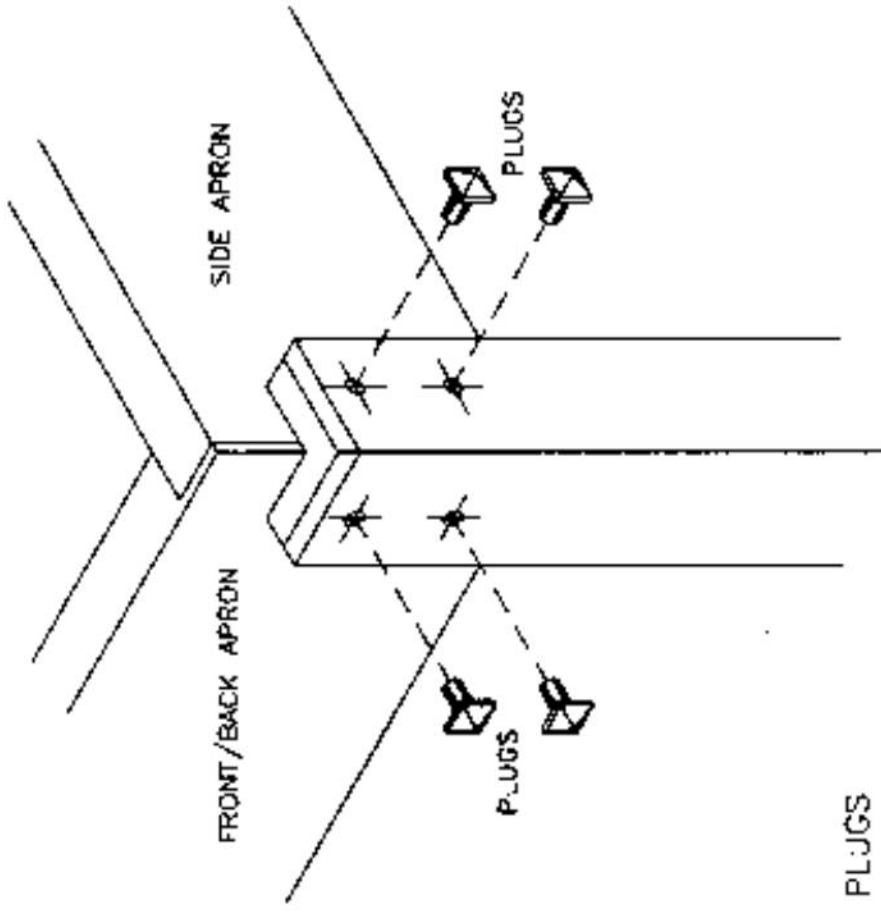

CELEBRATE TABLE  
SHEET 09

CORNER DETAIL

D. REILLY JULY 2006

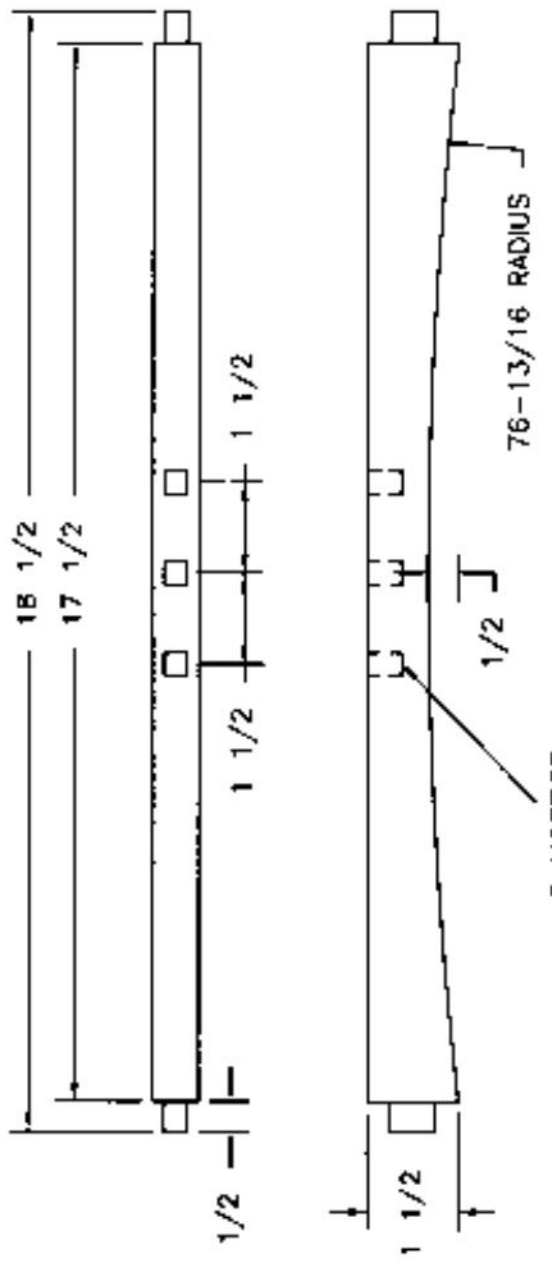

3 MORTISE  
 3/8 X 3/8 X 9/16 DEEP

REAR STRINGER  
 1 REQUIRED

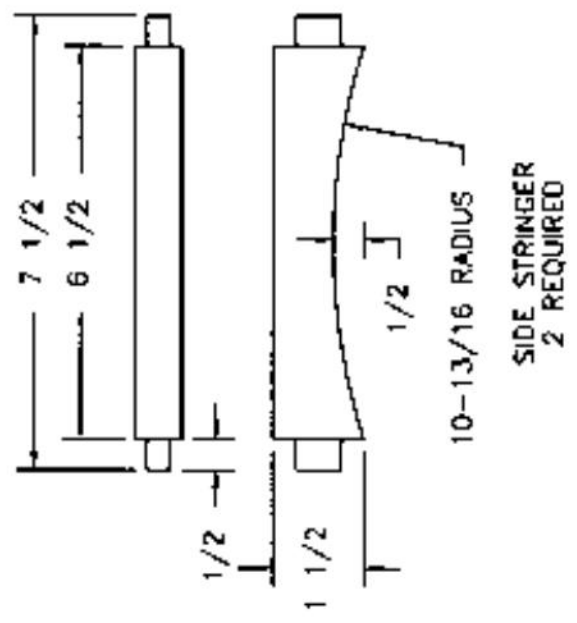

10-13/16 RADIUS  
 SIDE STRINGER  
 2 REQUIRED

CELEBRATE TABLE  
 SHEET 10  
 STRINGERS

D. REILLY JULY 2006

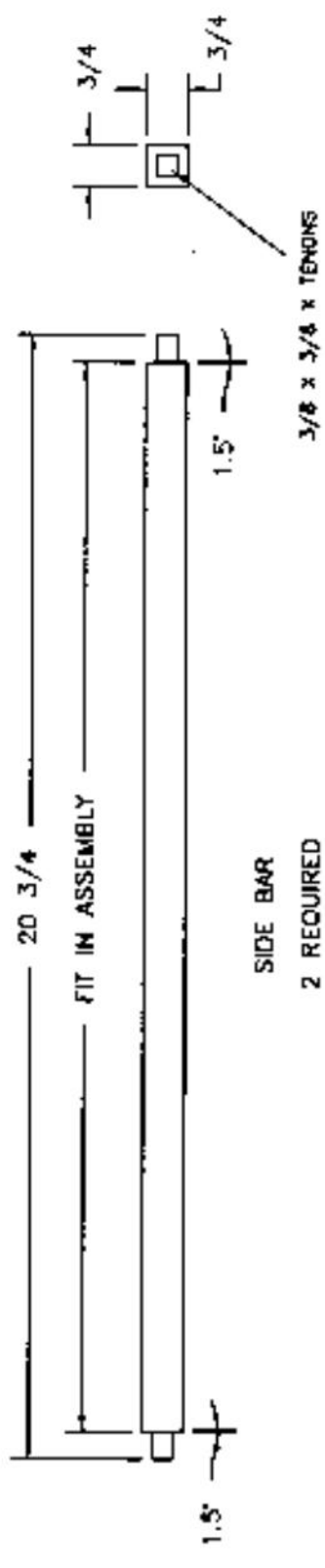
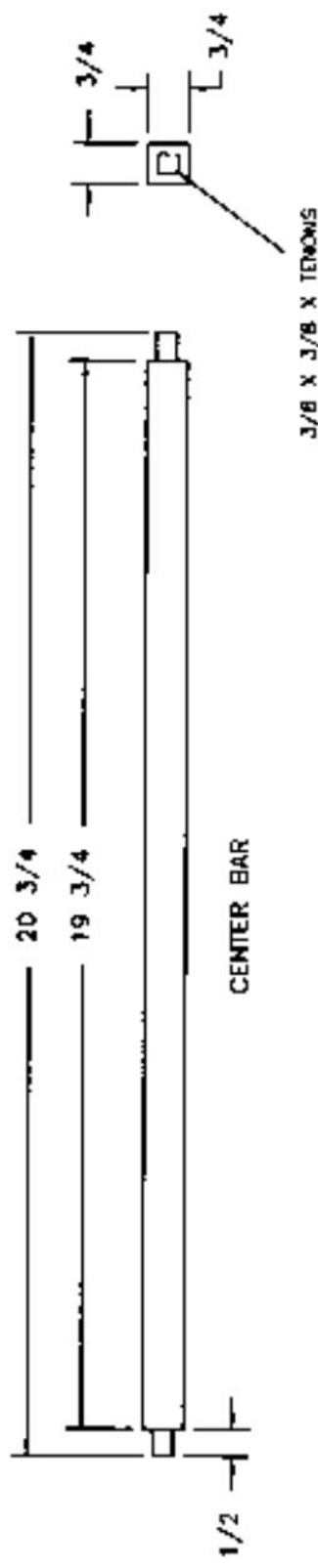

SEE SHEET 13 FOR  
1-1/2 DEGREE ANGLE GAGE

CELEBRATE TABLE  
SHEET 11

BARS

O. REILLY JULY 2006

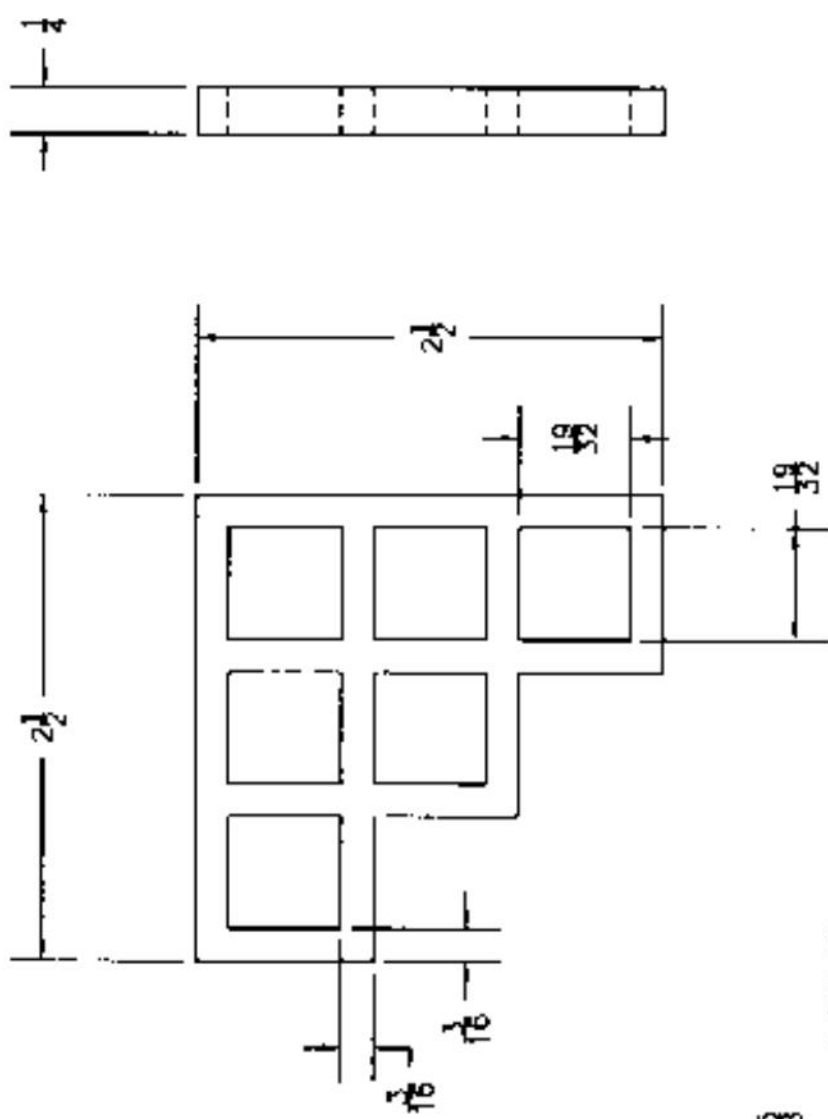

BRACKET  
6 REQUIRED

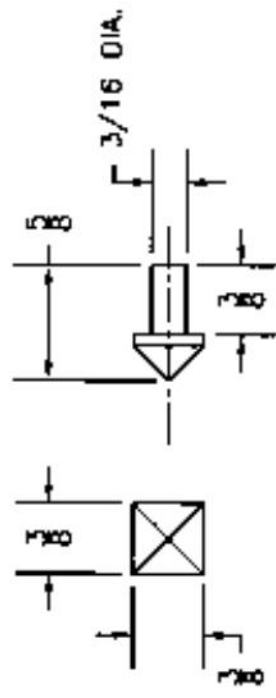

PLUG  
22 REQUIRED

CELEBRATE TABLE  
SHEET 12  
BRACKET AND PLUGS  
D. REILLY JULY 2006

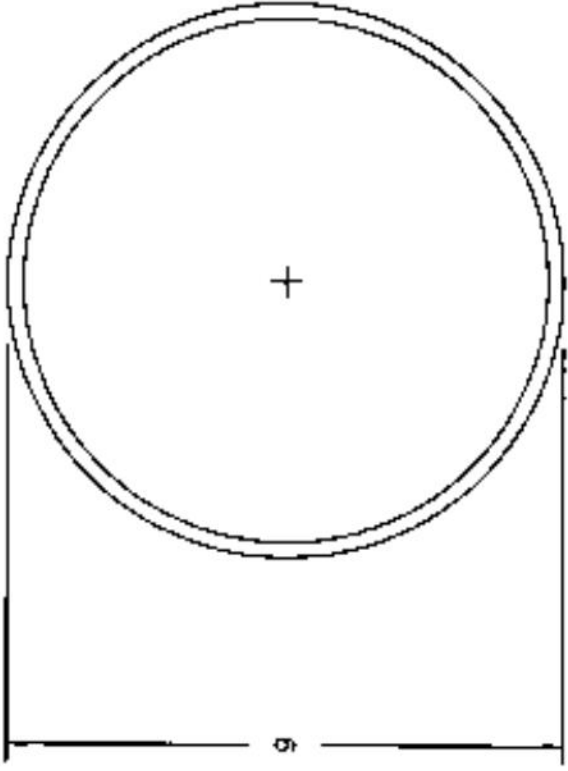
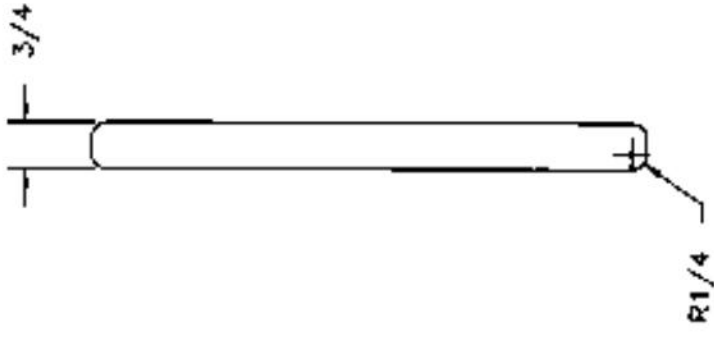

CELEBRATE TABLE  
SHEET 13

PLATE

D. REILLY JULY 2006

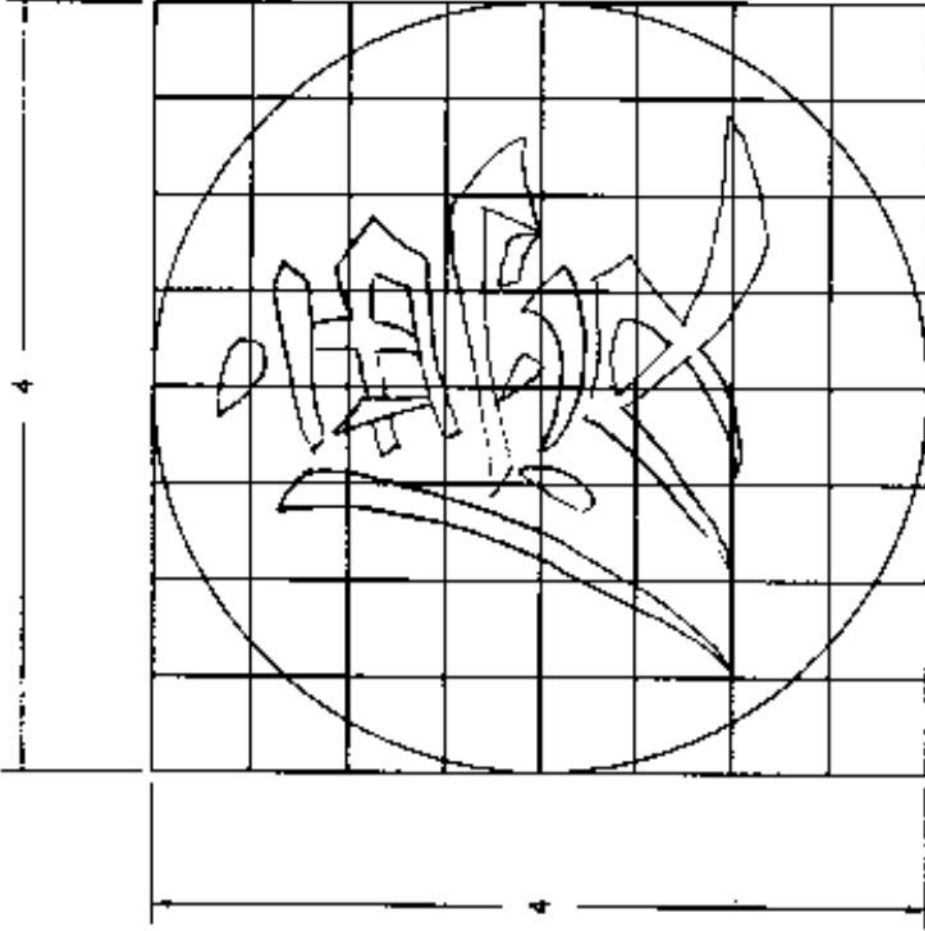

ENLARGE 2X

1/2" GRID

CELEBRATE TABLE  
SHEET 14

CELEBRATE CARVING

D. REILLY JULY 2006

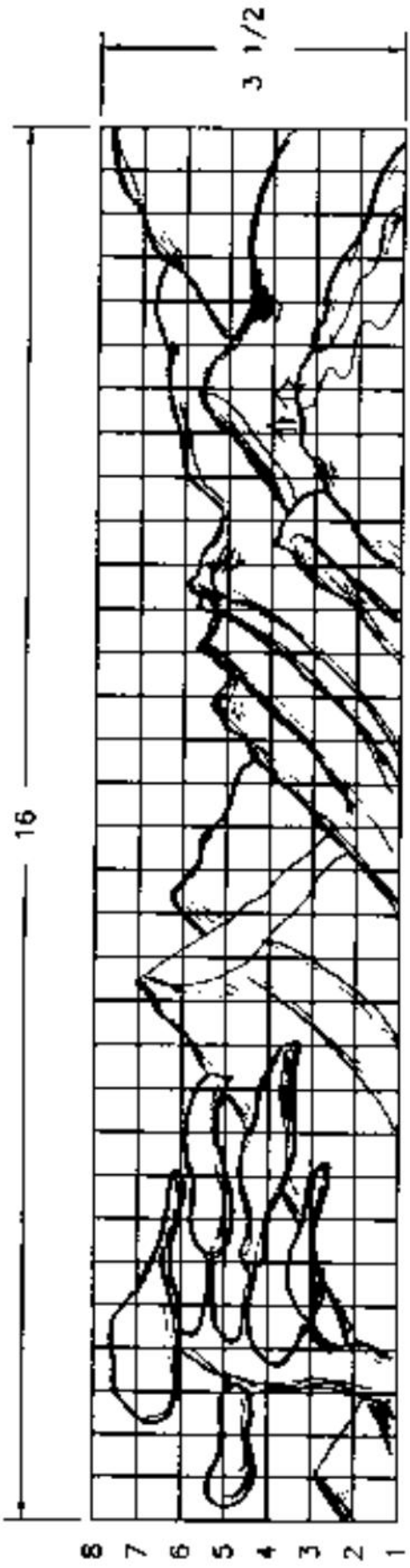

1 2 3 4 5 6 7 8 9 10 11 12 13 14 15 16 17 18 19 20 21 22 23 24 25 26 27 28 29 30 31 32 33

1/2" GRID  
ENLARGE 1.9 TIMES

CELEBRATE TABLE  
SHEET 15  
APRON CARVING  
D. REILLY JULY 2006