

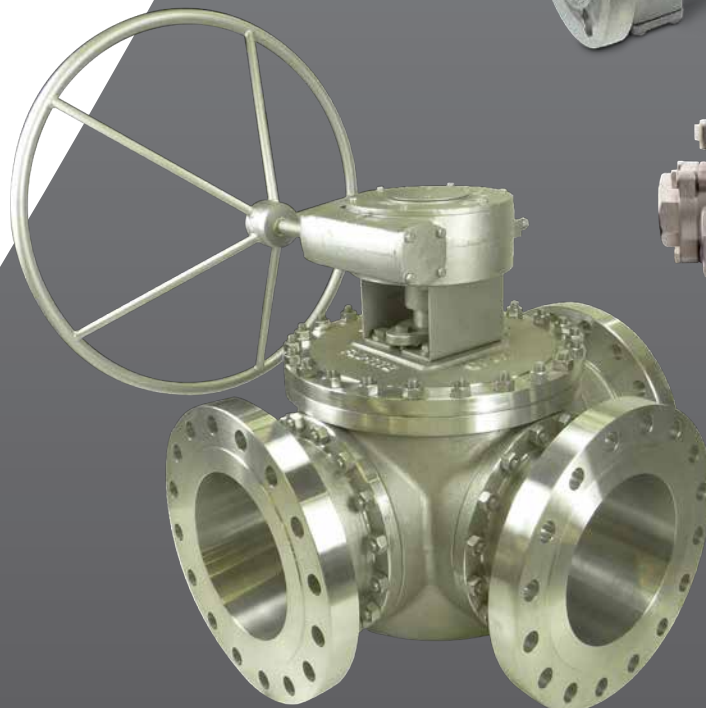

Ball Valve Selection Guide

From Simple to Complex Designs

- Electric, Pneumatic Actuators & Controls
- 3 and 4 Way Multi-Port Valves
- Pipeline Trunnion Type Valves
- Custom Designed Ball Valves
- Severe Service Metal Seats
- Segmented Control Valves
- Flush Bottom Tank Valves
- Steam Jacketed Valves
- Dribble Control Valves
- Instrumentation Valves
- V-Port Control Valves
- Special Alloy Valves
- Cavity Filled Valves
- Fusible Link Valves
- Automated Valves
- Cryogenic Valves
- PFA Lined Valves
- Sanitary Valves
- Ceramic Valves



www.flotite.com
 910.738.8904 | sales@flotite.com



Trunnion Ball Valves

TM Series

Designed and Fabricated for Pipeline Applications. Offering both forged 3-pc and cast 1 & 2 pc body designs.

Applications:

Oil and Pipeline applications and other industrial applications including:

- Natural Gas Storage
- Gas Transmission, Oil Refinery
- Dryer Service
- LNG, HRSG
- Skids
- Subsea
- Natural Gas Compressor Stations
- Desalination
- Petrochemical Plants
- CO₂ Service
- Pipeline
- Power Generation

Design Features:

- Full Compliance with API-6D
- ISO 9001, CE & NACE
- Grease Sealant Fitting Standard
- ANSI Class 150, 300, 600, 900, 1500, 2500
- High Temperature Metal Seated
- Piggable Service
- Control Ball Valve
- 3-Way Designs
- Double Block & Bleed
- Both Cast & Forged
- Optional: Fully Welded Body Designs
- Custom Designs Welcome!

Engineered Valves for Pipeline and Severe Service Applications

3-Way 10"



TB 80-19

Models:
TM150
TM300
TM600

Size Range:
1"-56"

Pressure Rating:
ANSI Class 150-2500



Segmented Control Valves

Sentinel Series

Eccentric Ball Available

Precise Control

Applications:

- Clean or Dirty Liquids
- Gases
- Fibrous Suspension Applications
- Power Generation
- Pulp and Paper

Design Features:

- ISA S75.04
- Rugged Uni-body Construction Available in Flanged or Wafer 150, 300, & 600 Lbs
- Metal or Soft Seated

Size Range:
1"-24"

Pressure Ratings:
Ansi Class 150-600
Flanged: 150, 300, 600
Wafer: 150, 300



TB 68-19-1

Models:
RV-150
RV-300
RV-600

New! Now available Eccentric Control Valve

High Performance 3-Piece Designs

Multi-Choice Series

Models: 200, 300

This series is our most versatile design. Series 200/300 ball valves are offered in Threaded, Socket Weld, Butt Weld, Flanged End, and Extended Weld Ends. The Valve center body is drilled and tapped for cap screw bolting to assure exact alignment.



Applications:

- Water Services
- Oil and Gas
- Universal Applications

Size Range: 1/4"–4"

Pressure Ratings:

- 1/4"–2 1/2" — 1500 psi WOG
- 3"–4" — 1250 psi WOG

Design Features:

- Live-loaded stem
- V-Ring stem packing
- Anti-Static grounding device
- ISO-Mount automation pad
- Safety locking handle
- Wide range of seating materials
- V-Ball Control Valves Available
- Cavity Fillers Available
- Carbon, Stainless Steel, Alloy 20 and many other Special Materials
- Secondary Media Containment
- Flush Bottom Tank



TB 45-19

ISO Mount

Multi-Choice Weld-In-Place Series

Eliminate Valve disassembly when welded ball valves are required!

Applications:

- Water Services
- Oil and Gas
- Moderate Pressure Applications
- Petrochemical Services

Design Features:

- Safer Installation
- Reduced Liability
- Save Valuable Time
- Reduce Labor Cost
- Assures Fool - Proof Installation
- Socket & Butt-Weld Design

Models:
335-SS
235-CS



Models:
325-SS
225-CS



Size Range: 1/4"–4"

Pressure Ratings:

- Size 1/4"–2 1/2" 1500 psi MAWP/WOG
- Size 3"–4" 1250 psi MAWP/WOG

TB 46-19

Tri-Pro Series

High pressure 3-Piece Series built for demanding applications.

Applications:

- Cryo
- Oil and Gas
- High Pressure Applications
- Aviation & Aerospace

Design Features:

- Fire Safe designed to API 607-7
- ANSI B16.34
- Protected seat design
- Captive seats & body seals
- Weld-In-Place socket & butt weld
- Flanged end ANSI Class and 600
- Wide range of seating materials
- Metal seats available in both class V & VI

Size Range:

Full Port

1/4"–4"

Reduced Port

1/2"–4"

Pressure Ratings:

1/4"–3/4" 3000 psi MAWP (Full Bore)

1"–4" 2250 psi MAWP/WOG (Full Bore)

1/2"–1" 3000 psi MAWP/WOG (Reduced Bore)

1 1/4"–4" 2250 psi MAWP/WOG (Reduced Bore)



ISO Mount

Models:
HPF50-SS
HPF40-CS

TB 51-19

High Performance 3-Piece Designs

Pro-Max Series

Applications:

- Water Services
- Petrochemical
- Oil and Gas
- Food Services
- Heat Exchange
- Power Generation
- Universal Applications

Design Features:

- Flo-Tite Economical 3-pc valve
- Reduced port
- Available with NPT or Socket Weld Ends
- 2000/1500 psi WOG
- RPTFE Seats
- Enclosed Bolting
- ISO 5211 Mounting Pad
- Safety Locking Handle
- CE Compliance
- Fire Safe Certified
- NACE

Size Range:

1/2"-2"

Pressure Ratings:

1/2"-1 1/4" 2000 psi WOG / 150 psi WSP

1 1/2"-2" 1500 psi WOG / 150 psi WSP

Model:
360



TB 48-19

Titan Series

Applications:

- Extreme Pressure Applications
- Power Generation
- Water Services
- Petrochemical

Design Features:

- ANSI Class 900 & 1500 Raised Face
- RTJ Flange available (not standard)
- 5000 psi WOG
- V-Port Control Option
- Devlon Seats Standard
- Peak & Metal Seat Options
- Fire Safe API 607-7, API 608

Model:
1552

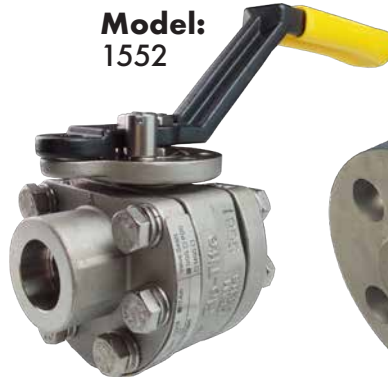

TB 53-18

Model:
1558



Size Range:
1/2"-2"

Pressure Rating:
5000 psi WOG

Direct Connect Series

Save Time & Money mounting Actuators directly to the Valves.

Applications:

- Universal Applications
- Low Pressure Steam Applications
- Space Saving
- Water Treatment & Processing

Design Features:

- ISO-5211 Top Works - Live-Loaded Stem
- 2-pc body 1000 PSI WOG- (DM85 & DM-V60)
- 2-pc body 2000 PSI WOG Fire Safe Design - (DM2000 & DMV2000)
- 2-pc Flanged End (DM F15)
- 3-pc body 1000 PSI WOG (DM100 & DM300 series)
- 3-Way 1000 PSI WOG (DM MPT100)
- Wafer ANSI 150 LB (DM WF150)

Other Direct Connect Products:

- **DM 85** TB 34-19
- **DM 300** TB 35-18
- **DM 15** TB 36-18
- **DM-V60** TB 37-18
- **DM2000** TB 38-18
- **DM MPT 100** TB 102-19

Model:
DMW150



TB 38-18

Size Range:
1/2"-3"

Pressure Rating:
2000 psi WOG/150 psi WSP

Flanged End Ball Valves

Full-Flo Series

Full Bore

- Oil & Gas Sector
- Chemical Manufacturing & Processing
- Petrochemical Industry

Design Features:

- ISO 5211 Mounting pad
- Safety locking handle
- Anti-Static grounding device
- ANSI Class 150, 300, 600
- Special Metal Seats meeting Class V & VI
- Cavity Fillers sizes 1/2" – 14"
- Fugitive Emissions certified per ISO 15848-1
- V-Ball Control Valves
- Fire Safe per API 607 (all valves) & API 6FA (on selected models)
- NACE compliance available as option
- API 6D logo



EC Series

Model:

TB 66-18

F15

Size Range:
2"–6"

Pressure Ratings:
F15 ANSI 150
F30 ANSI 300

Uni-Flo Series

Standard Bore

Applications:

- Power Generation
- Pulp & Paper Production Industry
- Cryo



Petro Series

TB 69-18

Model:

F60



EZ Series

TB 58-20

Model:

RF-15/RF-150

Size Range:
3"–14"

Pressure Rating:
ANSI 150

Model:

RF-30

Size Range:
3"–6"

Pressure Rating:
ANSI 300

ISO Mount

Full Bore & Reduced Bore

API 6D Certified Floating Ball Valves



Uni-Flo TB 58-20

Models:

SF150/SF300



Full-Flo

Models:

F150/F300

Size Range:

Full Bore
1/2"–12"

Standard Bore
1"–12"

Pressure Ratings:

F150/SF150 ANSI 150
F300/SF300 ANSI 300
All 150 PSI SWP
(300 PSI SWP Optional)

Media Containment

Multi-Purpose Secondary Containment

- Help maintain ultra-low fugitive emissions
- Maintenance Repair
- High Temperature Applications
- **Upgrade standard Ball Valves with a simple low cost device**



Award Winning Product

Certified ISO 15848-1:2015
Methane Fugitive Emission Testing



TB 140-19

Multi-Port 3&4 Way Ball Valves

Trans-Flo Series

ISO Actuator Mount

Flo-Tite offers a wide selection of multi-port ball valves designed to simplify piping systems, eliminating the need for two or more standard valves. The valve has either one or two pc ball/ stem with a trunnion type Ball Support. T, L, or LL Flow Plans.

Applications:

- Oil and Gas
- Lact Skids
- Heat Exchange Applications
- Water Services

MODELS AVAILABLES:

- MPF15 - ANSI 150 LB Flanged Ends
- MPF30 - ANSI 300 LB Flanged Ends
- MPF60 - ANSI 600 LB Flanged Ends
- MPT30 - ANSI 300 PSI Threaded Ends
- MPC15 - ANSI 150 TRI-Clamp Ends
- MPF154 - ANSI 150 LB Flanged 4-Way Valves

Sizes:

- 3/4" - 14"



Model:
MPF154
4-Way

TB 90-19



**120° 3-Way
Ball Valve**



Model:
MPF15
3-Way

TB 90-19

Ball Porting

Flow Plans:

T-Pattern L-Pattern LL-Pattern In-Line Pattern



3-Way Trunnion Designs also Available



MPT-100 Series

Applications:

- Mixing & Blending Services
- Flow & Bypass
- Diversion Operations
- Beverage & Food Industry
- Water Treatment & Processing
- Chemical Production

Design Features:

- Stainless
- 3-Way Diverting or Mixing
- Standard port design
- Threaded ends/Tri-Clamp
- Optional Brass T + L ports model #355/365

Size Range:

1/4" - 2"

Pressure Rating:

800 psi MAWP/WOG

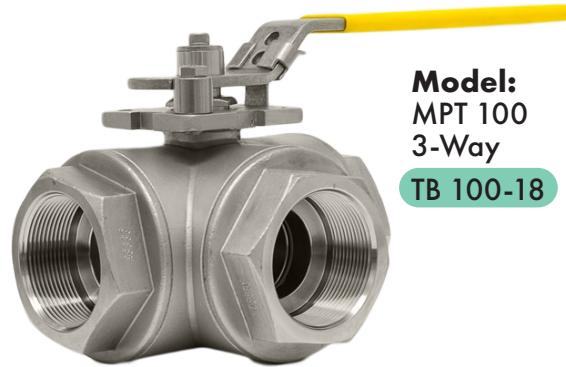

Model:
MPT 100
3-Way

TB 100-18

3 & 4-Way

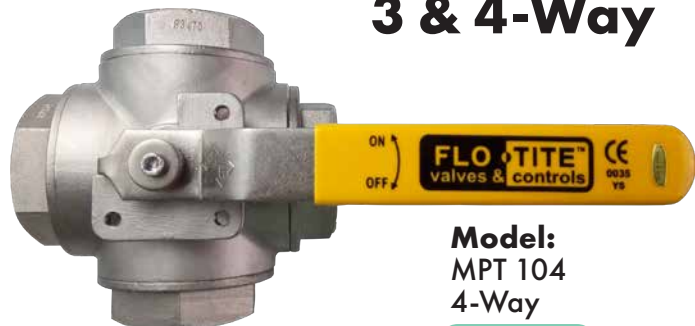

Model:
MPT 104
4-Way

TB 100-18

Multi-Port 3&4 Way Ball Valves

Tri-Pro Bottom Flow Series

Applications:

- Oil & Gas
- Lact Skids
- Diversion of Process Fluid
- Heat Exchange
- Water Services
- Power Generation
- Aviation & Aerospace

Design Features:

- 3-Way diverter design
- 1500 psi WOG fire safe type
- Threaded/SW/BW/Flanged

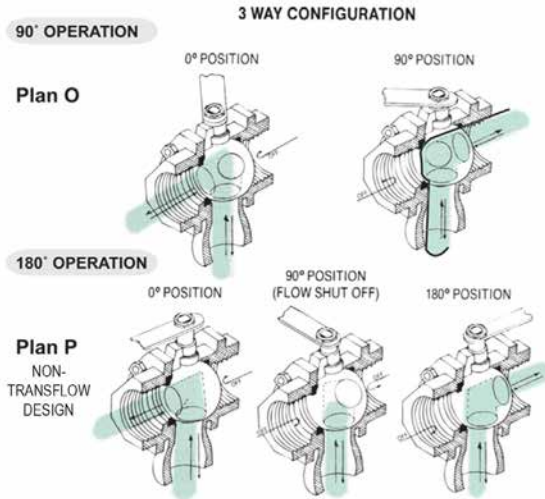

Optional T-Port Plans
Available Consult Factory



Model:
3W-HPF

Size Range:

1/2"–2 1/2"

Pressure Range:

1500 psi MAWP/WOG

Fire-Safe

TB 98-18

Bottom Entry Series

Applications:

- HVAC Services
- Sanitation & Waste Processing
- Medical & Pharmaceutical Services
- Water Supply & Distribution
- Chemical Manufacturing & Processing

Design Features:

- 3-Way diverter design

Size Range:

2"–6"

Pressure Rating:

Class 150/300



Model:
MPF-155

TB 96-18

**Many Different Flow Plans Are Available.
Ideal replacement for Plug Valves.**

Unique Application Ball Valves

Cryogenic Design Ball Valves

Applications:

- Low temperature services with temperatures below freezing down to -450°F
- Gases including:
 - » Oxygen
 - » Nitrogen
 - » Hydrogen
 - » Fluorine
 - » Helium
 - » Methane
- Chilling & Freezing Applications Food Industry
- Biotechnology & Medical Industry
- Aerospace Industry
- Alloy Treatment Service
- Petrochemical Industry

Design Features:

- Available Cryo Bonnet Tall Stems
- One Piece High Strength Stems
- Encapsulated body seals prevent "cold flow"

Size Range:

1/4"-12"

Pressure Rating:

2000 psi MAWP/WOG



Model:
F150 Cryo
TB 138-19



Tri-Pro HPF with
Cryogenic Stem
Extension

Flo-Tite offers a
complete line of
Cryogenic Ball
Valves.



SuperAlloys & Ceramic Valves Available



Zirconium
Gate Valve



Titanium Knife
Gate Valve



Inconel
Butterfly Valve



Nickel Alloy
Gate Valve



Hastelloy
Ball Valve



Ceramic
Ball Valve

Flush Bottom Tank Valves

The valve tank pad is welded flush to the tank bottom for unrestricted drainage of tank media. Available with threaded, SW, BW, and flanged ends ANSI 150/300 Lb.

Design Features:

- Tank pad 316L-SS

Perfect Adaptor between the tank & the valve body.
Minimizes the dead space between the valve ball and the tank.

Size Range:

1"-8"

Pressure Ratings:

1"-2" 1500 WOG

3"-4" 1250 WOG

6"-8" 740 WOG



Model:
TK300

TB 142-18

Unique Application Ball Valves

Safety Exhaust 3 pc Valve

Offers downstream air pressure, "blow-down" design valve with complete serviceability without disturbing the piping system.

Design Features:

- Tank pad 316L-SS
- SW/BW/NPT/150RF Flanged

Size Range:
1/4"–18"

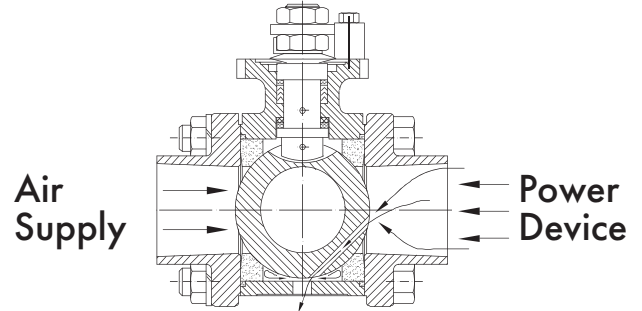

Spring Return Handle

Deadman Handle

Model:

SRH-05
SRH-07
(Just the handle)

Size Range:

1/2"–2"

Pressure Rating:

1000 psi MAWP/WOG

Model:

SRH-05
Requires a Bracket



TB 145-18



Model:

SR75-SS
(Valve with Handle)

Valve Can Never be Left in the Wrong Position.

Multi-Choice Sanitary Designs

High Purity Series

Applications:

- Food Services
- Medical Services
- Pharmaceutical Services
- Water Services

Design Features:

- 3 pc Sanitary Ball Valves with True Tube Bore
- Clean-In-Place, Purge Ports
- 20-25 RA standard
- Electropolish, Solution Clean & Bagged, Optional
- All Wetted Parts SS316L
- Cavity Fillers Available
- In-Line Orbital Welding

Size Range:

1/2"–4"

Pressure Ratings:

1000 psi MAWP/WOG
150 psi WSP

ISO Mount

Model:

S370-SL



Model:
S350-SL

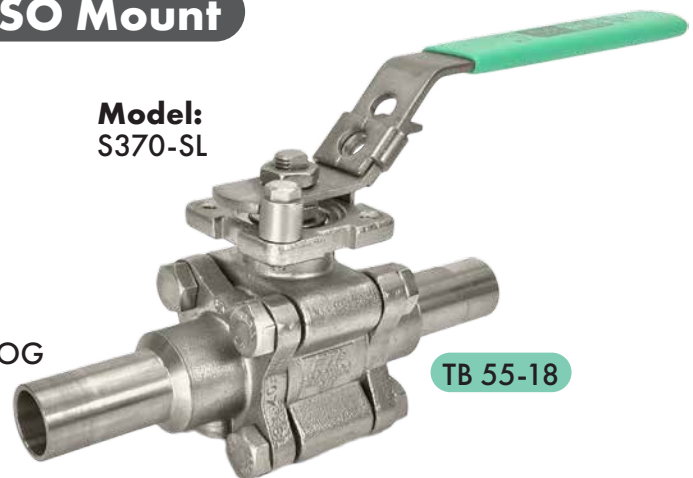

TB 55-18



Industrial Process Threaded End Designs

Fusion Series

- **Model:** S23 1 pc Seal Welded Body
- **Model:** T23 2 pc Body

Design Features:

- The S23 series seal-welded high pressure valves incorporate safety. All welded body assures that the 2 pc body can never be separated.
- Anti-Static, Fire Safe, API 608, Steam Seals, Locking Handle.
- ISO 5211 Actuator Mounting
- Outstanding performance in Steam service

Size Range:

1/4"–4"

Pressure Ratings:

1/4"–2" 2000 psi WOG/250 psi WSP

2 1/2"–4" 1500 psi WOG/250 psi WSP



Model:

T23
2 pc Body



Model:

S23
1 pc Body

TB 14-19

Flotron and Flotron II Series

Applications:

- High pressure shut off Valves
- Petrochemical
- Hydraulic Services

Design Features:

- Rugged Construction - Cast Body
- Seal Welded Body
- Fire Safe Designed to API 607-4
- Anti-Static Grounding
- Blow-Out Proof Stem Design
- Lockable Handles

Size Range:

1/4"–3"

(2" is not Full Bore)

Pressure Rating:

3000 psi WOG (Flotron Series S3000/T3000)

6000 psi WOG (Flotron II Series S6000)



Model:

Flotron
S3000
Seal Weld (1 pc)

TB 16-18



Model:

Flotron II
T3000
Full Port (2 pc)

TB 17-18

OMNI Series

Applications:

- High Pressure Shut Off
- Low Pressure Steam Applications
- Food Industry
- Energy Generation

Design Features:

- 25% Carbon/PTFE Seats
- Outstanding Low Cost/High Pressure Valve
- Fire Safe Certified API 607-4
- Double Reduced Bore Fire Safe Certified
- 316SS and Carbon Steel
- Economical Solution
- 1 pc Body Design

Size Range:

1/2"–2"

Pressure Ratings:

2000 psi MAWP/WOG

175 psi SWP



Model:

T12

TB 23-19

Industrial Process Threaded End Designs

Econo-Groove Series

Applications:

- HVAC
- Plumbing
- Mining
- Waste Water
- Oil Field
- Power Plants
- Military

Design Features:

- 3 pc Body Design
- All Stainless Steel Design
- Full Port Design
- Easy Maintenance
- Blow-Out Proof Stem
- AWWA C-606 grooved ends

Size Range:

1½"–6"

Pressure Rating:

1000 psi MAWP/WOG

ISO Mount

Model:

390



Model:

190SS

TB 56-19

Kompact Series

Applications:

- Skids
- Applications where space is restricted
- Aviation & Aerospace
- Paper & Pulp Services

Design Features:

- Full Port
- Full Flanged Wafer
- Compact Design
- Cavity Filled
- Steam Jacket
- V-Port Control

ISO Mount

ISO 5211

Direct Connect Design

Size Range:

¼"–6"

Pressure Rating:

Class ANSI 150

Model:

DM-W150



TB 111-19

Max-Gear Manual Gear Operators

Designed to be used with quarter turn Butterfly Valves, Plug Valves, and Dampers requiring a Self-Locking Mechanism.

Torque Range 2832 in-lbs through 37173 in-lbs



Design Features:

- Long Life Reliability
- Epoxy Coated Housing
- External Fully Adjustable End Stops
- Weather Proof Housing
- Rugged Compact Heavy Duty Construction

Options:

- Star Drive
- Locking Device
- Special Coatings
- Flow Plan Indicators for Multi-Port Valves
- Chain Wheel Operators
- Adjustable Memory Stops in Open Position 45°–90°

Replaceable Drive Insert Design:

Standard gears are fitted with square drive insert or double D, but a variety of other inserts such as key way are also available. Inserts can be easily replaced or remachined as needed.

Model	Gear Ratio	Torque In-Lbs	Weight Lbs
GO-4.5.6	28:1	2832	11
GO-8.10	41:1	4425	18
GO-12.14	46:1	12391	35
GO-16.18	49:1	22127	57
GO-20	129:1	26552	84
GO-24	158:1	37173	90



TB 151-19

V-Ball Control Valves

V-Port Control Series

Most of Flo-Tite's High Performance standard ball valves are now available with custom designed V-Cut options such as:

15°, 30°, 60°, 90°, and 120°

Applications:

- Higher Flow Capacities
- Bubble Tight Shut Off
- Precise Flow Control
- Economical Low Operating Cost

Design Features:

- Flanged Type 150, 300, 600 ANSI Class
- Wafer Design 150 LB
- NPT/SW/BW Ends

Available Pressures:

- » **Control-Set 2 pc** - 1000 psi WOG
- » **Segmented Design** - ANSI 150, 300 & 600
- » **3 pc All Types** - 1000, 2250, & 5000 psi WOG
- » **Wafer Design** - ANSI 150



TB 120-19



Flo-Tite's Control Ball Valves feature a solid stainless steel ball, not a seat insert like many others.



Economy Design from Flo-Tite

Econoflo Series

Reduced Port

Applications:

- Gauge or Drain Services
- Water Treatment
- Compressed Air Lines
- Plumbing Services

Design Features:

- 1 pc Design Valves
- Male X Female Connections/and Female
- Economical Compact Design
- Blow-Out Proof Stem
- Low-Operating Torque

Size Range:

1/4"–2"

Pressure Rating:

1000 psi MAWP/WOG



Model:
T45 SS



Model:
T40 MxF



Model:
T45 SS

TB 26-18

EconoChem Series

- **Models:** 110, 120, 130

Design Features:

- 3 pc Body
- Threaded, Socket-Weld, or Butt Weld Ends
- Full Port Design
- RPTFE Seats

UL Certification Available



Model:
110

Size Range:

1/4"–4"

Pressure Rating:

1000 psi MAWP/WOG

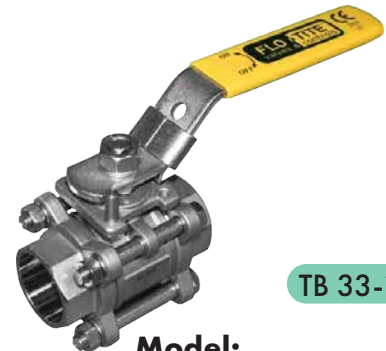

Model:
120

TB 33-18

ISO Mount

PFA Lined Valves

Applications:

- Fertilizers
- Desalination
- Bio-Technical
- Pulp and Paper
- Textile Industry
- Petro-Chemical
- Food Processing
- Semi-Conductors
- Mining and Steel
- Paint and Pigments
- Pharmaceutical Industry
- Chemical Process Industry

Design Features:

- Valve Body Design: ASME B16.42 & EN12516-3
- Face-to-Face: ASME B16.10
- Actuator Mounting Pad: ISO-5211
- ISO 15848-1 compliant & tested low fugitive emission design



Size Range:
1/2"–6"



Size Range:
2"–24"



Size Range:
1/2"–4"

Pressure Rating:

250 psi MAWP/WOG

Economy Design from Flo-Tite

Econoflo Series

- **Models** T80/T82

Applications:

- Power Generation
- Petrochemical Services
- Lact Skids
- Chemical Services
- Universal Applications

Design Features:

- T80 Ball Valves offer an economical solution for low cost full port stainless steel.
- Full Port
- Bubble Tight - Zero Leakage
- Locking Handles

Size Range:

1/4"–4"

Pressure Ratings:

1000 psi MAWP/ WOG
150 psi SWP



Model:
T80



Model:
T82

TB 28-18

Forged Brass - Threaded & Solder Ends

- **Models:** RB Series T91, T92

Applications:

- T91BZ ball valves are ideal utility valves for low pressure applications.

Design Features:

- FM / UL / SR certificates
- Lead Free Designs
- Locking Options
- Full Port

Size Range:

1/4"–4"

Pressure Ratings:

1/4"–2" 600 psi MAWP/WOG
2 1/2"–4" 400 psi MAWP/WOG
150 psi SWP

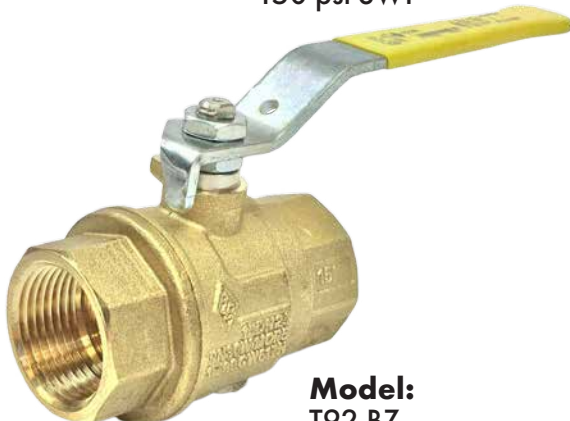

Model:
T92 BZ

TB 31-18

Commercial Series

- **Model:** T70

Design Features:

- 2 pc Standard Port
- All 316 Stainless Steel design

Size Range:

1/4"–2"

Pressure Ratings:

1/4"–1" 2000 psi WOG
1 1/4"–2" 1500 psi WOG
150 psi SWP



Model:
T70

TB 22-18

Metal Seated Ball Valves

Metal Seated Valves

Applications:

- Abrasive or Corrosive Chemicals
- High Temperature Pressure & Steam
- Hydraulic Services
- Slurry Services
- Cryo Applications
- Asphalt Services
- Gas & Oil Services
- Liquid Sulfur
- Steam Services

Design Features:

- **Flanged Type** 150, 300, 600, 1500, 2500 ANSI Class
- **Segmented Design** 150, 300, 600 ANSI Class
- 2 & 3 pc 2250, 3000, 6000 psi WOG
- Uni and Bi Directional Flows
- Tungsten Carbide
- Forged Chromium Carbide
- Hard Chrome
- Forged Stainless Steel Balls
- High Temperature Designs up to 1000°F



TB 130-19

Surface treatments and coatings to withstand abrasion resistance.



Metal Seats Are Available in Above Models.

Steam Jacket Series

Flo-Tite's valve jackets are designed for chemical service where absolute control of fluids are required within a specified temperature range. With special preparation, these valves can be used for severe and hazardous chemical service.

Design Features:

- Bolt on Jacket
- Clamp on Jacket
- Full Jacket
- Compact Full Jacket

2" Carbon Steel F150 with Steam Jacket

3-Way Bolt Type



TB 114-18



Actuation Products



AirCon offers a complete package of Pneumatic, Hydraulic, & Electric Actuators. All types of controls & accessories for a vast number of special automated applications.

AirCon Series

Designed for quarter-turn ball, butterfly, & plug valves as well as damper applications. Incorporating the latest technology in actuator design.

Design Features:

- Hard anodized aluminum body
- NAMUR interface & ISO 5211 Mounting
- 5° travel stops, optional 90° stops
- Torque range up to 1,565,200 in-lbs
- Optional Stainless Steel, PTFE Coated, Epoxy Coated, Ceramic Coated & Nickel Infused Available
- Specs: CE, ISO, ATEX, SIL3



180° Movement

Smart Positioner VAC

- Hart, Fieldbus, and Profibus



VRC Series

- All Specials
- High Chemical Resistance Housing



Solenoid Valve

- Direct Design
- 304 Stainless



Easy-Link ISO Mounting Hardware



Set Screws Locking

Electric Actuators



Max-Seal Butterfly Valves

Flo-Tite also offers a wide variety of Max-Seal Butterfly Valves.

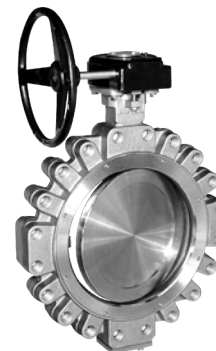

All Types & Designs



4815 West 5th Street
Lumberton NC, 28358

www.flotite.com

Office: 910.738.8904
Fax: 910.738.9112
sales@flotite.com

This brochure is general in nature and Flo-Tite reserves the right to alter dimensions, materials, or to make design improvements.

Document No: SGA-2022
Revision No: 01
Last Review/Update: 04/20/22