



WEATHER SHIELD.
WINDOWS & DOORS

PREMIUM COASTAL

Aluminum-Clad Wood
Windows and Patio Doors

WELCOME



WINDOWS SHOWN:

Configuration: Casement

Exterior Color: White

Hardware Finish: White

Features: Casement Picture
Combinations

A SOLID FOUNDATION TO BUILD ON



When Edward Lee Schield designed his first window in 1955, he set into motion a company built around an inventive spirit. His enthusiasm for innovation defines Weather Shield to this day. After more than 70 years and 33 patents, Weather Shield remains faithfully focused on creating something better and purposeful.



Our Premium Series of products embraces our founder's vision of combining quality craftsmanship with innovative designs and materials. This comprehensive collection features timeless aesthetics with modern energy efficiency.

TABLE OF CONTENTS

Why Weather Shield?	4	Specialty Shape Windows	16	Grille Options	28
Efficiency & Strength	6	Hinged Patio Doors	18	Glass Options	30
Impact Protection	8	Bi-Fold Doors	18	Hardware Options	32
Double Hung Windows	10	Exterior Options	22	Architectural Services	34
Casement Windows	12	Interior Options	24		
Awning Windows	14	Mulling & Trim Options	26		

WHY WEATHER SHIELD?



WINDOWS SHOWN:

Configuration: Hinged Patio Door

Interior Finish: White Poly

Exterior Color: White

Glass: Insulated Low-E with Argon



5 REASONS TO CONSIDER WEATHER SHIELD

With hundreds of window and door manufacturers to choose from, it can be difficult to distinguish one company from another. We thought it might be helpful to share a few of the things that set Weather Shield apart from the rest.

1 Continuous Innovation

At Weather Shield, we never stop searching for ways to improve both our products and our processes. The goal of discovering new and innovative solutions has always been part of our DNA. That's why we have our own dedicated Research and Development Center and the largest onsite test lab in the industry. Not a day goes by when we aren't working on building a better product.

2 Best-In-Class Warranty

At Weather Shield, we do more than talk about our dedication to craftsmanship and quality materials. We back our products with a warranty against defects in material or workmanship for a period of 20 years, and against wood rot on all clad products for 30 years*. So you can be confident you're getting an outstanding product from a trustworthy company.

3 Design Flexibility

When you design with Weather Shield, you have options. Our casements alone allow you to create more than 6,000,000 different configurations.

Choose from an impressive array of wood interiors and finishes, along with a myriad of exterior colors. We also offer some of the industry's largest expanses of glass for framing spectacular views. Whatever the style, whatever the size, nobody gives you more choices than Weather Shield.

4 Energy Efficiency Without Sacrifice

Through our innovative use of materials and design, we're able to offer industrial strength efficiency with refined appearance. We're very deliberate in our use of energy efficient materials to drive performance where it matters most. We're proud to offer an extensive number of beautifully designed ENERGY STAR® rated products.

5 More Than 70 Years of Experience

Since 1955, Weather Shield has been committed to making windows and doors the right way – by putting our customers first. That philosophy remains at the heart of everything we do today. What began as a small operation in Central Wisconsin has grown into one of the nation's leading window and door manufacturers.

Decades of dedication to quality and continuous improvement have helped us build lasting relationships with homeowners, builders, architects, and distributors across the country. Headquartered in Medford, Wisconsin, we invite you to discover everything Weather Shield has to offer.

*For more specific information regarding our warranty, visit weathershield.com/warranties.

EFFICIENCY & STRENGTH



AS STRONG AND BEAUTIFUL AS MOTHER NATURE HERSELF

Don't let your home's greatest asset—its location—become a liability. Coastal living is meant to be stress-free. Rest easy knowing your home is perfectly tailored to the landscape that surrounds it, with exteriors designed to be as durable and secure as they are beautiful.



30 Year No-Rot Warranty*

With advanced wood protection technology, Weather Shield windows are perfectly sealed so that no moisture can penetrate your first line of defense. It's a promise we stand by with one of the most comprehensive no-rot warranties in the industry.



OURS



OTHER MANUFACTURERS

Worry-Free Exteriors

Protect your home from the elements, so you can get out and enjoy them. Our exteriors are free from the damage done by salt water, sea breezes and strong sun. Our uniquely designed extruded aluminum cladding is 50% stronger than standard thin roll-form cladding, so it won't corrode, dent or fade.

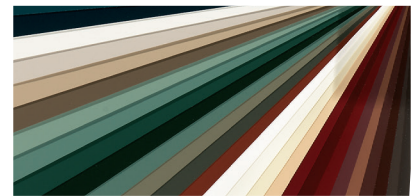

Standard Premium Paint

Don't let your home fall victim to humidity, color change, chalk, gloss loss and deterioration from chemicals like salt and acid rain. All Premium Coastal products offer outstanding resistance to these and other coastal concerns.

Your Best Defense

It's crucial to protect your home from the severe weather associated with coastal climates. Much of the damage that can occur during a hurricane is the result of an impact fracture such as a broken window or failed door. The resulting rapid air movement can cause catastrophic damage to the home—all because of one faulty product.

Our impact-resistant windows and doors are made with laminated glass to dramatically reduce the likelihood of an impact fracture during a high windstorm, keeping air pressure—and your home—secure.

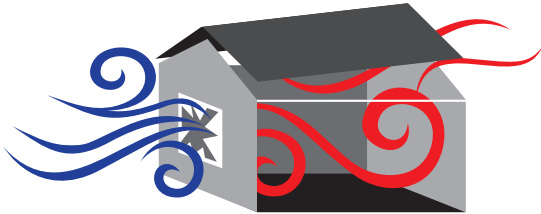

Opening in Windward Wall

Failed windows and doors compromise a home's structure. When pressurized outside air rushes to find low-pressure pockets of air and expand, the force may be enough to physically blow off a roof.

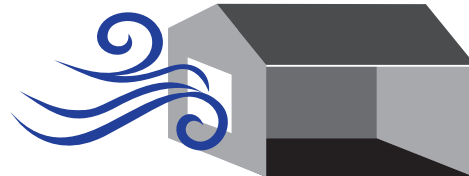

Fully Enclosed Building

Premium Coastal windows and doors are tough. Their durable interlayer can withstand tremendous blows from flying debris, thus reducing the chance of an impact fracture. With the building envelope intact, the likelihood of a catastrophic structural failure is reduced.

Powerful Glass for Powerful Protection

Premium Coastal windows and doors feature **heavy-duty impact-resistant glass** that consists of a tough laminated interlayer bonded between two panes of glass. This impact-resistant layer helps prevent flying debris from entering the home, even in the most severe storms. Find out more about Weather Shield's glass options on pages 26 and 27.

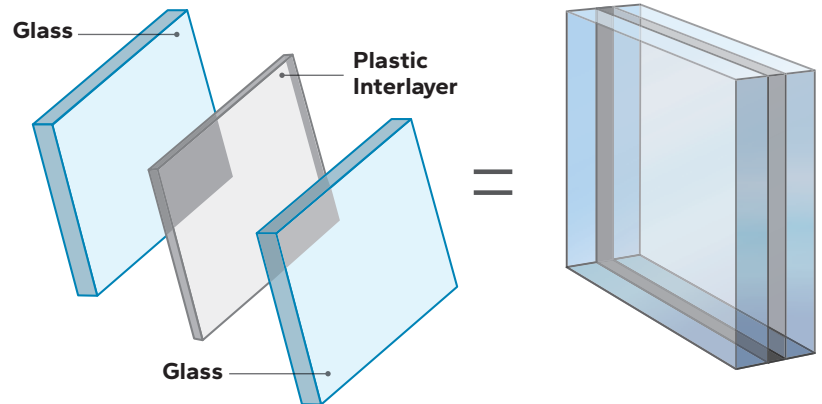

Heavy-duty Impact Glass

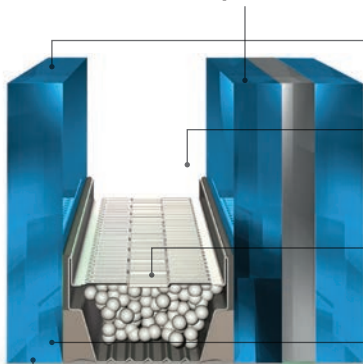

Non-Impact Glass

Low-E coatings help to filter UV rays to protect furnishings from fading due to the sun, while also insulating the home in winter and summer.

The **airspace between the two panes of glass** provides insulating power from the extreme temperatures common in coastal regions. Adding safe, colorless argon gas or an inert gas-mix to the airspace increases the window unit's energy efficiency.

Our unique **Endura IG™ stainless steel spacer** adds strength and durability. Bent corners create a continuous impermeable barrier around the entire perimeter.

EasyCare™ glass is an excellent option with Zo-e-shield Coastal. This additional, invisible, permanent coating on the glass makes it easy to wash away dirt and sand, and allows water to spread out and evaporate leaving fewer spots.

IMPACT PROTECTION



THE ULTIMATE PEACE OF MIND

Our products are rigorously tested to meet the most stringent codes. Weather Shield Premium Coastal® Impact products are certified by the Window and Door Manufacturers Association (WDMA). They are independently tested in accordance with ASTM E1886 and E1996 and/or TAS (201, 202, 203) protocols.

More Than Impact Protection

In addition to protection from severe weather, laminated glass offers several other advantages:



Sound

Welcome in the sounds of crashing waves and sea breezes—or block them out. Our products are designed to protect from exterior noise so you can easily filter out unwanted sound.



Safety

Protect yourself and your family with glass that eliminates the dangers of jagged edges that can cause injury or harm, in addition to compromising the integrity of your home.



Security

Your home is your safe haven—and it should feel secure. Rest easy knowing your loved ones and precious belongings are secure from burglary or an attempted breach of a window or door.



Solar

Enjoy the abundant sunshine without letting it damage your home. Our products offer superior resistance to the UV fading so common in poorly equipped coastal homes.

Each impact resistant Premium Coastal unit undergoes rigorous testing to ensure that it is less susceptible to object penetration during high winds than windows and doors that are manufactured using other types of glass. If the glass is broken, its laminated interlayer is designed to remain intact. This can help reduce damage from windborne debris and the likelihood of an implosion caused by sudden pressure equalization inside the home.



High Velocity Hurricane Zone

- Geographic area of Florida including all of Miami/Dade and Broward Counties
- Ultimate Design Wind Speed greater than 170 mph
- Missile level D: 9 lbs., 2 x 4 shot at 50 ft. per second (2 shots)
- 9,000 +/- air pressure cycles
- TAS (201,202, 203) Protocol



Wind Zone 4

- Ultimate Design Wind Speed greater than 170 mph
- Missile level D: 9 lbs., 2 x 4 shot at 50 ft. per second (2 shots)
- 9,000 +/- air pressure cycles
- ASTM E1886/1996



Wind Zone 3

- Ultimate Design Wind Speed 150-170 mph
- Missile level D: 9 lbs., 2 x 4 shot at 50 ft. per second (1 shot)
- 9,000 +/- air pressure cycles
- ASTM E1886/E1996

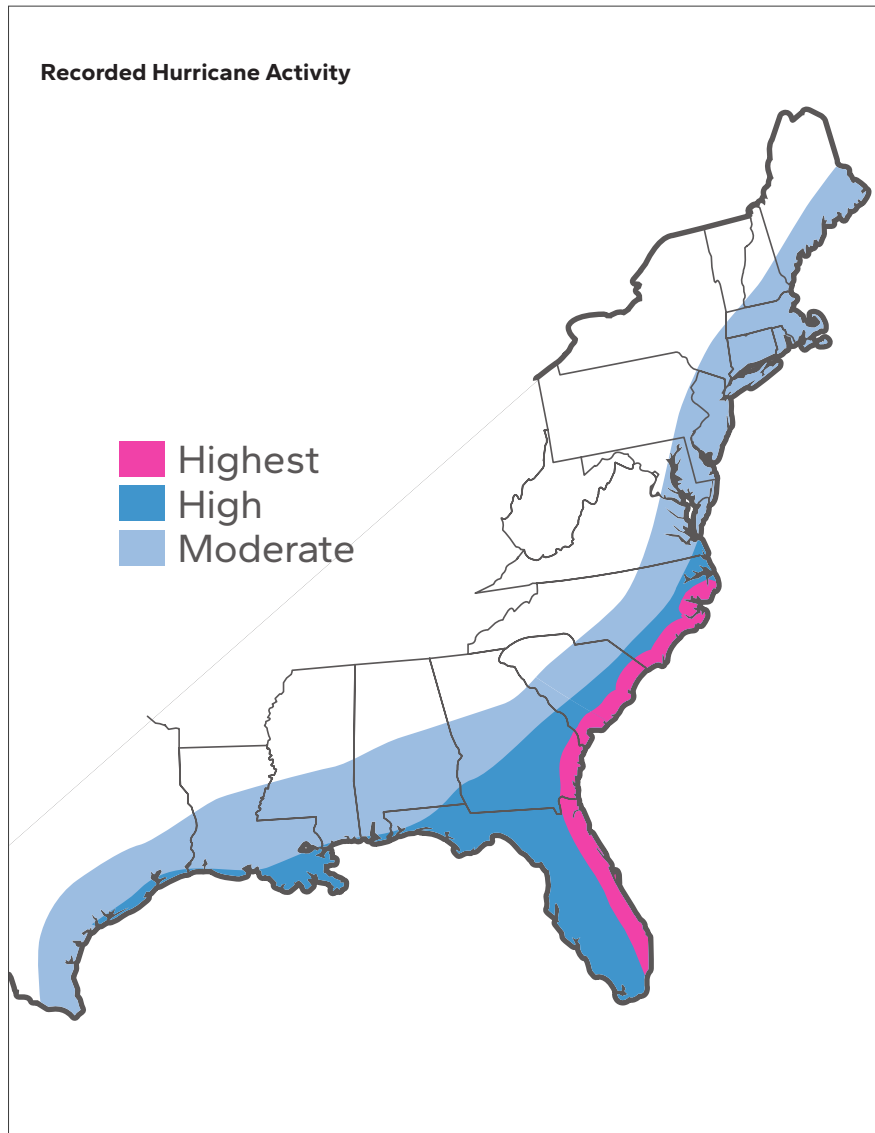

Weather Shield Premium Coastal products have been tested and certified to one or more of the following test protocols as required to meet the extreme building code requirements for coastal areas exposed to hurricane activity. This testing complies with the requirements of the Florida Building Code, International Building Code and International Residential Code based on wind zones.

- Miami-Dade County HVHZ (TAS 201, 202, 203)
- ASTM E 1886/ASTM E1996 (Missile Level D – Wind Zone 4)
- ASTM E 1886/ASTM E1996 (Missile Level D – Wind Zone 3)

These test standards were developed to determine an externally glazed product's ability to resist windborne debris. Successful performance to these standards is required to meet building code requirements in wind-borne debris regions for glazed opening protection. The Florida Building Code and the International Building Code mandate windborne debris protection for glazing in all hurricane-prone or high-wind regions.

During tests, an entire window or door unit is subject to the impact of a eight foot long, nine-pound 2"x 4" piece of lumber projected at a speed of 50 feet per second. HVHZ and Wind Zone 4 certified units are subjected to two wood hits, while Wind Zone 3 units receive one hit. If the window successfully resists the impact, it's then subjected to the cyclical pressure test where the window must endure 9,000 inward- and outward-acting pressure cycles in a strictly sanctioned sequence defined in the test standard.

Source: U.S. Department of Interior, U.S. Geological Survey, Reston, VA, USA

DOUBLE HUNG WINDOWS

WINDOWS SHOWN:

Configuration: Double Hung

Exterior: White

Hardware Finish: Black

Features: 7/8" Simulated Divided Lite

LET THE FRESH AIR IN

With the versatility to open from the top or bottom, our double hung windows ensure nothing ever stands between you and an inviting breeze. This design also offers robust ventilation, energy efficiency and ease of use—making it an instant classic.

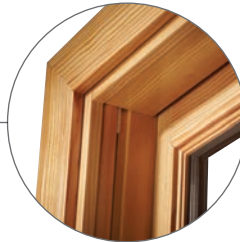

Natural Finish

A **wood jambliner** covers all mechanical balance systems to create a **clean aesthetic** perfect for a coastal lifestyle.



Clean Sightlines

Keep your coastal view unobstructed with **concealed tilt release latches** that are recessed into the lock rail, leaving the sash clear of all visible latch hardware.



Single Handed Ease

The **single dual action lock** can easily be unlocked and tilted with one hand, so you can save your energy for enjoying the view.

CERTIFIED TO:



Premium Coastal single-glazed and insulated double hung window

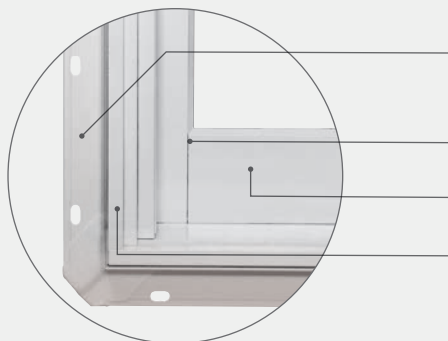

The Beauty is in the Details

The **rigid integral nailing fin** makes installation simple and provides more durability than flimsy snap-in or fold-out fins found with other windows.

Butt jointed cladding accurately mimics traditional wood windows for a familiar aesthetic.

The **3-1/2" bottom rail** creates clean lines and ideal architectural proportions.

Durable and virtually maintenance-free, **extruded aluminum exteriors** stand up to the harshest coastal elements, resisting dents, dings and scratches with rot- and corrosion-resistant composition.

AN ELEGANT WINDOW TO YOUR WORLD

Our casement windows offer outstanding design flexibility—used individually or in combination to create a wall of glass, the possibilities are endless. Welcome in a burst of fresh air as you effortlessly open the side-hinged window, and maximize the view with minimal sightlines ideal for framing an ocean vista.

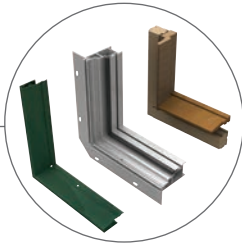

Unmatched Performance

Tricore™ Frame Technology features extruded aluminum exterior cladding that's easy to maintain and stands up to the harshest elements. With corners welded to prevent water penetration, the multi-chambered composite sub-frame is not only impervious to moisture, but also acts as a thermal barrier.

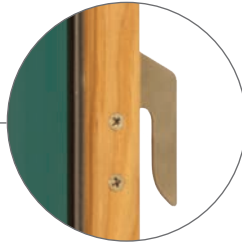

Refined Security

The **concealed lock system** provides a clean appearance with a single lever lock that engages all lock points on the sash.



Effortless Operation

European engineered **premium hardware** makes opening and closing even the largest units feel effortless.

CERTIFIED TO:



Premium Coastal single-glazed and insulated casement window

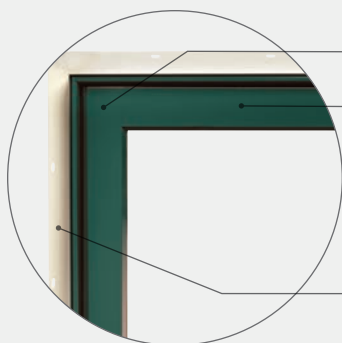

Butt jointed cladding accurately mimics traditional wood windows for a familiar aesthetic.

Climate-Proof Exteriors

Our aluminum exterior-clad wood products feature **commercial-grade premium paint** that resists the fading and chalking so common in coastal climates. Extruded aluminum resists dents, dings and scratches and is backed by our 20-year limited warranty.

Durable by Design

Integral nailing fins increase stability and help seal the unit to the structure, providing superior performance and durability even in severe weather conditions.

CASEMENT WINDOWS



WINDOWS SHOWN:

Configuration: Casement

Interior Finish: White Poly Painted

Hardware Finish: White

Glass: Premium Coastal Insulated Glass

AWNING WINDOWS



WINDOWS SHOWN:

Configuration: Awning

Hardware Finish: Tan

Interior Finish: Pine with
Clear Satin Stain

Glass: Premium Coastal
Insulated Glass

THE PERFECT COASTAL SOLUTION

Take advantage of the beach breeze with awning windows designed to let you control ventilation. Hinged to swing out from the bottom, they're a great way to welcome in abundant natural light while protecting your home from unwanted moisture.

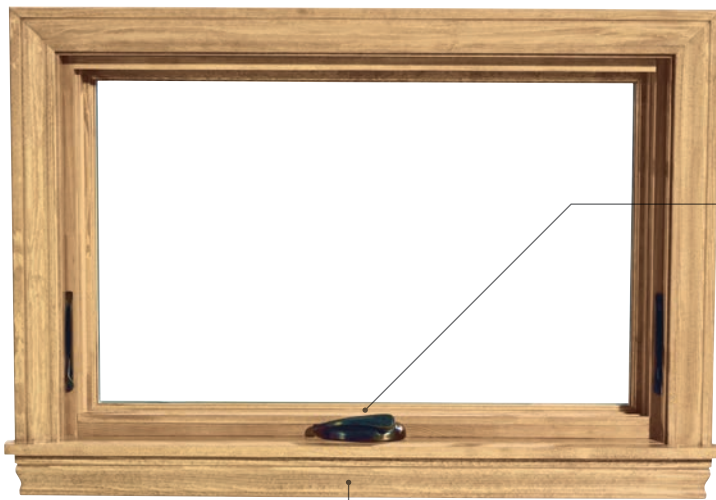

Low Profile, High Performance

Nested folding cranks create visual harmony from the window detailing, to the hardware, to the coastal views. The handle folds neatly out of the way so it won't interfere with the window treatment. Take advantage of design flexibility with a variety of finishes to choose from for a custom look.



Corrosion-Resistant Hardware

Stainless steel hinge arms are designed to **resist rust and corrosion** to provide a lifetime of smooth operation. The heavy gauge steel also provides superior strength and stability to keep open windows securely in position.

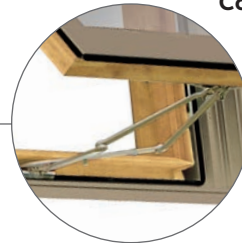

CERTIFIED TO:



Premium Coastal single-glazed and insulated awning window

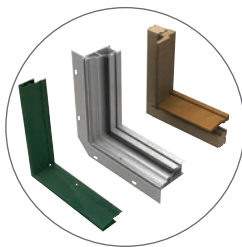

Unmatched Performance

Tricore™ Frame Technology features extruded aluminum exterior cladding that's easy to maintain and stands up to the harshest elements. With corners welded to prevent water penetration, the multi-chambered composite sub-frame is not only impervious to moisture, but also acts as a thermal barrier.



Less Maintenance, More Peace of Mind

The aluminum clad exterior **stands up to long-term exposure** in the harshest coastal environments.

Naturally Appealing

Butt jointed cladding accurately **mimics traditional wood** windows for an authentic, beachy aesthetic.

Weather Ventilation

Our awning windows give you **greater control over airflow**, as you open them to whatever degree suits your needs. Whether you maximize the breeze or simply let in a little fresh air, the choice is yours.

SHAPE YOUR VIEW

Your home should be as flawlessly suited to your tastes as the coastal landscape surrounding it. Choose among limitless sizes, shapes and styles — as well as finishes, colors and materials — to create a specialty shape window perfect for you. With the same energy efficiency and durability you expect from Weather Shield products — it's the perfect solution.



SIMULATED SASH

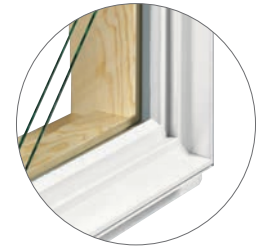

STANDARD FRAME

Functional Flexibility

Take full advantage of the coastal landscape with abundant vistas and natural light in any room. The **simulated sash** option gives the appearance of a true sash window with the performance of a direct-set.

CERTIFIED TO:



Premium Coastal single-glazed and insulated direct set window



HALF CIRCLE



QUARTER CIRCLE



EYEBROW WITH LEGS



QUARTER EYEBROW



TRIANGLE, LEFT/RIGHT



OCTAGON



HALF CIRCLE WITH LEGS



QUARTER CIRCLE WITH LEGS

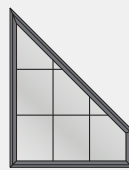

TRAPEZOID



PENTAGON



RECTANGLE

Architectural Freedom

Glass is glazed directly into the frames of our specialty shape windows, in a **wide range of shapes and sizes** to perfectly suit any space.

In addition to the Premium Coastal direct-set windows shown here, the following shapes are also available: Arch Top, Diamond, Hexagon, Parallelogram, Right Triangle, Triangle, Full Circle and other custom shapes upon request.



SPECIALTY SHAPE WINDOWS

WINDOWS SHOWN:

Configuration: Direct Set

Exterior Color: White

Interior Finish: White Poly Painted

Features: 7/8" Simulated Divided Lite

HINGED PATIO DOORS



DOOR SHOWN:

Style: French Hinged Patio Door

Exterior Color: White

Interior Finish: White Poly Painted

Hardware Finish: Brushed Nickel

THE DOORWAY TO COASTAL PERFECTION

Our hinged patio door is the ideal transition between the beauty outside and beauty within. Open it and let daylight and fresh air flow freely. Close it and enjoy the sleek appearance and clean lines of a timeless architectural classic.



Durable Construction

Each patio door panel is made with structurally sound **Laminated Veneer Lumber (LVL)**. Solid, heavy-duty 3/4-inch wood dowels connect the panels.



Security and Performance

Our stainless steel **multi-point locking system** offers increased security and the peace of mind you deserve. It's also impervious to corrosion and able to withstand the elements in any climate.

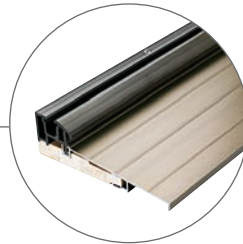

Shelter From the Storm

Patio doors provide the perfect **buffer from the coastal climate** outside. Every component has been reviewed to ensure that rain and water stay outside, never even crossing the threshold.

CERTIFIED TO:



Premium Coastal single-glazed and insulated outswing 1-3/4" and 2-1/4" French door and sidelites



Premium Coastal insulated inswing 2-1/4" French door

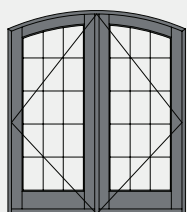

EYEBROW DOOR

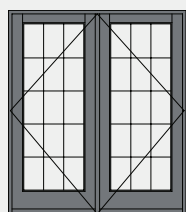

FRENCH HINGED DOOR

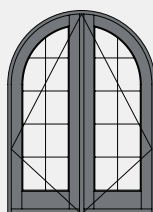

FULL RADIUS DOOR

Options Abound

Our hinged patio door is available in a **wide variety of styles and operations**. Inswing or outswing doors can accommodate any room arrangement, while eyebrow or full radius panels provide endless choices to suit any style. Whatever your design preference, the Premium Coastal hinged patio door is the perfect way to open your home to the salty breeze and crashing waves you love.

ADD BREEZY CHARM TO COASTAL LIVING

Our bi-fold doors bring the breezy charm of coastal living to any home, effortlessly blending with any style. They open wide to invite the sea air and sunlight inside, creating a seamless flow between your interior retreat and the great outdoors.

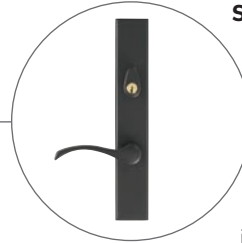

Security and Performance

Our **stainless steel multi-point locking system** offers increased security and the peace of mind you deserve. It's also impervious to corrosion and able to withstand the elements in any climate.



Optimum Operation

The **concealed shoot bolt system** releases the shoot bolts while providing a handle for ease of operation when opening the panels.



Optimum Operation

Bi-fold doors open and close with a whisper, utilizing the **highest-grade bearings** made with stainless steel and corrosion-resistant polymers. Our remarkable **roller system** has been tested to fifty thousand cycles without failure — making it as reliable as it is unique.

CERTIFIED TO:



Premium Coastal single-glazed and insulated bi-fold door

Superior Engineering

Our bi-fold doors and windows feature a single, high-performance sill designed to deliver exceptional durability and smooth operation. Visit our website for detailed specifications.

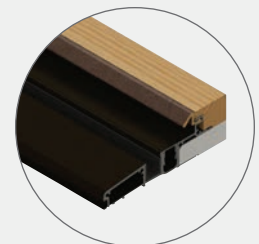

TRADITIONAL SILL

BI-FOLD DOORS



DOOR SHOWN:

Configuration: Bi-Fold Door

Exterior Color: White

Interior Finish: White Poly

Hardware Finish: Brushed Nickel

EXTERIOR OPTIONS



EXTERIOR COLOR OPTIONS

To help you capture the perfect coastal look, we offer a refreshing palette of durable, seaside-ready exterior color options – all rated to the highest standards for long-lasting color and finish. Our Premium windows and doors are available in 60 high-performance painted colors and 6 anodized finishes, plus unlimited custom color-match options to reflect your unique coastal style.

Anodized Aluminum Exterior Finishes

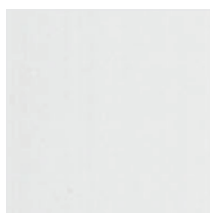

CLEAR



CHAMPAGNE



LIGHT BRONZE



MEDIUM BRONZE



DARK BRONZE



BLACK

60 Painted Exterior Finishes

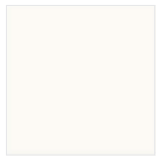

WHITE

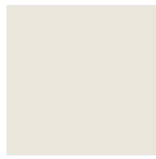

DUNE WHITE
MATTE

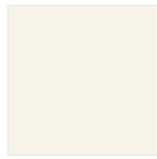

ALABASTER



CAMEO



PEARL



MODERATE WHITE



LINEN



ACCESSIBLE BEIGE



TAN



SANDSTONE



DRIFTWOOD



DESERT TAN



NATURAL
CANVAS

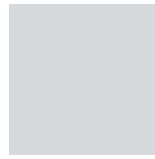

OLYMPUS WHITE



GLACIER GRAY



MIST GRAY



GRAY
MATTERS



WALL STREET



GUNPOWDER



IRON MATTE



BURNT SLATE
MATTE



OBSIDIAN



BLACK STEEL
MATTE



JET BLACK



SUNBEAM
YELLOW



SERENGETI GRASS



OATMEAL CREAM



MUSHROOM GRAY



STONE GRAY



PRESTIGE



SHALE



BRONZE GREEN



QUAKER BRONZE



TUDOR HOUSE



CRAFTSMAN
BRONZE



TWILIGHT BRONZE



MOSS



ARCADIAN



WOODLAND
GREEN



SAGE GREEN



BERCORTIZ GREEN



HARTFORD GREEN



SHORELINE



AEGEAN BLUE



DISTANCE



BLUE STONE



INDIGO



MIDNIGHT BLUE



TIMBERIDGE



SUPERIOR
BRONZE



HERITAGE BROWN



ADOBE

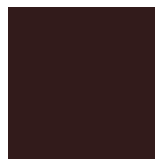

APPALACHIAN
BROWN

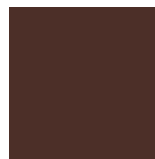

ROYAL BROWN



BOYSENBERRY



FIREBRICK



BRICK RED

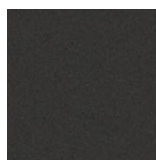

ESPRESSO
METALLIC



WARM SILVER
METALLIC

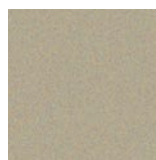

ANTIQUE SILVER
METALLIC

INTERIOR OPTIONS



INTERIOR WOOD OPTIONS

Every home is different. So we give you choices to add your own special touch. Choose the wood grain and color that complement your design. Then add warmth and beauty with our factory finishes. Whether subtle or stunning, you'll find options to make a lasting impression.

Rich Wood Interiors

With eight wood species to choose from, there's sure to be one perfect for your home. For a truly unique look, other wood species are available upon request.



PINE
(STANDARD)

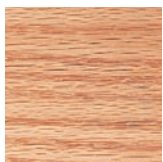

OAK

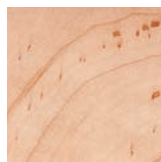

MAPLE



ALDER
(CHARACTER)



CHERRY

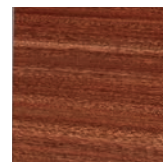

MAHOGANY



MIXED GRAIN FIR

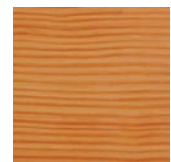

VERTICAL GRAIN
FIR

FACTORY FINISHES ON PINE

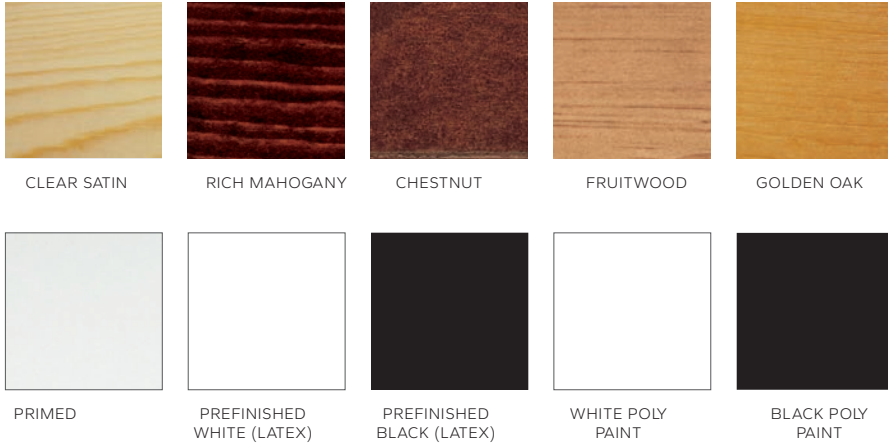

Durable Factory Finishes

Save time and money with our factory finishing. The wood is stained and sealed on all surfaces to repel moisture and includes two Clear Satin top coats for durability and easy cleaning.

DESIGNER STAINS ON PINE

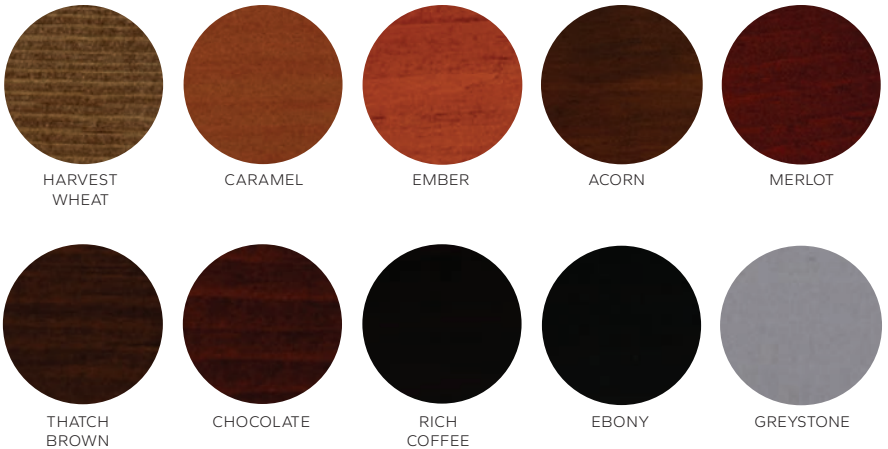

Designer Stains

Explore our new furniture-grade stain offering created in partnership with leading paint and coatings manufacturer Sherwin-Williams®. These new stains provide clean, vivid colors with high pigmentation for excellent clarity and uniformity.

PROUDLY FINISHED WITH
SHERWIN-WILLIAMS®

7 Step Process

Our intensive seven step process creates a long-lasting premium finish that will protect and enhance the beauty of your windows and doors for years to come.

7 STEPS TO CREATE A FURNITURE GRADE STAIN

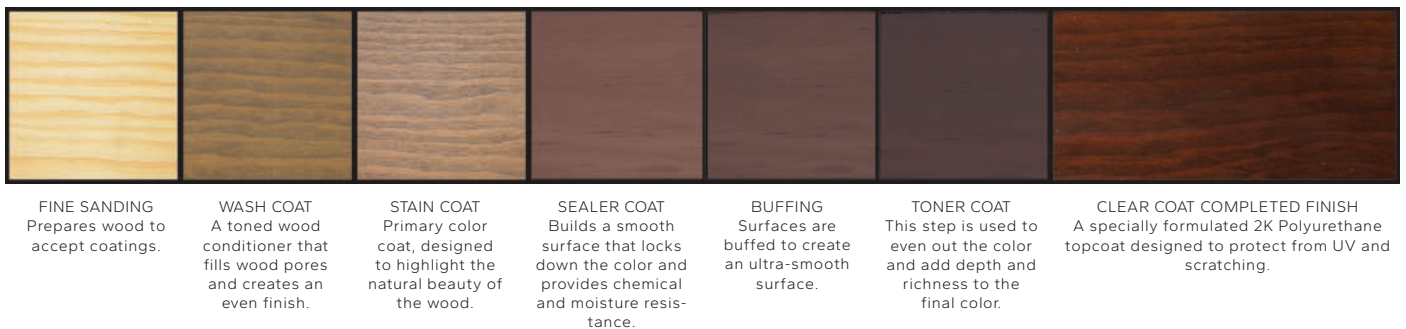

FINE SANDING
Prepares wood to accept coatings.

WASH COAT
A toned wood conditioner that fills wood pores and creates an even finish.

STAIN COAT
Primary color coat, designed to highlight the natural beauty of the wood.

SEALER COAT
Builds a smooth surface that locks down the color and provides chemical and moisture resistance.

BUFFING
Surfaces are buffed to create an ultra-smooth surface.

TONER COAT
This step is used to even out the color and add depth and richness to the final color.

CLEAR COAT COMPLETED FINISH
A specially formulated 2K Polyurethane topcoat designed to protect from UV and scratching.

Finishes and colors shown may not be actual representations. Please visit an authorized Weather Shield dealer for color samples.

All finishes not available on all wood species. Please visit an authorized Weather Shield dealer for details.

MULLING & TRIM OPTIONS



DOOR SHOWN:

Configuration: Hinged
Patio Door

Exterior Color: White

Interior Finish: White Poly Painted

Features: 7/8" Simulated
Divided Lite

NO COMPROMISES

With Weather Shield's Premium Coastal products, you do not have to sacrifice design to have the views you want. Our impact products have been certified in a multitude of mull and stacked configurations to eliminate the compromising that often takes place for code compliance.

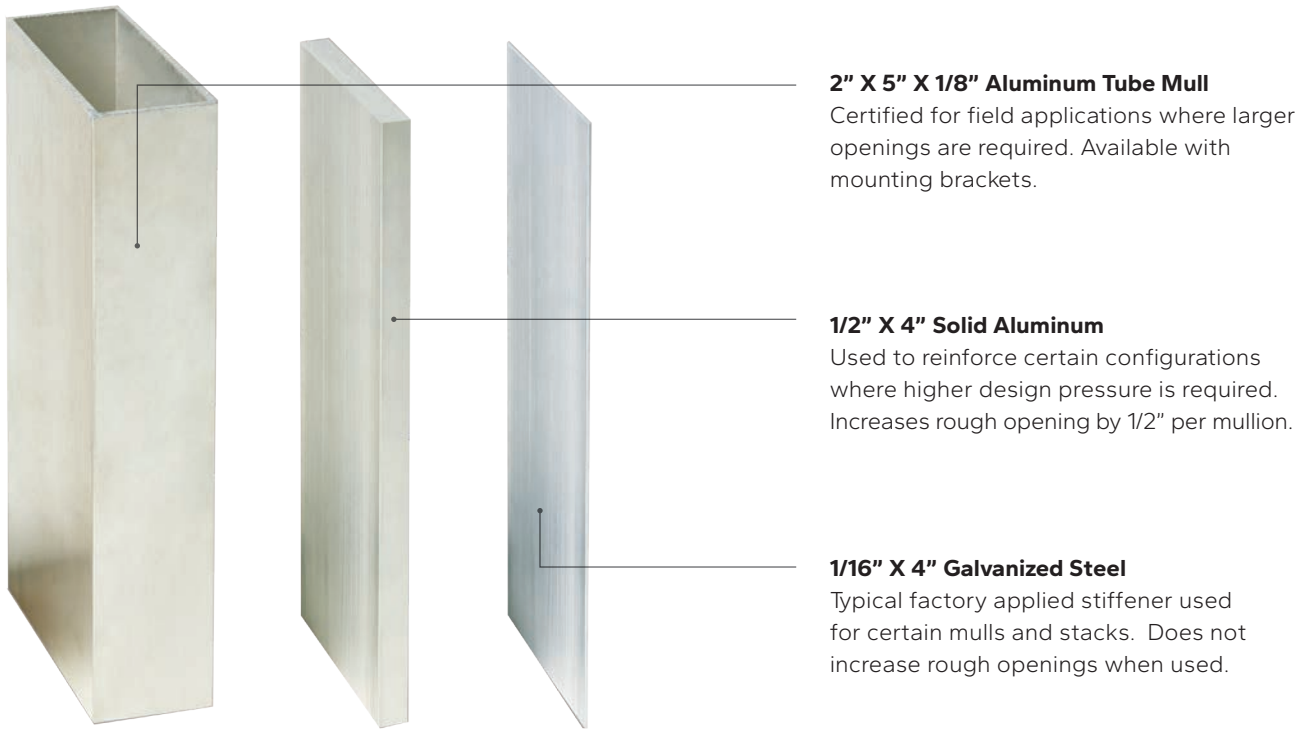

2" X 5" X 1/8" Aluminum Tube Mull
 Certified for field applications where larger openings are required. Available with mounting brackets.

1/2" X 4" Solid Aluminum
 Used to reinforce certain configurations where higher design pressure is required. Increases rough opening by 1/2" per mullion.

1/16" X 4" Galvanized Steel
 Typical factory applied stiffener used for certain mulls and stacks. Does not increase rough openings when used.

Mulling Options

Save time and money with certified, factory mull windows and doors. Avoid additional labor in the field by having your composite windows mull and stacked in our quality controlled factory.



7/8" BRICKMOLD



1-11/16" BRICKMOULD

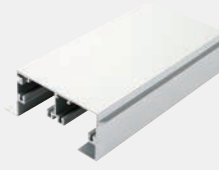

3-1/2" FLAT CASING



HISTORICAL BRICKMOULD



Exterior Trim Options

A traditional wood look with the durability of heavy extruded aluminum. Factory applied to save time and money.

GRILLE OPTIONS



QUALITY AS STUNNING AS THE VIEW

Never compromise when it comes to creating your dream coastal home. We offer only top-of-the-line design and construction, so you can perfectly complete the look of your windows with high performance, innovative solutions.

The Perfect Grille

Personalize your home with windows featuring a selection of bar widths and profiles, as well as traditional grille patterns and custom designs. For even greater **creativity and design** flexibility, most grilles can be manufactured from Weather Shield's custom wood interiors collection.

Custom Grille Pattern Options

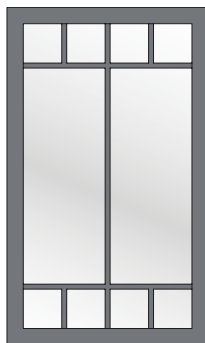

CHARLESTON

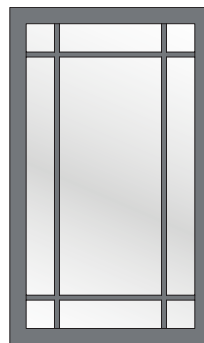

PRAIRIE

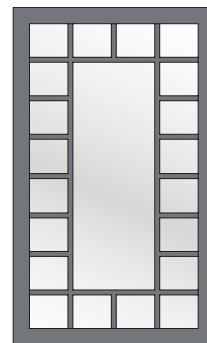

SAVANNAH

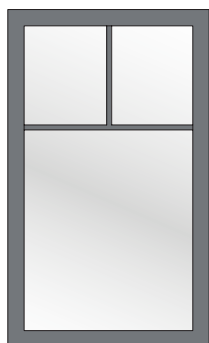

COTTAGE

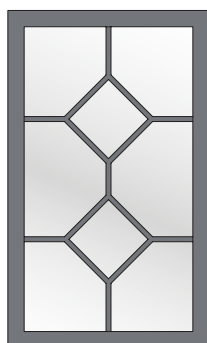

SILHOUETTE

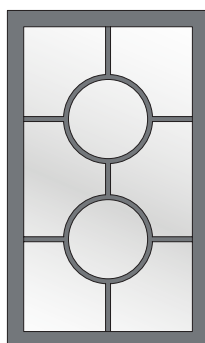

NEWPORT

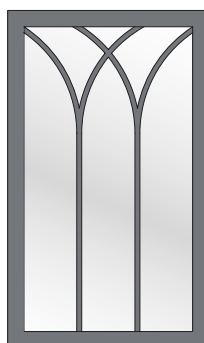

GOthic

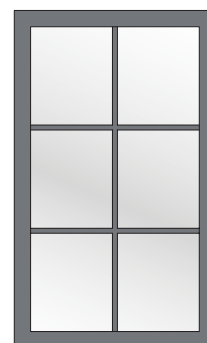

RECTANGULAR

Putty Exterior Aluminum Profile

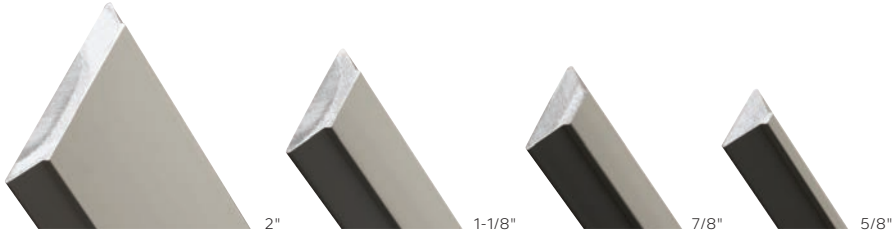

Colonial Interior Wood Profile

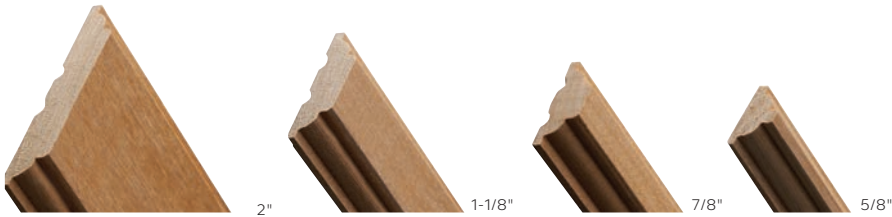

Putty Interior Wood Profile



Square Interior Wood Profile

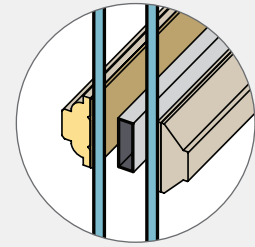
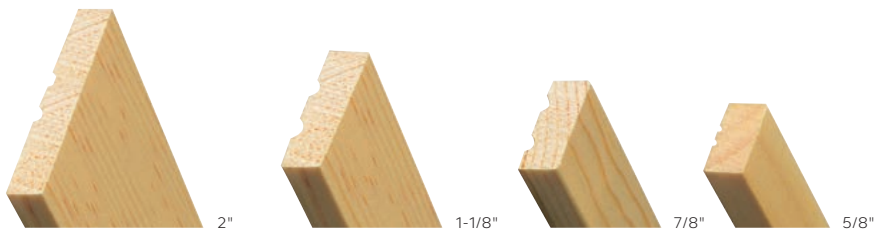

Innovative Design; Classic Appeal

The best of modern energy efficiency meets old-world charm in **Simulated Divided Lite (SDL)** grilles. While mimicking the look of classic single-pane windows, SDL grilles offer exterior and interior grille bars either with or without an aluminum spacer bar — translating to powerful insulation and innovation.

Framed With You in Mind

Featuring a unique **perimeter grille frame design** that rests on the inside of the unit, Weather Shield windows employ a concealed pin system to snap the perimeter grille frame securely into place. These grilles can be easily removed in order to clean the entire interior glass surface.

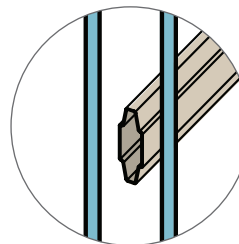
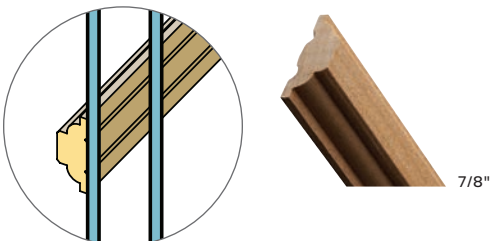

A Breath of Fresh Air

Airspace Grilles seal aluminum grille bars in either a sculpted or flat design between two panes of glass. Resulting in a classic aesthetic that is easy to clean and maintain.

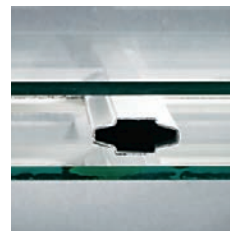

1 1/16" SCULPTURED

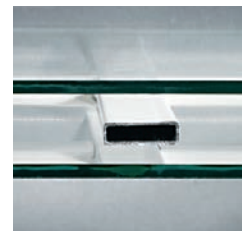

5/8" FLAT

GLASS OPTIONS



THE CRYSTAL CLEAR CHOICE

Energy efficiency is more important than ever in a coastal setting. Choosing the right glass can powerfully impact climate control in a tropical climate, while providing the safety and security you need to protect your assets. And with UV protection, you don't have to let the sunshine you love damage your investment.

High-Performance Glass



LoE²-272 Glass

is ideal for all weather conditions in most climates.

- Highest light transmission, 72%.
- Moderate solar control. Blocks more than 65% of the sun's heat.
- Less than 1% UV transmission when combined with laminated glass.



LoE³-366 Glass

is the ultimate performance glass

- Highest Light Transmission, 65%.
- Low solar gain. Blocks nearly 80% of the sun's heat.
- Less than 1% UV transmission when combined with laminated glass.



LoE³-340 Glass

has unprecedented solar control while maintaining low U-values.

- Lower Light Transmission, 40%.
- Lowest solar gain. Blocks about 85% of the sun's heat.
- Best choice for fade resistance when combined with laminated glass. (UV & visible light)
- Meets sea turtle conservation codes.

Insulated Glass Construction

Rather than using a single pane of glass, an insulated glass unit is comprised of two lites of glass that are combined into one airtight unit.

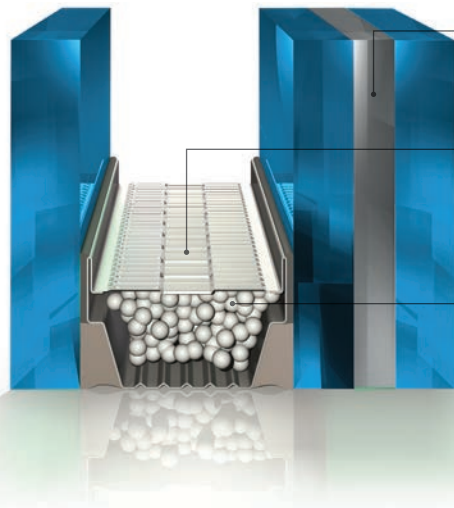

Impact Resistant Laminated Glass

Polyvinyl butyral (PVB) or DuPont SentryGlas® Plus (SGP) Interlayer bonded between two panes of glass

Structural Stainless Steel Spacer

Corrugated shape adds strength. Bent corners create a continuous impermeable barrier around the entire perimeter.

Desiccant

Assures optimum moisture absorption while minimizing the effects of temperature-related pressure changes.

Single Glazed Construction

For those areas that codes allow single glazed windows and doors, Weather Shield has the products to fit. Single glazed products are fortified with Polyvinyl Butyral (PVB) or DuPont™ SentryGlas® Plus (SGP) Interlayer bonded between two panes of glass. For added solar control our single glazed windows are available with LoE³ 366 or LoE³ 340 performance glass coatings.

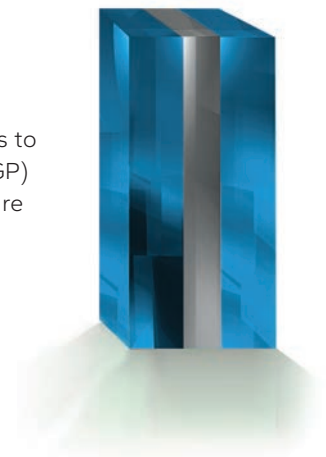

Time-Saving Options

Windows Clean Easier and Stay Cleaner

Neat® coated glass harnesses the power of the sun's UV rays to loosen dirt so water can rinse it away, leaving the window virtually spotless.

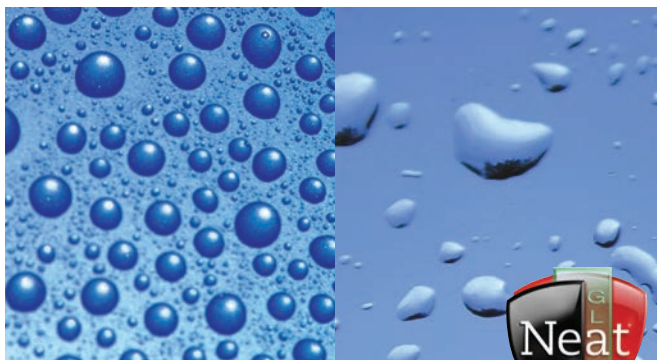

UNCOATED GLASS

NEAT® GLASS

Jobsite Protection and Easy Clean-Up

Preserve® is a clear protective film that is factory-applied in overlapping layers to ensure that the entire glass surface is protected. It can be applied to be the inner and outer surfaces of insulated glass units.



HARDWARE OPTIONS



LUXURY HARDWARE FOR YOUR LUXURY HOME

Your coastal home already makes a dramatic statement—don't let the hardware do anything less. Gracefully transform and enhance the style of any space with our curated line of finishes and designs, then rest easy knowing your careful choice will stand up to the corrosion of salt and the elements.

Finish First

Window hardware finishes are available in an array of colors and textures to suit any user's tastes. Options range from ultra modern brushed nickel to sleek black, allowing you to achieve any desired look.

Double Hung Hardware



CONTEMPORARY SASH LOCK



CONTEMPORARY LIFT HANDLE



HISTORICAL SASH LOCK*



HISTORICAL FINGER LIFT



HISTORICAL PULL

Double Hung Hardware Finishes



WHITE



TAN



BRUSHED NICKEL



BRIGHT BRASS



RUSTIC BRONZE

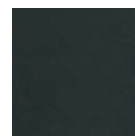

BLACK

Finishes and colors shown may not be actual representations. Please visit authorized Weather Shield dealer for color samples.

*Historical Sash Lock not available in Bright Brass.

Casement and Awning Hardware Finishes



WHITE

TAN

BRUSHED
NICKEL



BRIGHT BRASS

RUSTIC BRONZE

BLACK



POLISHED
CHROME*

Casement and Awning Hardware



NESTED FOLDING CRANK

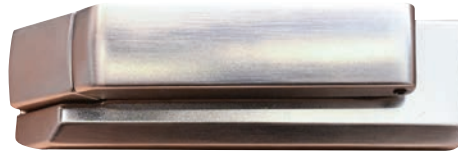

CONTEMPORARY FOLDING CRANK

PUSH OUT HARDWARE**



TRANSITIONAL



CONTEMPORARY

Finishes and colors shown may not be actual representations. Please visit authorized Weather Shield dealer for color samples.

*Polished Chrome only available for contemporary hardware.

**Push Out hardware only available in Black, Rustic Bronze, and Brushed Nickel.

The Perfect Finishing Touch

Discover the full range of **patio door hardware finishes** – from classic to contemporary, luxurious to minimalist – and experience the power of design to shape your perspective.

Hinged Patio Door Hardware Finishes

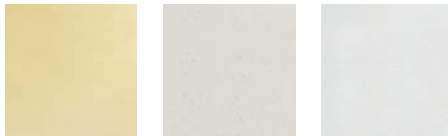

BRIGHT BRASS
PVD

BRUSHED
NICKEL PVD

POLISHED
CHROME

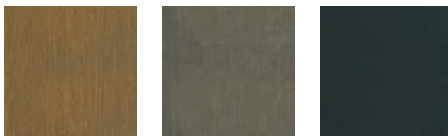

ANTIQUE
BRASS

OIL-RUBBED
BRONZE

BLACK

All finishes not available on all hardware. Please visit authorized Weather Shield dealer for finish options.



SQUARE TOP
ESCUTCHEON



ARCH TOP
ESCUTCHEON

Finishes and colors shown may not be actual representations. Please visit authorized Weather Shield dealer for color samples.

ARCHITECTURAL SERVICES



DOOR SHOWN:

Style: French Hinged
Patio Door

Exterior Color: White

Hardware Finish: Brushed Nickel

Features: Stacked Door Transoms

ARCHITECTURAL SERVICES

Weather Shield's architectural team is here to help you solve your design challenges. Whether you're dealing with the requirements of an historic renovation, designing a one-of-a-kind configuration or facing stringent structural or thermal demands, we're ready, willing and able to help you get it right.

Weather Shield Products are Ideally Suited for Several Commercial Project Types

- Educational Facilities
- Office Buildings
- Retail Buildings
- Restaurants
- Hotels/Resorts
- Recreational Facilities
- Religious Facilities
- Municipal Buildings
- Government Facilities
- Assisted Living
- Senior Housing
- Adaptive Re-use
- Historic Projects
- Multi-Family

Build it Right. Stand Behind It.

We design and manufacture stunning windows and doors that perform to the highest standards. Energy efficiency at every stage makes thermal performance only the beginning. Weather Shield offers sustainable production, energy efficient designs and glass coatings, LEED assistance for architects and builders.



Pre-Project Architectural Consultation Services

- Specification writing
- Assistance with product selection
- Custom product design consultation
- Code Compliance assessment
- Test Reports
- LEED Assistancess
- Samples and submittals
- Complete project management

Architectural Tools

- Detailed 2D CAD Library
- 3D Revit Models/BIM Library
- Rapid prototyping/solid modeling
- AIA continuing education programs



Starting Your Next Project

To contact a specialist in our architectural consultation group, call **1-800-538-8836**.

Business hours are 8:00 am - 5:00 pm CST, Monday - Friday.

Or email archservices@weathershield.com.

For drawing and technical information and to find a dealer in your area visit weathershield.com.



PREMIUM COASTAL

WEATHER SHIELD.
WINDOWS & DOORS

800.222.2995
weathershield.com