

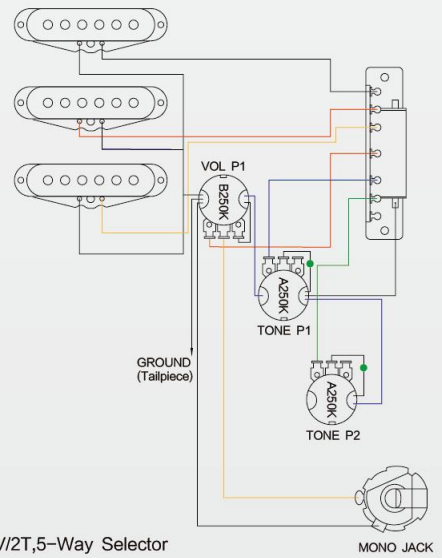

**12ST STYLE**  
**ASSEMBLY DIAGRAM**



S-S-S, 1V/2T, 5-Way Selector

MONO JACK



**YOU NEED A SCREWDRIVER**



**YOU NEED A WRENCH**



**YOU NEED TO USE WIRE CUTTERS**



**PAY ATTENTION TO ASSEMBLING**





A



B



C

D

E

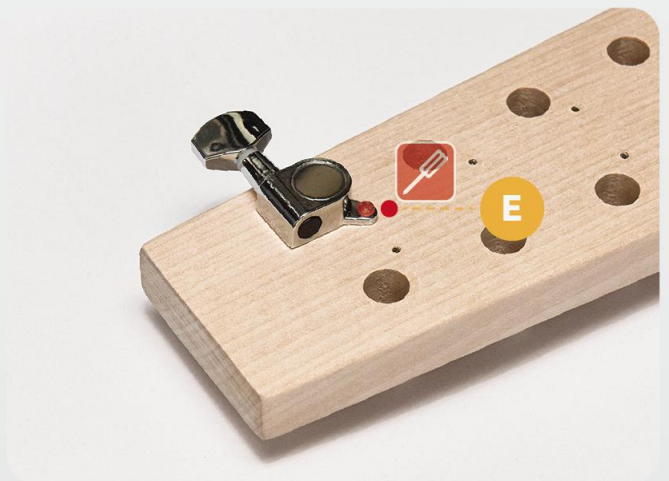
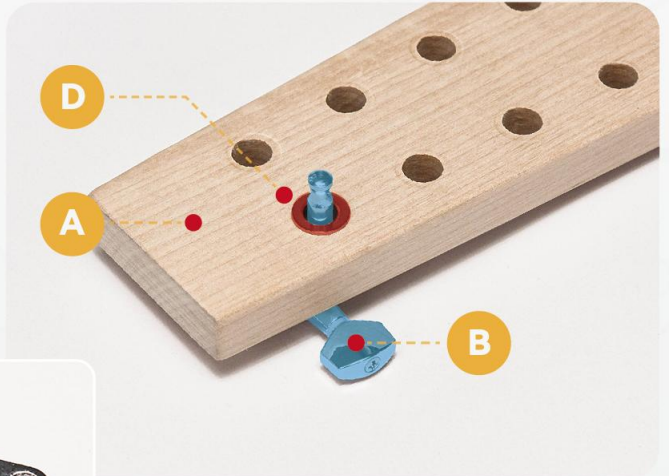

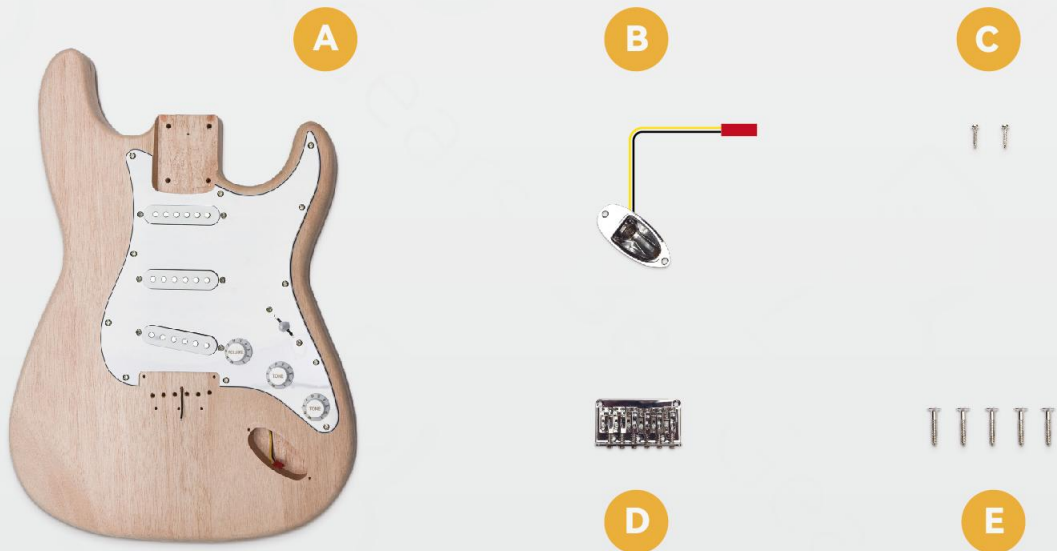

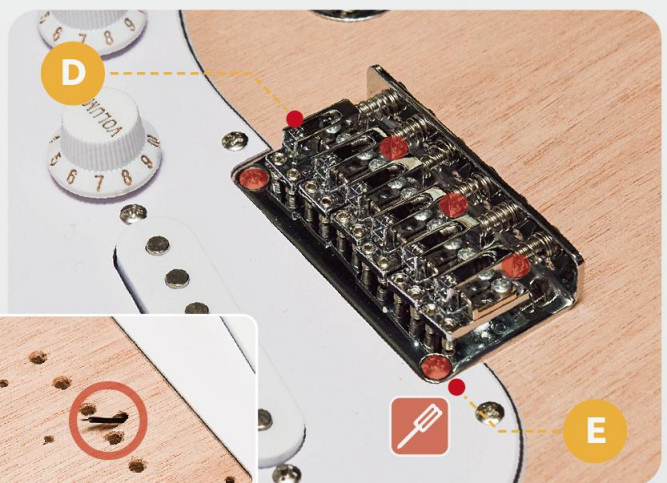
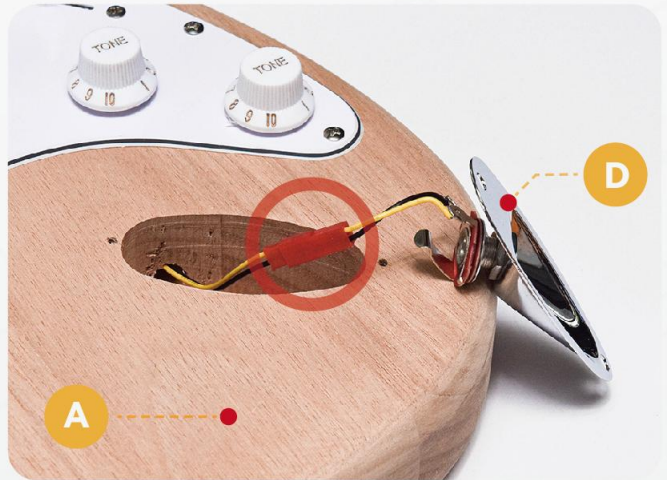

**Ground wire**



A



B



C



D



E





C



D



E

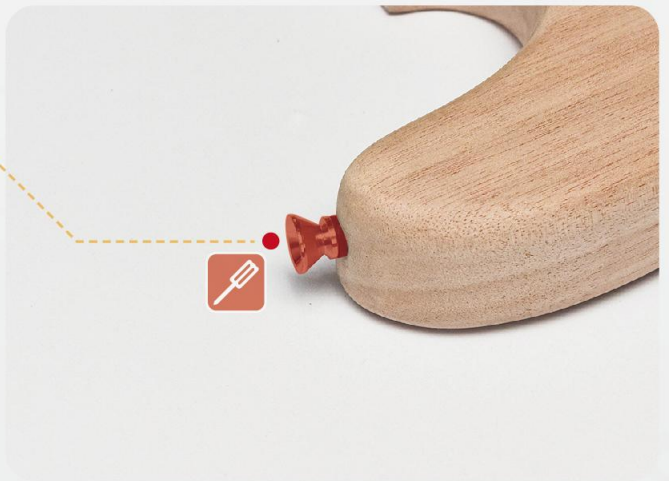
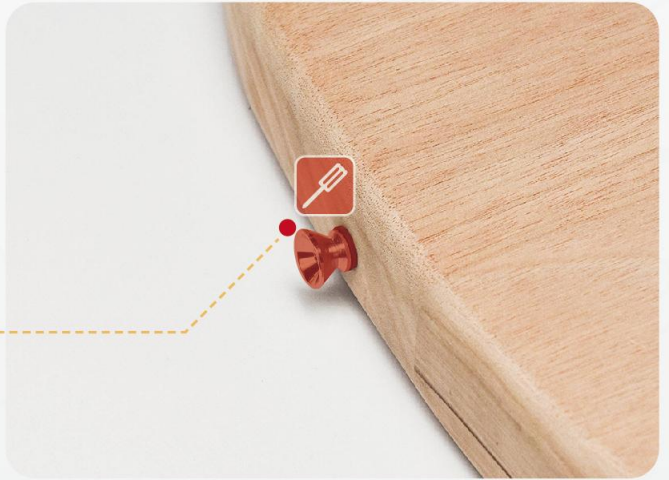

B

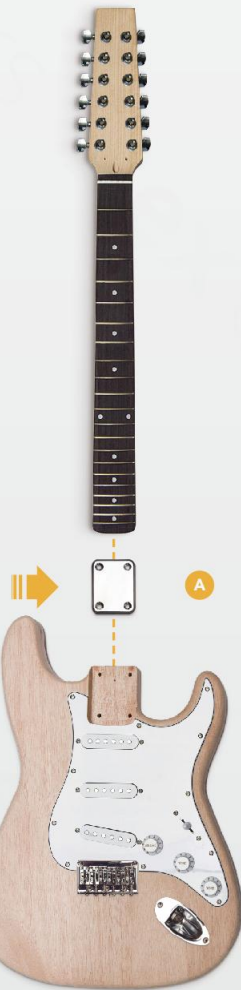

A

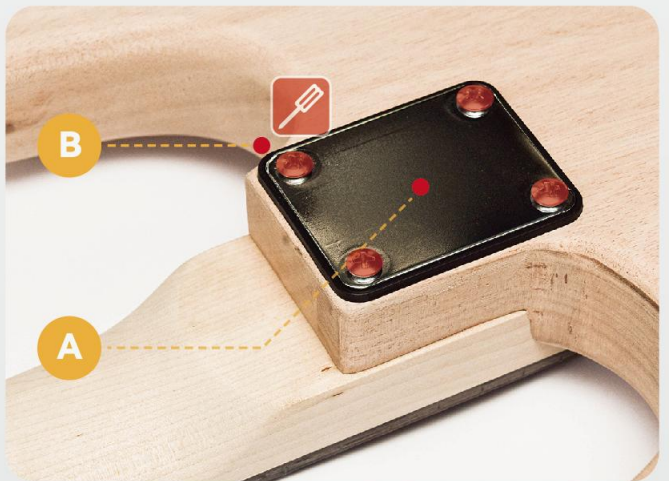

**THE THIRD STEP/STRAP BUTTON ASSEMBLY SEQUENCE**



A



B



C



D



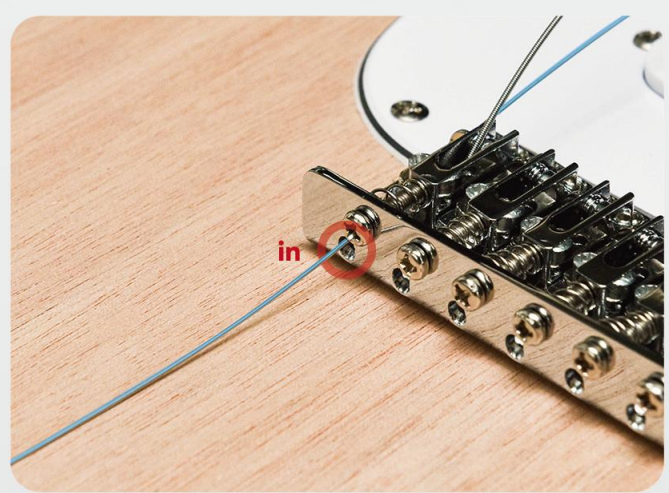
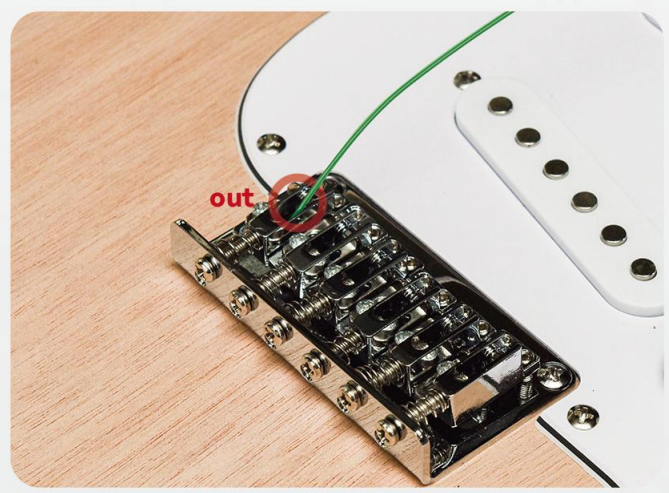
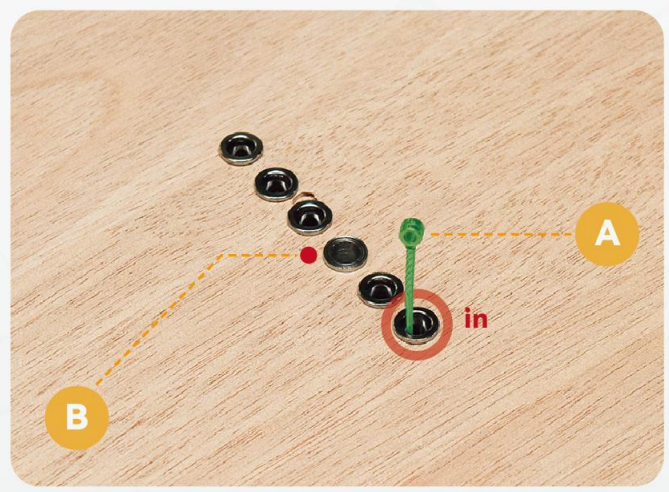

**THE FOURTH STEP/STRING TREE  
ASSEMBLY SEQUENCE 01**

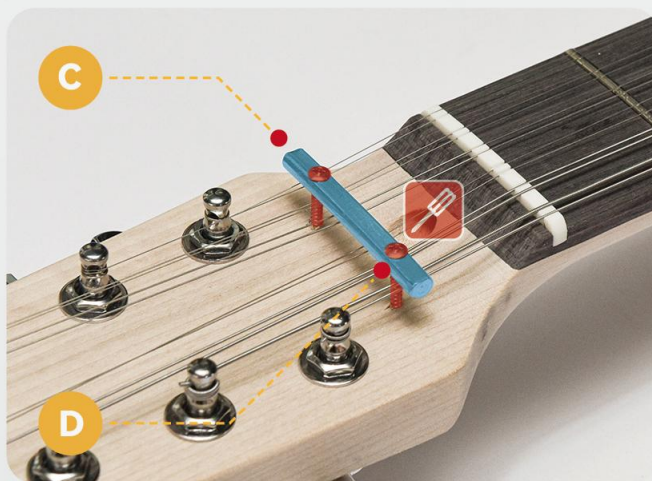
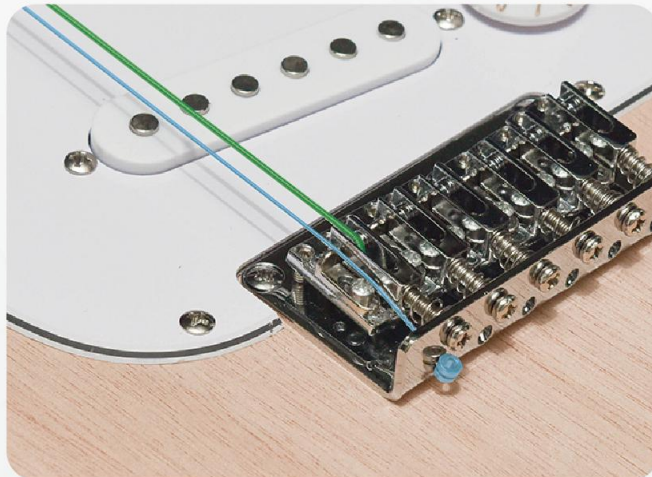





**Bex** Gears