

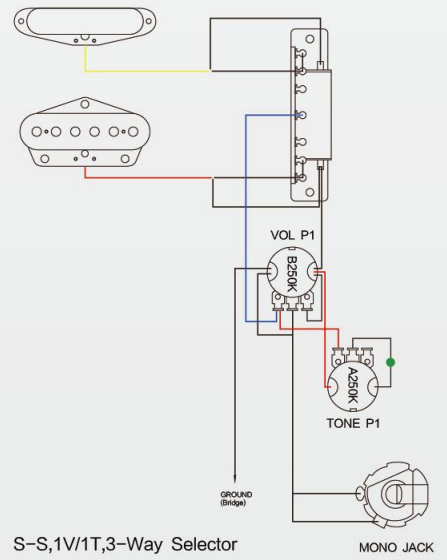

12TL STYLE
ASSEMBLY DIAGRAM



YOU NEED A SCREWDRIVER



YOU NEED A WRENCH



**YOU NEED TO USE
WIRE CUTTERS**



**PAY ATTENTION TO
ASSEMBLING**



**LIST OF ALL PARTS
SUGGESTED ASSEMBLY SEQUENCE**



A



B



C



D



E



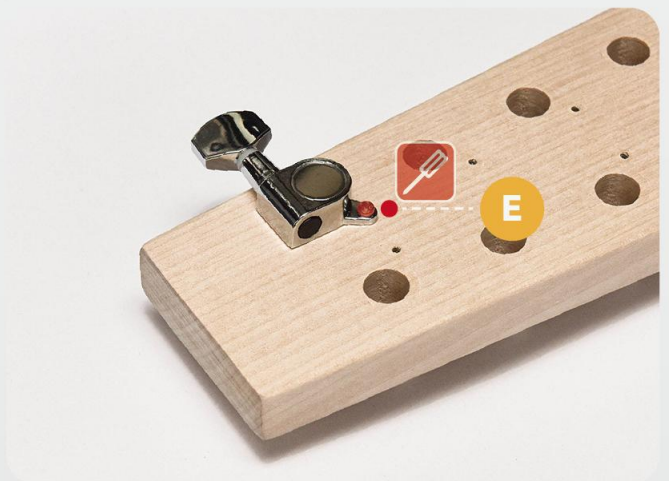
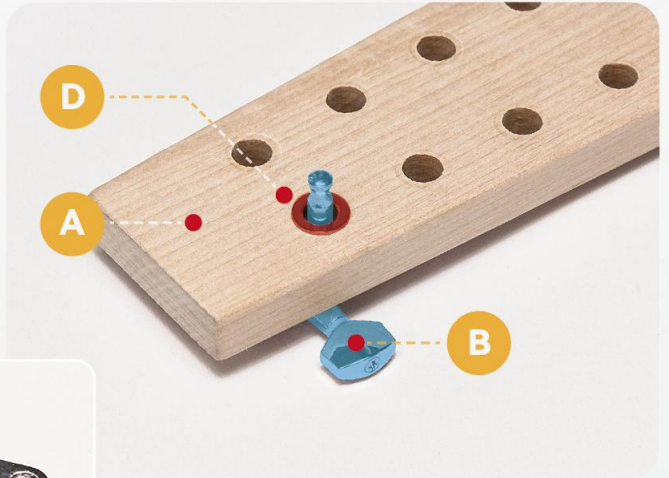
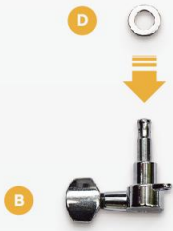

**THE FIRST STEP/ASSEMBLING OF TUNRES
ASSEMBLY SEQUENCE**

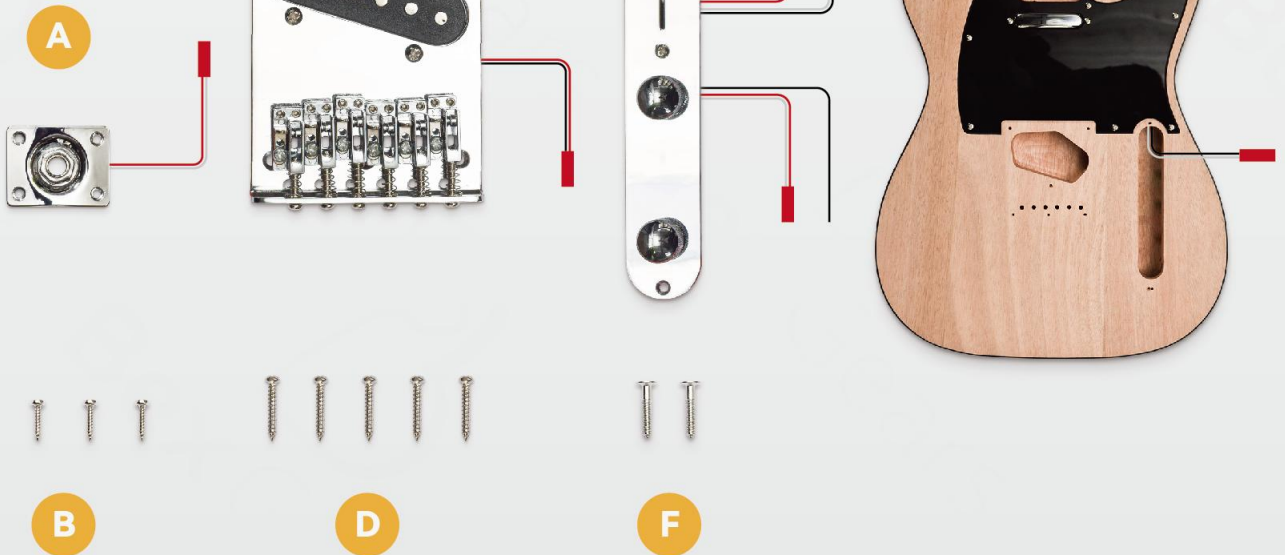

**THE SECOND STEP/WIRING AND BRIDGE PICKUP AND BRIDGE
LIST OF PARTS**



Wiring diagram

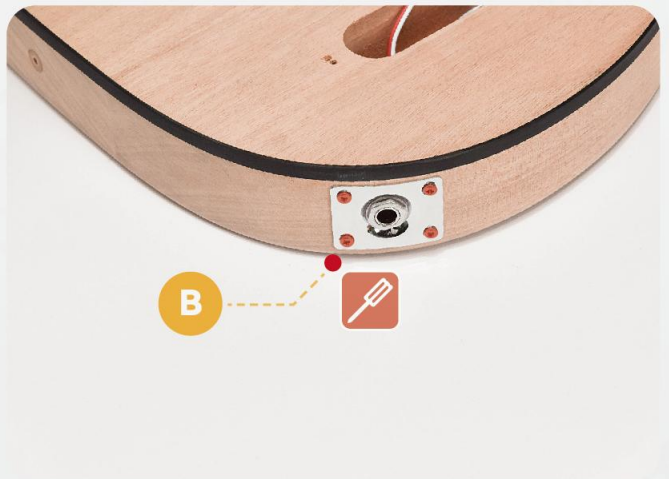
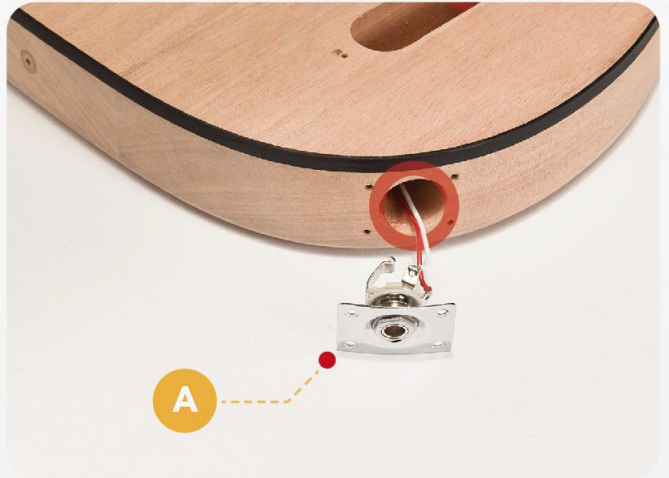

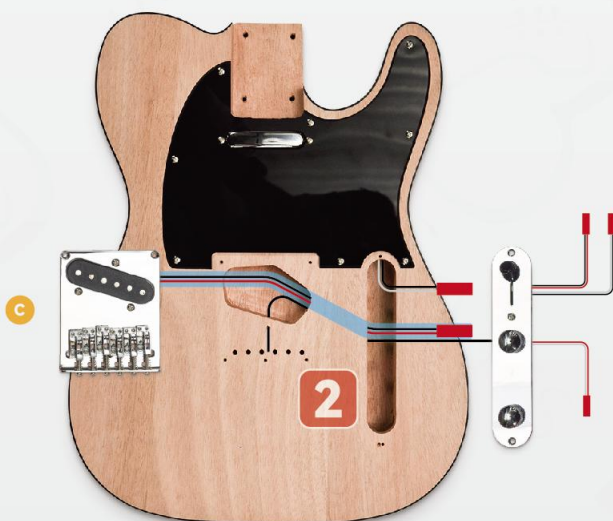
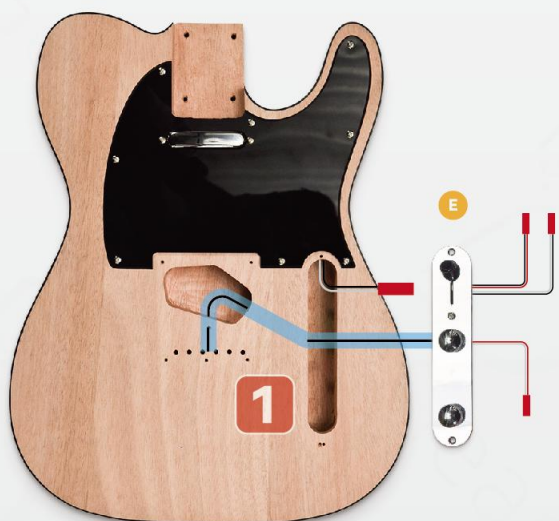

Wiring diagram



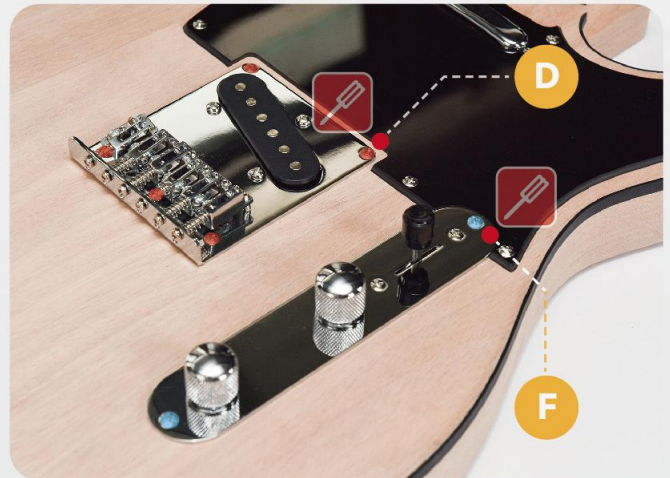
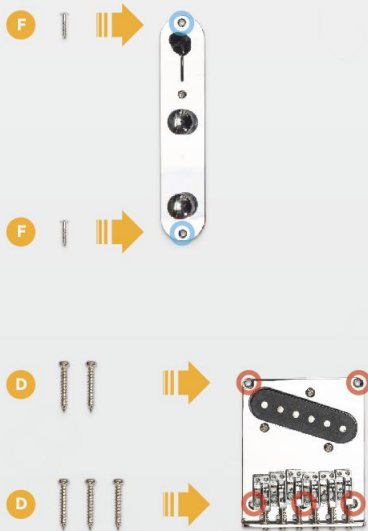
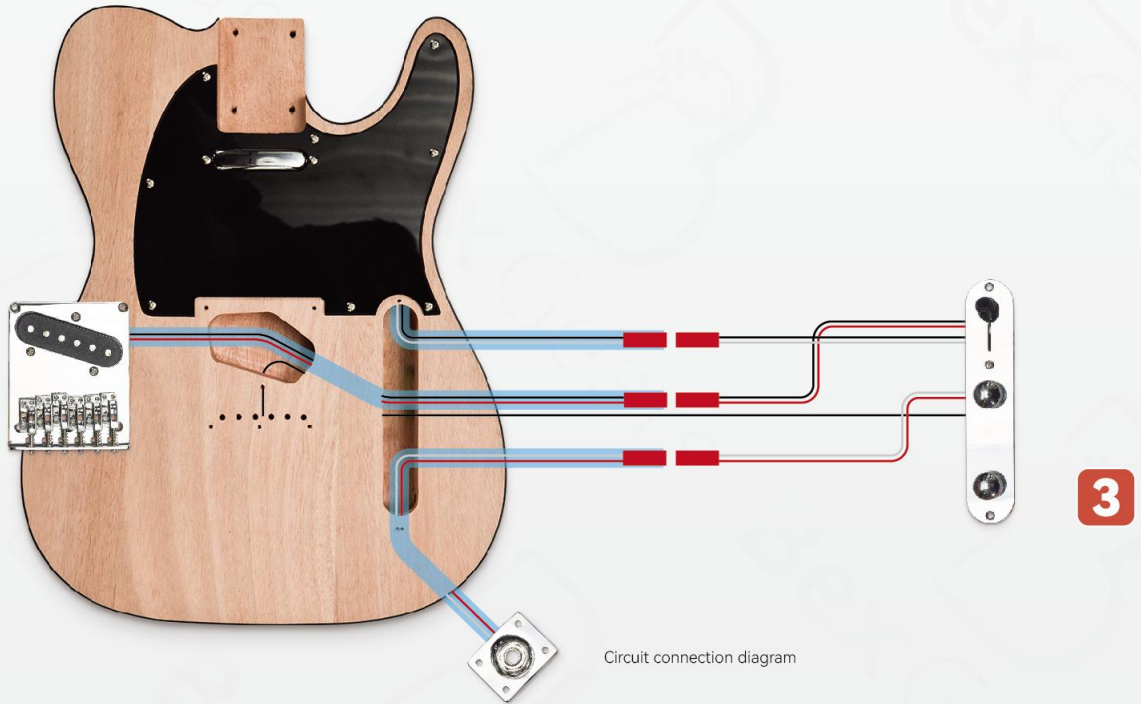



A



B



C



D



E



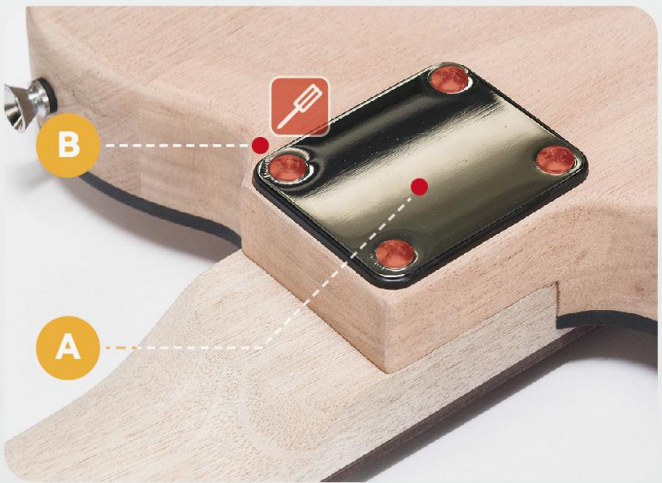
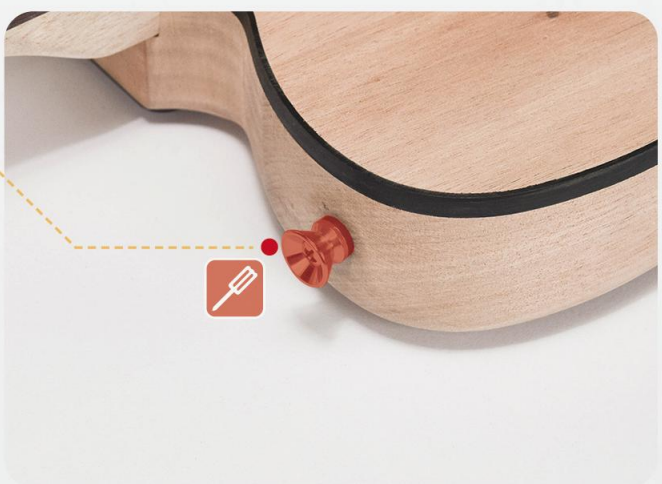
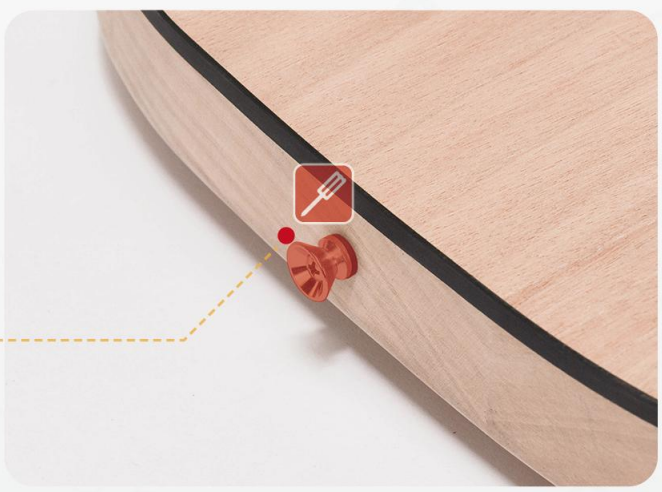
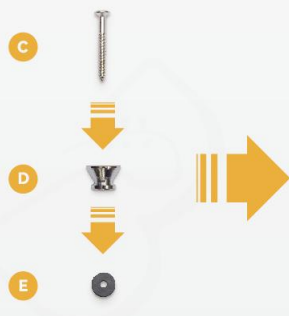

THE THIRD STEP/NECK PLATE AND STRAP BUTTON ASSEMBLY SEQUENCE



A



B



C



D



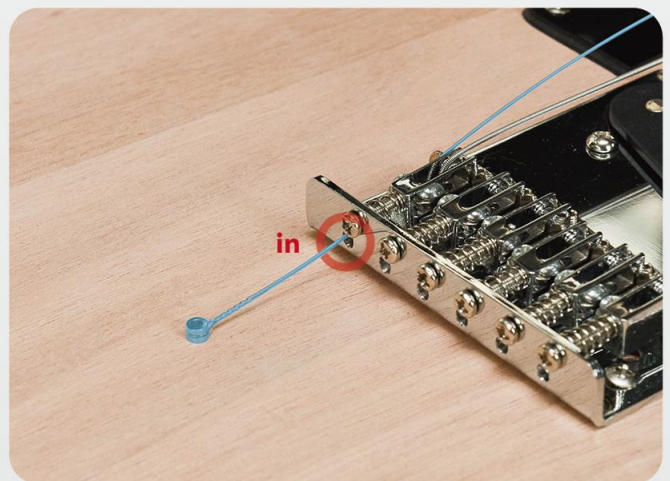
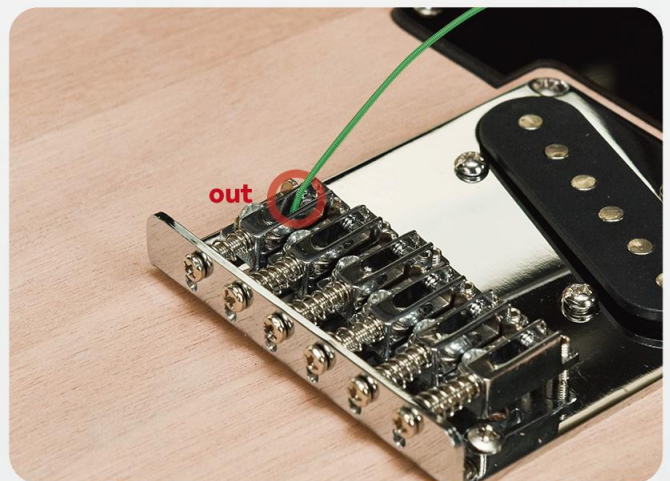
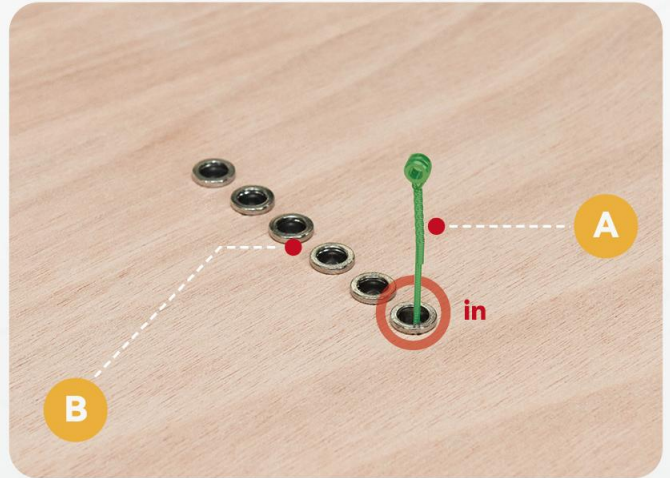

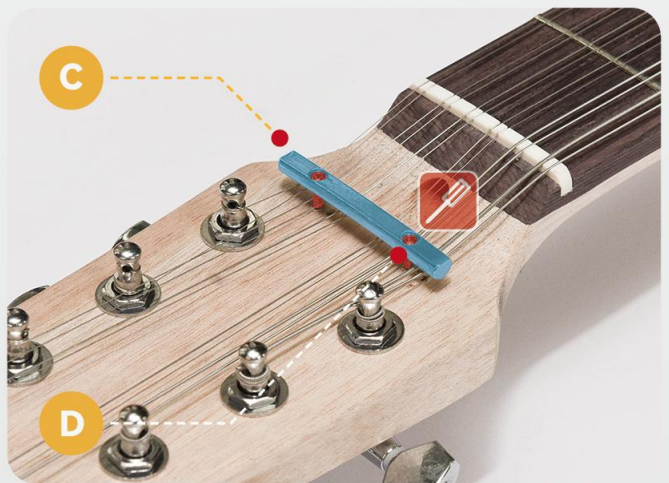
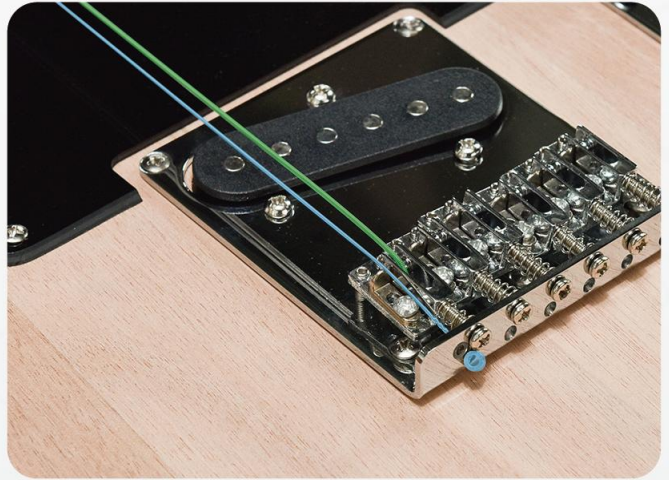





Bex Gears