

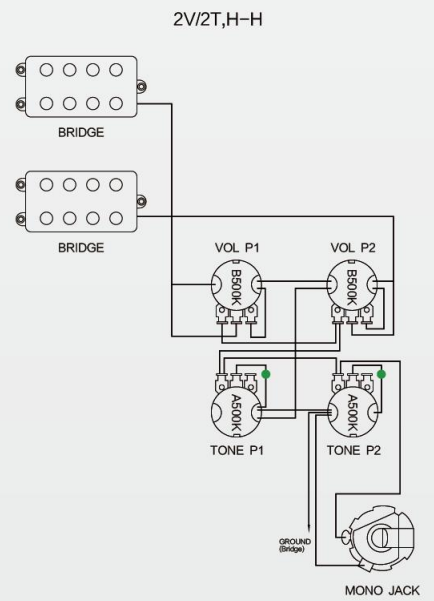

5 STRING BASS
ASSEMBLY DIAGRAM



YOU NEED A SCREWDRIVER



YOU NEED A WRENCH



**YOU NEED TO USE
WIRE CUTTERS**



**PAY ATTENTION TO
ASSEMBLING**





B



A



C



D



E



THE FIRST STEP/ASSEMBLING OF TUNRES
LIST OF PARTS

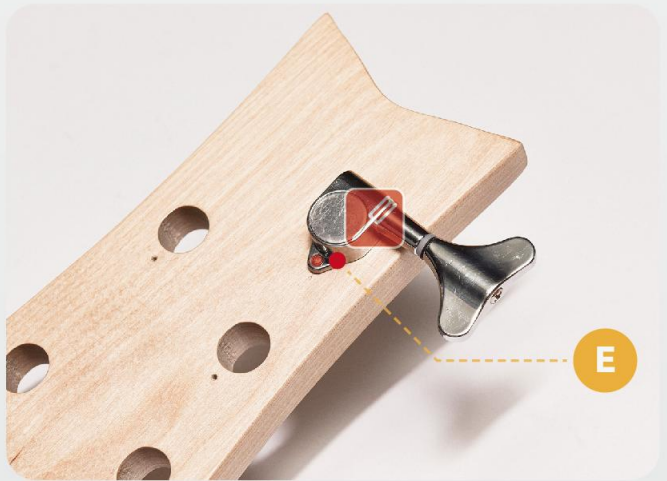
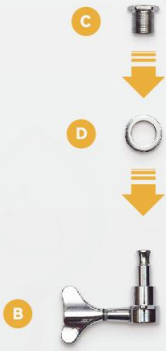
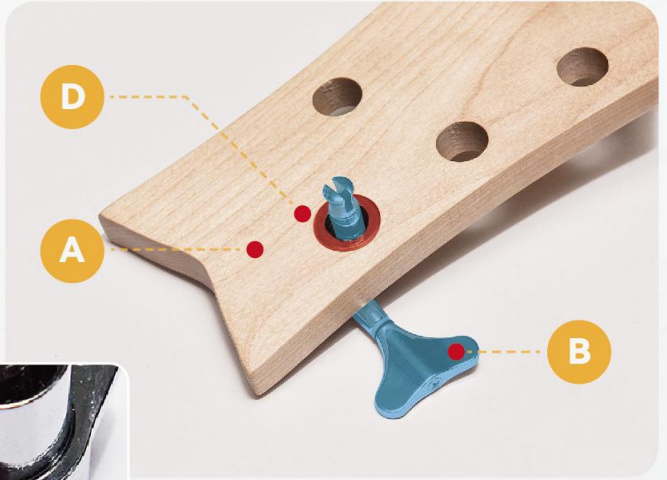

**THE FIRST STEP/ASSEMBLING OF TUNRES
ASSEMBLY SEQUENCE**

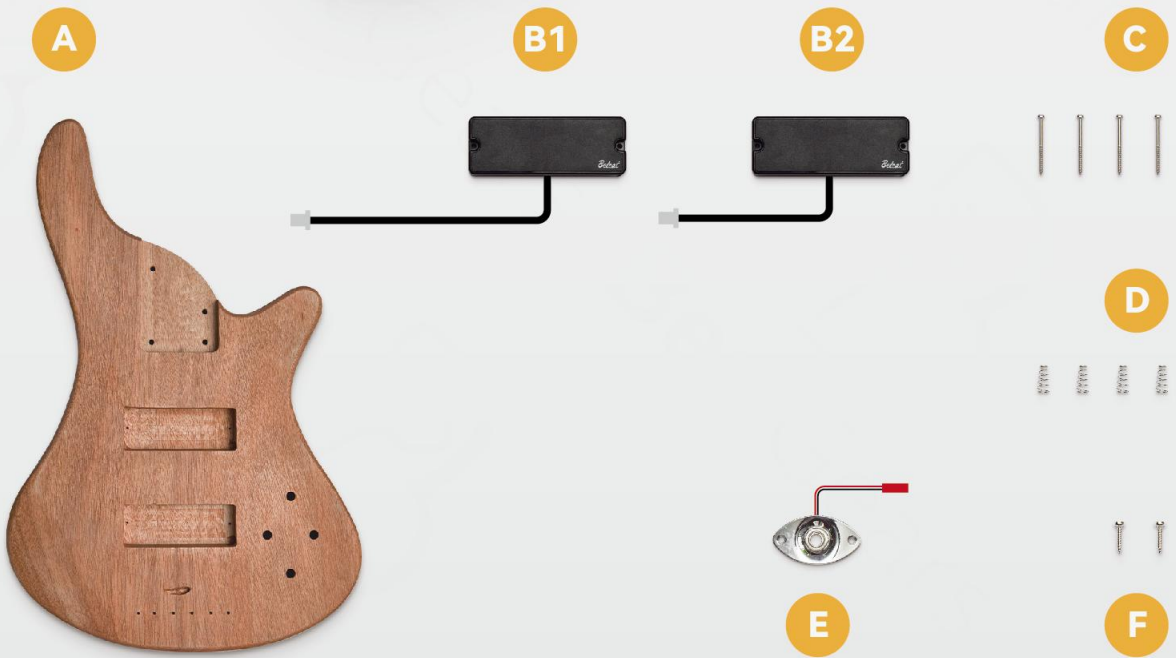

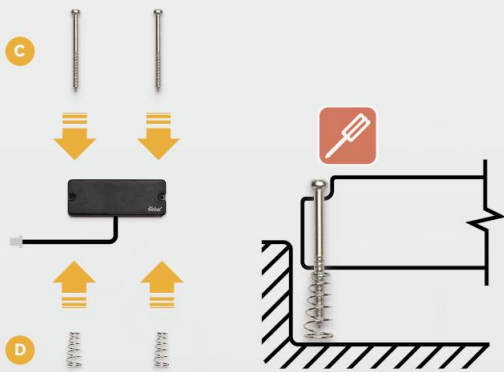
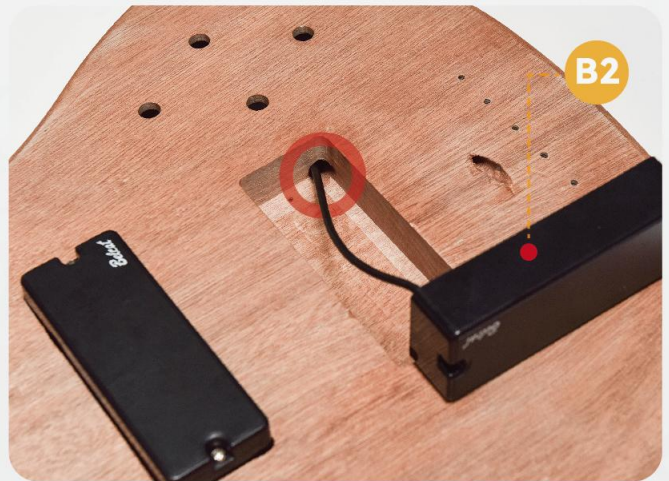
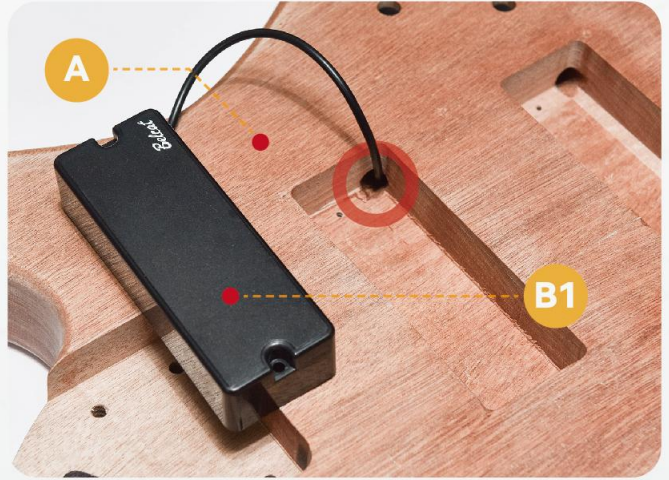

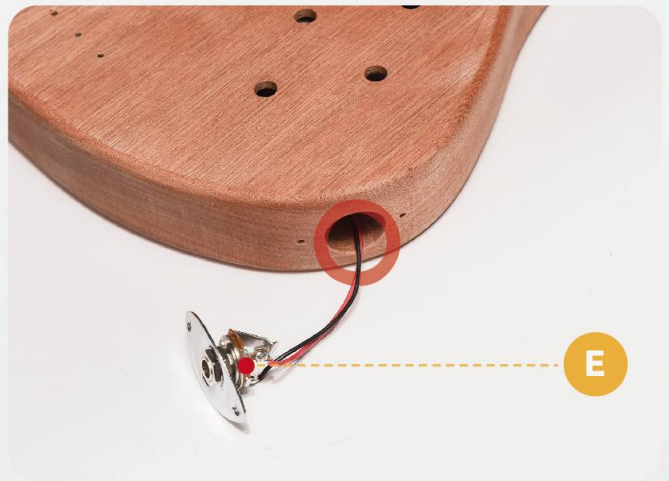

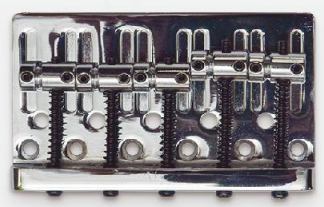
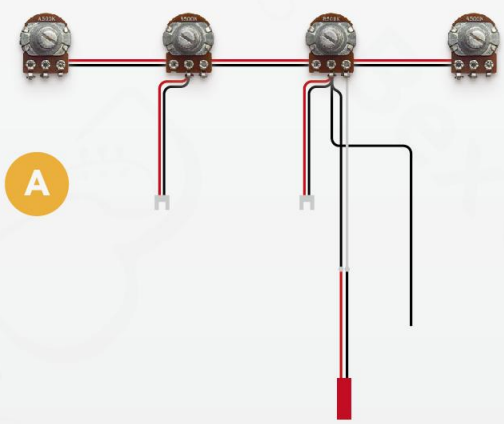

**THE THIRD STEP/WIRING
LIST OF PARTS**

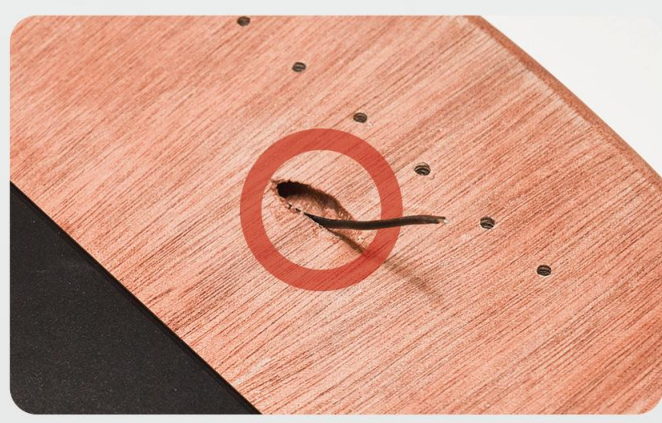
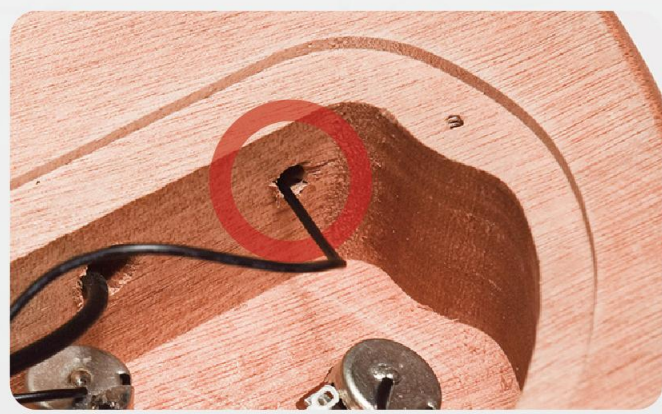
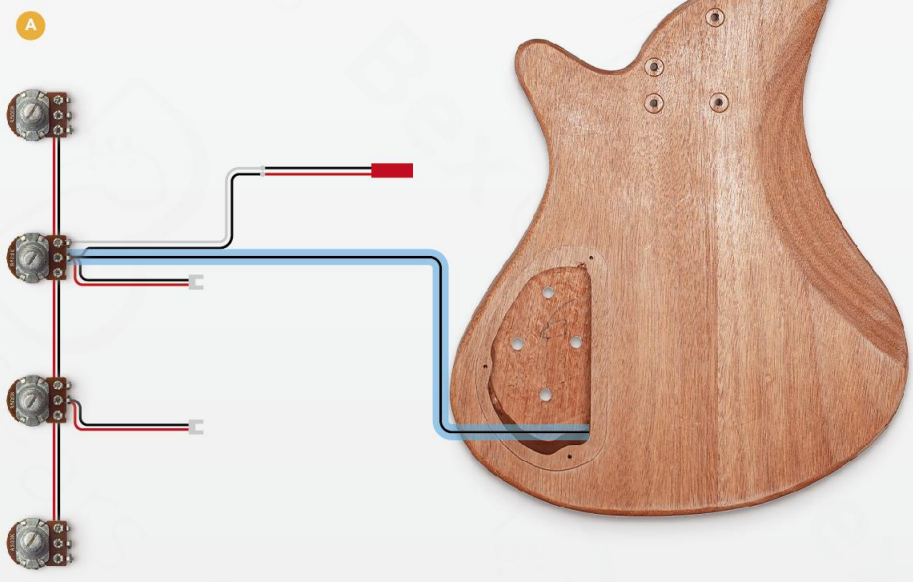

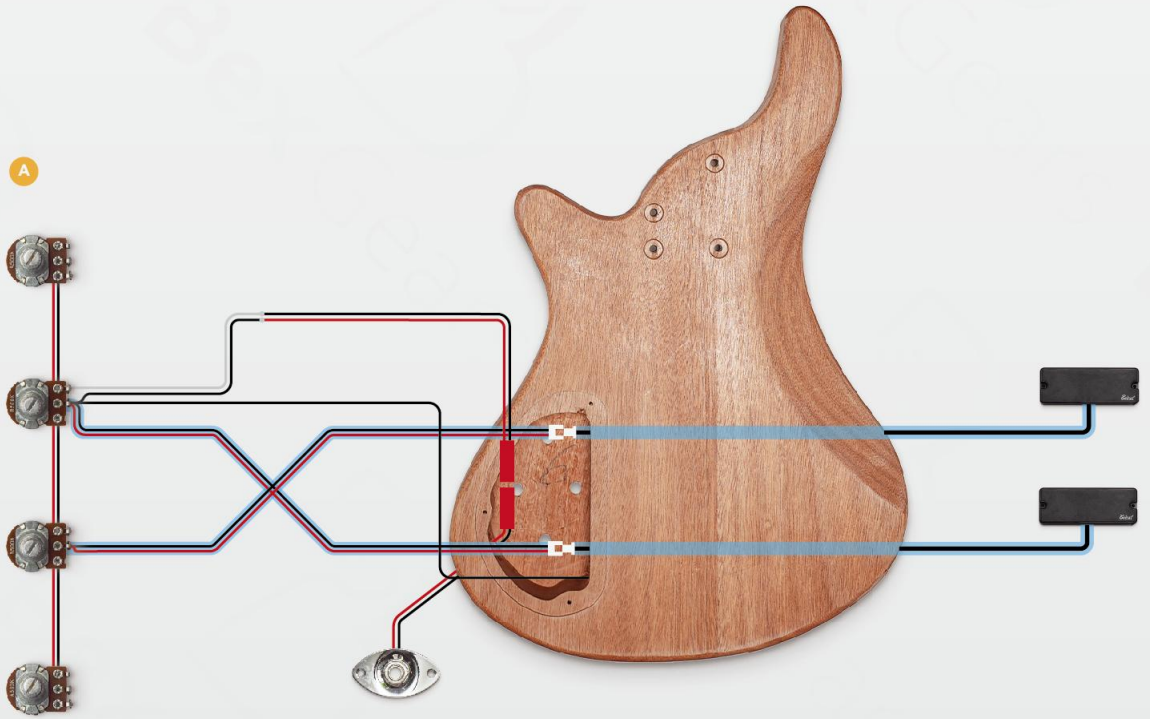
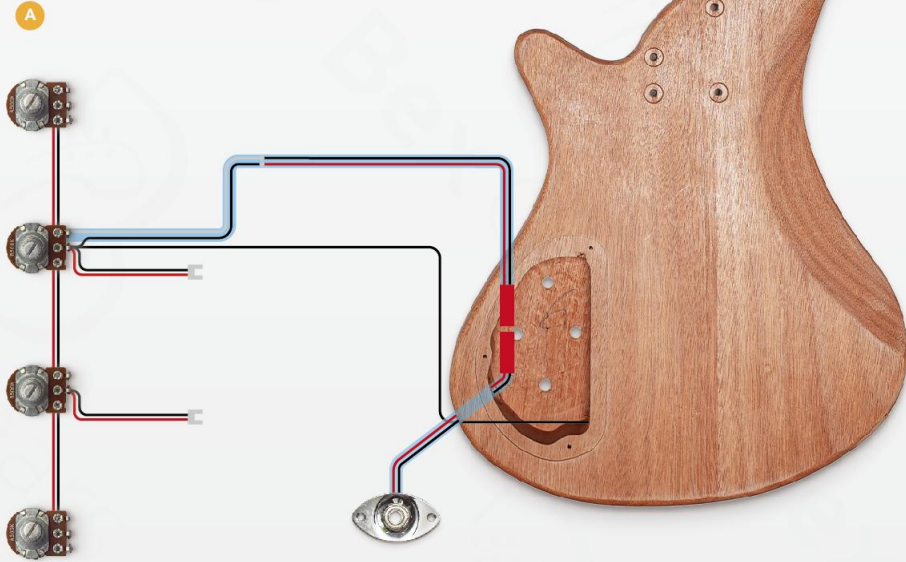

Wiring diagram

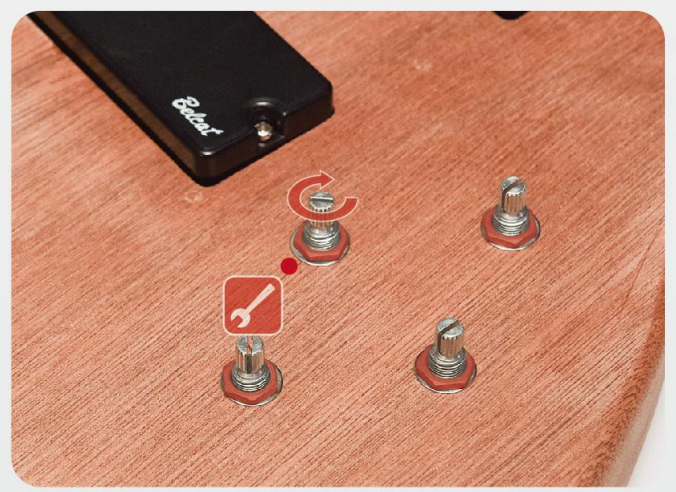
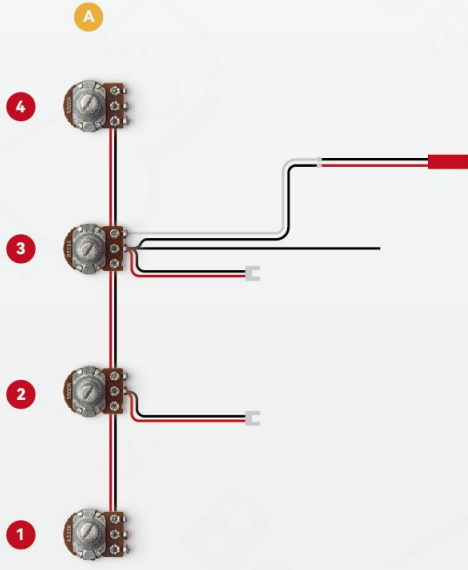

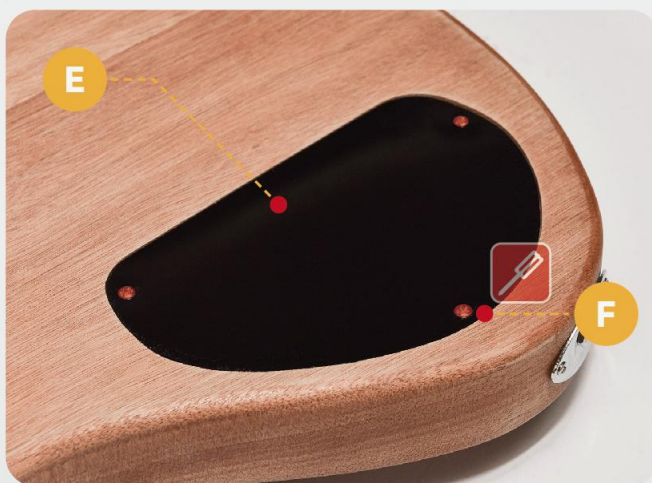
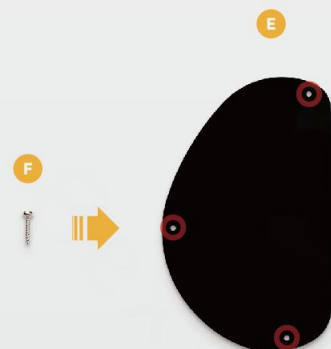
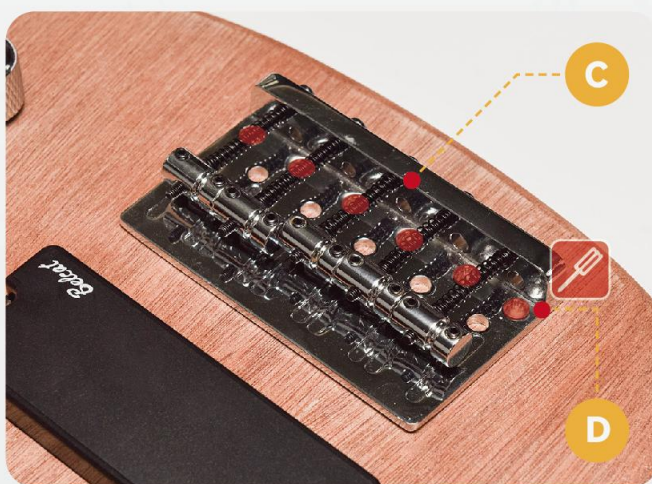
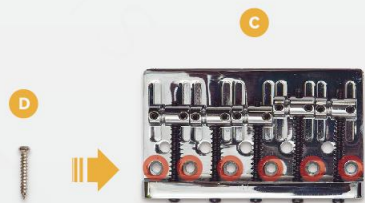



A



B



C



D



E



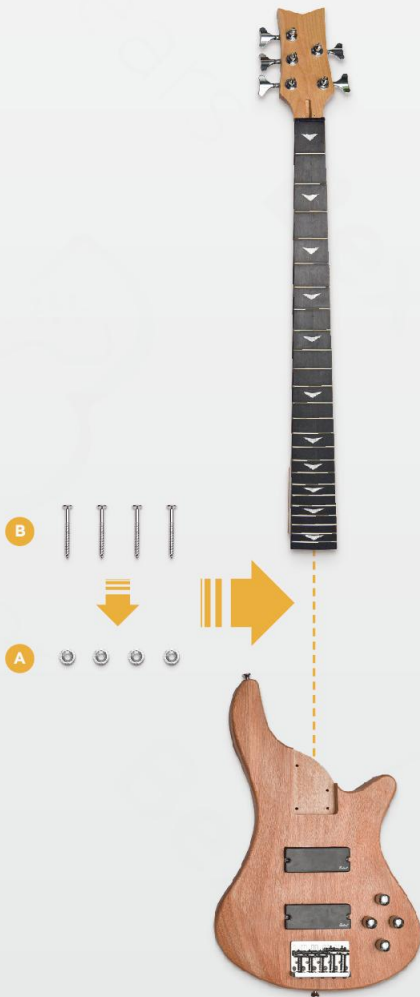
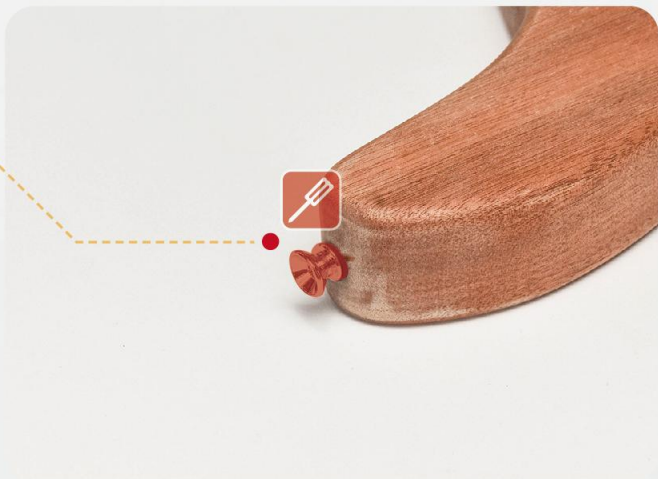
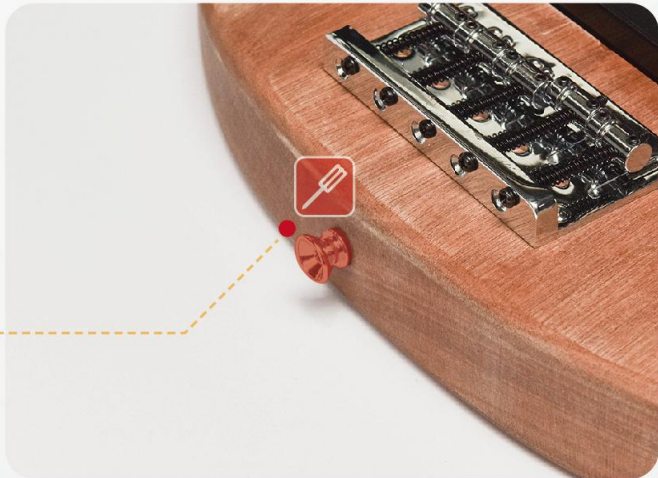
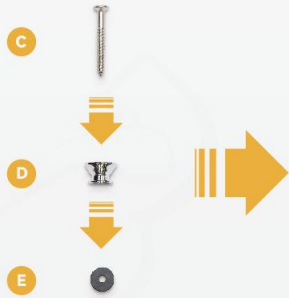

A



B



C



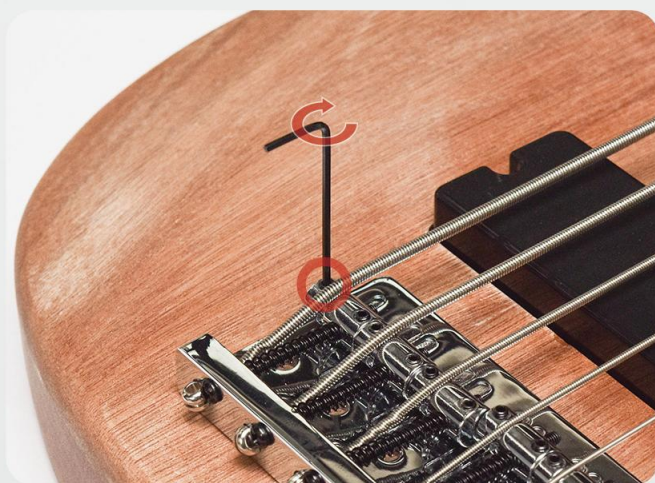
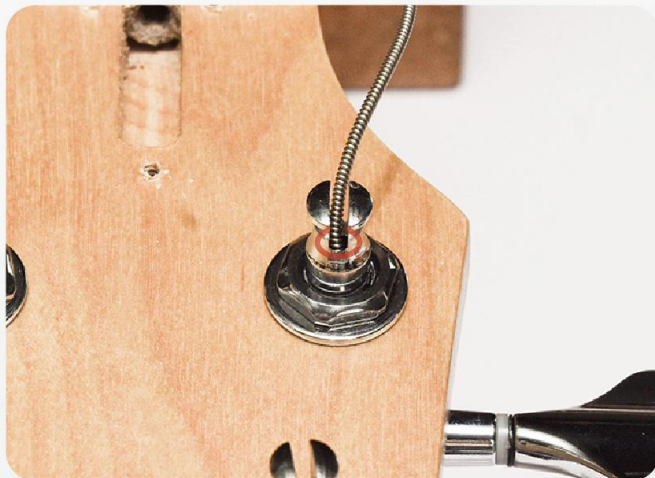

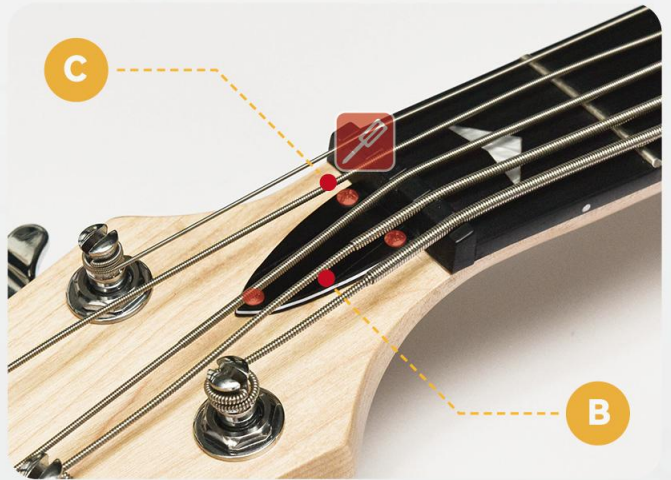
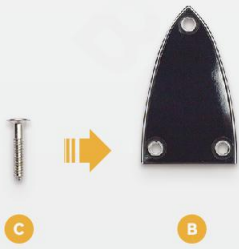



ENJOY



Bex Gears