

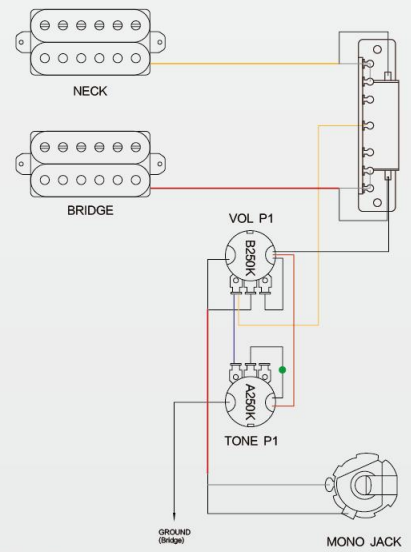

8S STYLE
ASSEMBLY DIAGRAM



H-H,1V/1T,3-Way Selector



YOU NEED A SCREWDRIVER



YOU NEED A WRENCH



**YOU NEED TO USE
WIRE CUTTERS**



**PAY ATTENTION TO
ASSEMBLING**

1



12



11



8



9



2

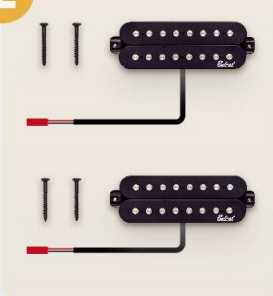

5



7



4

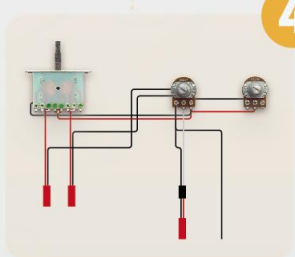

6

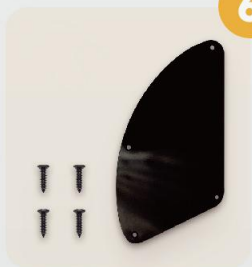

3



10



9



LIST OF ALL PARTS
SUGGESTED ASSEMBLY SEQUENCE



B



A



C

D

E

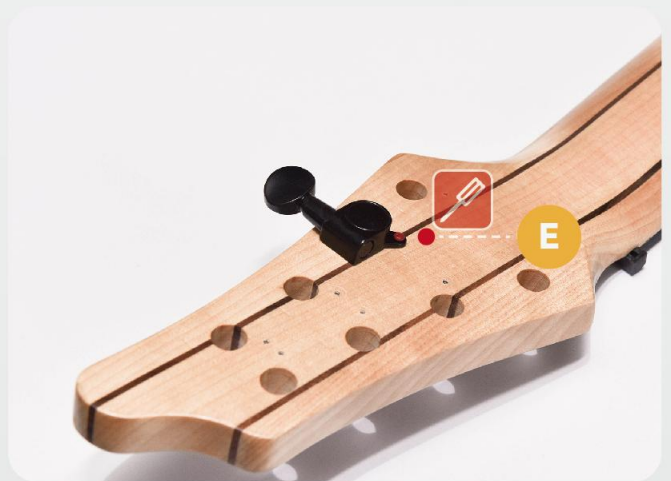
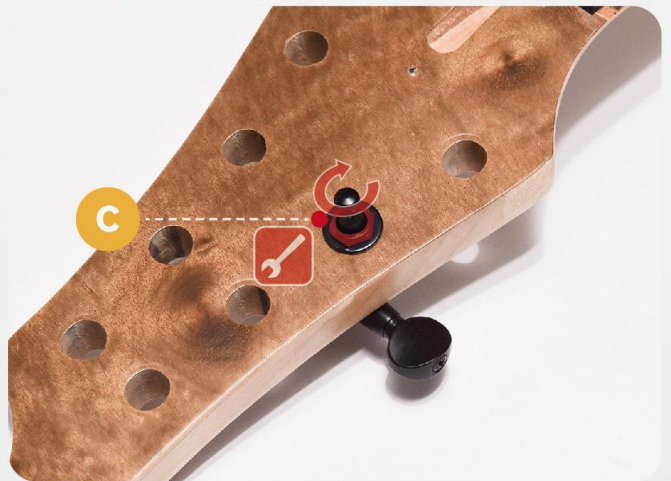
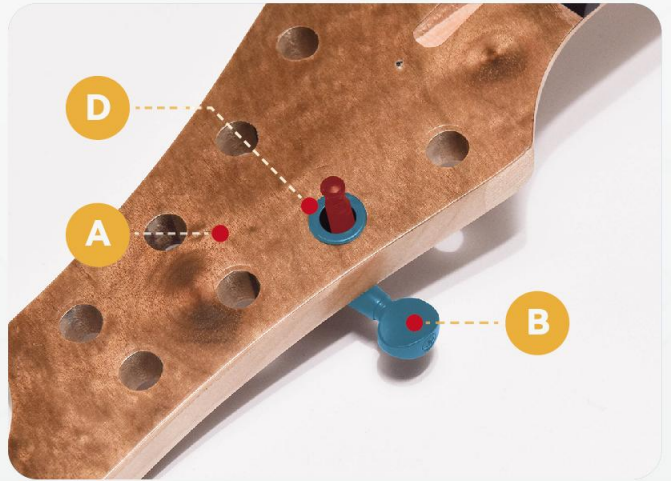



A



B



C



D



E



F



G



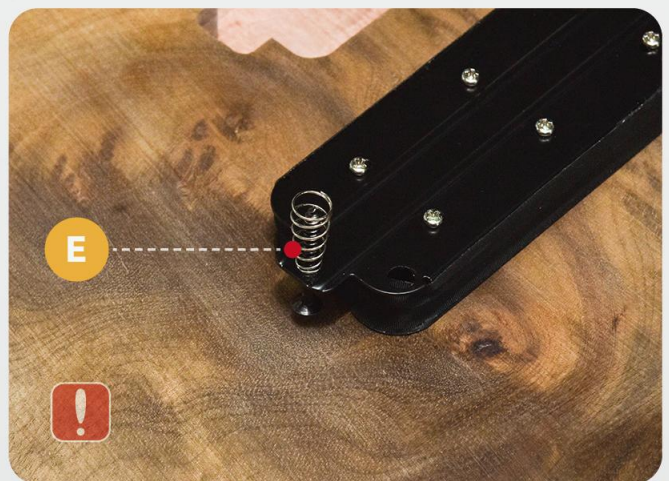
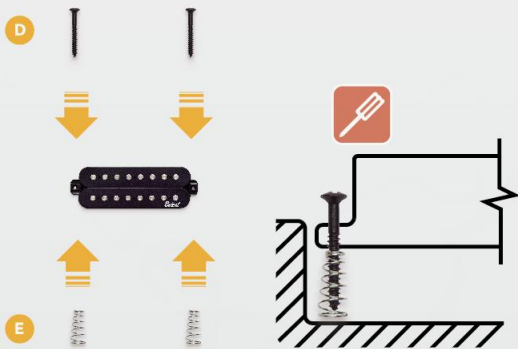
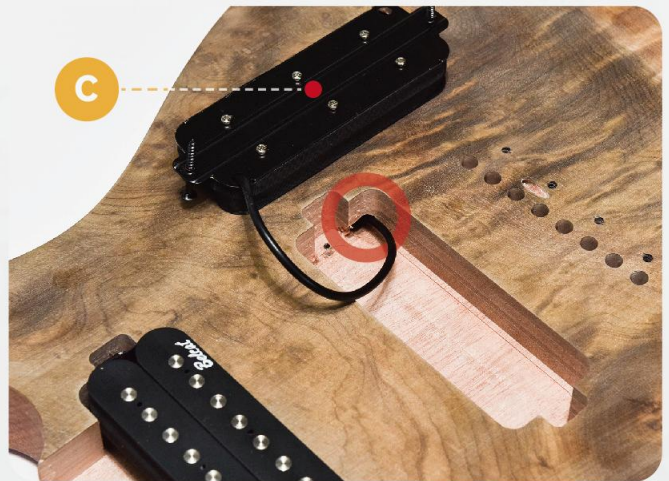
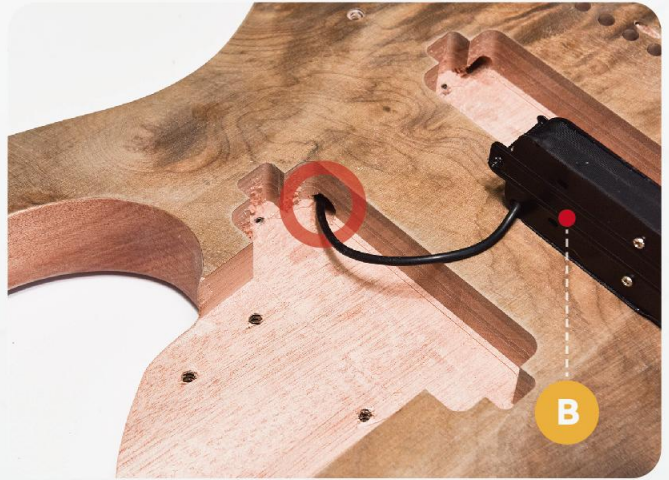
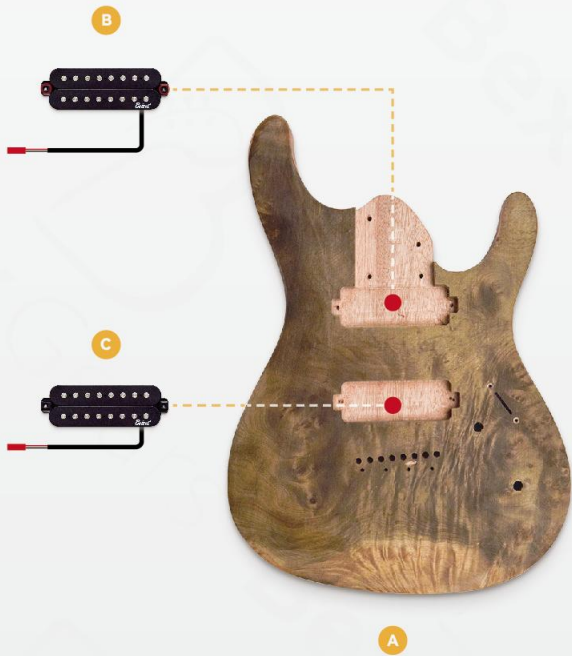

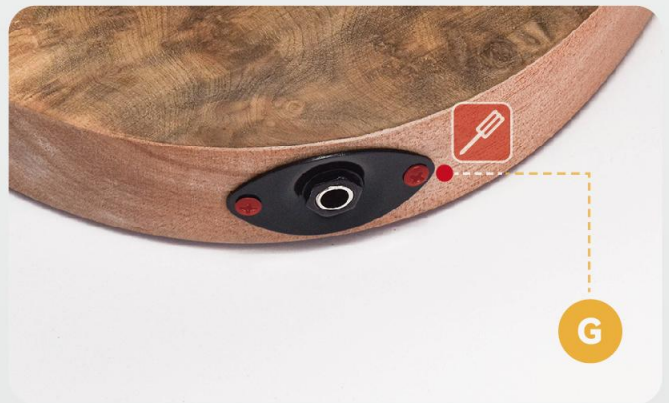
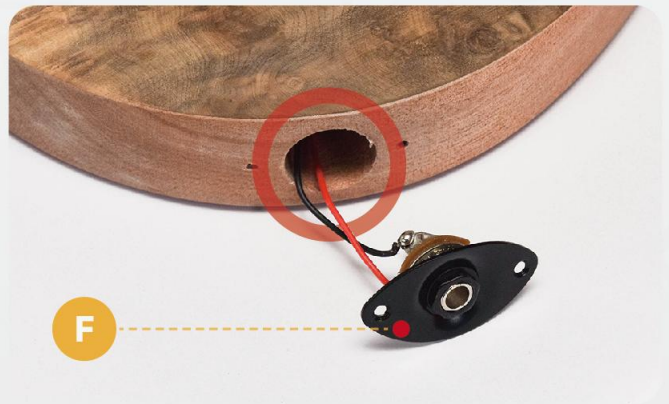



A

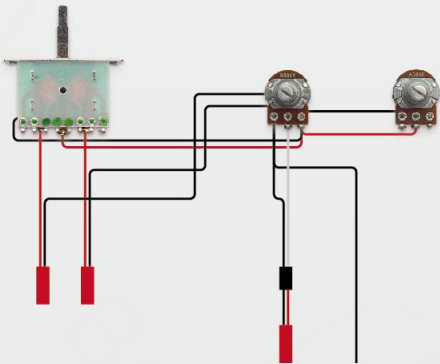

B



C



D



F



G



E



A

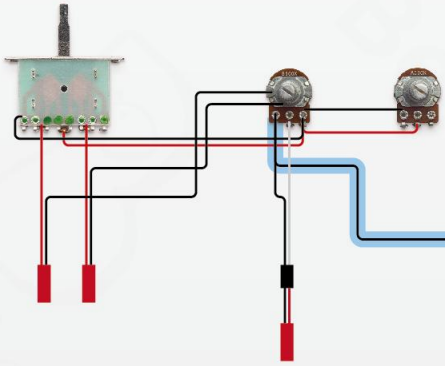

Wiring diagram

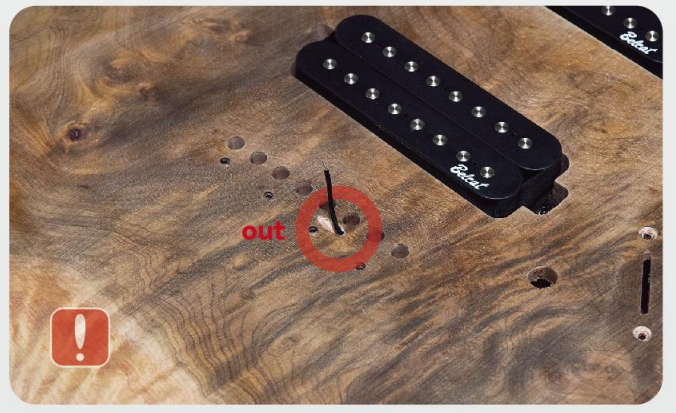
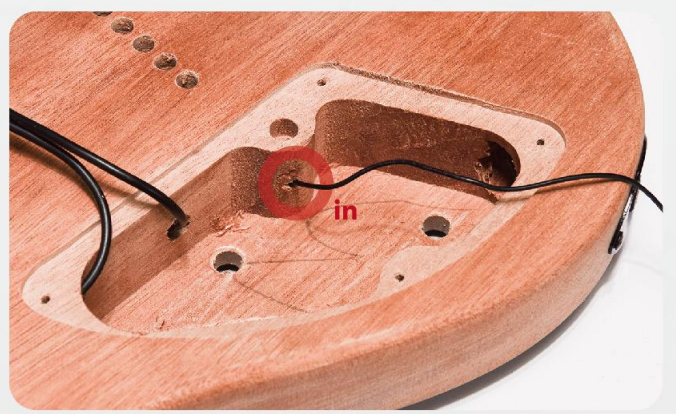

A

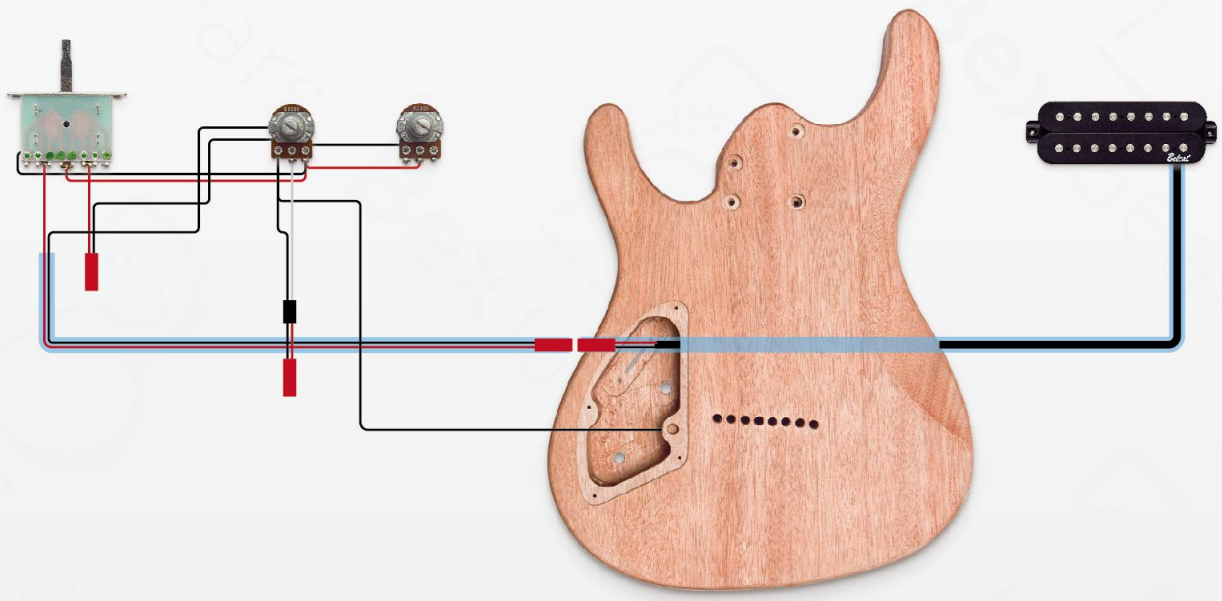

A

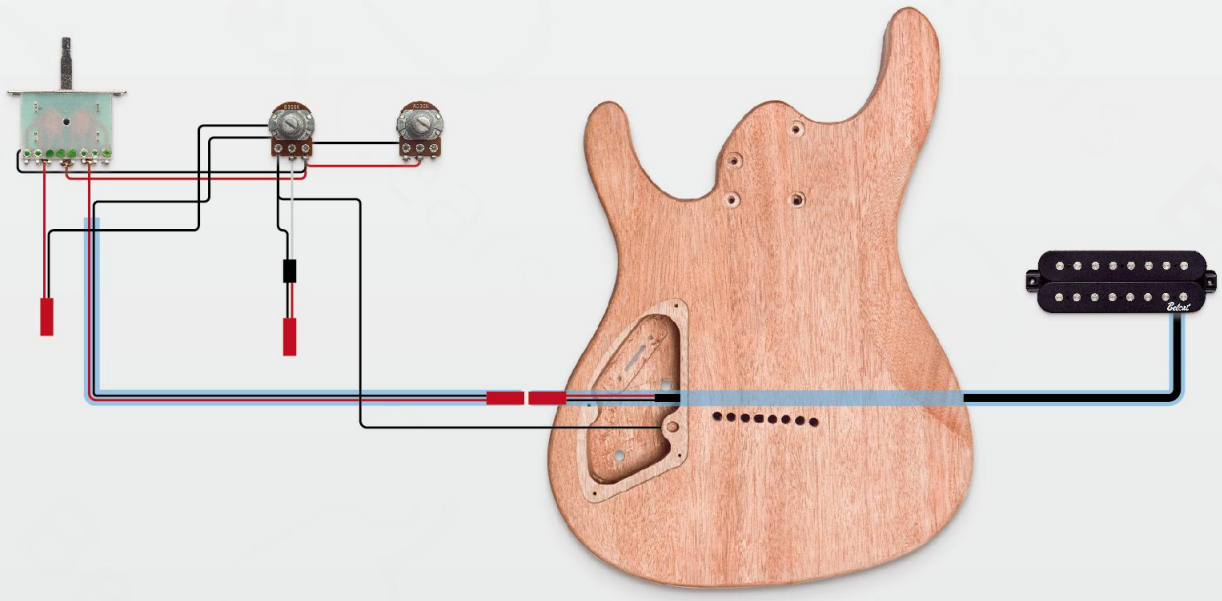

Wiring diagram

A

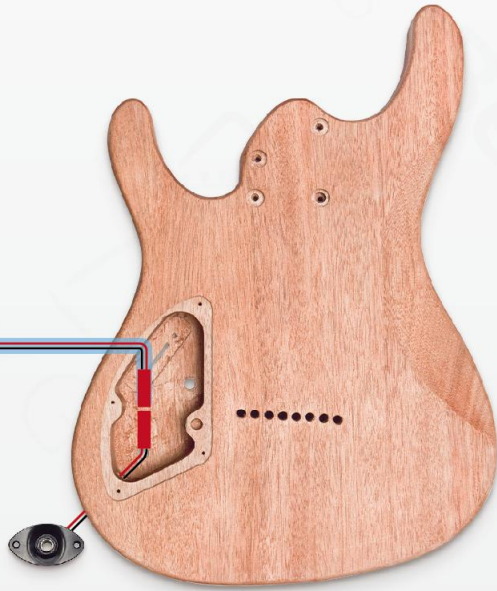
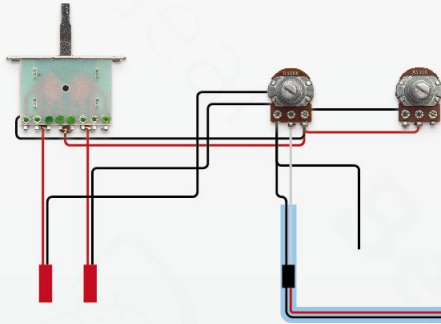

Wiring diagram

1

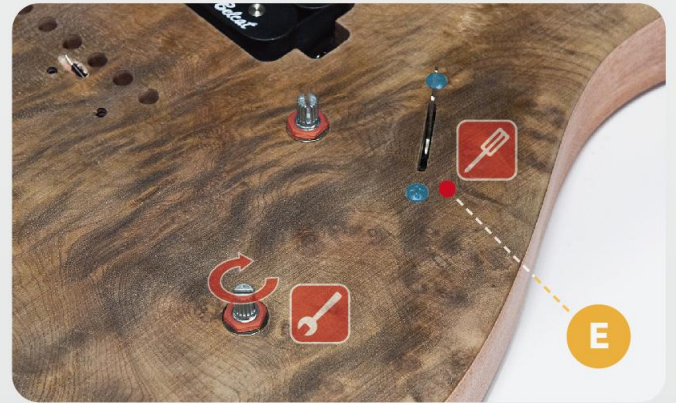
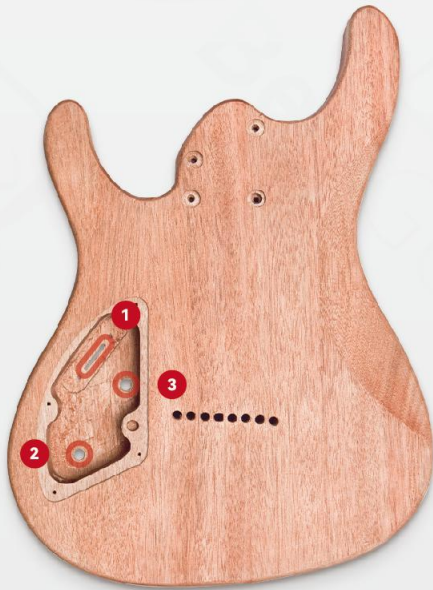
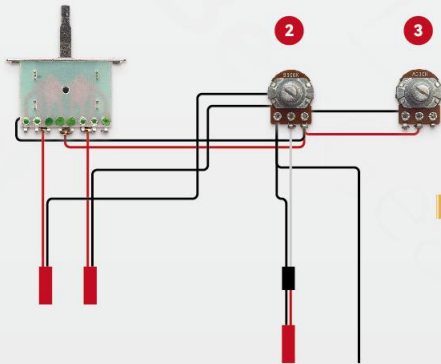

**THE THIRD STEP/WIRING
ASSEMBLY SEQUENCE 03**

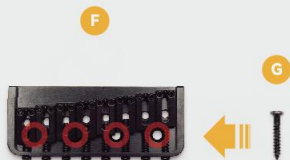
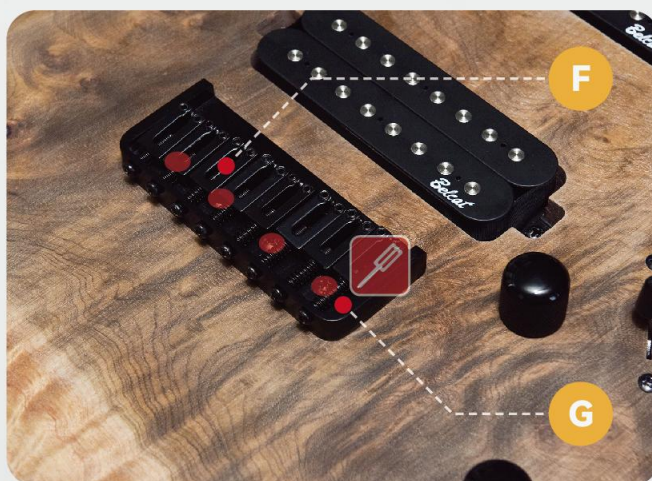
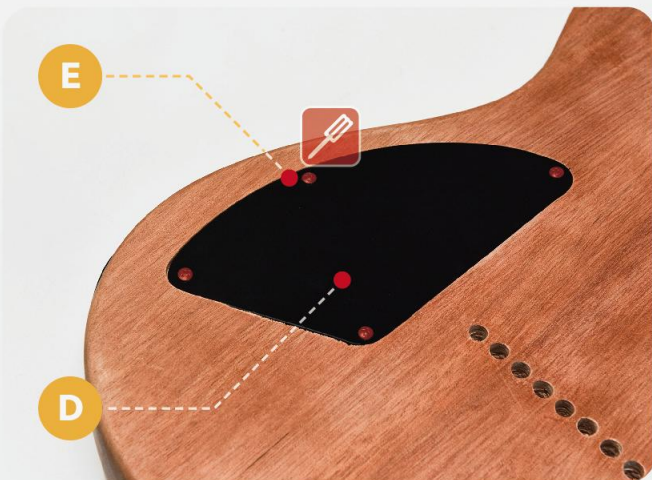
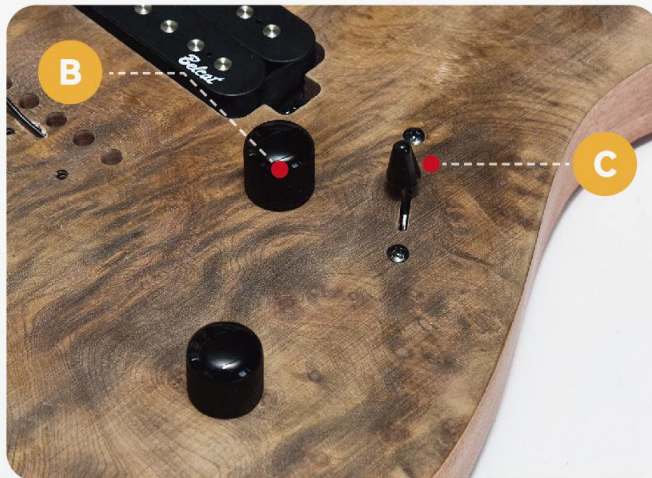



A



B



C



D



E



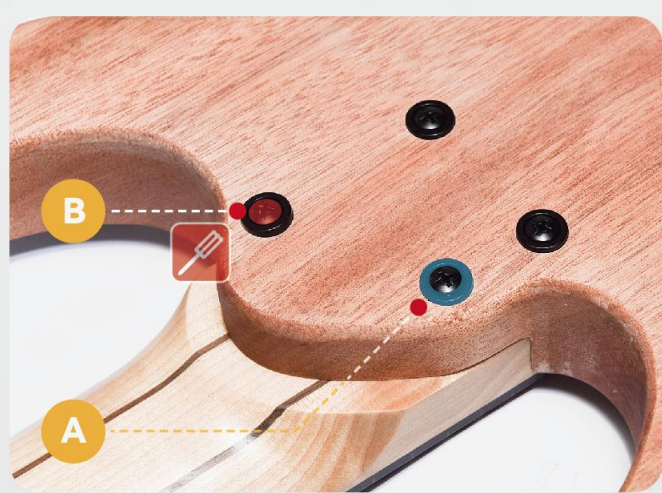
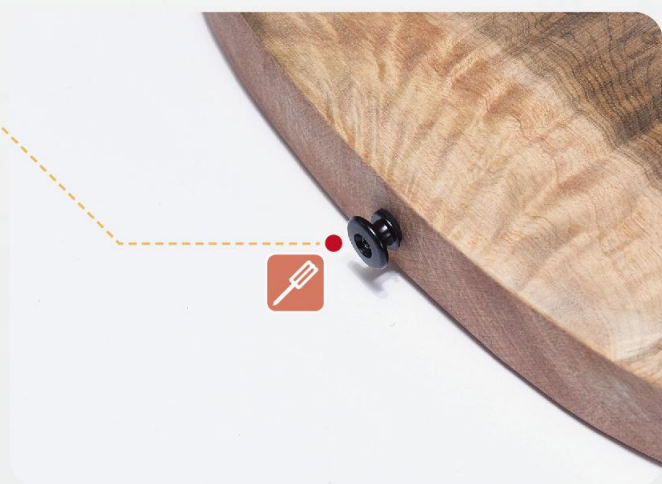
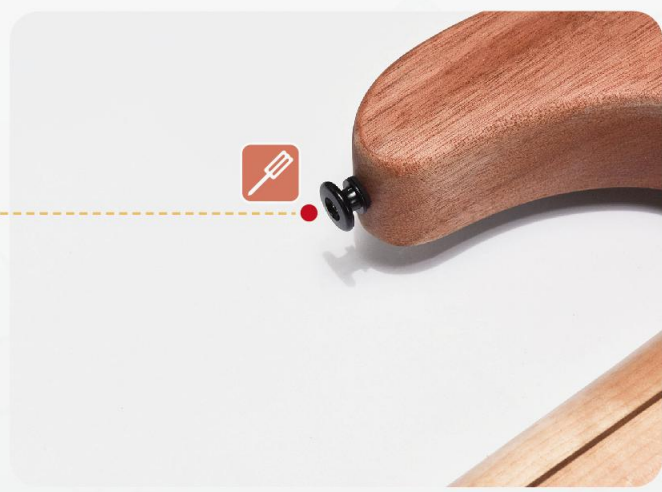
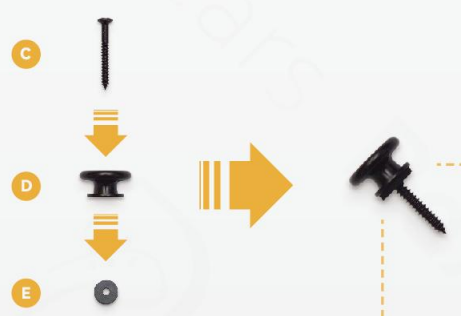
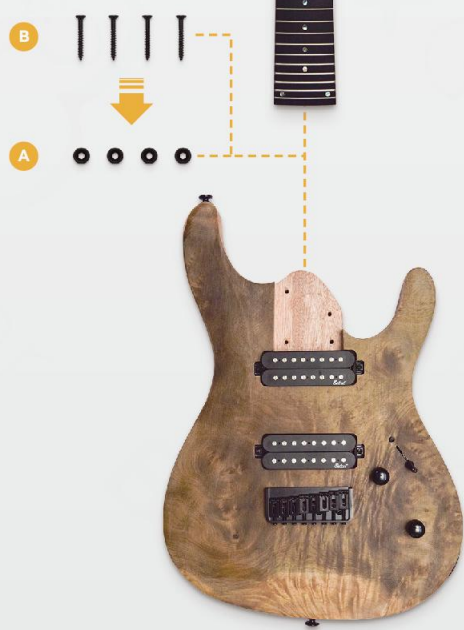

THE FIFTH STEP/STRAP BUTTON ASSEMBLY SEQUENCE



A



B



C



D



A



A

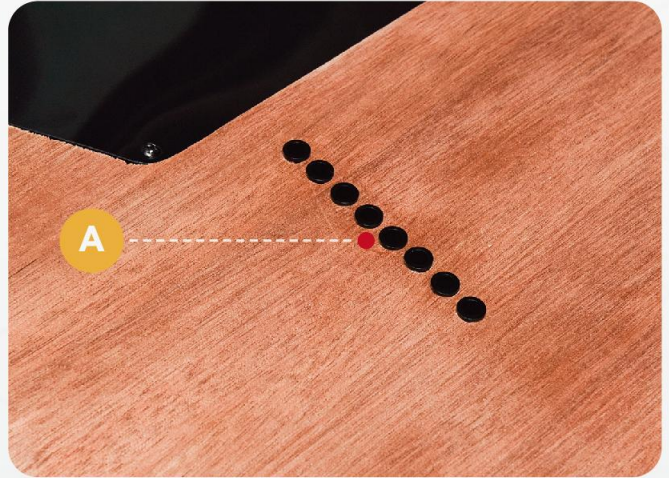

B

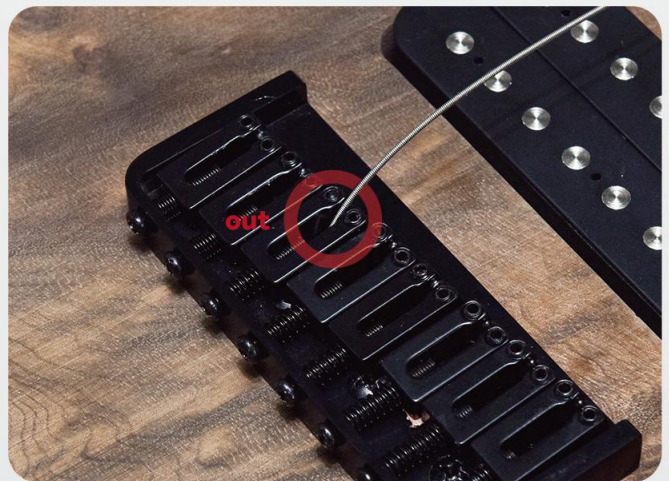
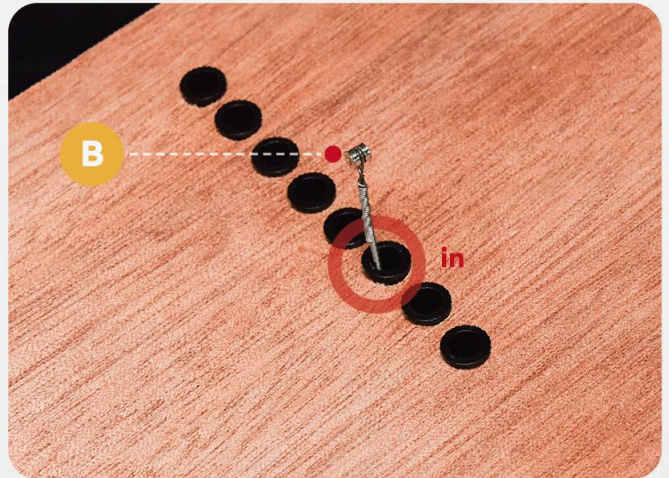

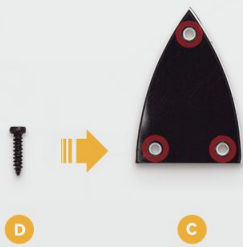
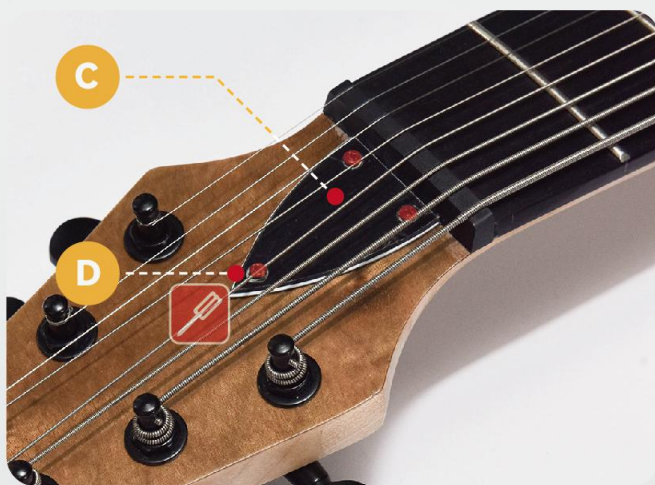

ENJOY





Bex Gears