

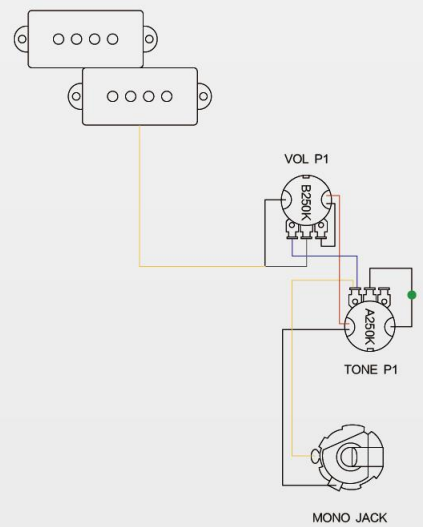

Bex Gears

JB STYLE
ASSEMBLY DIAGRAM

PB,1V/1T



YOU NEED A SCREWDRIVER



YOU NEED A WRENCH



**YOU NEED TO USE
WIRE CUTTERS**



**PAY ATTENTION TO
ASSEMBLING**

1



6



5



3



4



2



3



LIST OF ALL PARTS
SUGGESTED ASSEMBLY SEQUENCE



B

A

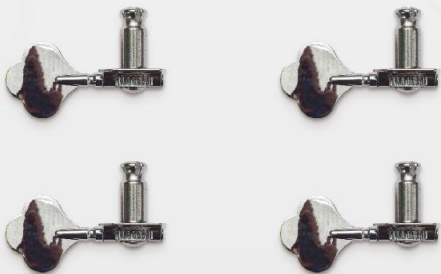

C

D



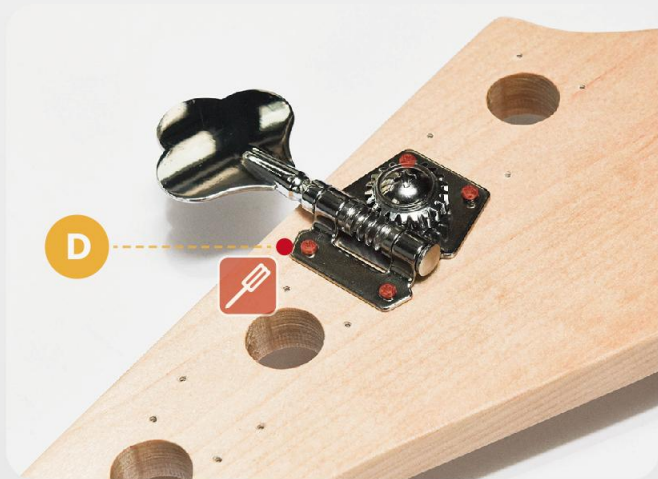



A



B



C



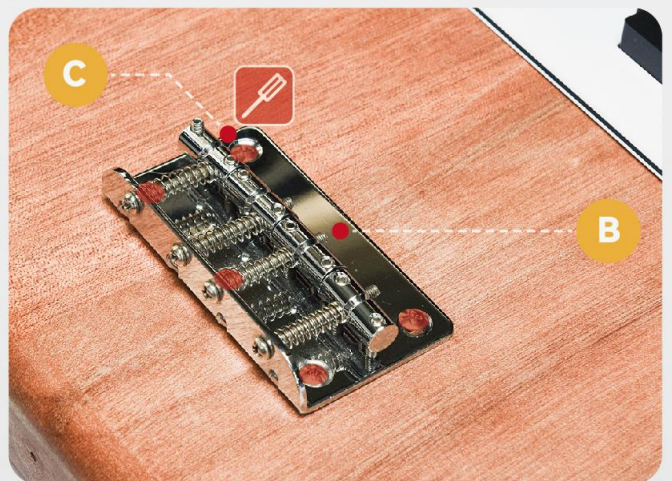



A



B



C



D



E



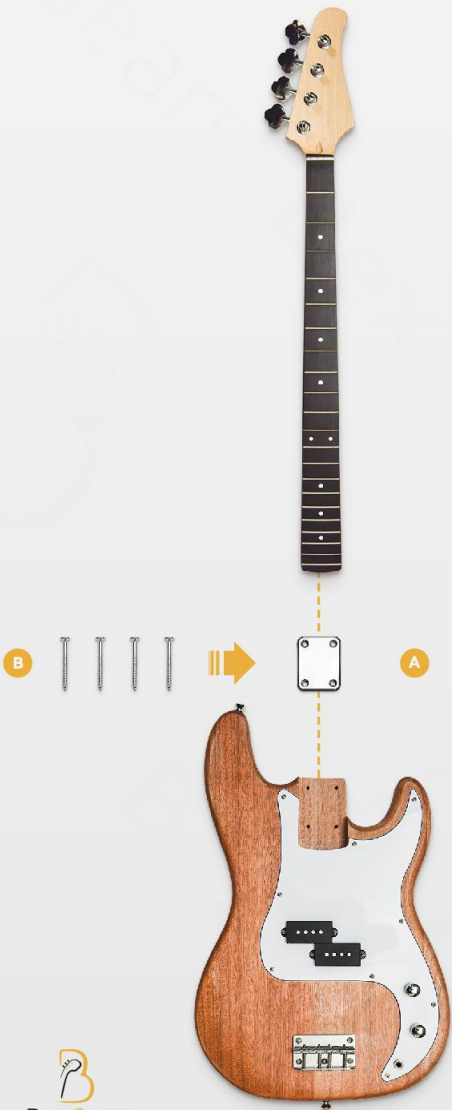
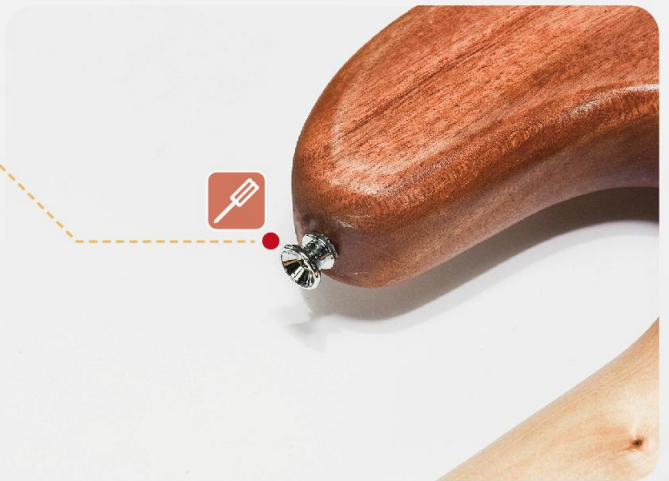
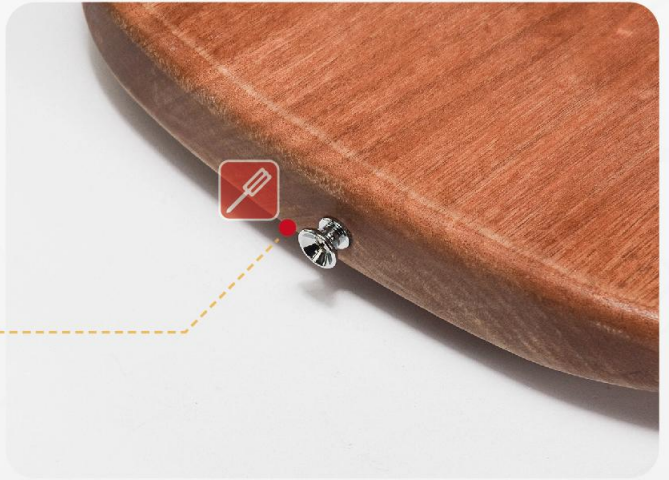

THE THIRD STEP/STRAP BUTTON ASSEMBLY SEQUENCE



A



B



C



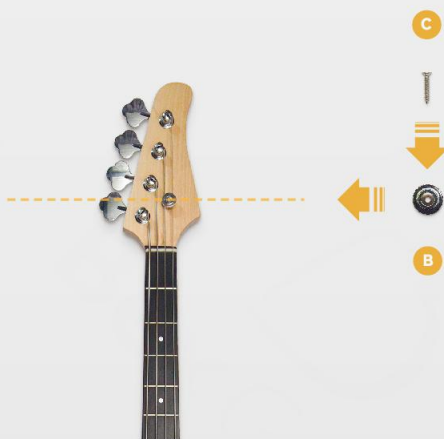
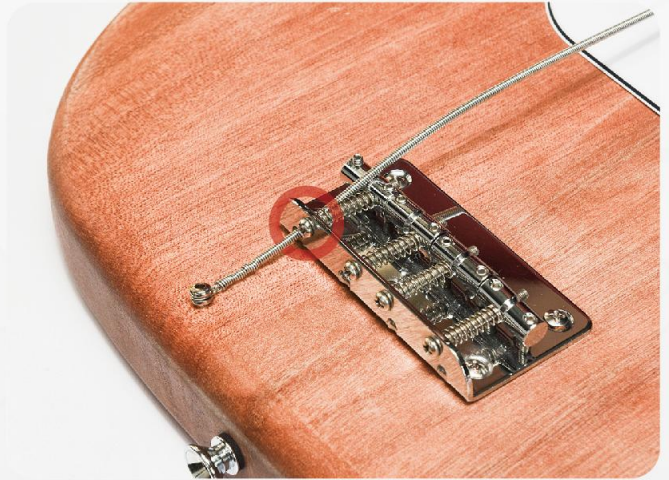

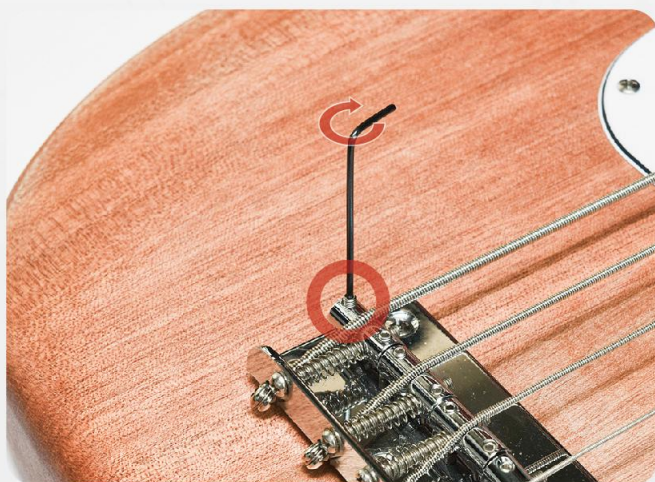



ENJOY



Bex Gears