

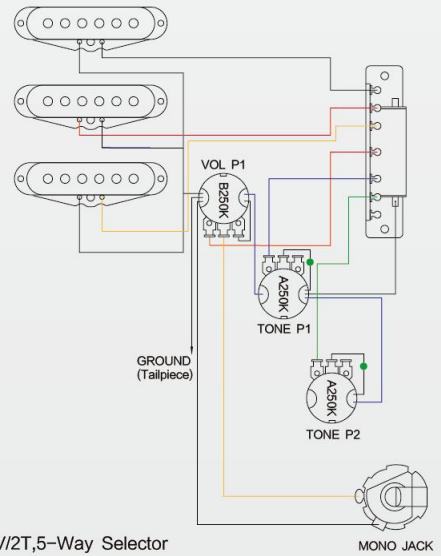

# Bex Gears

**ST STYLE**  
ASSEMBLY DIAGRAM



S-S-S,1V/2T,5-Way Selector

MONO JACK



**YOU NEED A SCREWDRIVER**



**YOU NEED A WRENCH**



**YOU NEED TO USE  
WIRE CUTTERS**



**PAY ATTENTION TO  
ASSEMBLING**





**B**



**A**



**C**

**D**

**E**

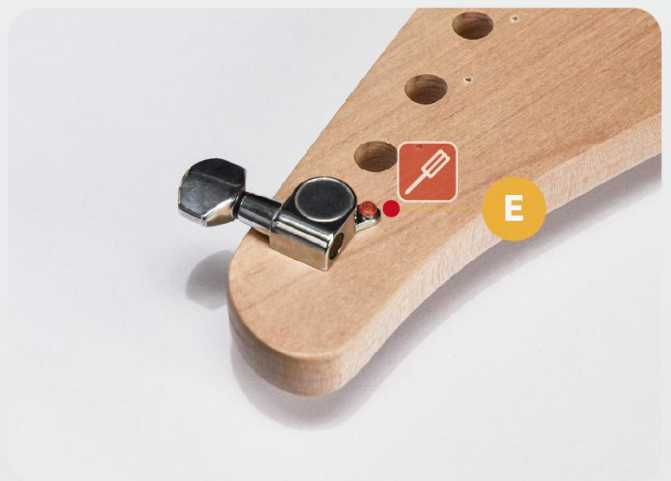
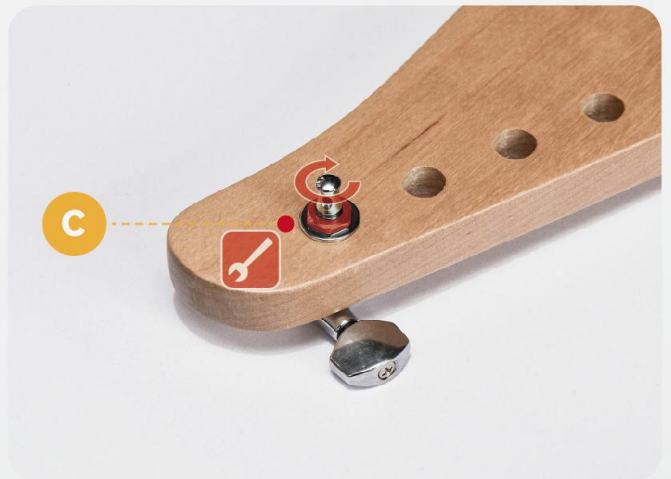
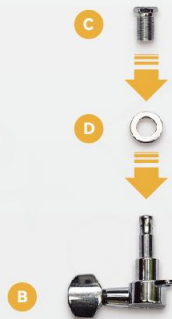
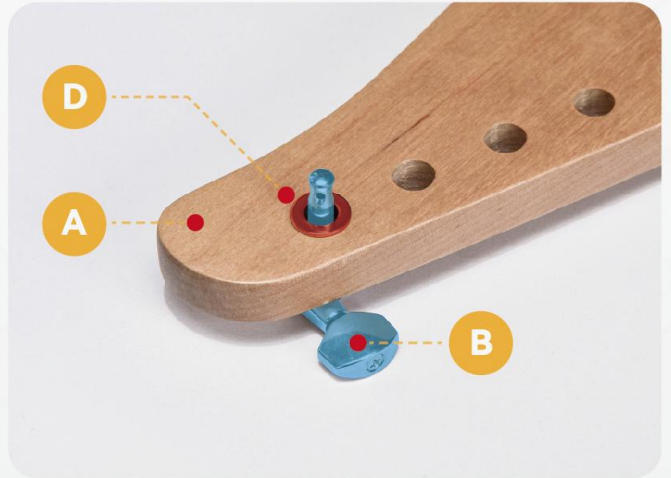



**A**



**B**



**C**



**D**



**F**

**E**



**G**



Wiring diagram

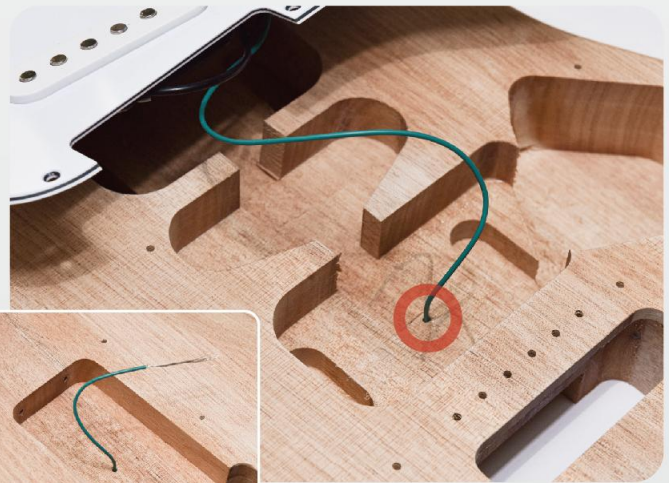
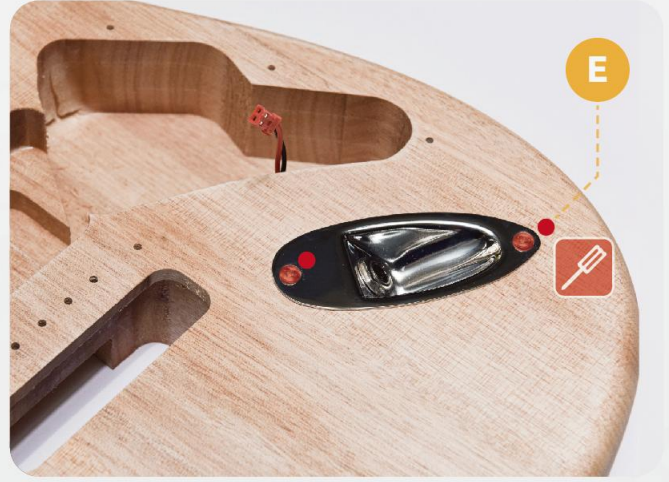
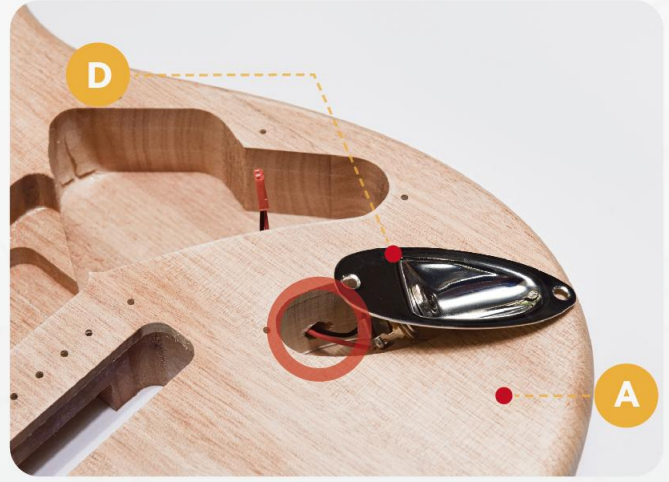

back



**THE SECOND STEP/NECK PICKUP AND PICKGUARD ASSEMBLY SEQUENCE 01**

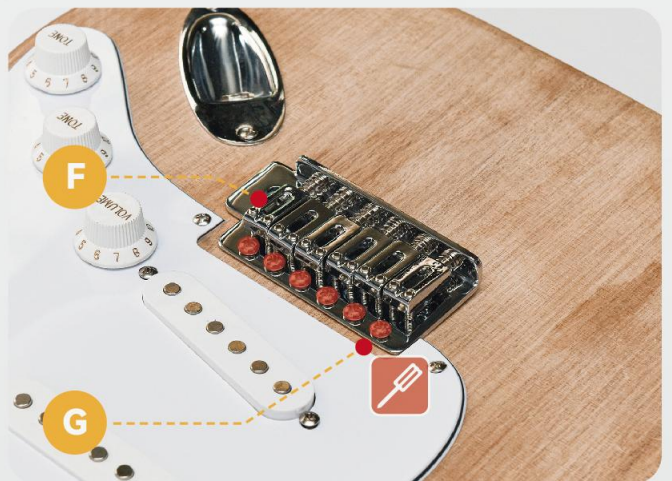





A



B



D



C



E



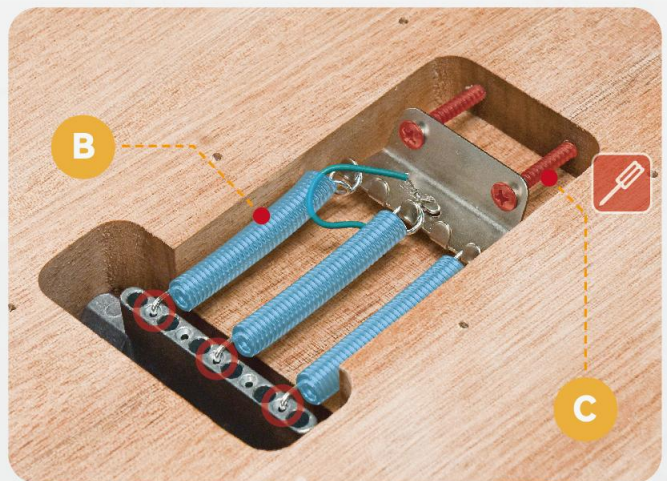



A



B



C



D



E



C



D



E

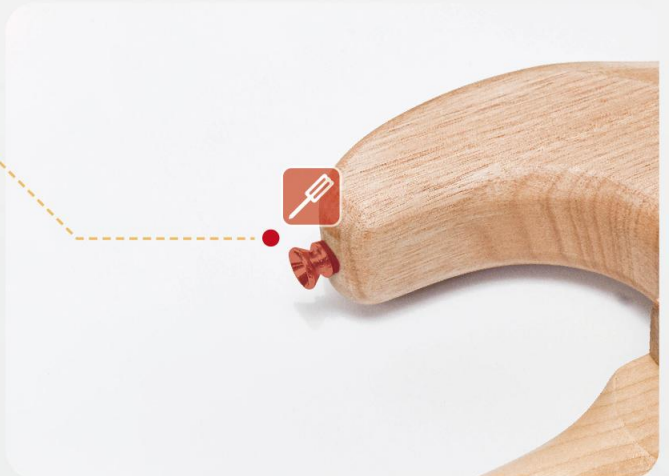
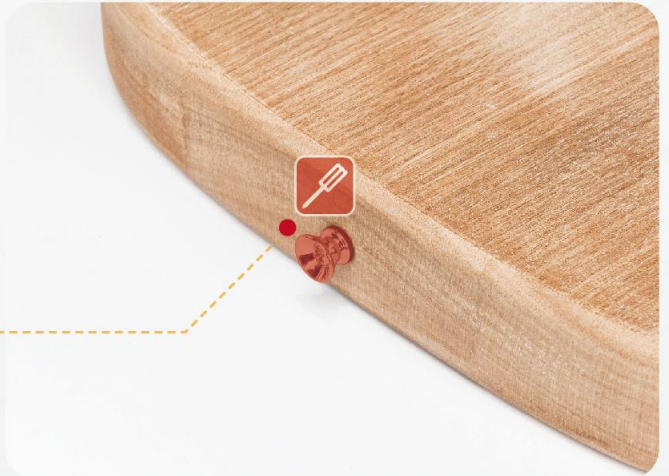

B

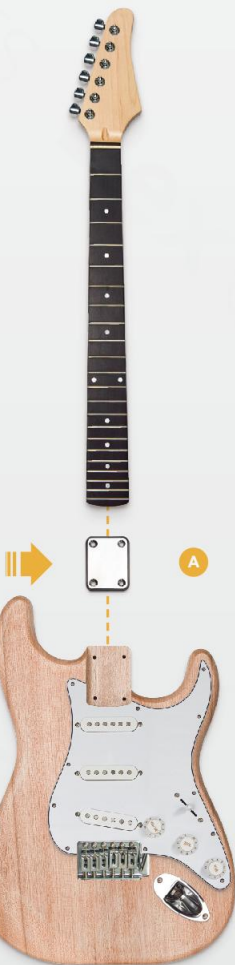

A

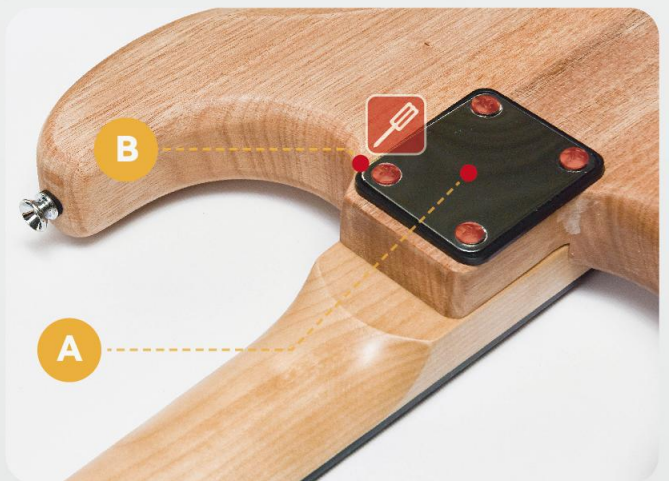

B

A



**THE FOURTH STEP/STRAP BUTTON ASSEMBLY SEQUENCE**



A



B



C



D



E



F

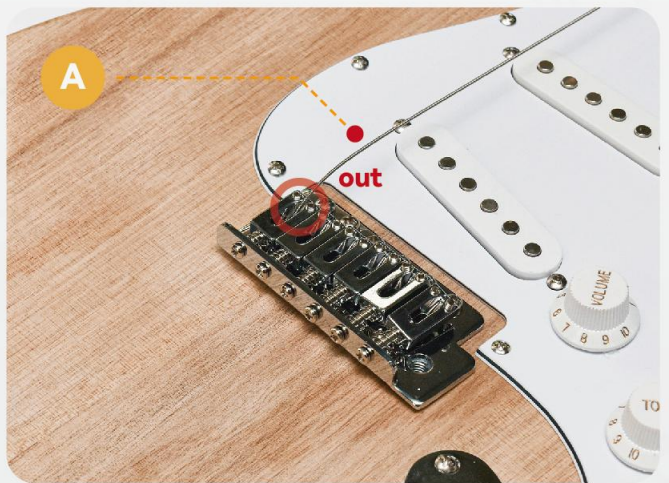

Bex Gears

C



B



E



C



B



D

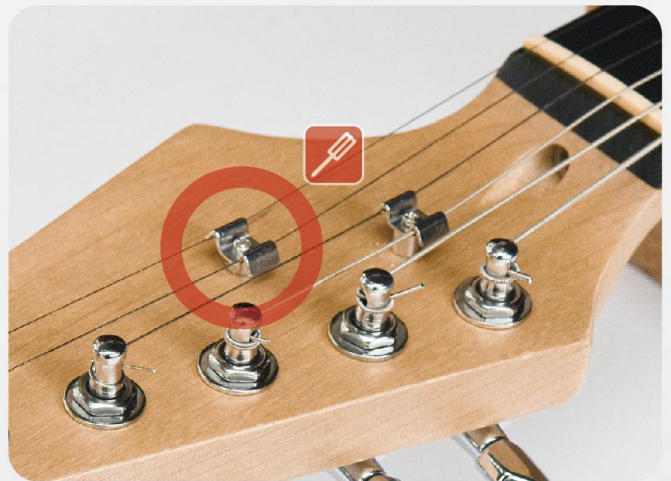





ENJOY





**Bex** Gears