

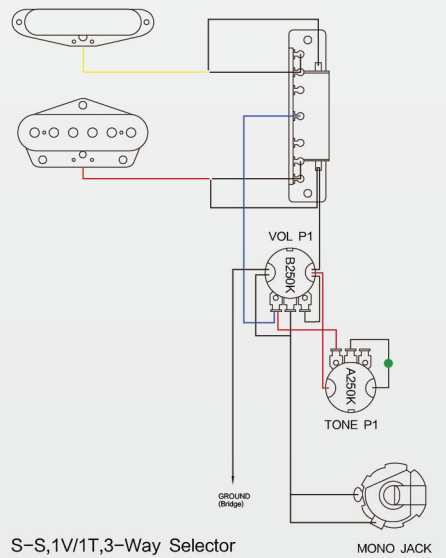

**TL STYLE**  
**ASSEMBLY DIAGRAM**



**YOU NEED A SCREWDRIVER**



**YOU NEED A WRENCH**



**YOU NEED TO USE  
WIRE CUTTERS**



**PAY ATTENTION TO  
ASSEMBLING**

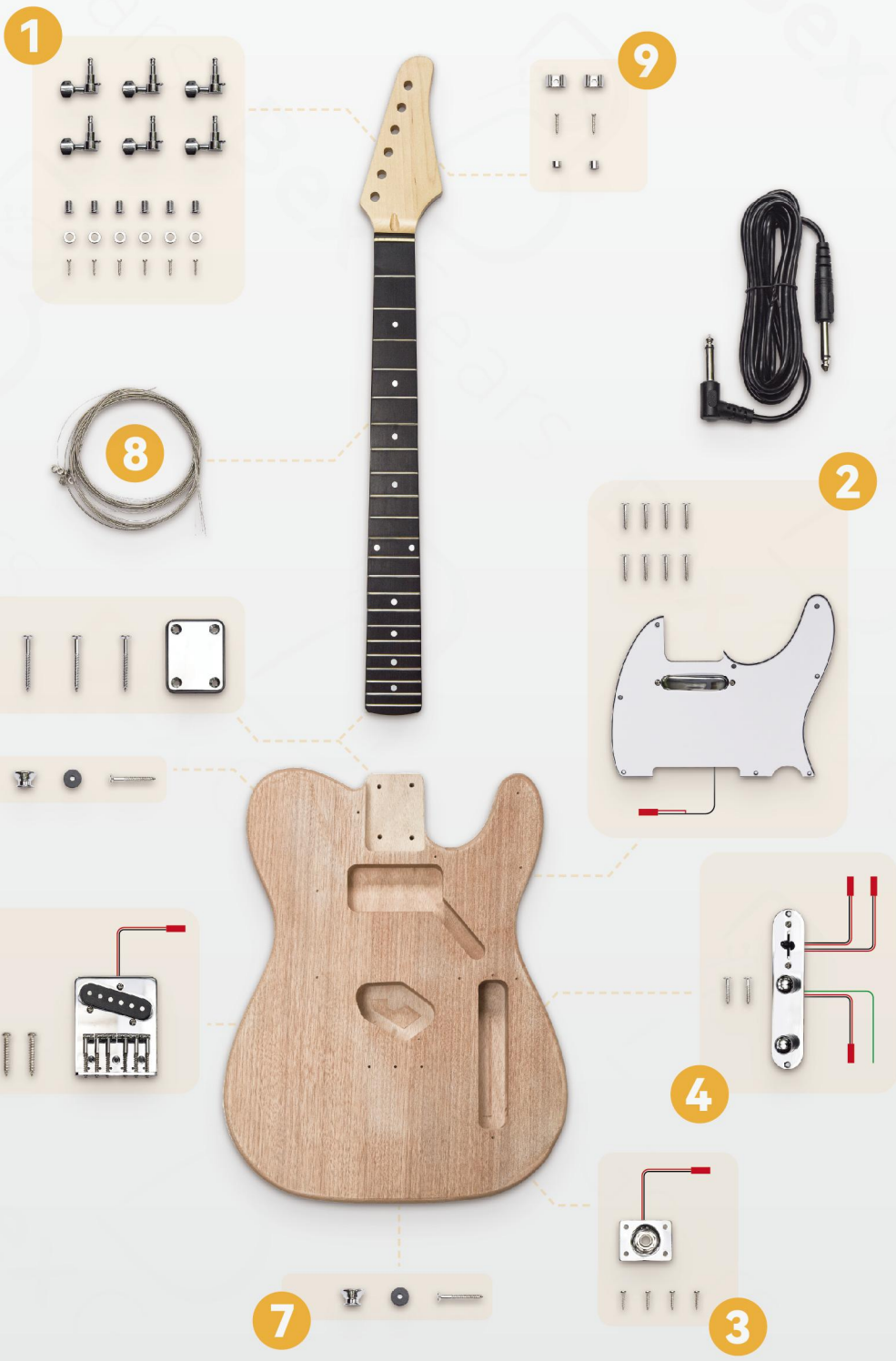



**B**



**A**



**C**

**D**

**E**

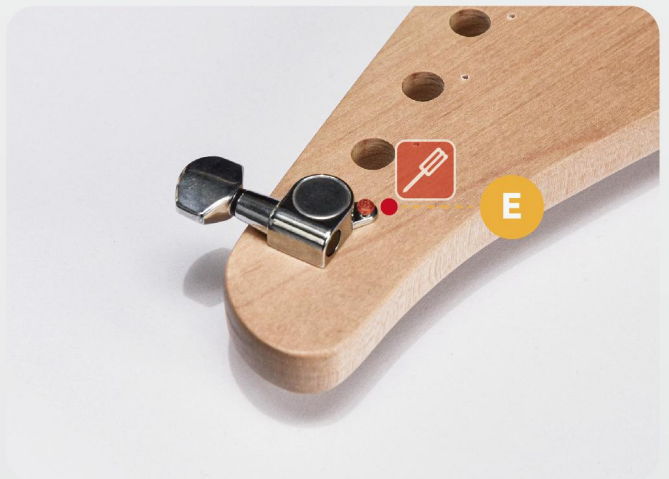
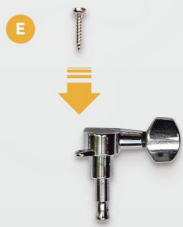
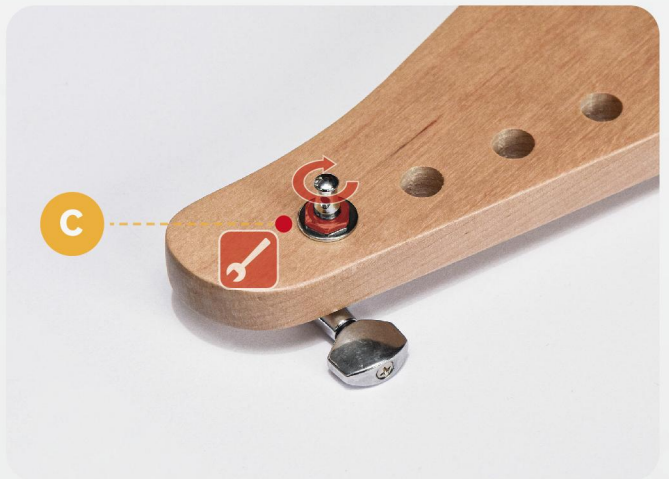
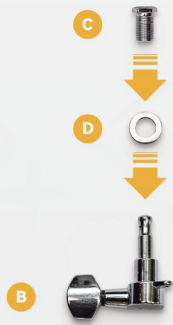
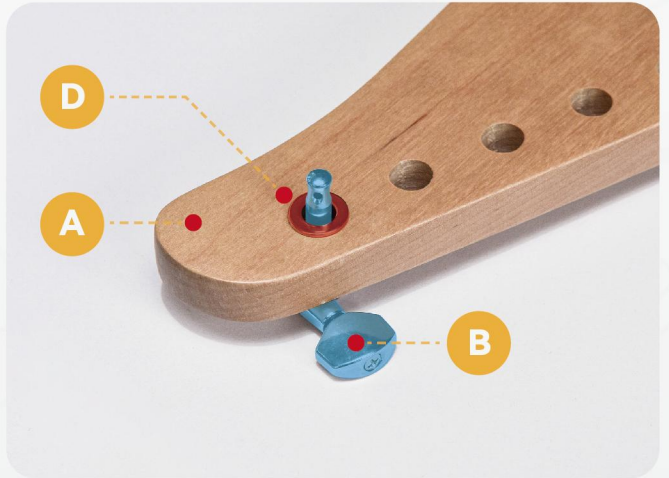
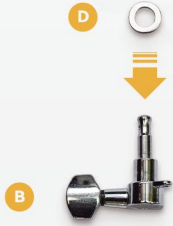





A



B

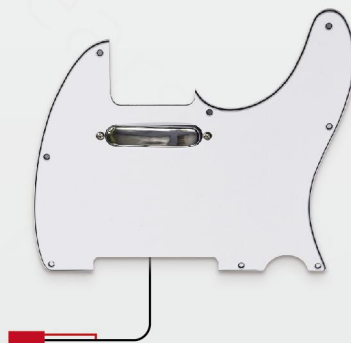

C

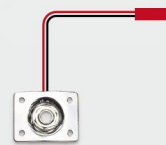

D

E





Wiring diagram

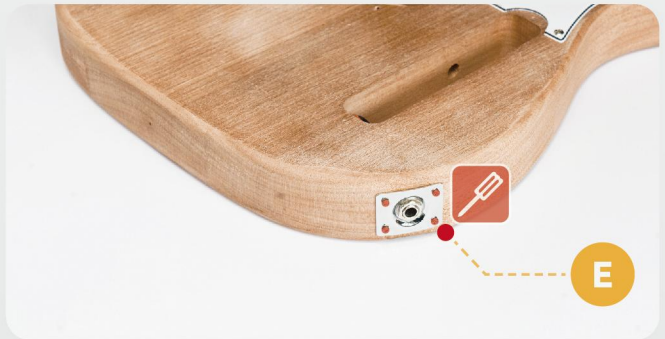
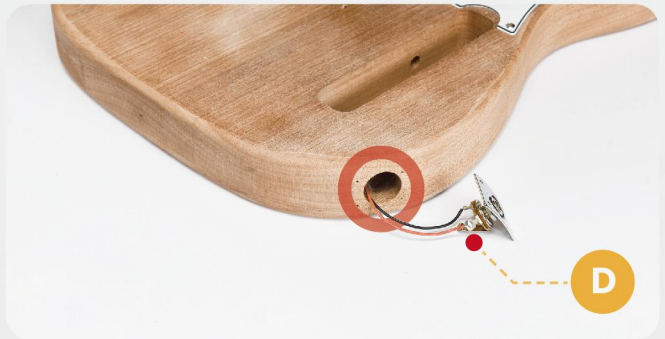
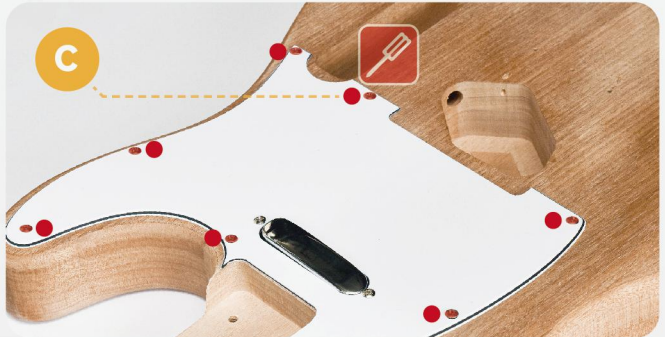
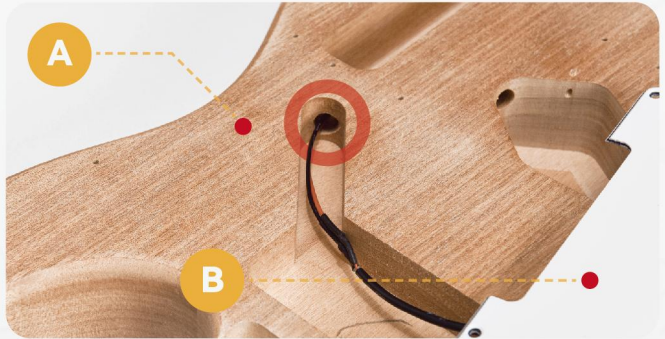



A

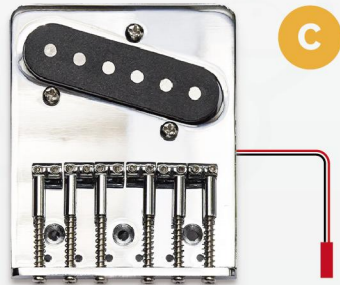

C



B



D







此处需要有必要的文字描述

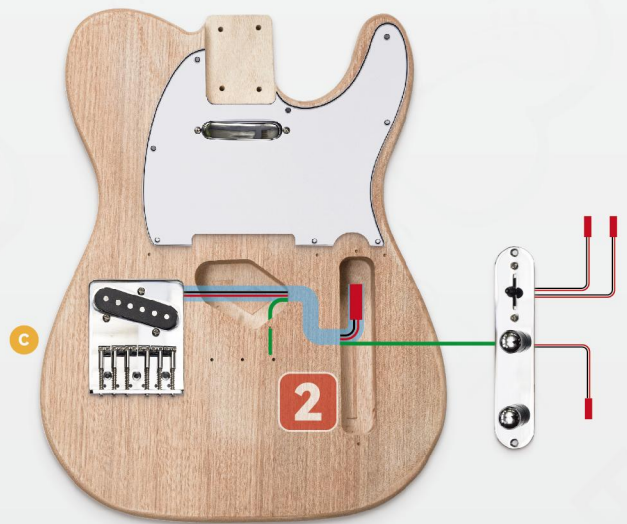
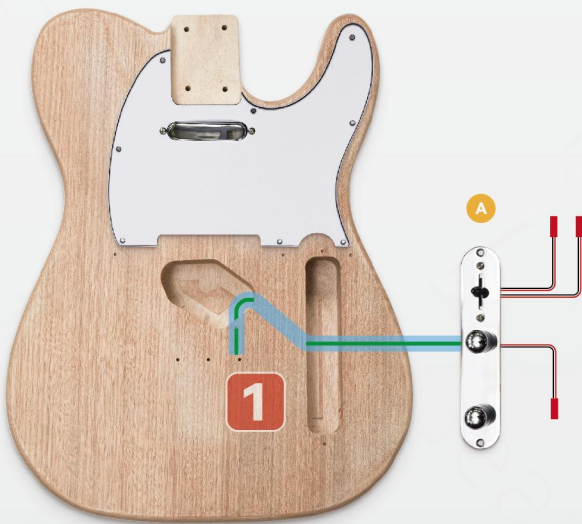
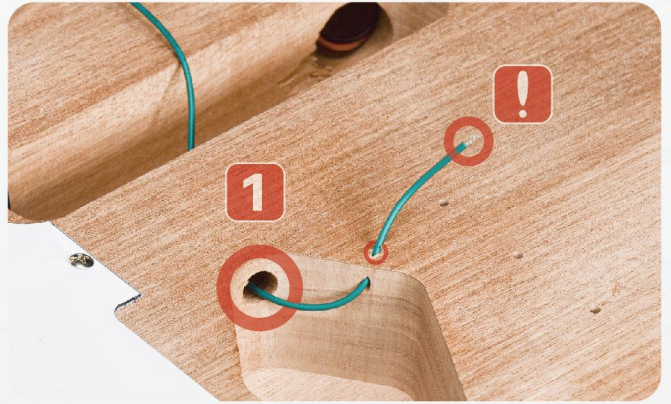

Wiring diagram

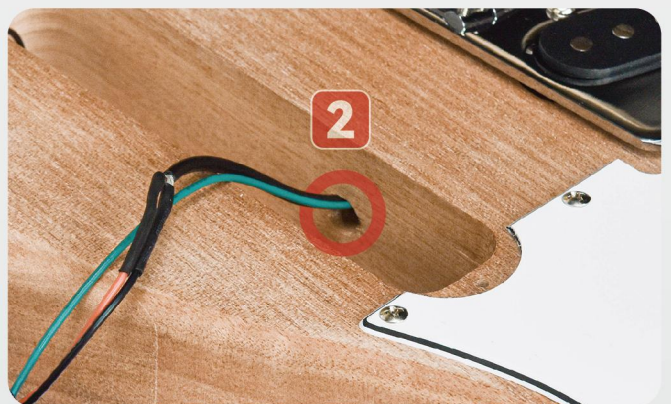

**THE THIRD STEP/WIRING AND BRIDGE PICKUP AND BRIDGE ASSEMBLY SEQUENCE 01**

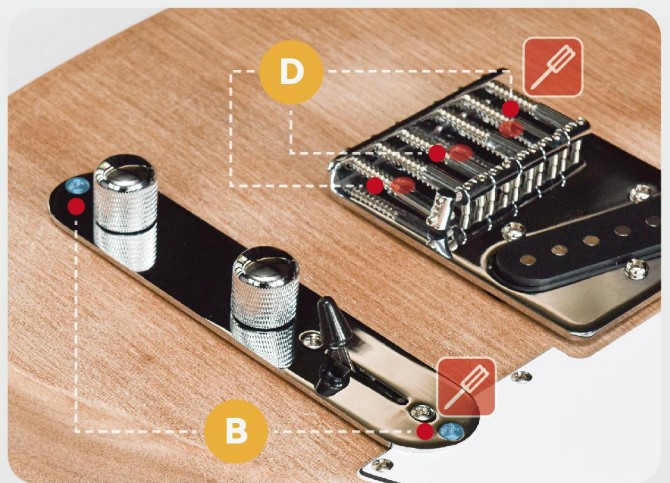
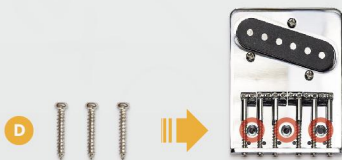
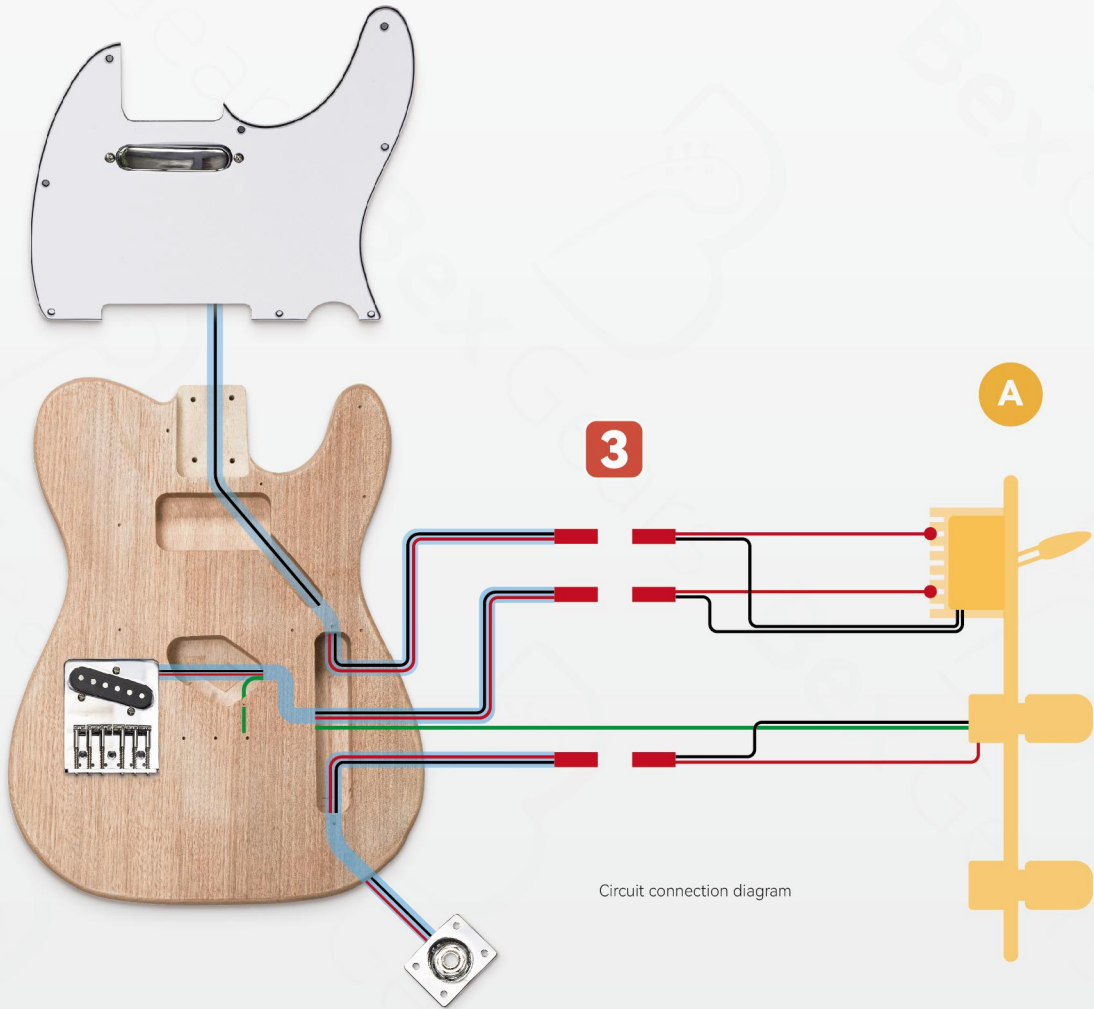



A



B



C



D



E





C



D



E

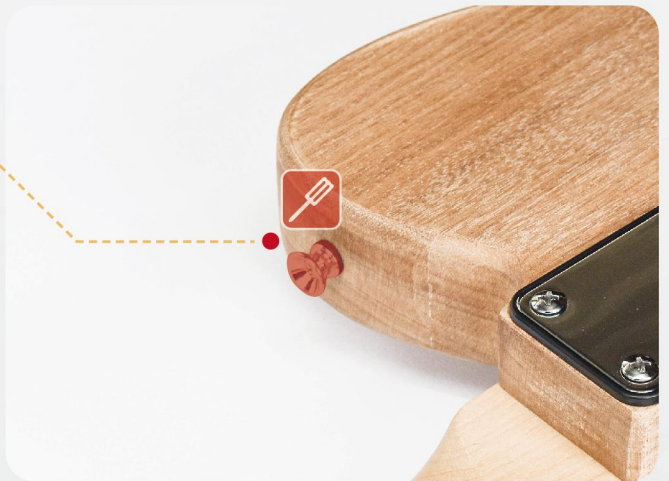
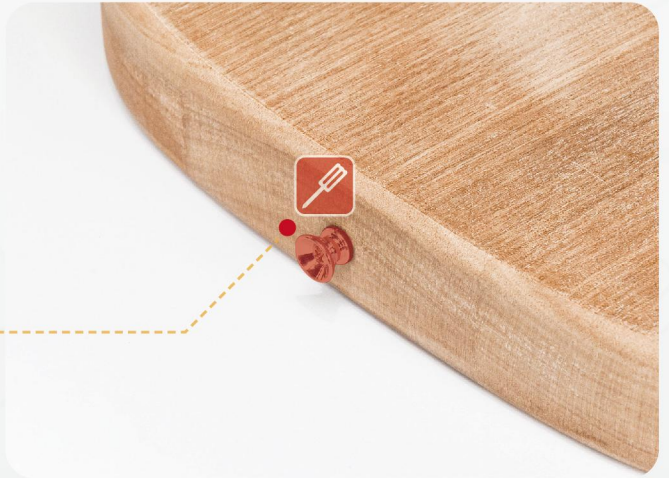

B

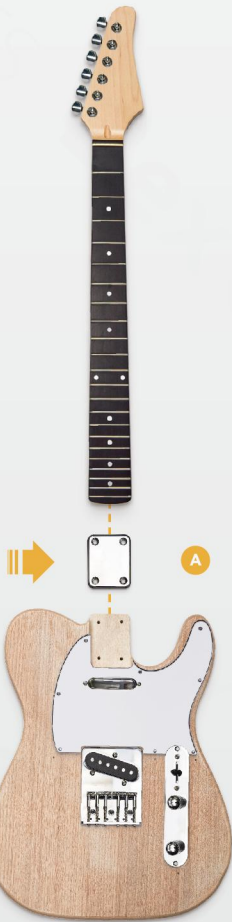

A

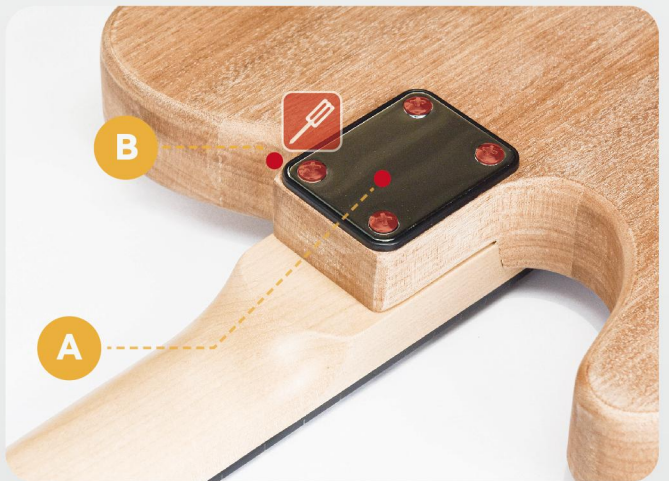





A



B



C



D



E





- C 
- ↓ 
- B 
- ↓ 
- E 

- C 
- ↓ 
- B 
- ↓ 
- D 

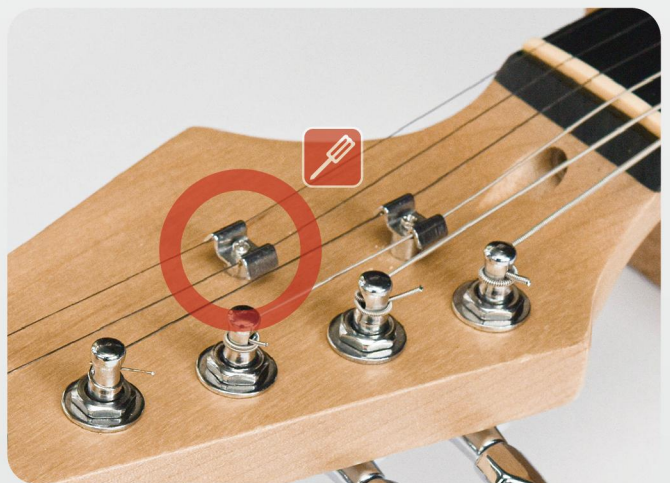
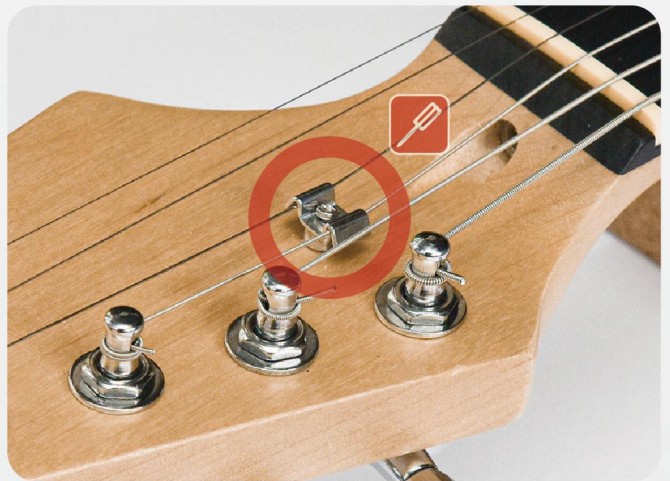

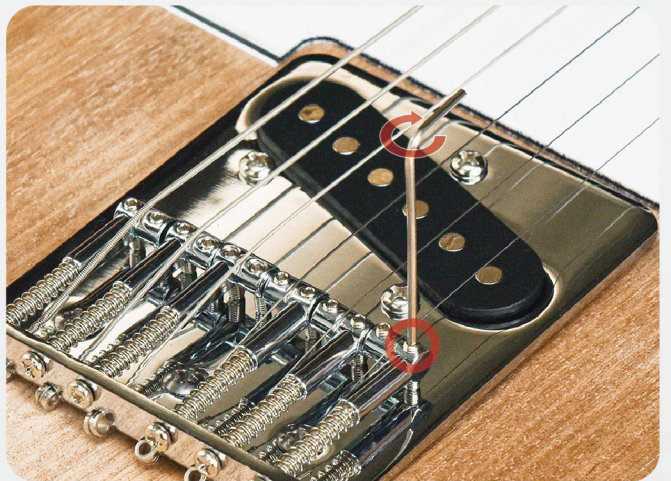



**Bex** Gears