

# **DELCO** **TRAILERS**

## **OWNERS MANUAL**

### **DUMP**

#### **WARNING**

**THIS OWNERS MANUAL CONTAINS SAFETY INFORMATION AND INSTRUCTIONS FOR YOUR TRAILER.**

**YOU MUST READ THIS MANUAL BEFORE LOADING OR TOWING YOUR TRAILER.**

**YOU MUST FOLLOW ALL SAFETY PRECAUTIONS AND INSTRUCTIONS AS STATED WITHIN.**

<b>1. Introduction.....</b>	<b>5</b>
<b>2. Safety .....</b>	<b>6</b>
<b>2.1 Safety Alert Symbols And Signal Words .....</b>	<b>6</b>
<b>2.2 Major Hazards .....</b>	<b>6</b>
2.2.1 Improper Sizing Of Trailer To Tow Vehicle .....	6
2.2.2 Driving Too Fast.....	6
2.2.3 Adjust Driving When Towing Trailer .....	7
2.2.4 Trailer Not Properly Coupled To Hitch.....	7
2.2.5 Proper Use Of Safety Chains.....	8
2.2.6 Proper Connection Of Breakaway Brake.....	8
2.2.7 Matching Trailer And Hitch .....	8
2.2.8 Worn Tires, Loose Wheels And Lug Nuts .....	8
2.2.9 Improper Loading .....	9
2.2.10 Unsafe Load Distribution .....	10
2.2.11 Shifting Cargo .....	10
2.2.12 Inappropriate Cargo .....	10
2.2.13 Inoperable Brakes Or Lights.....	11
2.2.14 Trailer Modifications.....	11
2.2.15 Trailer Towing Guide .....	11
2.2.16 Safe Trailer Towing Guidelines.....	12
2.2.17 Safety Warning Labels On Your Trailer.....	13
2.2.18 Reporting Safety Defects .....	16
<b>3. Tire Safety Information .....</b>	<b>17</b>
<b>3.1 Trailer Tire Information.....</b>	<b>17</b>
<b>3.2 Steps For Determining Correct Load Limit - Trailer .....</b>	<b>18</b>
3.2.1 Trailers 10,000 Pounds GVWR Or Less .....	18
3.2.2 Trailers Over 10,000 Pounds GVWR .....	18
<b>3.3 Steps For Determining Correct Load Limit - Tow Vehicle.....</b>	<b>19</b>
<b>3.4 Glossary Of Tire Terminology.....</b>	<b>19</b>
<b>3.5 Tire Safety - Everything Rides On It.....</b>	<b>21</b>
3.5.1 Safety First- Basic Tire Maintenance .....	22
3.5.2 Finding Your Vehicle’s Recommended Tire Pressure And Load Limits.....	22
3.5.3 Understanding Tire Pressure And Load Limits .....	22
3.5.4 Safety First- Basic Tire Maintenance .....	22
3.5.5 Steps For Maintaining Proper Tire Pressure.....	22
3.5.6 Tire Size .....	23
3.5.7 Tire Tread.....	23
3.5.8 Tire Balance And Wheel Alignment .....	23
3.5.9 Tire Repair .....	23
3.5.10 Tire Fundamentals.....	23
3.5.10.1 Information on Passenger Vehicle Tires .....	23
3.5.10.2 UTQGS Information .....	24
3.5.10.3 Additional Information On Light Truck Tires .....	24
3.5.10.4 Tire Safety Tips.....	25

<b>4. Coupling To Tow Vehicle .....</b>	<b>26</b>
<b>4.1 Tow Vehicle And Hitch.....</b>	<b>26</b>
4.1.1 Trailer Information .....	26
4.1.2 Tow Vehicle .....	26
<b>4.2 Coupling And Uncoupling The Trailer .....</b>	<b>26</b>
<b>4.3 Couple Trailer To Tow Vehicle .....</b>	<b>27</b>
4.3.1 Ball Hitch Coupler.....	27
4.3.1.1 Before Coupling Trailer To Tow Vehicle .....	28
4.3.1.2 Prepare Coupler And Hitch .....	28
4.3.1.3 Couple Trailer To Tow Vehicle.....	28
4.3.2 Trailer With Ring And Pintle Coupler .....	29
4.3.2.1 Before Coupling Trailer To Tow Vehicle .....	29
4.3.2.2 Prepare Ring And Pintle .....	29
4.3.2.3 Couple Trailer To Tow Vehicle.....	30
4.3.3 Connect Safety Chains.....	30
4.3.4 Connect Electrical Cable.....	31
4.3.5 Attach Breakaway Brake Lanyard.....	31
4.3.5.1 Test Electric Brakes .....	31
4.3.5.2 Test Electric Breakaway Brakes .....	31
4.3.5.3 Test Surge Brakes (If Equipped).....	32
4.3.5.4 Test Surge Breakaway System .....	33
<b>4.4 Uncouple Trailer.....</b>	<b>33</b>
<b>4.5 Tongue Weight .....</b>	<b>33</b>
4.5.1 Checking Tongue Weight.....	34
<b>4.6 Adjust Hitch Height (If Equipped).....</b>	<b>34</b>
<b>5. Loading And Unloading .....</b>	<b>36</b>
<b>5.1 Loading Trailer .....</b>	<b>36</b>
5.1.1 Preparing Trailer For Loading.....	36
5.1.2 Loading A Rigid Deck Trailer .....	36
5.1.3 Loading A Tilt Deck Trailer.....	37
5.1.3.1 Manual Tilt Trailer .....	37
5.1.3.2 Hydraulic Tilt Trailer.....	38
<b>5.2 Unload Trailer .....</b>	<b>38</b>
5.2.1 Unload Manual Tilt Trailer .....	38
5.2.2 Unload Hydraulic Tilt Trailer .....	38
<b>5.3 Hydraulic Components .....</b>	<b>39</b>
<b>5.4 Securing Cargo .....</b>	<b>39</b>
<b>6. Pre-Tow Checklist.....</b>	<b>40</b>
6.1 Pre-Tow Checklist.....	40
6.2 Make Regular Stops .....	40

---

<b>7. Breaking In A New Trailer .....</b>	<b>41</b>
7.1 Retighten Lugs At First 10, 25 & 50 Miles.....	41
7.2 Adjust Brake At First 200 Miles .....	41
7.3 Synchronizing Brake Systems .....	41
<b>8. Accessories .....</b>	<b>42</b>
8.1 Accessory Battery .....	42
<b>9. Inspection, Service And Maintenance .....</b>	<b>43</b>
9.1 Inspection, Service & Maintenance Summary Charts.....	43
9.2 Inspection And Service Instructions.....	46
9.2.1 Trailer Structure.....	46
9.2.1.1 Fasteners And Frame Members.....	46
9.2.1.2 Welds.....	46
9.2.2 Trailer Brakes - Electric.....	46
9.2.2.1 Brake Shoes And Drums .....	46
9.2.2.2 Manually Adjusting Brake Shoes.....	47
9.2.2.3 Electric Brakes .....	47
9.2.2.4 Tow Vehicle Operated Electric Brakes .....	47
9.2.2.5 Electric Brake Magnets.....	47
9.2.3 Trailer Brakes - Surge (If Equipped).....	47
9.2.3.1 Surge Brake Master Cylinder .....	47
9.2.3.2 Hydraulic Surge Brake.....	48
9.2.3.3 Master Cylinder Bleeding .....	48
9.2.4 Trailer Connection To Tow Vehicle.....	48
9.2.4.1 Coupler And Ball .....	48
9.2.4.2 Ring And Pintle.....	49
9.2.5 Landing Leg Or Jack .....	49
9.2.6 Lights And Signals .....	49
9.2.7 Wheel Rims .....	49
9.2.8 Tires .....	49
9.2.9 Wheel Bearings.....	50
9.2.10 Lubrication .....	50
9.2.11 Hydraulic Reservoir .....	50
9.2.12 Lug Nuts Or Bolts.....	50

## 1. Introduction

---

Congratulations on the purchase of your trailer. We believe you will be happy and completely satisfied with your purchase. Our goal is to provide a valued customer a quality trailer at a reasonable price.

For your safety, read and understand this manual before operating your trailer. If there are any questions about information in this manual, please consult your dealer.

When calling about your trailer, please have the VIN number available for the dealer. The VIN number is normally on the front left side of the trailer.

For future reference, please write your VIN number in the space below:

---

This manual covers the basic trailer. You must read, understand and follow the instructions given by the trailer manufacturer, tow vehicle and trailer hitch manufacturers. Keep all manuals provided with your trailer in a safe place at all times.

Inserts providing information on axles and tire warranty are provided with this manual. Please keep these inserts for future reference.

## 2. Safety

### 2.1 Safety Alert Symbols And Signal Words

An Owner's Manual that provides general trailer information cannot cover all of the specific details necessary for the proper combination of every trailer, tow vehicle and hitch. You must read, understand and follow the instructions given by the tow vehicle and trailer hitch manufacturers, as well as the instructions in this manual.

Our trailers are built with components produced by various manufacturers. Some of these items have separate instruction manuals. Where this manual indicates that you should read another manual, and you do not have that manual, contact your dealer for assistance.

The safety information in this manual is denoted by the safety alert symbol:



This symbol means ATTENTION! BECOME ALERT! YOUR SAFETY IS INVOLVED!

The level of risk is indicated by the following signal words:

 <b>DANGER</b>
<p><b>DANGER - Indicates a hazardous situation, which, if not avoided, WILL result in death or serious injury.</b></p>

 <b>WARNING</b>
<p><b>WARNING - Indicates a hazardous situation, which, if not avoided, could result in death or serious injury.</b></p>

 <b>CAUTION</b>
<p><b>CAUTION - Indicates a hazardous situation, which, if not avoided, could result in minor or moderate injury.</b></p>

## NOTICE

***NOTICE - Indicates a situation that could result in damage to the equipment or other property.***

### 2.2 Major Hazards

Loss of control of the trailer or trailer/tow vehicle combination can result in death or serious injury. The most common causes for loss of control of the trailer are:

- Improper sizing the trailer for the tow vehicle, or vice versa.
- Excessive Speed: Driving too fast for the conditions.
- Improper braking and steering under sway conditions
- Overloading and/or improper weight distribution.
- Not keeping lug nuts tight.
- Failure to adjust driving behavior when towing a trailer.
- Not maintaining proper tire pressure
- Improper or mis-coupling of the trailer to the hitch.

#### 2.2.1 Improper Sizing Of Trailer To Tow Vehicle

Trailers that weigh too much for the tow vehicle can cause stability problems, which can lead to death or serious injury. The additional strain put on the engine and drive-train may lead to serious tow vehicle maintenance problems.

Do not exceed the maximum towing capacity of your tow vehicle. The towing capacity of your tow vehicle, in terms of maximum Gross Trailer Weight (GTW) and maximum Gross Combined Weight Rating (GCWR) can be found in the tow vehicle Owner's Manual.

 <b>DANGER</b>
<p><b>Use of an under-rated hitch, ball or tow vehicle can result in loss of control leading to death or serious injury.</b></p> <p><b>Make certain your hitch and tow vehicle are rated for your trailer.</b></p>

#### 2.2.2 Driving Too Fast

With ideal road conditions, the maximum recommended speed for safely towing a trailer is 55 mph. Driving too fast can cause the trailer to sway, thus increasing

the possibility for loss of control. Also your tires may overheat, increasing the possibility of a blowout.



## WARNING

**Driving too fast for conditions can result in loss of control and cause death or serious injury.**

**Adjust speed down when towing trailer.**

### 2.2.3 Adjust Driving When Towing Trailer

When towing a trailer, you will have decreased acceleration, increased stopping distance, and increased turning radius.

The trailer will change the handling characteristics of the tow vehicle, making it more sensitive to steering inputs and more likely to be pushed around in windy conditions or when being passed by large vehicles. In addition, you will need a longer distance to pass, due to slower acceleration and increased length. With this in mind:

- When encountering trailer sway, take your foot off the accelerator, and steer as little as possible in order to stay on the road. Use small “trim-like” steering adjustments. Do not attempt to steer out of the sway; you’ll only make it worse. Also do not apply the tow vehicle brakes to correct trailer swaying. On the other hand, application of the trailer brakes alone will tend to straighten out the combination, especially when going downhill.
- Check rearview mirrors frequently to observe trailer and traffic.
- Be aware of trailer height, especially when approaching bridges, roofed areas and trees.
- Be alert for slippery conditions. You are more likely to be affected by slippery road surfaces when driving a tow vehicle with a trailer, than driving a tow vehicle without a trailer.
- Anticipate the trailer “swaying.” Swaying can be caused by excessive steering, wind gusts, roadway edges, or by the trailer reaction to the pressure wave created by passing trucks and busses.
- Use lower gear when driving down steep or long grades. Use the engine and transmission as a brake. Do not ride the brakes, as they can overheat and become ineffective.

### 2.2.4 Trailer Not Properly Coupled To Hitch

It is critical that the trailer be securely coupled to the hitch, and that the safety chains and emergency breakaway brake lanyard are correctly attached. Uncoupling may result in death or serious injury to you and to others.



## WARNING

**Proper selection and condition of the coupler and hitch are essential to safely towing a trailer.**

**A loss of coupling may result in death or serious injury.**

**Hitch size must match coupler size.**

**Be sure hitch load rating is equal to or greater than load rating of the coupler.**

**Be sure hitch components are tight before coupling trailer to tow vehicle.**

**Observe hitch for wear, corrosion and cracks before coupling. Replace worn, corroded or cracked hitch components before coupling trailer to tow vehicle.**



## WARNING

**An improperly coupled trailer can result in death or serious injury. Do not move the trailer until:**

- **Coupler is secured and locked to hitch.**
- **Safety chains are secured to tow vehicle.**
- **Trailer jack(s) are fully retracted.**
- **Trailer brakes are checked.**
- **Tires and wheels are checked.**
- **Breakaway switch is connected to tow vehicle;**
- **The trailer lights are connected and checked.**
- **Load is secured to trailer.**

## 2.2.5 Proper Use Of Safety Chains

Safety chains are provided so that control of the trailer can be maintained if your trailer comes loose from the hitch.

### **WARNING**

**Improper rigging of the safety chains can result in loss of control of the trailer and tow vehicle, leading to death or serious injury, if the trailer uncouples from the tow vehicle.**

**Cross chains underneath hitch and coupler with enough slack to permit turning and to hold tongue up, if the trailer comes loose.**

**Fasten chains to frame of tow vehicle.**

**Do not fasten chains to any part of the hitch unless the hitch has holes or loops specifically for that purpose.**

## 2.2.6 Proper Connection Of Breakaway Brake

If equipped with brakes, your trailer will be equipped with a breakaway brake system that can apply the brakes on your trailer if your trailer comes loose from the hitch. You may have a separate set of instructions for the breakaway brake if the trailer is so equipped. The breakaway brake system, including battery, must be in good condition and properly rigged to be effective.

### **WARNING**

**An ineffective or inoperative breakaway brake system can result in a runaway trailer, leading to death or serious injury if the coupler or hitch fails.**

**Breakaway lanyard must be connected to the tow vehicle, NOT to any part of the hitch.**

**Before towing trailer, test the function of the breakaway brake system. If the breakaway brake system is not working, do not tow the trailer. Have it serviced or repaired.**

## 2.2.7 Matching Trailer And Hitch

### **DANGER**

**Be sure hitch and tow vehicle are rated for the Gross Vehicle Weight Rating (GVWR) of your trailer.**

**Use of a hitch with a load rating less than the load rating of the trailer can result in loss of control and may lead to death or serious injury.**

**Use of a tow vehicle with a towing capacity less than the load rating of the trailer can result in loss of control, and may lead to death or serious injury.**

## 2.2.8 Worn Tires, Loose Wheels And Lug Nuts

Inspect all trailer tires before each tow. If a tire has a bald spot, bulge, cut, cracks, or is showing any cords, replace the tire before towing.

If a tire has uneven tread wear, take the trailer to a trailer service center for diagnosis. Uneven tread wear can be caused by tire imbalance, axle misalignment or incorrect inflation.

Tires with too little tread will not provide adequate frictional forces on wet roadways and can result in loss of control, leading to death or serious injury.

Improper tire pressure causes increased tire wear and may reduce trailer stability, which can result in a tire blowout or possible loss of control. Therefore, before each tow you must also check the tire pressure.

The proper tire pressure is listed on the Certification / VIN label, normally mounted on the front left side of the trailer, and should be checked when tires are cold. Allow 3 hours cool-down after driving as much as 1 mile at 40 mph before checking tire pressure.



## **WARNING**

**Inflate tires to pressure stated on the Certification / VIN label.**

**Improper tire pressure may cause unstable trailer. Blowout and loss of control may occur. Death or serious injury can result.**

**Make sure of proper tire pressure before towing trailer.**

The tightness of the wheel nuts or bolts is very important in keeping the wheels properly seated to the hub. Before each tow, check to make sure they are tight.

## **WARNING**

**Metal creep between the wheel rim and wheel nuts or bolts may cause rim to loosen.**

**Death or injury can occur if wheel comes off.**

**Tighten lug nuts or bolts before each tow.**

The proper tightness (torque) for wheel nuts or bolts and tightening sequence is listed in the Inspection, Service and Maintenance section of this manual. Use a torque wrench to tighten the lug nuts and use the crisscross star pattern sequence. Improper tightening of the lug nuts voids the axle warranty.

Wheel nuts or bolts are also prone to loosen after first being assembled. When driving a new trailer (or after wheels have been remounted), check to make sure they are tight after the first 10, 25 and 50 miles of driving and before each tow thereafter.

Failure to perform this check can result in a wheel separating from the trailer and a crash, leading to death or serious injury.

## **WARNING**

**Wheel nuts or bolts are prone to loosen after being first assembled. Death or serious injury can result.**

**Check wheel nuts or bolts for tightness on a new trailer, and after re-mounting a wheel at 10, 25 and 50 miles.**

## **WARNING**

**Inadequate wheel nut or bolt torque can cause a wheel to separate from the trailer, leading to death or serious injury.**

**Verify wheel nuts or bolts are tight before each tow.**

### 2.2.9 Improper Loading

The total weight of the load you put on the trailer, plus the empty weight of the trailer itself, must not exceed the trailer's Gross Vehicle Weight Rating (GVWR).

If you do not know the empty weight of the trailer plus the cargo weight, you must weigh the loaded trailer at a commercial scale. In addition, you must distribute the load in the trailer such that the load on any axle does not exceed the Gross Axle Weight Rating (GAWR).

If your trailer is equipped with a Tire & Loading Information Placard, mounted next to the Certification / VIN label, the cargo capacity weight stated on that placard is only a close estimate. The GVWR and GAWR are listed on the Certification / VIN label normally located on the front left side of the trailer.

## **WARNING**

**An overloaded trailer can result in failure or loss of control of the trailer, leading to death or serious injury.**

**Never load a trailer so that the weight on any tire exceeds its rating.**

**Never exceed the trailer Gross Vehicle Weight Rating (GVWR) or axle Gross Axle Weight Rating (GAWR).**

## 2.2.10 Unsafe Load Distribution

Improper front/rear load distribution can lead to an unstable trailer or poor tow vehicle handling. Poor trailer stability results from tongue weights that are too low, and poor tow vehicle stability results from tongue weights that are too high.

Refer to the “Loading And Unloading” section for more information.

In the following table, the second column shows the rule of thumb percentage of total weight of the trailer plus its cargo (Gross Trailer Weight, or “GTW”) that should appear on the tongue of the trailer. For example, a large trailer with a loaded weight of 6,000 pounds, should have 10-15% of 6,000 pounds (600-900 lbs.) on the hitch.

Tongue Weight as a Percentage of Loaded Trailer Weight	
Type of Hitch	Percentage
Ball Hitch or Ring & Pintle	10-15% for large trailers 6-10% for small trailers

The numbers quoted are for example purposes only and should be tailored to the specific trailer.

For questions regarding the actual percent of tongue weight for the trailer, check with the manufacturer for specifics.

After loading, be sure to check that none of the axles are overloaded.

Uneven left/right load distribution can cause tire, wheel, axle or structural failure.

Be sure your trailer is evenly loaded left/right. Towing stability also depends on keeping the center of gravity as low as possible.



### WARNING

**Improper tongue weight (load distribution) can result in loss of control of the trailer, leading to death or serious injury.**

**Make certain that tongue weight is within the allowable range.**

**Be sure to:**

- **Distribute the load evenly, right and left.**
- **Keep the center of gravity low.**
- **Distribute the load front-to-rear to provide proper tongue weight (see chart).**

## 2.2.11 Shifting Cargo

Since the trailer “ride” can be bumpy and rough, you must secure the cargo so that it does not shift while the trailer is being towed.



### WARNING

**A shifting load can result in failure, or to loss of control of the trailer, and can lead to death or serious injury.**

**You must tie down all loads with proper sized fasteners, chains, straps, etc. to prevent the load from shifting while towing.**

## 2.2.12 Inappropriate Cargo

The trailer may be designed for specific cargo. If your trailer is designed for specific cargo, only carry that cargo in the trailer. A trailer must not be used to carry certain items, such as people, containers of hazardous substances or containers of flammable substances.



### WARNING

**Do not transport people on your trailer. Besides putting their lives at risk, the transport of people on a trailer is illegal.**



## WARNING

**Do not transport flammable, explosive, poisonous or other dangerous materials on your trailer.**

**The exception is fuel in the tank of a vehicle or equipment being hauled.**

### 2.2.13 Inoperable Brakes Or Lights

If your trailer has electric brakes, your tow vehicle will have an electric brake controller that sends power to the trailer brakes.

Before towing the trailer, you must operate the brake controller while trying to pull the trailer in order to confirm that the electric brakes operate. While towing the trailer at less than 5 mph, manually operate the electric brake controller in the tow vehicle cab. You should feel the operation of the trailer brakes.

If your trailer has hydraulic “surge” brakes, pull the emergency breakaway brake lanyard to check the operation of the surge mechanism.

Be sure that the electric brakes and all of the lights on your trailer are functioning properly before towing the trailer. Electric brakes and lights on a trailer are controlled via a connection to the tow vehicle, generally a multi-pin electrical connector.



## WARNING

**Improper electrical connection between the tow vehicle and the trailer will result in inoperable lights and electric brakes, and can lead to collision.**

**Before each tow:**

- **Check that the electric brakes work by operating the brake controller inside the tow vehicle.**
- **Check that all lights and turn signals work.**

You must provide mirrors that allow you to safely observe approaching traffic. Standard mirrors usually do not provide adequate visibility for viewing traffic to the sides and rear a towed trailer.

### 2.2.14 Trailer Modifications

Modification of the trailer structure or alteration of your trailer can make the trailer unsafe and will void all warranty options. Before making any alteration to the trailer, contact your dealer or the manufacturer and describe the alteration you are contemplating.

### 2.2.15 Trailer Towing Guide

Driving a vehicle with a trailer in tow is vastly different from driving the same vehicle without a trailer in tow. Acceleration, maneuverability and braking are all diminished with a trailer in tow. It takes longer to get up to speed; you need more room to turn and pass, and more distance to stop when towing a trailer.

You will need to spend time adjusting to the different feel and maneuverability of the tow vehicle with a loaded trailer. Because of the significant differences in all aspects of maneuverability when towing a trailer, the hazards and risks of injury are also much greater than when driving without a trailer.

You are responsible for keeping your vehicle and trailer in control, and for all the damage that is caused if you lose control of your vehicle and trailer.

Find an open area with little or no traffic for your first practice. Before you start towing the trailer, you must follow all of the instructions for inspection, testing, loading and coupling. Also, before you start towing, adjust the mirrors so you can see the trailer as well as the area to the rear of it.

Drive slowly at first, 5 mph or so, and turn the wheel to get the feel of how the tow vehicle and trailer combination responds. Next, make some right and left hand turns. Watch in your side mirrors to see how the trailer follows the tow vehicle. Turning with a trailer attached requires more room.

Stop the rig a few times from speeds no greater than 10 mph. If your trailer is equipped with brakes, try using different combinations of trailer/electric brake and tow vehicle brake. Note the effect that the trailer brakes have when they are the only brakes used. When properly adjusted, the trailer brakes will come on just before the tow vehicle brakes.

It will take practice to learn how to back up a tow vehicle with a trailer attached. Take it slow. Before backing up, get out of the tow vehicle and look behind the trailer to make sure that there are no obstacles.

Some drivers place their hands at the bottom of the steering wheel, and while the tow vehicle is in reverse, “think” of the hands as being on the top of the wheel. When the hands move to the right (counter-clockwise, as you would do to turn the tow vehicle to the left when moving forward), the rear of the trailer moves to the right.

Conversely, rotating the steering wheel clockwise with your hands at the bottom of the wheel will move the rear of the trailer to the left, while backing up. Be careful not to allow the trailer to turn too much, because it will hit the rear of the tow vehicle. To straighten the rig, either pull forward, or turn the steering wheel in the opposite direction.

## **2.2.16 Safe Trailer Towing Guidelines**

Before towing, check coupling, safety chain, brakes, tires, wheels and lights.

Check the lug nuts or bolts for tightness.  
Recheck the load tie downs to make sure the load will not shift during towing.

Check coupler tightness after towing 50 miles.

Adjust the brake controller to engage the trailer brakes before the tow vehicle brakes. Follow the brake controller manufacturer’s literature.

Use your mirrors to verify that you have room to change lanes or pull into traffic.

Use your turn signals well in advance.

Allow plenty of stopping space for your trailer and tow vehicle.

Use lower gears for climbing and descending grades.

Do not ride the brakes while descending grades; they may get so hot that they stop working. Then you will potentially have a runaway tow vehicle and trailer.

Do not apply the tow vehicle brakes to correct extreme trailer swaying. Instead, lightly apply the trailer brakes with the hand controller.

Make regular stops, about once each hour. Confirm that:

- The coupler is secure to the hitch and is locked.
- Electrical connectors are made.
- There is appropriate slack in safety chains.
- There is appropriate slack in breakaway lanyard.

- The tires are not visibly low on pressure.
- The cargo is secure and in good condition.

Slow down for bumps in the road.

Do not brake while in a curve unless absolutely necessary. Instead, slow down before you enter the curve.

Do not drive so fast that the trailer begins to sway due to speed. Generally never drive faster than 55 m.p.h.

Allow plenty of room for passing. A rule of thumb is that the passing distance with a trailer is 4 times the passing distance without a trailer.

## 2.2.17 Safety Warning Labels On Your Trailer

Depending on trailer configuration, your trailer may not be equipped with all safety labels shown.

<h3>⚠ WARNING</h3>	
<p>Uncoupling will cause trailer to come loose from tow vehicle. You must:</p> <ol style="list-style-type: none"> <li>1. CHECK that ball LOAD RATING is same as or greater than coupler LOAD RATING.</li> <li>2. CHECK that ball SIZE is same as coupler.</li> <li>3. CLOSE COUPLER CLAMP on ball.</li> <li>4. LIFT coupler upwards to test that it will not separate from ball.</li> <li>5. LOCK coupler clamp with pin or padlock.</li> </ol> <p>© 2002 NATM</p>	

<h3>⚠ WARNING</h3>	
<p>Uncoupling will cause trailer to come loose from tow vehicle. You must:</p> <ol style="list-style-type: none"> <li>1. CHECK that ball LOAD RATING is same or greater than coupler LOAD RATING.</li> <li>2. CHECK that ball SIZE is same as coupler.</li> <li>3. CLOSE COUPLER CLAMP on ball.</li> <li>4. LIFT coupler upwards to test that it will not separate from ball.</li> <li>5. LOCK sleeve with pin or padlock.</li> </ol> <p>© 2002 NATM</p>	

<h3>⚠ WARNING</h3>	
<p>Uncoupling will cause trailer to come loose from tow vehicle.</p> <ol style="list-style-type: none"> <li>1. CHECK that pintle LOAD RATING is same or greater than ring LOAD RATING.</li> <li>2. LOCK the clamp in place using a pin or lock.</li> </ol> <p>© 2002 NATM</p>	

<h3>⚠ WARNING</h3>	
<p><b>ALWAYS</b> use safety chains. Chains hold trailer if connection fails. You must:</p> <ol style="list-style-type: none"> <li>1. CROSS chains underneath coupler.</li> <li>2. ALLOW slack for trailer to turn.</li> <li>3. ATTACH chain hooks securely to tow vehicle frame.</li> </ol> <p>© 2002 NATM</p>	

<h3>⚠ WARNING</h3>	
<p><b>ALWAYS</b> use safety chains. Chains hold trailer if connection fails. You must:</p> <ol style="list-style-type: none"> <li>1. CROSS chains underneath coupler.</li> <li>2. ALLOW slack for trailer to turn.</li> <li>3. ATTACH chain hooks securely to tow vehicle frame.</li> </ol> <p>© 2002 NATM</p>	

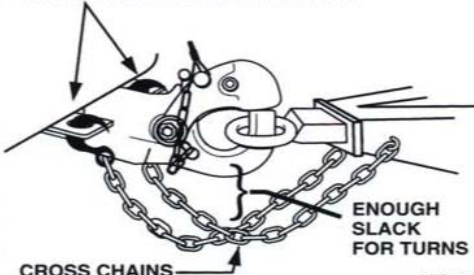
<h2 style="margin: 0;">⚠ WARNING</h2>	<b>ATTACH TO TOW VEHICLE FRAME</b>
<p><b>ALWAYS</b> use safety chains. Chains hold trailer if connection fails. You must:</p> <ol style="list-style-type: none"> <li>1. <b>CROSS</b> chains underneath coupler.</li> <li>2. <b>ALLOW</b> slack for trailer to turn.</li> <li>3. <b>ATTACH</b> chain hooks securely to tow vehicle frame.</li> </ol>	
© 2002 NATM	UT0034

<h2 style="margin: 0;">⚠ WARNING</h2>	<b>Attach To Tow Vehicle    Break-away Brake Chain    Check Fluid Level</b>
<p>Trailer can roll if it comes loose. Safety brake applies when chain pulls brake lever.</p> <ol style="list-style-type: none"> <li>1. <b>ATTACH</b> brake <b>CHAIN</b> securely to tow vehicle so lever will be pulled if trailer separates.</li> <li>2. <b>CHECK</b> brake fluid level.</li> <li>3. <b>DO NOT TOW</b> trailer if brake fluid is <b>NOT FULL</b>.</li> </ol>	
© 2002 NATM	UT0028

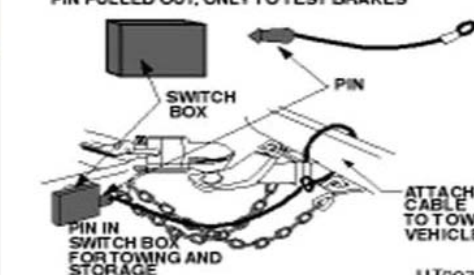
<h2 style="margin: 0;">⚠ WARNING</h2>	<b>PIN PULLED OUT, ONLY TO TEST BRAKES</b>
<p>Trailer can roll if it comes loose. Electric safety brake applies when cable pulls pin out of switch box:</p> <ol style="list-style-type: none"> <li>1. <b>PULL</b> hard to get pin out of switch box.</li> <li>2. <b>CHECK</b> brake by <b>PULLING TRAILER</b> with tow vehicle.</li> <li>3. <b>ATTACH</b> pin <b>CABLE</b> to tow vehicle so pin will be pulled out if trailer separates.</li> <li>4. Promptly <b>REPLACE</b> pin in switch box.</li> </ol>	
© 2002 NATM	UT0037

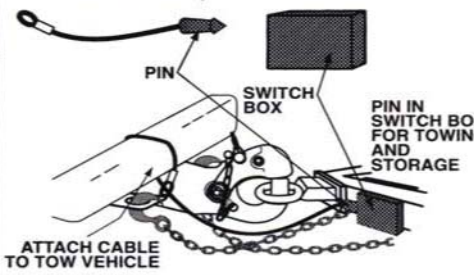
<h2 style="margin: 0;">⚠ WARNING</h2>	<b>PIN PULLED OUT, ONLY TO TEST BRAKES</b>
<p>Trailer can roll if it comes loose. Electric safety brake applies when cable pulls pin out of switch box:</p> <ol style="list-style-type: none"> <li>1. <b>PULL</b> hard to get pin out of switch box.</li> <li>2. <b>CHECK</b> brake by <b>PULLING TRAILER</b> with tow vehicle.</li> <li>3. <b>ATTACH</b> pin <b>CABLE</b> to tow vehicle so pin will be pulled out if trailer separates.</li> <li>4. Promptly <b>REPLACE</b> pin in switch box.</li> </ol>	
© 2002 NATM	UT0035

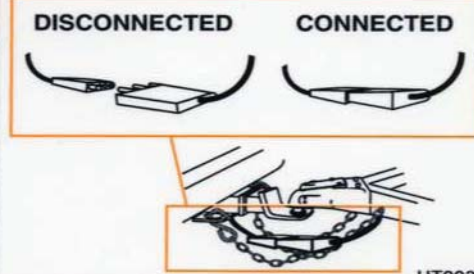
<h2 style="margin: 0;">⚠ WARNING</h2>	<b>DISCONNECTED    CONNECTED</b>
<p>Lights can prevent trailer from being hit by other vehicles. You must:</p> <ol style="list-style-type: none"> <li>1. <b>CONNECT</b> trailer and tow vehicle electrical connectors.</li> <li>2. <b>CHECK</b> all lights: tail lights, turn signal, and brake lights.</li> <li>3. <b>DO NOT TOW</b> if lights are not working.</li> </ol>	
© 2002 NATM	UT0026

<h2 style="margin: 0;">⚠ WARNING</h2>	<p style="text-align: center;">PIN PULLED OUT, ONLY TO TEST BRAKES</p>
<p>Trailer can roll if it comes loose. Electric safety brake applies when cable pulls pin out of switch box.</p> <ol style="list-style-type: none"> <li>1. <b>PULL</b> hard to get pin out of switch box.</li> <li>2. <b>CHECK</b> brake by <b>PULLING TRAILER</b> with tow vehicle.</li> <li>3. <b>ATTACH</b> pin <b>CABLE</b> to tow vehicle so pin will be pulled out if trailer separates.</li> <li>4. Promptly <b>REPLACE</b> pin in switch box.</li> </ol> <p>© 2002 NATM</p>	<p>UT0014</p>

<h2 style="margin: 0;">⚠ WARNING</h2>	
<p>Improper loading can cause trailer sway and sudden loss of control. You must:</p> <ul style="list-style-type: none"> <li>• Make certain weight of load plus trailer weight does not exceed trailer's capacity (GVWR-Gross Vehicle Weight Rating).</li> <li>• Load heavier items in front of wheels.</li> <li>• Load evenly side to side.</li> <li>• <b>SECURE</b> load to trailer.</li> </ul> <p>© 2002 NATM</p>	<p>UT0017</p>

<h2 style="margin: 0;">⚠ WARNING</h2>	
<p>Tire, wheel or lugnut failure can cause loss of control. Before towing, you must <b>CHECK</b>:</p> <ol style="list-style-type: none"> <li>1. Tire pressure and tread.</li> <li>2. Tires and wheels for damage.</li> <li>3. Lug nuts for tightness.</li> </ol> <p style="padding-left: 20px;">For new and remounted wheels, re-tighten lug nuts at the first 10, 25 and 50 miles of driving.</p> <p>© 2002 NATM</p>	<p>UT0019</p>

<h2 style="margin: 0;">⚠ WARNING</h2>	<p><b>MAXIMUM LOADED TRAILER WEIGHT (GVWR) = EQUALS</b></p> <div style="text-align: center; border: 1px solid black; padding: 5px; width: fit-content; margin: 0 auto;"> <p><b>MAXIMUM CARGO WEIGHT</b></p> <p><b>+ PLUS</b></p> <p><b>WEIGHT OF EMPTY TRAILER</b></p> </div>
<p><b>OVERLOAD HAZARD</b> RISK OF DEATH DUE TO LOSS OF CONTROL NEVER EXCEED GROSS VEHICLE WEIGHT RATING (GVWR)</p> <p>● BEFORE LOADING THE TRAILER FOR THE FIRST TIME, YOU MUST VERIFY ITS CARGO CAPACITY:</p> <ol style="list-style-type: none"> <li>1. You <b>MUST WEIGH</b> the <b>EMPTY TRAILER</b>.</li> <li>2. Subtract the weight of the <b>EMPTY TRAILER</b> from the <b>MAXIMUM LOADED TRAILER WEIGHT (GVWR)</b> (see VIN / SERIAL NO. tag).</li> <li>3. <b>DO NOT LOAD TRAILER BEYOND VERIFIED CARGO CAPACITY.</b></li> </ol>	<p>291758</p>

<h2 style="margin: 0;">⚠ WARNING</h2>
<p>To protect you and others against death or serious injury, all applicable labels shown must be on the trailer and must be legible.</p> <p>If any of these labels are missing or cannot be read, contact your dealer for replacement labels.</p>

## **2.2.18 Reporting Safety Defects**

If you believe that your vehicle has a defect that could cause a crash or could cause injury or death, you should immediately inform the National Highway Traffic Safety Administration (NHTSA) in addition to notifying

Best Trailer, Inc.

If NHTSA receives similar complaints, it may open an investigation, and if it finds that a safety defect exists in a group of vehicles, it may order a recall and remedy campaign. However, NHTSA cannot become involved in individual problems between you, your dealer, or

Best Trailer, Inc.

To contact NHTSA, you may call the Vehicle Safety Hotline toll-free at 1-888-327-4236 (TTY: 1-800-424-9153); or go to <http://www.safercar.gov>; or write to:

Administrator, NHTSA,  
1200 New Jersey SE,  
Washington, DC 20590.

You can also obtain other information about motor vehicle safety from <http://www.safercar.gov>.



## 3. Tire Safety Information

This portion of the User's Manual contains tire safety information as required by 49 CFR 575.6.

Section 3.1 contains "Trailer Tire Information".

Section 3.2 contains "Steps for Determining Correct Load Limit - Trailer".

Section 3.3 contains "Steps for Determining Correct Load Limit – Tow Vehicle".

Section 3.4 contains a Glossary of Tire Terminology, including "cold inflation pressure", "maximum inflation pressure", "recommended inflation pressure", and other non-technical terms.

Section 3.5 contains information from the NHTSA brochure entitled "Tire Safety – Everything Rides On It".

This brochure, as well as preceding subsections, describes the following items;

- Tire labeling, including a description and explanation of each marking on the tires, and information about the DOT Tire Identification Number (TIN).
- Recommended tire inflation pressure, including a description and explanation of:
  - A. Cold inflation pressure.
  - B. Vehicle Placard and location on the vehicle.
  - C. Adverse safety consequences of under inflation (including tire failure).
  - D. Measuring and adjusting air pressure for proper inflation.
- Tire Care, including maintenance and safety practices.
- Vehicle load limits, including a description and explanation of the following items:
  - A. Locating and understanding the load limit information, total load capacity, and cargo capacity.
  - B. Calculating total and cargo capacities with varying seating configurations including quantitative examples showing / illustrating how the vehicles cargo and luggage capacity decreases as combined number and size of occupants' increases. This item is also discussed in Section 3.
  - C. Determining compatibility of tire and vehicle load capabilities.
  - D. Adverse safety consequences of overloading on handling and stopping on tires.

## 3.1 Trailer Tire Information

Trailer tires may be worn out even though they still have plenty of tread left. This is because trailer tires have to carry a lot of weight all the time, even when not in use.

It is actually better for the tire to be rolling down the road than to be idle. During use, the tire releases lubricants that are beneficial to tire life. Using the trailer tires often also helps prevent flat spots from developing.

The main cause of tire failure is improper inflation. Check the cold tire inflation pressures at least once a week for proper inflation levels. "Cold" means that the tires are at the same temperature as the surrounding air, such as when the vehicle has been parked overnight. Wheel and tire manufacturers recommend adjusting the air pressure to the trailer manufacturer's recommended cold inflation pressure, in pounds per square inch (PSI) stated on the vehicle's Federal Certification Label or Tire Placard when the trailer is loaded to its gross vehicle weight rating (GVWR).

If the tires are inflated to less than the recommended inflation level or the GVWR of the trailer is exceeded, the load carrying capacity of the tire could be dramatically affected. If the tires are inflated more than the recommended inflation level, handling characteristics of the tow vehicle/trailer combination could be affected. Refer to the owner's manual or talk to your dealer or vehicle manufacturer if you have any questions regarding proper inflation practices.

Tires can lose air over a period of time. In fact, tires can lose 1 to 3 PSI per month. This is because molecules of air, under pressure, weave their way from the inside of the tire, through the rubber, to the outside. A drop in tire pressure could cause the tire to become overloaded, leading to excessive heat build up. If a trailer tire is under-inflated, even for a short period of time, the tire could suffer internal damage.

High speed towing in hot conditions degrades trailer tires significantly. As heat builds up during driving, the tire's internal structure starts to breakdown, compromising the strength of the tire. It is recommended to drive at moderate speeds.

Statistics indicate the average life of a trailer tire is about five years under normal use and maintenance conditions. After three years, replacing the trailer tires with new ones should be considered, even if the tires have adequate tread depth. Some experts claim that after five years, trailer tires are considered worn

# Tire Safety

out and should be replaced, even if they have had minimal or no use. This is such a general statement that it may not apply in all cases. It is best to have your tires inspected by a tire supplier to determine if your tires need to be replaced.

If you are storing your trailer for an extended period, make sure the tires are fully inflated to the maximum rated pressure and that you store them in a cool, dry place, such as a garage. Use tire covers to protect the trailer tires from the harsh effects of the sun.

## 3.2 Steps For Determining Correct Load Limit - Trailer

Determining the load limits of a trailer includes more than understanding the load limits of the tires alone. On all trailers there is a Federal Certification / VIN label that is located on the forward half of the left (road) side of the unit. This certification/VIN label will indicate the trailer's Gross Vehicle Weight Rating (GVWR). This is the most weight the fully loaded trailer can weigh. It will also provide the Gross Axle Weight Rating (GAWR). This is the most a particular axle can weigh. If there are multiple axles, the GAWR of each axle will be provided.

If your trailer has a GVWR of 10,000 pounds or less, there is a vehicle placard located in the same location as the certification label described above. This placard provides tire and loading information. In addition, this placard will show a statement regarding maximum cargo capacity.

Cargo can be added to the trailer, up to the maximum weight specified on the placard. The combined weight of the cargo is provided as a single number. In any case, remember: the total weight of a fully loaded trailer can not exceed the stated GVWR.

When loading your cargo, be sure it is distributed evenly to prevent overloading front to back and side to side. Heavy items should be placed low and as close to the axle positions as reasonable. Too many items on one side may overload a tire. The best way to know the actual weight of the vehicle is to weigh it at a public scale. Talk to your dealer to discuss the weighing methods needed to capture the various weights related to the trailer. This would include the weight empty or unloaded, weights per axle, wheel, hitch or king-pin, and total weight.

Excessive loads and/or under inflation cause tire overloading and, as a result, normal tire flexing

occurs. This situation can generate an excessive amount of heat within the tire. Excessive heat may lead to tire failure. It is the air pressure that enables a tire to support the load, so proper inflation is critical. The proper air pressure may be found on the Certification / VIN label and/or on the Tire Placard. This value should never exceed the maximum cold inflation pressure stamped on the tire.

### 3.2.1 Trailers 10,000 Pounds GVWR Or Less

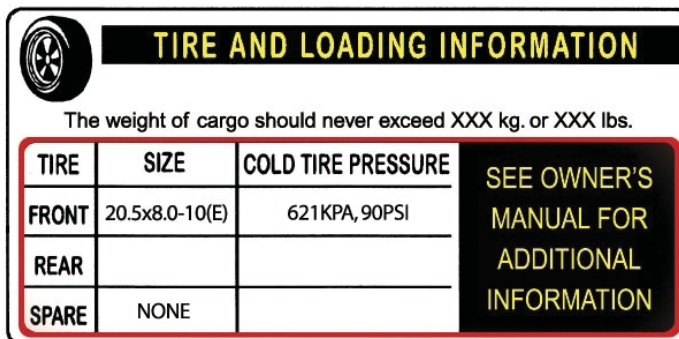

The weight of cargo should never exceed XXX kg. or XXX lbs.

TIRE	SIZE	COLD TIRE PRESSURE	SEE OWNER'S MANUAL FOR ADDITIONAL INFORMATION
FRONT	20.5x8.0-10(E)	621KPA, 90PSI	
REAR			
SPARE	NONE		

1. Locate the statement, "The weight of cargo should never exceed XXX kg or XXX lbs.," on your vehicle's placard.
2. This figure equals the available amount of cargo and luggage load capacity.
3. Determine the combined weight of luggage and cargo being loaded on the vehicle. That weight may not safely exceed the available cargo and luggage load capacity.
4. The trailer's placard refers to the Tire Information Placard attached adjacent to or near the trailer's VIN (Certification) label at the left front of the trailer.

### 3.2.2 Trailers Over 10,000 Pounds GVWR

(Note: These trailers are not required to have a tire information placard on the trailer and may not have one installed)

1. Determine the empty weight of your trailer by weighing the trailer using a public scale or other means.
2. Locate the GVWR (Gross Vehicle Weight Rating) of the trailer on your trailer's VIN (Certification) label.
3. Subtract the empty weight of your trailer from the GVWR stated on the VIN label. That weight is the maximum available cargo capacity of the trailer and may not be safely exceeded. Safety Administration (NHTSA) in addition to notifying us.

## 3.3 Steps For Determining Correct Load Limit - Tow Vehicle

1. Locate the statement, "The combined weight of occupants and cargo should never exceed XXX lbs.," on your vehicle's placard.
2. Determine the combined weight of the driver and passengers who will be riding in your vehicle.
3. Subtract the combined weight of the driver and passengers from XXX kilograms or XXX pounds.
4. The resulting figure equals the available amount of cargo and luggage capacity. For example, if the "XXX" amount equals 1400 lbs. and there will be five 150 lb. passengers in your vehicle, the amount of available cargo and luggage capacity is 650 lbs. (1400-750 (5 x 150) = 650 lbs.).
5. Determine the combined weight of luggage and cargo being loaded on the vehicle. That weight may not safely exceed the available cargo and luggage capacity calculated in previous step.
6. If your vehicle will be towing a trailer, load from your trailer will be transferred to your vehicle. Consult the tow vehicle's manual to determine how this weight transfer reduces the available cargo and luggage capacity of your vehicle.

## 3.4 Glossary Of Tire Terminology

**Accessory weight:** The combined weight (in excess of those standard items which may be replaced) of automatic transmission, power steering, power brakes, power windows, power seats, radio and heater, to the extent that these items are available as factory-installed equipment (whether installed or not).

**Bead:** The part of the tire that is made of steel wires, wrapped or reinforced by ply cords and that is shaped to fit the rim.

**Bead separation:** This is the breakdown of the bond between components in the bead.

**Bias ply tire:** A pneumatic tire in which the ply cords that extend to the beads are laid at alternate angles substantially less than 90 degrees to the centerline of the tread.

**Carcass:** The tire structure, except tread and sidewall rubber which, when inflated, bears the load.

**Chunking:** The breaking away of pieces of the tread or sidewall.

**Cold inflation pressure:** The pressure in the tire before you drive.

**Cord:** The strands forming the plies in the tire.

**Cord separation:** The parting of cords from adjacent rubber compounds.

**Cracking** Any parting within the tread, sidewall, or inner liner of the tire extending to cord material.

**CT:** A pneumatic tire with an inverted flange tire and rim system in which the rim is designed with rim flanges pointed radially inward and the tire is designed to fit on the underside of the rim in a manner that encloses the rim flanges inside the air cavity of the tire.

**Curb weight:** The weight of a motor vehicle with standard equipment including the maximum capacity of fuel, oil, and coolant, and, if so equipped, air conditioning and additional weight optional engine.

**Extra load tire:** A tire designed to operate at higher loads and at higher inflation pressures than the corresponding standard tire.

**Groove:** The space between two adjacent tread ribs.

**Gross Axle Weight Rating:** The maximum weight that any axle can support, as published on the Certification / VIN label on the front left side of the trailer. Actual weight determined by weighing each axle on a public scale, with the trailer attached to the towing vehicle.

**Gross Vehicle Weight Rating:** The maximum weight of the fully loaded trailer, as published on the Certification / VIN label. Actual weight determined by weighing trailer on a public scale, without being attached to the towing vehicle.

**Hitch Weight:** The downward force exerted on the hitch ball by the trailer coupler.

**Innerliner:** The layer(s) forming the inside surface of a tubeless tire that contains the inflating medium within the tire.

**Innerliner separation:** The parting of the innerliner from cord material in the carcass.

**Intended outboard sidewall:** The sidewall that contains a white-wall, bears white lettering or bears manufacturer, brand, and/or model name molding that is higher or deeper than the same molding on the other

# Tire Safety

sidewall of the tire or the outward facing sidewall of an asymmetrical tire that has a particular side that must always face outward when mounted on a vehicle.

**Light truck (LT) tire:** A tire designated by its manufacturer as primarily intended for use on lightweight trucks or multipurpose passenger vehicles. May be used on trailers.

**Load rating:** The maximum load that a tire is rated to carry for a given inflation pressure.

**Maximum load rating:** The load rating for a tire at the maximum permissible inflation pressure for that tire.

**Maximum permissible inflation pressure:** The maximum cold inflation pressure to which a tire may be inflated.

**Maximum loaded vehicle weight:** The sum of curb weight, accessory weight, vehicle capacity weight, and production options weight.

**Measuring rim:** The rim on which a tire is fitted for physical dimension requirements.

**Non-pneumatic rim:** A mechanical device which, when a non-pneumatic tire assembly incorporates a wheel, supports the tire, and attaches, either integrally or separably, to the wheel center member and upon which the tire is attached.

**Non-pneumatic spare tire assembly:** A non-pneumatic tire assembly intended for temporary use in place of one of the pneumatic tires and rims that are fitted to a passenger car in compliance with the requirements of this standard.

**Non-pneumatic tire:** A mechanical device which transmits, either directly or through a wheel or wheel center member, the vertical load and tractive forces from the roadway to the vehicle, generates the tractive forces that provide the directional control of the vehicle and does not rely on the containment of any gas or fluid for providing those functions.

**Non-pneumatic tire assembly:** A non-pneumatic tire, alone or in combination with a wheel or wheel center member, which can be mounted on a vehicle.

**Normal occupant weight:** This means 68 kilograms (150 lbs.) times the number of occupants specified in the second column of Table I of 49 CFR 571.110.

**Occupant distribution:** The distribution of occupants in a vehicle as specified in the third column of Table I of 49 CFR 571.110.

**Open splice:** Any parting at any junction of tread, sidewall, or innerliner that extends to cord material.

**Outer diameter:** The overall diameter of an inflated new tire.

**Overall width:** The linear distance between the exteriors of the sidewalls of an inflated tire, including elevations due to labeling, decorations, or protective bands or ribs.

**Pin Weight:** The downward force applied to the 5th wheel or gooseneck ball, by the trailer kingpin or gooseneck coupler.

**Ply:** A layer of rubber-coated parallel cords.

**Ply separation:** A parting of rubber compound between adjacent plies.

**Pneumatic tire:** A mechanical device made of rubber, chemicals, fabric and steel or other materials, that, when mounted on an automotive wheel, provides the traction and contains the gas or fluid that sustains the load.

**Production options weight:** The combined weight of those installed regular production options weighing over 2.3 kilograms (5 lbs.) in excess of those standard items which they replace, not previously considered in curb weight or accessory weight, including heavy duty brakes, ride levelers, roof rack, heavy duty battery, and special trim.

**Radial ply tire:** A pneumatic tire in which the ply cords that extend to the beads are laid at substantially 90 degrees to the centerline of the tread.

**Recommended inflation pressure:** This is the inflation pressure provided by the vehicle manufacturer on the Tire Information label and on the Certification / VIN tag.

**Reinforced tire:** A tire designed to operate at higher loads and at higher inflation pressures than the corresponding standard tire.

**Rim:** A metal support for a tire or a tire and tube assembly upon which the tire beads are seated.

# Tire Safety

**Rim diameter:** This means the nominal diameter of the bead seat.

**Rim size designation:** This means the rim diameter and width.

**Rim type designation:** This means the industry of manufacturer's designation for a rim by style or code.

**Rim width:** This means the nominal distance between rim flanges.

**Section width:** The linear distance between the exteriors of the sidewalls of an inflated tire, excluding elevations due to labeling, decoration, or protective bands.

**Sidewall:** That portion of a tire between the tread and bead.

**Sidewall separation:** The parting of the rubber compound from the cord material in the sidewall.

**Special Trailer (ST) tire:** The "ST" is an indication the tire is for trailer use only.

**Test rim:** The rim on which a tire is fitted for testing, and may be any rim listed as appropriate for use with that tire.

**Tread:** That portion of a tire that comes into contact with the road.

**Tread rib:** A tread section running circumferentially around a tire.

**Tread separation:** Pulling away of the tread from the tire carcass.

**Treadwear indicators (TWI):** The projections within the principal grooves designed to give a visual indication of the degrees of wear of the tread.

**Vehicle capacity weight:** The rated cargo and luggage load plus 68 kilograms (150 lbs.) times the vehicle's designated seating capacity.

**Vehicle maximum load on the tire:** The load on an individual tire that is determined by distributing to each axle its share of the maximum loaded vehicle weight and dividing by two.

**Vehicle normal load on the tire:** The load on an individual tire that is determined by distributing to each

axle its share of the curb weight, accessory weight, and normal occupant weight (distributed in accordance with Table I of CRF 49 571.110) and dividing by 2.

**Weather side:** The surface area of the rim not covered by the inflated tire.

**Wheel center member:** In the case of a non-pneumatic tire assembly incorporating a wheel, a mechanical device which attaches, either integrally or separably, to the non-pneumatic rim and provides the connection between the nonpneumatic rim and the vehicle; or, in the case of a non-pneumatic tire assembly not incorporating a wheel, a mechanical device which attaches, either integrally or separably, to the non-pneumatic tire and provides the connection between tire and the vehicle.

**Wheel-holding fixture:** The fixture used to hold the wheel and tire assembly securely during testing.

## 3.5 Tire Safety - Everything Rides On It

The National Traffic Safety Administration (NHTSA) has published a brochure (DOT HS 809 361) that discusses all aspects of Tire Safety, as required by CFR 575.6. This brochure is reproduced in part below. It can be obtained and downloaded from NHTSA, free of charge, from the following web site:

[http://www.nhtsa.dot.gov/cars/rules/TireSafety/ridesonit/tires\\_index.html](http://www.nhtsa.dot.gov/cars/rules/TireSafety/ridesonit/tires_index.html)

Studies of tire safety show that maintaining proper tire pressure, observing tire and vehicle load limits (not carrying more weight in your vehicle than your tires or vehicle can safely handle), avoiding road hazards, and inspecting tires for cuts, slashes, and other irregularities are the most important things you can do to avoid tire failure, such as tread separation or blowout and flat tires. These actions, along with other care and maintenance activities, can also:

- Improve vehicle handling
- Help protect you and others from avoidable breakdowns and accidents
- Improve fuel economy
- Increase the life of your tires.

This booklet presents a comprehensive overview of tire safety, including information on the following topics:

- Basic tire maintenance
- Uniform Tire Quality Grading System

# Tire Safety

- Fundamental characteristics of tires
- Tire safety tips.

Use this information to make tire safety a regular part of your vehicle maintenance routine. Recognize that the time you spend is minimal compared with the inconvenience and safety consequences of a flat tire or other tire failure.

## **3.5.1 Safety First- Basic Tire Maintenance**

Properly maintained tires improve the steering, stopping, traction, and load-carrying capability of your vehicle. Underinflated tires and overloaded vehicles are a major cause of tire failure. Therefore, as mentioned above, to avoid flat tires and other types of tire failure, you should maintain proper tire pressure, observe tire and vehicle load limits, avoid road hazards, and regularly inspect your tires.

## **3.5.2 Finding Your Vehicle's Recommended Tire Pressure And Load Limits**

Tire information placards and vehicle certification labels contain information on tires and load limits. These labels indicate the vehicle manufacturer's information including:

- Recommended tire size
- Recommended tire inflation pressure
- Vehicle capacity weight (VCW—the maximum occupant and cargo weight a vehicle is designed to carry)
- Front and rear gross axle weight ratings (GAWR—the maximum weight the axle systems are designed to carry).
- Both placards and certification labels are permanently attached to the trailer near the left front.

## **3.5.3 Understanding Tire Pressure And Load Limits**

Tire inflation pressure is the level of air in the tire that provides it with load-carrying capacity and affects the overall performance of the vehicle. The tire inflation pressure is a number that indicates the amount of air pressure—measured in pounds per square inch (psi)—a tire requires to be properly inflated. (You will also find this number on the vehicle information placard expressed in kilopascals (kPa), which is the metric measure used internationally.)

Manufacturers of passenger vehicles and light trucks determine this number based on the vehicle's design

load limit, that is, the greatest amount of weight a vehicle can safely carry and the vehicle's tire size. The proper tire pressure for your vehicle is referred to as the "recommended cold inflation pressure." (As you will read below, it is difficult to obtain the recommended tire pressure if your tires are not cold.)

Because tires are designed to be used on more than one type of vehicle, tire manufacturers list the "maximum permissible inflation pressure" on the tire sidewall. This number is the greatest amount of air pressure that should ever be put in the tire under normal driving conditions.

## **3.5.4 Safety First- Basic Tire Maintenance**

It is important to check your vehicle's tire pressure at least once a month for the following reasons:

- Most tires may naturally lose air over time.
- Tires can lose air suddenly if you drive over a pothole or other object or if you strike the curb when parking.
- With radial tires, it is usually not possible to determine under inflation by visual inspection.

For convenience, purchase a tire pressure gauge to keep in your vehicle. Gauges can be purchased at tire dealerships, auto supply stores, and other retail outlets. The recommended tire inflation pressure that vehicle manufacturers provide reflects the proper psi when a tire is cold. The term cold does not relate to the outside temperature. Rather, a cold tire is one that has not been driven on for at least three hours. When you drive, your tires get warmer, causing the air pressure within them to increase. Therefore, to get an accurate tire pressure reading, you must measure tire pressure when the tires are cold or compensate for the extra pressure in warm tires.

## **3.5.5 Steps For Maintaining Proper Tire Pressure**

1. Locate the recommended tire pressure on the vehicle's tire information placard, certification label, or in the owner's manual.
2. Record the tire pressure of all tires.
3. If the tire pressure is too high in any of the tires, slowly release air by gently pressing on the tire valve stem with the edge of your tire gauge until you get to the correct pressure.
4. If the tire pressure is too low, note the difference between the measured tire pressure and the correct tire pressure. These "missing" pounds of pressure are what you will need to add.

# Tire Safety

5. At a service station, add the missing pounds of air pressure to each tire that is under inflated.
6. Check all the tires to make sure they have the same air pressure except in cases in which the front and rear tires are supposed to have different amounts of pressure).

If you have been driving your vehicle and think that a tire is under inflated, fill it to the recommended cold inflation pressure indicated on your vehicle's tire information placard or certification label. While your tire may still be slightly under inflated due to the extra pounds of pressure in the warm tire, it is safer to drive with air pressure that is slightly lower than the vehicle manufacturer's recommended cold inflation pressure than to drive with a significantly under inflated tire. Since this is a temporary fix, don't forget to recheck and adjust the tire's pressure when you can obtain a cold reading.

## 3.5.6 Tire Size

To maintain tire safety, purchase new tires that are the same size as the vehicle's original tires or another size recommended by the manufacturer. Look at the tire information placard, the owner's manual, or the sidewall of the tire you are replacing to find this information. If you have any doubt about the correct size to choose, consult with the tire dealer.

## 3.5.7 Tire Tread

The tire tread provides the gripping action and traction that prevent your vehicle from slipping or sliding, especially when the road is wet or icy. In general, tires are not safe and should be replaced when the tread is worn down to 2/32 of an inch. Tires have built-in tread wear indicators that let you know when it is time to replace your tires. These indicators are raised sections spaced intermittently in the bottom of the tread grooves. When they appear "even" with the outside of the tread, it is time to replace your tires. Another method for checking tread depth is to place a penny in the tread with Lincoln's head upside down and facing you. If you can see the top of Lincoln's head, you are ready for new tires.

## 3.5.8 Tire Balance And Wheel Alignment

To avoid vibration or shaking of the vehicle when a tire rotates, the tire must be properly balanced. This balance is achieved by positioning weights on the wheel to counterbalance heavy spots on the wheel-and-tire assembly. A wheel alignment adjusts the angles of the wheels so that they are positioned

correctly relative to the vehicle's frame. This adjustment maximizes the life of your tires. These adjustments require special equipment and should be performed by a qualified technician.

## 3.5.9 Tire Repair

The proper repair of a punctured tire requires a plug for the hole and a patch for the area inside the tire that surrounds the puncture hole. Punctures through the tread can be repaired if they are not too large, but punctures to the sidewall should not be repaired. Tires must be removed from the rim to be properly inspected before being plugged and patched.

## 3.5.10 Tire Fundamentals

Federal law requires tire manufacturers to place standardized information on the sidewall of all tires. This information identifies and describes the fundamental characteristics of the tire and also provides a tire identification number for safety standard certification and in case of a recall.

### 3.5.10.1 Information on Passenger Vehicle Tires

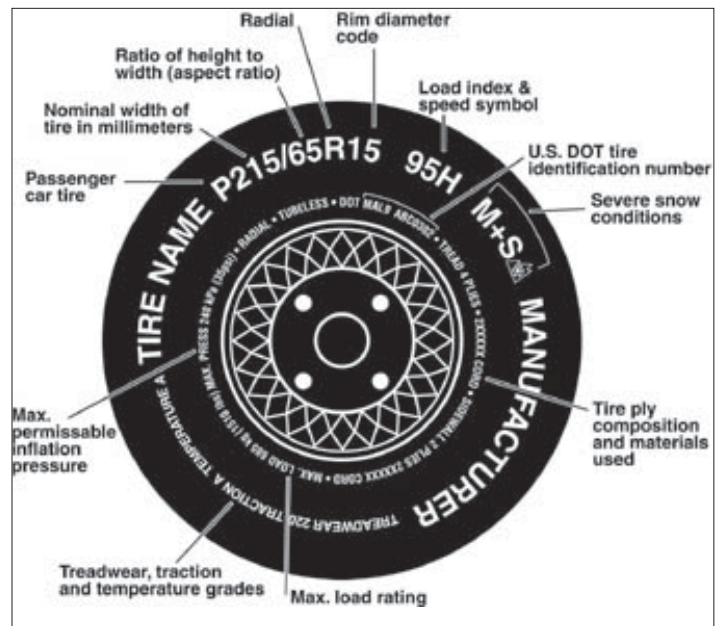

**P:** The "P" indicates the tire is for passenger vehicles.

**Next number:** This three-digit number gives the width in millimeters of the tire from sidewall edge to sidewall edge. In general, the larger the number, the wider the tire.

**Next number:** This two-digit number, known as the aspect ratio, gives the tire's ratio of height to width. Numbers of 70 or lower indicate a short sidewall





**ST:** An “ST” is an indication the tire is for trailer use only.

**Max. Load Dual kg (lbs) at kPa (psi) Cold:** This information indicates the maximum load and tire pressure when the tire is used as a dual, that is, when four tires are put on each rear axle (a total of six or more tires on the vehicle).

**Max. Load Single kg (lbs) at kPa (psi) Cold:** This information indicates the maximum load and tire pressure when the tire is used as a single.

**Load Range:** This information identifies the tire’s load-carrying capabilities and its inflation limits.

### **3.5.10.4 Tire Safety Tips**

#### **Preventing Tire Damage**

- Slow down if you have to go over a pothole or other object in the road.
- Do not run over curbs or other foreign objects in the roadway, and try not to strike the curb when parking.

#### **Tire Safety Checklist**

- Check tire pressure regularly (at least once a month), including the spare.
- Inspect tires for uneven wear patterns on the tread, cracks, foreign objects, or other signs of wear or trauma.
- Remove bits of glass and foreign objects wedged in the tread.
- Make sure your tire valves have valve caps.
- Check tire pressure before going on a long trip.
- Do not overload your vehicle. Check the Tire Information Placard or Owner’s Manual for the maximum recommended load for the vehicle.

## 4. Coupling To Tow Vehicle

Follow all of the safety precautions and instructions in this manual to ensure safety of persons, cargo, and satisfactory life of the trailer.

### 4.1 Tow Vehicle And Hitch

If the vehicle and hitch are not properly selected and matched to the Gross Vehicle Weight Rating (GVWR) of your trailer, you can cause an accident that could lead to death or serious injury. If you already have a tow vehicle, know your vehicle tow rating and make certain the trailer's rated capacity is less than or equal to the tow vehicle's rated towing capacity.

#### DANGER

**Use of a tow vehicle with a towing capacity less than the load rating of the trailer can result in loss of control, and may lead to death or serious injury.**

**Use of a hitch with a load rating less than the load rating of the trailer can result in loss of control and may lead to death or serious injury.**

**Verify hitch and tow vehicle are rated for the Gross Vehicle Weight Rating of your trailer.**

#### 4.1.1 Trailer Information

The Certification/Vehicle Identification Number (VIN) tag is located on the front left side of the trailer.

The trailer Certification/VIN tag contains the following critical safety information for the use of your trailer:

**MANUFACTURER:** Name of trailer manufacturer.

**DATE OF MANUFACTURE:** Month and year the trailer was manufactured.

**GVWR:** The Gross Vehicle Weight Rating is the maximum allowable gross weight of the trailer and its contents. The gross weight of the trailer includes the weight of the trailer and all of the items within it (such as cargo and other supplies).

**GAWR:** The Gross Axle Weight Rating is the maximum gross weight that an axle can support. It is

the lowest of axle, wheel, or tire rating. Sometimes the tire or wheel rating is lower than the axle manufacturers rating, and will then determine GAWR.

The sum total of the GAWR for all trailer axles may be less than the GVWR for the trailer, because some of the trailer load is carried by the tow vehicle, rather than by the trailer axle(s). The total weight of the cargo and trailer must not exceed the GVWR, and the load on an axle must not exceed its GAWR.

**TIRE SIZE:** The tire size and load range for your trailer.

**RIM SIZE:** The rim size and load range for your trailer.

**PSI:** The tire air pressure (kPa / PSI) measured with tires cold.

**VIN:** The Vehicle Identification Number.

**VEHICLE TYPE:** Model or style of trailer.

**CERTIFICATION STATEMENT:** "This trailer meets all the Federal Motor Vehicle Safety Standards in effect on the date of manufacture shown above".

#### 4.1.2 Tow Vehicle

When equipping a new vehicle or an older vehicle to tow a trailer, ask the vehicle dealer for advice on how to outfit the tow vehicle.

Vehicle manufacturers will provide you with the maximum towing capacities of their various models, as well as the GCWR. No amount of reinforcement will give a 100 horsepower, 2,500 pound truck the towing capacity that a 300 horsepower, 5,000 pound truck has.

## 4.2 Coupling And Uncoupling The Trailer

A secure coupling (or fastening) of the trailer to the tow vehicle is essential. A loss of coupling may result in death or serious injury. Therefore, you must understand and follow all of the instructions for coupling.

The following parts are involved in making a secure coupling between the trailer and tow vehicle:

**Coupling:** The trailer connecting mechanism by which the connection is actually made to the trailer hitch. This does not include any structural member, extension of the trailer frame, or brake controller.

# Coupling To Tow Vehicle

**Hitch:** The connecting mechanism including the ball support platform and ball and those components that extend and are attached to the towing vehicle, including bumpers intended to serve as hitches.

**Safety chains:** Chains permanently attached to the trailer such that if the coupler connection comes loose, the safety chains can keep the trailer attached to the tow vehicle. With properly rigged safety chains, it is possible to keep the tongue of the trailer from digging into the road pavement, even if the coupler-to-hitch connection comes apart.

**Trailer lighting (and braking) connector:** A device that connects electrical power from the tow vehicle to the trailer. In addition, if your trailer has a separate braking system, the electrical connector will also supply power to the trailer brakes from the tow vehicle.

**Breakaway switch:** If the trailer becomes uncoupled from the tow vehicle, the breakaway switch lanyard, attached independently to the tow vehicle hitch, will pull a pin in the emergency electrical breakaway switch on the trailer. The breakaway switch is activated by a battery on the trailer to energize the trailer brakes independently of the towing vehicle.

It is important to check the state of charge of the emergency breakaway battery before each trip. Simply pull the pin out of the switch by hand and then try to pull the trailer. If you feel a significant drag force the brakes are activated. Be sure to re-insert the pin in the breakaway switch. Also be sure to allow enough slack in the breakaway brake lanyard such that the switch will only activate (pin pulls out) if the coupler connection comes loose.

**Jack:** A device on the trailer that is used to raise and lower the trailer tongue.



## WARNING

**An improperly coupled trailer can result in death or serious injury. Do not move the trailer until:**

- **Coupler is secured and locked to hitch.**
- **Safety chains are secured to tow vehicle.**
- **Trailer jack(s) are fully retracted.**
- **Trailer brakes are checked.**
- **Tires and wheels are checked.**
- **Breakaway switch is connected to tow vehicle;**
- **The trailer lights are connected and checked.**
- **Load is secured to trailer.**

## 4.3 Couple Trailer To Tow Vehicle

The trailer may be equipped with a ball hitch coupler or a ring & pintle coupler. See the appropriate section for the coupler on your trailer.

### 4.3.1 Ball Hitch Coupler

A ball hitch coupler connects to a ball that is located on or under the rear bumper of tow vehicle.

We have utilized a ball hitch coupler that is suitable for the size and weight of the trailer. The load rating of the coupler and the necessary ball size are listed on the trailer tongue.

You must provide a hitch and ball for your tow vehicle, that meets or exceeds the GVWR of the trailer.

The ball size must be the same as the coupler size. If the hitch ball is too small, too large, is underrated, is loose or is worn, the trailer can come loose from the tow vehicle, and may cause death or serious injury.

**The tow vehicle, hitch and ball must have a rated towing capacity equal to or greater than the trailer gross vehicle weight rating (GVWR).**

**It is essential that the hitch ball be the same size as the coupler.**

The ball size and load rating (capacity) are marked on the ball; hitch capacity is marked on the hitch.

# Coupling To Tow Vehicle

## 4.3.1.1 Before Coupling Trailer To Tow Vehicle

1. Be sure the size and rating of hitch ball match the size and rating of the coupler. Hitch balls and couplers are marked with their size and rating.

### WARNING

**Coupler-to-hitch mismatch can result in uncoupling, leading to death or serious injury.**

**Be sure the LOAD RATING of the hitch ball is equal or greater than the load rating of the coupler.**

**Be sure the SIZE of the hitch ball matches the size of the coupler.**

2. Wipe the hitch ball clean and inspect it visually and by feel for flat spots, cracks and pits.

### WARNING

**A worn, cracked or corroded hitch ball can fail while towing, and may result in death or serious injury.**

**Before coupling trailer, inspect the hitch ball for wear, corrosion and cracks.**

**Replace worn or damaged hitch ball.**

3. Rock the ball to make sure it is tight to the hitch, and visually check that the hitch ball nut is solid against the lock washer and hitch frame.
4. Wipe the inside and outside of the coupler clean and inspect it visually for cracks and deformations; feel the inside of the coupler for worn spots and pits.
5. Be sure the coupler is tight to the tongue of the trailer. All coupler fasteners must be visibly solid against the trailer frame.

### WARNING

**A loose hitch ball nut can result in uncoupling, leading to death or serious injury.**

**Make sure the hitch ball is tight to the hitch before coupling the trailer.**

6. Raise the bottom surface of the coupler to be above the top of the hitch ball.

## 4.3.1.2 PREPARE COUPLER AND HITCH

1. Lubricate hitch ball and inside of coupler with a thin layer of automotive bearing grease.
2. Remove safety latch pin and open coupler locking mechanism. In the open position, coupler is able to drop fully onto hitch ball. See the coupler instructions for details of placing the coupler in the "open" position.
3. Slowly back up tow vehicle so that hitch ball is near or aligned under coupler.

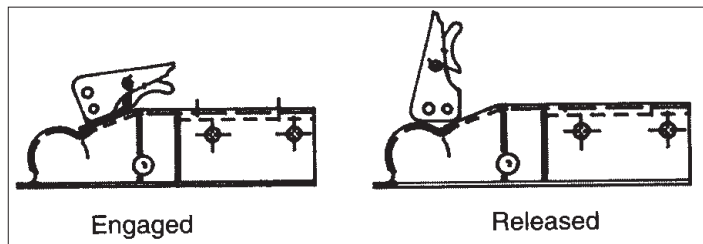

Your trailer may be equipped with a different style coupler. If so, see the coupler manufacturers operating instructions.

## 4.3.1.3 Couple Trailer To Tow Vehicle

1. Lower the trailer tongue until the coupler fully engages the hitch ball. If the coupler does not line up with the hitch ball, adjust the position of the tow vehicle.
2. Close latch and engage the coupler locking mechanism. In the engaged position, the locking mechanism securely holds the coupler to the hitch ball.
3. Insert the safety lock pin through the hole in the locking mechanism.
4. Be sure the coupler is all the way on the hitch ball and the locking mechanism is engaged. A properly engaged locking mechanism will allow the coupler to raise the rear of the tow vehicle. Using the trailer jack, test to see that you can raise the rear of the tow vehicle by 1 inch, after the coupler is locked to the hitch.

### NOTICE

***The tongue jack can be damaged by overloading. Do not use the tongue jack to raise the tow vehicle more than 1 inch.***

5. If the coupler cannot be secured to the hitch ball, do not tow the trailer. Contact your dealer for assistance.

# Coupling To Tow Vehicle

6. Lower the trailer so that its entire tongue weight is held by the hitch, and continue retracting the jack to its fully retracted position.

## CAUTION

**Drop leg jacks may be spring loaded and may rapidly return to the raise position when released.**

**Keep clear when releasing drop legs.**

7. Fully retract jack drop leg if equipped.

**Go to Section 4.3.3 “Connect Safety Chains” to continue connecting trailer to tow vehicle.**

### **4.3.2 Trailer With Ring And Pintle Coupler**

A ring on the trailer connects to the pintle that is located on or under the rear bumper of tow vehicle.

We have utilized a ring that is suitable for the size and weight of the trailer. The load rating of the ring and the necessary pintle size are listed on the trailer tongue.

You must provide a pintle for your tow vehicle, where the load rating of the hitch and pintle is equal to or greater than that of your trailer. The pintle size must be the same as the ring size. If the pintle is too small, too large, is underrated, is loose or is worn, the trailer can come loose from the tow vehicle, and may cause death or serious injury.

**The tow vehicle, hitch and pintle must have a rated towing capacity equal to or greater than the trailer gross vehicle weight rating (GVWR).**

**It is essential that the pintle be the same size as the coupler.**

The pintle size and load rating (capacity) are marked on the pintle; ring capacity is marked on the ring.

#### **4.3.2.1 Before Coupling Trailer To Tow Vehicle**

1. Be sure the size and rating of pintle match the size and rating of the ring. Hitch ring and pintles are marked with their size and rating.

## WARNING

**Ring-to-pintle mismatch can result in uncoupling, leading to death or serious injury.**

**Be sure the LOAD RATING of the pintle is equal or greater than the load rating of the ring.**

**Be sure the SIZE of the pintle matches the size of the ring.**

2. Wipe the pintle clean and inspect it visually and by feel for flat spots, cracks and pits.

## WARNING

**A worn, cracked or corroded pintle can fail while towing, and may result in death or serious injury.**

**Before coupling trailer, inspect the pintle for wear, corrosion and cracks.**

**Replace worn or damaged pintle.**

3. Rock the pintle to make sure it is tight to the hitch, and visually check that the pintle fasteners are solid against the hitch frame.
4. Wipe the inside and outside of the ring clean and inspect it visually for cracks and deformations; feel the inside of the ring for worn spots and pits.
5. Be sure the ring is tight to the tongue of the trailer. All ring fasteners must be visibly solid against the trailer frame.

## WARNING

**A loose pintle can result in uncoupling, leading to death or serious injury.**

**Make sure the pintle is tight to the hitch before coupling the trailer.**

6. Raise the bottom surface of the ring to be above the top of the open pintle.

#### **4.3.2.2 Prepare Ring And Pintle**

1. Lubricate the inside of the pintle with a thin layer of automotive bearing grease.
2. Remove the safety latch pin and open the pintle locking mechanism.

# Coupling To Tow Vehicle

3. In the open position, the ring is able to drop fully onto the pintle.

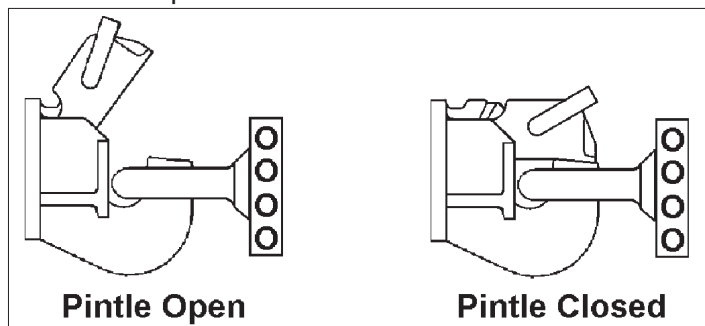

4. See the coupler instructions for details of placing the pintle in the “open” position.
5. Slowly back up the tow vehicle so that the pintle is aligned under the ring.

## 4.3.2.3 COUPLE TRAILER TO TOW VEHICLE

1. Lower the trailer tongue until the ring fully engages the pintle. If the ring does not line up with the pintle, adjust the position of the tow vehicle.
2. Close pintle and engage the pintle locking mechanism. In the engaged position, the locking mechanism securely holds the ring to the pintle.
3. Insert the safety lock pin through the hole in the locking mechanism.
4. Be sure the ring is all the way on the pintle and the locking mechanism is engaged. A properly engaged locking mechanism will allow the pintle to raise the rear of the tow vehicle. Using the trailer jack, test to see that you can raise the rear of the tow vehicle by 1 inch, after the pintle is closed and locked.

### NOTICE

***The tongue jack can be damaged by overloading. Do not use the tongue jack to raise the tow vehicle more than 1 inch.***

5. If the ring cannot be secured to the pintle, do not tow the trailer. Contact your dealer for assistance.
6. Lower the trailer so that its entire tongue weight is held by the hitch, and continue retracting the jack to its fully retracted position.

### CAUTION

**Drop leg jacks may be spring loaded and may rapidly return to the raise position when released.**

**Keep clear when releasing drop legs.**

7. Fully retract jack drop leg if equipped.

**Go to Section 4.3.3 “Connect Safety Chains” to continue connecting trailer to tow vehicle.**

## 4.3.3 Connect Safety Chains

1. Visually inspect the safety chains and hooks for wear or damage. Replace worn or damaged safety chains and hooks before towing.
2. Safety chains must crisscross under the coupler so if the trailer uncouples, the safety chains can hold the tongue up above the road. Loop around a frame member of the tow vehicle or to holes provided in the hitch system, but do not attach them to an interchangeable part of the hitch assembly.
3. Attach hooks up from underneath the hole. Do not just drop into hole.
4. Provide enough slack in chains to permit tight turns, but not be close to the road surface to drag.

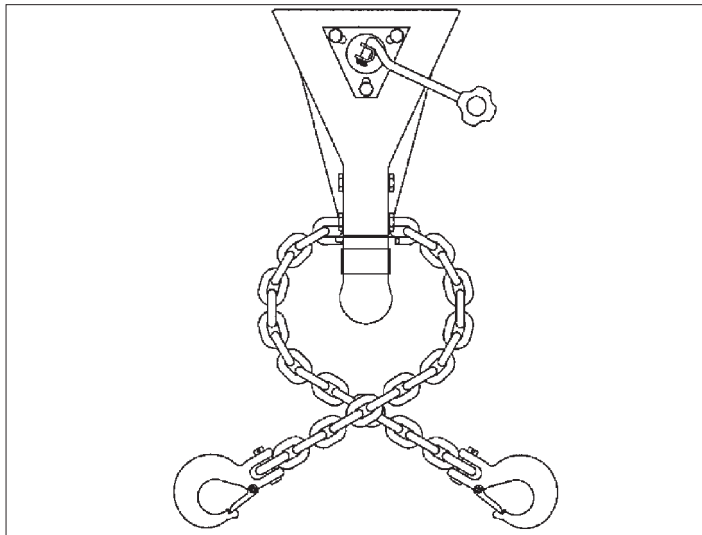

# Coupling To Tow Vehicle



## WARNING

**Improper rigging of the safety chains can result in loss of control of the trailer and tow vehicle, leading to death or serious injury, if the trailer uncouples from the tow vehicle.**

**Cross chains underneath hitch and coupler with enough slack to permit turning and to hold tongue up, if the trailer comes loose.**

**Fasten chains to frame of tow vehicle.**

**Do not fasten chains to any part of the hitch unless the hitch has holes or loops specifically for that purpose.**

### 4.3.4 Connect Electrical Cable

1. Connect the trailer lights to the tow vehicle's electrical system using trailer electrical cable.
2. Check all lights for proper operation. Repair or replace non-working lights before towing trailer.
3. Check electric brakes for proper operation using brake controller mounted in the cab.



## WARNING

**Improper electrical connection between the tow vehicle and the trailer will result in inoperable lights and electric brakes, and can lead to collision.**

**Before each tow:**

- **Check that the electric brakes work by operating the brake controller inside the tow vehicle.**
- **Check that all lights and turn signals work.**

### 4.3.5 Attach Breakaway Brake Lanyard

If the coupler or hitch fails, a properly connected and working breakaway brake system will apply the trailer brakes. The safety chains will keep the tow vehicle attached and as the trailer brakes are applied, the trailer/tow vehicle combination will come to a controlled stop.

Connect the lanyard to the tow vehicle so that the

hydraulic actuator will engage or the electric brake pullpin will be pulled out before all of the slack in the safety chains is taken up. Do not connect the lanyard to a safety chain, hitch ball or hitch ball assembly. This would keep the breakaway brake system from operating when it is needed.

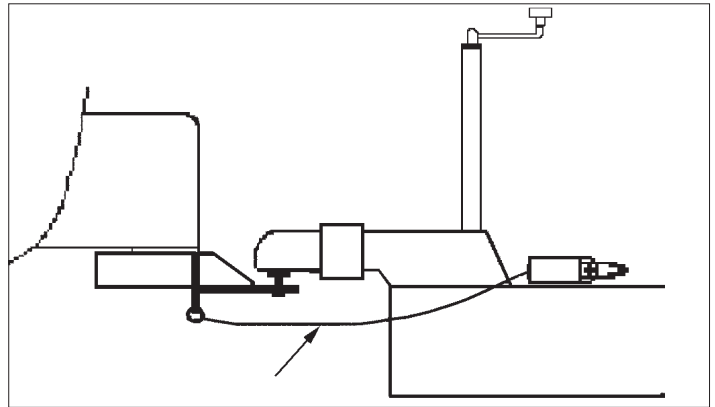

### 4.3.5.1 Test Electric Brakes

If your trailer has electric brakes, your tow vehicle will have an electric brake controller that sends power to the trailer brakes. Before towing the trailer on the road, you must operate the brake controller while trying to pull the trailer in order to confirm that the electric brakes operate.

While towing the trailer at less than 5 mph, manually operate the electric brake controller in the tow vehicle. You should feel the operation of the trailer brakes. If the trailer brakes are not functioning, the brake system **MUST** be evaluated to determine the cause of the problem and corrective action **MUST** be taken before the trailer is used. Take the unit to your dealer or a qualified brake specialist.

Use this procedure each time you tow the trailer to check brake system operation.

### 4.3.5.2 Test Electric Breakaway Brakes

The breakaway brake system includes a battery, a switch with a pullpin and lanyard, and a breakaway brake controller. Read and follow the instructions here as well as the instructions that have been prepared by the breakaway brake manufacturer. If you do not have these instructions, contact your dealer for assistance.

Hydraulic tilt trailers may use the hoist battery to provide power to the breakaway brakes. If your trailer is not setup this way, there will be a small breakaway battery mounted near the breakaway switch.

# Coupling To Tow Vehicle

Most trailers are setup to charge the battery from the tow vehicle. If the electrical system on your tow vehicle does not provide power to the battery, you must periodically charge the battery with a commercial battery charger to keep the battery charged.

## CAUTION

**Extreme cold weather can degrade battery performance and cause brakes to not operate properly.**

**Check battery charge level before towing.**

Do not tow trailer if the battery requires recharging. A discharged brake battery will not activate the brakes if the trailer uncouples from the tow vehicle. The battery must be fully charged before towing trailer.

To test the breakaway brake battery, remove the pullpin from the switch and attempt to pull the trailer forward. You should feel the trailer resisting being towed, but the wheels will not necessarily be locked. If the brakes do not function, do not tow the trailer until brakes, or battery, are repaired.

Immediately replace the pullpin. The breakaway brake battery discharges rapidly when the pullpin is removed.

## WARNING

**An ineffective breakaway brake system can result in a runaway trailer, leading to death or serious injury if the coupler fails.**

**Test the function of the breakaway brake system before towing trailer. Do not tow trailer if breakaway brake system is not working; have it serviced or repaired.**

**Connect breakaway lanyard to the tow vehicle, NOT to the safety chain, ball, pintle, hitch, or support.**

Do not tow the trailer with the breakaway brake system ON because the brakes will overheat which can result in permanent brake failure.

## WARNING

**Failure to replace the pullpin can result in ineffective brakes, leading to loss of control, serious injury or death.**

If you do not use your trailer for three or more months, or during winter months:

- Store the battery indoors; and
- Charge the battery every three months.

Replace the breakaway brake battery according to the intervals specified by battery manufacturer.

### 4.3.5.3 Test Surge Brakes (If Equipped)

Hydraulic surge actuator systems provide automatic and smooth trailer braking without special application by the tow vehicle driver. While this is extremely convenient it can sometimes be difficult to determine if the surge setup is functioning properly. The following steps provide a quick field-test to confirm that the trailer brake system is operational.

## WARNING

**The field-test procedure indicates only if the trailer brake system is functional, but DOES NOT provide information on how efficiently it will operate.**

**Regular inspection, maintenance, and adjustment of all brake system components (including the surge actuator, tubing, hoses, brake clusters, drums, and associated hardware/support structure) are still required to ensure maximum brake performance and smooth, even brake operation.**

Move the trailer to flat, level ground, pulling FORWARD several feet before parking. This forward motion will ensure trailers equipped with free-backing brakes are in their normal operating mode. Disconnect the trailer from the tow vehicle and jack up the trailer's tongue until it is horizontal. Hook the trailer's safety chains (NOT the actuator's breakaway cable) together to form a loop, which is centered below the actuator's coupler. Place wheel chock blocks two feet behind the trailer to prevent a runaway trailer.

Place a sturdy board, such as a 2 inch by 4 inch piece of lumber, into the chain loop below the coupler.



# Coupling To Tow Vehicle

The board should be 4 feet or longer so it will extend several feet above the actuator. Keep the end of the board a few inches off the ground, and position it to press against the front end of the actuator's coupler. Press the board towards the rear of the trailer.

Keep pressing the top of the board to stroke the actuator and its internal master cylinder. If the trailer brake system is operational, the brakes will apply and keep the trailer from rolling away from you. Properly adjusted uni-servo or duo-servo type brakes will prevent you from moving the trailer back more than a few inches. Free-backing type brakes will initially provide rolling resistance, but continued force on the board will switch them into free-backing mode, and you'll be able to move the trailer backwards.

If you have uni-servo or duo-servo brakes, and stroking the actuator (as described above) causes the trailer to roll away from you freely or with only minimal resistance, the brakes are NOT applying properly. If you have free-backing brakes and stroking the actuator (as described above) causes the trailer to roll away without initial resistance, then the brakes are NOT applying properly. The brake system MUST be evaluated to determine the cause of the problem and corrective action MUST be taken before the trailer is used. Use this procedure each time you tow your trailer to check your surge brake system operation.

### 4.3.5.4 Test Surge Breakaway System

Before towing, check that the breakaway lever and lanyard are properly positioned. If the breakaway lever and lanyard are not located correctly due to either the lanyard being pulled during use or by accident, it MUST be reset prior to the trailer being moved.

See the Surge Brake Actuator manual for the correct resetting and testing procedure.



### WARNING

**The breakaway system is designed to operate if the trailer separates from the tow vehicle.**

**DO NOT use the breakaway system as a parking brake.**

## 4.4 Uncouple Trailer

Follow these steps to uncouple trailer from the tow vehicle:

1. Park the trailer on a firm level surface and block trailer tires.
2. Disconnect electrical connector.
3. Disconnect breakaway brake switch lanyard.
4. Disconnect safety chains from tow vehicle.
5. Unlock the coupler and open it.
6. Before extending jack, make certain the ground surface below the jack pad will support the tongue load.
7. Rotate jack handle to extend the jack and transfer the weight of the trailer tongue to the jack.
8. Raise the trailer coupler above the tow vehicle hitch.
9. Drive tow vehicle forward.

## 4.5 Tongue Weight

It is critical to have a portion of the trailer load carried by the tow vehicle. That is, the trailer tongue must exert a downward force on the hitch. This is necessary for two reasons. First, the proper amount of tongue weight is necessary for the tow vehicle to be able to maintain control of the tow vehicle/trailer system. If, for example, the tongue exerts an upward pull on the hitch, instead of pushing down on it (because the trailer is overloaded behind its axle(s)), the rear wheel of the tow vehicle can lose traction or grip and cause loss of control. Also, even if there is some weight on the tongue, but not enough weight on the tongue, the trailer can become unstable at high speeds. Remember, the faster you go the more likely the trailer is to sway.

If there is too much tongue weight, the tow vehicle is prone to jack-knife. The front wheels of the tow vehicle can be too lightly loaded and cause loss of steering control and traction, if the front wheels are driving.

In addition to tow vehicle control, tongue weight is necessary to insure that the trailer axle(s) do not exceed their Gross Axle Weight Rating (GAWR).

In the following table, the second column shows the rule of thumb percentage of total weight of the trailer plus its cargo (Gross Trailer Weight, or "GTW") that should appear on the tongue of the trailer. For example, a large trailer with a loaded weight of 6,000 pounds, should have 10-15% of 6,000 pounds (600-900 lbs.) on the hitch.

Tongue Weight as a Percentage of Loaded Trailer Weight	
Type of Hitch	Percentage
Ball Hitch or Ring & Pintle	10-15% for large trailers 6-10% for small trailers

# Coupling To Tow Vehicle

The numbers quoted are for example purposes only and should be tailored to the specific trailer.

For questions regarding the actual percent of tongue weight for the trailer, check with the manufacturer for specifics.



## WARNING

**Improper tongue weight (load distribution) can result in loss of control of the trailer, leading to death or serious injury.**

**Make certain that tongue weight is within the allowable range.**

**Be sure to:**

- **Distribute the load evenly, right and left.**
- **Keep the center of gravity low.**
- **Distribute the load front-to-rear to provide proper tongue weight (see chart).**

### 4.5.1 Checking Tongue Weight

To check the tongue weight, the tow vehicle and trailer must be on level ground, as they will be when the trailer is being towed.

Take the trailer to a truck stop or grain elevator where there is a “certified” scale. Place the tow vehicle only onto the scale and get the weight. This weight must be less than your tow vehicle’s GVWR.

Pull the trailer onto the scale and uncouple it from the tow vehicle, leaving just the trailer on the scale. Get a ticket which lists the total trailer weight. Re-connect the trailer to your tow vehicle and the drive the tow vehicle wheels off the scale, just leaving the trailer axles on the scale. Get a “ticket”, which lists the trailer’s axle weight. Simply subtract the axle weight from the total weight to determine the hitch weight.

While you are at the scale, you should weigh the entire combination vehicle. This result should be less than the Gross Combined Weight Rating (GCWR) for your towing vehicle. Some scales allow you to get individual axle weights also. If this is possible, get the tow vehicles front and rear axle weights to make sure they are in the same proportion as the tow vehicle alone, and that the rear axle is not overloaded.

## 4.6 Adjust Hitch Height (If Equipped)

The height of the hitch on the trailer must be adjusted so that the trailer, when loaded to rated capacity, is level while connected to the tow vehicle. A level trailer allows equal weight distribution on the axles.

Your dealer or a trailer service center can perform this adjustment or you can use the following steps to adjust the hitch height yourself.

If the trailer is not equipped with an adjustable hitch, an offset ball mount may be available from your hitch manufacturer.



## WARNING

**Improper hitch height adjustment can result in overloaded tires, blowout and loss of control, leading to death or serious injury.**

**Adjust the hitch height so that the loaded trailer is level.**

1. Connect trailer to tow vehicle and load the trailer to rated capacity. See Loading And Unloading.
2. Park the tow vehicle and trailer on a firm level surface.
3. Stand away from the trailer and visually verify if the trailer is level front-to-rear. If the front of the trailer is higher than the rear, the hitch must be raised. If the front of the trailer is lower than the rear, the hitch must be lowered.
4. Uncouple trailer from tow vehicle. See Coupling And Uncoupling.
5. Remove the lock nuts and bolts (1) on hitch. Discard lock nuts. Inspect bolts for damage and replace if necessary. Contact your dealer for the correct size and grade of bolts.



### **WARNING**

**Used lock nuts are prone to loosen, resulting in the hitch separating from the trailer, which can lead to death or serious injury.**

**NEVER re-use a lock nut.**

**Use new lock nuts each time the hitch height is adjusted.**

**Contact your dealer for the proper grade and size of lock nut.**

6. Raise or lower the hitch as necessary.
7. Install bolts and new lock nuts.
8. Tighten lock nuts to torque specified by your dealer.
9. Couple the trailer to the tow vehicle and verify that the trailer is level front to rear. Adjust if necessary.
10. Unload trailer. See Loading And Unloading.

## 5. LOADING AND UNLOADING

Improper trailer loading causes many accidents and deaths. To safely load a trailer, you must consider:

- Overall load weight.
- Load weight distribution.
- Proper tongue weight.
- Securing the load properly.

To determine that you have loaded the trailer within its rating, you must consider the distribution of weight, as well as the total weight of the trailer and its contents. The trailer axles carry most of the total weight of the trailer and its contents (Gross Vehicle Weight, or "GVW"). The remainder of the total weight is carried by the tow vehicle hitch.

It is essential for safe towing that the trailer tongue and tow vehicle hitch carry the proper amount of the loaded trailer weight, otherwise the trailer can develop an undesirable sway at towing speeds, or the rear of the towing vehicle can be overloaded. Read the "Tongue Weight" information in Section 4.

The load distribution must be such that no component part of the trailer is loaded beyond its rating. You must consider the rating of the tires, wheels and axles. For tandem and triple axle trailers, you must make sure that the front-to-rear load distribution does not result in overloading any axle.

Towing stability also depends on keeping the center of gravity as low as possible. Load heavy items on the floor and over the axles. When loading additional items, be sure to maintain even side-to-side weight distribution and proper tongue weight. The total weight of the trailer and its contents must never exceed the total weight rating of the trailer (Gross Vehicle Weight Rating, or "GVWR").

Do not transport people, containers of hazardous substances, or flammable liquids. The exception is fuel in the tank of vehicles or equipment being hauled.



### WARNING

**Do not transport flammable, explosive, poisonous or other dangerous materials on your trailer.**

**The exception is fuel in the tank of a vehicle or equipment being hauled.**



### WARNING

**Do not transport people on your trailer. Besides putting their lives at risk, the transport of people on a trailer is illegal.**

## 5.1 Loading Trailer

### 5.1.1 Preparing Trailer For Loading

1. Inspect the floor of the trailer.
2. Inspect the tie down rings and track system for damage, looseness or signs of bending before loading the trailer.



### WARNING

**Damaged or loose tie down rings or track can break, allowing cargo to become loose.**

**Loose cargo can shift the center of gravity, and result in loss of control of the trailer.**

**Inspect and test tie downs and track before loading cargo.**

**Do not use a damaged or loose tie downs or track to secure cargo.**

3. Park the tow vehicle and trailer on a firm and level surface.
4. Clear the area around the trailer.

### 5.1.2 Loading A Rigid Deck Trailer

1. Couple the trailer to the tow vehicle.



### WARNING

**Trailer must be coupled to tow vehicle before loading trailer.**

2. Lower rear stabilizers (if equipped) or place blocking under rear of trailer so the weight of the cargo does not raise the front of the trailer during loading.

# Loading And Unloading

## CAUTION

Use a safe lifting procedure to avoid injury when handling ramps.

3. Remove ramps from storage position and secure to rear of trailer. Adjust ramp position to align with equipment tires or tracks.

## WARNING

Load can suddenly move or topple, which can result in death or serious injury.

Do not load or unload trailer unless coupled to tow vehicle and is on a firm and level surface.

## NOTICE

*Ramps are not rated for load bearing capacity. They will NOT support the load bearing capacity of the trailer.*

*Do not overload ramps.*

4. Load the cargo on trailer with approximately 60% of the cargo in the front half of the trailer.
5. Secure the load to the trailer using appropriate straps, chains and tensioning devices. Refer to [www.fmcsa.dot.gov](http://www.fmcsa.dot.gov) for regulations regarding cargo securement rules.
6. Remove ramps and place in storage position.
7. Secure ramps to trailer.
8. Raise rear stabilizers (if equipped) or remove blocking under rear of trailer.

### 5.1.3 Loading A Tilt Deck Trailer

A tilt deck trailer may be equipped with a manual or a hydraulic tilt deck.

#### 5.1.3.1 Manual Tilt Trailer

1. Couple the trailer to the tow vehicle.

## WARNING

Trailer must be coupled to tow vehicle before loading trailer.

2. Release deck latch pin to pivot trailer deck for loading.

## WARNING

Loading a pivoting-deck trailer before retracting the deck catch pin can crack the catch pin, which can cause loss of cargo or loss of control of the trailer. Death or serious injury may result.

Before loading the trailer, retract the deck catch pin.

If the deck catch pin becomes bent, do not straighten it. Replace the deck catch pin before towing the load.

3. Load the cargo on trailer with approximately 60% of the cargo in the front half of the trailer. Deck will pivot down into the driving position as the cargo is moved forward on the deck.
4. Extend the deck catch pin into the deck to lock the deck into the driving position. Verify the catch engages the hole in the pivoting deck.

## WARNING

An unlocked pivoting deck can result in loss of cargo or loss of control of the trailer, which can result in death or serious injury.

Before towing the trailer:

- Lock the pivoting deck in the driving position.
- Verify that the catch engages the hole in the pivoting deck.

5. Secure the load to the trailer using appropriate straps, chains and tensioning devices. Refer to [www.fmcsa.dot.gov](http://www.fmcsa.dot.gov) for regulations regarding cargo securement rules.

## WARNING

Shifting cargo can result in loss of control of the trailer, and can lead to death or serious injury.

Tie down all loads with proper sized fasteners, chains, straps, etc.

# Loading And Unloading

## 5.1.3.2 Hydraulic Tilt Trailer

1. Couple the trailer to the tow vehicle.



### WARNING

**Trailer must be coupled to tow vehicle before loading trailer.**

2. Read and understand the hoist operating procedure before operating the tilt deck.
3. Locate the tilt deck controller. Position yourself in a safe location clear of the tilt deck.
4. Press and hold button to raise the tilt deck. Release the button when the rear of the tilt deck touches the ground.
5. Load the cargo on trailer with approximately 60% of the cargo in the front half of the trailer.
6. Secure cargo to prevent movement.
7. Press and hold button to lower the tilt deck. Release the button when the tilt deck is in the driving position.
8. Secure the load to the trailer using appropriate straps, chains and tensioning devices. Refer to [www.fmcsa.dot.gov](http://www.fmcsa.dot.gov) for regulations regarding cargo securement rules.
9. Stow controller.



### WARNING

**Shifting cargo can result in loss of control of the trailer, and can lead to death or serious injury.**

**Tie down all loads with proper sized fasteners, chains, straps, etc.**

## 5.2 Unload Trailer

### 5.2.1 Unload Manual Tilt Trailer

1. Couple the trailer to the tow vehicle.



### WARNING

**Trailer must be coupled to tow vehicle before unloading trailer.**

2. Park the tow vehicle and trailer on a firm and level surface.
3. Clear the area around the trailer.
4. Remove chains, straps and tensioning devices.

5. Release deck latch pin to pivot trailer deck for unloading.



### WARNING

**Unloading a pivoting-deck trailer before retracting the deck catch pin can crack the catch pin, which can cause loss of cargo or loss of control of the trailer. Death or serious injury may result.**

**Before unloading the trailer, retract the deck catch pin.**

**If the deck catch pin becomes bent, do not straighten it. Replace the deck catch pin before towing the load.**

6. Carefully move cargo toward rear of trailer. Deck will pivot down into the unload position as the cargo is moved rearward on the deck.
7. Pivot deck back to the driving position and extend the deck catch pin to lock the deck. Verify the catch engages the hole in the pivoting deck.



### WARNING

**An unlocked pivoting deck can result in loss of cargo or loss of control of the trailer, which can result in death or serious injury.**

**Before towing the trailer:**

- Lock the pivoting deck in the driving position.
- Verify that the catch engages the hole in the pivoting deck.

### 5.2.2 Unload Hydraulic Tilt Trailer

1. Couple the trailer to the tow vehicle.



### WARNING

**Trailer must be coupled to tow vehicle before unloading trailer.**

2. Park the tow vehicle and trailer on a firm and level surface.
3. Clear the area around the trailer.
4. Remove chains, straps and tensioning devices.
5. Read and understand the hoist operating

- procedure before operating the tilt deck.
6. Locate the tilt deck controller. Position yourself in a safe location clear of the tilt deck.
  7. Press and hold button to raise the tilt deck. Release the button when the rear of the tilt deck touches the ground.
  8. Unload the cargo from trailer.
  9. Press and hold button to lower the tilt deck. Release the button when the tilt deck is in the driving position.
  10. Stow controller.

## **5.3 Hydraulic Components**

Do not alter or substitute and hydraulic components on the trailer. The hydraulic system is designed with each component being compatible with the safe and reliable operation of the hydraulic system. **Under no circumstances should you alter the hydraulic pressure or flow rate in the hydraulic system.**

### **DANGER**

**Crushing hazard.**

**An altered or component substituted hydraulic system may malfunction, resulting in the tilt deck falling without warning.**

**NEVER alter or substitute any hydraulic system component.**

Always have the hydraulic system repaired or maintained by a qualified technician.

## **5.4 Securing Cargo**

### **WARNING**

**Shifting cargo can result loss of control of the trailer, and can lead to death or serious injury.**

**Tie down all loads with proper sized fasteners, chains, straps, etc.**

Refer to [www.fmcsa.dot.gov](http://www.fmcsa.dot.gov) for regulations regarding cargo securement rules.

## **6. Pre-Tow Checklist**

### **6.1 Pre-Tow Checklist**

Before towing, double-check all of these items:

- Tires, wheels and lug nuts. See “Breaking In A New Trailer” section of this manual.
- Tire Pressure. Inflate tires on trailer and tow vehicle to the pressure stated on the Certification / VIN label.
- Coupler secured and locked. See “Coupling To Tow Vehicle” section of this manual.
- Safety chains properly rigged to tow vehicle, not to hitch or ball. See “Coupling To Tow Vehicle” section of this manual.
- Test Tail, Stop, and Turn Lights.
- Test trailer brakes.
- Safety breakaway lanyard fastened to tow vehicle, not to safety chains. See “Coupling To Tow Vehicle” section of this manual.
- Cargo properly loaded, balanced and tied down. See the appropriate “Loading And Unloading” section of this manual.
- Tongue weight and weight distribution set-up.
- Ramps secured for travel.
- Fire extinguisher.
- Flares and reflectors.

### **6.2 Make Regular Stops**

After each 50 miles, or one hour of towing, stop and check the following items:

- Coupler secured.
- Safety chains are fastened and not dragging.
- Cargo secured.



## 7. Breaking In A New Trailer

### 7.1 Retighten Lugs At First 10, 25 & 50 Miles

Wheel lugs can shift and settle quickly after being first assembled, and must be checked after the first 10, 25 and 50 miles of driving. Failure to perform this check may result in a wheel coming loose from the trailer, causing a crash leading to death or serious injury. Improper tightening of the lug nuts or bolts voids the axle warranty.

Refer to the Inspection, Service and Maintenance section of this manual.



#### WARNING

**Lug nuts or bolts are prone to loosen after being first assembled. Death or serious injury can result.**

**Check lug nuts or bolts for tightness on a new trailer, and after re-mounting a wheel at 10, 25 and 50 miles.**

### 7.2 Adjust Brake At First 200 Miles

Brake shoes and drums experience a rapid initial wear. The brakes must be adjusted after the first 200 miles of use, and each 3,000 miles thereafter. Some axles are fitted with a mechanism that will automatically adjust the brake shoes.

Read your axle and brake manual to see if your brakes adjust automatically. If you do not have the axle and brake manual, contact your dealer for assistance.

If your trailer is not fitted with automatically adjusting brakes, the brakes will need to be manually adjusted. See section 9 for instructions.

### 7.3 Synchronizing Brake Systems

Trailer brakes are designed to work in synchronization with the brakes on the tow vehicle. When the tow vehicle and trailer braking systems are synchronized, both braking systems contribute to slowing, and the tongue of the trailer will neither dive nor rise sharply.



#### WARNING

**If trailer and tow vehicle brakes do not work properly together, death or serious injury can occur.**

**Road test the brakes in a safe area at no more than 30 m.p.h. before each tow.**

To insure safe brake performance and synchronization, read and follow the axle/brake and the brake controller manufacturers' instructions. If you do not have these instructions, contact your dealer for assistance.

## 8. Accessories

This section provides some basic information for the safe operation of accessories.

You must read and follow these instructions before using the accessory. If you are uncertain whether you have all of the instructions, contact your dealer before operating the accessory.

### 8.1 Accessory Battery

Your trailer may be equipped with an accessory battery that operates the tilt deck.

The battery may be kept charged either by the tow vehicle, by an auxiliary charger or by using an on-board battery maintainer/charger (if equipped). If the trailer is used daily, it is recommended that the battery charger be plugged in after each days use. The battery may be located in a tongue mounted battery box or a side mounted box.

The accessory battery must be kept in a charged condition during storage. The battery could freeze and break if it becomes discharged.

If the battery is not fully charged, the hydraulic pump will lose pressure which may cause hydraulic fluid to flow back into the hydraulic reservoir, overfilling the reservoir and ejecting fluid into the battery box.



#### **WARNING**

**Risk of battery exploding.**

**Battery box prop rod may contact battery terminals, which may result in the battery exploding.**

**Place battery box lid prop rod in retaining clip.**

## 9. Inspection, Service And Maintenance

### 9.1 Inspection, Service & Maintenance Summary Charts

You must inspect, maintain and service your trailer regularly to insure safe and reliable operation. If you cannot or are unsure how to perform the items listed here, have your dealer do them. Note: In addition to this manual, also check the relevant component manufacturer's manual.

<b>Inspection And Service Before Each Tow</b>		
<b>Item</b>	<b>Inspection/Service</b>	<b>Manual Section Reference</b>
Breakaway Brakes • Electric • Hydraulic	Check operation. Check operation.	Section 4. Section 4.
Breakaway Battery	Fully charged, connections clean.	Section 4 and 9.
Brakes • Electric • Surge	Check operation. Check operation. Check master cylinder level.	Section 4 and 9.
Shoes And Drums	Adjust	Section 9.
Safety Chains And Hooks	Check for wear, damage.	Section 4.
Coupler And Hitch Ball	Check for cracks, pits, and flats. Replace w/ ball and coupler having trailer GVW Rating.  Grease.  Check locking device & replace when worn.	Section 4 and 9.  Section 4 and 9.  Section 4 and 9.
Ring And Pintle	Check for cracks, pits, and flats. Replace w/ ring and pintle having trailer GVW Rating.  Grease.  Check locking device & replace when worn.	Section 4 and 9.  Section 4 and 9.  Section 4 and 9.
Tires	Check tire pressure when cold. Inflate as needed.  Check for damage.	Section 6 and 9  Section 6 and 9
Wheels - Lug Nuts Or Bolts & Hub	Check for tightness.  Tighten. For new and remounted wheels, check torque after first 10, 25 & 50 miles of driving and after any impact.	Section 6.  Section 7 and 9.

## Inspection, Service And Maintenance

<b>Inspection And Service Every Month</b>		
<b>Item</b>	<b>Inspection / Service</b>	<b>Manual Section Reference</b>
Lubrication	Lubricate tilt deck pivot points (if equipped).	Section 9.
	Lubricate hydraulic cylinder ends (if equipped).	Section 9.

<b>Inspection and Service Every 6 Months or 6,000 Miles</b>		
<b>Item</b>	<b>Inspection/Service</b>	<b>Manual Section Reference</b>
Brakes, electric <ul style="list-style-type: none"> <li>• Magnet</li> <li>• Controller (in tow vehicle)</li> </ul>	Check wear and current draw.	Section 9.
	Check power output (amperage) and modulation.	Section 9. See Controller Mfr's Manual
Tires	Inspect tread and sidewalls thoroughly.	Section 9.
	Replace tire when treads are worn, when sidewall has a bulge, or sidewall is worn.	Section 9.
	Rotate every 5,000 Miles.	Section 9.
Brakes <ul style="list-style-type: none"> <li>• Electric</li> <li>• Surge</li> </ul>	Check Operation. Check Operation. Check Master Cylinder Level.	Section 4.
Brake Shoes And Drums	Adjust	Section 7 and 9.
Safety Chains & Hooks	Check for wear, damage.	Section 4.
Coupler And Hitch Ball	Check for cracks, pits, and flats. Replace w/ ball and coupler having trailer GVW Rating.	Section 4.
	Grease.	Section 4 and 9.
	Check locking device and replace when worn.	Section 4 and 9.
Ring And Pintle	Check for cracks, pits, and flats. Replace w/ ring and pintle having trailer GVW Rating.	Section 4.
	Grease.	Section 4 and 9.
	Check locking device & replace when worn.	Section 4 and 9.

## Inspection, Service And Maintenance

<b>Inspection And Service Every Year or 12,000 Miles</b>		
<b>Item</b>	<b>Inspection/Service</b>	<b>Manual Section Reference</b>
Brakes, all types <ul style="list-style-type: none"> <li>• Shoes and Drums</li> </ul>	Check for scoring and wear. Replace per manufacturer's specifications.	Section 9.  See Brake Mfr's Manual
Jack, Drop-leg (if equipped)	Grease gears at top.	See Jack Mfr's Manual
Structure <ul style="list-style-type: none"> <li>• Frame Members</li> </ul>	Inspect all frame members, bolts & rivets. Repair or replace damaged, worn or broken parts.	Section 9.
<ul style="list-style-type: none"> <li>• Welds</li> </ul>	Inspect all welds. Repair as needed.	Section 9.
Wheels <ul style="list-style-type: none"> <li>• Wheel Bearings</li> <li>• Rims</li> </ul>	Disassemble / inspect / assemble and repack. Replace promptly if immersed in water.  Inspect for cracks & dents. Replace as needed.	Section 9 & See Axle Mfr's Manual
Structure <ul style="list-style-type: none"> <li>• Axle Attachment Bolts</li> </ul>	Check BY DEALER	Section 9.

## 9.2 Inspection And Service Instructions

### WARNING

**Worn or broken suspension parts can cause loss of control and injury may result.**

**Have trailer professionally inspected annually and after any impact.**

To perform many of the inspection and maintenance activities, you must jack up the trailer.

When jacking and using jack stands, place them so as to clear wiring, brake lines, and suspension parts (springs, torsion bars, etc.). Place jacks and jack stands under the outer frame rail to which the axles are attached.

### WARNING

**Never go under trailer unless it is on firm and level ground and resting on properly placed and secured jack stands.**

### WARNING

**Crushing hazard.**

**The tow vehicle and trailer could be inadvertently moved while a person is under the trailer.**

**The tow vehicle engine must be off, ignition key removed and parking brakes set before entering the area under the trailer.**

### 9.2.1 Trailer Structure

Wash the trailer as needed with a power washer and a detergent solution.

#### 9.2.1.1 Fasteners And Frame Members

Inspect all fasteners and structural frame members for bending and other damage, cracks, or failure. Repair or replace any damaged fastener and repair the frame member. If you have any questions about the condition or method of repair of fasteners or frame members, get the recommendation of, or have the repair done by your dealer.

### WARNING

**Broken or damaged fasteners can cause injury or damage to trailer and contents.**

**Inspect for, and repair all damaged parts at least once a year.**

#### 9.2.1.2 Welds

All welds can crack or fail when subjected to heavy loads or movement of cargo that was not properly secured. Any time that you know or suspect that the trailer has been subjected to heavy loads or movement of cargo, immediately inspect the welds and fasteners for damage. To prevent severe damage to your trailer, inspect all of the welds for cracks or failure at least once a year. If a weld failure is detected, contact your dealer.

### WARNING

**Do not attempt to repair a cracked or broken weld unless you have the skills and equipment to make the repair.**

**Improper weld repair will lead to early failure of the trailer structure and serious injury or death.**

**See your dealer for weld repairs.**

### WARNING

**Broken or damaged welds can cause injury or damage to trailer and contents.**

**Inspect for, and repair all damaged parts at least once a year.**

### 9.2.2 Trailer Brakes - Electric

#### 9.2.2.1 Brake Shoes And Drums

Properly functioning brake shoes and drums are essential to ensure safety. You must have your dealer inspect these components at least once per year, or each 12,000 miles. Brake adjustment is not covered under the axle warranty.

The brake shoes must be adjusted after the first 200 miles of use, and each 3,000 miles thereafter. Most axles are fitted with a brake mechanism that will automatically adjust the brake shoes when the trailer

is “hard braked” from a rearward direction. Read your axle and brake manual to see how to adjust your brakes. If you do not have this manual, contact your dealer for assistance.

## 9.2.2.2 Manually Adjusting Brake Shoes

Some braking systems are not automatically adjusted. These brakes require manual adjustment. The following steps apply to adjust most manually adjustable brakes.

Read your axle and brake manual to see how to adjust your brakes. If you do not have this manual, contact your dealer for assistance.

1. Jack up the trailer and secure it on adequate capacity jack stands.
2. Be sure the wheel and brake drum rotate freely.
3. Remove the adjusting-hole cover from the adjusting slot on the bottom of the brake backing plate.
4. With a screwdriver or standard adjusting tool, rotate the starwheel of the adjuster assembly to expand the brake shoes. Adjust the brake shoes out until the pressure of the linings against the drum makes the wheel very difficult to turn. Note: Your trailer maybe equipped with drop spindle axles. See axle manual for your axle type. You will need a modified adjusting tool for adjusting the brakes in these axles.
5. Rotate the starwheel in the opposite direction until the wheel turns freely with a slight drag.
6. Replace the adjusting-hole cover.
7. Repeat the above procedure on all brakes.
8. Lower the trailer to the ground.

## 9.2.2.3 ELECTRIC BRAKES

Two different types of electric brakes may be present on the trailer: an emergency electric breakaway system, which acts only if the trailer comes loose from the hitch and the breakaway pin is pulled. The other brake is an electric braking system that acts whenever the brakes of the tow vehicle are applied.

**Breakaway Battery** - This battery supplies the power to operate the trailer brakes if the trailer uncouples from the tow vehicle. Be sure to check, maintain and replace the battery according to the battery manufacturer’s instructions. Your trailer may use the hydraulic system battery to operate the breakaway brakes.



## CAUTION

**Extreme cold weather can degrade battery performance and cause brakes to not operate properly.**

**Check battery charge level before towing.**

**Breakaway Switch** - This switch engages the electric brakes if the trailer uncouples from the tow vehicle. To check for proper functioning of the switch, battery and brakes, you must pull the pin from the switch and confirm that the brakes apply to each wheel. You can do this by trying to pull the trailer with the tow vehicle, after pulling the pin. The trailer brakes may not lock, but you will notice that a greater force is needed to pull the trailer.



## WARNING

**If electric breakaway brakes do not operate when trailer is uncoupled from the tow vehicle, death or serious injury can occur.**

**Check emergency breakaway brake system before each tow.**

## 9.2.2.4 Tow Vehicle Operated Electric Brakes

The electric brakes that operate in conjunction with the tow vehicle brakes must be “synchronized” so that braking is properly distributed to the tow vehicle brakes and the trailer brakes. For proper operation and synchronization, read and follow the axle/brake and the brake controller manufacturers’ instructions. If you do not have these instructions, contact your dealer for assistance.

## 9.2.2.5 Electric Brake Magnets

To make certain an electrically-operated braking system will function properly, you must have your dealer inspect the magnets at least once a year, or each 12,000 miles. See the brake manual for wear and current inspection instructions.

## 9.2.3 Trailer Brakes - Surge (If Equipped)

### 9.2.3.1 Surge Brake Master Cylinder

Check fluid level prior to using the trailer. The master cylinder is normally located on the tongue of the trailer. The fluid level must maintained at full mark on

reservoir. Check with your dealer for the type of brake fluid used in the brake system.

## 9.2.3.2 Hydraulic Surge Brake

Before each tow, perform the following steps:

1. Check that the brake master cylinder level as instructed above. Check for leaks and repair as required.
2. Examine the actuator for wear, bent parts, corroded/seized parts, or other damage. Have the affected components replaced with genuine service parts.
3. Check to determine that the actuator mounting bolts are tightened to the manufacturer's specification.
4. Test the actuator and brake function as described in the Coupling To Tow Vehicle section of this manual. Actuator travel over one inch indicates that the brakes need adjustment (or that the actuator has been structurally damaged). Actuator travel is the distance the coupler case assembly moves to the outer case during braking. Adjust the brakes following the instructions given in the brake installation manual. Failure to adjust brakes will result in loss of braking.
5. Before storage or after extended use, apply motor oil to the coupler components and the internal rollers to keep them moving freely and to prevent corrosion.
6. See the surge brake manufacturer's manual for other inspection and maintenance activities. If you do not have this manual, contact your dealer for assistance.

## 9.2.3.3 Master Cylinder Bleeding

Remove the master cylinder's cap and fill the reservoir to three quarters full with DOT-3 or DOT 4 brake fluid. DO NOT allow brake fluid to contact painted surfaces since it will damage the finish. Wipe up any spills immediately and wash the area with water.

Bleed the brake system manually or with a pressure bleeder. Pressure bleeding equipment simplifies the process, and is available at most automotive supply stores. Use the instructions provided with the pressure bleeder. If you chose to manually bleed the system, an assistant is required. Use the following steps to manually bleed the brake system:

1. Disconnect the trailer from the tow vehicle and jack the trailer's tongue until it is horizontal. Make sure that the wheels are blocked so that the trailer will not roll away.
2. Fill the master cylinder with correct fluid.
3. Install a bleeder hose on the bleeder screw of the farthest wheel cylinder from the actuator. If the

trailer has multiple axles, bleed the rear axle first. Submerge the other end of the hose in a glass container of brake fluid, so that air bubbles can be observed.

4. Open the bleeder screw and have an assistant stroke (but not release) the actuator. Brake fluid and/or air bubbles will flow into the jar. Close the bleeder screw. The helper can then allow the actuator to return to its rest position.
5. Repeat the process until no more bubbles are released with the stroke. Air trapped in the brake lines will greatly reduce your braking efficiency. Be sure to close the bleeder screw securely when the cylinder is fully bled. Repeat the bleeding operation at each wheel cylinder. During the bleeding process, replenish the master cylinder reservoir with fresh brake fluid so that the level does not fall below half full. This will ensure that no air is drawn into the system.
6. After all brakes have been bled, refill the master cylinder before operating. Be sure to install the master cylinder filler cap.



### WARNING

**Use only fresh brake fluid from a sealed container. DO NOT reuse fluid. After filling and bleeding, refill the actuator.**

**Failure to maintain an adequate fluid level may cause brake failure.**

## 9.2.4 Trailer Connection To Tow Vehicle

### 9.2.4.1 Coupler And Ball

Before each tow, coat the ball with a thin layer of automotive bearing grease to reduce wear and ensure proper operation; and check the locking device that secures the coupler to the ball for proper operation.

See the coupler manufacturer's manual for other inspection and maintenance procedures. If you do not have this manual, contact your dealer for assistance.

If you see or feel evidence of wear, such as flat spots, deformations, pitting or corrosion, on the ball or coupler, immediately have your dealer inspect them to determine the proper action to prevent possible failure of the ball and coupler system. All bent or broken coupler parts must be replaced before towing the trailer.



The coupler latch lever must be able to rotate freely and automatically snap into the latched position. Oil the pivot points, sliding surfaces, and spring ends with SAE 30W motor oil. Keep the ball pocket and latch mechanism clean. Dirt or contamination can prevent proper operation of the latching mechanism.

When replacing a ball, the load rating must match or exceed the GVWR of the trailer.

## **9.2.4.2 Ring And Pintle**

Before each tow, coat the ring with a thin layer of automotive bearing grease to reduce wear and ensure proper operation; and check the locking device that secures the pintle to the ring for proper operation.

See the pintle manufacturer's manual for other inspection and maintenance activities. If you do not have this manual, contact your dealer for assistance.

If you see or feel evidence of wear, such as flat spots, deformations, pitting or corrosion, on the ring or pintle, immediately have your dealer inspect them to determine the proper action to prevent possible failure of the ring and pintle system. All bent or broken coupler parts must be replaced before towing the trailer.

The pintle handle lever must be able to rotate freely and automatically snap into the latched position. Oil the pivot points, sliding surfaces, and spring ends with SAE 30W motor oil. Keep the ring pocket and latch mechanism clean. Dirt or contamination can prevent proper operation of the latching mechanism.

When replacing a ring, the load rating must match or exceed the GVWR of the trailer.

## **9.2.5 Landing Leg Or Jack**

If a grease fitting is present, use a grease gun to lubricate the jack mechanism. Grease the gears in the top of hand-cranked jacks once a year, by removing the top of the jack and pumping or hand packing grease into the gears.

## **9.2.6 Lights And Signals**

Before each tow, check all trailer lights for proper operation.

## **9.2.7 Wheel Rims**

If the trailer has been struck, or impacted, on or near the wheels, or if the trailer has struck a curb, inspect the rims for damage. Replace any damaged wheel. Inspect the wheels for damage every year, even if no obvious impact has occurred.

## **9.2.8 Tires**

Before each tow, check the tire pressure to make sure it is at the level indicated on the tire sidewall or VIN label. Tire pressure must be checked while the tire is cold. Do not check tire pressure immediately after towing the trailer. Allow at least three hours for the tires to cool, if the trailer has been towed for as much as one mile. Tires can lose air over a period of time.

Replace the tire before towing the trailer if the tire treads have less than 2/32 inch depth or the telltale bands are visible.

A bubble, cut or bulge in a side wall can result in a tire blowout. Inspect both side walls of each tire for any bubble, cut or bulge; and replace a damaged tire before towing the trailer.



If you are storing your trailer for an extended period, make sure the tires are inflated to the maximum rated pressure indicated on the sidewall or VIN label and that you store them in a cool, dry place such as a garage. Use tire covers to protect the tires from the harsh effects of the sun.



### **WARNING**

**To avoid risk of collisions, all lights must work.**

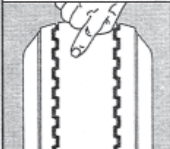
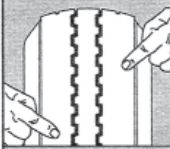
# Inspection, Service And Maintenance

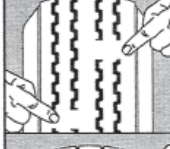
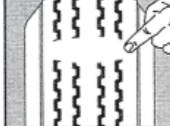
	Condition	Possible Cause	Remedy
	Even Center Wear	Over Inflation	Check & Adjust Pressure When Cold
	Inside & Outside Wear	Under Inflation	Check & Adjust Pressure When Cold
	Smooth, Side Wear - One Side	Loss of Camber or Overloading	Check & Unload As Necessary Have Alignment Checked
	"Feathering" Across The Face	Axle Not Square To Frame or Incorrect Toe In	Square Axles Have Alignment Checked
	Cupping	Loose Bearings or Wheel Balance	Check Bearing Adjustment and Wheel & Tire Balance
	Flat Spots	Wheel Lockup	Adjust Brakes

*Tire Inspection Chart*



## WARNING

**Worn, damaged or under-inflated tires can cause loss of control, injury and damage.**

**Check tires before each tow.**

### 9.2.9 Wheel Bearings

A loose, worn or damaged wheel bearing is the most common cause of brakes that grab.

To check your bearings, jack up the trailer and secure it on adequate capacity jack stands. Check wheels for side-to-side looseness.

If the wheels are loose, or spin with a wobble, the bearings must be serviced or replaced.



## WARNING

**Never go under trailer unless it is on firm and level ground and resting on properly placed and secured jack stands.**

If your axle(s) are equipped with a grease zerk on the ends of the axle(s), the bearings must be greased every 6 months or 6,000 miles to ensure reliable and safe operation of your trailer.

1. Remove the rubber plug from the axle end.
2. Place grease gun on zerk.
3. Pump grease until new grease begins to appear. Use a different color grease each time so you will know when the new grease begins to appear.
4. Install rubber plug and cap. Repeat for remaining wheel bearings.

If your trailer axle(s) are not equipped with grease zerks, refer to the axle manufacturer's manual for service and maintenance information.

### 9.2.10 Lubrication

Lubricate tilt deck pivots and hydraulic cylinder ends every month (if equipped).

### 9.2.11 Hydraulic Reservoir

Check fluid level prior to towing the trailer. The reservoir is normally located inside the battery box.

The tilt deck must be fully lowered before checking fluid level. The reservoir should be filled to the full mark on the side of the reservoir.

Use a quality hydraulic fluid with anti-wear properties, rust and oxidation inhibitors. Fluid ejecting from the reservoir could indicate a low battery.

### 9.2.12 Lug Nuts Or Bolts

Lug nuts or bolts are prone to loosen right after a wheel is mounted to a hub. When driving on a remounted wheel, check to see if the lug nuts or bolts are tight after the first 10, 25 and 50 miles of driving, and before each tow thereafter.



## WARNING

**Lug nuts or bolts are prone to loosen after being first assembled. Death or serious injury can result.**

**Check lug nuts or bolts for tightness on a new trailer, and after re-mounting a wheel at 10, 25 and 50 miles.**

**! WARNING**

**Metal creep between the wheel rim and lug nuts or bolts can cause rim to loosen.**

**Death or injury can occur if wheel comes off.**

**Tighten lug nuts or bolts before each tow.**

Tighten the lug nuts or bolts in three stages to the final torque for the axle size on your trailer, to prevent wheels from coming loose. Tighten each lug nut or bolt in the order shown in the following figure.

Use a calibrated torque wrench to tighten the fasteners. Verify that wheel studs are free of contaminants such as paint or grease, which may result in inaccurate torque readings. Over-tightening will result in breaking the studs or permanently deforming the mounting stud holes in the wheels, and will void the axle warranty.

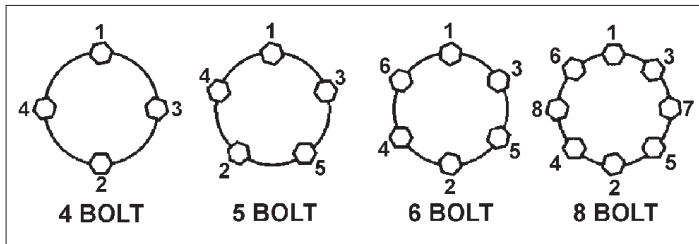

See your axle manufacturers manual or your dealer for wheel nut or bolt torque specifications.

---

---