

AXIAL #

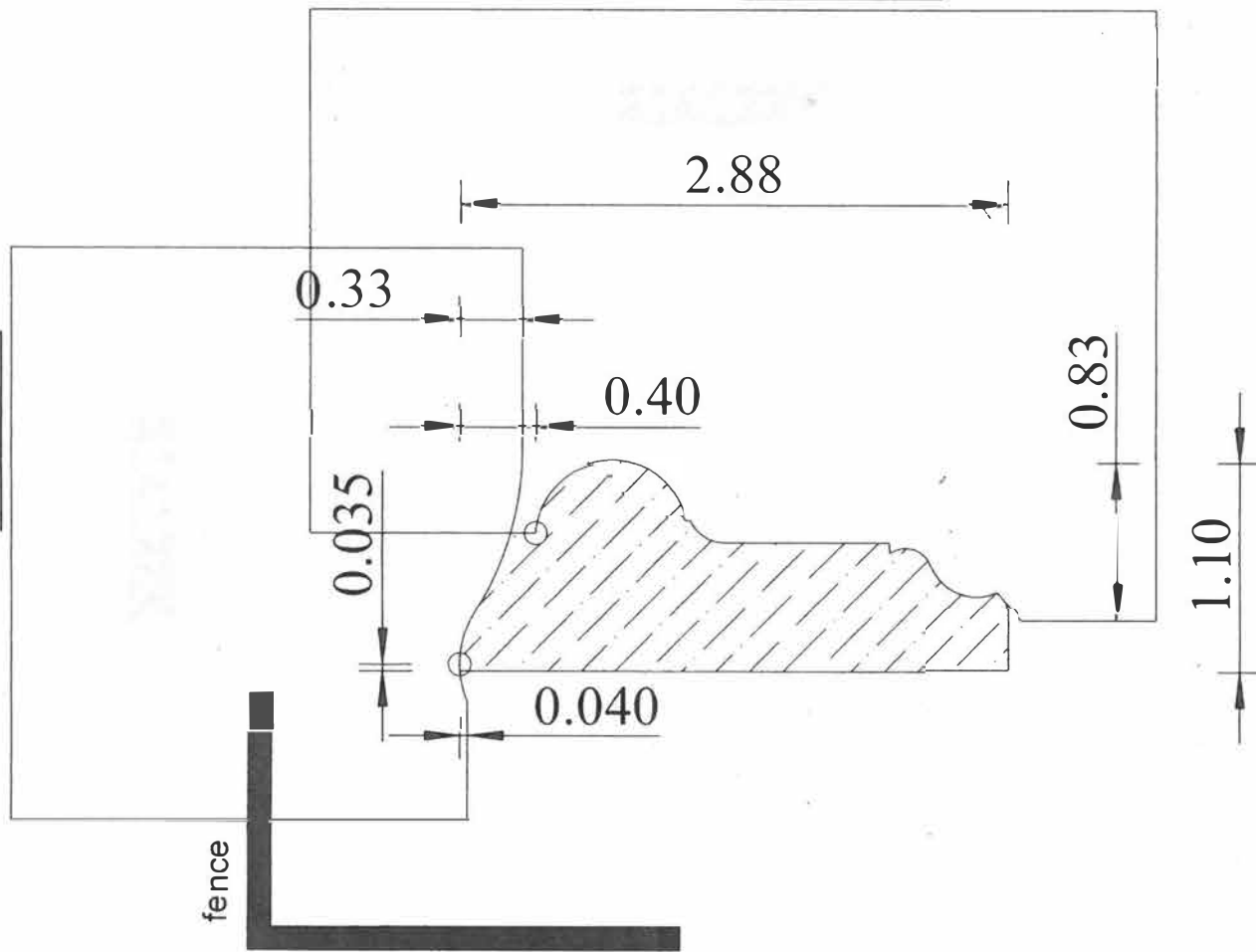

A-69

A-71

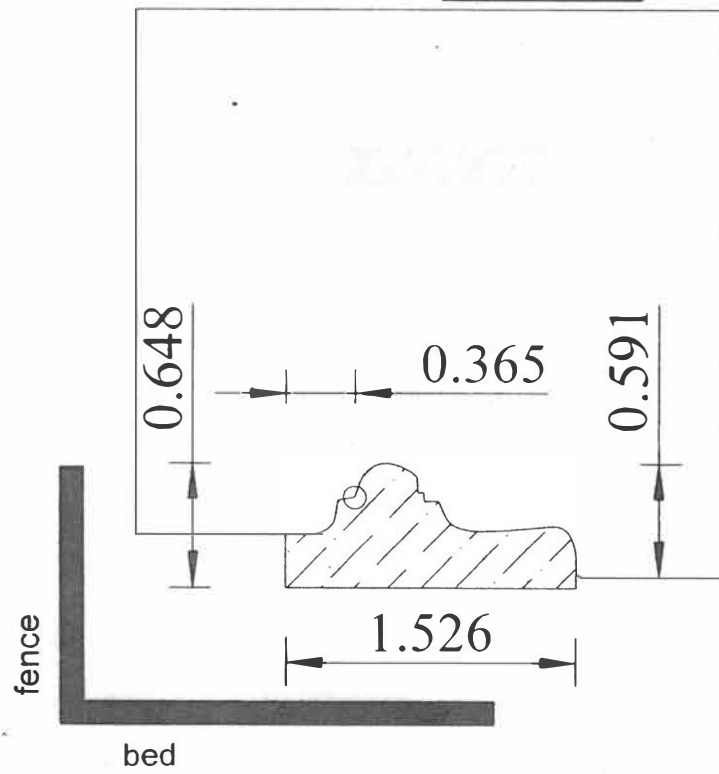



2000000

A-83

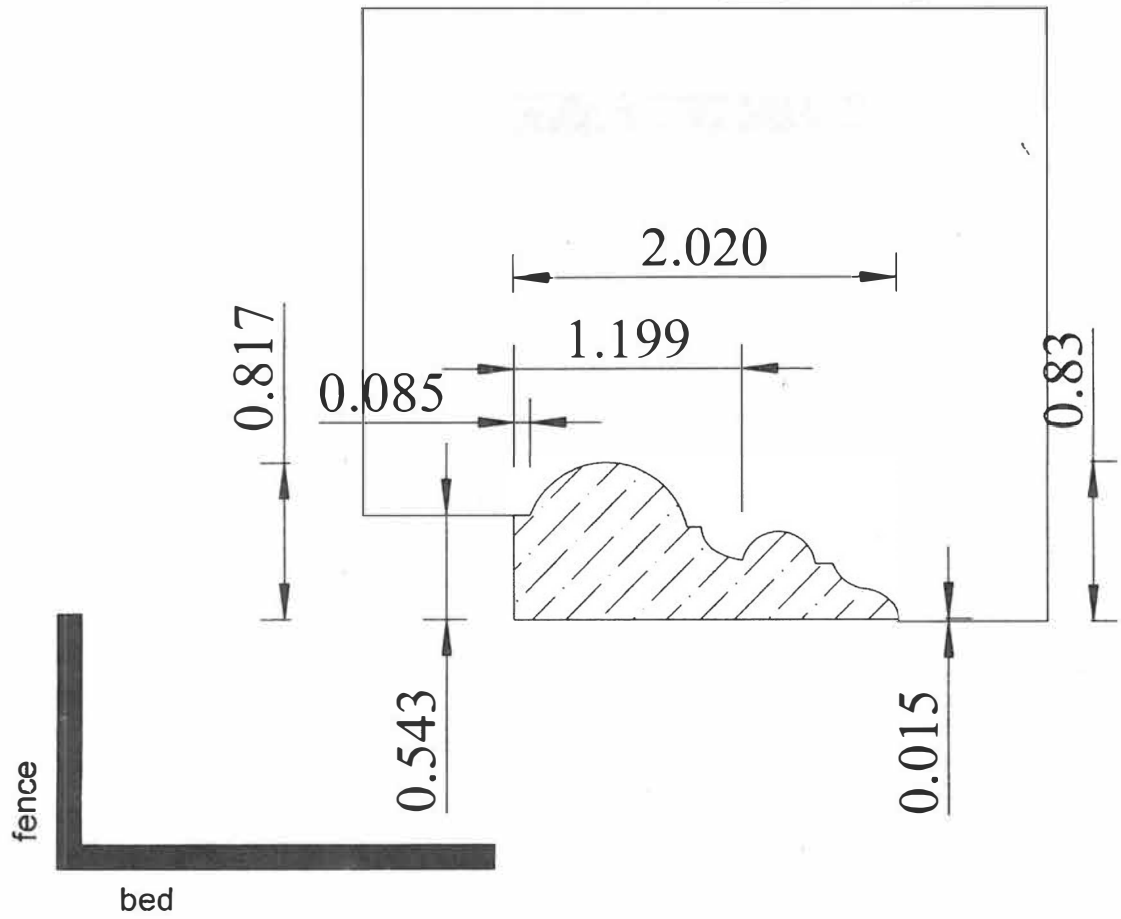

A-89

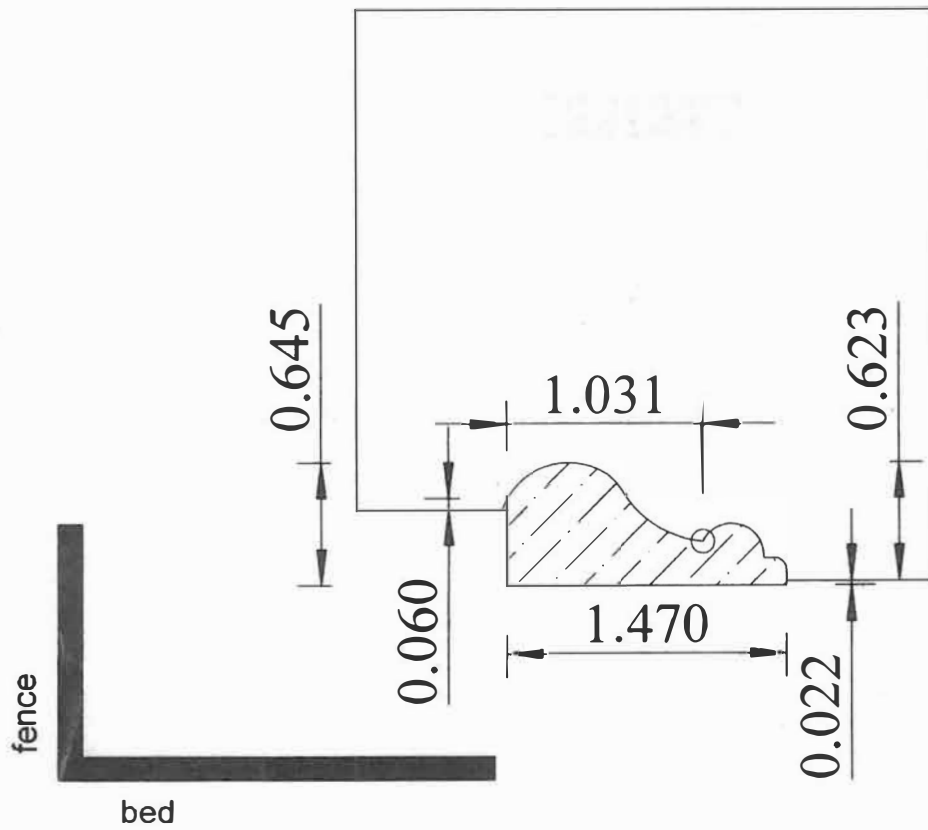

C-58

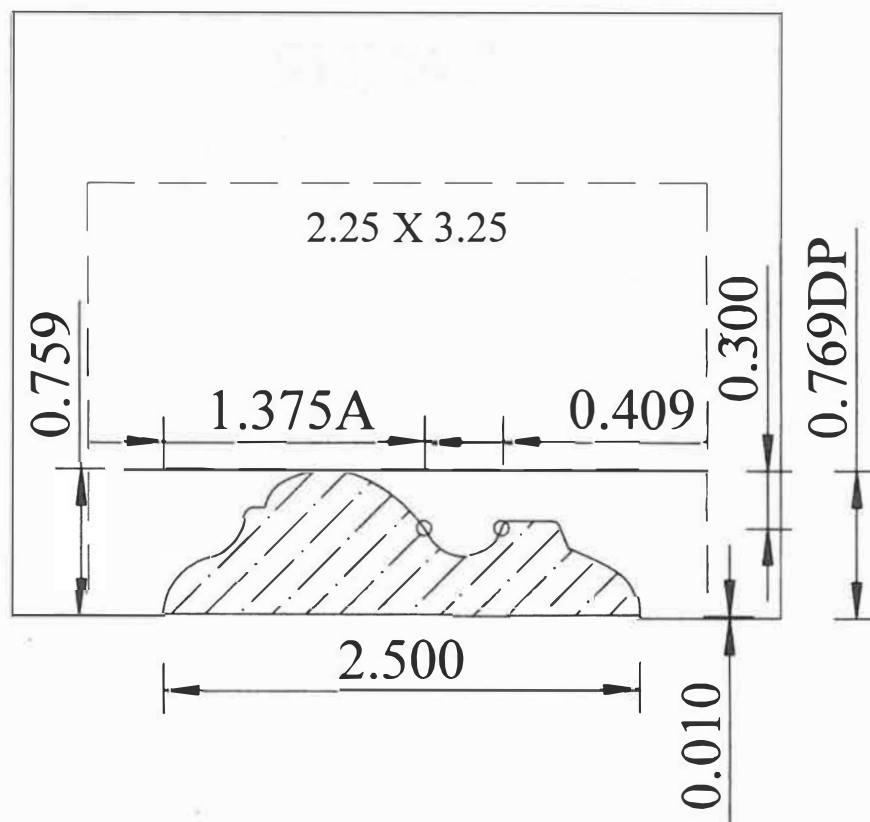

C-74

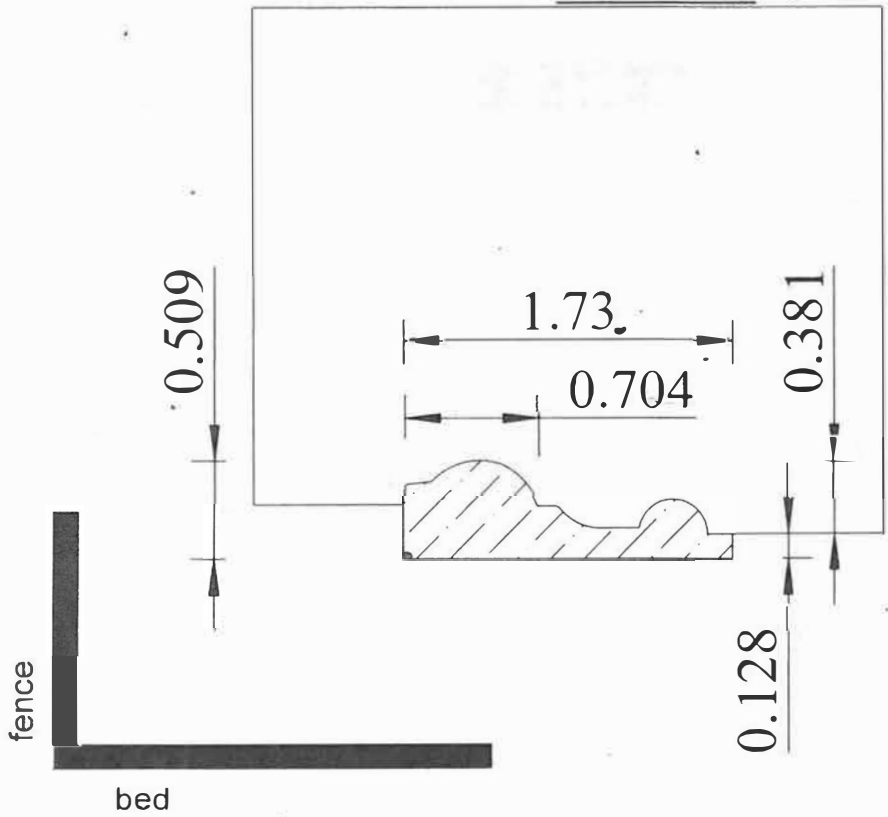

D-44

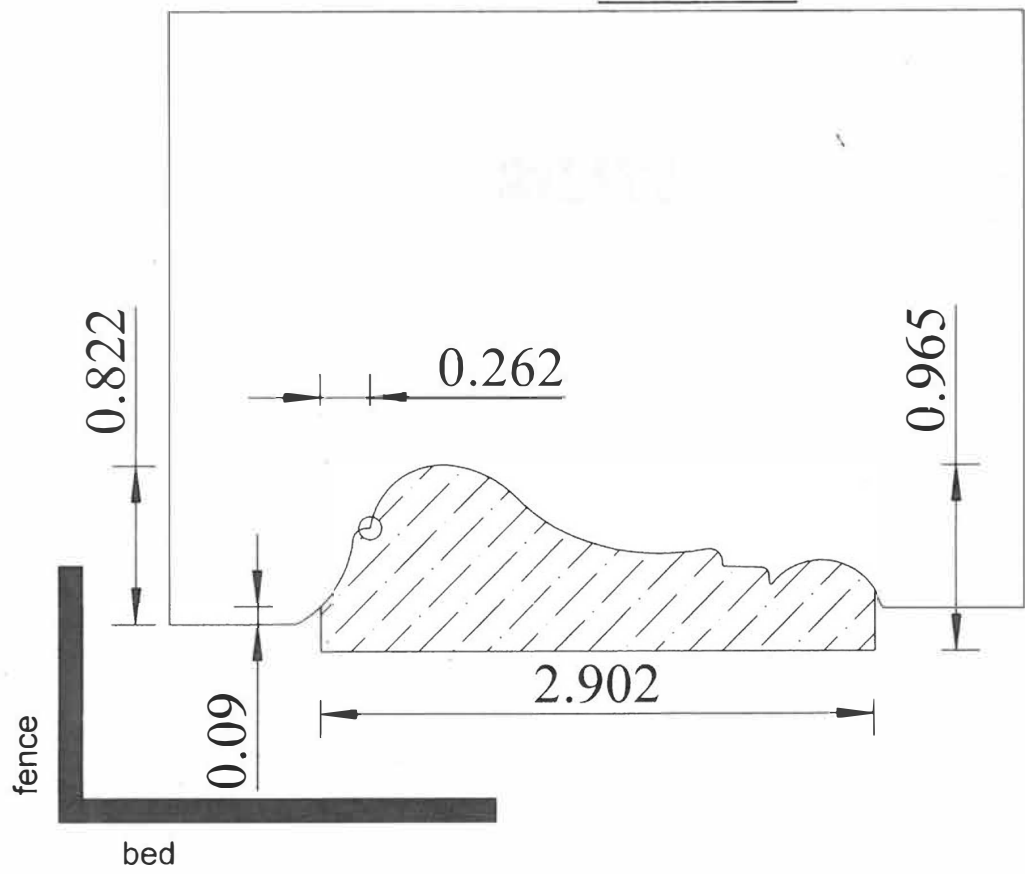

D-69

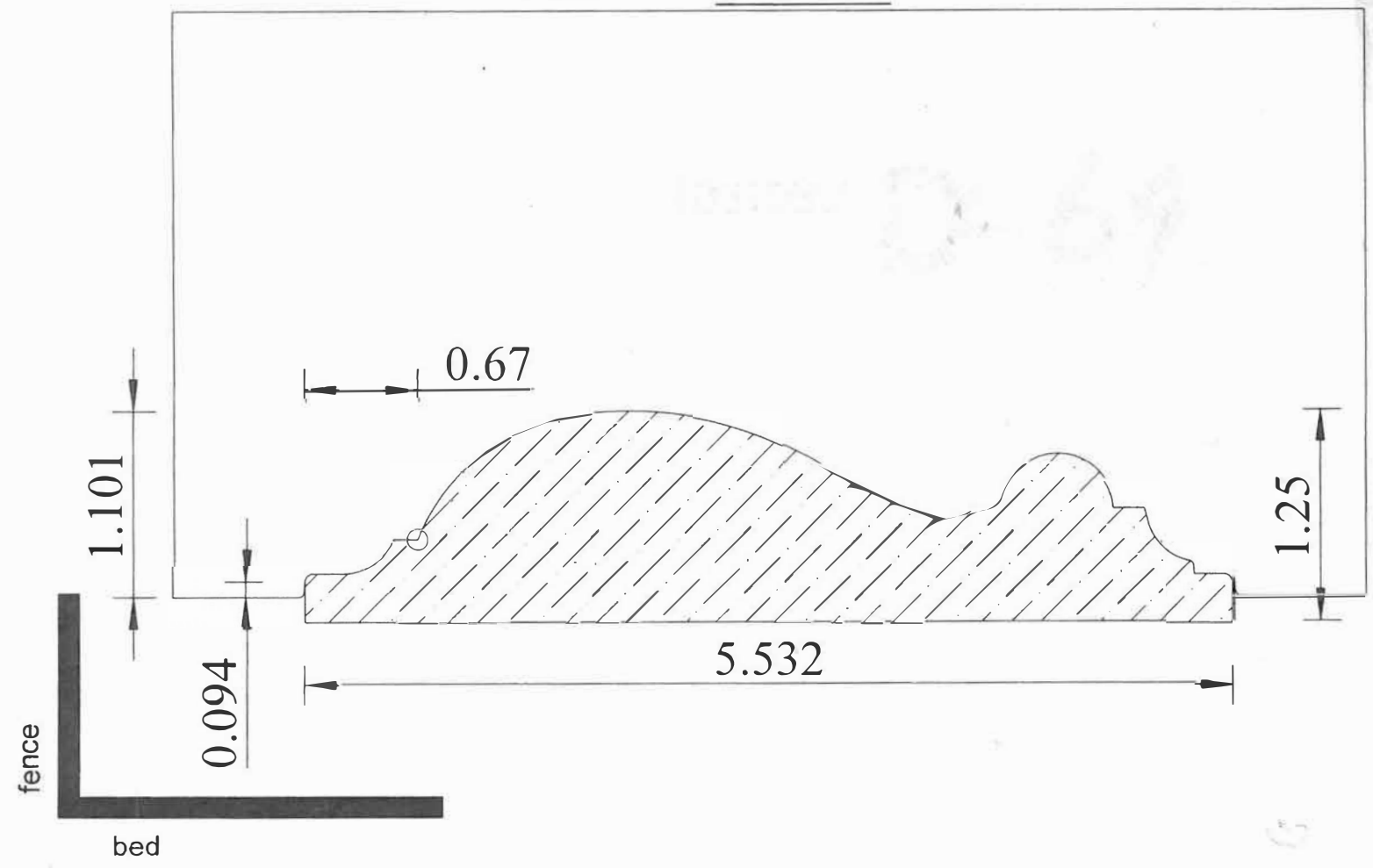



ATKINS

100%

UNIVERSITY OF WISCONSIN
MADISON

	100%	100%
100%	100%	100%
100%	100%	100%

D-74

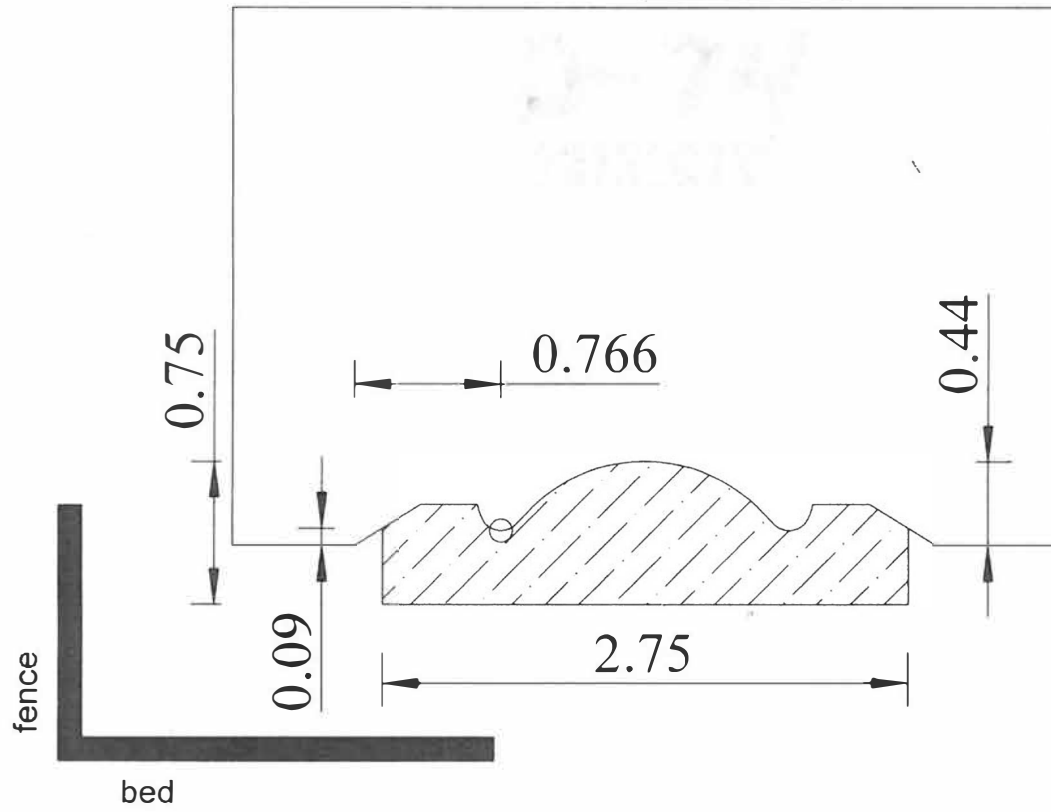

UNIVERSITY OF WISCONSIN
MADISON

UNIVERSITY OF WISCONSIN
MADISON



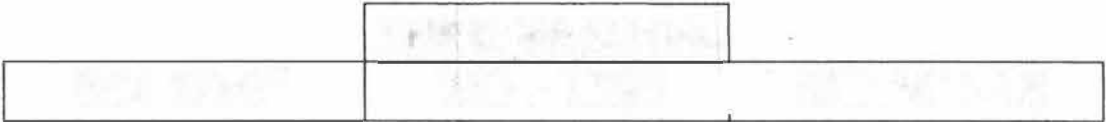

D-79

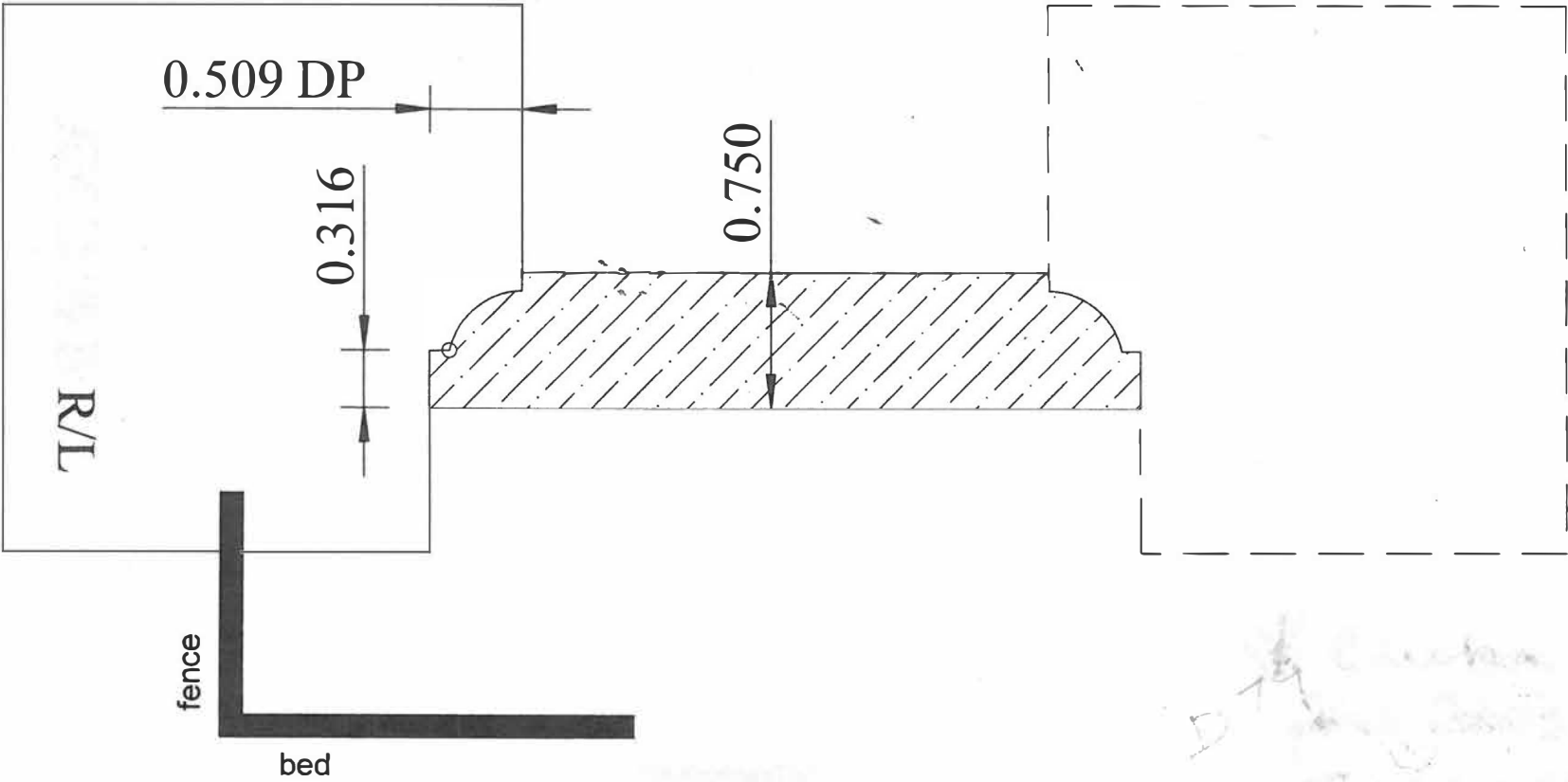

D-79
Custom
...

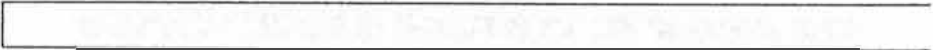

D-93

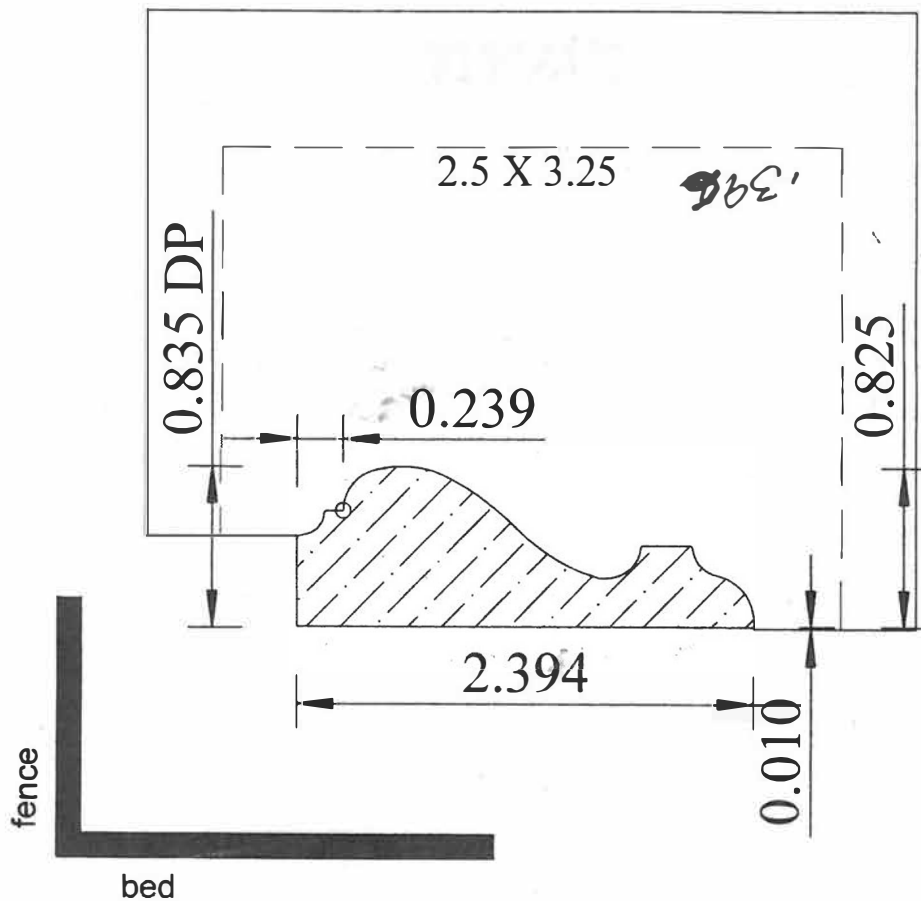

E-89

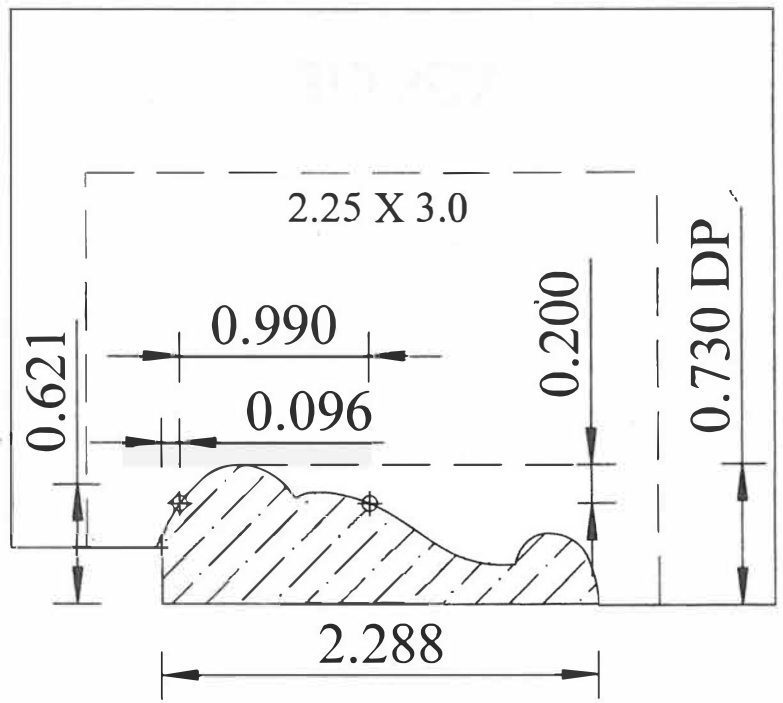

E-93

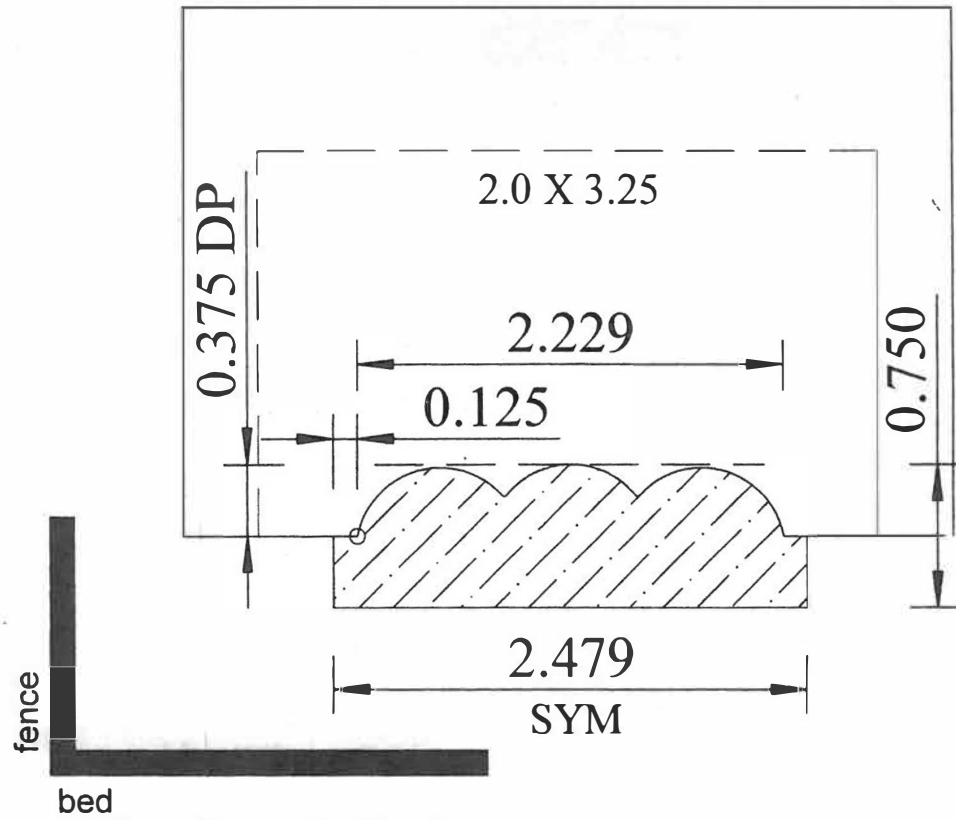

04

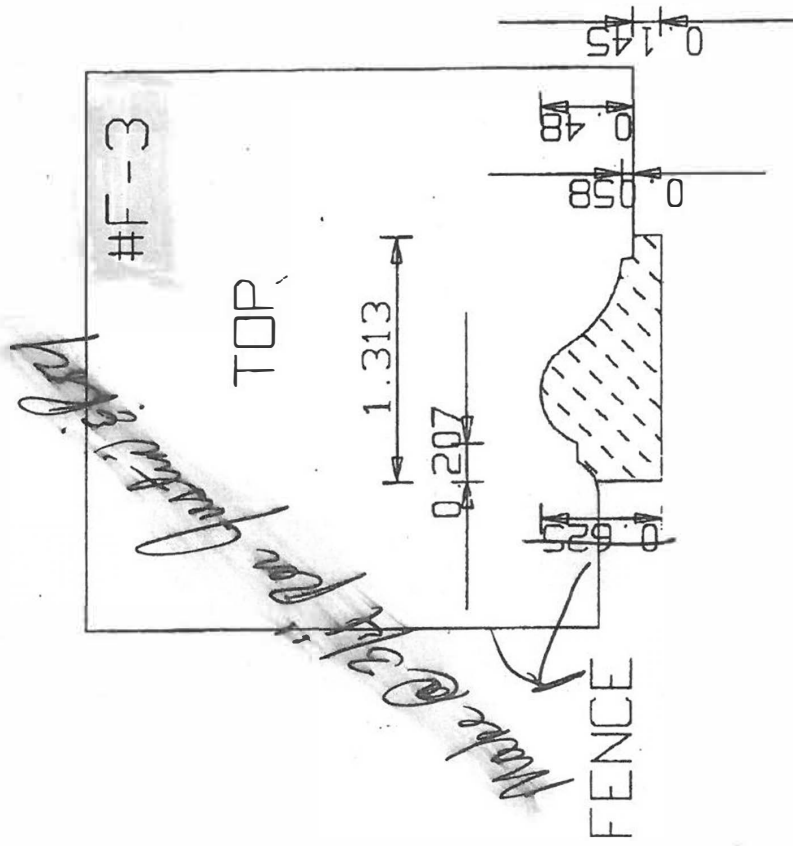

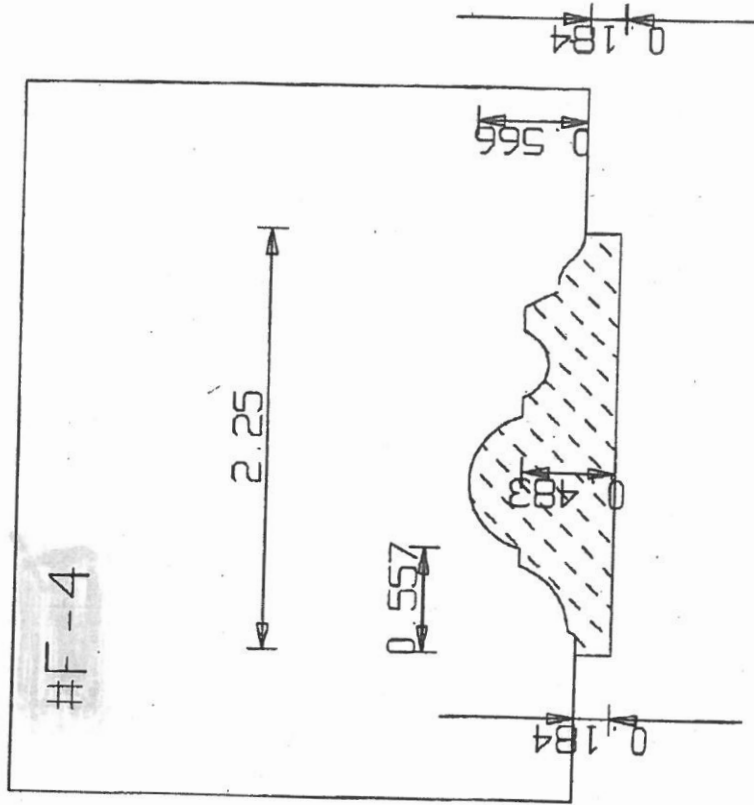

FENCE
0.75

1/0

F-5

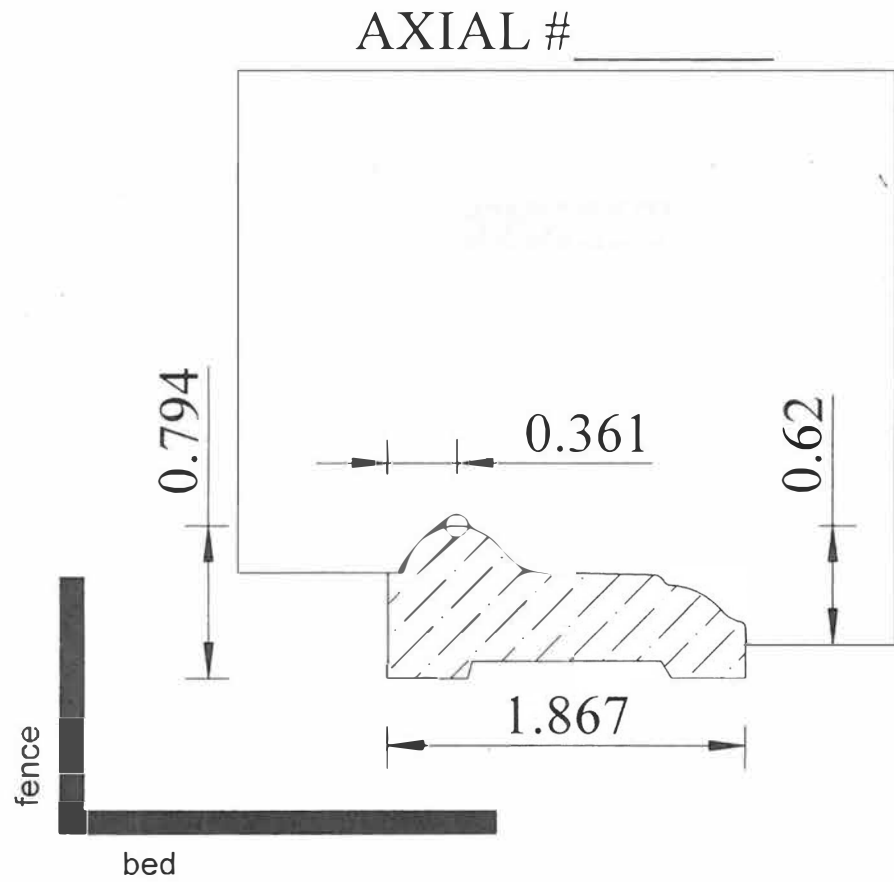

4/0

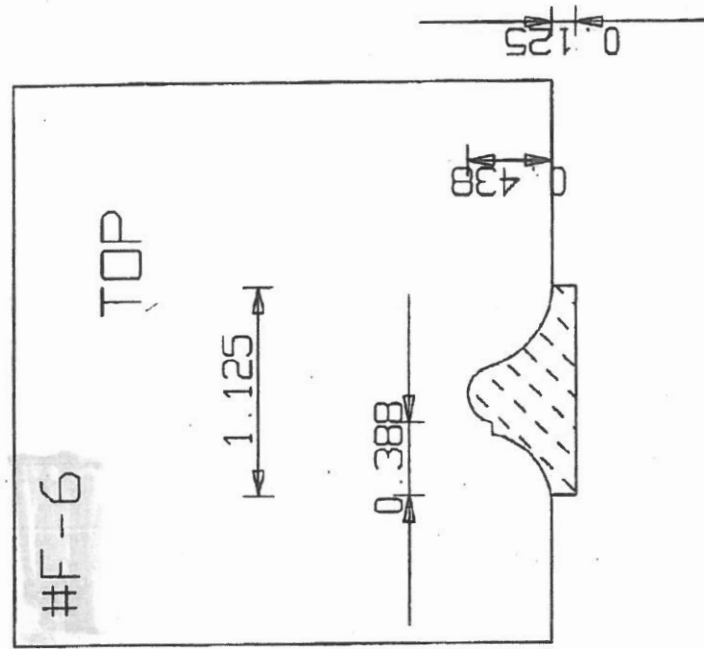

FENCED
0.563

✓
D

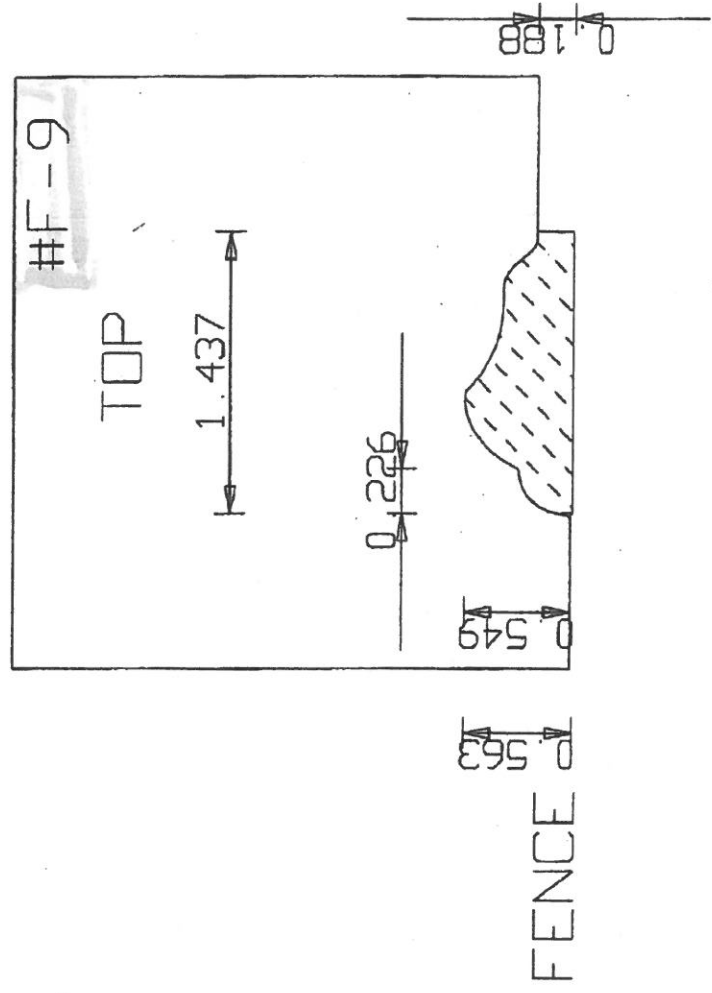

40

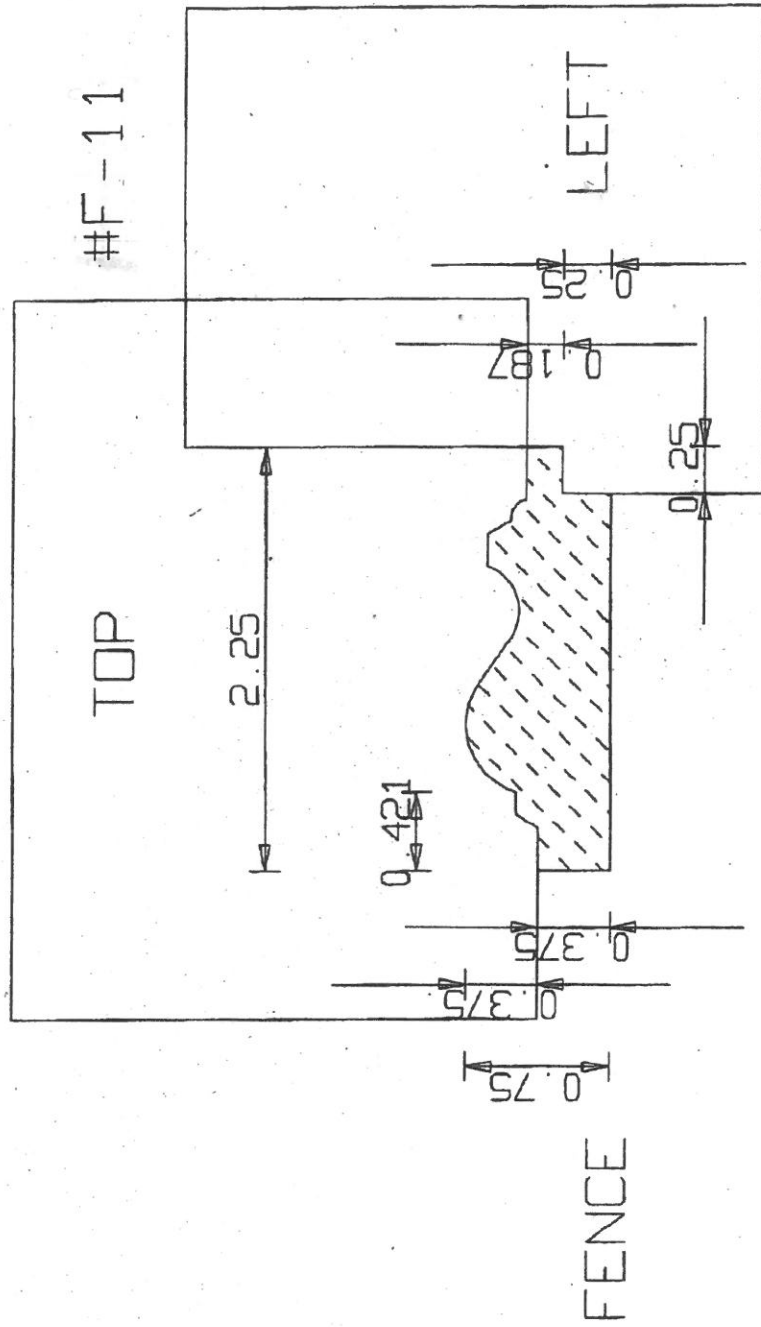

40

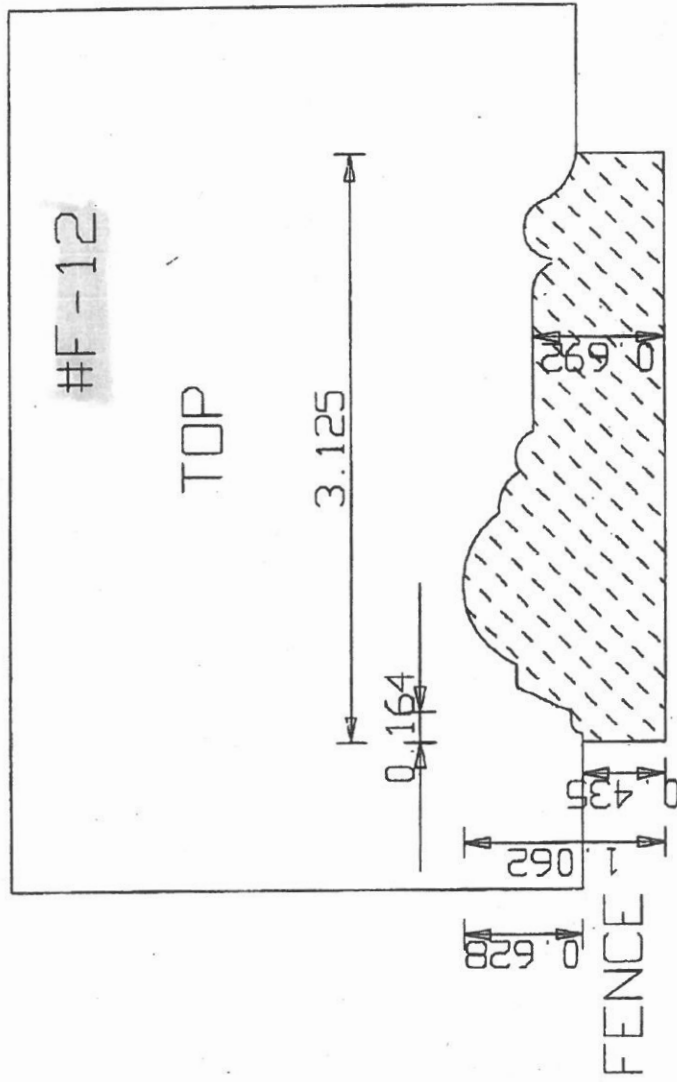

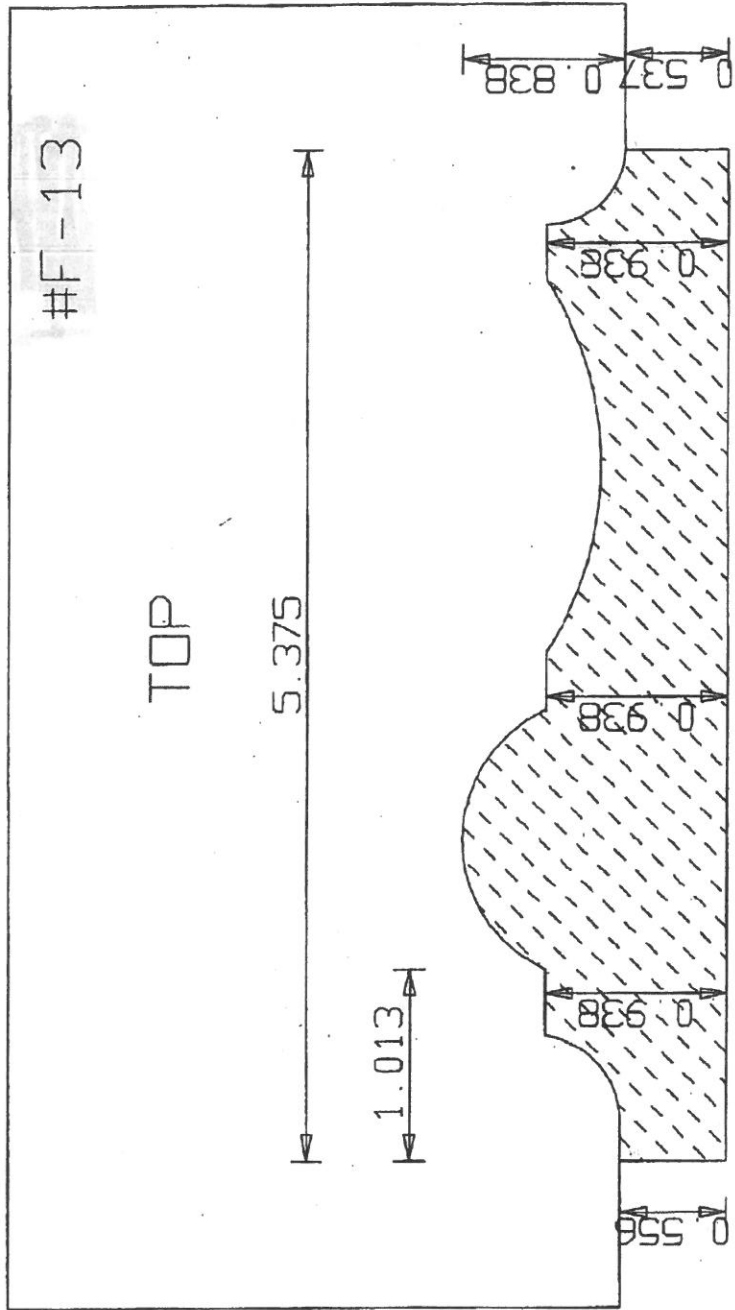

4/0

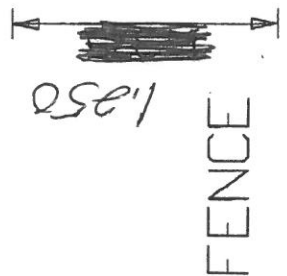

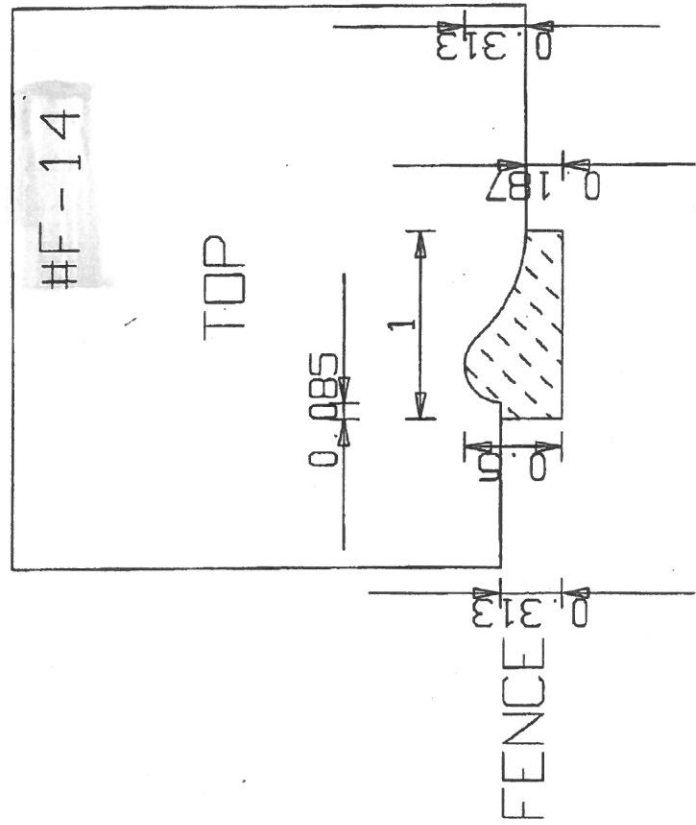

40

✓₀

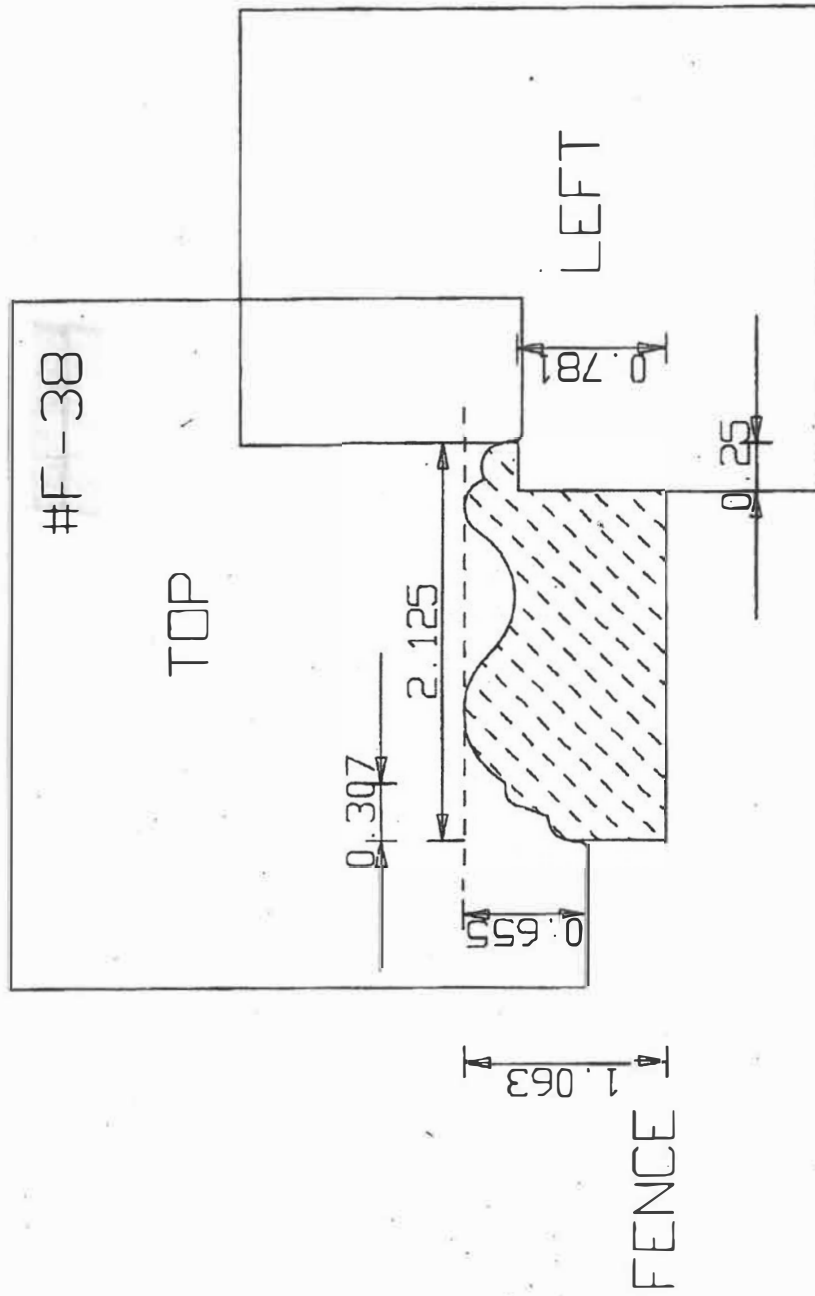

	100000	100000
100000	100000	100000
100000	100000	100000

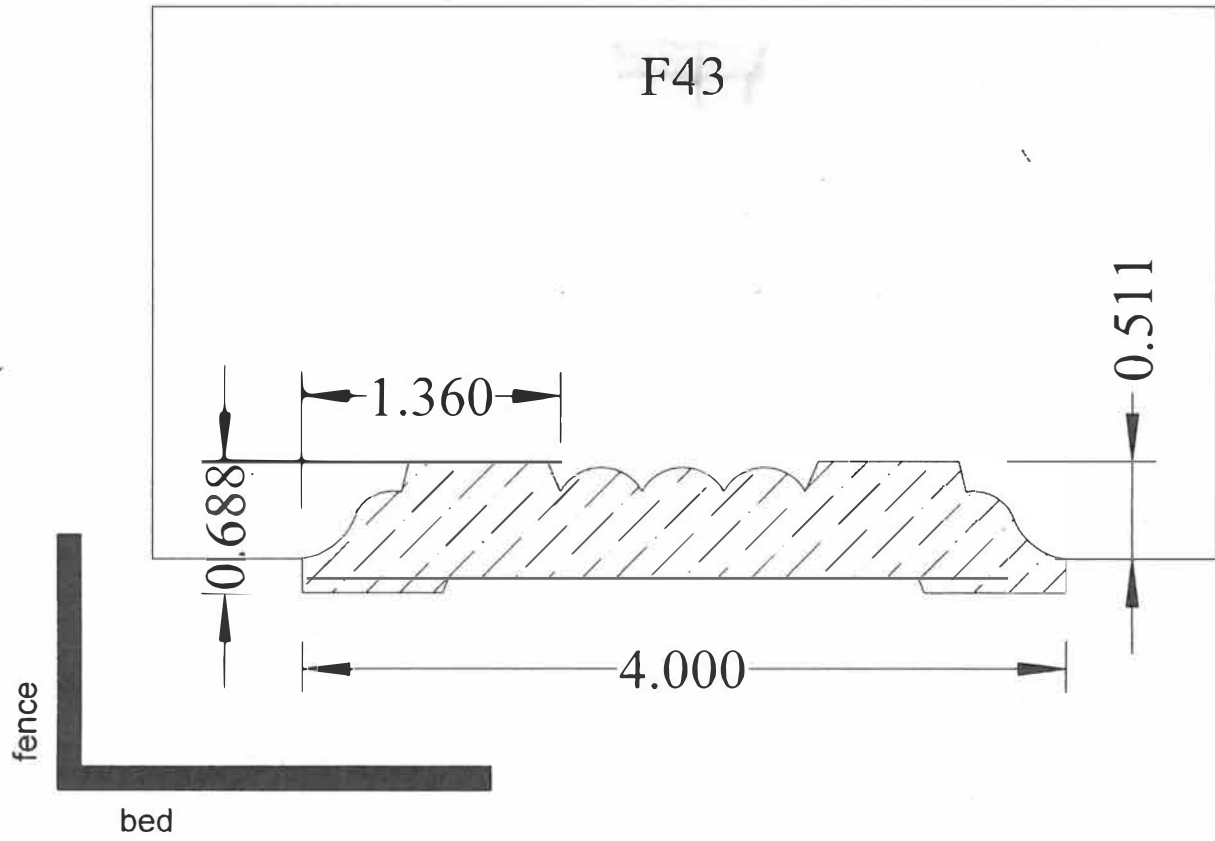

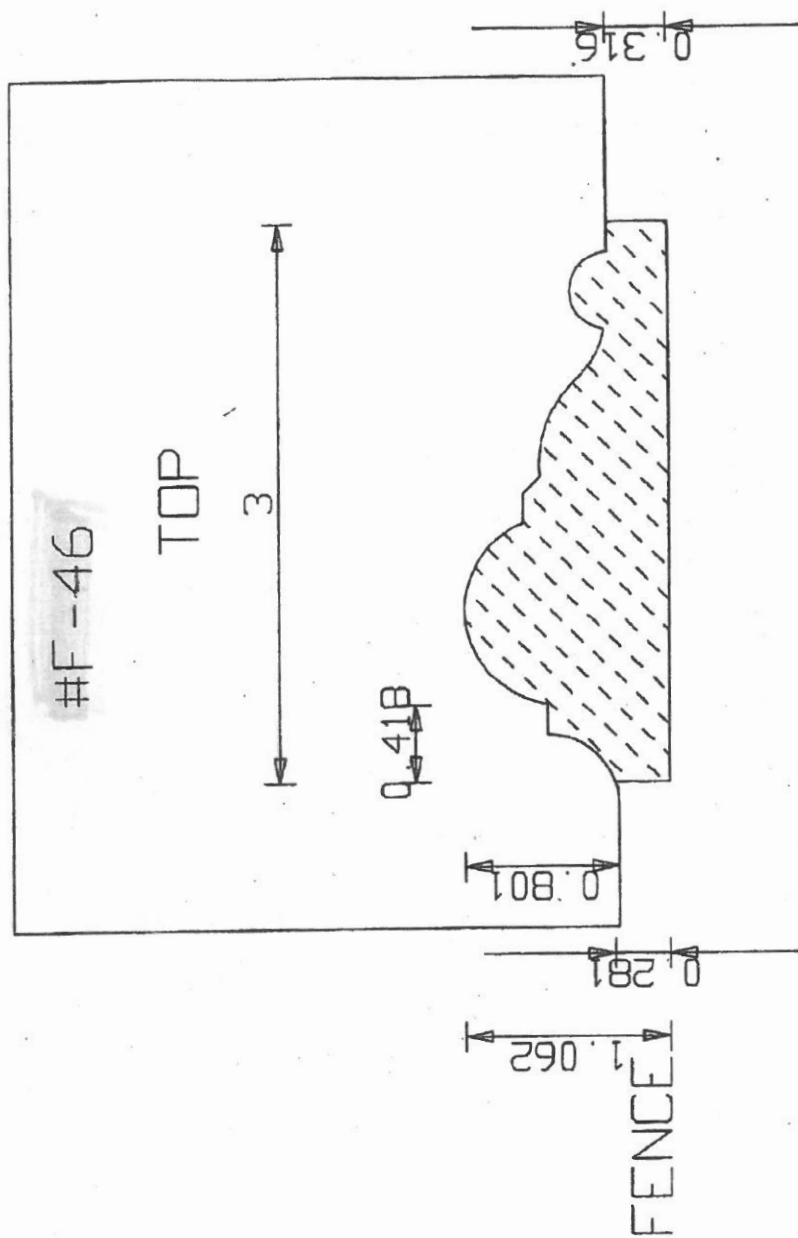

40

F-74

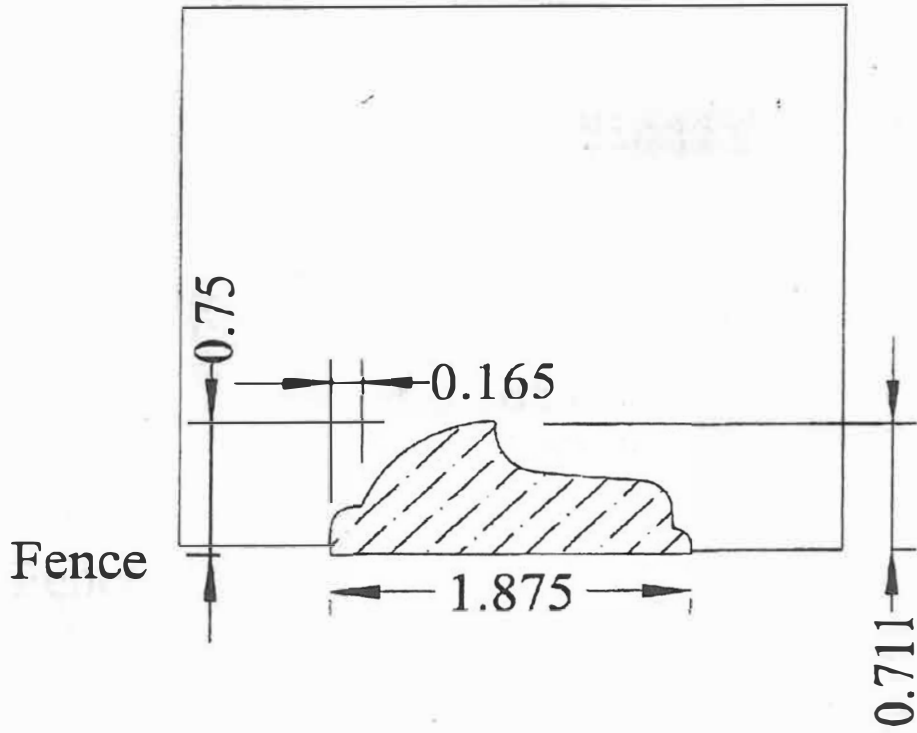

F-58

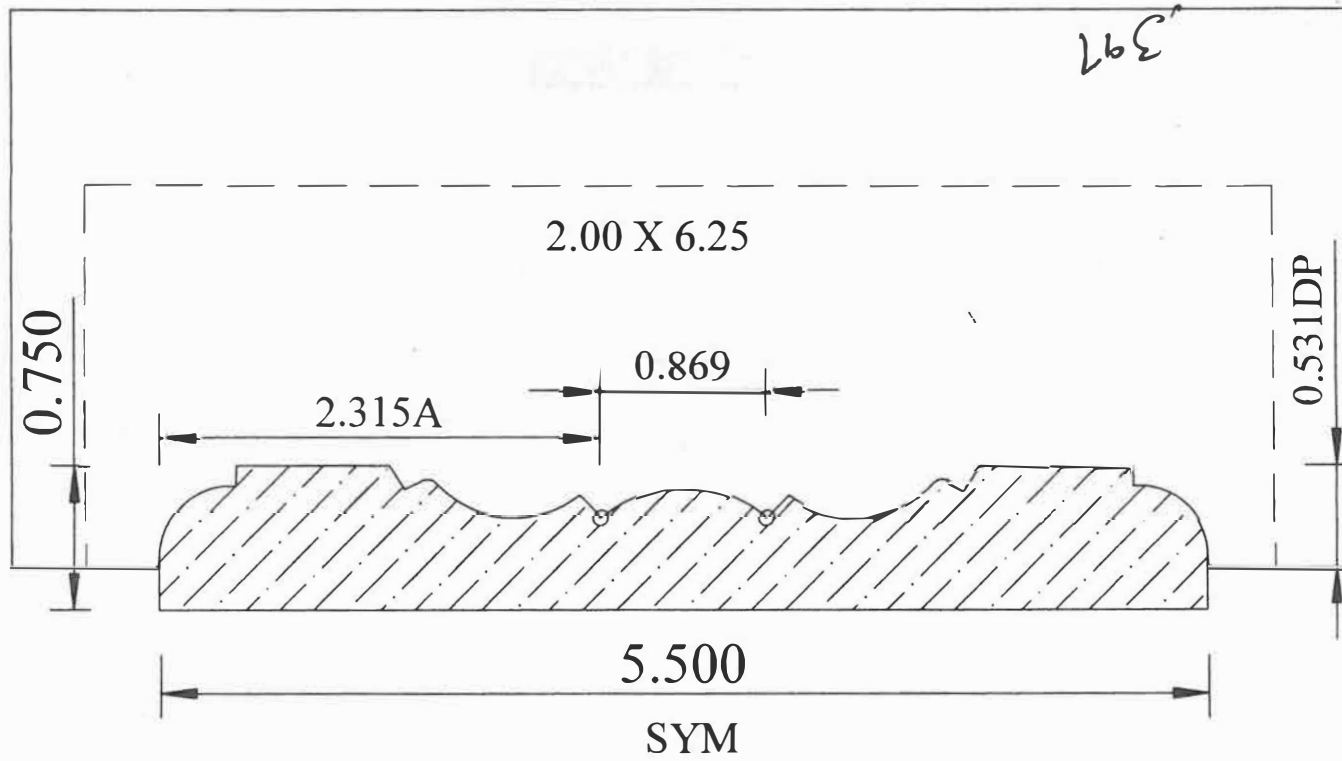

F-58

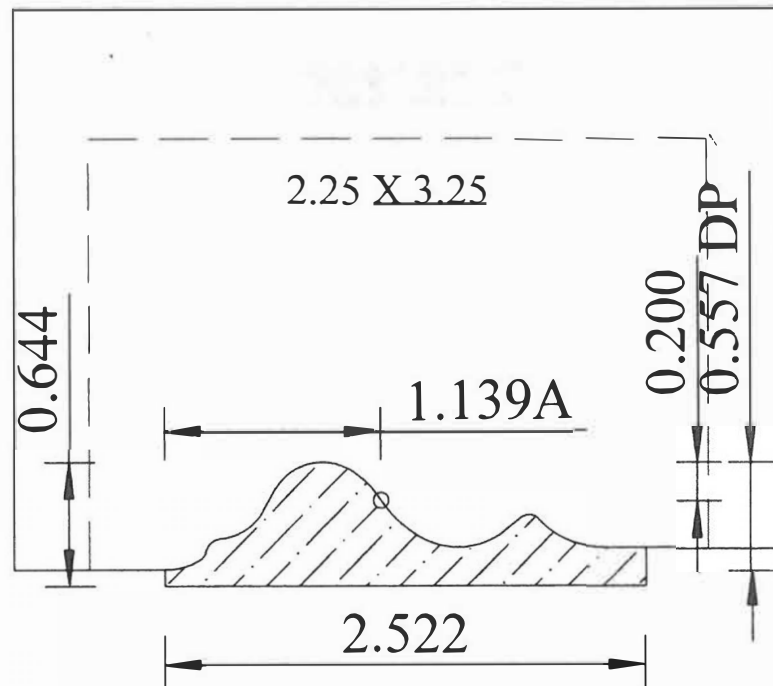
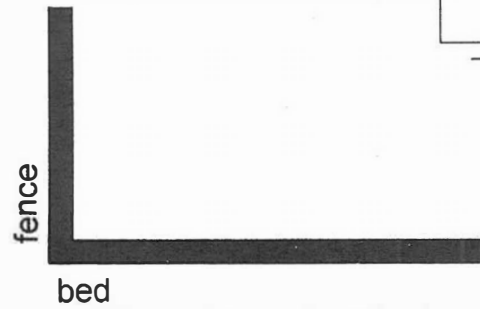

Filling

F-69

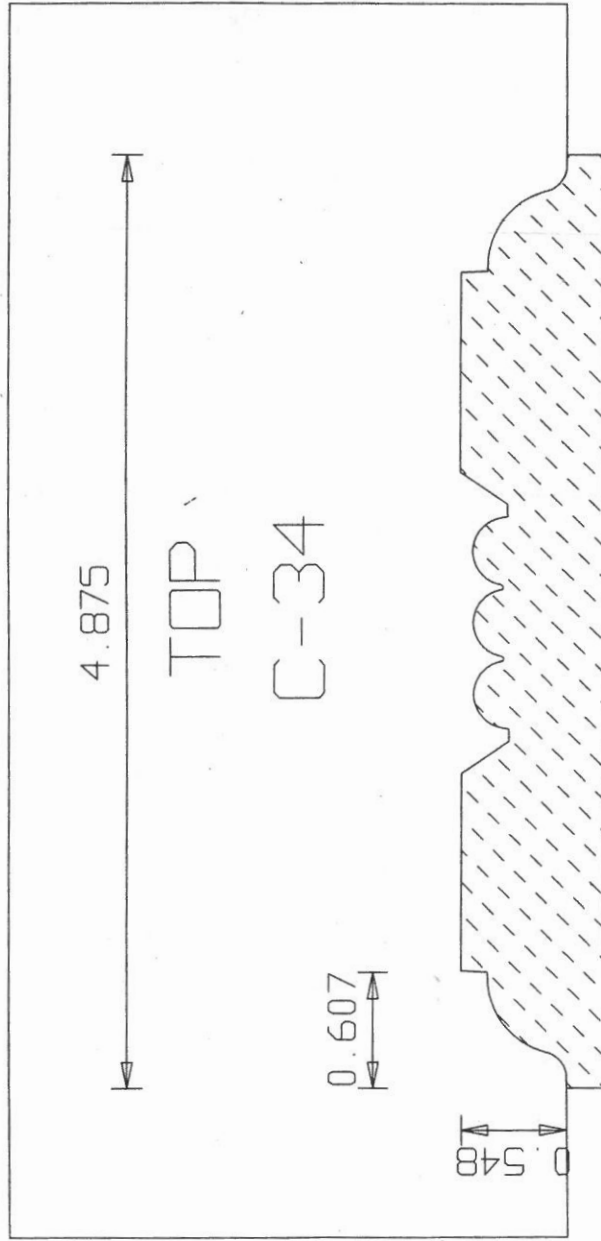

0.75

FENCE

F.91

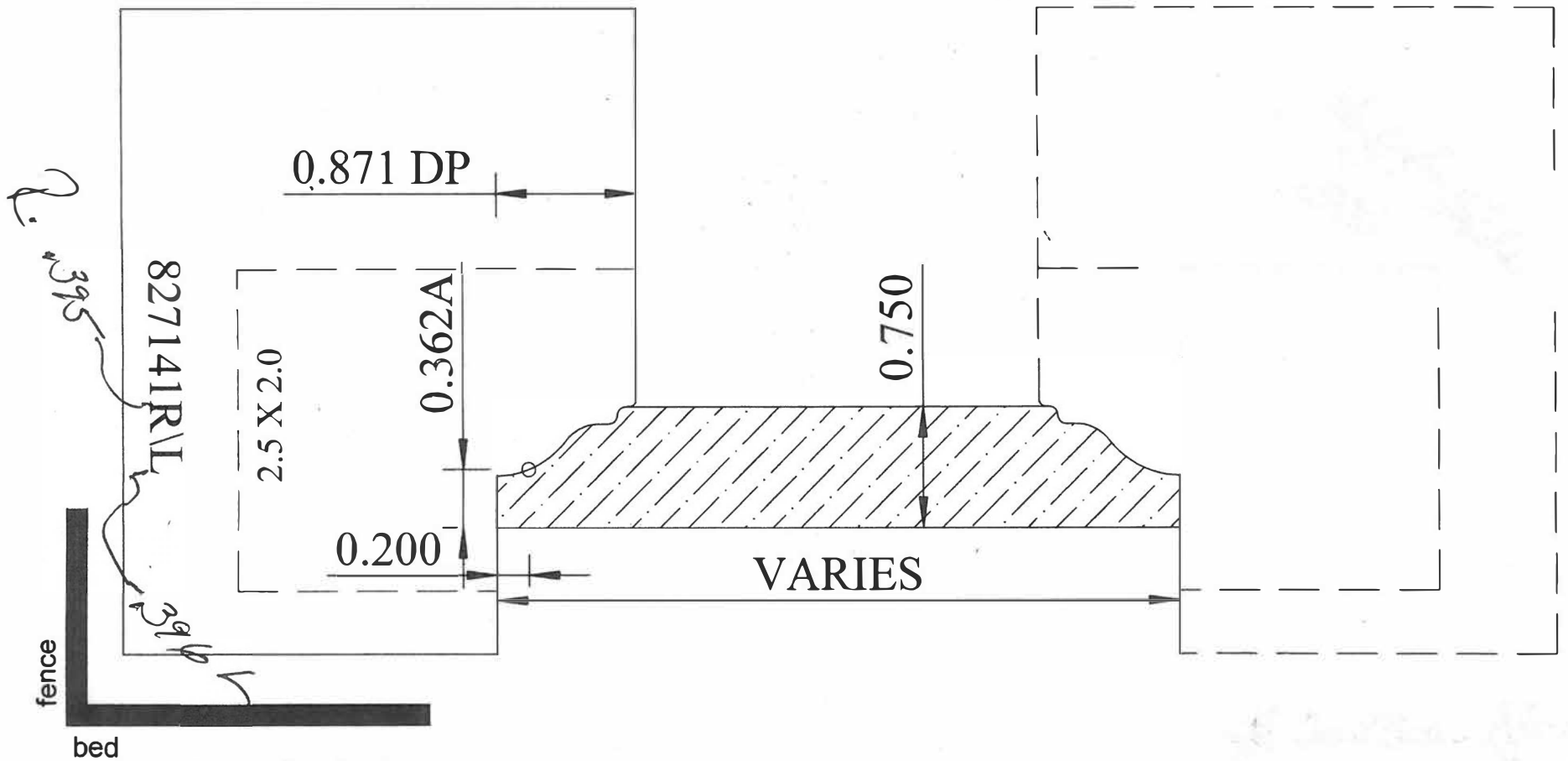

G-64

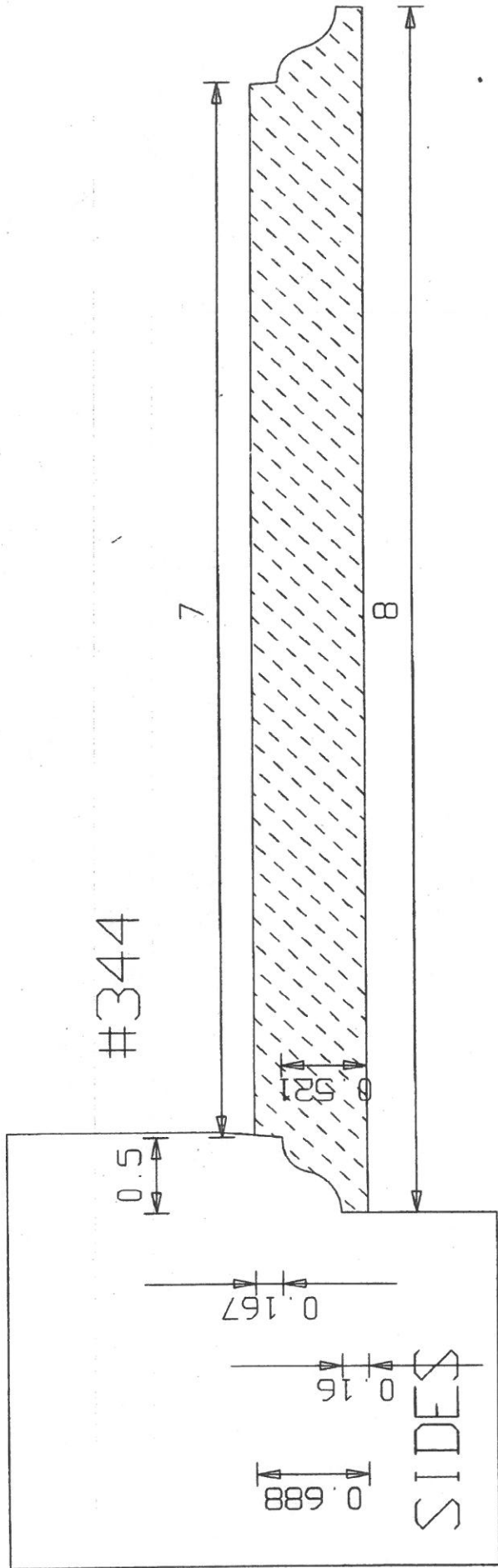

G-79

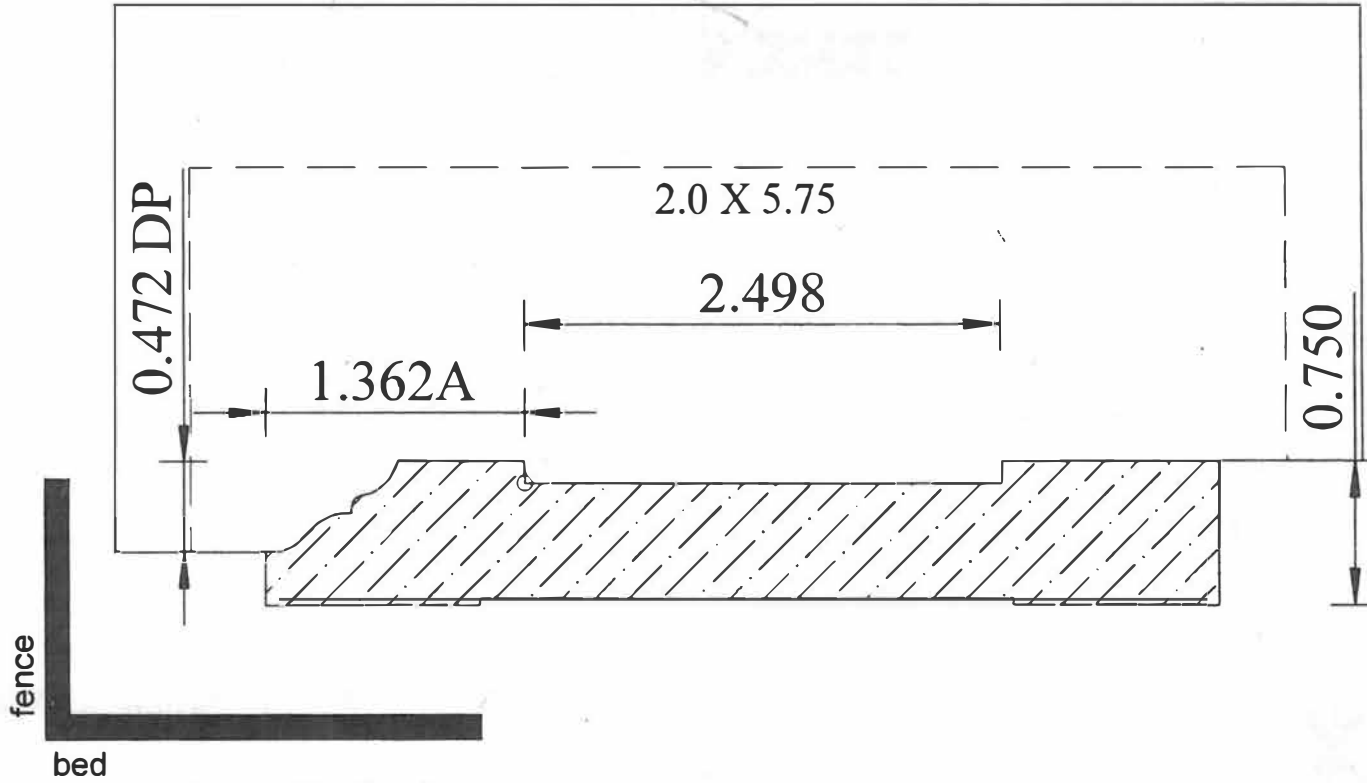

G-83

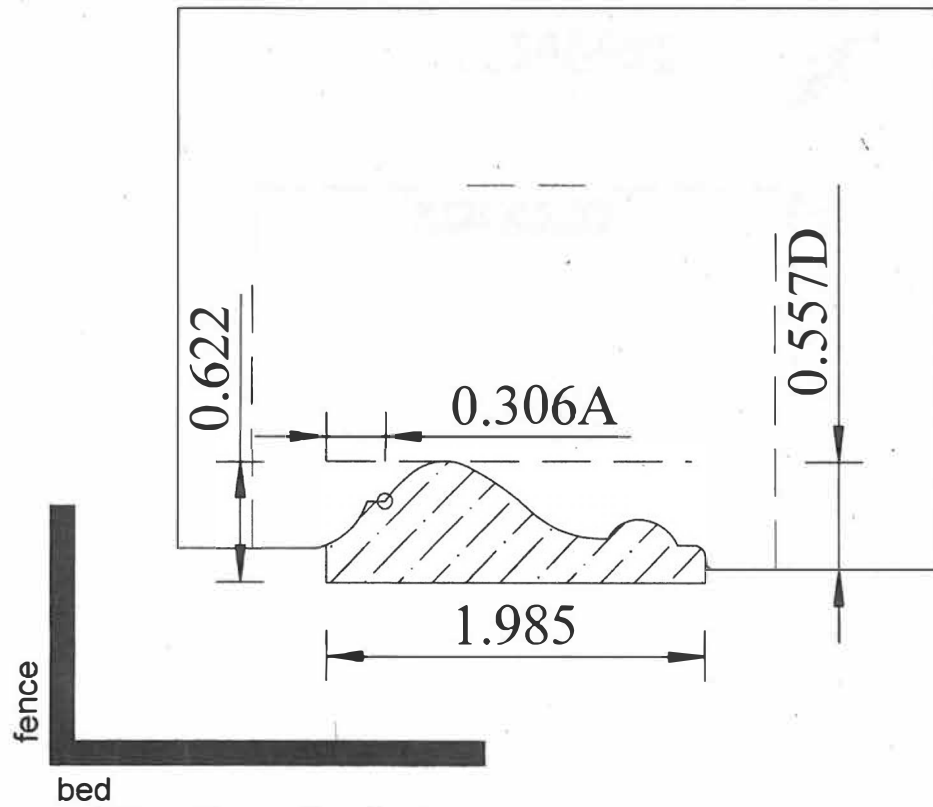

G-85

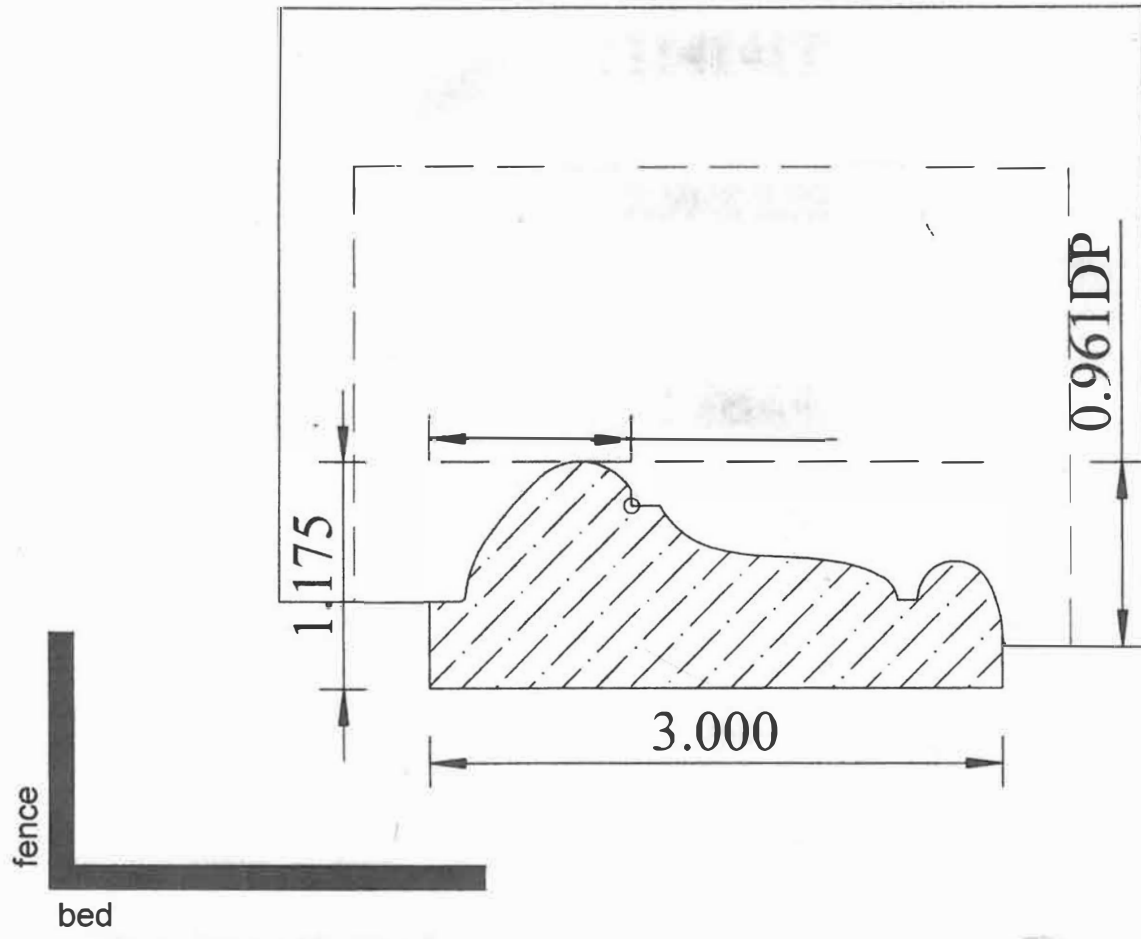

G-91

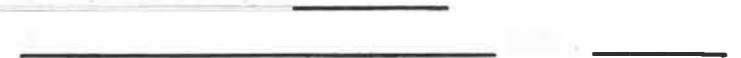
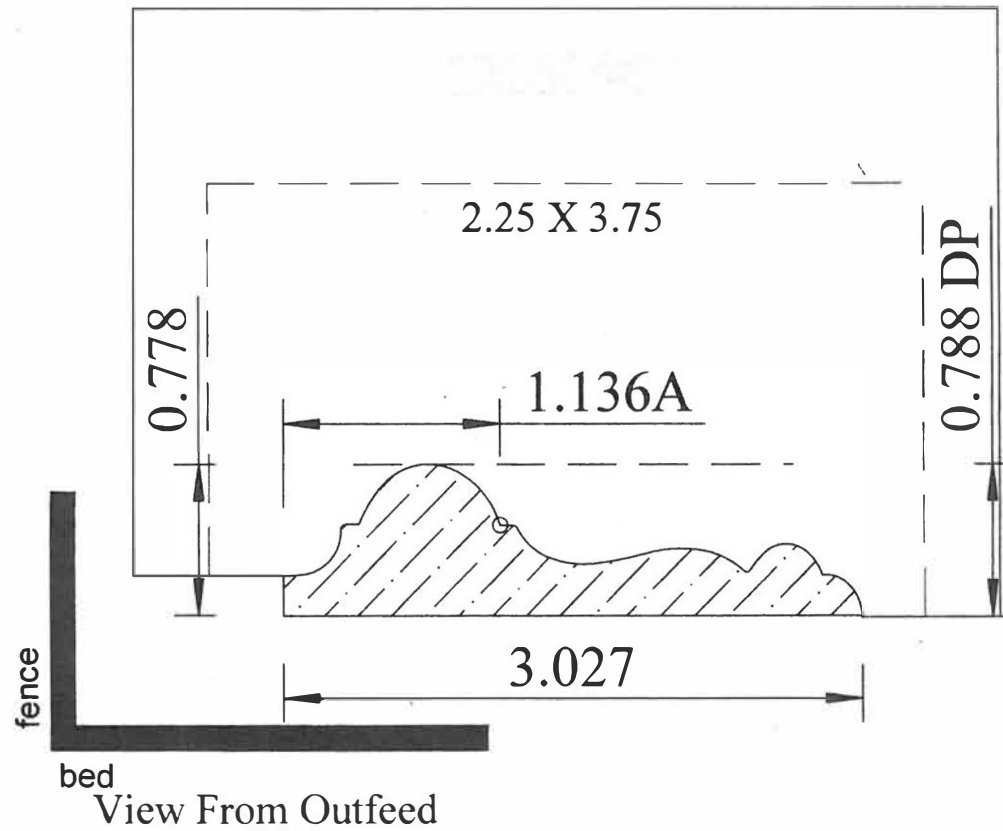

G-92

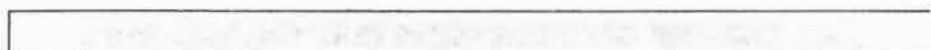
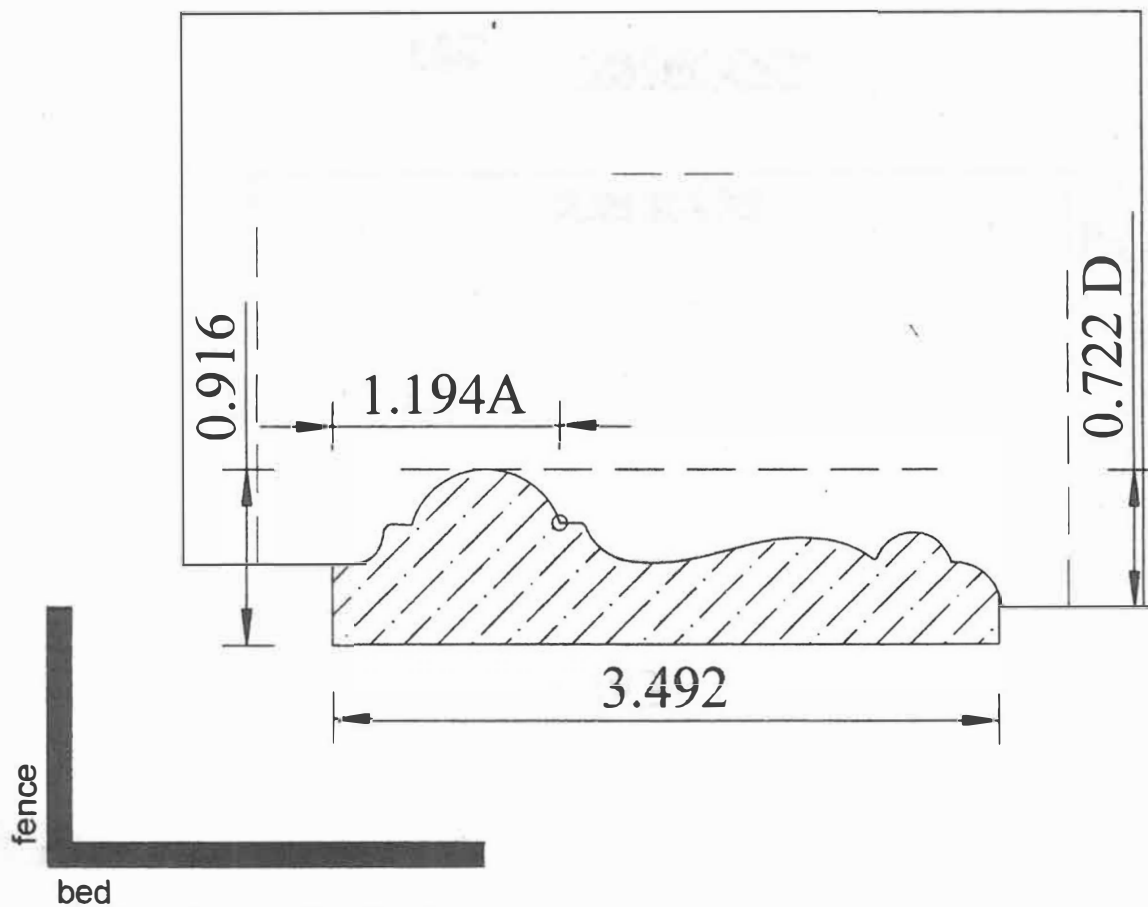

H-74

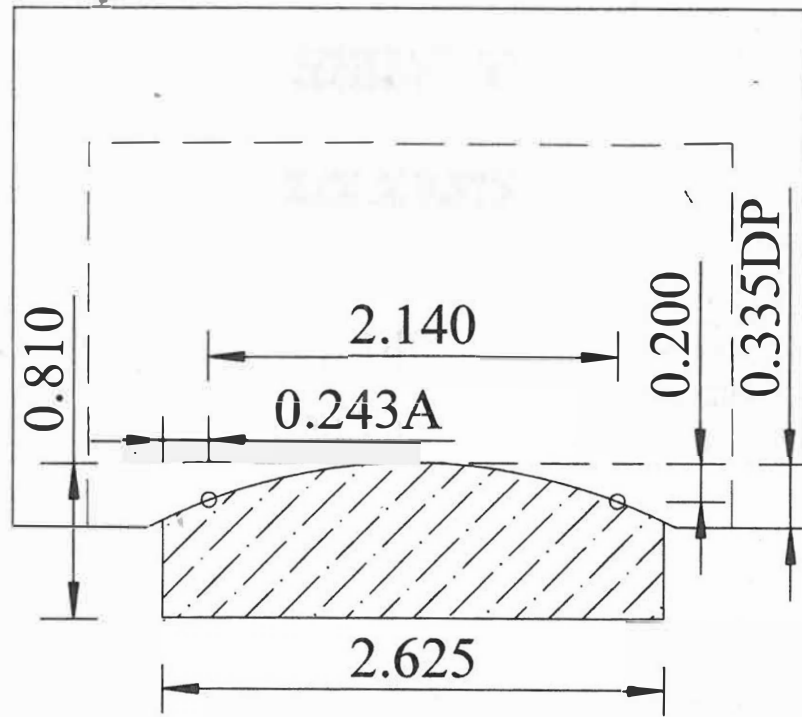

CE

I-43

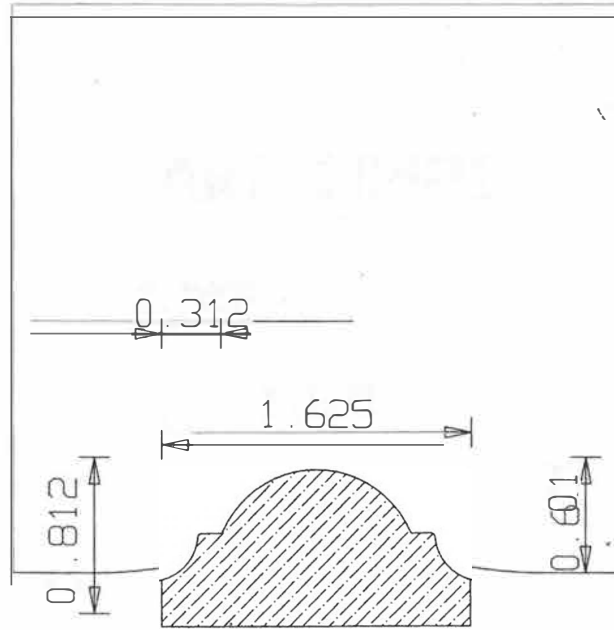

I-64

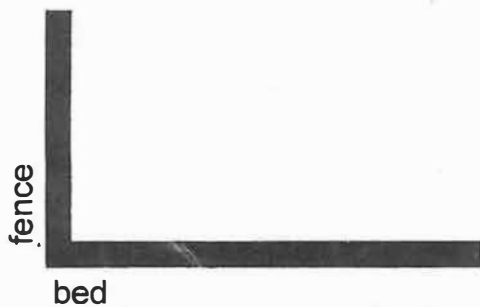
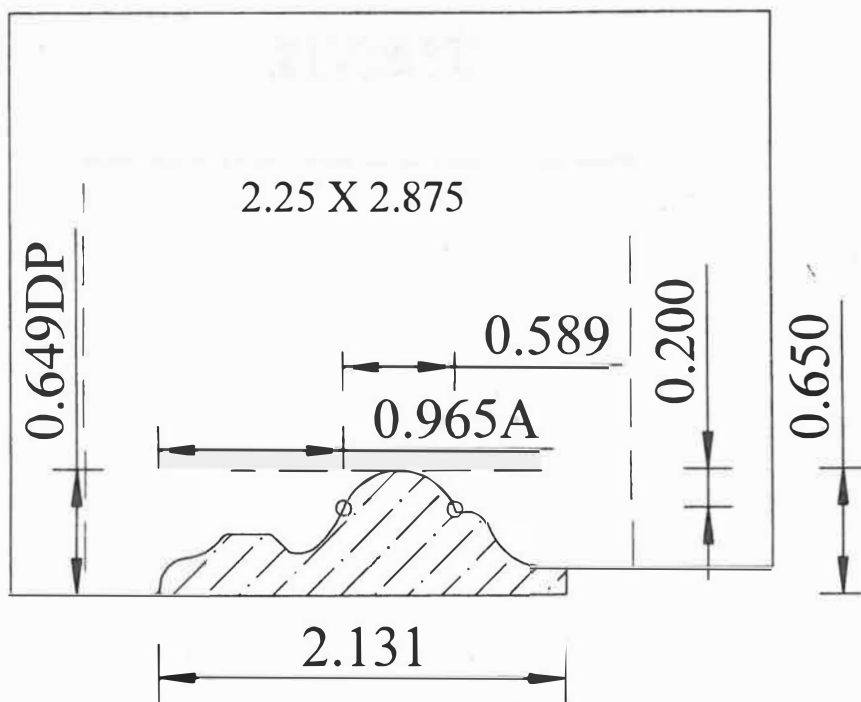

I-70

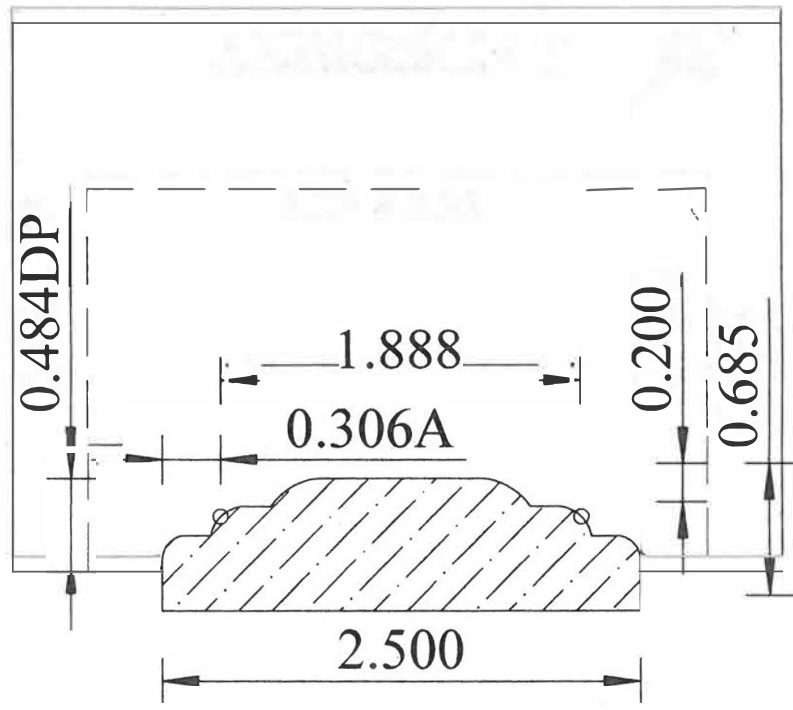

fence

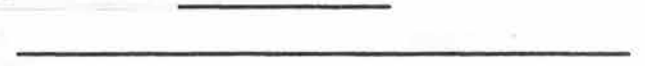
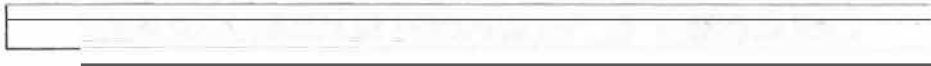

I-73

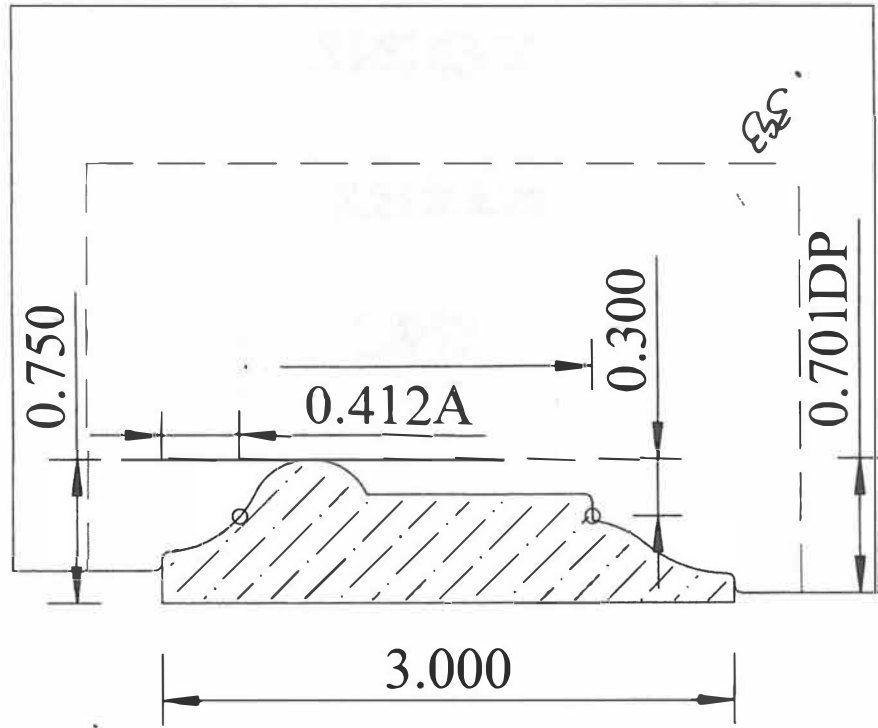

I-81

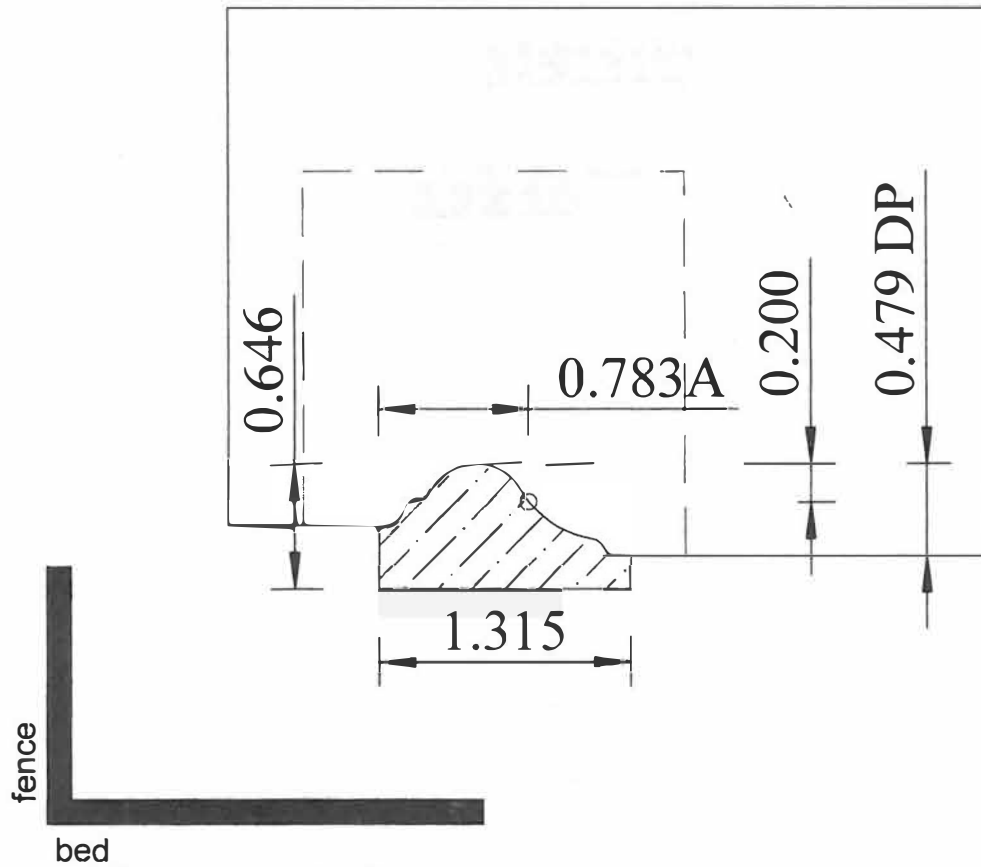

J-70

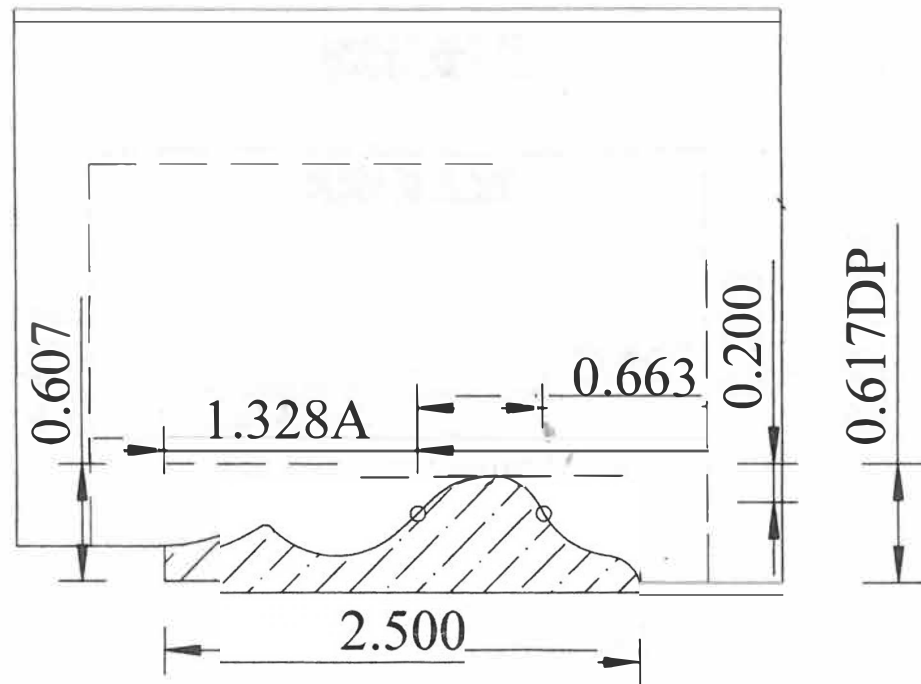

fence

bed



J-89

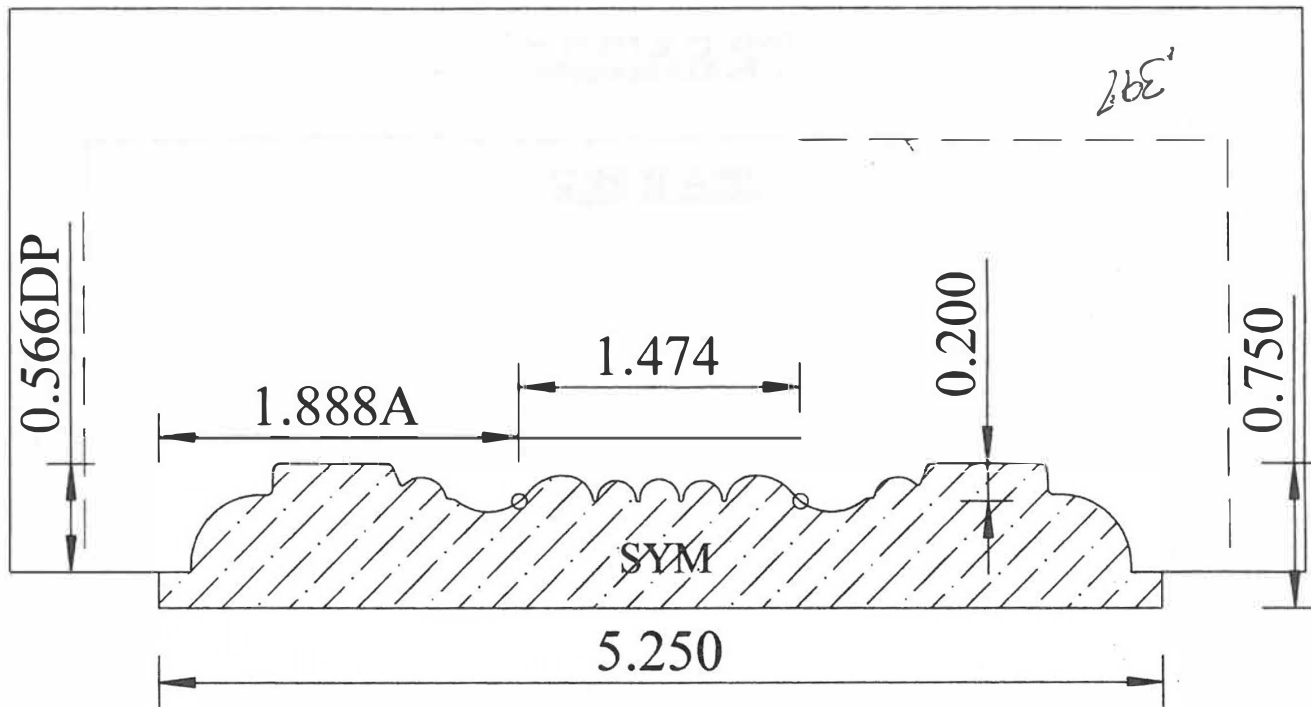

fence



J-94

Profile (L)

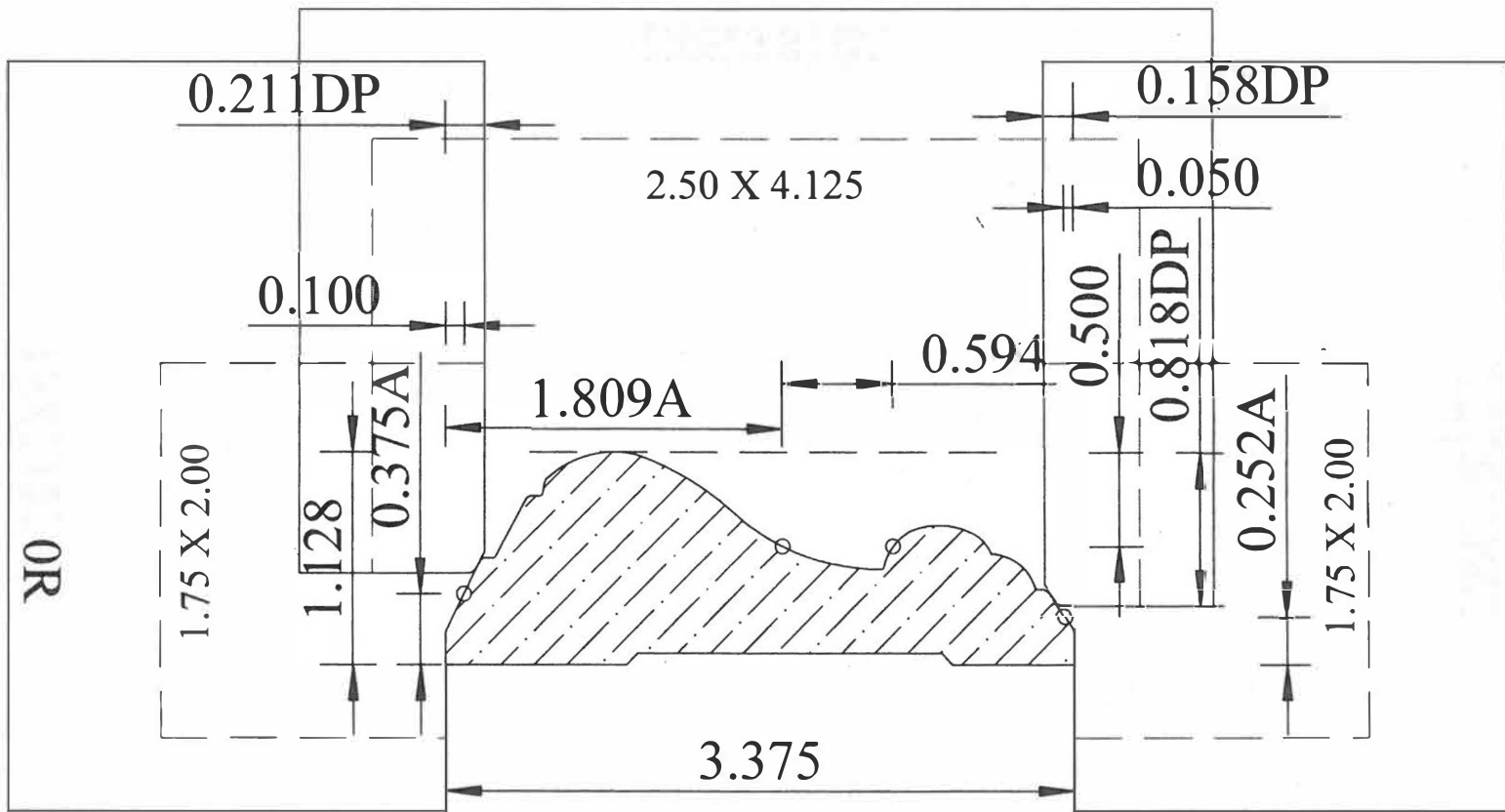

OR

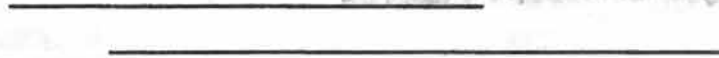

L-73

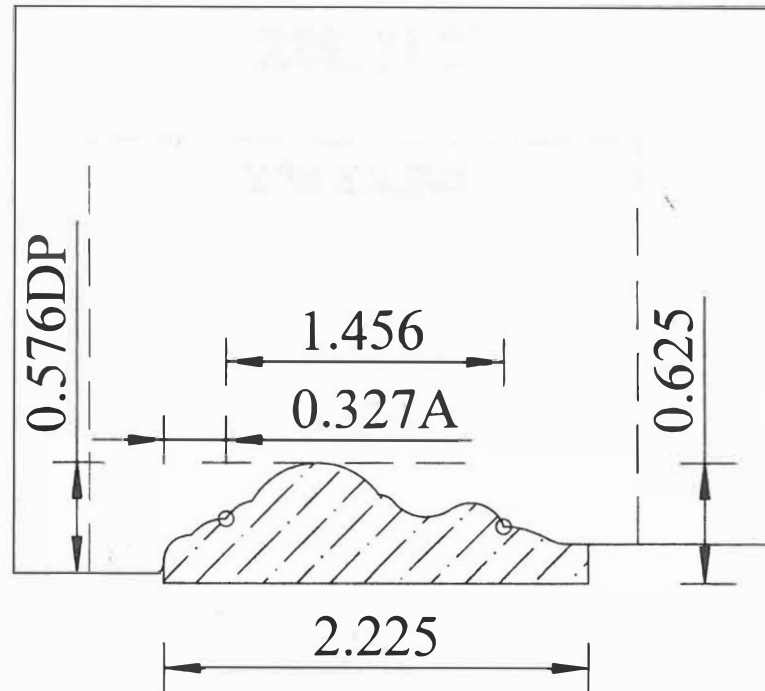

fence

