

V2 | December 2018

ULTRASKY FLAT SKYLIGHT INSTALLATION GUIDE

Dear Customer,

Thank you for choosing the Ultras

Before you commence installation of the skylight, please take a moment to read this guide.

This guide is written on the basis that a qualified surveyor has undertaken correct checks for the capability / structural performance of any existing framework / walls / foundations to verify they are fit for purpose.

Please contact the Tech Support Team on **01200 452 918** or email **techsupport@ultraframe.co.uk**

IMPORTANT NOTES

- Take care when opening package.
- Always wear appropriate PPE when handling glass; Cut level 5 gloves, cut resistant sleeves, eye protection.
- Ensure the skylight is fitted in the correct sequence and orientation.
- Check that the up stand is square by measuring diagonals.
- Larger units will require multiple persons to lift.
- Not suitable to walk on the glass.

ASSEMBLIES & PARTS INCLUDED



Clip (FRICB001M)



Plasterboard trim (LVCT)

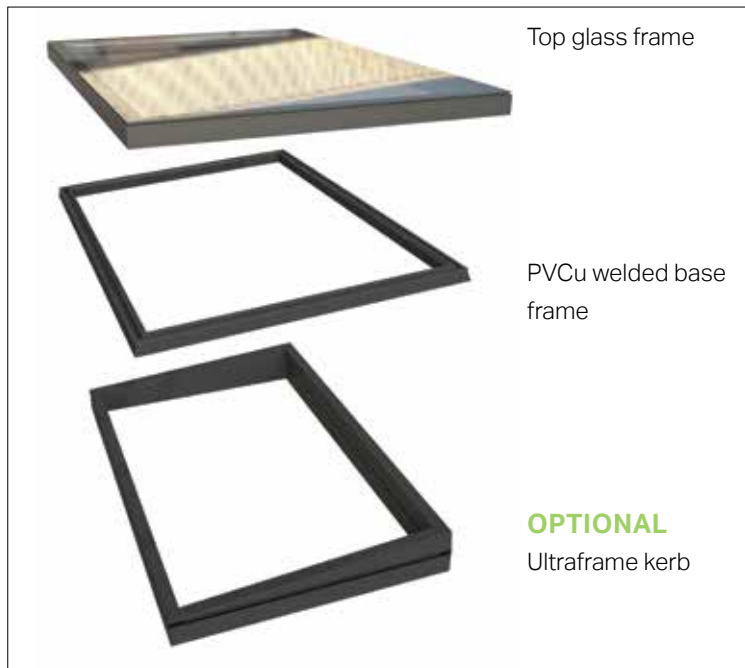

Top glass frame

PVCu welded base frame

OPTIONAL
Ultraframe kerb



90° Angle bracket (FRKBA001)



Tilt Fillet (NRPA/7)

NOT INCLUDED



50mm timber deck screws (suggested)

Screws supplied as required



100mm (FRFC008-100)



200mm (FRFC008-200)



250mm (FRFC008-250)



Self drilling screw
(FRFC008-60)

Surplus fasteners may be supplied in some instances but do not require fitting.

TOOLS REQUIRED



Drill/ Screwdriver



Tape Measure



Spirit Level



Stanley Knife



Sealant Gun



5mm Drill Bit

KERB INSTALLATION

ULTRAFRAME KERB

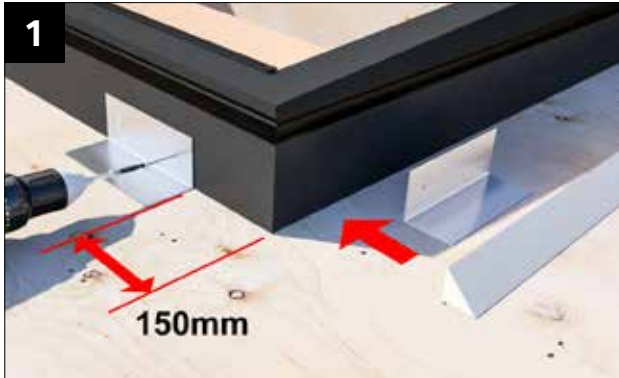

Align Ultraframe kerb assembly with the aperture. Fix 90° angle bracket (FRKBA001) 150mm from end face using 2x Self drilling screw (FRFC008-60) into pre drilled holes. Fix appropriately to roof using suitable screws. Position 4x tilt fillets (NRPA/7). **NOTE: Fasteners to roof (not supplied)**

CUSTOMER SUPPLIED KERB

Kerb construction rules



80mm Overall including roof covering, excluding plasterboard

Min 150mm



Construct the up stand to flat roof and fit roof covering.

NOTE: Measure diagonal corners to check sizes

ROOF COVERINGS WITH ULTRAFRAME KERB

Guidance only, always consult your roof covering supplier prior to fitting.

Membrane:

Option 1 Lap membrane over the top of the kerb ensuring that a watertight finish is achieved.

Option 2 Wrap the membrane up to the top face of the kerb, knife flush and fix using sealant/adhesive - ensuring that a watertight finish is achieved.

Bitumen Felt and torch on Systems: The Ultraframe kerb should be primed and normal application methods followed. For torch on products, the torch should be directed at the waterproofing and not directly at the Ultraframe skylight kerb (see image).

Asphalt: The Ultraframe kerb should be primed and expanded metal lathe (EML) metal should be attached using 10mm maximum length nails or screws. First coat asphalt should be applied cooler than normal (approx 180°), and should be as thin as practically possible. The first coat must be completely cool before applying successive coats which can be applied at normal temperatures and thicknesses.

Fibreglass: The Ultraframe kerb should be primed to ensure an excellent bond between PVCu liners and GRP reinforcement. Microseal T20 is recommended. Apply an even layer by brush onto the PVCu. Leave surface for 45 - 60 minutes. Then apply first coat of catalysed polyester resin. The fibre reinforcing is then added and built up to the required thickness (max thickness 10mm).

E.D.P.M Rubber: The Ultraframe kerb should be primed and normal application methods followed. Refer to supplier for further information.

Single Ply Systems: This may be solvent or hot air welded and mechanically fixed to the Ultraframe skylight kerb, dependant on the type of membrane. Refer to supplier for further information.

Post Skylight Installation: Roof coverings can be applied before or after the skylight is installed. When applying roof covering after the skylight it must be wedged behind the aluminum frame.

Torch on system

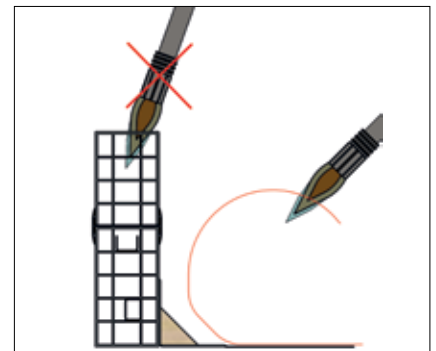

Fibreglass

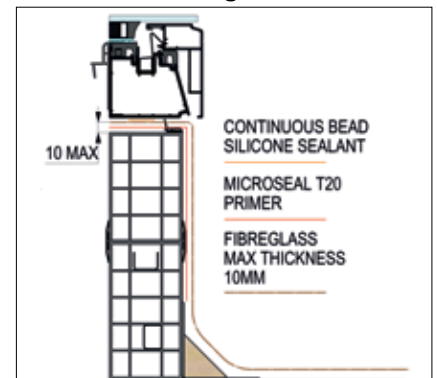

FLAT SKYLIGHT INSTALLATION



Apply a generous, continuous bead of silicone to the top surface of the kerb as shown. NOTE: If Ultraframe kerb remove adhesive film prior to silicone application.



Position PVCu welded base frame and align with internal kerb face.

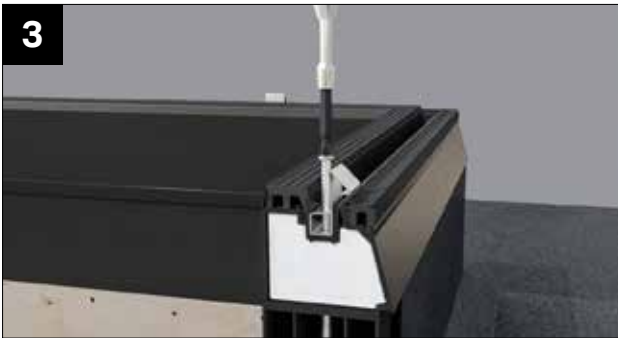

Ensure you use all the clips provided. Position clips (FRICB001M) into location holes and fix using a screws as outlined below into the kerb.

Screw length supplied:

100mm (FRFC008-100) – If customers supply their own kerb.

200mm (FRFC008-200) – Always required with Ultraframe Kerb

250mm (FRFC008-250) – If slope is between 1301 - 1400mm, ensure 2 screws are used in clips in the lowest corners

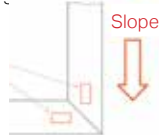

Fit the top glass frame onto the PVCu frame. Carefully lower into position and then apply downwards pressure to opposite sides to activate clips locking feature. (You will hear a click).

NOTE: Larger units will require multiple persons to lift.

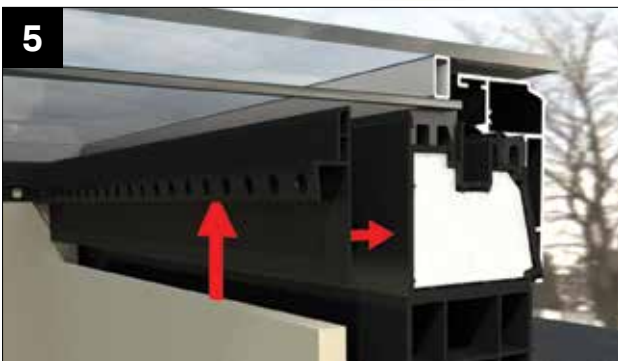

Plasterboard trim fitting -

OPTION ONE - Fit to edge of plasterboard and then fix plasterboard appropriately

OPTION TWO - Position as shown and then fix; using a countersunk screw and adhesive (not supplied) and then fit plasterboard.

NOTE: Top edge to be flush with internal glass.



INSTALLATION IS COMPLETE

www.ultraframetrade.co.uk

Ultraframe®
Transforming light and space

Job No.: 3902 12/18 V1 FRIG001

It is Ultraframe's policy to continually seek to improve its products, processes and services, and we reserve the right to change specifications without prior notice. Ultraframe is a trading name of Ultraframe (UK) Limited.