

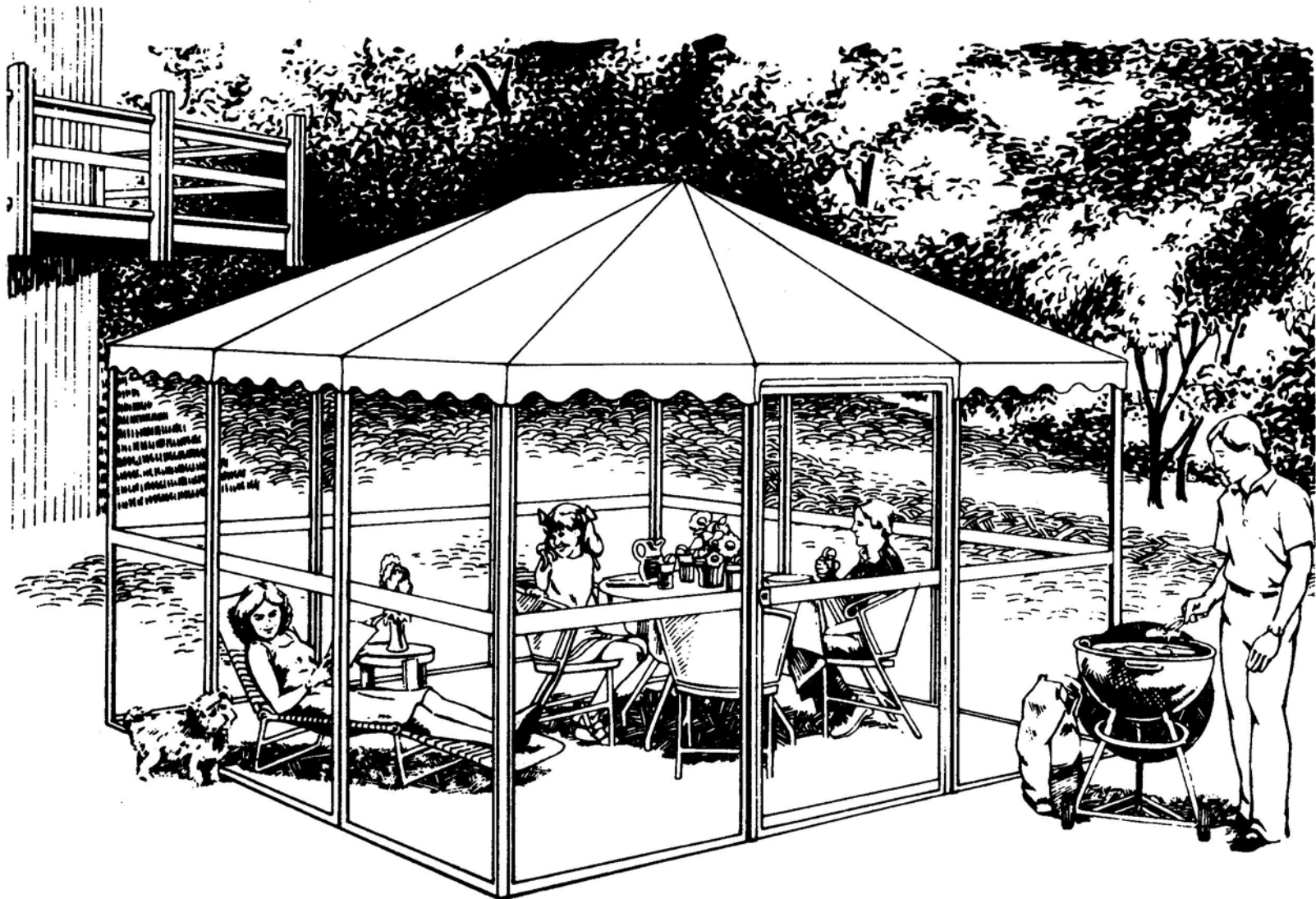

SCREENHOUSE

Owner's guide and assembly instructions 12 Panel Square Models



NOTE: DO NOT SEEK REPLACEMENT OF PARTS THROUGH THE STORE. RETURN ENCLOSED CARD TO THE FACTORY OR CALL CUSTOMER SERVICES AT 800-626-5296.

Safety Instructions

1. Do not attempt to assemble the screenhouse under windy conditions.
2. In the event strong winds or storms are forecast, disassemble and store in a safe place. Minimum precaution requires removal of the roof.
3. The screenhouse is not designed to hold a snow load. Disassemble during snow season.
4. Keep open flames and inflammable materials outside and at a safe distance from your screenhouse.

1. Prior to assembly:

• Read all instructions thoroughly before attempting assembly.

A. To safely and easily assemble the screenhouse, a minimum of two people are needed. You will need a medium-sized slothead screwdriver, a hammer and a sturdy chair or 5-6 foot ladder.

B. You should erect your screenhouse on as level a spot as possible.

C. Remove the vinyl roof, roof tubes, vinyl hinge, bag of parts and the door hardware box, then inventory the parts as follows:

	40" Panel	45" Panel
(4) Corner roof tubes	76"	85 1/2"
(4) Side roof tubes	64 1/16"	72 1/2"
(4) End roof tubes	50 1/16"	57 1/4"
(1) Peak roof tube	39 3/4"	44 3/4"

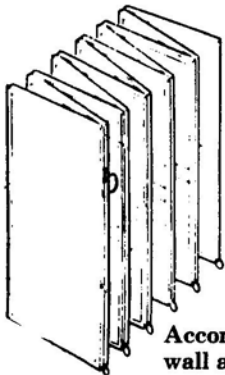

Accordion folded wall assembly (1)

Vinyl hinge (1)

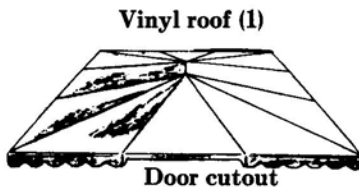

Vinyl roof (1)

Door cutout

Vinyl parts bag (1) containing:



Anchor stakes (10)



Tube tips (12)



Boxed door latch assembly (1)

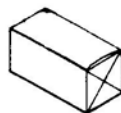

Roof hub (2)

D. Completely open vinyl roof on a flat surface, preferably in direct sunlight, to allow folds and creases to disappear.

E. Set packing carton upright and remove wall assembly, making sure wire stake loops are on the ground.

F. Unfold wall assembly like an accordion. Make certain wire stake loops are not snagged on adjoining wall joint. If so, do not force, but simply un snag wire loops and continue unfolding.

G. Retain the packing carton for off-season storage.

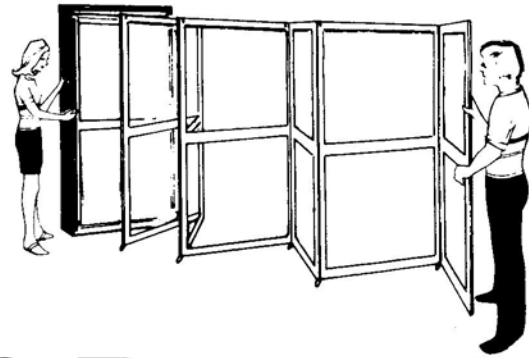

2. To assemble the wall:

A. Form a rough square with the wall as shown, making sure the door opens out.

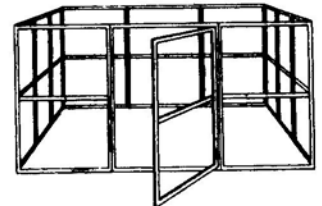

B. Unhook the rubber bands securing the ends of both top and bottom wire support cables.

Plastic cable retainers inserted and removed.



C. Remove the black self-locking cable retainer from the top left corner of door panel. (Use a screwdriver, pen or nail to depress the black square stud and slide the cable retainer out.)

D. Remove the black, self-locking cable retainer from the top right and bottom right corners of the wall section to left of door panel.

E. Line up the left edge of the door panel and right edge of the adjacent wall panel, so that the corners from which cable retainers have been removed are adjoining.

F. Hold one end of the vinyl hinge vertically above the hinge channels of the two adjacent sections. Slowly pull edges of hinge into channels until fully inserted. The vinyl hinge will slide more easily if first dipped in water.

Vinyl hinge Door section



Hinge channels

Wall section

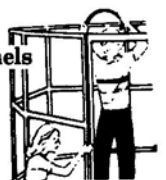

G. Unhook the extra wire loop from the lower cable clip and locate it directly between the two panels. Connect the bottom cable and center in the bottom channel. Replace bottom cable retaining clip, making sure the wire loop is to the left of the retainer clip at bottom. This will be used for staking the Screenhouse.

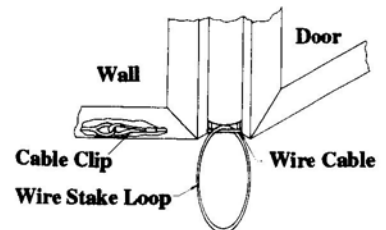

Wall

Door

Cable Clip

Wire Stake Loop

Wire Cable

Note: The easiest way to replace the cable retainers is to insert the stud into the channel entrance first, and then rotate the curved leg of the retainer into the channel. Slide the retainer into the channel until the stud clicks into its hole.

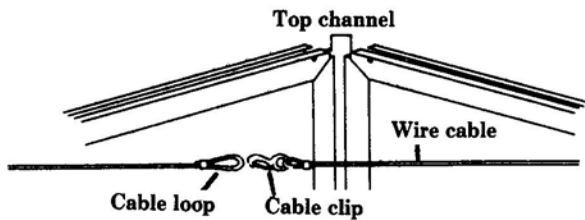

H. Connect top cable ends together with clip provided and center cable in top channel. Replace two remaining cable retainer clips.

3. To assemble the roof frame:

A. Remove roof tube tips from the parts bag.

B. Insert the roof tube tips into the roof tubes (rafters):

1. To insert the tip properly, just push the plastic tip into the aluminum tube with the upraised square stud to either side of the holes. Rotate the tip until the stud snaps into place in the desired hole of the tube. You'll be able to hear it click as well as see it. Also, you will note by now that this operation is similar to that used on the cable retainers.

2. There are three (3) square holes near the end of each tube. Notice that there is a square, upraised stud on the end of each black, molded-nylon tube tip. By inserting this stud into the first, second or third hole of the tube, you can adjust the length of the tube to allow for roof size variation and taut roof fit.

3. When you first put your new roof on your screenhouse, the studs should be in the second square hole. Through use, if your roof relaxes to the point that it is baggy, the tube can be adjusted to its maximum length to compensate. If you notice that the roof is becoming hard to assemble because of shrinkage, just move the tips back to the third hole, as required, to make a proper fit.

It is important that all tips be in the same holes in all tubes for best fit. That is, if one tip is in the second hole, all remaining tips should also be in the second hole.

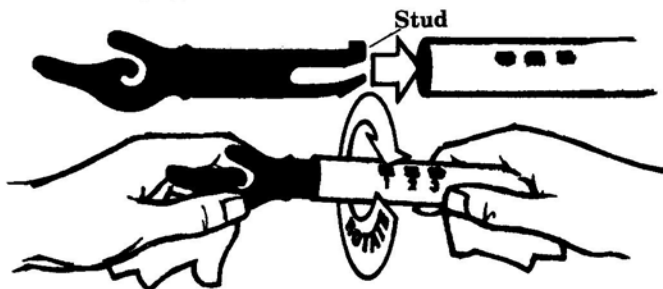

C. Enter the screenhouse, taking the spoked roof hubs and all roof tubes.

D. One person should stand on a sturdy stool or stepladder near the center of the wall assembly, holding one of the spoked roof hubs with spokes angled downward level with the top of the walls.

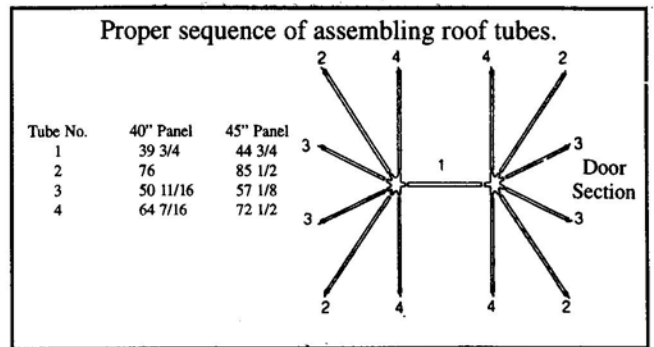
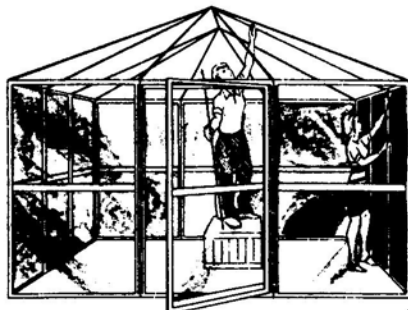

The second person should pick up two of the roof tubes that go in the corner (#2). Insert the tube snugly on each of the two proper hub spokes. Work

the tip end of the tube under the wire cable at the wall perimeter (see above illustration for proper positioning). Next, insert the tubes in the #4 location then the #3 tubes in a similar manner. Insert tube #1 into the hub, and attach the second hub to the end, at the other end of the enclosure. Repeat this procedure on the other end of the screenhouse. The structure is now complete. Maintain a firm grip on the tubes during this procedure as they are under significant tension.

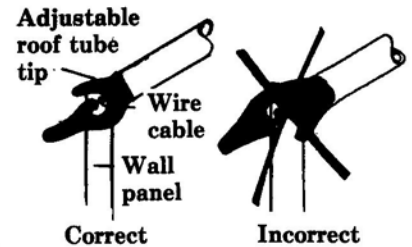

Correct **Incorrect**

IMPORTANT NOTE: It is very important that the roof tubes be hooked under the cable **ONLY AS SHOWN ABOVE** (left). Should the position be reversed, as shown, (above right), the roof will not be securely anchored, and could blow off in moderate winds. The cable must be located fully in the eye of the plain tube tip.

CAUTION: Make sure the roof tubes are pushed all the way on and firmly against the center hub before connecting the tubes to the retaining cable. If this is not done, the roof tube ends can split.

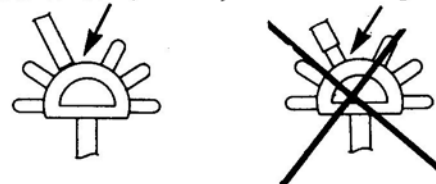

Center hub showing correct roof tube insertion. Tube end is tight against hub.

Incorrect roof tube insertion. Tube must be snug against hub.

4. To install the roof:

Please read carefully prior to installing your new screenhouse roof.

The roof of your new screenhouse has been carefully engineered, fabricated and inspected to look and fit well for many years. It is made from one of the finest outdoor fabrics, consisting of vinyl layers laminated to supportive webbing.

Because the roof is hand-cut and sewn, much like a tailored suit or dress, slight variations in roof section sizes can occur. The roof is a vinyl laminate and is not dimensionally stable, and can, under certain climatic conditions, display a slight relaxing effect.

In the event that water should collect in these depressions during heavy rain, it will be vented by the grommet drains provided in the roof. The small amount of water that may remain should be removed by standing inside the screenhouse and pushing the roof upward and outward.

Do this as soon as practical, should the need arise, as water standing and evaporating under direct sunlight will stain the roof permanently.

There is a predetermined shrink factor allowed for in fabricating the roof. We allow for approximately three (3) seasons of shrinkage when cutting the roof to size, after which there should be no more shrinkage. Since individual roofs vary somewhat, the fit of the roof grommets over the roof tube tips may become tighter in subsequent seasons. Assistance with considerable pull may become necessary to secure the last few grommets. To compensate for this variance, should it occur, and assure a constant good fit, the roof support tubes and tips can be adjusted to shorten the tube length as needed. In the event your roof shows abnormal shrinkage, and is hard or impossible to install, the roof tubes can be shortened by taking a hacksaw and removing 1/2-inch or whatever is required to make it fit properly, from the hub end of each roof tube.

CAUTION: In the event strong winds or storms are forecast, remove roof of the screenhouse.

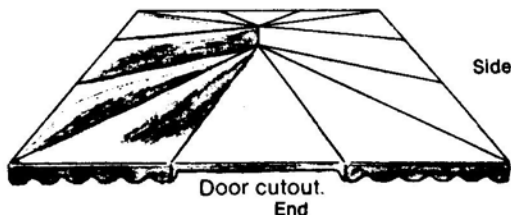

A. Unfold vinyl roof and spread evenly over frame, with seam binding "up" (on outside surface). Throw the roof over the rafters from the side, not from the end, to avoid undue stress on a single roof hub. Position cut-out section over door. Allow time for fabric to relax. Install roof during warm weather, or warm part of day, for easiest installation.

B. Secure the grommets on each side of the door cutout first as follows:

Stand outside the screenhouse and grasp material and grommet with both hands, exposing underside of grommet and patch as shown. Be sure patch is fully spread. Pressing both thumbs against screenhouse frame for leverage, pull edge of vinyl toward you and fasten grommet over tube tip. Next, fasten the 4 corner grommets. Proceed to fasten balance of grommets over tips, working in a clockwise direction.

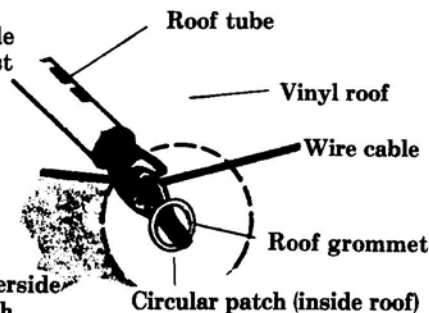

The roof is fabricated to fit snugly to assure a wrinkle-free fit. A strong pull may be necessary to secure last several grommets. Do not use tools; use hands only.

C. After the roof grommets are hooked over the tube tips, the roof should be further secured at the middle of the door assembly with the velcro button and patch provided. Grasp the roof edge near the patch, pull firmly outward and downward, hold down and press inward on the roof to join the patch and button. To remove, pull outward at the very edge of the roof below the fasteners.

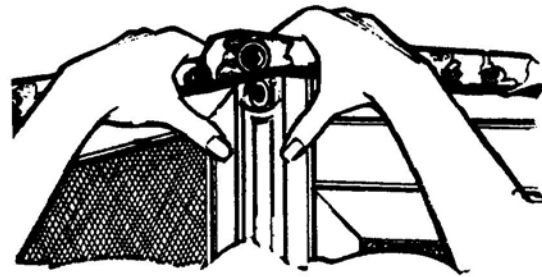

D. It is normal for needle holes to show in the vinyl roof where it is stitched. This is because the vinyl material, unlike cloth fibers, will not contract after being pierced with a sewing needle.

These small holes may leak water when it first begins to rain. However, the Dacron thread used to stitch the vinyl roof has a cotton wrap that expands when it gets wet, to close needle holes and stop leaks. If leak continues, treat with vinyl sealant.

E. Now that the roof is completely mounted, make sure that the top flaps of the flexible vinyl hinges are properly positioned on the inside of the Screenhouse, where they will cover the tube tip/cable joints.

5. To install the latch:

A. On the outside of the door you will see three holes provided for the mounting of the door latch assembly.

B. Assemble push-button spindle and spring into outside handle as shown, making sure small end of spring is inserted into push button.

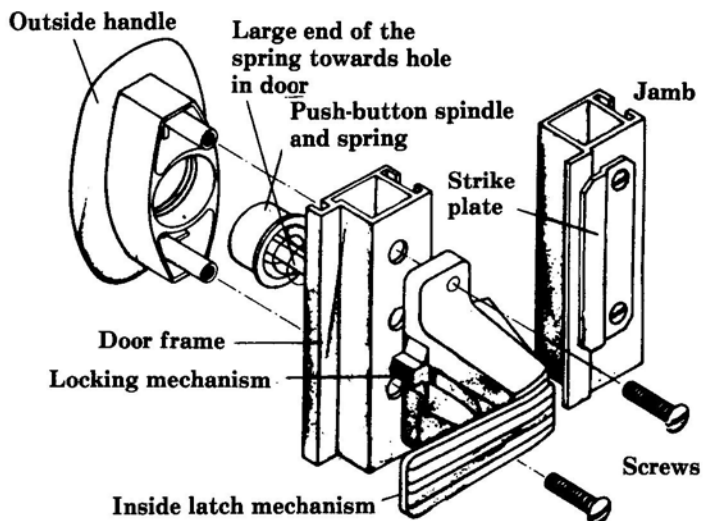

C. Insert assembly through drilled holes from the outside of door. Position inside latch mechanism over holes on inside of door, guiding end of push-button spindle into rectangular slot in latch. Fasten with the two machine screws provided.

D. With door in fully closed position, mount strike plate on jamb and adjust sideways to firmly engage inside latch mechanism.

E. The door can be locked from both the inside (by pushing down the locking mechanism) and from the outside (by inserting a dime into the slot in the push button and turning to the right).

The door, if locked from the inside, can be opened from the outside simply by turning the push button to the left. No key is needed; therefore, no key is provided.

6. To anchor screenhouse:

A. Make certain that all walls are vertical and straight, paying special attention to the door frame.

B. The wire stake loops should be hooked tautly to the stakes. Working from the outside, drive the anchor stakes firmly into the ground at an angle, with the sharp tip of the stake pointing toward the center of the screenhouse.

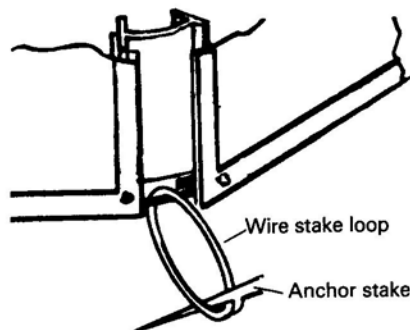

C. HEAVY-DUTY GROUND ANCHOR

Use to give additional stability. Cable and "duck bill" adjustable anchor assembly attaches to center of roof rafter assembly and can be driven into the ground or anchored to the deck using an eye bolt.

(See separate instructions.)

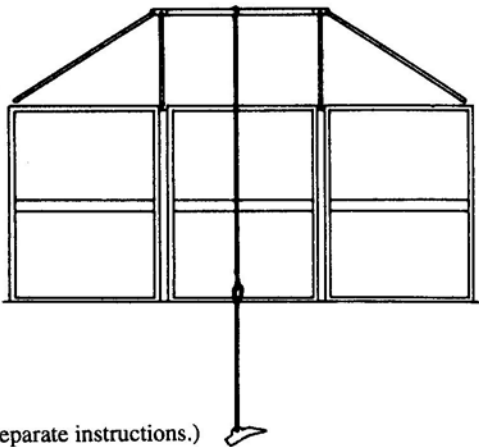

D. **Final door adjustment.** Door may bind when swinging shut due to uneven ground. This door bind may be eliminated by pulling outward on the stake loops on either side of the door, and then restaking tautly.

If this fails due to extremely uneven ground, stand outside the screenhouse facing the door and raise or lower the panel to the right of the door by removing soil or adding shims, as required.

E. Should you desire to anchor your screenhouse to a deck or concrete slab, special anchoring brackets are available (order from parts list). They should be secured with masonry wedge bolts for cement or lag bolts for wood. (bolts not provided)

IMPORTANT NOTE:

It is essential that the screenhouse be properly anchored, as this will add stability to the structure. Therefore, the ground anchor kit provided must be used to increase stability.

7. To store screenhouse:

A. Disassemble your screenhouse by reversing the assembly techniques.

B. Clean the roof before storing by using a mild detergent and warm water, scrubbing with a medium-bristle brush. *Rinse thoroughly.*

C. **IMPORTANT:** Be absolutely certain that the *top fabric and rib webs are thoroughly dry* before folding. Moisture, if trapped in folds, will cause rot and mildew.

D. Store your screenhouse in its carton in a dry, heated place.

8. Accessories

ANCHOR BRACKET KIT
Used to anchor the Screenhouse to a deck or patio. Sold in sets of 12.

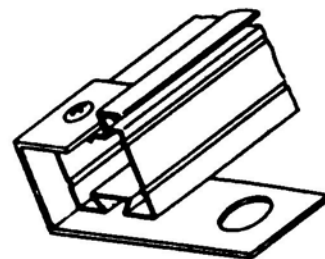

PRIVACY PANELS

Install quickly and easily and offer extra privacy when desired.

One panel encloses upper or lower half of screen wall; sold in sets of four panels.

SNAP-ON THRESHOLD

Stabilizes and protects door frame against kicks and bumps while it helps guard against tripping. Comes in Mill finish; can be painted to match unit. (See parts list for matching touch-up paint.)

OTHER ACCESSORIES CAN BE ORDERED FROM PARTS LIST

- Roof repair kit
- Wall screen repair kit
- Door screen repair kit
- Vinyl sealant

NOTE: This Screenhouse is not designed to withstand heavy winds or snow. Please disassemble your unit during inclement weather and the off season.

9. To order parts:

A combination parts/accessories list and order form is included with your screenhouse. To order parts and accessories, fill it out and send us the entire form. A duplicate form will be returned with your parts order.

All parts are sold by check, money order, or Visa/Mastercard with order. Sorry, no COD orders are accepted.

SCREENHOUSE PARTS DIAGRAM

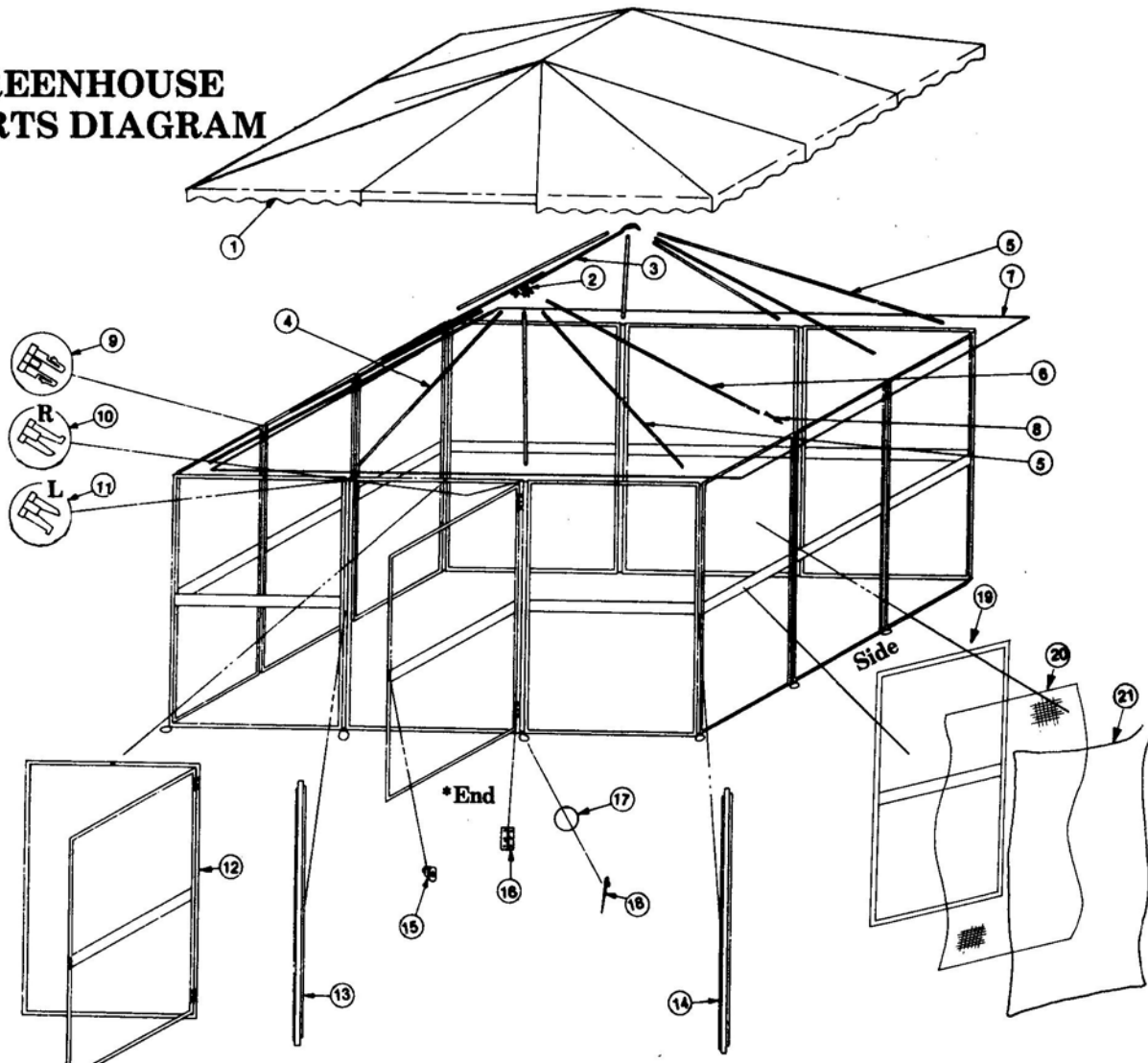

Key No.	Description	Key No.	Description
1	Roof	12	Door assembly (incl.screen)
2	Roof hub	13	Vinyl hinge, wall-to-door
3	Peak roof tube	14	Vinyl hinge, wall-to-wall
4	End roof tube	15	Door latch assembly
5	Corner roof tube	16	Spring-loaded door hinge
6	Side roof tube	17	Wire stake loop
7	Wire cable assembly	18	Anchor stake
8	Tube tip	19	Wall panel assembly (incl.screen)
9	Cable retainer for wall sections	20	Fiberglass screen only
10	Cable retainer 'L' for door section	21	Screen spline only
11	Cable retainer 'R' for door section		

*"End" of screenhouse is defined as the side with the door, and the side opposite that.

CAUTION: This screenhouse is not designed to withstand heavy winds or snow. Please disassemble your unit during inclement weather and the off season.

CAUTION: Though the screenhouse does meet requirements for flame retardancy, keep inflammable materials at a safe distance.

Kay Home Products, 90 McMillen Road, Antioch, IL 60002
 Website: www.kayhomeproducts.com
 U.S. Customer Service: 1-800-626-5296 x522 Canada Customer Service: 1-888-988-8555
 IN ALL CORRESPONDENCE REGARDING THIS PRODUCT ALWAYS MENTION MODEL NO.
 ORDER REPLACEMENT PARTS BY MAIL, WEBSITE, OR PHONE

KAY HOME PRODUCTS

Form No. 30067 Rev 12/04