

2018

Professional Quality Tools

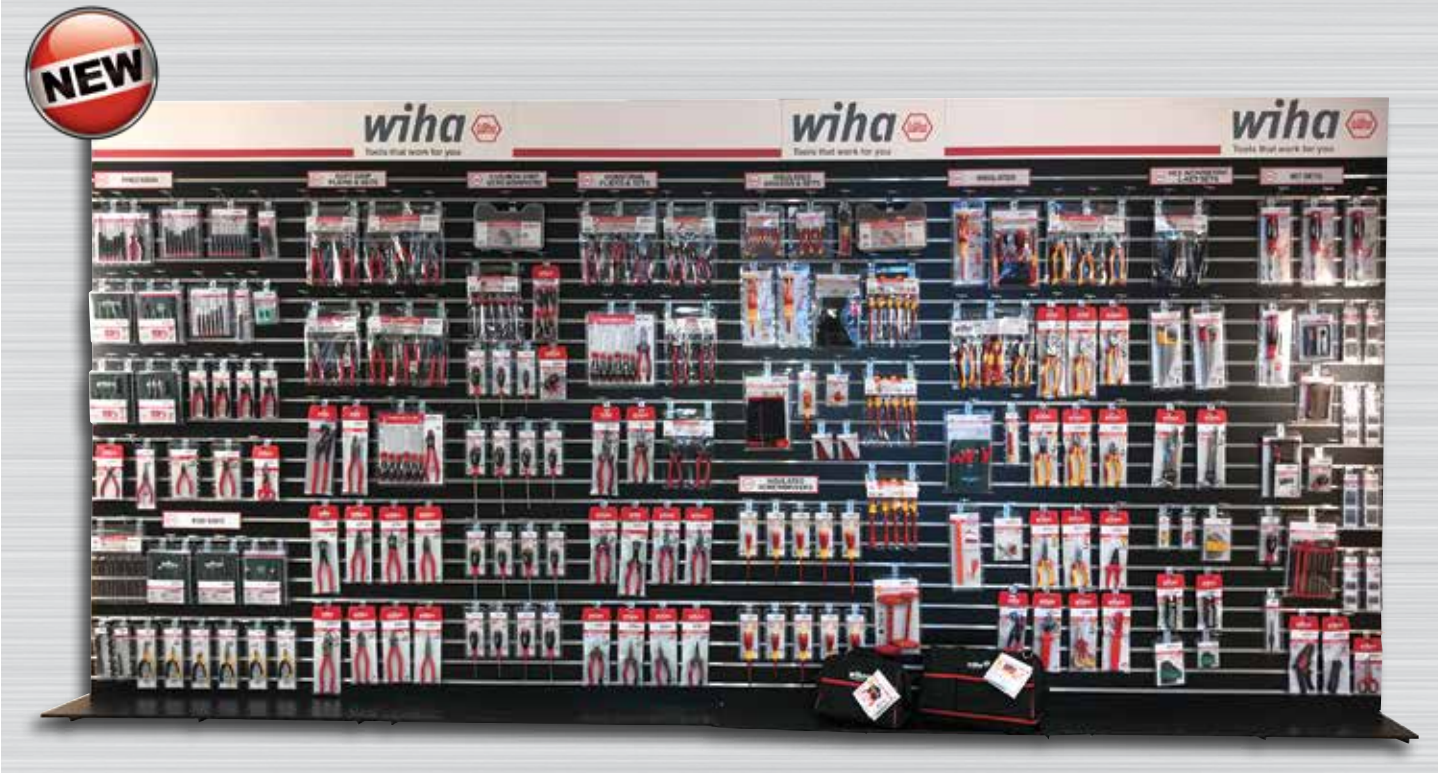





MERCHANDISE PROGRAM



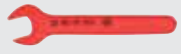



09007
Wiha Merchandise Catalog







Wiha Insulated Tools

Description	Page
 Insulated Open End Spanners	6
 Insulated Adjustable Wrenches	6
 Insulated Knives	6
 Insulated Folding Ruler	21

Wiha Insulated Screwdrivers

Description	Page
 Insulated Hex Inch/Metric T-handles	7
 Insulated TorqueControl Handle with Blade Holder	7
 Voltage Detectors	13
 Insulated Screwdrivers Slotted, Phillips, TORX®, Nut Drivers, Pozidriv®, Square	11-14

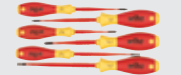
Wiha Insulated SlimLine Tools

Description	Page
 Insulated SlimLine Handles	8
 Insulated SlimLine Blade Sets	8
 Insulated SlimLine Blades	9
 Insulated SlimLine Drivers	10-11
 Insulated SlimLine Driver Sets	10-11
 Insulated Pop-Up SlimLine Sets	8



Wiha Insulated Pico Finish Screwdrivers

Description	Page
 Insulated PicoFinish Sets	9



Wiha Insulated Insert Bit Sets

Description	Page
 Insulated Pop-Up Sets	15



Wiha Insulated Chrome Pliers & Cutters

Description	Page
 Insulated Pliers & Cutters	19
 Insulated Stripping Pliers & Accessories	19
 Insulated Tool Sets	15-18

Wiha Insulated Industrial Pliers/Cutters

Description	Page
 Insulated Industrial Pliers/Cutters	22-23
 Insulated Pliers Sets	21-23







Wiha Strippers

Description	Page
 Ergo Wire Stripper	25
 Cable Stripper	27

Industrial SoftGrip Pliers & Cutters

Description	Page
 Pliers & Cutters	24-25
 Stripping Pliers	25
 Adjustable Pliers	27
 Industrial SoftGrip Tool Sets	26-27

Vinyl Grip Pliers & Cutters

Description	Page
 Pliers & Cutters	28-29
 Stripping Pliers	30
 High Lev. End Cutting Nippers	30
 Adjustable Pliers	30
 Standard Pliers/Cutters Sets Belt Pack Pouch Sets	31-32
 Molded Grip Shears	27

Precision Electronic Pliers/Cutters

	Description	Page
	Electronic Pliers & Cutters	34
	Electronic Stripping Pliers	34

ESD Safe Pliers/Cutters

	Description	Page
	ESD Safe Pliers & Cutters	35-38

ESD Safe Precision Screwdriver Sets

	Description	Page
	Prec. Slotted/Phillips	39
	Prec. Torx/TorxPlus	39
	Prec. Hex Screwdrivers	39
	Prec. Nut Drivers	40
	ESD Safe Micro Bit Sets	40

Wiha Precision Screwdriver Sets

	Description	Page
	Precision Slotted Drivers	41
	Precision Phillips Drivers	41
	Precision Hex Drivers	42
	Precision Ball End Drivers	42
	Precision Torx® Drivers	42
	Precision Pentalobe Drivers	42
	Precision Chip Lifters	41

Wiha Magnetizer/Demagnetizer

	Description	Page
	Magnetizer/Demagnetizer	40

Wiha Power Blade Handle & Sets

	Description	Page
	CentroFix Blade Holder	47
	Power Blade Sets	47

Insert & Power Bit Sets

	Description	Page
	Terminator Impact Bit Sets	44-45
	Security Bits Collector	47
	26inOne Ultra Drivers	48
	Insert Bit Selectors	46
	XSelector/XLSelectors	46
	Stubby Bit Holder Sets	47
	Pop-Up Bit Holder Sets	48,56
	26inOne Ultra Driver Sets	48,57

Wiha SoftFinish® Cushion Grip Drivers Sets

	Description	Page
	SoftFinish® Slotted/Phillips Drivers	49-50
	SoftFinish® Square Drivers	51
	SoftFinish® Pozidriv® Drivers	51
	Torx® Screwdriver Drivers	51

Wiha Hex Inch/Metric & TORX® Tools

	Description	Page
	Hex PocketStar Fold Outs	54
	Hex L-key Sets - Long/Short	52-54
	Hex T-handle Sets	54
	TORX® L-key Sets	55
	TORX® PocketStar Fold Outs	55

Wiha Shop Tools

	Description	Page
	Folding Ruler	52
	Torpedo Level	52

Wiha Starter 4' x 4' Planogram



- 21103 Electricians Switch Cabinet Key
- 10250 Insulated Strippers
- 26197 Precision Slotted & Phillips Screwdrivers 7 Pc Set
- 26190 Precision Slotted/Phillips Drivers 7 Pc Set, w/pliers
- 28394 7 Pc. Insulated Pop-Up-SlimLine Blades Set
- 35844 Insulated SlimLine Square Screwdriver #1 x 100
- 35845 Insulated SlimLine Square Screwdriver #2 x 125
- 30746 Insulated SlimLine Xeno Sl/Ph Driver #1 x 80
- 30747 Insulated SlimLine Xeno Sl/Ph Driver #2 x 100
- 32085 5 Pc. Insulated Precision Slotted/Phillips Drivers
- 32636 Classic BicCut Super Cutters 8" with Power Button
- 32637 Auto Pliers Water Pump
- 32605 Soft Grip Crimping Pliers 7.0"
- 32923 Insulated Industrial Pliers Long Nose With cutters
- 32929 Insulated Industrial High Lev. Diagonal Cutters
- 32938 Insulated High Leverage NE Lineman's Pliers 9.5"
- 35891 Insulated 6 Pcs. Slotted/Phillips/Square Drivers Set
- 36900 Ball End Hex L-Key Mid Length 22Pc IN-MM
- 38050 Insulated Pop-Up 1/4" Insert Bit Set, 14 Pc
- 40010 Magnetizer Demagnetizer
- 66990 ErgoStar MagicRing Ballend L Key 9 Piece Metric
- 66991 ErgoStar MagicRing Ballend L Key 13 Piece Inch
- 74996 34 Pc. Compact Premium Bit Set "Go Box"
- 92004 Insulated Slotted Screwdriver 3.0 x 100mm (1/8")
- 92005 Insulated Slotted Screwdriver 3.5 x 100mm (9/64")
- 92012 Insulated Slotted Screwdriver 4.5 x 150mm (3/16")
- 92024 Insulated Slotted Screwdriver 6.5 x 150mm (1/4")
- 92026 Insulated Slotted Screwdriver 8.0 x 175mm (5/16")
- 92033 Insulated Phillips Screwdriver #1 x 80mm
- 92035 Insulated Phillips Screwdriver #2 x 100mm

Wiha Quality Tools 4' x 8' Planogram

- 21103 Electricians Switch Cabinet Key
- 10250 Insulated Strippers
- 26197 Precision Slotted & Phillips Screwdrivers 7 Pc Set
- 26190 Precision Slotted/Phillips Drivers 7 Pc Set, w/pliers
- 28394 7 Pc. Insulated Pop-Up-SlimLine Blades Set
- 30746 Insulated SlimLine Xeno Sl/Ph Driver #1 x 80
- 30747 Insulated SlimLine Xeno Sl/Ph Driver #2 x 100
- 32046 Insulated SlimLine Slotted Screwdriver 3.5 x 100
- 32052 Insulated SlimLine Slotted Screwdriver 4.5 x 125
- 32055 Insulated SlimLine Slotted Screwdriver 5.5 x 125
- 32085 5 Pc. Insulated Precision Slotted/Phillips Drivers
- 32088 8 Pc. Insulated Precision Slotted/Phillips Drivers
- 32145 Insulated SlimLine Phillips Screwdriver #1 x 80
- 32146 Insulated SlimLine Phillips Screwdriver #2 x 100
- 32292 Insulated SoftFinish® Inch Nut Driver Set, 5 Pc
- 32636 Soft Grip BicCut SuperCut 8" with Power Button
- 32637 Auto Pliers Water Pump
- 32602 Soft Grip Multi Strand Cable Cutters 8.0"
- 32605 Soft Grip Crimping Pliers 7.0"
- 32611 SoftFinish® Multipurpose Electrician Shears 5.75"
- 32621 Soft Grip 8.0" Long Nose Pliers w/Cutters
- 32631 Soft Grip High Leverage NE Lineman's Pliers. 9.5"
- 32652 Soft Grip Heavy Duty Diagonal Cutters 8"
- 32917 Insulated High Leverage with Crimper 9"
- 32923 Insulated Industrial Pliers Long Nose With cutters
- 32929 Insulated Industrial High Lev. Diagonal Cutters
- 32936 Insulated BiCut Super Cut With Power Button 8"
- 32938 Insulated High Leverage NE Lineman's Pliers 9.5"
- 35844 Insulated SlimLine Square Screwdriver No. 1 x 100
- 35845 Insulated SlimLine Square Screwdriver No. 2 x 125
- 35891 Insulated 6 Pcs. Slotted/Phillips/Square Drivers Set
- 36900 Ball End Hex L-Key Mid Length 22Pc IN-MM
- 38048 Stubby bit set with slotted, Phillips and Robertson



- 38050 Insulated Pop-Up 1/4" Insert Bit Set, 14 Pc
- 40010 Magnetizer Demagnetizer
- 56871 WIHA Stripping Pliers
- 66990 ErgoStar MagicRing Ballend L Key 9 Piece Metric
- 66991 ErgoStar MagicRing Ballend L Key 13 Piece Inch
- 36986 Colour Coded Ball End Hex Inch L-Key 13 Pc. Set
- 36987 Colour Coded Ball End Hex Metric L-Key 9 Pc. Set
- 71990 Standard 39 Piece Security Bits Collector Set
- 74996 34 Pc. Compact Premium Bit Set "Go Box"
- 77797 26inOne Ultra Driver Tradesman Set, 27 Piece
- 76098 Security Power Blade 36 Piece Set
- 33490 6 Pc Insulated Hex Inch T-Handle Set
- 33478 Insulated Hex Metric T-Handle Set, 5 Piece
- 61670 Torpedo Level with Magnetic Base 8"
- 61630 Insulated MaxiFlex Folding Ruler Inch & Metric
- 92002 Insulated Slotted Screwdriver 2.5 x 75mm (3/32")
- 92004 Insulated Slotted Screwdriver 3.0 x 100mm (1/8")
- 92005 Insulated Slotted Screwdriver 3.5 x 100mm (9/64")
- 92012 Insulated Slotted Screwdriver 4.5 x 150mm (3/16")
- 92024 Insulated Slotted Screwdriver 6.5 x 150mm (1/4")
- 92026 Insulated Slotted Screwdriver 8.0 x 175mm (5/16")
- 92033 Insulated Phillips Screwdriver #1 x 80mm
- 92035 Insulated Phillips Screwdriver #2 x 100mm
- 92043 Insulated Square Tip Screwdriver #1 x 100mm
- 92045 Insulated Square Tip Screwdriver #2 x 150mm

Wiha Insulated Pro 8' x 4' Planogram



32058	Insulated SlimLine Slotted Screwdriver
32055	Insulated SlimLine Slotted Screwdriver
32052	Insulated SlimLine Slotted Screwdriver
32049	Insulated SlimLine Slotted Screwdriver
32046	Insulated SlimLine Slotted Screwdriver
32092	Insulated Slotted & Phillips 6 Pc. Set
32089	Insulated 9 Pc. Screwdriver Set
32088	Insulated PicoFinish Slot/Ph 8 Pc. Set
30289	SoftFinish 8 Pc. Screwdriver Set
32085	Insulated PicoFinish Slot/Ph 5 Pc. Set
32146	Insulated SlimLine Phillips Screwdriver
32145	Insulated SlimLine Phillips Screwdriver
30747	Insulated SlimLine Xeno Driver #2
30746	Insulated SlimLine Xeno Driver #1
40010	Magnetizer Demagnetizer
32292	Insulated Inch Nut Driver 5 Pc. Set
26197	Precision Slotted/Phillips Set
26190	Precision Slotted/Phillips & Pliers Set
28301	Insulated SlimLine Blade Handle
28302	Insulated Stubby SlimLine Blade Holder
28372	Insulated SlimLine Blade 7 Pc. Set
28373	Insulated SlimLine Blade 7 Pc. Set
28751	Insulated TorqueVario-S Handle
28394	Insulated Pop-Up SlimLine 7 Pc. Set
28792	Insulated TorqueControl 16 Pc. Set
28390	Insulated SlimLine Blade 15 Pc. Set
61630	Insulated MaxiFlex Folding Ruler
32985	Insulated Industrial Pliers/Drivers Set
33490	Insulated T-Handle Hex Inch 6 Pc. Set
20192	Insulated Open End Inch Wrench Set
21103	Switch Cabinet Key
25500	Category III Voltage Detector 110V
32981	Insulated Industrial Pliers/Cutters Set
32917	Insulated Industrial Lineman's Pliers 9"
32938	Insulated Industrial Lineman's Pliers
32956	Insulated Push Button Water Pump Pliers
32635	Soft Grip Pliers Wrench 10.25"
32951	Insulated Proturm Shears 6.3"
15000	Insulated Cable Stripping Knife 50mm
76208	Insulated Adjustable Wrench 8"
10250	Insulated Stripping Pliers
32933	Insulated Industrial Diagonal Cutters
32939	Insulated Industrial H. Leverage Cutters
32936	Insulated Industrial BiCut SuperCut 8.0"
32923	Insulated Industrial Long Nose Pliers 8"
32926	Insulated Industrial Long Nose Pliers
32800	Insulated 80 Pc Set In Rolling Tool Case
32874	Insulated Pliers/Cutters & Drivers Set
32878	Insulated Pliers/Cutters & Drivers Set



Let Wiha help start-up your Planogram!
FREE *Planogram Backer With Every Program Order

* Add Planogram Backer Item #91422 To Your Order

Wiha Insulated Open-End Wrenches

Insulation Test Standards:

Insulation according to ASTM F-1505, EN/IEC 60900, VDE 0680, DIN 7446 & CSA

1000V

Angled 15°

Insulation

High visibility, grip is double coated

Steel

Forged from chrome vanadium, meets - DIN 3110



1000Volt

20192 8 Piece Insulated Inch Open End Wrench Set In Clamshell

Item No.	Hex	OAL Inch	Hex	OAL Inch	Capacity lbs.
20192	5/16	3.9	9/16	5.7	1.59
	3/8	4.1	5/8	6.2	
	7/16	4.6	11/16	6.5	
	1/2	5.5	3/4	7.0	

1000Volt

20093 8 Piece Insulated Metric Open End Wrench Set In Clamshell

Item No.	Hex mm	OAL mm	Hex mm	OAL mm	Capacity lbs.
20093	6.0	97	13.0	137	1.4
	7.0	98	14.0	150	
	8.0	104	17.0	162	
	10.0	107	19.0	178	

Wiha Insulated Electrician's Knives

Insulation Test Standards:

Insulation according to ASTM, EN/IEC, VDE & CSA Specification Individually tested

1000V

Insulation

molded on for permanent bonding

1000V



1000Volt

15003 Insulated Electrician's Cable Stripping Knife, With Insulated Handle

Straight, partly insulated, strong blade. Insulation molded directly on. Cover included. In Pouch

Item No.	Blade mm	OAL mm	OAL Inch	Capacity lbs.
15003	50	230	9.0	.23

1000Volt

15050 Insulated Stripping Knife, With Insulated Handle

Blade tool steel, hardened. Insulation molded directly on. Hooked cutting edge, half-round ground. Cover included. In Pouch

Item No.	Blade mm	OAL mm	OAL Inch	Capacity lbs.
15050	35	222	8.75	.22

Wiha Insulated Adjustable Wrenches

Each tool individually tested to 10,000 Volts & certified to 1000 Volt ac or 1500 Volt dc

1000Volt



76208 Insulated 8" Adjustable Wrench Insulation According to ASTM, EN/IEC, NFPA, CSA and ISO Specification, up to 1000 Volt. Individually Tested. Etched on scale for pre-setting size. Slip guard handle for added protection. In Pouch

Item No.	OAL Inch	OAL mm	Capacity Opening	Capacity lbs.
76208	8.0	200	1"	.7

1000Volt

76210 Insulated 10" Adjustable Wrench Etched on scale for pre-setting size. Slip guard handle for added protection. In Pouch

Item No.	OAL Inch	OAL mm	Capacity Opening	Capacity lbs.
76210	10.0	250	1-1/4"	1.4

1000Volt

76212 Insulated 12" Adjustable Wrench Etched on scale for pre-setting size. Slip guard handle for added protection. In Pouch

Item No.	OAL Inch	OAL mm	Capacity Opening	Capacity lbs.
76212	12.0	300	1-1/2"	1.9

Each tool individually tested to 10,000 volts & rated to 1000 Volt ac or 1500 Volt dc



1000Volt

15000 Insulated Electrician's Cable Stripping Knife, With Insulated Handle, Insulation According To VDE Specification, Up To 1000 Volt. Individually Tested.

Blade tool steel, hardened, molded directly on. Cover included. In Pouch

Item No.	Blade mm	OAL mm	OAL Inch	Capacity lbs.
15000	50	216	8.5	.30

Insulated Hex T-handles

Insulation Test Standards:
Insulation according to EN/IEC, ASTM, VDE, DIN, NFPA70E & CSA specification

Each tool individually tested to 10,000 volts and rated to 1000Volt ac or 1500Volt dc

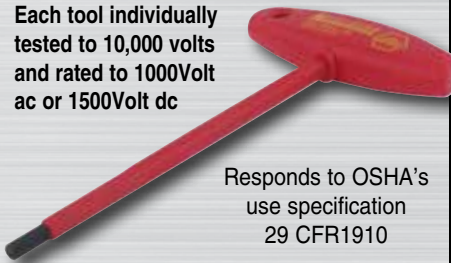

Responds to OSHA's use specification 29 CFR1910

Insulation

Molded directly onto blade for permanent bonding

Blade

CVM tool steel, hardened to average 58/60RC



1000Volt

33490 6 Piece Hex Inch T-handle Set

In Clamshell

Item No.	Inch:	lbs.
33490	5/32, 3/16, 7/32, 1/4, 5/16, 3/8"	1.66

1000Volt



33478 5 Piece Hex Metric T-handle Set

In Clamshell

Item No.	Metric:	lbs.
33478	4.0, 5.0, 6.0, 8.0, 10.0mm	1.20

Wiha Insulated TorqueControl & SlimLine Tool Sets

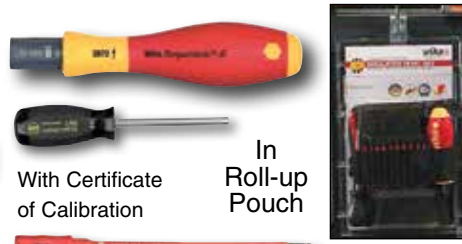

With Certificate of Calibration

In Roll-up Pouch

1000Volt



28792 16 Piece Insulated

TorqueControl Set With SlimLine Blades

Certified to EN ISO 6789, BS EN 26789, ASME B107.14M. Set includes Insulated multi-component adjustable TorqueVario-S handle, 13 SlimLine blades, SlimLine blade holder & Torque adjustment tool. In Clamshell

Item No.	Item	Quantity
28792	SlimLine Slotted: 4.0, 5.5, 6.5mm	3
	SlimLine Phillips: #1, 2	2
	SlimLine Terminal Xeno: #1, 2	2
	SlimLine TORX®: T8, T10, T15, T20	2
	SlimLine Square: #1, 2	2
	28727 - Handle Range 18-62 Inch/lbs.	1
	SlimLine Blade Holder	1



28795 12 Pc. Insulated TorqueControl

Set With SlimLine Blades Certified to EN ISO, BS EN, ASME. Set includes Insulated multi-component adjustable TorqueVario-S Nm handle, SlimLine Blade Holder Handle, 8 SlimLine blades, SlimLine blade holder & Torque adjustment tool. In Clamshell

Item No.	Item	Quantity
28795	SlimLine Slotted: 4.0, 5.5, 6.5mm	3
	SlimLine Phillips: #1, 2	2
	SlimLine Pozidriv®: #1, 2	2
	SlimLine Terminal Xeno SI/Pz: #2	2
	28736 - Handle Range 0.8 - 5.0 Nm	1
	SlimLine Blade Holder Handle	1
	SlimLine Blade Holder	1

With Certificate of Calibration

Wiha Insulated TorqueControl Tools



* Includes Certificate

* Includes SlimLine blade holder #28350

* Requires SlimLine Blades



1000Volt

287 Insulated TorqueVario-S, With Window Scale Insulation up to 1000Volt.

EN/IEC 60900 EN ISO 6789, BS EN 26789, ASME B107.14M & CSA, +/- 6% Accuracy. Ergonomic multi-component handle, light & compact. Handle sizes proportioned to optimize torque range. Audible & perceptible click when torque setting has been attained. In Plastic Tube Holder

Item No.	Range	Inch	lbs.	Increments	mm
28750	5 - 18	.5	18	.5 In/lbs	126-131
28751	10 - 50	2	50	2 In/lbs	133-138
28752	18 - 62	2	62	2 In/lbs	137-142

287 Insulated TorqueVario-S Handle - In Newton Meter Scale

Item No.	Range	Nm	mm	lbs.	pkg.
28740	0.5 - 2.0	131	.75	.75	1
28741	0.8 - 5.0	138	.77	.77	1
28742	2.0 - 7.0	142	.80	.80	1

Each TorqueVario handle has unique serial number & certificate of calibration



In Roll-up Pouch



1000Volt



Certified to EN ISO, BS EN & ASME Specifications

28791 8 Piece Insulated TorqueControl Set With Slotted & Phillips SlimLine Blades

Set includes Insulated multi-component adjustable TorqueVario-S handle, 5 SlimLine blades, SlimLine blade holder & Torque adjustment tool. In Clamshell

Item No.	Item	Quantity
28791	SlimLine Slotted: 3.0, 4.0, 5.5mm	3
	SlimLine Phillips: #1, 2	2
	28726-Handle Range 10-50 Inch/lbs.	1
	SlimLine Blade Holder	1

With Certificate of Calibration

Wiha Insulated Pop-Up SlimLine Sets



Locking blade holder securely holds blades in place for precise fastening



Blades High quality CV steel, through-hardened

1000Volt Rated
10,000 Volt Tested

Certified to VDE, EN ISO, BS EN, ASME specifications



“Apprentice”



28393 Insulated Pop-Up “Apprentice” Blade Holder Set With SlimLine Blades

Insulated cushion grip multi-component handle. Locking bit holder holds SlimLine Blades securely. Convenient rotating cap.

28393 Set includes the following blades:

⚡ Slotted: 3.0, 4.0, 5.5, 6.5mm

⊕ Phillips: #1, #2

⚡ lbs. .38



1000Volt “Residential”



28394 Insulated Pop-Up “Residential” Blade Holder Set With SlimLine Blades

28394 Set includes the following blades:

⚡ Slotted: 3.0, 4.0mm

⊕ Phillips: #1, #2

⊖ Square: #1, #2

⚡ lbs. .38



1000Volt “MRO”



28395 Insulated Pop-Up “MRO” Blade Holder Set With SlimLine Blades

28395 Set includes the following blades:

⚡ Slotted: 3.0, 4.0mm

⊕ Phillips: #1, #2

⊕ Terminal Xeno: #1, #2

⚡ lbs. .38

Wiha Cushion Grip SlimLine Blade Holder



1000Volt

28302 SlimLine Stubby Blade Holder, With Wiha-SoftFinish® Handle. Insulation According to VDE, ASTM, EN/IEC, NFPA70E & CSA, up to 1000 Volt. Wiha-SoftFinish® handle, multi-component, cushion grip.

In Clamshell

Item No.	Slotted	Phillips	Xeno SL/PH	TORX
28302	1/4"	57	2.2	.11 1

1000Volt

28301 SlimLine Blade Holder, W/Wiha-SoftFinish® Handle Insulation According to VDE, ASTM F-1505 and EN/IEC 60900, NFPA70E & CSA, up to 1000 Volt.

Chrome-vanadium steel, through-hardened. Insulation molded directly onto blade. Blade holder, holds blades securely. Wiha-SoftFinish® handle, multi-component, cushion grip. In Clamshell

Item No.	Slotted	Phillips	Xeno SL/PH	TORX
28301	1/4"	50	2.0	160 6.3



1000Volt

28304 SlimLine Blade Holder, W/Wiha-SoftFinish® Handle. Insulation According to VDE, ASTM, EN/IEC, NFPA & CSA, up to 1000 Volt. Wiha-SoftFinish® handle, multi-component, cushion grip. In Clamshell

Item No.	Slotted	Phillips	Xeno SL/PH	TORX
28304	1/4"	114	4.5	.21 1

1000Volt



28390 15 Piece Insulated SlimLine Blade Set

High quality CV steel, through hardened. Cushion grip. Friction hold blade holder, holds blades securely. Up to 33% narrower insulation diameter than standard insulated tools. In Clamshell

Item No.	Slotted	Phillips	Xeno SL/PH	TORX
28390	3.0, 4.0, 5.5, 6.5mm	#1, #2	#1, #2	T8, T10, T15, T20
lbs.	.56			
28301 - SlimLine Blade Holder				



In Roll-up Pouch

1000Volt

28392 12 Piece Insulated SlimLine Blade Set

High quality CV steel, through hardened. Cushion grip. Friction hold blade holder, holds blades securely. SlimLine blades have up to 33% narrower insulation diameter than standard insulated tools.

Item No.	Slotted	Phillips	Xeno SL/PH	TORX
28392	3.0, 5.5mm	#2	#1, #2	T8, T10, T15, T20
lbs.	.52			
28301 - SlimLine Blade Holder				



In Roll-up Pouch
1000Volt

28391 8 Piece Insulated SlimLine Blade Set

High quality CV steel, through hardened. Cushion grip. Friction hold blade holder, holds blades securely. Up to 33% narrower insulation diameter than standard insulated tools.

Item No.	Slotted	Phillips	Xeno SL/PH	TORX
28391	4.0, 6.5	#1, #2	#2	T15, T20
lbs.	.45			
28301 - SlimLine Blade Holder				

Wiha Insulated SlimLine Blades

Integrated Slim Insulation molded directly onto blade

High quality CV steel, through-hardened

Insulation does not exceed screw head diameter

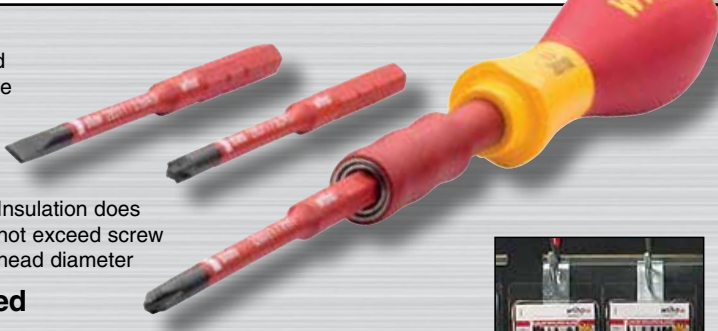

1000Volt Rated
10,000 Volt Tested



Wiha SlimTECHNOLOGY
Achieves blade diameters up to 33% narrower utilizing integrated insulation



slimTECHNOLOGY
33% Narrower



Insulation Test Standards:

Insulation according to EN/IEC 60900, ASTM F-1505, VDE 0682/part 201, DIN 7437, NFPA70E & CSA specification



33% Narrower Insulation Diameter

28372 7 Piece SlimLine Blade Set
High quality CV steel, through hardened, black finish. In Clamshell

Item No.	Slotted: 2.5, 3.5, 5.5mm	
28372	Phillips: #1, #2	lbs. .14
	Square: #1, #2	

28373 7 Piece SlimLine Blade Set
High quality CV steel, through hardened, black finish. In Clamshell

Item No.	Slotted: 2.5, 3.5, 5.5mm	
28373	Phillips: #1, #2	lbs. .14
	Xeno Sl/Ph: #1, #2	



More Info. on Page 56

New Counter Top Displays!



Insulated PicoFinish Precision Screwdrivers

Individually Tested Protective Insulation
1000Volt AC, VDE & GS Tested



Rotating cap for precise turning and control with fingertip



32088 8 Piece Slotted & Phillips PicoFinish Set
High quality CV steel, through hardened, black finish. In Clamshell

1000Volt

Item No.	Slotted: 1.5, 2.0, 2.5, 3.0, 3.5mm	
32088	Phillips: #00, #0, #1	lbs. .35

32085 5 Piece Slotted & Phillips PicoFinish Set
High quality CV steel, through hardened, black finish. In Clamshell

1000Volt

Item No.	Slotted: 1.5, 2.5, 3.5	
32085	Phillips: #0, #1	lbs. .26

Wiha Insulated SlimLine Counter Top Display



⚡ 1000Volt



32079 30 Pc. Insulated SlimLine Slotted & Phillips Screwdriver Display. Meets ASTM, VDE, EN/IEC, NFPA70E & CSA Specs, Tested to 10,000Volts. SlimLine blades have up to 33% narrower insulation diameter than standard insulated tools. High quality CV steel, through hardened.

Item	6 of each:
No.	⚪ Slotted: 3.5, 4.5, 5.5mm
32079	⊕ Phillips: #1, #2

Refills For Insulated SlimLine Display

6 Packs 6 Pack Insulated SlimLine Slotted & Phillips Screwdriver Refills

Item No.	6 Pack Refills
32060	6 Slotted: 3.5mm
32062	6 Slotted: 4.5mm
32063	6 Slotted: 5.5mm
32148	6 Phillips: #1
32149	6 Phillips: #2

Additional Drivers For SlimLine Display

6 Packs 6 Pack Insulated SlimLine Screwdriver Refills

Item No.	6 Pack Refills
32061	6 Slotted: 4.0mm
32064	6 Slotted: 6.5mm
30750	6 Terminal Xeno: #1
30751	6 Terminal Xeno: #2
35847	6 Square: #1
35848	6 Square: #2

Wiha Insulated SlimLine Screwdrivers



Insulation Test Standards:
Insulation according to EN/IEC, ASTM, VDE, DIN 7437, NFPA & CSA specification



Tools individually packaged in a snap closed Clamshell

Integrated Slim Insulation molded directly onto blade



Ideal for jobs where access is limited

⚡ 1000Volt Rated
10,000 Volt Tested

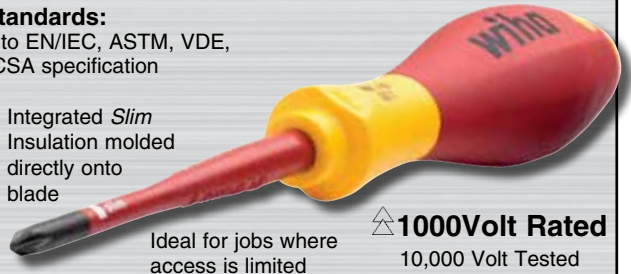

←1.4"→

⚪ 1000Volt

320 Insulated Slotted SlimLine Screwdrivers Insulation According to ASTM F-1505, New VDE Specification and EN/IEC, NFPA70E & CSA, ⚡ up to 1000 Volt. Individually Tested to 10,000Volts. High quality CV steel, through hardened. SlimLine blades have up to 33% narrower insulation diameter than standard insulated tools. Wiha-SoftFinish® handle, multi-component, cushion grip. In Clamshell

High quality CV steel, through hardened. SlimLine blades have up to 33% narrower insulation diameter than standard insulated tools. Wiha-SoftFinish® handle, multi-component, cushion grip. In Clamshell

Item	⚪	⚪	Slim	—	—
No.	mm	Inch	Dia.	mm	mm
32046	3.5	9/64	3.5	100	204
32049	4.0	5/32	4.0	100	211
32052	4.5	3/16	4.5	125	211
32055	5.5	7/32	5.5	125	243
32058	6.5	1/4	6.5	150	268

←1.4"→

⚙ 1000Volt

325 Insulated Security TORX® SlimLine Drivers Insulation According to ASTM, New VDE Specification and EN/IEC, NFPA70E & CSA, ⚡ up to 1000 Volt. Individually Tested to 10,000Volts. In Clamshell

Item	⚙	—	—
No.	Size	mm	mm
32512	T10s	100	204
32513	T15s	100	211
32514	T20s	100	211
32515	T25s	125	243
32517	T27s	125	243
32518	T30s	125	243
32519	T40s	150	268

←1.4"→

⊕ 1000Volt

321 Insulated Phillips SlimLine Screwdrivers Insulation According to ASTM F-1505, New VDE Specification 0682/part 201 and EN/IEC 60900, NFPA70E & CSA, ⚡ up to 1000 Volt. Individually Tested to 10,000Volts. In Clamshell

Item	⊕	Slim	—	—
No.	Size	Dia.	mm	mm
32145	1	4.5	80	204
32146	2	6.0	100	211

←1.4"→

⊕ 1000Volt

307 Insulated Xeno SlimLine Drivers For Terminal Screws Insulation According to ASTM F-1505, New VDE Specification 0682/part 201 and EN/IEC 60900, NFPA70E & CSA, ⚡ up to 1000 Volt. Individually Tested to 10,000Volts. In Clamshell

Item	⊕	Slim	—	—
No.	Size	Dia.	mm	mm
30746	1	4.5	80	191
30747	2	6.0	100	218

←1.4"→

⊖ 1000Volt

358 Insulated Square SlimLine Drivers Insulation According to ASTM, New VDE Specification and EN/IEC, NFPA70E & CSA, ⚡ up to 1000 Volt. Individually Tested to 10,000Volts. In Clamshell

Item	⊖	Slim	—	—
No.	Size	Dia.	mm	mm
35844	1	4.0	100	218
35845	2	4.5	125	243



Wiha Insulated SlimLine Screwdriver Sets

 1000Volt



 Slotted/Phillips

30770 2 Pc. Insulated SlimLine Terminal Block Xeno Slotted/Phillips Screwdrivers. Meets ASTM, VDE, EN/IEC, NFPA70E & CSA Specs. High quality CV steel, through hardened. SlimLine blades have up to 33% narrower insulation diameter than standard insulated tools.

Item No.  Xeno: #1x80mm
30770  Xeno: #2x100mm
 lbs. .34







 1000Volt









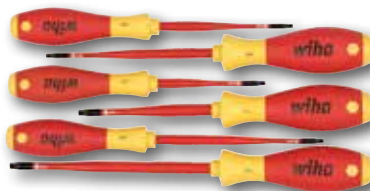

32196 6 Piece Insulated SlimLine Slotted, Phillips & Square Screwdrivers. Insulation According to ASTM F-1505, New VDE Specification 0682/part 201 and EN/IEC 60900, NFPA70E & CSA,  up to 1000 Volt. Individually Tested to 10,000Volts. High quality CV steel, through hardened. SlimLine blades have up to 33% narrower insulation diameter than standard insulated tools. Wiha-SoftFinish® handle, multi-component, cushion grip.

Item No.	 Slotted: 4.5, 6.5mm	 lbs.
32196	 Phillips: #1, #2	1.15
	 Square: #1, #2	1.15



  1000Volt

32596 6 Pc. Insulated SlimLine Security TORX® Screwdrivers. Insulation According to ASTM F-1505, New VDE Specification 0682/part 201 and EN/IEC 60900, NFPA70E & CSA,  up to 1000 Volt. Individually Tested to 10,000Volts. High quality CV steel, through hardened. SlimLine blades have up to 33% narrower insulation diameter than standard insulated tools.

Item No. Security TORX®: T10s, T15s, T20s, T25s, T27s, T30s
32596  lbs. 1.18

Wiha Insulated Metric & Inch Nut Drivers





322 Metric Nut Drivers, With Wiha-SoftFinish® Handle Insulation According to ASTM F-1505, New VDE Specification 0682/part 201 and EN/IEC 60900, NFPA70E & CSA,  up to 1000 Volt. Individually Tested. Blade CVM steel, hardened. Insulation molded directly onto blade. Deep drawn 1" socket. Wiha-SoftFinish® handle, multi-component.

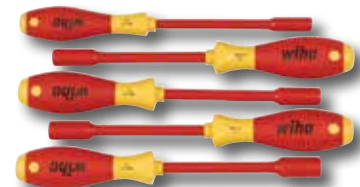



32291 5 Pc. Nut Driver Set - Metric Sizes

Item No.	Metric:	 lbs.
32291	6.0, 7.0, 8.0, 9.0, 10.0mm	1.36

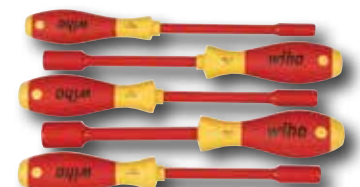



32292 5 Pc. Nut Driver Set - Inch Sizes



Item No.	Inch:	 lbs.
32292	7/32, 1/4, 5/16, 3/8, 1/2"	1.52







 1000Volt

32189 2 Pc. Insulated SlimLine Slotted & Phillips Screwdrivers. Meets ASTM, VDE, EN/IEC, NFPA70E & CSA Specs, Individually Tested. High quality CV steel, through hardened. SlimLine blades have up to 33% narrower insulation diameter than standard insulated tools.

Item No.  Slotted: 4.5x125mm
32189  Phillips: #2x100mm
 lbs. .37

Wiha Slim TECHNOLOGY

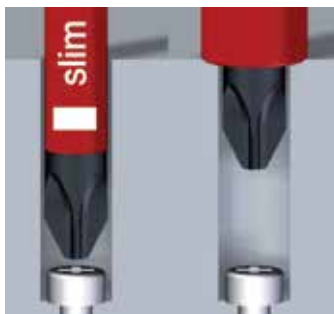
Achieves blade diameters up to 33% narrower utilizing Wiha integrated insulation



Wiha Insulated Screwdrivers with SoftFinish® Cushion Grip Handle

Insulation Test Standards:

Insulation according to EN/IEC 60900, ASTM F-1505, New VDE 0682/part 201, DIN 7437, NFPA70E & CSA

Responds to OSHA's use specification 29 CFR1910



Blade

CVM tool steel, hardened to average 58/60RC

Insulation

Molded directly onto the blade for permanent bonding

SoftFinish® handle

Solid molded core with soft outer cushion grip. 40% more torque than conventional handles



Each tool individually tested to 10,000 volts and rated to 1000 Volt ac or 1500 Volt dc

Each tool individually packaged in a snap closed Clamshell



1000Volt

32105 2 Piece Slotted & Phillips Set

In Pouch

Item Slotted: 5.5

No. Phillips: #2

32105 lbs. .50



1000Volt

33532 2 Piece Slotted & Phillips Set

In Pouch

Item Slotted: 6.0

No. Phillips: #2

33532 lbs. .50

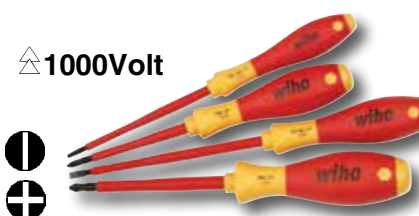

1000Volt

32090 4 Piece Slotted & Phillips Set

In Pouch

Item No. Slotted: 3.5, 4.5

32090 Phillips: #1, 2

lbs. .76

1000Volt

32091 5 Piece Slotted & Phillips Set

In Pouch

Item Slotted: 3.0, 4.5, 6.5

No. Phillips: #1, 2

32091 lbs. 1.31

1000Volt



920 Slotted Screwdriver, With Wiha-SoftFinish® Handle. Insulation According to ASTM F-1505, New VDE Specification 0682/part 201 and EN/IEC 60900, NFPA70E & CSA, up to 1000 Volt. Individually Tested. In Clamshell

Item No.									
	mm	Inch	Inch	mm	Inch	mm	Inch	lbs.	pkg.
92000	2.0	.078	5/64	60	3.0	164	6.5	.05	10
92002	2.5	.098	3/32	75	3.0	179	7.1	.06	10
92004	3.0	.118	1/8	100	4.0	204	8.0	.07	10
92005	3.5	.139	9/64	100	4.0	204	8.0	.07	10
92006	4.0	.157	5/32	100	4.0	211	8.3	.12	10
92008	4.5	.177	3/16	100	4.0	211	8.3	.12	10
92010	4.5	.177	3/16	125	5.0	236	9.3	.12	10
92012	4.5	.177	3/16	150	6.0	261	10.2	.14	10
92014	4.5	.177	3/16	175	7.0	286	11.2	.13	10
92016	4.5	.177	3/16	200	8.0	311	12.3	.15	10
92018	5.5	.216	7/32	125	5.0	243	9.5	.15	10
92020	5.5	.216	7/32	175	7.0	293	11.5	.21	10
92022	6.0	.236	15/64	150	6.0	268	10.6	.21	10
92024	6.5	.255	1/4	150	6.0	268	10.6	.21	10
92026	8.0	.315	5/16	175	7.0	299	11.8	.34	10
92028	10.0	.393	3/8	200	8.0	318	12.5	.39	10



1000Volt

920 Phillips Screwdriver, With Wiha-SoftFinish® Handle. Insulation According to ASTM F-1505, New VDE Specification 0682/part 201 and EN/IEC 60900, NFPA70E & CSA, up to 1000 Volt. Individually Tested. In Clamshell

Item No.							
	Size	mm	Inch	mm	Inch	lbs.	pkg.
92031	0	60	2.4	164	6.5	.06	10
92033	1	80	3.0	191	7.5	.12	10
92035	2	100	4.0	218	8.6	.20	10
92038	3	150	6.0	268	10.6	.34	10
92040	4	200	8.0	318	12.5	.39	10

Wiha Insulated Screwdriver Sets



⚡ 1000Volt



32092 6 Piece Slotted & Phillips Set

In Pouch

Item No. ⚡ Slotted: 3.5, 4.5, 6.5

⊕ Phillips: #1, 2, 3

32092 ⚖ lbs. 1.38



⚡ 1000Volt

35890 6 Pc. Insulated Slotted, Phillips & Square Screwdrivers In Pouch

Item No.	Slotted: 4.5, 6.5mm	⚖
35890	Phillips: #1, 2	lbs.
	Square: #1, 2	.83

Wiha Insulated Square Tip Screwdrivers



⚡ 1000Volt

920 Square Tip Screwdriver, With Wiha-SoftFinish® Handle Insulation According to ASTM, VDE, EN/IEC, NFPA70E and CSA, ⚡ up to 1000 Volt. Individually Tested. Blade high alloy CVM steel, hardened, black finish. In Clamshell

Item	⚡	⊕	⊖	⊗	
No.	Size	mm	Inch	mm	Inch
92043	1	100	4.0	210	8.2
92045	2	150	6.0	268	10.5



⚡ 1000Volt

35891 6 Pc. Insulated Slotted, Phillips & Square Screwdrivers In Pouch

Item No.	Slotted: 3.0, 5.5mm	⚖
35891	Phillips: #1, 2	lbs.
	Square: #1, 2	.83

Insulated Drivers & Voltage Detector Set



⚡ 1000Volt



32089 9 Pc. Slotted, Phillips, Square & Voltage Detector Set In Molded Case

Item Slotted: 3.5, 4.0, 4.5, 5.5mm

No. Phillips: #1, #2

32089 Xeno Sit/Ph: #1, #2

Ins. Single Pole Voltage Detector

⚖ lbs. 1.81

Insulated Single-Pole Voltage Detector



⚡ 1000Volt

25511 Insulated Single-Pole Voltage Detector. 110-250Volts. Insulation According To DIN 57860/6 And DIN VDE 0680-6, GS Safety Tested. Blade CVM steel, hardened, nickel-plated. Insulation molded directly onto blade. Amber LED light. 10,000Volt tested. In Clamshell

Item	⚡	⊕	⊖	⊗
No.	mm	mm	mm	Inch
25511	3.0	65	145	5.7

Insulated Terminal Block Xeno Screwdrivers

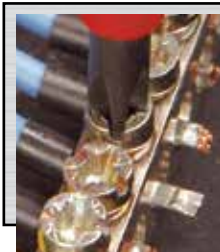

Combination Terminal Block Drivers

Slotted/Phillips
Slotted/Pozidriv®

⚡ 1000Volt



⊕ Slotted/Phillips

920 Combination Terminal Block Xeno Screwdriver, With Wiha SoftFinish® Handle. Insulation According to ASTM F-1505, VDE, 0682/part 201, EN/IEC 60900, NFPA70E & CSA specification. Individually Tested. Blade CVM steel, hardened, black finish. Insulation molded directly onto blade. Wiha-SoftFinish® handle, multi-component, cushion grip. For combination Slotted/Phillips head terminal screws. In Clamshell

Item	⊕	⊖	⊗	
No.	Size	mm	mm	Inch
92075	1	80	191	7.5
92076	2	100	218	8.6



⊗ Slotted/Pozidriv®

920 Combination Terminal Block Xeno Screwdriver, With Wiha SoftFinish® Handle. Insulation According to ASTM F-1505, VDE, 0682/part 201, EN/IEC 60900, NFPA70E & CSA specification. Individually Tested. Blade CVM steel, hardened, black finish. Insulation molded directly onto blade. Wiha-SoftFinish® handle, multi-component, cushion grip. For combination Slotted/Pozidriv® head terminal screws. In Clamshell

Item	⊗	⊖	⊗	
No.	Size	mm	mm	Inch
92077	1	80	191	7.5
92078	2	100	218	8.6

Cat. IV Voltage Detector - Battery Operated



💡 🔊 ⚡ 1000Volt

25505 Battery Operated Voltage Detector

Tests 50-1000 Volts. Category IV, CE IEC 61010-1 With audible sound & light warnings. (Requires 2 AAA batteries). In Pouch

Item	⊕	⊖	⊗	⊗
No.	mm	Inch	lbs.	pkg.
25505	146	5.75	.13	1

Wiha Insulated Master Electrician's Tools

Insulation Test Standards:
Insulation according to EN/IEC 60900, ASTM F-1505, New VDE 0682/part 201, DIN 7437, NFPA70E & CSA



⚠️ 1000Volt

All Tools In Dedicated Positions For Quick Storage & Easy Location Tracking

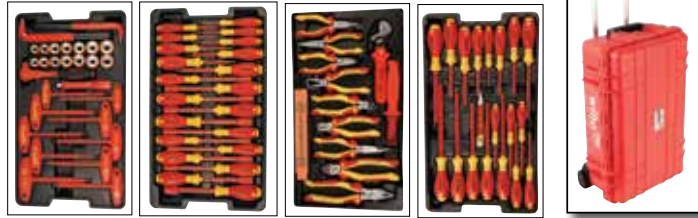

Wiha Insulated Master Electrician's Tools

Insulation Test Standards:
Insulation according to EN/IEC 60900, ASTM F-1505, New VDE 0682/part 201, DIN 7437, NFPA70E & CSA

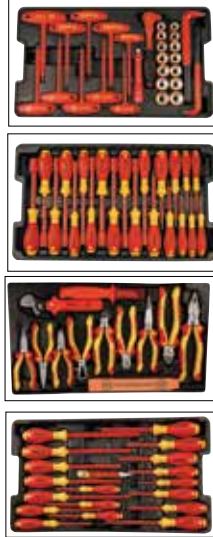

⚠️ 1000Volt

All Tools In Dedicated Positions For Quick Storage & Easy Location Tracking

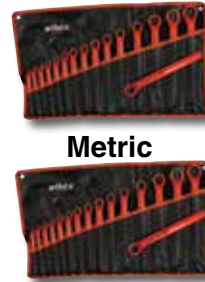

32800 80 PC. Insulated Master Electrician's Tool Set In Rolling Water Tight Traveling Tool Box - 10,000Volt Tested, 1000Volt Rated

Item# 32800	Set Includes:	⚖️ lbs. 33.9
6.3" Long Nose Pliers	6.3" Diagonal Cutters	
8.0" Long Nose Pliers	8.0" High Leverage Cutters	
6.3" Bent Nose Pliers	6.3" Cable Cutters	
6.3" Long Flat Nose Pliers	6.3" Stripping Pliers	
9.0" Combo Pliers/Crimpers	8.0" Adjustable Wrench	
Insulated Inch Sockets: 1/2, 9/16, 5/8, 11/16, 3/4, 13/16, 7/8"	Insulated Slotted: 2.5, 3.0, 3.5, 4.0, 4.5, 5.5, 6.0, 6.5, 8.0, 10.0mm	
Insulated Metric Sockets: 13.0, 14.0, 15.0, 17.0, 19.0, 20.0, 22.0mm	Insulated Phillips: #0, 1, 2, 3	
Insulated Ratchet 3/8" Drive	Insulated Xeno Slotted/Phillips Terminal: #1, 2	
Insulated 4.9" Extension 3/8" Dr.	Insulated Square: #1, 2	
Insulated Inch Nut Drivers: 7/32, 1/4, 5/16, 3/8, 7/16"	Insulated TORX: T6, T7, T8, T9, T10, T15, T20, T25, T30	
Insulated Metric Nut Drivers: 5.0, 5.5, 6.0, 7.0, 8.0, 10.0, 13.0mm	Insulated L-key: 10mm	
Insulated T-handle Inch Hex: 5/32, 3/16, 7/32, 1/4, 5/16, 3/8"	Insulated L-key: 1/2"	
Insulated T-handle Metric Hex: 4.0, 5.0, 6.0, 8.0mm	Insulated Cable Knife: 50mm	
	Insulated Folding Ruler In/MM	
	Cat. III Voltage Detector- Battery Operated	

Use & Care Guide For Insulated Tools:

Store tools to minimize risk of damage to insulation, always wear approved eye protection, inspect insulation prior to each use of any insulated tool. Use insulated tools where the ambient temperature is between -20 to +70° C. Have a qualified safety technician visually inspect insulation on tools annually for safe use.

32801 112 Pc. Insulated Master Electrician's Tool Set In Rolling Water Tight Traveling Tool Box - 10,000Volt Tested, 1000Volt Rated

Item# 32801	Set Includes:	⚖️ lbs. 51.3
6.3" Long Nose Pliers	6.3" Diagonal Cutters	
8.0" Long Nose Pliers	8.0" High Leverage Cutters	
6.3" Bent Nose Pliers	6.3" Cable Cutters	
6.3" Long Flat Nose Pliers	6.3" Stripping Pliers	
9.0" Combo Pliers/Crimpers	8.0" Adjustable Wrench	
Insulated Inch Sockets: 1/2, 9/16, 5/8, 11/16, 3/4, 13/16, 7/8"	Insulated Slotted: 2.5, 3.0, 3.5, 4.0, 4.5, 5.5, 6.0, 6.5, 8.0, 10.0mm	
Insulated Metric Sockets: 13.0, 14.0, 15.0, 17.0, 19.0, 20.0, 22.0mm	Insulated Phillips: #0, 1, 2, 3	
Insulated Ratchet 3/8" Drive	Insulated Xeno Slotted/Phillips Terminal: #1, 2	
Insulated 4.9" Extension 3/8" Dr.	Insulated Square: #1, 2	
Insulated Inch Nut Drivers: 7/32, 1/4, 5/16, 3/8, 7/16"	Insulated TORX: T6, T7, T8, T9, T10, T15, T20, T25, T30	
Insulated Metric Nut Drivers: 5.0, 5.5, 6.0, 7.0, 8.0, 10.0, 13.0mm	Insulated T-handle Inch Hex: 5/32, 3/16, 7/32, 1/4, 5/16, 3/8"	
Insulated L-key: 10mm	Insulated T-handle Metric Hex: 4.0, 5.0, 6.0, 8.0mm	
Insulated L-key: 1/2"	Insulated Inch Deep Offset Ring Wrenches: 1/4, 5/16, 3/8, 7/16, 1/2, 9/16, 5/8, 11/16, 3/4, 25/32, 13/16, 7/8, 15/16, 1, 1-1/16, 1-1/4"	
Insulated Cable Knife: 50mm	Insulated Metric Deep Offset Ring Wrenches: 8.0, 9.0, 10.0, 11.0, 12.0, 13.0, 14.0, 15.0, 17.0, 19.0, 20.0, 22.0, 24.0, 27.0, 30.0, 32.0mm	
Cat. III Voltage Detector- Battery Operated		

Wiha 1000Volt Insulated Tool Sets



50 Pc. BIG SET



1000Volt

32874 50 Pc. Insulated Tool Set
Insulation According to VDE, EN/IEC, ASTM, NFPA70E & CSA, up to 1000 volt. Individually Tested. Pliers drop-forged from special tool steel, individually high frequency induction hardened, chrome/nickel plated, mirror-polished. Cushion Grip Insulated handles. Canvas tool bag.

- Item# 32874 Set Includes:** 5.5 lbs. 19.8
- 6.3" & 8.0" Long Nose Pliers
 - 6.3" Side Cutters
 - 6.3" Combination Pliers
 - 9.0" Combo Pliers/Crimpers
 - 10.0" Water Pump Pliers
 - 8.0" BiCut SuperCut
 - 6.3" Stripping Pliers
 - 8.0" Adjustable Wrench
 - Voltage Detector
- Slotted:** 2.0, 2.5, 3.0, 3.5, 4.0, 4.5, 5.5, 6.0, 6.5, 8.0mm
Phillips: #0, 1, 2, 3 & **Square:** #1, 2
Slt/Ph Terminal: #1, 2
TORX: T8, T9, T10, T15, T20, T25, T27, T30
Hex Inch: 5/32, 3/16, 7/32, 1/4, 5/16, 3/8"
Nut Driver Inch: 7/32, 1/4, 5/16, 3/8, 7/16, 1/2"
50mm Cable Stripping Knife
Insulated Inch/Metric Folding Ruler

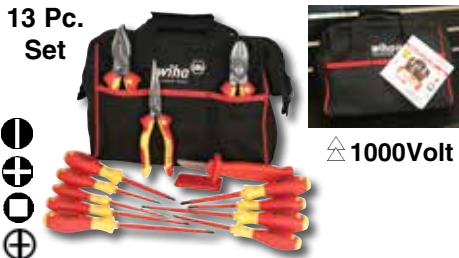

13 Pc. Set



1000Volt

32878 13 Piece Pliers & Screwdriver Set. In canvas tool bag

Item#32878 Set Includes: 5.16 lbs. 5.16

- 8.0" Long Nose
- 8.0" BiCut SuperCut
- 9.0" Combo Pliers/Crimpers
- 50mm Cable Stripping Knife

Insulated Slotted: 3.0, 4.5, 6.0mm
Insulated Phillips: #1, 2
Insulated Square: #1, 2
Insulated Slt/Ph Terminal: #1, 2



1000Volt



32857 7 Pc. Insulated Pliers/Cutters & Screwdriver Set. Insulation According to VDE, EN/IEC, ASTM, NFPA & CSA, up to 1000 volt. Individually Tested. Pliers drop forged of high C70 steel. Durable cutting is achieved through additional inductive hardening to approx. 64HRC. Screwdriver blade high alloy CVM steel, hardened, black finish. Wiha-SoftFinish® handle, multi-component, cushion grip. In Clamshell

Item No.	Insulated Pliers/Cutters
32857	8.0" BiCut SuperCut Pliers
5.5	Insulated Slotted/Phillips Drivers
lbs.	Slotted: 3.5, 4.5, 5.5mm
1.85	Phillips: #0, #1, #2



1000Volt



32856 5 Pc. Insulated Pliers/Cutters & Screwdriver Set. Insulation According to VDE 0682/part 201, EN/IEC 60900, ASTM F-1505, NFPA70E & CSA, up to 1000 volt. Individually Tested. Pliers drop forged of high C70 steel. Durable cutting is achieved through additional inductive hardening to approx. 64HRC. Screwdriver blade high alloy CVM steel, hardened, black finish. Wiha-SoftFinish® handle, multi-component, cushion grip. In Pouch

Item No.	Insulated Pliers/Cutters
32856	8.0" Long Nose Pliers
5.5	6.3" Diagonal Cutters
lbs.	Insulated Slotted/Phillips Drivers
1.81	Slotted: 4.5, 5.5mm
	Phillips: #2



1000Volt

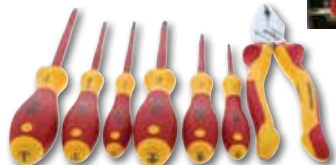

32858 7 Pc. Insulated Pliers/Cutters & Screwdriver Set. Insulation According to VDE, EN/IEC, ASTM, NFPA & CSA, up to 1000 volt. Individually Tested. Pliers drop forged of high C70 steel. Durable cutting is achieved through additional inductive hardening to approx. 64HRC. Screwdriver blade high alloy CVM steel, hardened, black finish. Wiha-SoftFinish® handle, multi-component, cushion grip. In Clamshell

Item No.	Insulated Pliers/Cutters
32858	8.0" Combination Lineman's Pliers
5.5	Insulated Slotted/Phillips Drivers
lbs.	Slotted: 3.5, 4.5, 5.5mm
1.81	Phillips: #0, #1, #2



1000Volt

32865 8 Pc. Insulated Pliers/Cutters & SlimLine Blade Set. Insulation According to VDE, EN/IEC, ASTM, NFPA & CSA, up to 1000 volt. Individually Tested. Pliers drop forged of high C70 steel. Durable cutting is achieved through additional inductive hardening to approx. 64HRC. SlimLine blades high alloy CV steel, through hardened. Blades have up to 33% narrower insulation diameter than standard insulated tools. In Pouch

Item No.	Insulated Pliers/Cutters
32865	8.0" Long Nose Pliers
5.5	Ins. Slotted/Phillips SlimLine Blades
lbs.	Slotted: 3.0, 4.0, 5.5, 6.5mm
.98	Phillips: #1, #2

Insulated Pliers/Cutters & Screwdrivers Sets



32864 3 Pc. Insulated Pliers & Cutters Set Insulation According to VDE, EN/IEC, ASTM, NFPA & CSA, Δ up to 1000 volt. Individually Tested. Pliers drop forged of high C70 steel. Durable cutting is achieved through additional inductive hardening to approx. 64HRC. In Pouch

Item No.	Insulated Pliers & Cutters
32864	6.3" Diagonal Cutters
lbs.	8.0" Long Nose Pliers
1.94	8.0" Combination Lineman's Pliers

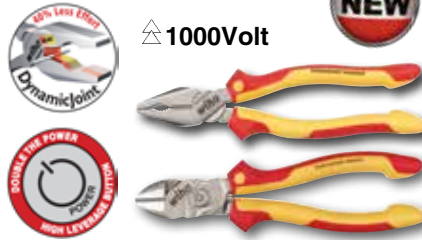

32862 2 Pc. Insulated Pliers & Cutters Set. Insulation According to VDE, EN/IEC, ASTM, NFPA & CSA, Δ up to 1000 volt. Individually Tested. Pliers drop forged of high C70 steel. Durable cutting is achieved through additional inductive hardening to approx. 64HRC. In Pouch

Item No.	Insulated Pliers/Cutters Pliers
32862	8.0" BiCut SuperCut Pliers
lbs. 1.66	8.0" Combination Pliers

Insulated BiCut SuperCut

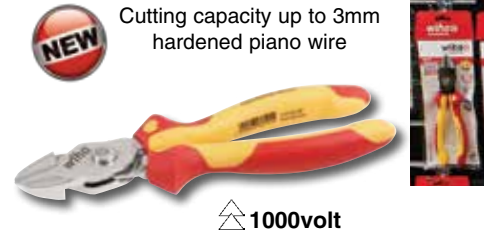

- Cutting capacity up to 3mm hardened piano wire
- Double the power at the press of a button
- BiCut does the job of two pairs of pliers
- Up to 50% less hand strength required for cutting
- Cutting force doubled for extremely hard materials
- Easily switch between two strengths in one-handed operation

32837 Insulated BiCut SuperCut. Insulation According to VDE 0682/part 201, EN/IEC 60900, ASTM F-1505, NFPA70E & CSA, Δ up to 1000 Volt. Individually Tested.

Durable cutting is achieved through additional inductive hardening to approx. 64HRC. Drop forged of high C70 steel. For cutting various materials from soft to extremely hard, such as nails, screws, bolts, wire cables, spring wires, chains, etc. In Pouch

Item	↔	↔	⊞	⊞
No.	mm	Inch	Pkg.	lbs.
32837	200	8.0	1	.78



32863 3 Pc. Insulated Pliers/Cutters & Stripping Pliers Set. Insulation According to VDE 0682/part 201, EN/IEC 60900, ASTM F-1505, NFPA70E & CSA, Δ up to 1000 volt. Individually Tested. Pliers drop forged of high C70 steel. Durable cutting is achieved through additional inductive hardening to approx. 64HRC. In Pouch

Item No.	Insulated Pliers/Cutters & Stripping Pliers
32863	8.0" High Leverage Diagonal Cutters
lbs.	9.0" Lineman's Pliers W/Crimpers
2.21	6.3" Stripping Pliers - Strips 0.81-2.59 / AWG #20-#10

NE Style Lineman's Pliers Set

Insulated Tool meets ASTM, IEC, EN, NFPA & CSA standards
Individually Tested

Knurled striking zone on vinyl grip pliers



32833 2 Piece NE Style Lineman's Pliers Set In Pouch

Item No.	NE Style Lineman's Pliers
32833	9.5" Insulated 1000Volt
	9.5" Vinyl Soft Grip
⊞	lbs. 2.22

Insulated NE Style Lineman's Pliers



32831 Insulated NE Style Lineman's Pliers. Insulation According to EN/IEC, ASTM, NFPA and CSA, Δ up to 1000 Volt. Individually Tested. Long life edge is achieved through additional induction hardening to approx. 64HRC. Special C70 tool steel hardened & tempered. Extra long cutting edge for flat and round cables. Two component soft grip ergonomic handles. In Pouch

Item	↔	↔	⊞	⊞
No.	mm	Inch	Pkg.	wt.
32831	245	9.5	1	1.18

Wiha Insulated Chrome Pliers & Cutters

Tools Meet 10,000 Volt Test Standards Certified to 1000 Volt ac or 1500 Volt dc

Chrome finish for long lasting corrosion protection

Cutters additionally induction hardened

Safety slip guard

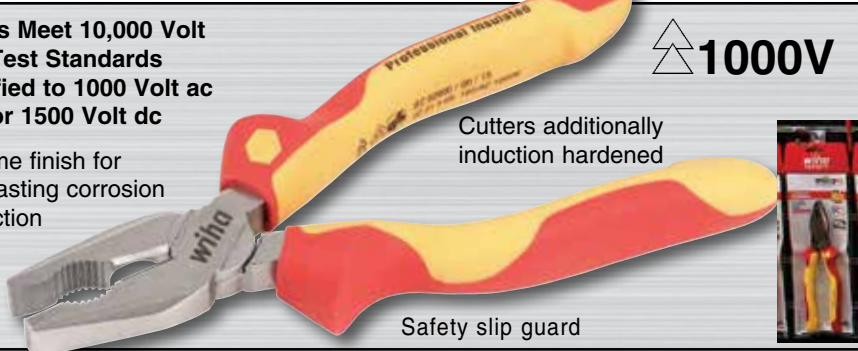

Insulation Standards:
EN/IEC 60900, ASTM F-1505-10, VDE 0682/part 201, NFPA70E and CSA

Each tool individually packaged in a snap closed reusable pouch

Insulated Lineman's Pliers With Crimpers



With lower crimping jaw

32821 Insulated Lineman's Pliers "5-in-1" Professional Design. Insulation According to EN/IEC, ASTM, NFPA & CSA, △ up to 1000Volt. Individually Tested. Deep cut radius conduit jaws for non-slip gripping. Extra long induction hardened precision matched cutting edges. Lower crimping jaw accepts most standard non-insulated electrical connectors. Large head with square anvil surface on each side. Made from premium C70 tool steel forgings. 64HRC cutting edges. In Pouch

Item	Cutting Capacity		
No.	mm	Inch	Copper AWG
32821	225	9.0	#4

Insulated Combination Lineman's Pliers



Serrated jaws

328 Combination Pliers. Insulation According to VDE, EN/IEC, ASTM, NFPA and CSA, △ up to 1000 Volt. Individually Tested. DIN ISO 5746 Extra long cutting edge for flat & round cables. Cutting edges additionally induction hardened to approx. 64HRC. Special C70 tool steel forgings, Chrome finish. Use for gripping and holding as well as cutting soft & hard wires & cables. In Pouch

Item	Cutting Capacity		
No.	mm	Inch	Copper AWG
32814	160	6.3	#10
32816	180	7.0	#9
32818	200	8.0	#8

Insulated Stripping Pliers

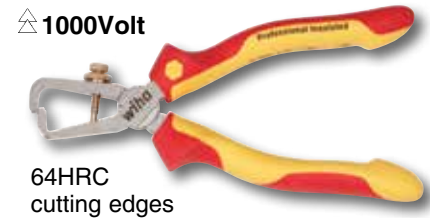

64HRC cutting edges

32860 Stripping Pliers. Insulation According to VDE, EN/IEC, ASTM, NFPA and CSA, △ up to 1000 Volt. Individually Tested. Heavy duty forged with induction hardened cutting edges for even stripping of insulation. Drop-forged from special tool steel, chrome & nickel plated, mirror-polished. Ergo comfort grip with slip guard. Spring & adjusting screw, for stripping up to #8 AWG. In Pouch

Item	Stripping Capacity		
No.	mm	Inch	Copper AWG
32860	160	6.3	#8 - #28

Insulated High Leverage Combination Pliers



Lineman's

32820 High Leverage Combination Pliers. Insulation According to EN/IEC, ASTM, NFPA and CSA, △ up to 1000 Volt. Individually Tested. DIN ISO 5746 Extra long cutting edge for flat and round cables. Cutting edges additionally induction hardened to approx. 64HRC. C70 Special tool steel. Use for gripping, pulling & holding as well as cutting wires and cables ranging in hardness from soft to extremely hard. Two component soft grip ergonomic handles. In Pouch

Item	Cutting Capacity		
No.	mm	Inch	Copper AWG
32820	225	9.0	#4

Insulated Crimping Pliers



32841 Insulated Crimping Pliers. Insulation According to VDE, EN/IEC, ASTM, NFPA & CSA, △ up to 1000 Volt. Individually Tested. Semi-circular profiles for secure connection between & sleeve and conductor. Long life is achieved through additional induction hardening to 64HRC. C70 special tool steel. In Pouch

Item	Cutting Capacity			
No.	mm	Inch	mm ²	AWG
32841	180	7.0	0.25-2.5	6-30

Insulated Serrated Edge Cable Cutters



328 Serrated Edge Cable Cutters. Insulation According to VDE, EN/IEC, ASTM, NFPA and CSA, △ up to 1000 Volt. Individually Tested. Light, clean cutting ground precision cutting edges. Durable cutting is achieved through additional inductive hardening to approx. 64HRC. Special tool steel. For cutting of copper & aluminum cables without crushing. In Pouch

Item	Cutting Capacity			
No.	mm	Inch	Ø	mm ²
32826	160	6.3	16	50
32828	200	8.0	20	60

Insulated Electrician's Diagonal Cutters



⚡ 1000Volt

32861 Diagonal Cutters W/Stripping Holes. Insulation According to VDE 0682/part 201, EN/IEC 60900, ASTM F-1505-10, NFPA70E and CSA, ⚡ up to 1000 Volt. Individually Tested. Drop-forged from special tool steel, cutters additionally induction hardened to approx. 64HRC, chrome-nickel plated, mirror-polished. Ergonomic comfort grip with slip guard. Holes in the cutting edge for stripping copper wire of Ø 1.5 and 2.5. Strips AWG sizes #10 & #14. In Pouch

Item No.	Cutting Capacity		Copper AWG
	mm	Inch	
32861	160	6.3	#10 & #14

Insulated Long Nose Pliers



⚡ 1000Volt

328 Long Nose Pliers With Cutters. Insulation According to VDE 0682/part 201, EN/IEC 60900, ASTM F-1505-10, NFPA70E & CSA, ⚡ up to 1000 Volt. Individually Tested. Drop-forged from C70 special tool steel, cutters additionally induction hardened to approx. 64HRC, chrome-nickel plated, mirror-polished, ergonomic comfort grip with slip guard, serrated gripping surface. In Pouch

Item No.	Cutting Capacity		Copper AWG
	mm	Inch	
32806	160	6.3	#10
32808	200	8.0	#8

Insulated Long Flat Nose Pliers

Two component Soft Grip handles

Extra long head



⚡ 1000Volt

Insulation According to VDE 0682/part 201, EN/IEC 60900, ASTM F-1505-10, NFPA70E & CSA, ⚡ up to 1000 Volt. Individually Tested.

Insulated Diagonal Cutters



⚡ 1000Volt

328 Diagonal Cutters. Insulation According to VDE, EN/IEC, ASTM, NFPA & CSA, ⚡ up to 1000 Volt. Individually Tested. DIN ISO 5749 Low wear lap joint, riveted & able to withstand high levels of load. Lightweight action, clean cutting. Long term cutting is achieved through additional inductive hardening to approx. 64HRC. Special tool steel hardened & tempered. For soft & medium hard wire. 32832 & 32834 for soft, hard & piano wire. In Pouch

Item No.	Cutting Capacity		
	mm	Inch	Copper AWG
32830	140	5.5	#6
32832	160	6.3	#6
32834	180	7.0	#6

Insulated Bent Nose Pliers

Angled 40°



⚡ 1000Volt

328 Bent Nose Pliers With Cutters. Insulation According to VDE 0682/part 201, EN/IEC 60900, ASTM F-1505-10, NFPA70E and CSA, ⚡ up to 1000 Volt. Individually Tested. Drop-forged from C70 special tool steel, cutters additionally induction hardened to approx. 64HRC, chrome-nickel plated, mirror-polished. Ergo comfort grip with slip guard. Serrated gripping surface. In Pouch

Item No.	Cutting Capacity		Copper AWG
	mm	Inch	
32804	200	8.0	#8
32807	160	6.3	#10

32810 Long Flat Nose Pliers. Individually Tested. DIN ISO 5745 Serrated Jaws are induction hardened. Special C70 tool steel forgings, Chrome finish. Use for Gripping and right-angle bending of wires and sheet metal parts. In Pouch

Item No.	Cutting Capacity		Pkg.	lbs.
	mm	Inch		
32810	160	6.3	1	.39

Insulated High Leverage Diagonal Cutters



⚡ 1000Volt

New dynamic joint provides 40% easier cuts and significantly longer tool life

328 High Leverage Diagonal Cutters. Insulation According to VDE 0682/part 201, EN/IEC 60900, ASTM F-1505-10, NFPA70E and CSA, ⚡ up to 1000 Volt. Individually Tested. DIN ISO 5749 Semi-circular. Low wear lap joint, riveted and able to withstand high levels of load. Lightweight action, clean cutting. Long term cutting is achieved through additional inductive hardening to approx. 64HRC. C70 special tool steel hardened & tempered. For soft, hard & piano wire, lay-on joint, optimized power transmission. In Pouch

Item No.	Cutting Capacity		Copper AWG
	mm	Inch	
32835	160	6.3	#6
32836	180	7.0	#5
32838	200	8.0	#4

Each tool individually packaged in a snap closed reusable pouch



Round Nose Pliers



⚡ 1000Volt

32870 Round Nose Pliers. Insulation According to VDE, EN/IEC, ASTM, NFPA and CSA, ⚡ up to 1000 Volt. Individually Tested. Drop-forged from C70 special tool steel, individually induction hardened, chrome and nickel plated, mirror-polished. Ergonomic comfort grip with slip guard. Serrated jaws. In Pouch

Item No.	Cutting Capacity		Pkg.	lbs.
	mm	Inch		
32870	160	6.3	1	.34

Insulated Stripping Pliers



 1000volt

10250 Insulated Stripping Pliers. Insulation According to EN/IEC 60900, DIN ISO 8976, ASTM F-1505 & CSA Specification. Individually Tested.

Wide long head with ridged gripping surface, shears blade and firm wire stripping stations. Wire stripping stations 0.81 / 1.0 / 1.3 / 1.6 / 2.0 / 2.59mm, AWG 20 / 18 / 16 / 14 / 12 / 10.

Item No.	mm	Inch	Ø	AWG
10250	160	6.3"	0.81-2.59	20-10



Protturn Insulated Electrician's Shears



 1000volt

32951 Protturn Insulated Electrician's Shears Insulation meets VDE, ASTM, EN/IEC, CSA, NFPA OSHA Specifications.

Made from stainless 420 grade steel

Item				
No.	mm	Inch	Pkg.	lbs.
32951	160	6.3	1	.22

Insulated Water Pump Pliers

 1000volt

Tools meet ASTM, IEC, VDE, EN, NFPA & CSA standards



32954 Insulated Industrial Water Pump Pliers 10 opening settings provides optimal adjustment to objects being gripped.

Chrome-vanadium tool steel forgings, hardened and tempered.

Item			Capacities	
No.	mm	Inch	Round	Hex
32954	250	10.0	1 3/4	2

Insulated Push Button Water Pump Pliers

 1000volt

Tools meet ASTM, IEC, VDE, EN, NFPA & CSA standards



32956 Insulated Industrial Push Button Water Pump Pliers Extra narrow head for working in small spaces. Rapid and simple push button setting & locking. Finger jam protection for safe operation at all settings.

Item			Capacities	
No.	mm	Inch	Round	Hex
32956	250	10.0	1 3/4	2"

Wiha Insulated Industrial Tool Sets

Tools meet ASTM, IEC, VDE, EN, NFPA & CSA standards

Brushed Finish

In Belt Pack Pouch



 1000volt



32985 7 Pc. Insulated Industrial Pliers/Cutters & Screwdrivers In Clamshell

Item No.	Insulated Pliers/Cutters:
32985	8.0" Combo Pliers, 6.3" Long Nose, 6.3" Diagonal Cutters
lbs.	Insulated Drivers: Phillips: #1, #2
2.30	Slotted: 3.0, 4.5mm

 1000volt



32982 3 Pc. Insulated Industrial Pliers/Cutters & Voltage Detector In Clamshell

Item No.	Insulated Pliers/Cutters & Cat. III Voltage Detector
32982	6.3" Long Pliers, 6.3" Diagonal Cutters
lbs.	Voltage Detector with both light and sound alerts
.98	

Insulated Inch & Metric Folding Ruler



With Wire Puller Slot



Meets VDE, EN/IEC, ASTM, CSA, NFPA standards

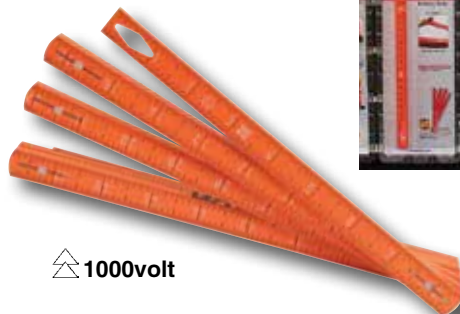

 1000volt

61630 Insulated Inch & Metric Folding Ruler 10,000Volt Tested/1000Volt Rated. Inch & Metric deep embossed scales. 10 folding sections. 30% fiberglass reinforced polyimide. 1/16 & 1mm Increments. In Clamshell

Item					
No.	Meter	Inch	Sections	lbs.	Pkg.
61630	2	78"	10	.31	1



Insulated Industrial Pliers & Cutters

Induction hardened jaws and cutters to 64HRC

Industrial brushed finish



Two component ergo cushion grip handles



New dynamic joint provides 40% easier cuts & significantly longer tool life

Insulated Lineman's Pliers With Crimpers



Long life high performance dynamic 60/40 joint

1000volt

32917 Insulated Industrial Lineman's Pliers "5-In-1" Professional Design Insulation According to EN/IEC, ASTM, NFPA70E & CSA, up to 1000 volt. Individually Tested. In Pouch

Item	↔	↔	Cutting Capacity	
No.	mm	Inch	Copper AWG	
32917	225	9.0	#4	

Insulated High Leverage Diagonal Cutters



1000volt

32939 Insulated Industrial High Leverage Diagonal Cutters. Insulation According to VDE, EN/IEC, ASTM, NFPA70E & CSA, up to 1000 volt. Individually Tested. In Pouch

Item	↔	↔	Cutting Capacity	
No.	mm	Inch	Copper AWG	
32939	200	8.0	#4	

Insulated Industrial NE Style Lineman's Pliers



Knurled Striking Zone



1000volt

32938 Insulated Industrial NE Style Lineman's Pliers. Insulation According to EN/IEC 60900, ASTM F-1505, NFPA70E and CSA, up to 1000 Volt. Individually Tested. Long life edge is achieved through additional induction hardening to approx. 64HRC. Special C70 tool steel hardened & tempered. Extra long cutting edge for flat and round cables. In Pouch

Item	↔	↔	↔	↔
No.	mm	Inch	Pkg.	wt.
32938	245	9.5	1	1.18

Insulated Heavy Duty Cable Cutters



1000volt

32927 Insulated Industrial Serrated Edge Cable Cutters. Insulation According to VDE 0682/part 201, EN/IEC 60900, ASTM F-1505-10, NFPA70E and CSA, up to 1000 Volt. Individually Tested. In Pouch

Item	↔	↔	↔	↔
No.	mm	Inch	Ø	mm ²
32927	200	8.0	20	60

Insulated Long Nose Pliers With Cutters



1000volt

329 Insulated Industrial Long Nose Pliers With Cutters. Insulation According to VDE 0682/part 201, EN/IEC 60900, ASTM F-1505-10, NFPA70E & CSA, up to 1000 volt. Individually Tested. In Pouch

Item	↔	↔	Cutting Capacity	
No.	mm	Inch	Copper AWG	
32926	160	6.3	#10	
32923	200	8.0	#8	

Insulated Diagonal Cutters



Long life high performance dynamic 60/40 joint

1000volt

329 Insulated Industrial Diagonal Cutters. Insulation According to VDE 0682/part 201, EN/IEC 60900, ASTM F-1505-10, NFPA70E & CSA, up to 1000 volt. Individually Tested. DIN ISO 5749 In Pouch

Item	↔	↔	Cutting Capacity	
No.	mm	Inch	Copper AWG	
32933	160	6.3	#6	
32929	200	8.0	#6	

Insulated Combo Pliers With Dynamic Joint

1000volt



Long life high performance dynamic 60/40 joint

32930 Insulated Industrial High Leverage Combination Pliers. Insulation According to EN/IEC 60900, ASTM F-1505-10, NFPA70E & CSA, up to 1000 volt. Individually Tested. DIN ISO 5746 In Pouch

Item	↔	↔	Cutting Capacity	
No.	mm	Inch	Copper AWG	
32930	200	8.0	#4	

1000volt



32945 Insulated Industrial Crimping Pliers. Insulation According to VDE 0682/part 201, EN/IEC 60900, ASTM F-1505-10, NFPA70E and CSA, up to 1000 Volt. Individually Tested. In Pouch

Item	↔	↔	↔	↔
No.	mm	Inch	mm ²	AWG
32945	180	7.0	0.25-2.5	6-30

Insulated Stripping Pliers



 1000volt

32947 Insulated Industrial Stripping Pliers. Insulation According to VDE, DIN 7437, EN/IEC, ASTM, NFPA & CSA, Specs, Individually Tested. In Pouch

Item	↔ ↔ Stripping Capacity		
No.	mm	Inch	Copper AWG
32947	160	6.3	#8 - #28

Insulated BiCut SuperCut

Cutting capacity up to 3mm hardened piano wire



 1000volt

32936 Insulated Industrial BiCut SuperCut. Insulation According to VDE 0682/part 201, EN/IEC 60900, ASTM F-1505, NFPA70E & CSA,  up to 1000 Volt. Individually Tested. For cutting various materials from soft to extremely hard, such as nails, screws, bolts, wire cables, spring wires, chains, etc. In Pouch

Item	↔	↔	▬	↕
No.	mm	Inch	Pkg.	lbs.
32936	200	8.0	1	.78

 1000volt



32977 11 Pc. Pliers & Driver Set. Insulation According to VDE, EN/IEC, ASTM, NFPA70E & CSA,  up to 1000 volt. Individually Tested. In canvas tool bag

Item# 32977 Set Includes:  lbs. 7.5

- 8.0" Linemans Pliers
- 6.3" & 8.0" Long Nose Pliers W/Cutters
- 6.3" Diagonal Cutters
- 8.0" High Leverage Cutters
- Proturm Slotted: 3.0, 4.0, 6.5mm
- Proturm Phillips: #0, #1, #2

Insulated TriCut Strippers & Cutters



 1000volt

32944 Insulated Industrial TriCut Strippers & Cutters. Insulation According to VDE 0682/part 201, EN/IEC 60900, ASTM F-1505-10, NFPA70E and CSA,  up to 1000 Volt. Individually Tested. Cuts cable, strips cable, strips wire leads. Unique 3 in 1 design provides faster combined cutting and stripping. Strips AWG sizes #10 & #14. In Pouch

Item	↔	↔	▬	↕
No.	mm	Inch	AWG	Pkg. wt.
32944	170	6.7	#6	1 .58

Insulated BiCut SuperCut & Screwdriver Set

Tools meet ASTM, IEC, VDE, EN, NFPA & CSA standards



 1000volt

32942 7 Pc. Insulated Industrial BiCut SuperCut & Drivers In Clamshell  lbs. 1.86

Item No. Insulated BiCut SuperCut:

32942 8.0"/200mm BiCut SuperCut

Ins. Drivers: Phillips: #0, #1, #2
Slotted: 3.0, 4.5, 5.5mm

 1000volt



32390 11 Pc. Pliers & Driver Set. Insulation According to VDE, EN/IEC, ASTM, NFPA70E & CSA,  up to 1000 volt. Individually Tested. In canvas tool bag

Item# 32390 Set Includes:  lbs. 7.5

- 8.0" Linemans Pliers
- 6.3" & 8.0" Long Nose Pliers W/Cutters
- 6.3" Diagonal Cutters
- 8.0" High Leverage Cutters
- Proturm Slotted: 3.0, 4.5mm, 6.5mm
- Proturm Phillips: #0, #1, #2

Wiha Insulated Industrial Tool Sets



Tools meet ASTM, IEC, VDE, EN, NFPA & CSA standards

 1000volt



32981 3 Pc. Insulated Industrial Pliers & Cutters In Pouch  lbs. 2.18

Item No. Insulated Pliers & Cutters

32981 8.0" Combo Pliers, 8.0" Long Pliers, 8.0" Diagonal Cutters



 1000volt

Tools meet ASTM, IEC, VDE, EN, NFPA & CSA standards

32983 5 Pc. Insulated Industrial Diagonal Cutters & Drivers In Pouch  lbs. 1.17

Item No. Insulated Diagonal Cutters:

32983 6.3"/160mm Diagonal Cutter

Insulated Divers: Phillips: #1, #2
Slotted: 3.0, 4.5mm

Tools meet ASTM, IEC, VDE, EN, NFPA & CSA standards



 1000volt

32984 6 Pc. Insulated Industrial Combo Pliers & Drivers In Pouch  lbs. 2.06

Item No. Insulated Combination Pliers:

32984 8.0" Combination Pliers
8" Long Nose Pliers

Divers: Slotted: 3.0, 4.5mm
Phillips: #2 • Square: #2

Wiha Industrial SoftGrip Pliers & Cutters

Maximum comfort in daily use, smooth operation & optimum force transmission without uncomfortable pressure points. Natural brushed finish.

**40/60
Dynamic
Joint**



New dynamic joint provides 40% easier cuts & significantly longer tool life

Induction hardened cutters



Slip guards molded into grip

Anti-slip soft dual material handles for safe gripping

Ergonomic shape for maximum user comfort

Two component SoftGrip ergo handle



Industrial SoftGrip Combination Pliers



309 Industrial Combination Pliers

DIN ISO 5746 Extra long cutting edge for flat and round cables. Serrated jaws. Cutting edges additionally induction hardened to approx. 64HRC. Special C70 tool steel. For gripping and holding as well as cutting soft and hard wires & cables. Two component Industrial SoftGrip ergonomic handles. In Pouch

Item No.	Cutting Cap.	
	mm	Inch
30901	160	6.3
30903	180	7.0
30905	200	8.0

Industrial SoftGrip Linemans Crimpers



30912 Industrial Linemans Crimpers

DIN ISO 5746 Extra large head & extra long cutting edges for flat and round cables. Cutting edges additionally induction hardened to approx. 64HRC. Special C70 tool steel. For gripping & holding as well as cutting wires & cables ranging in hardness from soft to extremely hard. Two component SoftGrip ergo handles. In Pouch

Item No.	Cutting Cap.	
	mm	Inch
30912	225	9.0

Industrial SoftGrip Cable Cutters



309 Industrial Cable Cutters DIN ISO 5749

Energy saving & clean cutting cable cutters with specially ground precision cutting edges. Long life cutting edges are achieved through additional induction hardening to approx. 64HRC. C70 special CV tool steel. In Pouch

Item No.	Cutting Capacity	
	mm	Inch
30926	160	6.3
30928	200	8.0

Industrial SoftGrip Diagonal Cutters



309 Industrial Diagonal Cutters DIN ISO 5749

Low wear lap joint, riveted & able to withstand high levels of load. Low force action, clean cutting. Long life cutting edge is achieved with additional induction hardening to approx. 64HRC. Special C70 tool steel forgings hardened & tempered. For soft & medium hard wire. In Pouch

Item No.	Cutting Capacity	
	mm	Inch
30923	140	5.5
30925	160	6.3
30927	180	7.0

Industrial SoftGrip Heavy Duty Combo Pliers



309 Industrial Heavy Duty Combination Pliers DIN ISO 5746

Larger Head & extra long cutting edges for flat and round cables. Serrated jaws. Cutting edges additionally induction hardened to approx. 64HRC. Special C70 tool steel. For gripping & holding as well as cutting wires & cables ranging in hardness from soft to extremely hard. Two component SoftGrip ergo handles. In Pouch

Item No.	Cutting Cap.	
	mm	Inch
30907	200	8.0
30909	225	9.0

Industrial SoftGrip NE Style Lineman's Pliers



Knurled Striking Zone



30940 Industrial NE Style Lineman's Pliers

Long life edge is achieved through additional induction hardening to approx. 64HRC. Special C70 tool steel hardened & tempered. Extra long cutting edge for flat and round cables. Two component SoftGrip handle. In Pouch

Item No.	Cutting Cap.		Pkg.	wt.
	mm	Inch		
30940	245	9.5	1	1.18

Industrial SoftGrip High Leverage Diagonal Cutters



309 Industrial High Leverage Diagonal Cutters DIN ISO 5749

Semi-circular. Low wear lap joint, riveted and able to withstand high levels of load. Low force action, clean cutting. Long life cutting edges are achieved through additional induction hardening to approx. 64HRC. C70 tool steel hardened and tempered. In Pouch

Item No.	Cutting Capacity	
	mm	Inch
30929	160	6.3
30931	180	7.0
30933	200	8.0

Industrial SoftGrip Long Nose Pliers



309 Industrial Long Nose Pliers With Cutting Edge DIN ISO 5745 Long nose pliers. Extra long cutters for flat and round wires. Gripping surfaces serrated in parts. Cutting edges additionally induction hardened to approx. 64HRC. C70 Special tool steel. Two component SoftGrip handle. In Pouch

Item	↔	↔	Cutting Cap.
No.	mm	Inch	AWG
30911	160	6.3	#10
30913	200	8.0	#8

Industrial SoftGrip Flat Nose Pliers



30919 Industrial Long Flat Nose Pliers DIN ISO 5745 Extra long head. Gripping surfaces serrated & induction hardened. C70 Special tool steel. Two component SoftGrip handle. Gripping and right-angled bending of wires and sheet metal parts. In Pouch

Item	↔	↔	↔	↔
No.	mm	Inch	Pkg.	lbs.
30919	160	6.3	1	.43

Industrial SoftGrip Stripping Pliers



For stripping up to #8 AWG

30947 Industrial Stripping Pliers DIN ISO 5743 Heavy duty forged with induction hardened cutting edges for even stripping of insulation. Easy to use adjustment screw allows stripping diameter to be quickly changed. Return spring for effortless use. Special C70 tool steel edges. Stripping Diameter: .019" to .393". In Pouch

Item	↔	↔	Stripping Capacity
No.	mm	Inch	Copper AWG
30947	160	6.3	#8 - #28

Industrial SoftGrip Bent Long Nose Pliers

Angled approx. 40°



309 Industrial Bent Nose Pliers With Cutters DIN ISO 5745 Long nose pliers angled approx. 40°. Extra long cutting edge for flat & round wires. Gripping surfaces serrated in parts. Cutting edges additionally induction hardened to approx. 64HRC. C70 Special tool steel. Two component SoftGrip handle. In Pouch

Item	↔	↔	Cutting Capacity
No.	mm	Inch	Copper AWG
30915	160	6.3	#10
30917	200	8.0	#8

Industrial SoftGrip Long Round Nose Pliers



30921 Industrial Long Round Nose Pliers DIN ISO 5745 Extra long head. Gripping surfaces serrated and induction hardened. C70 Special tool steel. Two component SoftGrip handle. Gripping and bending of wires and sheet metal parts. In Pouch

Item	↔	↔	↔	↔
No.	mm	Inch	Pkg.	lbs.
30921	160	6.3	1	.39

Stripping Pliers



56871 Stripping Pliers Wide long head with ridged gripping surface, shears blade & firm wire stripping stations. With opening spring and locking mechanism. Wire stripping stations 0.81 / 1.0 / 1.3 / 1.6 / 2.0 / 2.59mm, AWG 20 / 18 / 16 / 14 / 12 / 10. In Pouch

Item No.	mm	Inch	Ø	AWG
56871	180	7.0	0.81-2.59	20-10

Industrial SoftGrip Heavy Duty End Nippers



30939 Industrial Heavy Duty End Cutting Nippers Induction hardened cutting edges. Special tool steel. Gripping and right-angled bending of wires and sheet metal parts. Two component SoftGrip handle. In Pouch

Item	↔	↔	↔	↔
No.	mm	Inch	Pkg.	lbs.
30939	200	8.0	1	.74

Industrial SoftGrip BiCut SuperCut

Cutting capacity up to 3mm hardened piano wire



Double the power at the press of a button BiCut does the job of two pairs of pliers Up to 50% less hand strength required for cutting Cutting force doubled for extremely hard materials Switch between 2 strengths in one-handed operation

30936 Industrial SoftGrip BiCut SuperCut For cutting various materials from soft to extremely hard, such as nails, screws, bolts, wire cables, spring wires, chains, etc. In Pouch

Item	↔	↔	↔	↔
No.	mm	Inch	Pkg.	lbs.
30936	200	8.0	1	.78

Ergo Wire Stripper



44219 Compact Ergo Wire Stripper Molded ergo pistol grip design. Top mounted thumb lock. Strip length 7/32 to 1/2"

Item No.	mm	Inch	Strip Range
44219	184	7.25	5-12mm

Industrial SoftGrip Pliers & Cutters 2 Piece Sets



BiCut SuperCut Cutting capacity up to 3mm hardened piano wire

30941 2 Piece Industrial SoftGrip

Pliers & Cutters Set Maximum comfort in daily use, smooth operation and optimum force transmission without uncomfortable pressure points. Cutters additionally induction hardened. Anti-slip soft dual material handles for safe gripping, ergonomic shape for maximum user comfort. In Pouch

Item# 30941 Set Includes:	↔ lbs.
9.0" Lineman's Pliers	1.90
8.0" BiCut SuperCut Pliers	

Double the power at the press of a button
BiCut does the job of two pairs of pliers
Up to 50% less hand strength required for cutting
Cutting force doubled for extremely hard materials
Switch between 2 strengths in one-handed operation



30963 2 Piece Industrial SoftGrip

Pliers & Cutters Set Maximum comfort in daily use, smooth operation and optimum force transmission without uncomfortable pressure points. Cutters additionally induction hardened. Anti-slip soft dual material handles for safe gripping, ergonomic shape for maximum user comfort. In Pouch

Item# 30963 Set Includes:	↔ lbs.
9.5" NE Style Lineman's Pliers	2.06
8.0" BiCut SuperCut Pliers	



30961 2 Piece Industrial SoftGrip

Pliers & Cutters Set Maximum comfort in daily use, smooth operation and optimum force transmission without uncomfortable pressure points. Cutters additionally induction hardened. Anti-slip soft dual material handles for safe gripping, ergonomic shape for maximum user comfort. In Pouch

Item# 30961 Set Includes:	↔ lbs.
9.5" NE Style Lineman's Pliers	1.76
8.0" Long Nose Pliers W/Cutters	

Industrial BiCut SuperCut & Screwdriver Set



30942 7 Pc. Industrial BiCut SuperCut & Screwdriver Set In Pouch

Item No.	BiCut SuperCut:	↔ lbs.
30942	8.0"/200mm BiCut SuperCut	1.86
	Screwdrivers: Phillips: #0, #1, #2	
	Slotted: 3.0, 4.0, 6.5mm	

Industrial SoftGrip Pliers & Cutters Sets



30969 5 Pc. Industrial Pliers/Cutters & Screwdriver Set In Pouch

Item No.	8.0" High Lev. Diagonal Cutters	↔ lbs.
30969	8.0" Long Nose Pliers With Cutters	2.01
	Screwdrivers: Phillips: #2	
	Slotted: 4.5, 5.5mm	



30960 2 Piece Industrial SoftGrip

Pliers & Cutters Set Maximum comfort in daily use, smooth operation and optimum force transmission without uncomfortable pressure points. Cutters additionally induction hardened. Anti-slip soft dual material handles for safe gripping, ergonomic shape for maximum user comfort. In Pouch

Item# 30960 Set Includes:	↔ lbs.
9.5" NE Style Lineman's Pliers	2.01
8.0" Diagonal Cutters	

Industrial SoftGrip Pliers & Cutters 3 Piece Sets



30964 3 Piece Industrial SoftGrip Pliers & Cutters Set Maximum comfort in daily use, smooth operation and optimum force transmission without uncomfortable pressure points. Cutters additionally induction hardened. Anti-slip soft dual material handles for safe gripping, ergonomic shape for maximum user comfort. In Pouch

Item# 30964 Set Includes:	↔ lbs.
8.0" Combination Pliers	2.00
8.0" Long Nose Pliers W/Cutters	
6.3" Diagonal Cutters	

Industrial SoftGrip Pliers & Cutters Sets



30993 3 Piece Industrial SoftGrip Pliers & Cutters Set Maximum comfort in daily use, smooth operation and optimum force transmission without uncomfortable pressure points. Cutters additionally induction hardened. Anti-slip soft dual material handles for safe gripping, ergonomic shape for maximum user comfort. In Clamshell

Item# 30993 Set Includes:	↔ lbs.
30905 Combination Pliers - 8.0"	1.76
30925 Diagonal Cutters - 6.3"	
30911 Long Nose Pliers - 6.3"	

Industrial SoftGrip Push Button Adj. Pliers

With box joint



309 Industrial Slide Lock Adjustable Pliers - Box Joint - With Push Button Setting. DIN ISO 8976 Extra narrow head for working small spaces. Rapid and simple push button setting and locking. Long life achieved through additional induction hardening of jaws to approx. 64HRC. Finger jam protection for safe operation at all settings. CVM tool steel forgings, hardened and tempered. In Pouch

Item	↔	↔	Capacities	
No.	mm	Inch	Round	Hex
30943	250	10.0	1 3/4"	2"

Industrial SoftGrip Standard Adjustable Pliers

With box joint



30937 Industrial Adjustable Pliers DIN ISO 8976 10 opening settings provides optimal adjustment to objects being gripped. Long life achieved through additional induction hardening of jaws to approx. 64HRC. Chrome-vanadium tool steel forgings, hardened and tempered. Two component SoftGrip ergonomic handle. Black finish. In Pouch

Item	↔	↔	Capacities	
No.	mm	Inch	Round	Hex
30937	250	10.0	1 3/4"	2"

Cable Stripper



44216 Cable Stripper - Adjustable Safe stripping of all common round cables from Ø 4mm - 28mm. Ergonomic impact resistant handle makes for perfect handling. Hooked blade and cutter are made of hardened steel. Additional spare blades in the handle. Includes safety cap. In Pouch

↔ lbs.	.25		
Item No.	mm	Inch	Strip Range
44216	165	6.5	4.0-28mm ²

Protturn Stripping Pliers



57872 Protturn Stripping Pliers Wide long head with ridged gripping surface, shears blade and firm wire stripping stations. With opening spring and locking mechanism. Wire stripping stations 0.81 / 1.0 / 1.3 / 1.6 / 2.0 / 2.59mm, AWG 20 / 18 / 16 / 14 / 12 / 10. In Pouch

#57872	mm	Inch	Ø	AWG
	180	7.0	0.81-2.59	20-10

Soft Grip Electrician's shears



32611 SoftGrip Electrician's And Craftsman Shears High alloy carbon steel, hardened, burnished surface. Sturdy model, straight, very robust, micro-toothed cutting. In Pouch

Item				↔	↔
No.	mm	Inch	Pkg.	lbs.	
32611	145	5.75	1	.05	



30965 3 Piece Industrial SoftGrip Pliers & Cutters Set Maximum comfort in daily use, smooth operation and optimum force transmission without uncomfortable pressure points. Cutters additionally induction hardened. Anti-slip soft dual material handles for safe gripping, ergonomic shape for maximum user comfort. In Pouch

Item# 30965 Set Includes:	↔ lbs.
9.0" Lineman's Pliers W/Crimpers	2.00
8.0" Long Nose Pliers W/Cutters	
10.0" Adjustable Pliers	

Soft Grip Pliers & Cutters

Wiha Pliers and Cutters, professional quality at competitive prices. A wide selection covering most applications in which pliers and cutters are required.

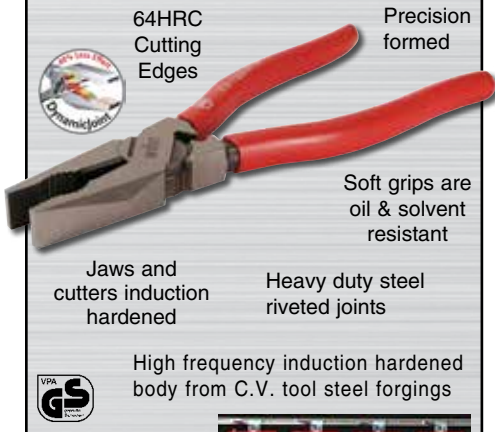

64HRC Cutting Edges

Precision formed

Soft grips are oil & solvent resistant

Jaws and cutters induction hardened

Heavy duty steel riveted joints

High frequency induction hardened body from C.V. tool steel forgings



Each tool individually packaged in a snap closed reusable pouch



Lineman's Pliers With Crimpers

5-in-1 Lineman's Pliers



With Lower Crimping Jaw



32616 Lineman's Pliers "5-in-1"

Professional Design Deep cut radius conduit jaws for non-slip gripping. Extra long induction hardened precision matched 64HRC cutting edges. Lower crimping jaw accepts most standard non-insulated electrical connectors. Large head with square anvil surface on each side. Premium C70 tool steel forgings. In Pouch

Item	↔	↔	Cutting Capacity	
No.	mm	Inch	Copper AWG	
32616	225	9.0	#4	

Combination Pliers With Cutters



326 Combination Pliers With Cutters

DIN ISO 5746 Extra long cutting edge for flat and round cables. Serrated jaws. Cutting edges additionally induction hardened to approx. 64HRC. C70 Special tool steel. For gripping and holding as well as cutting soft & hard wires and cables. In Pouch

Item	↔	↔	Cutting Capacity	
No.	mm	Inch	Copper AWG	
32603	160	6.3	#10	
32606	180	7.0	#9	
32609	200	8.0	#8	

High Leverage Combination Pliers



326 High Leverage Heavy Duty Combination Pliers DIN ISO 5746

Extra long cutting edge for flat and round cables. Serrated jaws. Cutting edges additionally induction hardened to approx. 64HRC. C70 Special tool steel forgings. Use For gripping, pulling & holding as well as cutting soft, hard & piano wires and cables. Soft vinyl grips are oil & solvent resistant. In Pouch

Item	↔	↔	Cutting Capacity	
No.	mm	Inch	Copper AWG	
32612	200	8.0	#4	
32615	225	9.0	#4	

Soft Grip NE Style Lineman's Pliers



Knurled striking zone on vinyl grip pliers



32631 NE Style Lineman's Pliers

Long life edge is achieved through additional induction hardening to approx. 64HRC. Special C70 tool steel hardened & tempered. Extra long cutting edge for flat and round cables. Soft vinyl grips. In Pouch

Item	↔	↔	↔	↔
No.	mm	Inch	Pkg.	wt.
32631	245	9.5	1	1.18

Soft Grip BiCut SuperCut



Cutting capacity up to 3mm hardened piano wire



Double the power at the press of a button BiCut does the job of two pairs of pliers Up to 50% less hand strength required for cutting Cutting force doubled for extremely hard materials Switch between 2 strengths in one-handed operation

32636 Soft Grip BiCut SuperCut

For cutting various materials from soft to extremely hard, such as nails, screws, bolts, wire cables, spring wires, chains, etc. In Pouch

Item	↔	↔	↔	↔
No.	mm	Inch	Pkg.	lbs.
32636	200	8.0	1	.72

Diagonal Cutters



Special C70 tool steel hardened & tempered

326 Diagonal Cutters DIN ISO 5749

Low wear lap joint, riveted & able to withstand high levels of load. Low force cutting action, clean cutting. Long life edge is achieved through additional induction hardening to approx. 64HRC. For soft & medium hard wire. In Pouch

Item	↔	↔	Cutting Capacity	
No.	mm	Inch	Copper AWG	
32638	140	5.5	#6	
32642	160	6.3	#6	
32639	180	7.0	#6	

Flush Cutting Mechanic's Diagonal Cutters

Special C70 tool steel hardened & tempered

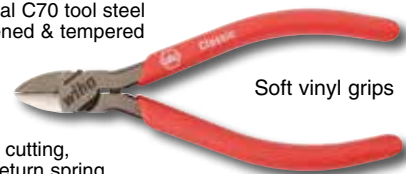

Soft vinyl grips

Flush cutting, with return spring

326 Flush Cutting Mechanic's Diagonal Cutters With Return Spring DIN ISO 5749

Low wear lap joint, riveted and able to withstand high levels of load. Lightweight action, clean cutting. Long life edge is achieved through additional induction hardening to approx. 64HRC. Special C70 tool steel hardened and tempered. For flush cutting soft and semi-hard wires. In Pouch

Item	↔	↔	Cutting Capacity	
No.	mm	Inch	Copper AWG	
32613	127	5.0	#12	

Diagonal Cutters

Flush cutting,
with return spring



DIN ISO 5749

326 Flush Cutting Diagonal Cutters With Return Spring For Cutting Plastic Low wear lap joint, riveted and able to withstand high levels of load. Lightweight action, clean cutting. Long life edge is achieved through additional induction hardening to approx. 64HRC. Special C70 tool steel hardened & tempered. For flush cutting soft and semi-hard wires. In Pouch

Item	↔	↔	↔	↔
No.	mm	Inch	Pkg.	lbs.
32607	127	5.0	1	.14
32614	160	6.3	1	.36

Long Nose Pliers With Return Spring



32617 Long Nose Pliers With Cutters With Return Spring DIN ISO 5745 Long nose pliers. Extra long cutters for flat and round cables. Serrated Jaws. Cutting edges additionally induction hardened to approx. 64HRC. Special C70 tool steel forgings. Soft vinyl grips are oil & solvent resistant. In Pouch

Item	↔	↔	Cutting Capacity	
No.	mm	Inch	Copper AWG	
32617	160	6.3	#12	

Bent Long Nose Pliers With Cutters

Angled 40°



326 Bent Long Nose Pliers With Cutters DIN ISO 5745 Long nose pliers angled 40°. Extra long cutters for flat and round wire. Partially Serrated Jaws. Cutting edges additionally induction hardened to approx. 64HRC. Special C70 tool steel forgings. Soft vinyl grips are oil & solvent resistant. In Pouch

Item	↔	↔	Cutting Capacity	
No.	mm	Inch	Copper AWG	
32623	160	6.3	#10	
32625	200	8.0	#8	

Cable Cutters



Long life is achieved through additional induction hardening of cutting edge to 64HRC

326 Cable Cutters Light, energy-saving & clean cutting with specially ground precision cutting edges. C70 special tool steel hardened & tempered. For cutting of copper & aluminum cables without crushing, also suitable for stripping. Not for steel cable, wires & copper conductors with hard coatings. In Pouch

Item	↔	↔	Cutting Capacity	
No.	mm	Inch	Copper/Aluminum	
32600	160	6.3	16mm	
32602	200	7.9	20mm	

Long Nose Pliers With Cutters



326 Long Nose Pliers With Cutters DIN ISO 5745 Long nose pliers. Extra long cutters for flat and round cables. Serrated Jaws. Cutting edges additionally induction hardened to approx. 64HRC. Special C70 tool steel forgings. Soft vinyl grips are oil & solvent resistant. In Pouch

Item	↔	↔	Cutting Capacity	
No.	mm	Inch	Copper AWG	
32618	160	6.3	#10	
32621	200	8.0	#8	

Long Flat Nose Pliers



32630 Long Flat Nose Pliers DIN ISO 5745 Extra long head. Serrated Jaws are induction hardened. Special C70 tool steel forgings. Use for gripping and right-angled bending of wires and sheet metal parts. Soft vinyl grips are oil & solvent resistant. In Pouch

Item	↔	↔	↔	↔
No.	mm	Inch	Pkg.	lbs.
32630	160	6.3	1	.26

High Leverage Cutters



DIN ISO 5749

326 High Leverage Cutters Semi-circular. Low wear lap joint, riveted & able to withstand high levels of load. Low force action, clean cutting. Long life is achieved through additional induction hardening of cutting edge to 64HRC. C70 special tool steel hardened & tempered. In Pouch

Item	↔	↔	Cutting Capacity	
No.	mm	Inch	Copper AWG	
32646	160	6.3	#6	
32649	180	7.0	#5	
32652	200	8.0	#4	

Long Round Nose Pliers



32633 Long Round Nose Pliers DIN ISO 5745 Extra long head. Serrated Jaws are induction hardened. Special C70 tool steel forgings. Use for gripping and uniform round bending of wires and sheet metal parts. Soft vinyl grips are oil & solvent resistant. In Pouch

Item	↔	↔	↔	↔
No.	mm	Inch	Pkg.	lbs.
32633	160	6.3	1	.25

High Leverage Angle Cutters

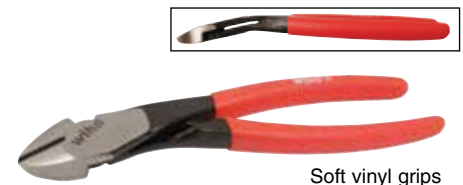

32620 High Leverage Angle Cutters 26° offset cutting angle. Low wear lap joint, riveted and able to withstand high levels of load. Low force action, clean cutting. Long life is achieved through additional induction hardening of cutting edge to 64HRC. C70 special tool steel hardened & tempered.

Item	↔	↔	↔	↔	↔
No.	mm	Inch	Copper AWG	lbs.	Pkg.
32620	200	8.0	#4	.30	1

Wiha Soft Grip Nippers



326 High Leverage End Cutting Nippers

DIN ISO 5749 Low wear lap joint, riveted and able to withstand high levels of load. Low force action, clean cutting. Long life cutting edges are achieved through additional induction hardening to approx. 60 HRC. Special C70 tool steel forgings hardened and tempered. Soft vinyl grips are oil & solvent resistant. In Pouch

Item	Cutting Capacity		
No.	mm	Inch	Copper AWG
32657	160	6.3	#6
32658	180	7.0	#6
32659	200	8.0	#6

Soft Grip Crimping Pliers



326 Crimping Pliers DIN ISO 5743

Semi-circular profiles for secure connection between end sleeve and conductor. Long life is achieved through additional induction hardening to 64HRC. C70 special tool steel hardened & tempered. Soft vinyl grips. In Pouch

Item	Capacities			
No.	mm	Inch	mm ²	AWG
32604	145	5.75	0.25-2.5	14-32
32605	180	7.0	0.25-16	6-32

Stripping Pliers



32645 Stripping Pliers DIN ISO 5744

Heavy duty forged with induction hardened cutting edges for even stripping of insulation. Easy to use adjusting screw allows the stripping diameter to be set. Opening spring for effortless and sensitive handling of pliers. C70 special tool steel. 64HRC cutting edges. For Stripping up to #8 AWG conductor cross-section. Soft vinyl grips. In Pouch

Item	Stripping Capacity		
No.	mm	Inch	Copper Awg#
32645	160	6.3	#8 - #28

Rapid Adjustable - Push Button Pliers



- Fast push button jaw release
- Finger jam protection in all settings

326 Push Button Adjustable Water Pump Pliers - DIN ISO 8976

Extra narrow head for working in restricted spaces. Rapid and simple push button setting and locking. Long durability achieved by additional inductive hardening of gripper jaws to approx. 58-60 HRC. Finger jam protection in all settings ensures safe operation. For gripping and holding pipes & angular profiles such as hex nuts in the installation area. In Pouch

Item	Capacities			
No.	mm	Inch	Round	Hex
32664	180	7.0	1.25	1 1/2
32665	250	10.0	1.75	2.0

Standard Adjustable Pliers



326 Adjustable Pliers - Box Type

DIN ISO 5745 10 different opening sizes provide optimal adjustment to objects being gripped. Long durability achieved through additional induction hardening of jaws to approx. 58-60 HRC. In Pouch

Item	Capacities			
No.	mm	Inch	Round	Hex
32660	180	7.0	1.25	1 1/2
32661	250	10.0	1.75	2.0

Pliers Wrench



32635 Soft Vinyl Grip Pliers Wrench

Smooth jaws for damage free turning on parallel surfaces. Fully adjustable jaws from 1-3/4" round / 46mm Hex. Easy & quick adjustment just slide & close directly on the workpiece. Narrower profile with no button to interfere with turning clearance. Ideal for all applications; gripping, holding, pressing, bending & precise turning. Chrome-vanadium steel, hot forged, hardened & tempered. In Pouch

Item	Capacities		Pkg. wt.	
No.	mm	Inch	Pkg.	wt.
32635	260	10.25	1	1.26

Auto Grip Pliers



32637 Auto Grip Pliers

Just squeeze and pliers automatically adjust to diameter. Induction hardened jaws. Heavy duty box steel joints. Made from high quality CV special tool steel. Soft vinyl grips are oil and solvent resistant. In Pouch

Item	Capacities				lbs.
No.	mm	Inch	Round	Hex	
32637	250	10.0	1.5	1 9/16	.86

Pliers Wrench & Auto Grip Pliers Combo Pack



32619 2 Pc. Combo Pack Pliers Wrench & Auto Pliers Set

Drop-forged from high quality CV special tool steel, individually high frequency induction hardened. Soft vinyl grips, oil & solvent resistant. In Pouch

Item#	32619	Set Includes:	lbs.
		10.0" Auto Pliers 10.0" Pliers Wrench	2.19

Wiha Pliers & Cutters Sets



32648 2 Piece Pliers & Cutters Set

Drop-forged from special tool steel, individually high frequency induction hardened. Precision formed. Soft vinyl grips, oil & solvent resistant.

Item# 32648 Set Includes:  lbs. .78
 32621 - Long Nose Pliers With Cutters - 8.0"
 32642 - Diagonal Cutters - 6.3"



32698 3 Piece Pliers & Cutters Set

Drop-forged from special tool steel, individually high frequency induction hardened. Precision formed. Soft vinyl grips, oil & solvent resistant.

Item# 32698 Set Includes:  lbs. 1.4
 32606 - Combination Pliers 32642 - Diagonal Cutters
 32618 - Long Nose Pliers

Double the power at the press of a button
 BiCut does the job of two pairs of pliers
 Up to 50% less hand strength required for cutting
 Cutting force doubled for extremely hard materials
 Switch between 2 strengths in one-handed operation



32640 2 Piece Soft Grip Pliers & Cutters Set

Maximum comfort in daily use, smooth operation and optimum force transmission without uncomfortable pressure points. Cutters additionally induction hardened. Anti-slip soft dual material handles for safe gripping, ergonomic shape for maximum user comfort. In Pouch

Item# 32640 Set Includes:  lbs.
 9.0" Lineman's Pliers W/Crimpers 1.74
 8.0" BiCut SuperCut Pliers

Soft Grip BiCut SuperCut & Screwdriver Set



32644 7 Pc. Soft Grip BiCut SuperCut & Screwdriver Set

Item No. BiCut SuperCut:  lbs. 1.78
32644 8.0"/200mm BiCut SuperCut
Screwdrivers: Phillips: #0, #1, #2
 Slotted: 3.0, 4.0, 6.5mm



32641 5 Piece Pliers/Cutters & Cushion Grip Screwdriver Set Drop-forged from special tool steel, individually high frequency induction hardened. Precision formed. Soft vinyl grips, oil & solvent resistant. Screwdriver blades CVM tool steel, hardened, hard chromed. SoftFinish cushion grip drivers.

Item Set Includes:  lbs.
No. 8.0" Long Nose Pliers lbs. 1.4
32641 6.3" Diagonal Cutters
Screwdrivers: Phillips: #2
 Slotted: 4.5, 5.5mm

Wiha Soft Grip Belt Pack Pouch Sets

Durable Canvas Belt Pack Pouch



32653 3 Pc. Pliers/Cutters In Belt Pack Pouch Pliers precision formed. Jaws & cutters induction hardened. Soft vinyl grips are oil & solvent resistant.

Item No. Pliers & Cutters
32653 8.0"/200mm High Leverage Cutters
 8.0"/200mm Combo Pliers
 8.0"/200mm Long Nose Pliers
 lbs. 2.02

Durable Canvas Belt Pack Pouch



32655 5 Pc. Pliers/Cutters & Screwdrivers In Belt Pack Pouch Pliers precision formed. Jaws & cutters induction hardened. Soft vinyl grips are oil & solvent resistant. Screwdriver blades CVM tool steel, hardened, hard chromed. SoftFinish cushion grip drivers.

Item No. Pliers & Cutters  lbs. 1.62
32655 6.3"/160mm Diagonal Cutters
 8.0"/200mm Long Nose Pliers
Cushion Grip Screwdrivers:
 Slotted: 3.0, 4.5mm Phillips: #2

Soft Grip Pliers & Cutters



32647	4 Piece Pliers & Cutters Set
Pliers precision formed. Jaws & cutters induction hardened. 10 different opening sizes on water pump pliers to provide optimal adjustment to objects being gripped. Soft vinyl grips are oil & solvent resistant. In Pouch	
Item No.	Pliers & Cutters Set
32647	6.3"/160mm Diagonal Cutters
	8.0"/200mm Combination Pliers
lbs.	8.0"/200mm Long Nose Pliers
2.65	10.0" Water Pump Pliers



32650	3 Piece Pliers & Cutters Set
Pliers precision formed. Jaws & cutters induction hardened. Soft vinyl grips are oil & solvent resistant. In Pouch	
Item No.	Pliers & Cutters Set
32650	6.3"/160mm Diagonal Cutters
	7.0"/180mm Combination Pliers
lbs.	8.0"/200mm Long Nose Pliers
1.56	

Soft Grip Pliers & Cutters 2 Piece Sets



Double the power at the press of a button
BiCut does the job of two pairs of pliers
Up to 50% less hand strength required for cutting
Cutting force doubled for extremely hard materials
Switch between 2 strengths in one-handed operation



Knurled striking zone on vinyl grip pliers



32651	2 Piece Soft Grip Pliers & Cutters Set
Maximum comfort in daily use, smooth operation and optimum force transmission without uncomfortable pressure points. Cutters additionally induction hardened. Anti-slip soft dual material handles for safe gripping, ergonomic shape for maximum user comfort. In Pouch	
Item# 32651	Set Includes:
9.5" NE Style Lineman's Pliers	lbs.
8.0" BiCut SuperCut Pliers	1.92

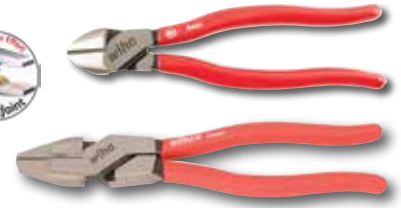

Knurled striking zone on vinyl grip pliers



32675	2 Piece Soft Grip Pliers & Cutters Set
Maximum comfort in daily use, smooth operation and optimum force transmission without uncomfortable pressure points. Cutters additionally induction hardened. Anti-slip soft dual material handles for safe gripping, ergonomic shape for maximum user comfort. In Pouch	
Item# 32675	Set Includes:
9.5" NE Style Lineman's Pliers	lbs.
8.0" High Leverage Cutters	1.92

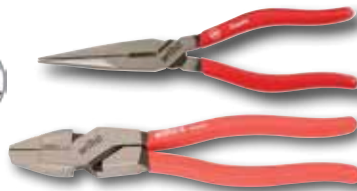

Knurled striking zone on vinyl grip pliers



32699	2 Piece Soft Grip Pliers & Cutters Set
Maximum comfort in daily use, smooth operation and optimum force transmission without uncomfortable pressure points. Cutters additionally induction hardened. Anti-slip soft dual material handles for safe gripping, ergonomic shape for maximum user comfort. In Pouch	
Item# 32699	Set Includes:
9.5" NE Style Lineman's Pliers	lbs.
8.0" Long Nose Pliers	1.60

Wire Stripping Pliers



High Carbon

57810 Wire Stripping Pliers

Pliers nose for working small nuts & pulling wire. Precision ground stripping stations for both solid & Stranded wire. Long, curved cutter requires less force to cut. Holes in the jaw for looping wire. Return spring & opening stop to prevent spring from becoming disengaged. Wire stripping stations 10 - 18 Solid & 12 - 20 Stranded. Screw Cutter 6-32 / 8-32

Item No.	mm	Inch
57810	184	7.25

Wire 5-in-1 Combination Strippers & Crimpers



High Carbon

Crimps Insulated & Non-Insulated

57814 Wire 5-in-1 Combo Strippers & Crimpers

Long head with cushion gripping surface, shears blade and firm wire stripping stations. Hardened tool steel, non-glare black finish. Serrated pliers nose for pulling and looping wire. Curved cutter for improved cutting action, requires less force. Wire stripping stations AWG 10-22. Screw Cutter 4-40 / 5-40 / 6-32 / 8-32 / 10-32 / 10-24.

Item No.	mm	Inch	Strips
57814	210	8.25	10-22

Wire Strippers & Cutters



High Carbon

57818 Wire Strippers & Cutters

Pliers nose for working small nuts & pulling wire. Precision ground stripping stations for both solid & Stranded wire. Long, curved cutter requires less force to cut. Holes in the jaw for looping wire. Return spring & opening stop to prevent spring from becoming disengaged. Wire stripping stations 20 - 30 Solid & 22 - 32 Stranded. Screw Cutter 6-32 / 8-32

Item No.	mm	Inch
57818	184	7.25

Upfront Cutters, Crimper, And Strippers



High Carbon

Crimps Insulated & Non-Insulated

57812 Upfront Cutters/Crimper/Strippers

Curved cutter reduces force required to cut, longer blade length capable of cutting NM-B cable in a single stroke. Hardened tool steel, non-glare black finish. Screw cutter/sizing holes are moved closer to the pivot for more leverage, making it easier to shear screw. Wire stripping stations AWG 10-22. Screw Cutter 4-40 / 6-32 / 8-32 / 10-32 / 10-24

Item No.	mm	Inch	Strips
57812	216	8.5	10-22

Wire Strippers & Cutters



High Carbon

57816 Wire Strippers & Cutters

Serrated pliers nose for pulling and working wire. Precision ground stripping stations. Scissors action cutter. Holes in jaw for looping wire. With return spring. Wire stripping stations 10 - 20 / 0.8 - 2.6mm.

Item No.	mm	Inch	Strips
57816	152	6.0	10-20

Dual NM-B Cable Strippers



High Carbon

57820 Wire Strippers Dual NM-B Cable

Dual cable stripper features serrated pliers nose, wire looping holes, spring return and lock. Staggered cutting blade produces clean, sure cut with 30-50% less effort. Strippers Size 12-2 / 14-2 NM-B. 12-14 AWG. Screw Cutter 6-32 / 8-32.

Item No.	mm	Inch	Strips
57820	197	7.75	12-14

Wiha Precision Electronic Pliers & Cutters

The Comfortable Precision Pliers & Cutters

Electronics pliers with cutting edges are designed especially for cutting soft to medium hard wires.

Light weight design for maximum user comfort in production work



C70 tool steel
HR60 hardness



Lay-on, riveted precision joint

Glare free black finish

Precision ground cutting edges for smooth cuts

Velvet soft ergonomically designed multi component handle

Electronic Diagonal Cutters



56813 Precision Electronic Diagonal Full Flush Cutters With Wire Trapping Spring

Extra narrow, short head for working in particularly restricted spaces. Cutting edge - full flush. With return spring. C70 special tool steel. For absolutely flush cutting of copper wires in difficult to access locations. In clamshell

Item No.	mm	Inch	Cut Capacity
56813	128	5.0	1.0mm/16AWG

Electronic Diagonal Cutters



Full Flush

56818 Precision Electronic Diagonal Cutters, Wide Pointed Head Cutting edge - full flush. With return spring. C70 special tool steel. For an absolutely flush cut of copper wire. In clamshell

Item No.	mm	Inch	Cut Capacity
56818	138	5.5	1.3mm/16AWG

Electronic Diagonal Cutters



56825 Precision Electronic Diagonal Cutters, Wide Shape With Wire Holding Spring

Wide, Pointed head. Cutting edge - full flush. With return spring & fixture for holding ends of wires that have been cut off. C70 special tool steel. For an absolutely flush cut of copper wire. In Clamshell

Item No.	mm	Inch	Cut Capacity
56825	138	5.5	1.3mm/16AWG

Electronic Oblique 48° Cutter



Full Flush

56833 Electronic Oblique 48° Cutter Wide pointed head. Cutting edge - full flush. With cutting edge at 48° for cutting obliquely from above or from the side. C70 special tool steel. For absolutely flush cutting of copper wires in difficult to access locations. In clamshell

Item No.	mm	Inch	Cut Capacity
56833	138	5.5	1.3mm/16AWG

Electronic Diagonal Cutters



Semi Flush

56815 Precision Electronic Diagonal Cutters, Wide Pointed Head Cutting edge - semi flush. With return spring. C70 special tool steel. Universal small diagonal cutter for cutting copper wires. In Clamshell $\frac{1}{2}$ lbs. .23

Item No.	mm	Inch	Cut Capacity	Hard Wire
56815	138	5.5	2.0mm/16AWG	0.8

Electronic Diagonal Cutters



Full Flush

56812 Precision Electronic Diagonal Cutters, Narrow Shape Extra narrow, short head for working in particularly restricted spaces. Cutting edge - full flush. With return spring. C70 special tool steel. For absolutely flush cutting of copper wires in difficult to access locations. In Clamshell $\frac{1}{2}$ lbs. .19

Item No.	mm	Inch	Cut Capacity
56812	118	4.5	0.8mm/16AWG

Narrow Front Cutter/Long Nose Pliers



Full Flush

56830 Electronic Narrow 30° Front Cutter / Long Nose Pliers Extremely narrow, short head for working in particularly restricted spaces. Cutting edge - full flush. Edge at 30° to face end of pliers for cutting obliquely from above or from the side. C70 special tool steel. For absolutely flush cutting of copper wires in difficult to access locations. In clamshell

Item No.	mm	Inch	Cut Capacity
56830	118	4.5	0.6mm/16AWG

Electronic Pointed Pliers



56801 Electronic Short Nose Precision Pliers Narrow, short head. Smooth jaws. Width at tip is only 1.2mm. C70 special tool steel. For holding small components as well as for holding and angling wires. In Clamshell

Item No.	mm	Inch	Pkg.	lbs.
56801	138	5.5	1	.23

Wiha ESD Safe Pliers & Cutters

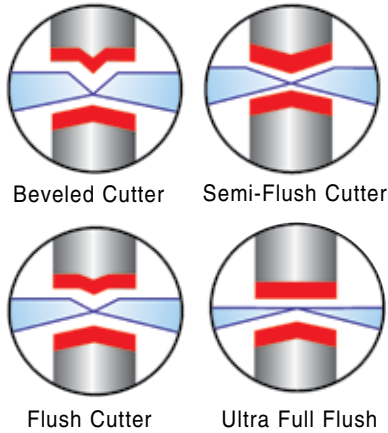

Box joint for longer tool life & endurance, mirror polished finish

ESD standard IEC 61340-5-1

Welded double leaf spring

Two component handle with non-slip soft grip surface

Hardened & annealed high carbon tool steel, induction hardened cutting edges

Protects the hand & reduces manual effort & user fatigue



Precision Cutters Tapered Head

Semi Flush



115mm

9.5mm

7.5mm

In Clamshell

32703 Precision Cutters, Small Tapered Head, Semi Flush Cutters drop-forged for an ideal material structure. Precise aligned cutting edges are additionally induction hardened at a hardness of Approx. 64°HRC. Two component non-slip soft grip handle, ESD Safe Dissipative.  lbs. .19

Item No.	mm	Inch	Copper	Head Wdth
32703	115	4.5	1.0	9.5mm

Precision Cutters Tapered Head

Semi Flush



115mm

9.5mm

7.5mm

In Clamshell

32702 Precision Cutters, Small Tapered Head With Hollow Ground Back, Semi Flush Cutters drop-forged for an ideal material structure. Precise aligned cutting edges are additionally induction hardened at a hardness of Approx. 64°HRC. Two component non-slip soft grip handle, ESD Safe Dissipative.

Item No.	mm	Inch	Copper	Head Wdth
32702	115	4.5	1.0	9.5mm

Precision Cutters Wide Tapered Head

Bevel



115mm

11.5mm

7.5mm

In Clamshell

32706 Precision Cutters, Wide Tapered Head, Bevel Cutters drop-forged for an ideal material structure. Precise aligned cutting edges are additionally induction hardened at a hardness of Approx. 64°HRC. Two component non-slip soft grip handle, ESD Safe Dissipative.

Item No.	mm	Inch	Copper	Head Wdth
32706	115	4.5	1.4	11.0mm

Precision Cutters Tapered Head

Flush



115mm

9.5mm

6.0mm

In Clamshell

32705 Precision Cutters, Small Tapered Head, Flush Cutters drop-forged for an ideal material structure. Precise aligned cutting edges are additionally induction hardened at a hardness of Approx. 64°HRC. Two component non-slip soft grip handle, ESD Safe Dissipative.

Item No.	mm	Inch	Copper	Head Wdth
32705	115	4.5	1.0	9.5mm

Precision Cutters Tapered Head

Flush



115mm

9.5mm

6.0mm

In Clamshell

32704 Precision Cutters, Small Tapered Head With Hollow Ground Back, Flush Cutters drop-forged for an ideal material structure. Precise aligned cutting edges are additionally induction hardened at a hardness of Approx. 64°HRC. ESD Safe Dissipative.

Item No.	mm	Inch	Copper	Head Wdth
32704	115	4.5	1.0	9.5mm

Precision Cutters Wide Tapered Head

Flush



115mm

11.0mm

7.5mm

In Clamshell

32708 Precision Cutters, Wide Tapered Head, Flush Cutters drop-forged for an ideal material structure. Precise aligned cutting edges are additionally induction hardened at a hardness of Approx. 64°HRC. Two component non-slip soft grip handle, ESD Safe Dissipative.

Item No.	mm	Inch	Copper	Head Wdth
32708	115	4.5	1.2	11.0mm

Precision Cutters Wide Tapered Head

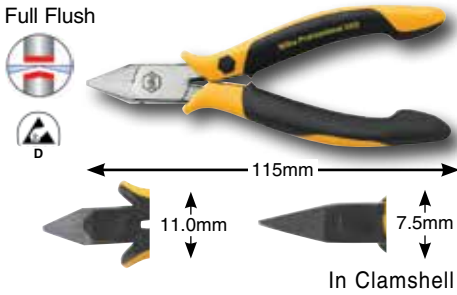

32710 Precision Cutters, Wide Tapered Head, Full Flush Cutters drop-forged for an ideal material structure. Precise aligned cutting edges are additionally induction hardened at a hardness of Approx. 64°HRC. Two component non-slip soft grip handle, ESD Safe Dissipative.

Item No.	mm	Inch	Copper	Head Wdth
32710	115	4.5	1.0	11.0mm

Precision Cutters Slim Oval Form



32714 Precision Cutters, Slim Oval Head, Full Flush Cutters drop-forged for an ideal material structure. Precise aligned cutting edges are additionally induction hardened at a hardness of Approx. 64°HRC. Two component non-slip soft grip handle, ESD Safe Dissipative.

Item No.	mm	Inch	Copper	Head Wdth
32714	115	4.5	1.0	10.0mm

Precision Cutters Wide Oval Form And Carbide Edge

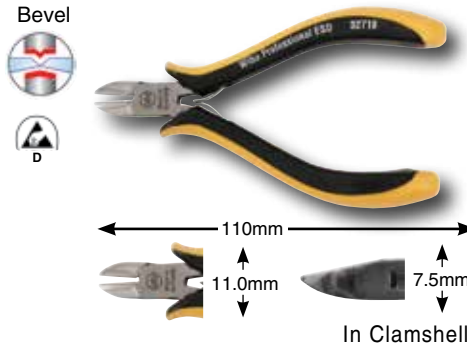

32718 Precision Cutters, Wide Oval Head Carbide Cutting Edges, Bevel Cutters drop-forged for an ideal material structure. Precise aligned carbide cutting edge. ESD Safe Dissipative.

Item No.	mm	Inch	Copper	Head Wdth
32718	110	4 3/8	1.6	11.0mm

Precision Cutters Wide Tapered Head



32711 Precision Cutters, Wide Tapered Head With Wire Trapping Device, Flush Cutters drop-forged for an ideal material structure. Precise aligned cutting edges are additionally induction hardened at a hardness of Approx. 64°HRC. ESD Safe Dissipative.

Item No.	mm	Inch	Copper	Head Wdth
32711	115	4.5	1.2	11.0mm

Precision Cutters Wide Oval Form



32716 Precision Cutters, Wide Oval Head, Bevel Cutters drop-forged for an ideal material structure. Precise aligned cutting edges are additionally induction hardened at a hardness of Approx. 64°HRC. Two component non-slip soft grip handle, ESD Safe Dissipative.

Item No.	mm	Inch	Copper	Head Wdth
32716	115	4.5	1.4	11.0mm

Precision Cutters Wide Oval Form

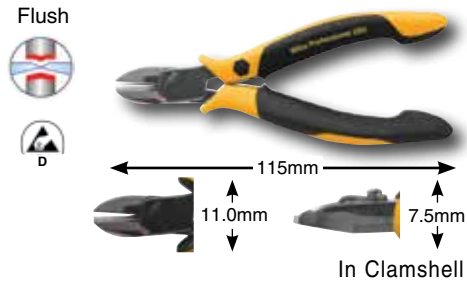

32721 Precision Cutters, Wide Oval Head With Wire Trapping Device, Flush Cutters drop-forged for an ideal material structure. Precise aligned cutting edges are additionally induction hardened at a hardness of Approx. 64°HRC. Two component non-slip soft grip handle, ESD Safe Dissipative.

Item No.	mm	Inch	Copper	Head Wdth
32721	115	4.5	1.2	11.0mm

Precision Cutters Slim Oval Form



32712 Precision Cutters, Slim Oval Head, Flush Cutters drop-forged for an ideal material structure. Precise aligned cutting edges are additionally induction hardened at a hardness of Approx. 64°HRC. Two component non-slip soft grip handle, ESD Safe Dissipative.

Item No.	mm	Inch	Copper	Head Wdth
32712	115	4.5	1.0	10.5mm

Precision Cutters Wide Oval Form



32720 Precision Cutters, Wide Oval Head, Flush Cutters drop-forged for an ideal material structure. Precise aligned cutting edges are additionally induction hardened at a hardness of Approx. 64°HRC. Two component non-slip soft grip handle, ESD Safe Dissipative.

Item No.	mm	Inch	Copper	Head Wdth
32720	115	4.5	1.2	11.0mm



Cutter Styles

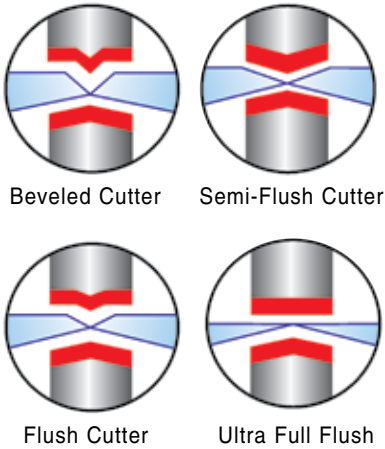

Beveled Cutter

Semi-Flush Cutter

Flush Cutter

Ultra Full Flush



All ESD Safe Pliers Packaged In a Clamshell

Oblique Angled Cutters



32724 Oblique Angled Cutters, 29°, Full Flush Oblique Cutters drop-forged for an ideal material structure. Precise aligned cutting edges are additionally induction hardened at a hardness of Approx. 64°HRC. Two component non-slip soft grip handle, ESD Safe Dissipative.
Item No. mm Inch Copper Head Wdth
32724 115 4.5 1.0 12.0mm

Oblique Angled Cutters



32726 Oblique Angled Cutters, 29°, Short Head, Semi Flush Oblique Cutters drop-forged for an ideal material structure. Precise aligned cutting edges are additionally induction hardened at a hardness of Approx. 64°HRC. Two component non-slip soft grip handle, ESD Safe Dissipative.
Item No. mm Inch Copper Head Wdth
32726 115 4.5 1.2 12.0mm

Oblique Front Cutters

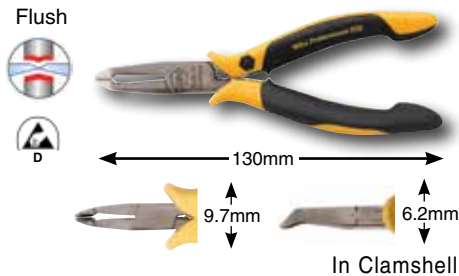

32728 Oblique Front Cutters, Very Small Head, 40°, Flush Oblique Cutters drop-forged for an ideal material structure. Precise aligned cutting edges are additionally induction hardened at a hardness of Approx. 64°HRC. ESD Safe Dissipative.
Item No. mm Inch Copper Head Wdth
32728 130 5.1 0.8 8.5mm

End Cutters Extra Slim

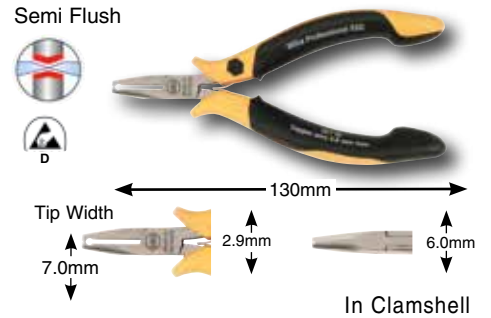

32732 End Cutters, Extra Slim, Semi Flush End Cutters drop-forged for an ideal material structure. Precise aligned cutting edges are additionally induction hardened at a hardness of Approx. 64°HRC. ESD Safe Dissipative.
Item No. mm Inch Copper Tip Wdth
32732 130 5.1 0.6 4.1mm

End Cutters Wide Head



32734 End Cutters, Wide Head, Flush End Cutters drop-forged for an ideal material structure. Precise aligned cutting edges are additionally induction hardened at a hardness of Approx. 64°HRC. ESD Safe Dissipative.
Item No. mm Inch Copper Head Wdth
32734 115 4.5 1.4 11.0mm

ESD Safe Pliers

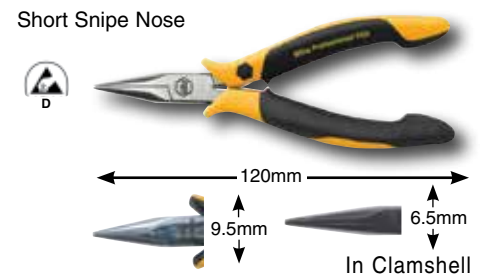

32742 ESD Safe Pliers, Short Snipe Nose (Chain Nose) Straight, Serrated Jaws Pliers drop-forged for an ideal material structure. Precisely aligned, jaws, hardened. Two component non-slip soft grip handle, ESD Safe Dissipative.
Item No. mm Inch Head Wdth
32742 120 4 3/4 9.5mm

ESD Safe Pliers

Bent Snipe
Nose 45°



In Clamshell

32744 ESD Safe Pliers, Snipe Nose (Chain Nose) Bent 45°, Smooth Jaws

Pliers drop-forged for an ideal material structure. Precisely aligned, jaws, hardened. ESD Safe Dissipative.

Item No.	mm	Inch	Head Wdth
32744	120	4 3/4	9.5mm

ESD Safe Pliers

Short Round
Nose Pliers

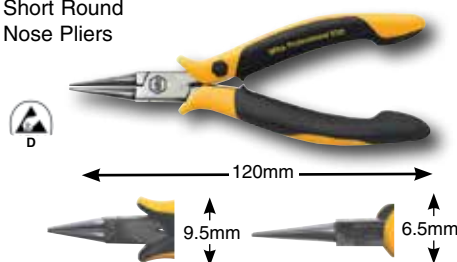

In Clamshell

32750 ESD Safe Pliers, Short Round Nose Pliers, Smooth Jaws

Pliers drop-forged for an ideal material structure. Precisely aligned, jaws, hardened. Two component non-slip soft grip handle, ESD Safe Dissipative.

Item No.	mm	Inch	Head Wdth
32750	120	4 3/4	9.5mm

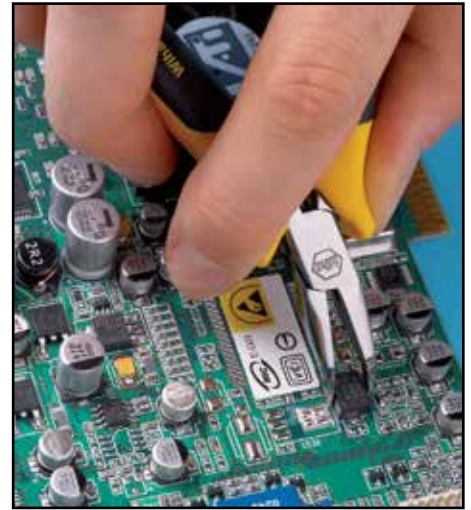

ESD Safe Pliers

Long Needle Nose

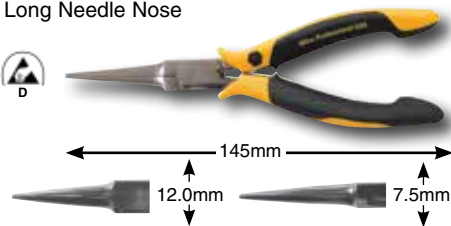

In Clamshell

32746 ESD Safe Pliers, Long Needle Nose Pliers, Straight, Serrated Jaws

Pliers drop-forged for an ideal material structure. Precisely aligned, jaws, hardened. ESD Safe Dissipative.

Item No.	mm	Inch	Head Wdth
32746	145	5 3/4	12.0mm

ESD Safe Pliers

Short Flat
Nose Pliers

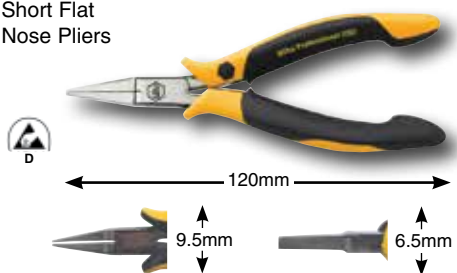

In Clamshell

32752 ESD Safe Pliers, Short Flat Nose Pliers, Smooth Jaws

Pliers drop-forged for an ideal material structure. Precisely aligned, jaws, hardened. Two component non-slip soft grip handle, ESD Safe Dissipative.

Item No.	mm	Inch	Head Wdth
32752	120	4 3/4	9.5mm

ESD Long Nose Pliers



In Clamshell

32762 ESD Safe Long Nose Pliers With Return Spring

Extra long cutters for flat and round cables. Serrated jaws. Long life edge is achieved through additional induction hardening to approx. 64HRC. Special C70 tool steel forgings. Two component non-slip soft grip handle, ESD Safe Dissipative.

Item No.	mm	Inch	Head Wdth
32762	165	6.5	.625"

ESD Safe Pliers

Needle Nose,
Bent 90°

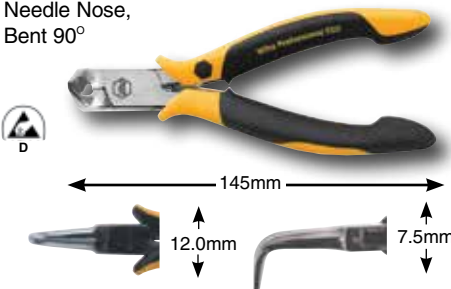

In Clamshell

32748 ESD Safe Pliers, Needle Nose Pliers, Bent 90°, Smooth Jaws

Pliers drop-forged for an ideal material structure. Precisely aligned, jaws, hardened. Two component non-slip soft grip handle, ESD Safe Dissipative.

Item No.	mm	Inch	Head Wdth
32748	145	5 3/4	12.0mm

ESD Safe Diagonal Cutters



In Clamshell

32760 ESD Safe Precision Flush Cutting Diagonal Cutters

Low wear lap joint, riveted and able to withstand high levels of load. Lightweight action, clean cutting. Long life edge is achieved through additional induction hardening to approx. 64HRC. Special C70 tool steel. Two component non-slip soft grip handle, ESD Safe Dissipative.

Item No.	mm	Inch	Head Wdth
32760	133	5.25	.5"

Precision ESD Safe Dissipative Screwdrivers

Wiha Precision ESD Static Dissipative Screwdrivers meet the requirements for tools used in static sensitive areas



Rotating cap

For precise turning & control with fingertip

Molded Precision handle

Impact resistant dissipative material

Tapered handle

allows rapid rotation

Blade

CVM steel, hardened, hard chrome finish

Tip

Precision ground for exact fit, Wiha Chromtop finish

ESD Standard IEC 61340-5-1

Surface resistance of handles is 10⁶ - 10⁹ Ohms

ESD standard IEC 61340-5-1



27899 Set 8 Pcs. TORX® Precision ESD Safe Dissipative Handle Set In Pouch Blade high alloy CVM steel, hardened, hard chromed. Handle impact resistant, dissipative material. Packaged in Clamshell

Item No.	TORX®:	Weight (lbs.)
27899	T1, T2, T3, T4, T5, T6, T7	.47
	Chip Lifter	



ESD Safe Pouch Sets Packaged In a Clamshell



27390 Set 7 Pcs. Slotted & Phillips Precision ESD Safe Dissipative Handle Blade high alloy CVM steel, hardened, hard chrome. Handle manufactured from impact resistant, dissipative material. Packaged in Clamshell

Item No.	Slotted:	Weight (lbs.)
27390	1.5, 2.0, 2.5, 3.5mm	.30
	Phillips: #00, 0, 1	



27894 Set 7 Pcs. TORXPlus® Precision ESD Safe Dissipative Handle Blade high alloy CVM steel, hardened, hard chromed. Packaged in Clamshell

Item No.	TORXPlus®:	Weight (lbs.)
27894	IP5, IP6, IP7, IP8, IP9, IP10, IP15	.27



27290 Set 8 Pcs. Slotted Precision ESD Safe Dissipative Handle Blade CVM steel, hardened, hard chrome. Handle impact resistant, dissipative material. In storage pouch, Packaged in Clamshell

Item No.	Slotted:	Weight (lbs.)
27290	.8, 1.0, 1.2, 1.5, 2.0, 2.5, 3.0, 3.5mm	.54

ESD standard IEC 61340-5-1



27591 Set 8 Pcs. Hex Inch Precision ESD Safe Dissipative Handle Blade CVM steel, hardened, hard chromed. Storage pouch, Packaged in Clamshell

Item No.	Hex Inch:	Weight (lbs.)
27591	.050, 1/16, 5/64, 3/32, 7/64, 1/8, 9/64, 5/32"	.57



27399 Set 8 Pcs. Slotted & Phillips Precision ESD Safe Dissipative Handle Blade high alloy CVM steel, hardened, hard chromed. Handle manufactured from impact resistant, dissipative material. Storage pouch, packaged in Clamshell

Item No.	Slotted:	Weight (lbs.)
27399	1.5, 2.0, 2.5, 3.0mm	.50
	Phillips: #000, 00, 0, 1	



27393 Set 7 Pcs. Extra Long Slotted/Phillips Precision ESD Safe Dissipative Handle Blade CVM steel, hardened, hard chromed. Handle impact resistant, dissipative material. ESD standard IEC 61340-5-1. In Pouch

Item No.	Slotted:	Weight (lbs.)
27393	2.0, 2.5, 3.0, 3.5, 4.0mm	.50
	Phillips: #0, 1	

ESD standard IEC 61340-5-1



27590 Set 8 Pcs. Hex Metric Precision ESD Safe Dissipative Handle Blade CVM steel, hardened, hard chromed. Storage pouch, packaged in Clamshell

Item No.	Hex Metric:	Weight (lbs.)
27590	.7, .9, 1.3, 1.5, 2.0, 2.5, 3.0, 4.0mm	.53

ESD standard IEC 61340-5-1



27791 Set 8 Pcs. Inch Nut Driver
Precision ESD Safe Dissipative Handle
 Blade CVM steel, hardened, hard chromed. In storage pouch, packaged in Clamshell

Item	Inch Nut Drivers:	
No.	3/32, 7/64, 1/8, 9/64,	lbs.
27791	5/32, 3/16, 7/32, 1/4"	.68

ESD standard IEC 61340-5-1



In Clamshell

27790 Set 8 Pcs. Metric Nut Driver
Precision ESD Safe Dissipative Handle
 Blade CVM steel, hardened, hard chromed.

Item	Metric Nut Drivers:	
No.	1.5, 2.0, 2.5, 3.0,	lbs.
27790	3.5, 4.0, 5.0, 5.5mm	.63

Wiha Magnetizer/ Demagnetizer

Magnetize or Demagnetize tools & small parts instantly

Shatterproof Box is made from high quality plastic

Uses 2 C8 industrial permanent magnets



(+) to Magnetize

(-) to Demagnetize

40010 Magnetizer and Demagnetizer
 To magnetize and demagnetize steel screwdriver blades, tweezers and similar tools. Box high quality plastic, shock-resistant, green, cadmium free. In Clamshell

Application:
 To magnetize, lead tool slowly through the (+) opening, to demagnetize guide tool slowly through the (-) opening.

Item		
No.	Dimensions	lbs.
40010	2.1" x 2.0" x 1.1"	.30

(Parts under 1" Length or 1/8" Diameter may not demagnetize)

Technician's Micro Bit Sets

- Micro Precision Bits on 4mm Hex Drive
- Bits of Exclusive CRM-72 Tool Steel
- Handle uses non-magnetic ball retainer
- Use bits in extension only
- Standard extension adds 4" to length
- Non-magnetic bit extension

Surface resistance of handles is 10⁶ - 10⁹ Ohms

Light weight & compact

Rotation cap

Handle tapered for precise control

Bits hardened for extreme durability



75093 SYSTEM 4 Slotted, Phillips, TORX® Compact ESD Precision Interchangeable Bit Set, 16 Pcs. Wiha precision handle, bit extension & 14 interchangeable bits.

Item No.	Combination Bit Set
75093	Set with ESD Safe Precision Handle
	● Slotted: 1.5, 2.0, 2.5, 3.0mm
	⊕ Phillips: 00, 0, 1
lbs.	● TORX®: T6, T7, T8, T9, T10, T15, T20
.17	○ 100mm Bit Extension

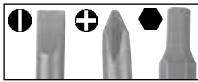

75094 SYS 4 Slotted, Phillips, Hex Inch Compact ESD Precision Interchangeable Bit Set, 16 Pcs. Wiha precision handle, bit extension & 14 interchangeable bits.

Item No.	Combination Bit Set
75094	Set with ESD Safe Precision Handle
	● Slotted: 1.5, 2.0, 2.5, 3.0mm
	⊕ Phillips: 00, 0, 1
lbs.	● Hex Inch: .035, .050, 1/16, 5/64,
.17	○ 100mm Bit Extension

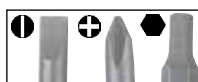

75095 SYS 4 Slotted, Phillips, Hex Metric Compact ESD Precision Interchangeable Bit Set, 16 Pcs. Wiha precision handle, bit extension & 14 interchangeable bits.

Item No.	Combination Bit Set
75095	Set with ESD Safe Precision Handle
	↓ Slotted: 1.5, 2.0, 2.5, 3.0mm
	⊕ Phillips: 00, 0, 1
lbs.	● Hex Metric: .9, 1.3, 1.5, 2.0,
.17	○ 100mm Bit Extension

75096 SYSTEM 4 Hex Inch & Metric Compact ESD Precision Interchangeable Bit Set, 16 Pcs. Wiha precision handle, bit extension & 14 interchangeable bits.

Item No.	Combination Bit Set
75096	Set with ESD Safe Precision Handle
	● Hex Inch: 1/16, 5/64, 3/32, 7/64, 1/8, 9/64, 5/32"
lbs.	● Hex Metric: .9, 1.3, 1.5, 2.0,
.17	○ 100mm Bit Extension

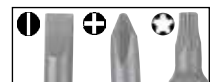

75097 SYS 4 Slotted, Phillips & 5Point Compact ESD Precision Interchangeable Bit Set, 16 Pcs. Wiha precision handle, bit extension & 14 interchangeable bits.

Item No.	Combination Bit Set
75097	Set with ESD Safe Precision Handle
	● Slotted: 1.2, 1.5, 2.0, 2.5, 3.0mm
lbs.	⊕ Phillips: 000, 00, 0, 1, 2
.17	● Pentalobe: PL1, PL2, PL3, PL4
.17	○ 100mm Bit Extension

Wiha Precision ESD Safe Chip Lifter

Surface resistance of handles is 10⁶ - 10⁹ Ohms



27920 Precision Chip Lifter - ESD Safe
 Blade CVM steel, hardened, corrosion resistant finish. Precision handle high quality plastic, Dissipative material. In Clamshell

Item						
No.	mm	mm	mm	mm	Inch	lbs. pkg.
27920	1	3.5	50	145	5.7	.07 1

ESD Safe dissipative handle



Rotating cap
for precise turning and control with fingertip

Precision handle
high quality plastic, cadmium free

Molded on tapered handle
allows rapid rotation

High performance blades
CVM steel, Hard chrome finished

Tip
precision ground for exact fit, hard chromed non-slip surface

Wiha Precision Chip Lifter & Accessories



26810 Precision Chip Lifter
Blade CVM steel, hardened, chrome-plated. Precision handle high quality plastic, impact resistant. Standard handle. In Clamshell

Item No.	mm	mm	mm	mm	Inch
26810	1	3.5	50	145	5.7

*Metric dimensions actual - Inch dimensions approximate



26190 8 Piece Precision Slotted & Phillips Screwdrivers & Industrial Long Nose Pliers Set In Clamshell

Item No.	Slotted:	Phillips:	Industrial Long Nose Pliers
26190	1.5 x 40mm	00 x 40mm	6.3"/160mm OAL
	2.0, 2.5 x 50mm, 3.0 x 60mm	0 x 50mm, 1 x 60mm	

Wiha Precision Slotted/Phillips Drivers



26090 6 Piece Precision Slotted Set
Blade high alloy chrome-vanadium-molybdenum steel. Hard chrome finished.

Item No.	Slotted:	lbs.
26090	1.5, 2.0 x 40mm	.27
	2.5, 3.0 x 50mm	
	3.5, 4.0 x 60mm	



26099 8 Piece Precision Slotted Set
Blade high alloy CVM steel. Hard chrome finished. In canvas storage pouch. In Clamshell

Item No.	Slotted:	lbs.
26099	1.0, 1.2, 1.5, 2.0 x 40mm	.54
	2.5, 3.0 x 50mm, 3.5, 4.0 x 60mm	



26197 7 Pc. Precision Slotted & Phillips Set In Clamshell

Item No.	Slotted:	Phillips:	lbs.
26197	1.5 x 40mm	00 x 40mm	.31
	2.0, 2.5 x 50mm, 3.0 x 60mm	0 x 50mm, 1 x 60mm	



26199 8 Pc. Precision Slotted/Phillips Set

Item No.	Slotted:	Phillips:	lbs.
26199	1.0, 2.0 x 40mm, 3.0 x 50mm, 4.0 x 60mm	000, 00 x 40mm, 0 x 50mm, 1 x 60mm	.55



26092 7 Piece Precision Slotted & Phillips Set Blade high alloy chrome-vanadium-molybdenum steel. In Pouch

Item No.	Slotted:	lbs.
26092	2.5 x 50mm, 2.5, 3.0, 4.0 x 100mm, 3.0, 4.0 x 150mm	.30
	Phillips:	
	0 x 75mm	



26194 4 Piece Precision Phillips Set
Blade high alloy CVM steel. Hard chrome finished. In Clamshell

Item No.	Phillips:	lbs.
26194	000, 00 x 40mm, 0 x 50mm, 1 x 60mm	.18



26192 5 Piece Precision Slotted & Phillips Set Blade high alloy chrome-vanadium-molybdenum steel. In Pouch

Item No.	Slotted:	Phillips:	lbs.
26192	2.5, 3.0, 4.0 x 150mm	0, 1 x 150mm	.44

Wiha PicoFinish Precision Tri-Wing Screwdriver



26631 Precision PicoFinish Tri-Wing Driver Blade CVM steel, hardened, chrome-plated. PicoFinish handle, molded on soft grip. In Clamshell

Item No.	Inch	mm	Inch	mm	lbs.	Pkg.
26631	1.6	40	5.5	140	.02	1

Wiha TORX® Precision Series



26792 7 Pc. TORX® Screwdriver Set

Blade high alloy chrome-vanadium-molybdenum steel. In Clamshell

Item		↔
No.	TORX®:	lbs.
26792	T5, T6, T7, T8 x 40mm T9, T10 x 50mm T15 x 60mm	.33



26790 6 Pc. TORX® Screwdriver Set

Blade high alloy chrome-vanadium-molybdenum steel. In Clamshell

Item		↔
No.	TORX®:	lbs.
26790	T6, T7, T8 x 40mm T9, T10 x 50mm T15 x 60mm	.30

26791 Set 8 Pcs. TORX® Screwdriver Set

Item No.	T1, T2, T3, T4,
26791	T5, T6, T7, T8



26799 8 Pc. TORX® Screwdriver Set

Blade high alloy CVM steel. Hard chrome finished. In canvas storage pouch, packaged in Clamshell

Item	TORX® : T3, T4, T5,	↔
No.	T6, T7, T8 x 40mm	lbs.
26799	T9 x T10 x 50mm	.50

Precision Pouch Sets Packaged In a Clamshell



Wiha Precision Inch/Metric Hex & Ball End Hex Drivers



26391 8 Pc. Precision Hex Driver Set -

Inch Blade high alloy chrome-vanadium-molybdenum steel. In Clamshell

Item No.	Hex Inch:	↔
26391	.028, .035, .050 x 1.6"	lbs.
	1/16, 5/64 x 2.0"	.32
	3/32, 7/64, 1/8 x 2.4"	



26390 7 Pc. Precision Hex Driver Set -

Metric CVM steel. In Clamshell

Item No.	Hex Metric:	↔
26390	.7, .9, 1.3 x 40mm	lbs.
	1.5, 2.0 x 50mm & 2.5, 3.0 x 60mm	.28



26399 8 Pc. Precision Hex Driver Set -

Inch Blade high alloy CVM steel. Hard chrome finished. In canvas storage pouch. In Clamshell

Item No.	Hex Inch:	↔
26399	.028, .035, .050 x 1.6"	lbs. .55
	1/16, 5/64 x 2.0", 3/32, 7/64, 1/8 x 2.4"	

Wiha Pentalobe Set



26794 6 Pc. Precision Pentalobe

Screwdriver Set Blade high alloy CVM steel. Hard chrome finished. Super hardened best wear resistance long life. In Clamshell

Item No.	Pentalobe Drivers:	↔
26794	PL1, PL2, PL3, PL4, PL5, PL6	lbs. .35



26491 5 Piece Ball End Hex Driver Set -

Metric Angle entry up to 30°. Blade high alloy chrome-vanadium-molybdenum-steel. In Clamshell

Item		↔
No.	Ball End Hex Metric:	lbs.
26491	1.3 x 40mm 1.5, 2.0 x 50mm 2.5, 3.0 x 60mm	.31



In canvas storage pouch



26499 8 Pc. Ball End Hex Driver Set - Inch

Blade high alloy chrome-vanadium-molybdenum steel. Hard chrome finished. In Clamshell

Item	Ball End Hex Inch:	↔
No.	.050 x 1.6"	lbs. .62
26499	1/16, 5/64, 3/32 x 2.0" 7/64, 1/8, 9/64, 5/32 x 2.4"	

Wiha Pentalobe Precision Series

Wiha Pentalobe drivers will fit fasteners used in "Apple" brand products including iPhone, Mac Book & Mac Air

- Exact fit precision machined tips
- High performance CRM72 tool steel
- Hard chromed finish blades & tips
- Tapered ergonomic handle
- Easy spin finger tip control cap



267 Pentalobe Screwdrivers, With

Precision Handle Blade high alloy chrome-vanadium-molybdenum steel.

Item		↔
No.	Size mm Inch mm Inch lbs. pkg.	
26761	PL1 40 1.6 120 4.7 .01 1	
26762	PL2 40 1.6 120 4.7 .02 1	
26763	PL3 40 1.6 120 4.7 .02 1	
26764	PL4 40 1.6 120 4.7 .02 1	
26765	PL5 40 1.6 120 4.7 .02 1	
26766	PL6 40 1.6 120 4.7 .02 1	

*Metric dimensions actual - Inch dimensions approximate (PL4 is used for Mac Book Pro)

Wiha Precision Screwdriver Single Packs



960 Slotted Screwdriver, With Precision Handle Blade high alloy chrome-vanadium-molybdenum steel.

Item No.	mm	Inch	mm	Inch	mm	mm	Inch	lbs.
96008	.80	1/32	40	1.6	0.16	120	4.7	.02
96010	1.0	.039	40	1.6	0.18	120	4.7	.02
96012	1.2	3/64	40	1.6	0.20	120	4.7	.02
96015	1.5	1/16	40	1.6	0.25	120	4.7	.02
96018	1.8	.070	40	1.6	0.30	120	4.7	.02
96020	2.0	5/64	40	1.6	0.40	120	4.7	.02
96025	2.5	3/32	50	2.0	0.40	145	5.7	.03
96030	3.0	1/8	50	2.0	0.50	145	5.7	.03
96035	3.5	9/64	60	2.4	0.60	170	6.7	.05
96040	4.0	5/32	60	2.4	0.80	170	6.7	.05

*Metric dimensions actual - Inch dimensions approximate



961 Phillips Screwdriver, With Precision Handle Blade high alloy chrome-vanadium-molybdenum steel.

Item No.	Size	mm	Inch	mm	Inch	mm	Inch	lbs.
96102	000	40	1.6	2.0	.08	120	4.7	.02
96100	00	40	1.6	2.0	.08	120	4.7	.02
96105	0	50	2.0	3.0	.12	145	5.7	.02
96110	1	60	2.4	4.0	.16	170	6.7	.05

*Metric dimensions actual - Inch dimensions approximate



967 TORX® Screwdriver, With Precision Handle Blade high alloy CVM steel.

Item No.	Size	mm	Inch	mm	Inch	lbs.
96703	T3	40	1.6	120	4.7	.02
96704	T4	40	1.6	120	4.7	.02
96705	T5	40	1.6	120	4.7	.02
96706	T6	40	1.6	120	4.7	.02
96707	T7	40	1.6	120	4.7	.02
96708	T8	40	1.6	120	4.7	.03
96709	T9	50	2.0	145	5.7	.03
96710	T10	50	2.0	145	5.7	.03
96715	T15	60	2.4	170	6.7	.05
96720	T20	60	2.4	170	6.7	.05

*Metric dimensions actual - Inch dimensions approximate



963 Inch Hex Driver, With Precision Handle Inch sizes. Blade high alloy chrome-vanadium-molybdenum steel.

Item No.	Inch	mm	mm	Inch	mm	Inch	lbs.
96307	0.028	0.7	40	1.6	120	4.7	.02
96309	0.035	0.9	40	1.6	120	4.7	.02
96313	0.05	1.3	40	1.6	120	4.7	.02
96316	1/16	-	50	2.0	145	5.7	.03
96320	5/64	2.0	50	2.0	145	5.7	.03
96323	3/32	-	60	2.4	170	6.7	.04
96327	7/64	-	60	2.4	170	6.7	.04
96331	1/8	-	60	2.4	170	6.7	.04

*Metric dimensions actual - Inch dimensions approximate



963 Metric Metric Hex Driver, With Precision Handle Metric sizes. Blade high alloy chrome-vanadium-molybdenum steel.

Item No.	mm	Inch	mm	Inch	mm	Inch	lbs.
96307	.7	.028	40	1.6	120	4.7	.02
96309	.9	.035	40	1.6	120	4.7	.02
96313	1.3	.050	40	1.6	120	4.7	.02
96315	1.5	-	50	2.0	145	5.7	.03
96320	2.0	5/64	50	2.0	145	5.7	.03
96325	2.5	-	60	2.4	170	6.7	.04
96330	3.0	-	60	2.4	170	6.7	.04

*Metric dimensions actual - Inch dimensions approximate



964 Metric Ball End Hex Metric Screwdriver With Precision Handle Angle entry up to 30°. Blade high alloy CVM steel.

Item No.	mm	Inch	mm	Inch	mm	Inch	lbs.	Pkg.
96413	1.3	.050	40	1.6	120	4.7	.02	10
96415	1.5	-	50	2.0	145	5.7	.03	10
96420	2.0	-	50	2.0	145	5.7	.03	10
96425	2.5	-	60	2.4	170	6.7	.04	10
96430	3.0	-	60	2.4	170	6.7	.05	10

*Metric dimensions actual - Inch dimensions approximate



965 Metric Metric Nut Driver With Precision Handle Metric sizes. Blade CVM steel.

Item No.	mm	mm	Inch	mm	Inch	lbs.
96510	1.5	60	2.4	140	5.5	.03
96515	1.8	60	2.4	140	5.5	.03
96520	2.0	60	2.4	140	5.5	.04
96525	2.5	60	2.4	155	6.1	.04
96530	3.0	60	2.4	155	6.1	.05
96532	3.2	60	2.4	155	6.1	.05
96535	3.5	60	2.4	155	6.1	.05
96540	4.0	60	2.4	155	6.1	.05
96545	4.5	60	2.4	155	6.1	.05
96550	5.0	60	2.4	155	6.1	.05
96555	5.5	60	2.4	170	6.7	.06
96560	6.0	60	2.4	170	6.7	.06
96570	7.0	60	2.4	170	6.7	.06

965 Inch Inch Nut Driver With Precision Handle Inch sizes. Blade CVM steel.

Item No.	Inch	mm	Inch	mm	Inch	lbs.
96523	3/32	60	2.4	155	6.1	.04
96527	7/64	60	2.4	155	6.1	.05
96531	1/8	60	2.4	155	6.1	.05
96536	9/64	60	2.4	155	6.1	.05
96539	5/32	60	2.4	155	6.1	.05
96547	3/16	60	2.4	155	6.1	.05
96556	7/32	60	2.4	170	6.7	.06
96563	1/4	60	2.4	170	6.7	.06

*Metric dimensions actual - Inch dimensions approximate



964 Inch Ball End Hex Inch Screwdriver With Precision Handle Angle entry up to 30°. Blade high alloy chrome-vanadium-molybdenum steel. Hard chrome finish.

Item No.	Inch	mm	Inch	mm	Inch	lbs.	Pkg.
96413	.050	40	1.6	120	4.7	.02	10
96416	1/16	50	2.0	145	5.7	.03	10
96419	5/64	50	2.0	145	5.7	.03	10
96423	3/32	50	2.0	145	5.7	.03	10
96427	7/64	60	2.4	170	6.7	.03	10
96431	1/8	60	2.4	170	6.7	.05	10
96436	9/64	60	2.4	170	6.7	.05	10
96439	5/32	60	2.4	170	6.7	.05	10

*Metric dimensions actual - Inch dimensions approximate

Wiha Terminator Impact Bits

Special energy absorbing dual material design

Standard 1/4" drive

Tough impact absorbing torsional zone

Up To 30X Performance Over Standard Screwdriver Bits

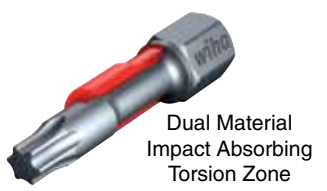

Dual Material Impact Absorbing Torsion Zone

No special bit holder required

Precision heat treated & premium CVM tool steel

Terminator Bit Sets Packaged In a Clamshell



Wiha Impact Power Bit Sets





76892 7 Pc. Bit Buddy Set With Terminator Impact Power Bits - 49mm

76892 Set includes the following bits:

- Phillips: #2, 3
- Square: #2, 3
- Torx®: T20, T25, T30

Wiha Impact Insert Bit Sets



76890 8 Pc. Bit Buddy Set With Terminator Impact Insert Bits - 29mm

76890 Set includes the following bits:

- 3 Phillips: #2
- Square: #2
- Torx®: T15, T20, T25

Includes magnetic bit holder



76893 8 Pc. Bit Buddy Set With Terminator Impact Insert Bits - 29mm

76893 Set includes the following bits:

- Hex Inch: 5/32, 3/16, 7/32, 1/4"
- Hex Metric: 4, 5, 6mm

Includes magnetic bit holder



76894 7 Pc. Bit Buddy Set With Terminator Impact Power Bits - 49mm

76894 Set includes the following bits:

- Hex Inch: 5/32, 3/16, 7/32, 1/4"
- Hex Metric: 4, 5, 6mm



76891 8 Pc. Bit Buddy Set With Terminator Impact Insert Bits - 29mm

76891 Set includes the following bits:

- Phillips: #2, 3
- Square: #2, 3
- Torx®: T20, T25, T30

Includes magnetic bit holder



76895 8 Pc. Bit Buddy Set With Terminator Impact Insert Bits - 29mm

76895 Set includes the following bits:

- Torx®: T10, T15, T20, T25, T27, T30, T40

Includes magnetic bit holder



76896 7 Pc. Bit Buddy Set With Terminator Impact Power Bits - 49mm

76896 Set includes the following bits:



- Torx®: T10, T15, T20, T25, T27, T30, T40

Wiha Terminator Impact Bits - 10 Packs in Clamshell

1/4" Drive Insert & Power Bits





765 Phillips Terminator Impact Bits, 1/4" Insert - 10 Bit Pack In Clamshell

Item			
No.	Size	mm	pkg.
76501	1	29	10
76502	2	29	10
76503	3	29	10





765 Pozidriv® Terminator Impact Bits, 1/4" Insert - 10 Bit Pack In Clamshell

Item			
No.	Size	mm	pkg.
76506	1	29	10
76507	2	29	10
76508	3	29	10





765 TORX® Terminator Impact Bits, 1/4" Insert - 10 Bit Pack In Clamshell

Item			
No.	Size	mm	pkg.
76510	T10	29	10
76511	T15	29	10
76512	T20	29	10
76513	T25	29	10
76514	T27	29	10
76516	T30	29	10
76517	T40	29	10





765 Square Terminator Impact Bits, 1/4" Insert - 10 Bit Pack In Clamshell

Item			
No.	Size	mm	pkg.
76538	1	29	10
76539	2	29	10
76540	3	29	10





765 Hex Inch Terminator Impact Bits, 1/4" Insert - 10 Bit Pack In Clamshell

Item			
No.	Inch	mm	pkg.
76530	1/8	29	10
76531	9/64	29	10
76532	5/32	29	10
76533	3/16	29	10
76534	7/32	29	10
76535	1/4	29	10





765 Hex Metric Terminator Impact Bits, 1/4" Insert - 10 Bit Pack In Clamshell

Item			
No.	mm	mm	pkg.
76523	3.0	29	10
76524	4.0	29	10
76525	5.0	29	10
76526	6.0	29	10





765 Phillips Terminator Impact Bits, 1/4" Power - 10 Bit Pack In Clamshell

Item			
No.	Size	mm	pkg.
76543	1	49	10
76544	2	49	10
76545	3	49	10



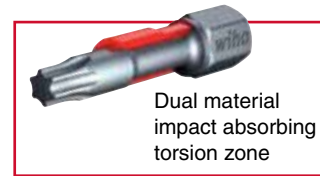

765 Pozidriv® Terminator Impact Bits, 1/4" Power - 10 Bit Pack In Clamshell

Item			
No.	Size	mm	pkg.
76548	1	49	10
76549	2	49	10
76550	3	49	10





765 Square Terminator Impact Bits, 1/4" Power - 10 Bit Pack In Clamshell

Item			
No.	Size	mm	pkg.
76578	1	49	10
76579	2	49	10
76580	3	49	10





765 TORX® Terminator Impact Bits, 1/4" Power - 10 Bit Pack In Clamshell

Item			
No.	Size	mm	pkg.
76553	T10	49	10
76554	T15	49	10
76555	T20	49	10
76556	T25	49	10
76557	T27	49	10
76558	T30	49	10
76559	T40	49	10





765 Hex Inch Terminator Impact Bits, 1/4" Power - 10 Bit Pack In Clamshell

Item			
No.	Inch	mm	pkg.
76570	1/8	49	10
76571	9/64	49	10
76572	5/32	49	10
76573	3/16	49	10
76574	7/32	49	10
76575	1/4	49	10



765 Hex Metric Terminator Impact Bits, 1/4" Power - 10 Bit Pack In Clamshell

Item			
No.	mm	mm	pkg.
76563	3.0	49	10
76564	4.0	49	10
76565	5.0	49	10
76566	6.0	49	10

Wiha Bit Selectors



Compact size and easy bit selection make the Bit Selector an ideal maintenance tool

Slide out drawer allows quick bit access and secure storage



Plastic storage box is compact, durable and light weight
1/4" Magnetic Adapter fits all standard 1/4" bits

Molded hex cavity in box end Magnetic adapter fits into opening so tool case can be used as a handle on quick fastening jobs

792 Sets Bit-Selector Sets

These handy sets include 10 hardened bits of chrome-vanadium-molybdenum steel. 1/4" magnetic bit holder can be used in power tools. Plastic storage box is compact, durable and light weight. Molded hex cavity turns box into handle for quick fastening jobs. Quick bit access with slide out drawer. Packaged in clear blister pack.



79243 Bit-Selector With Slotted, Phillips & TORX® Bits, Includes 1/4" Bit Holder & The Following 10 Bits: lbs. .32

- ↓ Slotted: 4.5, 5.5, 6.0mm
- ⊕ Phillips: #0, 1, 2, 3
- ⊗ TORX®: T10, T15, T20

79248 Bit-Selector With Slotted, Phillips & Square Bits, Includes 1/4" Bit Holder & The Following 10 Bits: lbs. .32

- ↓ Slotted: 4.5, 5.5, 6.0mm
- ⊕ Phillips: #0, 1, 2, 3
- Square: #1, 2, 3

71090 Bit-Selector With Slotted, Phillips & Hex 1/4" Bits, Includes Magnetic 1/4" Bit Holder & The Following 9 Bits: lbs. .31

- ↓ Slotted: 4.5, 5.5, 6.5mm
- ⊕ Phillips: #1, 2, 3
- ⬢ Hex Inch: 1/8, 5/32, 3/16"

Wiha XSelector & XLSelector Bit Sets

Compact size and easy bit selection make the Wiha XSelector an ideal maintenance tool



Easy bit access with hinged cover



XLSelector Pocket Sized 5.3" x 3.1" x .7"
XSelector Pocket Sized 3 1/8" x 2 1/8" x 1/2"

Sets include Clicfix quick release holder

These handy sets include 10 hardened bits of CVM steel. 1/4" Quick Release holder can be used in power tools. Quick bit access through integrated bit-clip.



79443 XSelector Bit Set With Slotted, Phillips, and TORX® Bits Set Includes Quick Release Holder & the following 10 bits:

- ↓ Slotted: 5.5, 6.5, 8.0mm
- ⊕ Phillips: #0, 1, 2, 3 lbs.
- ⊗ TORX®: T10, T15, T20 .27



79499 XLSelector 1/4" Ratchet & Bit Set Wiha 1/4" ratchet bit handle, bit holder & 15 Insert bits Includes:

- ↓ Slotted: 4.5, 5.5, 6.0mm
- ⊕ Phillips: #0, 1, 2
- ⊗ TORX®: T7, T8, T9, T10, T15, T20, T25
- Square: #1, 2
- ↔ lbs. .56



79491 XLSelector 1/4" Ratchet & Bit Set Wiha 1/4" ratchet bit handle, bit holder & 15 Insert bits Includes:

- ↓ Slotted: 4.5, 6.0mm
- ⊕ Phillips: #1, 2, 3 lbs.
- Square: #1, 2 .56
- ⊕ Pozidriv: #1, 2
- ⬢ Hex Metric: 2.0, 2.5, 3.0, 4.0, 5.0, 6.0mm



79495 XLSelector Bit Set With Slotted, Phillips, TORX®, Hex Bits, 31 Pc. Set Includes: ClicFix Bit Holder-magnetic & 30 Insert Bits In Clamshell

- ↓ Slotted: 4.5, 5.5, 6.0mm
- ⊕ Phillips: #0, 1, 2, 3
- ⊗ TORX®: T6, T7, T8, T9, T10, T15, T20, T25
- ⬢ Metric Hex: 2.0, 2.5, 3.0, 4.0, 5.0, 6.0mm lbs. .62
- ⬢ Inch Hex: 5/64, 3/32, 7/64, 1/8, 9/64, 5/32, 3/16, 7/32, 1/4"

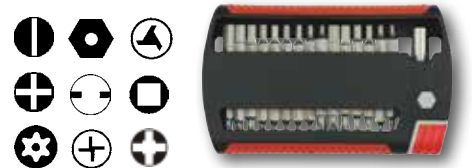

79490 XLSelector Security Bit Set, 31 Pc. Set Includes Universal Bit Holder-magnetic and the following 30 bits:

- ↓ Slotted: 6.0mm
- ⊕ Phillips: #1, 2
- ⊕ Torq Set: #6, 8, 10
- Square: #1, 2
- ⊕ Triwing: #2, 3, 4, 5
- ⊕ Pozidriv: #1, 2
- ↔ Spanner: #4, 6, 8, 10
- ⊗ Security TORX®: T8s, T10s, T15s, T20s, T25s lbs. .64
- ⬢ Security Hex: 5/64, 3/32, 7/64, 1/8, 9/64, 5/32, 3/16"



79493 XLSelector Security Bit Set, 31 Pc. Set Includes Universal Bit Holder-magnetic and the following 30 bits:

- ↓ Slotted: 4.5, 5.5, 6.0mm
- ⊕ Phillips: #1, 2, 3
- Square: #1, 2
- ⊗ TORX®: T7, T8, T9, T10, T15, T20, T25
- ⬢ Hex Metric: 2.0, 2.5, 3.0, 4.0, 5.0, 6.0mm
- ⬢ Hex Inch: 5/64, 3/32, 7/64, 1/8, 9/64, 5/32, 3/16, 7/32, 1/4"
- ↔ lbs. .64

Wiha 1/4" Insert Bit sets

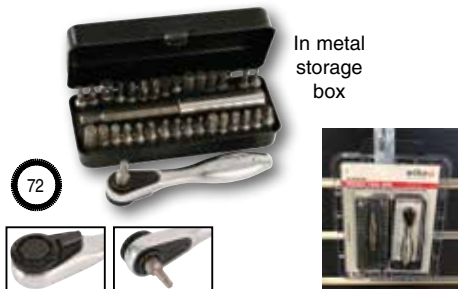

In metal storage box

72

74996 Ratchet Bit Set, 35 Pcs. Includes: Wiha 1/4" ratchet bit handle, bit holder, Hex/Sqr. Adapter & 33 Insert bits. In Clamshell

Item No. 74996 1/4" Ratchet Bit Set

- ⦿ **Slotted:** 5.5, 6.0mm
- ⊕ **Phillips:** #0, 1, 2, 3
- ⊖ **Square:** #1, 2
- ⊛ **TORX®:** T8, T10, T15, T20, T25, T27, T30
- ⬢ **Hex Metric:** 1.5, 2.0, 2.5, 3.0, 4.0, 5.0, 6.0mm
- ⬢ **Hex Inch:** 1/16, 5/64, 3/32, 7/64, 1/8, 9/64, 5/32, 3/16, 7/32, 1/4"
- ⊖ **1/4" Magnetic Bit Holder**
- ⊖ **1/4" Hex to 1/4" Square Adapter**
- ⚖ **lbs. .80**



71990 Bits Collector with Security TORX®, Tri-Wing, Torq Set, Spanner, Security Hex, Slotted, Phillips, Pozidriv® and Square bits. 39 Pc. Set includes: Handle, 1/4" Drive-Loc bit holder, 1/4" Bit holding socket adapter, storage box & the following 1/4" bits.

- In Clamshell
- ⊛ **Security TORX®:** T8s, T10s, T15s, T20s, T25s, T27s, T30s, T40s
 - ⬢ **Security Hex:** 5/64, 3/32, 7/64, 1/8, 9/64, 5/32"
 - ⦿ **Tri-Wing:** 1, 2, 3, 4
 - ⊕ **Torq Set:** 6, 8, 10
 - ⊖ **Spanner:** 4, 6, 8, 10
 - ⦿ **Slotted:** 6.0, 8.0mm
 - ⊕ **Phillips:** 1, 2
 - ⊕ **Pozidriv®:** 0, 1, 2, 3
 - ⊖ **Square:** 1, 2, 3



71994 Bits Collector with TORX®, Slotted, Phillips, Pozidriv®, Square & Hex Bits. 38 Pc. Set Includes: Handle, 1/4" bit holder, storage box & the following 1/4" bits.

- In Clamshell
- ⊛ **TORX®:** T7, T8, T9, T10, T15, T20, T25, T27, T30, T40
 - ⊖ **Square:** 1, 2, 3 & **Pozidriv®:** 1, 2, 3
 - ⦿ **Slotted:** 4.5, 5.5, 6.0mm
 - ⊕ **Phillips:** 0, 1, 2, 3
 - ⦿ **Hex Metric:** 2.5, 3.0, 4.0, 5.0, 6.0mm
 - ⦿ **Hex Inch:** 1/16, 5/64, 3/32, 1/8, 5/32, 3/16, 7/32, 1/4"

Wiha 90mm Power Blade Sets



76000 CentroFix Cushion Grip Blade Holder Wiha-SoftFinish® impact resistant, with roll off protection. Ergonomic cushion grip handle. Quick release bit holder with magnet.

Item No.	⊖	⊕	⊖	⦿	⦿	⚖
	mm	mm	Inch	mm	Inch	lbs.
76000	6.0	149	5.9	34.6	1.36	.26



76098 36 Pc. Power Blade Set, In Durable Belt Pack Set includes cushion grip CentroFix Blade Holder & 35 interchangeable blades.

- Item No. 76098** ⚖ **lbs. 1.86**
- Slotted:** 2.5, 3.0, 4.5, 5.5, 6.0mm
 - Phillips:** #0, 1, 2, 3
 - Security TORX®:** T8s, T9s, T10s, T15s, T20s, T25s, T27s, T30s, T40s
 - Security Hex Metric:** 2.5, 3.0, 4.0, 5.0mm
 - Pozidriv®:** #1, 2, 3 & **Square:** #1, 2, 3
 - Spanner:** #6, 8, 10 & **Tri-Wing:** #1, 2, 3, 4
- Cushion Grip CentroFix Blade Holder

Cushion Grip Stubby Bit Sets

Stubby Sets Packaged In a Clamshell



38043 SoftFinish® Cushion Grip Stubby Bit Holder with Wiha cushion grip handle & CVM tool steel shaft. In Clamshell

- Set includes the following 1/4" bits:**
- ⦿ **Slotted:** 4.5, 6.0mm ⚖ **lbs.**
 - ⊕ **Phillips:** #1, #2 **lbs.**
 - ⊕ **Pozidriv®:** #1, #2 **.20**



38048 SoftFinish® Cushion Grip Stubby Bit Holder with Wiha cushion grip handle & CVM tool steel shaft. In Clamshell

- Set includes the following 1/4" bits:**
- ⦿ **Slotted:** 4.5, 6.0mm ⚖ **lbs.**
 - ⊕ **Phillips:** #1, #2 **lbs.**
 - ⊖ **Square:** #1, #2 **.20**

Wiha Cushion Grip Pop-Up Screwdriver Bit Sets



Handle Diameter 1.45"



38032 Pop-Up Bit Screwdriver Set

Wiha Cushion Grip handle, multi-component. Compact storage for 12 bits in the handle. Bit holder stainless steel, magnetic. 8.25" OAL In Clamshell

- **Slotted:** 4.5, 5.5, 6.0mm ↔ lbs.
- ⊕ **Phillips:** 1, 2, 3 .42
- ⊛ **TORX®:** T10, T15, T20, T25, T27, T30



38041 Pop-Up Bit Screwdriver Set

Wiha Cushion Grip handle, multi-component. Compact storage for 12 bits in the handle. Bit holder stainless steel, magnetic. 8.25" OAL In Clamshell

- **Slotted:** 4.5, 6.0mm ↔
- **Square:** 1, 2 lbs.
- ⊕ **Phillips:** 1, 2 .42
- ⬢ **Hex:** 4.0, 5.0, 6.0mm
- ⊛ **TORX®:** T20, T25, T30



More Info. on Page 56

New Counter Top Displays!

Wiha 26inOne Ultra Drivers

"Grab & Go Tool Box"



Ultra Lite!
Ultra Compact!
Ultra Fast Access!
Ultra Quality!

- 13 Double End Bits
- Locking Bit Holder
- Pop-up Bit Access
- Rugged Industrial Design
- Cushion Grip Handle
- Professional Quality
- Made in Germany



Tradesman

77797 Cushion Grip Ultra Driver 26inOne

Wiha cushion grip handle & CVM tool steel shaft. Locking bit holder. In Clamshell

Includes the following 1/4" double end bits:

- **Slotted:** 3.0+4.5, 5.5+6.5mm ↔
- ⊕ **Phillips:** #1+2, #0+3 lbs.
- ⊕ **Pozidriv®:** #1+2 .45
- **Square:** #1+2, #0+3
- ⊛ **TORX®:** T10+T15, T20+T25
- ⬢ **Hex Inch:** 1/8+9/64, 5/32+3/16"
- ⬢ **Hex Metric:** 3.0+4.0, 5.0+6.0mm



Technician's

77798 Cushion Grip Ultra Driver 26inOne

Wiha cushion grip handle & CVM tool steel shaft. Locking bit holder. In Clamshell

Includes the following 1/4" double end bits:

- **Slotted:** 3.0+4.5, 4.0+6.0, 5.5+6.5mm ↔
- ⊕ **Phillips:** #1+2, #0+3 lbs.
- ⊕ **Pozidriv®:** #1+2 .45
- **Square:** #1+2, #0+3
- ⊛ **TORX®:** T6+T7, T8+T9, T10+T15, T20+T25, T27+T30



Industrial

77799 Cushion Grip Ultra Driver 26inOne

Wiha cushion grip handle & CVM tool steel shaft. Locking bit holder. In Clamshell

Includes the following 1/4" double end bits:

- **Slotted:** 4.0+6.0mm ↔
- ⊕ **Phillips:** #1+2 lbs.
- ⊛ **TORX®:** T8+T9, T10+T15, T20+T25, T27+T30
- ⬢ **Hex Inch:** 3/32+7/64, 1/8+9/64, 5/32+3/16, 7/32+1/4"
- ⬢ **Hex Metric:** 2.0+2.5, 3.0+4.0, 5.0+6.0mm

Wiha Security Ultra Driver



77796 Security Cushion Grip Ultra Driver

26inOne Wiha cushion grip handle & CVM tool steel shaft. Locking bit holder. In Clamshell

Includes 1/4" double end Security bits:

- ⊕ **Slotted/Phillips:** 5.5mm+#2 ↔
- **Square:** #1+#2 lbs.
- ⊛ **TORX®:** T8s+T9s, T10s+T15s, T20s+T25s, T27s+T30s .45
- ⬢ **Hex Inch:** 1/8+9/64, 5/32+3/16, 7/32+1/4"
- ⬢ **Hex Metric:** 3.0+4.0, 5.0+6.0mm
- ⊕ **Spanner:** #4+#6, #8+#10

Ultra Driver

Bonus Pack



77795 24 Pc. Cushion Grip Ultra Driver

26inOne Bonus Pack Wiha cushion grip handle & CVM tool steel shaft. Locking bit holder.

Includes the following 1/4" double end bits:

- **Slotted:** 3.0+4.5, 4.0+6.0, 5.5+6.5mm lbs.
- ⊕ **Phillips:** #1+2, #0+3 .50
- ⊕ **Pozidriv®:** #1+2
- **Square:** #1+2, #0+3
- ⊛ **TORX®:** T6+T7, T8+T9, T10+T15, T20+T25, T27+T30
- ⬢ **Hex Inch:** 3/32+7/64, 1/8+9/64, 5/32+3/16, 7/32+1/4"
- ⬢ **Hex Metric:** 2.0+2.5, 3.0+4.0, 5.0+6.0mm

1/4" Hex to 1/4" Square Socket Adapter



More Info. on Page 57

26inOne Counter Top Displays!

Wiha SoftFinish® Handle - Ergonomic Cushion Grip

The Wiha SoftFinish® Handle: Featuring advanced technology dual material molding. A remarkable improvement in handle design, comfort and performance. The SoftFinish® ergonomic shape allows maximum torque and user comfort.

Handle is molded directly onto the blade for a permanent bond. Large optimized handle diameter allows higher torque with less user hand fatigue

All blades are made of Wiha's exclusive formula chrome-vanadium-molybdenum tool steel, super hardened & hard chrome finish for unmatched durability



Wiha exclusive "SoftFinish® Zone" features solid molded core with soft outer cushion grip. Requires less force, yet achieves 40% more torque than conventional handles



Wiha SoftFinish® Extra Heavy Duty



530 Slotted Screwdriver, With Wiha-SoftFinish® Handle & Solid Metal Cap

Hex blade extending through handle manufactured from high alloy chrome-vanadium-molybdenum steel, hardened, hard chromed. Wiha-Chromtop finish on tips. Wiha-SoftFinish® handle, multi-component. Hex bolster for additional torque. In Clamshell

Item No.	mm	Inch	mm	Inch	mm	Inch	mm	Inch	mm	Inch	mm	Inch	lbs.	pkg.
53001*	3.5	.139	75	3.0	0.6	.024	4.0	5/32	186	7.3	30	1.18	.16	1
53002*	4.5	.177	90	3.5	0.8	.031	4.0	5/32	201	7.9	30	1.18	.17	1
53003	5.5	.196	100	3.9	1.0	.039	5.0	13/64	213	8.4	36	1.42	.23	1
53004	6.5	.255	125	5.0	1.2	.047	6.0	1/4	238	9.4	36	1.42	.33	1
53005	8.0	.315	150	5.9	1.2	.047	8.0	5/16	268	10.6	41	1.61	.56	1
53006	10.0	.393	175	7.0	1.6	.063	8.0	5/16	293	11.6	41	1.61	.58	1
53007	12.0	.472	200	8.0	2.0	.079	10.0	25/64	318	12.5	41	1.61	.76	1

*No Hex Bolster

Cushion Grip Nut Driver Sets



34193 7 Pcs. Nut Driver Set Inch sizes.

Blade CVM steel, hardened. Deep drawn 1" socket. In Pouch

Item No.	Inch:	lbs.
34193	3/16, 1/4, 5/16, 11/32,	1.89
	3/8, 7/16, 1/2"	



34194 7 Piece Nut Driver Set Metric sizes.

In Pouch

Item No.	Metric:	lbs.
34194	5.0, 5.5, 6.0, 7.0,	1.93
	8.0, 10.0, 13.0mm	

Wiha SoftFinish® Handle - Square Drivers



358 Square Screwdriver, With Wiha-SoftFinish® Handle

Round blade high alloy chrome-vanadium-molybdenum steel, hardened, hard chromed. Wiha-Chromtop finish on tips. Wiha-SoftFinish® handle, multi-component, cushion grips. In Clamshell

Item No.	Size	mm	Inch	mm	Inch	mm	Inch	mm	Inch	lbs.	pkg.
35820	0	80	3.1	4.0	5/32	191	7.5	30	1.18	.11	10
35821	1	100	3.9	4.5	5/32	210	8.2	30	1.18	.12	10
35822	2	150	5.9	6.0	1/4	268	10.5	36	1.42	.19	10
35823	3	150	5.9	6.0	1/4	268	10.5	36	1.42	.22	10

Wiha SoftFinish® Pozidriv®



313 Pozidriv® Screwdriver, With Wiha-SoftFinish® Handle

Round blade high alloy chrome-vanadium-molybdenum steel, hardened, hard chromed. Wiha-Chromtop finish on tips. Wiha-SoftFinish® handle, multi-component, cushion grips. In Clamshell

Item No.	Size	mm	Inch	mm	Inch	mm	Inch	mm	Inch	lbs.	pkg.
31350	0	60	2.4	3.0	.118	164	6.5	23	.91	.06	10
31351	1	80	3.1	4.5	.177	191	7.5	30	1.18	.11	10
31353	2	100	3.9	6.0	.236	218	8.6	36	1.42	.20	10
31354	3	150	5.9	8.0	.315	274	10.8	41	1.61	.33	10

Wiha TORX® SoftFinish® Screwdrivers



362 TORX® Screwdriver, With Wiha-SoftFinish® Handle

Round blade high alloy chrome-vanadium-molybdenum steel, hardened, hard chromed. Wiha-Chromtop finish on tips. Wiha-SoftFinish® handle, multi-component, cushion grips. In Clamshell

Item No.	Size	mm	Inch	mm	Inch	mm	Inch	mm	Inch	lbs.	pkg.
36364	T5	60	2.4	2.5	.098	164	6.5	23	.91	.05	10
36366	T6	60	2.4	3.5	.139	164	6.5	23	.91	.06	10
36368	T7	60	2.4	3.5	.139	164	6.5	23	.91	.06	10
36370	T8	60	2.4	3.5	.139	164	6.5	23	.91	.06	10
36372	T9	60	2.4	4.0	.157	171	6.7	30	1.18	.10	10
36374	T10	80	3.1	4.0	.157	191	7.5	30	1.18	.11	10
36376	T15	80	3.1	4.0	.157	191	7.5	30	1.18	.11	10
36378	T20	100	3.9	4.0	.157	211	8.3	36	1.42	.11	10
36380	T25	100	3.9	4.5	.177	211	8.3	36	1.42	.12	10
36382	T27	115	4.5	5.5	.216	233	9.2	36	1.42	.19	10
36384	T30	115	4.5	6.0	.236	233	9.2	36	1.42	.20	10
36386	T40	130	5.1	7.0	.275	254	10.0	41	1.61	.27	10
36388	T45	130	5.1	8.0	.315	254	10.0	41	1.61	.31	10

Wiha SoftFinish® Sets



35894 4 Pc. SoftFinish® Square Tip

Screwdriver Set Round blade high alloy CVM steel, hardened, hard chromed. In Pouch

Item No.	Size	mm	Size	mm	lbs.	.77
35894	0	80	2	150		
	1	100	3	150		



30289 8 Piece Slotted, Phillips & Square Cushion Grip Drivers In Molded Case

Item No.	Slotted: 3.0, 4.5, 5.5, 6.5mm	Phillips: #1, 2	lbs.
30289	Square: #0, 1		1.69



36291 6 Pc. SoftFinish® TORX®

Screwdriver Set Round blade high alloy CVM steel, hardened, hard chromed. In Pouch

Item No.	Size	lbs.	.77
36291	T6, T7, T8, T9, T10, T15		

Wiha SoftFinish® Bit Holder

Magnetic



Retainer out of stainless steel

38451 1/4" Magnetic Bit Holding Drivers, With Wiha SoftFinish® Handle

Ergonomic cushion grip, magnetic, holds bit and screw. Shaft CVM steel, nickel-plated. In clamshell

Item No.	Size	mm	Inch	mm	Inch	lbs.
38451	1/4"	125	5.0	240	9.46	.23

Switch Cabinet Keys



21103 Switch Cabinet Key For applications with all common switch cabinets & locking systems. Diecast Zinc. In Clamshell

Item No.	mm	Inch	Pkg.	lbs.
21103	76	3.0"	1	.22

Wiha Molded Torpedo Level



61670 Molded Torpedo Level Super light weight, waterproof resistant. 3 glass vials and a magnetic base. In Pouch

Item No.	OAL	lbs.	pkg.
61670	8.0"	.46	1

Long Arm Ball End Hex Keys Black Finish

Long Arm Ball End L-keys

Ball End Hex Keys
Chamfered ends for easy insertion

Ball End Hex L-keys Working angle up to 25°

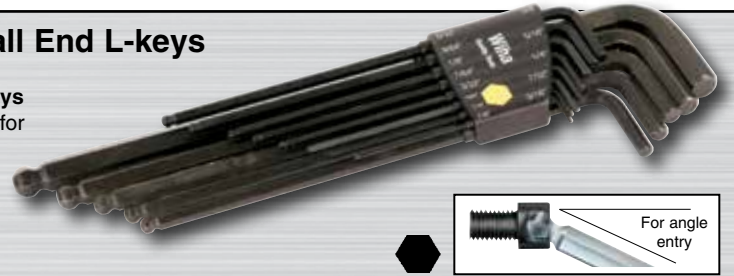

36991 13 Piece Inch Ball End Hex Long L-key Set Blade Chrome-V-Moly, hardened, black finish. In Pouch lbs. 1.0

Item No. 13 pc. set includes:

36991	.050, 1/16, 5/64, 3/32, 7/64, 1/8, 9/64, 5/32, 3/16, 7/32, 1/4, 5/16, 3/8"
-------	--



36990 9 Pc. Metric Ball End Hex Long L-key Set Blade Chrome-V-Moly, hardened, black finish. In Pouch lbs. .98

Item No. Metric: 1.5, 2.0, 2.5, 3.0, 4.0, 5.0, 6.0, 8.0, 10.0mm

Wiha Long Life Maxiflex Folding Rulers

Patented play free joint with steel spring pin, wear resistant & maintenance free

90° positive stop joints

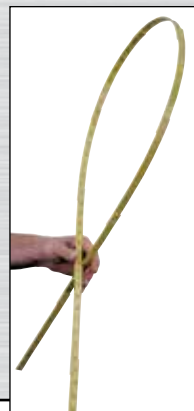

Reinforced with 30% fiberglass, rugged polyimide is scratch resistant

Deep embossed water proof scales

Tough and Flexible, impact resistant

Chemical and weather resistant for outdoor use

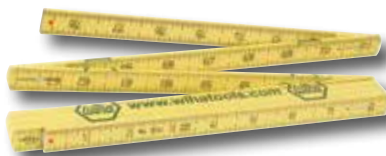

61662 Combination Metric & Inch Long Life MaxiFlex Folding Rulers

Molded 30% fiber glass reinforced polyimide scratch, chemical and weather resistant both tough & flexible, impact resistant.

Patented play free joint with steel spring is wear & maintenance free. Metric rules have 10cm red marking. In Clamshell Pkg. 1

Item No. Meter Inch Width Sections Increments lbs.

61662	2	78"	15mm	10	1/16 & 1mm	.31
-------	---	-----	------	----	------------	-----

Ball End Hex Keys Black Finish Short Arm

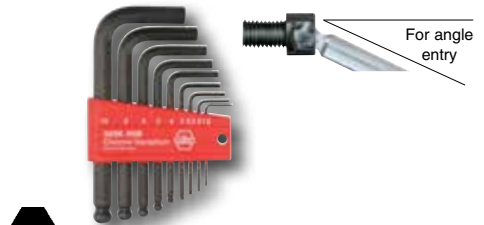

For angle entry

36989 9 Pc. Short Arm Metric Ball End Hex L-key Set, In Plastic Holder Includes: 1.5, 2.0, 2.5, 3.0, 4.0, 5.0, 6.0, 8.0, 10.0mm lbs. .59 pkg. 1

MagicRing Ball End Hex Keys

ErgoStar Holder
Every key can be taken out separately without having to move another key



Ball End Hex Keys
Chamfered ends for easy insertion

Ball End Hex Keys
Wiha exclusive CV-Moly super tool steel, hardened, hard chromed, screw holding

Screw Holding Hex Tools!



U.S. Patent 6,302,001 B1



66991 13 Pc. MagicRing Long Inch Ball End Hex L-key Set, In ErgoStar Holder
Blade Chrome-V-Moly, hardened, hard chrome finish. In Clamshell

Item Inch: .050*, 1/16*, 5/64*, 3/32*,
No. 7/64*, 1/8, 9/64, 5/32, 3/16, 7/32,
66991 1/4, 5/16, 3/8"
lbs. 1.14

* Standard Ball - No Ring



66990 9 Pc. MagicRing Long Metric Ball End Hex L-key Set, In ErgoStar Holder
Blade Chrome-V-Moly, hardened, hard chrome finish. In Clamshell

Item No. Metric: 1.5*, 2.0*, 2.5*, 3.0, 4.0,
66990 5.0, 6.0, 8.0, 10.0mm
lbs. 1.07

* Standard Ball - No Ring



66992 22 Pc. Combination MagicRing L-key Set, In ErgoStar Holder
Item No. Set includes Inch & Metric:
66992 66990 Set - 1.5*, 2.0*, 2.5*, 3.0, 4.0,
5.0, 6.0, 8.0, 10.0mm
lbs. 66991 Set - .050*, 1/16*, 5/64*,
2.21 3/32*, 7/64*, 1/8, 9/64, 5/32, 3/16,
7/32, 1/4, 5/16, 3/8"



* Standard Ball - No Ring

Metric Ball End Hex Keys Chrome Finish

66994 9 Piece Metric Ball End Hex Long L-key Set
Blade Chrome-V-Moly, hardened, hard chrome finish. In Clamshell

Item No. Metric: 1.5, 2.0, 2.5, 3.0, 4.0,
66994 5.0, 6.0, 8.0, 10.0mm
lbs. .98

For angle entry

36998 13 Pc. Inch Ball End Hex Long L-key Set, In Plastic Holder
Blade Chrome-V-Moly, hardened, hard chrome finish.

Item No. .050, 1/16, 5/64, 3/32, 7/64, 1/8,
36998 9/64, 5/32, 3/16, 7/32, 1/4, 5/16, 3/8"
lbs. 1.0

Inch & Metric Ball End Hex Keys Color Coded

Wiha standard extra long for extended reach

Wiha exclusive Chrome-V-Moly super tool steel, through hardened

25° Working Angles

Corrosion resistant nickel chrome base finish

Color coding for immediate identification of L-keys

25° Angle

For angle entry

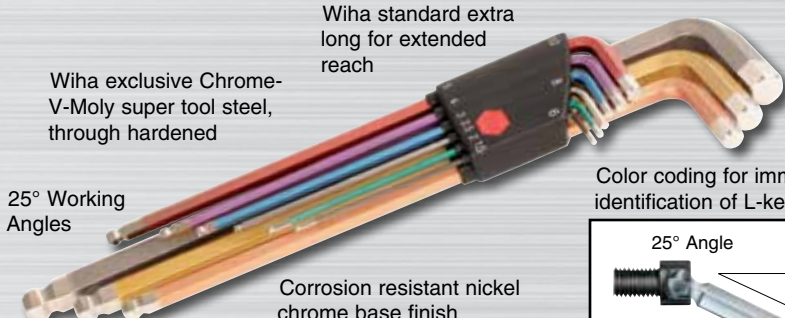
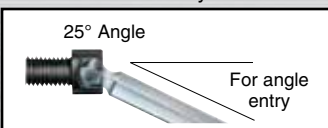
36986 13 Piece Inch Ball End Hex Long L-key Set With Color Coded Keys
Chrome-V-Moly, hardened. In Pouch

Item No. Inch: .050, 1/16, 5/64, 3/32, 7/64,
36986 1/8, 9/64, 5/32, 3/16, 7/32, 1/4,
5/16, 3/8"
lbs. 1.08

ErgoStar Ball End Hex Keys Chrome Finish



66996 9 Piece ErgoStar Metric Ball End Hex Long L-key Set In Clamshell
Item No. Metric: 1.5, 2.0, 2.5, 3.0, 4.0, 5.0,
66996 6.0, 8.0, 10.0mm
lbs. 1.02

Fast Auto Open Key Holder



66988 13 Piece ErgoStar Inch Ball End Hex Long L-key Set In Clamshell
Item No. .050, 1/16, 5/64, 3/32, 7/64, 1/8,
66988 9/64, 5/32, 3/16, 7/32, 1/4, 5/16, 3/8"
lbs. 1.08

Fast Auto Open Key Holder



66982 22 Pc. ErgoStar Inch/Metric Ball End Hex Long L-key Set In Pouch
Item No. Inch: .050, 1/16, 5/64, 3/32, 7/64, 1/8,
66982 9/64, 5/32, 3/16, 7/32, 1/4, 5/16, 3/8"
lbs. Metric: 1.5, 2.0, 2.5, 3.0, 4.0, 5.0,
2.1 6.0, 8.0, 10.0mm



36987 9 Piece Metric Ball End Hex Long L-key Set With Color Coded Keys
Chrome-V-Moly, hardened. In Pouch

Item No. Metric: 1.5, 2.0, 2.5, 3.0, 4.0,
36987 5.0, 6.0, 8.0, 10.0mm
lbs. .96



36987 9 Piece Metric Ball End Hex Long L-key Set With Color Coded Keys
Chrome-V-Moly, hardened. In Pouch

Item No. Metric: 1.5, 2.0, 2.5, 3.0, 4.0,
36987 5.0, 6.0, 8.0, 10.0mm
lbs. .96

Wiha PocketStar Fold-Ups

MagicRing Screw Holding



36997 9 Pc. MagicRing Inch PocketStar Fold Outs High alloy CVM steel, hardened, molded ergonomic handle. In Pouch

Item No. 36997 lbs.

Inch PocketStar: 5/64*, 3/32*, 7/64* lbs.
1/8, 9/64, 5/32, 3/16, 7/32, 1/4" .46

* Standard Ball - No Ring



36996 7 Pc. MagicRing Metric PocketStar Fold Outs High alloy CVM steel, hardened, molded ergonomic handle. In Pouch

Item No. Metric: lbs. .50

36996 2.0*, 2.5*, 3.0, 4.0, 5.0, 6.0, 8.0mm

* Standard Ball - No Ring

Wiha MagicRing Screw Holding T-handle



54090 5 Piece MagicRing Ball End T-handle Set, Metric Sizes

Blade Chrome-V-Moly, hardened, hard chromed. Wiha T-handle high quality plastic, impact resistant. In Clamshell

Item No.	Metric:	lbs.
54090	4.0, 5.0, 6.0, 8.0, 10.0mm	1.49



54091 6 Piece MagicRing Ball End T-handle Set, Inch Sizes

Blade Chrome-V-Moly, hardened, hard chromed. Wiha T-handle high quality plastic, impact resistant. In Clamshell

Item No.	Inch:	lbs.
54091	1/4, 5/16, 3/8"	1.59

Hex L-keys - Short Arm



35192 8 Piece Inch Hex L-key Set, In Plastic Holder Equipped with 5/64, 3/32, 1/8, 5/32, 3/16, 7/32, 1/4, 5/16". In Clamshell

lbs. .41 pkg. 1

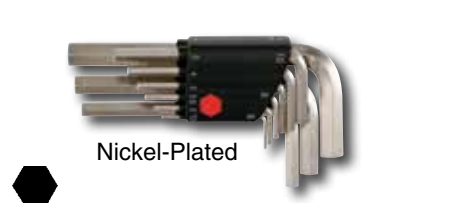

35191 9 Piece Metric Hex L-key Set, In Plastic Holder Equipped with 1.5, 2.0, 2.5, 3.0, 4.0, 5.0, 6.0, 8.0, 10.0mm. In Pouch

lbs. .59 pkg. 1

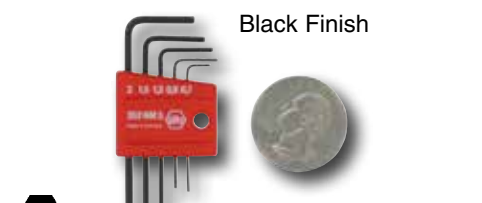

35392 5 Pc. Mini Metric Hex L-key Set Equipped with 0.7, 0.9, 1.3, 1.5, 2.0mm

lbs. .03 pkg. 1 In Clamshell

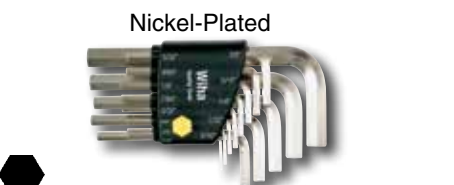

35194 13 Piece Inch Hex L-key Set, In Plastic Holder Equipped with .050 - 3/8" In Pouch

lbs. .72 pkg. 1



35193 6 Piece Metric Hex L-key Set, In Plastic Holder Equipped with 1.5, 2.0, 2.5, 3.0, 4.0, 5.0mm. In Clamshell

lbs. .20 pkg. 1

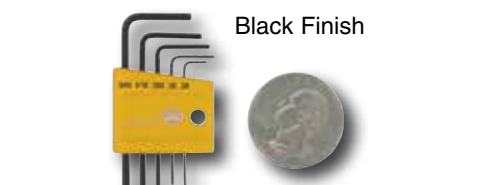

35393 5 Pc. Mini Inch Hex L-key Set Equipped with .028, .035, .050, 1/16, 5/64"

lbs. .03 pkg. 1 In Clamshell

TORX® Short Arm L-keys



36392 TORX® Set, 7 Pc. In Plastic Holder
Equipped with T6, T7, T8, T9, T10, T15, T20
In Clamshell

Item		
No.	lbs.	pkg.
36392	.10	1

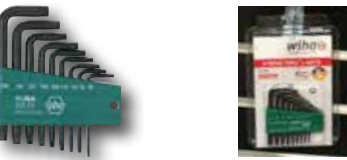

36394 TORX® Set, 9 Pc. In Plastic Holder
T8, T9, T10, T15, T20, T25, T27, T30, T40
In Clamshell

Item		
No.	lbs.	pkg.
36394	.30	1

Wiha ErgoStar Ball End TORX® Long L-keys



36689 ErgoStar TORX® Long Arm Set, 13 Pc. In Molded Holder Equipped with T5, T6, T7, T8, T9, T10, T15, T20, T25, T27, T30, T40, T45. In Pouch

Item No.		lbs.		pkg.
36689		1.08		1



36692 Ball End TORX® L-key Set, 8 Pc. in Plastic Holder Equipped with T9, T10, T15, T20, T25, T27, T30, T40. In Pouch

Item		
No.	lbs.	pkg.
36692	6.16	1

TORX® Long Arm L-keys



36699 Long Arm TORX® Set, 13 Pc. in Molded Holder Equipped with T5, T6, T7, T8, T9, T10, T15, T20, T25, T27, T30, T40, T50

Item No.		lbs.		In
36699		1.13	1	Pouch



36698 Long Arm TORX® Set, 10 Pc. In Molded Holder Equipped with T6, T7, T8, T9, T10, T15, T20, T25, T27, T30. In Pouch

Item No.		lbs.		pkg.
36698		1.04		1

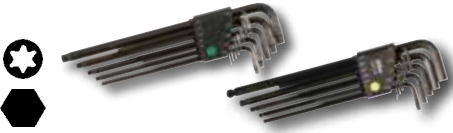

36694 26 Piece Combo Pack Long Arm TORX® And Hex Inch L-key Sets
Set includes: 36699-13pc set T5-T50 and 36991-13pc set .050 - 3/8". In Pouch

Item No.		lbs.		pkg.
36694		2.13		1

Wiha "Rust Free" Finish TORX® L-keys

Pacified Zinc Chromate Finish
96 hour salt bath tested for best corrosion protection



36693 TORX® Long Arm Set, 13 Pc. In ErgoStar Molded Holder Equipped with T5, T6, T7, T8, T9, T10, T15, T20, T25, T27, T30, T40, T45. In Clamshell

Item No.		lbs.		pkg.
36693		1.10		1

Wiha PocketStar Fold Outs



Push button key release



Blade length range 1.68 - 1.94"



36396 TORX® PocketStar Fold Outs, 7 Pc. Set High alloy CVM steel, hardened, molded ergonomic handle. OAL 3.8". In Pouch

Item No.		lbs.	pkg.
36396		.22	
			T7, T8, T9, T10, T15, T20, T25



Push button key release



Blade length range 1.95 - 2.39"



36398 TORX® PocketStar Fold Outs, 8 Pc. Set High alloy CVM steel, hardened, molded ergonomic handle. OAL 4.74". In Pouch

Item No.		lbs.	pkg.
36398		.24	
			T9, T10, T15, T20, T25, T27, T30, T40

Wiha Pop-Up Counter Displays



#28394



#38041

Order 18 Pop-Ups and get a FREE Counter Top Display Holder

Wiha Precision Counter Displays



92170 Slotted & Phillips Precision Counter Display Each display holds 50 Precision screwdrivers. Includes 5 of each Slotted 1.0, 1.5, 2.0, 2.5, 3.0, 3.5mm & 5 of each Phillips #000, #00, #0, #1. In metal stand.

Item No.	Qty	Counter Display
92170	50	14.0 x 9.75 x 3.75

92160 TORX® Precision Counter Display Each display holds 50 Precision screwdrivers. Includes 5 of each TORX® T3, T4, T5, T6, T7, T8, T9, T10, T15, T20. In metal stand.

Item No.	Qty	Counter Display
92160	50	14.0 x 9.75 x 3.75

92152 Insulated Pop-Up SlimLine Counter Display

Counter Display

Each Pop-Up Holds 6 SlimLine Blades In Slotted 3.0, 4.0mm, Phillips #1, #2 & Square #1, #2 (#28394 packaged)

Item No.	Qty	Counter Display
92152	18	19.5x17.25x11

Item No.	Qty	Description
28394	1	Pop-Up SlimLine "Residential" Blade Holder In Clamshell

92150 Pop-Up 12inOne Counter Display

Each Pop-Up Holds 12 Insert 1/4" Bits In Slotted 4.5, 6.0mm, Phillips #1, #2, Square #1, #2, Hex 4.0, 5.0, 6.0mm & TORX® T20, T25, T30 (#38041 packaged)

Item No.	Qty	Counter Display
92150	18	19.5x17.25x11

Item No.	Qty	Description
38041	1	Pop-Up 12inOne Bit Holder In Clamshell

Wiha Insulated SlimLine Counter Top Display



32079 30 Pc. Insulated SlimLine Slotted & Phillips Screwdriver Display. Meets ASTM, VDE, EN/IEC, NFPA70E & CSA Specs, Tested to 10,000Volts. SlimLine blades have up to 33% narrower insulation diameter than standard insulated tools. High quality CV steel, through hardened.

Item No.	Qty	Description
32079	6 of each:	<ul style="list-style-type: none"> Slotted: 3.5, 4.5, 5.5mm Phillips: #1, #2

Refills For Insulated SlimLine Display

Item No.	6 Pack Refills
32060	6 Slotted: 3.5mm
32062	6 Slotted: 4.5mm
32063	6 Slotted: 5.5mm
32148	6 Phillips: #1
32149	6 Phillips: #2

Additional Drivers For SlimLine Display

Item No.	6 Pack Refills
32061	6 Slotted: 4.0mm
32064	6 Slotted: 6.5mm
30750	6 Terminal Xeno: #1
30751	6 Terminal Xeno: #2
35847	6 Square: #1
35848	6 Square: #2

26inOne! Ultra Driver Displays



30 Pc. Display
"Tradesman"

97790 30 Ultra Drivers Display

Wiha cushion grip handle & CVM tool steel shaft. Locking bit holder.

Item No. 97790

Tradesman 1/4" Double End Bits:

- **Slotted:** 3.0+4.5, 5.5+6.5mm
- ⊕ **Phillips:** #1+2, #0+3
- ⊕ **Pozidriv®:** #1+2
- ◻ **Square:** #1+2, #0+3
- ⊗ **TORX®:** T10+T15, T20+T25
- ⬢ **Hex Inch:** 1/8+9/64, 5/32+3/16"
- ⬢ **Hex Metric:** 3.0+4.0, 5.0+6.0mm



30 Pc. Display
"Technician's"

97791 30 Ultra Drivers Display

Wiha cushion grip handle & CVM tool steel shaft. Locking bit holder.

Item No. 97791

Technician's 1/4" Double End Bits:

- **Slotted:** 3.0+4.5, 4.0+6.0, 5.5+6.5mm
- ⊕ **Phillips:** #1+2, #0+3
- ⊕ **Pozidriv®:** #1+2
- ◻ **Square:** #1+2, #0+3
- ⊗ **TORX®:** T6+T7, T8+T9, T10+T15, T20+T25, T27+T30



30 Pc. Display
"Industrial"

97792 30 Ultra Drivers Display

Wiha cushion grip handle & CVM tool steel shaft. Locking bit holder.

Item No. 97792

Industrial 1/4" Double End Bits:

- **Slotted:** 4.0+6.0mm
- ⊕ **Phillips:** #1+2
- ⊗ **TORX®:** T8+T9, T10+T15, T20+T25, T27+T30
- ⬢ **Hex Inch:** 3/32+7/64, 1/8+9/64, 5/32+3/16, 7/32+1/4"
- ⬢ **Hex Metric:** 2.0+2.5, 3.0+4.0, 5.0+6.0mm



No Hassle Guarantee

Wiha branded tools are regarded as the most durable, best designed and highly innovative products around. Our tools are used by demanding professional tradespeople and tool aficionados alike. They are meant to be used and utilized often. However, if you are not happy for any reason return them within 12 months of purchase with proof of purchase and we will **Repair** or **Replace**.

Rest assured, if for some reason there is a defect in material or workmanship we will replace your tool free of charge for as long as you own the tool.

Failures due to misuse, abuse or normal wear and tear are not covered by this guarantee. We stand by our products with what we believe is the best **No Hassle Guarantee** in the industry.

Exclusions

Wiha Tools has the right to exclude Bits, Tweezers and Ceramic Screwdrivers. These products are either consumable or wear easily.

All torque tools are designed for 5,000 cycles or 1 year (whichever comes first). If a tool becomes out of specification within that period Wiha Tools will **Repair** or **Replace**. Visit www.wihatools.com to learn more about our Torque Control Service Program.

Legal

Some areas do not allow the exclusion or limitation of incidental or consequential damages, so the above limitation or exclusion may not apply to you. This guarantee gives you specific rights, and you may also have other rights, which vary, from state to state, province to province, or country to country.

This **No Hassle Guarantee** is the sole and exclusive guarantee for the Willi Hahn Corporation dba Wiha Tools. No employee, agent, dealer, or other person is authorized to alter this guarantee or make any other guarantees on behalf of Wiha Tools.

Willi Hahn Corporation USA
Attn: No Hassle Guarantee
1348 Dundas Circle
Monticello, MN 55362

Numerical Index by Item Number

Item No.	Page	Item No.	Page	Item No.	Page	Item No.	Page	Item No.	Page	Item No.	Page
10250	21	30245	50	31142	50	32621	29	32810	20	35822	51
15000	6	30247	50	31143	50	32623	29	32814	19	35823	51
15003	6	30249	50	31144	50	32625	29	32816	19	35844	10
15050	6	30250	50	31145	50	32630	29	32818	19	35845	10
20093	6	30251	50	31146	50	32631	28	32820	19	35847	10,56
20192	6	30252	50	31147	50	32633	29	32821	19	35848	10,56
21103	52	30253	50	31148	50	32635	30	32826	19	35890	13
25505	13	30254	50	31149	50	32636	28	32828	19	35891	13
25511	13	30256	50	31190	50	32637	30	32830	20	35894	51
26090	41	30257	50	31191	50	32638	28	32831	18	36291	51
26092	41	30258	50	31350	51	32639	28	32832	20	36364	51
26099	41	30259	50	31351	51	32640	31	32833	18	36366	51
26190	41	30260	50	31353	51	32641	31	32834	20	36368	51
26192	41	30261	50	31354	51	32642	28	32835	20	36370	51
26194	41	30262	50	32046	10	32644	31	32836	20	36372	51
26197	41	30263	50	32049	10	32645	30	32837	18	36374	51
26199	41	30264	50	32052	10	32646	29	32838	20	36376	51
26390	42	30266	50	32055	10	32647	32	32841	19	36378	51
26391	42	30267	50	32058	10	32648	31	32856	17	36380	51
26399	42	30268	50	32060	10,56	32649	29	32857	17	36382	51
26631	41	30269	50	32061	10,56	32650	32	32858	17	36384	51
26491	42	30270	50	32062	10,56	32651	32	32860	19	36386	51
26499	42	30271	50	32063	10,56	32652	29	32861	20	36388	51
26761	42	30272	50	32064	10,56	32653	31	32862	18	36392	55
26762	42	30289	51	32079	10,56	32655	31	32863	18	36394	55
26763	42	30291	50	32085	9	32657	30	32864	18	36396	55
26764	42	30294	50	32088	9	32658	30	32865	17	36398	55
26765	42	30746	10	32089	13	32659	30	32870	20	36689	55
26766	42	30747	10	32090	12	32660	30	32872	15	36692	55
26790	42	30750	10,56	32091	12	32661	30	32873	15	36693	55
26791	42	30751	10,56	32092	13	32664	30	32874	17	36694	55
26792	42	30770	11	32105	12	32665	30	32878	17	36698	55
26794	42	30901	24	32145	10	32675	32	32917	22	36699	55
26799	42	30903	24	32146	10	32698	31	32923	22	36986	53
26810	41	30905	24	32148	10,56	32699	32	32926	22	36987	53
27290	39	30907	24	32149	10,56	32702	35	32927	22	36989	52
27390	39	30909	24	32189	11	32703	35	32929	22	36990	52
27393	39	30911	25	32196	11	32704	35	32930	22	36991	52
27399	39	30912	24	32291	11	32705	35	32933	22	36993	52
27590	39	30913	25	32292	11	32706	35	32936	23	36996	54
27591	39	30915	25	32366	14	32708	35	32938	22	36997	54
27790	40	30917	25	32390	23	32710	36	32939	22	36998	53
27791	40	30919	25	32512	10	32711	36	32942	23	38032	48
27894	39	30921	25	32513	10	32712	36	32944	23	38041	48
27899	39	30923	24	32514	10	32714	36	32945	22	38043	47
27920	40	30925	24	32515	10	32716	36	32947	23	38048	47
28301	8	30926	24	32517	10	32718	36	32951	21	38050	15
28302	8	30927	24	32518	10	32720	36	32954	21	38051	15
28304	8	30928	24	32519	10	32721	36	32956	21	38451	51
28372	9	30929	24	32596	11	32724	37	32977	23	40010	40
28373	9	30931	24	32600	29	32726	37	32981	23	44216	27
28390	8	30933	24	32602	29	32728	37	32982	21	44219	25
28391	8	30936	25	32603	28	32732	37	32983	23	53001	49
28392	8	30937	27	32604	30	32734	37	32984	23	53002	49
28393	8	30939	25	32605	30	32742	37	32985	21	53003	49
28394	8	30940	24	32606	28	32744	38	33478	7	53004	49
28395	8	30941	26	32607	29	32746	38	33490	7	53005	49
28740	7	30942	26	32609	28	32748	38	33532	12	53006	49
28741	7	30943	27	32611	27	32750	38	34193	49	53007	49
28742	7	30947	25	32612	28	32752	38	34194	49	54090	54
28750	7	30960	26	32613	28	32760	38	35191	54	54091	54
28751	7	30961	26	32614	29	32762	38	35192	54	56801	34
28752	7	30963	26	32615	28	32800	16	35193	54	56812	34
28791	7	30964	27	32616	28	32801	16	35194	54	56813	34
28792	7	30965	27	32617	29	32804	20	35392	54	56815	34
28795	7	30969	26	32618	29	32806	20	35393	54	56818	34
30241	50	30993	27	32619	30	32807	20	35820	51	56825	34
30243	50	31141	50	32620	29	32808	20	35821	51	56830	34

Item No.	Page	Item No.	Page	Item No.	Page	Item No.	Page	Item No.	Page	Item No.	Page
56833	34	76556	45	92064	14	96535	43				
56871	25	76557	45	92065	14	96536	43				
57810	33	76558	45	92066	14	96539	43				
57812	33	76559	45	92067	14	96540	43				
57814	33	76563	45	92068	14	96545	43				
57816	33	76564	45	92069	14	96547	43				
57818	33	76565	45	92070	14	96550	43				
57820	33	76566	45	92071	14	96555	43				
57872	27	76570	45	92072	14	96556	43				
61630	21	76571	45	92073	14	96560	43				
61662	52	76572	45	92075	13	96563	43				
61670	52	76573	45	92076	13	96570	43				
66982	53	76574	45	92077	13	97790	57				
66988	53	76575	45	92078	13	97791	57				
66990	53	76578	45	92079	14	97792	57				
66991	53	76579	45	92080	14						
66992	53	76580	45	92081	14						
66994	53	76890	44	92082	14						
66996	53	76891	44	92150	56						
71090	46	76892	44	92152	56						
71990	47	76893	44	92160	56						
71994	47	76894	44	92170	56						
74996	47	76895	44	96008	43						
75093	40	76896	44	96010	43						
75094	40	77795	48	96012	43						
75095	40	77796	48	96015	43						
75096	40	77797	48	96018	43						
75097	40	77798	48	96020	43						
76000	47	77799	48	96025	43						
76098	47	79243	46	96030	43						
76208	6	79248	46	96035	43						
76210	6	79443	46	96040	43						
76212	6	79490	46	96100	43						
76501	45	79491	46	96102	43						
76502	45	79493	46	96105	43						
76503	45	79495	46	96110	43						
76506	45	79499	46	96307	43						
76507	45	91450	5	96309	43						
76508	45	92000	12	96313	43						
76510	45	92002	12	96315	43						
76511	45	92004	12	96316	43						
76512	45	92005	12	96320	43						
76513	45	92006	12	96323	43						
76514	45	92008	12	96325	43						
76516	45	92010	12	96327	43						
76517	45	92014	12	96330	43						
76523	45	92016	12	96331	43						
76524	45	92018	12	96413	43						
76525	45	92020	12	96415	43						
76526	45	92022	12	96416	43						
76530	45	92024	12	96419	43						
76531	45	92026	12	96420	43						
76532	45	92028	12	96423	43						
76533	45	92031	12	96425	43						
76534	45	92033	12	96427	43						
76535	45	92035	12	96430	43						
76538	45	92038	12	96431	43						
76539	45	92040	12	96436	43						
76540	45	92043	13	96439	43						
76543	45	92045	13	96510	43						
76544	45	92050	14	96515	43						
76545	45	92052	14	96520	43						
76548	45	92054	14	96523	43						
76549	45	92056	14	96525	43						
76550	45	92058	14	96527	43						
76553	45	92060	14	96530	43						
76554	45	92062	14	96531	43						
76555	45	92063	14	96532	43						

 **Prop65 WARNING:** This product could expose you to chemicals including Vinyl Chloride, Ethylene Glycol, Ni or CrVI, which are known to the state of California to cause cancer or reproductive harm. For more information go to www.P65warnings.ca.gov/



Wiha Tools Canada Ltd.

www.wihatools.ca
 Brampton, ONT L6T 4X4
 tel: 866.494.0096 or 763.295.6591
 fax: 763.295.6598

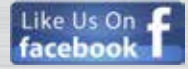

Subject to change without notice

©2018 Willi Hahn Corporation

©Torx is a registered trademark of Acument Intellectual Properties LLC.

Catalog Item No. 99007.C
 version - 11/15/18



Wiha Quality Tools

1348 Dundas Circle
 Monticello, MN 55362
 tel: 763.295.6591
 fax: 763.295.6598

Wiha Tools Canada Ltd.

www.wihatools.ca
 Brampton, ONT L6T 4X4
 tel: 866.494.0096 or 763.295.6591
 fax: 763.295.6598

To:

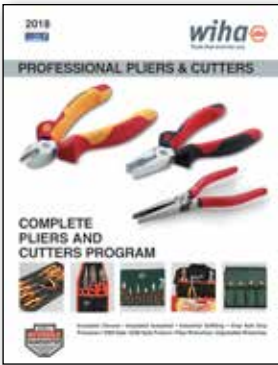

99977.w0 - Pliers/Crimpers Catalog



99004.w0 - Shop Tools Catalog



99914.w0 - TORX Catalog



99951.w0 - Bits Catalog



99002.w0 - Screwdrivers Catalog



99934.w0 - Hex Tools Catalog



99001.w0 - TorqueControl Catalog



99006.w0 - Tech Tools Catalog



99945.w0 - ESD Catalog



91330.w0 - Tooling Catalog

2018 Wiha Manufacturing Catalog