

PD9000 ConsoliDator+ Multivariable Controller Instruction Manual



ConsoliDator+

Multi-Channel Controller

- NEMA 4X Panel or Field Mount Multi-Channel Controller
- Convenient Display, Control, & Alarm of Multiple 4-20 mA & Pulse Inputs
- Numeric & Bargraph Color Display (320 x 240 px) 5.7" (145 mm)
- Sunlight Readable Display, White Backlight
- Isolated 24 VDC Transmitter Supplies 200 mA / Analog Input; 1,600 mA Max
- 99 Channels, 32 Totalizers, 32 Timers, & 199 Modbus Slave Inputs
- 64 High & Low Alarms assigned to up to 25 Relays with AND/OR Logic
- Modular Design for Input & Output Flexibility
- Up to (28) 4-20 mA Isolated Inputs or Pulse Inputs
- Up to (25) 10 Amp Form C Relays (With Eight Analog or Pulse Inputs)
- Up to (25) Isolated 4-20 mA Outputs (With Eight Analog or Pulse Inputs)
- Operating Temperature Range: -40 to 60°C (-40 to 140°F)
- Pulse, Analog, & Modbus Input Flow Rate / Total / Grand Total Capability
- 50-Point Linearization, Square Root, and Exponent for Open Channel Flow
- Round Horizontal Tank Volume Calculation; Just Enter Diameter & Length
- Multi-Pump Alternation Control or Simple On / Off Control
- Programmable Displays, Function Keys & Digital Inputs
- Math Functions: Sum, Diff, Average, Multiply, Divide, % Efficiency, & More
- Display Direct Modbus PV Inputs – Slave Mode
- RS-485 Modbus RTU Standard & Ethernet Modbus TCP/IP Optional
- Free ConsoliDator+ Configuration Software
- 3 Year Warranty

PRECISION DIGITAL CORPORATION



233 South Street • Hopkinton MA 01748 USA
Tel (800) 343-1001 • Fax (508) 655-8990

**PRECISION
DIGITAL**

www.predig.com

Disclaimer

The information contained in this document is subject to change without notice. Precision Digital makes no representations or warranties with respect to the contents hereof and specifically disclaims any implied warranties of merchantability or fitness for a particular purpose.

	
<p>CAUTION: <i>Read complete instructions prior to installation and operation of the meter.</i></p>	<p>WARNING: <i>Risk of electric shock or personal injury.</i></p>

 <p>Warning!</p>	<p><i>This product is not recommended for life support applications or applications where malfunctioning could result in personal injury or property loss. Anyone using this product for such applications does so at his/her own risk. Precision Digital Corporation shall not be held liable for damages resulting from such improper use.</i></p>
--	--

Limited Warranty

Precision Digital Corporation warrants this product against defects in material or workmanship for the specified period under “Specifications” from the date of shipment from the factory. Precision Digital’s liability under this limited warranty shall not exceed the purchase value, repair, or replacement of the defective unit.

Registered Trademarks

Modbus® is a Registered Trademark of Schneider Automation Inc. All other trademarks mentioned in this document are the property of their respective owners.

© 2019 Precision Digital Corporation. All rights reserved.

www.predig.com

Table of Contents

INTRODUCTION	5	Channel Parameters	27
ORDERING INFORMATION	5	Data Entry Keypad	28
SPECIFICATIONS	8	Setup Channels	29
General	8	Create New Channel	30
Totalizer	9	Delete Channel	31
Channel & Math Functions	10	Setup Math Functions.....	35
List of Engineering Units	10	Setup Totalizers.....	36
4-20 mA Analog Inputs	11	Setup Timers	37
Pulse Inputs	11	Setup Alarms	38
Modbus Inputs	11	Setup Inputs	40
Digital Inputs & Outputs	12	Setup Modbus Inputs.....	42
Relays	12	Setup All Outputs.....	43
4-20 mA Transmitter Outputs	13	Setup Screens	47
Timers	13	Screens Settings.....	47
Modbus® Serial Communications	13	Setup System	49
Ethernet Communications	13	Modbus Settings.....	49
ConsoliDator+ Software	13	General Settings.....	49
SAFETY INFORMATION	14	Display Settings.....	49
INSTALLATION	14	Set Password	50
Unpacking.....	14	Password Protected Controller.....	50
OVERALL DIMENSIONS	15	Remove Password Protection	50
Panel Mounting (-GP & -GH Models)	16	ETHERNET PORT SETUP	51
Wall Mounting Instructions (-FG & -FH Models) ..	17	Test Ethernet Communication	53
Optional Internal Mounting Plate for Field Enclosure	18	View Menu	54
Pipe Mounting	18	View Channel Details.....	54
Conduit Connections	19	View Totals	55
Sun Hood for ConsoliDator+	19	View Timers	56
Tamper Proof Enclosure	19	View Alarms	57
Connections	20	View Inputs	58
Power Connections	21	View Outputs	59
Analog Output Connections	22	View Screens.....	60
Digital Output Connections	22	OPERATION	61
Serial Communication Connections	23	Viewing Screens	61
External Keypad Connections	23	Individual Channel View	61
NAVIGATING AND EDITING	24	Low & High Alarm Indication.....	61
Soft-Keys and Buttons	24	MODBUS® RTU SERIAL COMMUNICATION .	62
SETUP AND PROGRAMMING	25	Modbus Register Tables	62
Overview	25	Register Numbers & Addresses	63
SETUP MENU	26	Relay Control Via Modbus	64
		TROUBLESHOOTING TIPS	65

Table of Figures

Figure 1. Panel Mount Overall Dimensions	15	Figure 19. 3-Wire Transmitters Powered Externally	21
Figure 2. Field Mount Overall Dimensions	15	Figure 20. Flow Meter Pulse Input Connections	22
Figure 3. Front Panel Mount Dimensions	16	Figure 21. Digital Input from Switch Closure and Live Signal	22
Figure 4. Panel Cutout Dimensions.....	16	Figure 22. Active 4-20 mA Output Powered by Controller	22
Figure 5. Panel Mount Installation.....	16	Figure 23. Passive 4-20 mA Output Powered by External Supply.....	22
Figure 6. Wall & Pipe Mounting Dimensions	17	Figure 24. Digital Outputs Driving 5V Solid State Relay.....	22
Figure 7. Wall Mount & Internal Boss Dimensions	17	Figure 25. Relay Connections	23
Figure 8. Mounting Plate Dimensions	18	Figure 26. AC and DC Internal Inductive Loads Protection	23
Figure 9. Clearance Inside Field Enclosure	18	Figure 27. Low Voltage DC Loads Protection	23
Figure 10. Pipe Mounted Field Controller.....	18	Figure 28. Serial Connections	23
Figure 11. Conduit Hole Punch Mark Locations.....	19	Figure 29. External Keypad Connections	23
Figure 12. Sun Hood for ConsoliDator+	19	Figure 30. Linear Response Graph.....	32
Figure 13. Sun Hood Installed on Field Mount Controller.....	19	Figure 31. Square Root Response Graph	32
Figure 14. Clasp on Side of the Enclosure	19	Figure 32. Exponent Response Graph	33
Figure 15. Connection Terminals for a PD9000-GP-4PI-8AI-10AO-10RY	20	Figure 33. Total Relay Sampling Operation.....	33
Figure 16. Power Connections.....	21	Figure 34. Round Horizontal Tank Volume Graph.....	34
Figure 17. Transmitters Powered by ConsoliDator+'s Isolated 24 VDC Power Supply	21		
Figure 18. Transmitter Powered by Ext. Supply or Self-Powered	21		

Introduction

The ConsoliDator+ is a multi-channel controller that is both easy to use and satisfies a wide variety of process display, alarm and control applications. It accepts 4-20 mA inputs, flow meter pulse inputs, digital inputs, and Modbus RTU inputs and displays them both in numeric and bargraph format on a large, 5.7" color display. It can be equipped with multiple relays with user-definable actions, 4-20 mA outputs, digital outputs, Modbus RTU, and Ethernet Modbus TCP/IP protocol communication capabilities. Additionally, the controller is equipped with up to 32 timers that can be used to control many processes or events.

All this functionality is easily programmed using free software or via the front panel pushbuttons. Choose the model that best suits your application, from monitoring only to fully loaded controllers with an extensive combination of inputs, outputs and communication protocols. The standard product offering is listed below, and other models are available for special order.

Ordering Information

General Purpose Panel Mount Models				
Model	Pulse Inputs	4-20 mA Inputs	4-20 mA Outputs	Relays
PD9000-GP-4AI	0	4	0	0
PD9000-GP-4AI-10RY	0	4	0	10
PD9000-GP-4AI-5AO-10RY	0	4	5	10
PD9000-GP-4AI-20RY	0	4	0	20
PD9000-GP-4AI-5AO-20RY	0	4	5	20
PD9000-GP-8AI	0	8	0	0
PD9000-GP-8AI-10RY	0	8	0	10
PD9000-GP-8AI-10AO-10RY	0	8	10	10
PD9000-GP-8AI-20RY	0	8	0	20
PD9000-GP-8AI-25RY	0	8	0	25
PD9000-GP-12AI	0	12	0	0
PD9000-GP-12AI-20RY	0	12	0	20
PD9000-GP-12AI-10AO-10RY	0	12	10	10
PD9000-GP-16AI	0	16	0	0
PD9000-GP-16AI-15RY	0	16	0	15
PD9000-GP-16AI-15AO	0	16	15	0
PD9000-GP-20AI	0	20	0	0
PD9000-GP-20AI-10RY	0	20	0	10
PD9000-GP-20AI-10AO	0	20	10	0
PD9000-GP-24AI	0	24	0	0
PD9000-GP-24AI-5RY	0	24	0	5
PD9000-GP-24AI-5AO	0	24	5	0
PD9000-GP-28AI	0	28	0	0
PD9000-GP-4PI	4	0	0	0
PD9000-GP-4PI-5AO	4	0	5	0
PD9000-GP-4PI-5AO-10RY	4	0	5	10
PD9000-GP-4PI-4AI-5AO	4	4	5	0
PD9000-GP-4PI-4AI-5AO-10RY	4	4	5	10
PD9000-GP-4PI-8AI-10AO-10RY	4	8	10	10
PD9000-GP-8PI	8	0	0	0
PD9000-GP-8PI-10AO	8	0	10	0
PD9000-GP-8PI-10AO-10RY	8	0	10	10
PD9000-GP-8PI-8AI-10AO-5RY	8	8	10	5

<p>G = General Purpose F = Field-Mount P = Panel-Mount AI = Analog Input</p>	<p>PI = Pulse Input AO = Analog Output RY = Relay E = Ethernet (Add "-E" at the end of the model number) Example: PD9000-GP-4PI-8AI-10AO-10RY-E</p>
---	---

General Purpose Field/Wall Mount Models				
Model	Pulse Inputs	4-20 mA Inputs	4-20 mA Outputs	Relays
PD9000-GF-4AI	0	4	0	0
PD9000-GF-4AI-10RY	0	4	0	10
PD9000-GF-4AI-5AO-10RY	0	4	5	10
PD9000-GF-4AI-20RY	0	4	0	20
PD9000-GF-4AI-5AO-20RY	0	4	5	20
PD9000-GF-8AI	0	8	0	0
PD9000-GF-8AI-10RY	0	8	0	10
PD9000-GF-8AI-10AO-10RY	0	8	10	10
PD9000-GF-8AI-20RY	0	8	0	20
PD9000-GF-8AI-25RY	0	8	0	25
PD9000-GF-12AI	0	12	0	0
PD9000-GF-12AI-20RY	0	12	0	20
PD9000-GF-12AI-10AO-10RY	0	12	10	10
PD9000-GF-16AI	0	16	0	0
PD9000-GF-16AI-15RY	0	16	0	15
PD9000-GF-16AI-15AO	0	16	15	0
PD9000-GF-20AI	0	20	0	0
PD9000-GF-20AI-10RY	0	20	0	10
PD9000-GF-20AI-10AO	0	20	10	0
PD9000-GF-24AI	0	24	0	0
PD9000-GF-24AI-5RY	0	24	0	5
PD9000-GF-24AI-5AO	0	24	5	0
PD9000-GF-28AI	0	28	0	0
PD9000-GF-4PI	4	0	0	0
PD9000-GF-4PI-5AO	4	0	5	0
PD9000-GF-4PI-5AO-10RY	4	0	5	10
PD9000-GF-4PI-4AI-5AO	4	4	5	0
PD9000-GF-4PI-4AI-5AO-10RY	4	4	5	10
PD9000-GF-4PI-8AI-10AO-10RY	4	8	10	10
PD9000-GF-8PI	8	0	0	0
PD9000-GF-8PI-10AO	8	0	10	0
PD9000-GF-8PI-10AO-10RY	8	0	10	10
PD9000-GF-8PI-8AI-10AO-5RY	8	8	10	5

<p>G = General Purpose F = Field-Mount P = Panel-Mount AI = Analog Input</p>	<p>PI = Pulse Input AO = Analog Output RY = Relay E = Ethernet (Add “-E” at the end of the model number) Example: PD9000-GP-4PI-8AI-10AO-10RY-E</p>
---	---

Input / Output Cards & Accessories

Model	Description
PDA9000-C4AI	(4) Isolated 4-20 mA Inputs Card for ConsoliDator+
PDA9000-C4PI	(4) Pulse Inputs Card for ConsoliDator+
PDA9000-C5AO	(5) Isolated 4-20 mA Outputs Card for ConsoliDator+
PDA9000-C5RY	(5) Relays Card for ConsoliDator+
PDA9000U	(2) U-Bolts Zinc-Plated Kit for 2" Pipe for ConsoliDator+
PDA9000U-SS	(2) U-Bolts Stainless Steel Kit for 2" Pipe for ConsoliDator+
PDP9000EB	Additional Devices Internal Mounting Plate for Field-Mount ConsoliDator+ Enclosure
PDA9000SH	Sun Hood for Field Mount or Panel Mount ConsoliDator+
PDX9000EC	Enclosure for Field-Mount ConsoliDator+ (Only for conversion from panel-mount)
PDX9000FC	Front Cover for Panel-Mount ConsoliDator+ (Only for conversion from field-mount)
PDA-LHR	Red Light / Horn for ConsoliDator+ Models with Relays
PDA-LHG	Green Light / Horn for ConsoliDator+ Models with Relays
PDA-LHY	Yellow Light / Horn for ConsoliDator+ Models with Relays
PDA-LHB	Blue Light / Horn for ConsoliDator+ Models with Relays
PDA-LHW	White Light / Horn for ConsoliDator+ Models with Relays
PDA-LH5C	Light / Horn with User Choice of Red, Green, Yellow, Blue, or White Light
PDA-LH3LC-RYG	Light / Horn with Red, Yellow, Green Light Layers

Setup & Calibration Services

Part Number	Description
PDN-CALCON+12	ConsoliDator+ Calibration and Certificate for up to 12 Inputs and Outputs
PDN-CALCON+24	ConsoliDator+ Calibration and Certificate for up to 24 Inputs and Outputs
PDN-CALCON+36	ConsoliDator+ Calibration and Certificate for up to 36 Inputs and Outputs
PDN-CALCON+12-DATA	ConsoliDator+ Calibration and Certificate with data for up to 12 Inputs and Outputs
PDN-CALCON+24-DATA	ConsoliDator+ Calibration and Certificate with data for up to 24 Inputs and Outputs
PDN-CALCON+36-DATA	ConsoliDator+ Calibration and Certificate with data for up to 36 Inputs and Outputs
PDN-CSETCON+	Custom Setup for ConsoliDator+

Specifications

Except where noted all specifications apply to operation at 25°C (77°F)

General

DISPLAY	Color; QVGA (320x240 px), 5.7" (145 mm) diagonally, white backlight Bargraph: Twenty divisions Numerical: Up to 15 digits (±999,999,999,999,999) Feet & Inches Format: 99,999' 11.9"
SCREEN BARGRAPH	Enable/disable: Channels, totals, timers Bargraph scale: 0 – 100%, independent of channel scale. Twenty divisions: 5% each. Screen: Select to show bargraph or not.
DECIMAL POINT	0 to 15 decimal places, user selectable
ENGINEERING UNITS	User selectable units or custom units Time, Distance, Volume, Pressure, Weight, Temperature, Current, Voltage, Percent, Amps, Volts, Counts, Logic, and Custom, Any unit/unit of time or other units
DISPLAY UPDATE RATE	User selectable: 0.1 to 10 sec (10 updates/sec to 1 update/10 sec)
PROGRAMMING METHOD	Front panel buttons, external buttons, or ConsoliDator+ Software
NUMBER OF ALARMS	Up to 64 high or low Automatic (non-latching) or latching On & Off time delays May be assigned to one or more relays. <i>Note: Alarms are independent from relays.</i>
ALARM TYPES	Single Source: One input Multi-Source: Two or more inputs Interval: Enter time interval and On Time Alarm OR: Any active input alarm triggers the OR alarm Alarm AND: All input alarms must be active to trigger the AND alarm
ALARM ACK & RESET	Automatic only (Non-latching) Automatic and manual Manual only (Latching) Manual with Ack only after alarm is cleared (Latching with Clear)
INTERNAL BUZZER	60 dBA @ 24 inches (61 cm) Enable/disable in System – General menu. Associated with alarm Horn setting
EXTERNAL HORN (Sold separately)	Assign any relay to the Horn function to activate an external horn when alarm condition is detected.
CALIBRATION	All inputs and outputs are calibrated at the factory. Field calibration not possible.
INPUT & OUTPUT CARDS	Max Number of I/O Cards: 7 Analog Inputs: 4/card Pulse Inputs: 4/card Analog Outputs: 5/card Relays: 5/card
NUMBER OF SCREENS	Up to 20 screens with 1 to 8 PVs or items per screen Enable or disable screen title, channel #, and bargraph Automatic or manual scanning Scan time: 1 to >1000 sec, independent for each screen F1-F4 keys are assigned per screen

FUNCTION KEYS	User programmable (See defaults below) F1 = Previous ← F2 = Next → F3 = Scan/Stop F4 = Ack
NUMBER OF CHANNELS	Up to 99 channels Input source: 4-20 mA, Pulse, Digital, Modbus, Alarm, Math, Channel, Total Timer, mA Output, Relay Output, Digital Output, or Modbus Output
PASSWORD	Programmable password restricts modification of programmed settings
NON-VOLATILE MEMORY	Settings stored for a minimum of 10 years.
POWER	Three-terminal connector (L, N, GND) AC: 80-264 VAC, 47 to 63 Hz, 60 W max DC: 113-370 VDC, 60 W max (L, N)
USER SELECTABLE BASED ON WIRING	Two-terminal connector (G, 24V) DC: 24 VDC ±10%, 60 W max
BACKUP POWER SUPPLY	If AC and DC power are connected, the 24 VDC can be used as backup power in case of AC power failure.
FUSE	Unit is protected internally with auto-resettable fuse AC: 1.25 A max DC: 3.7 A max
EXTERNAL FUSE	Recommended external fuse slow-blow 120 VAC: 2.0 A 240 VAC: 1.0 A 24 VDC: 4 A
ISOLATION & GROUNDING	1500 V Analog inputs/outputs-to-power line, 500 V Analog input-to-input, input-to-output, analog output-to-output All analog inputs and analog outputs are isolated from each other. <i>Note: DC Power is not isolated. DC- is connected to Earth Ground. Digital I/O, USB, and Ethernet are grounded.</i>
ENVIRONMENTAL	Operating temperature range: -40 to 60°C (-40 to 140°F) Storage temperature range: -40 to 60°C (-40 to 140°F) Relative humidity: 0 to 90% non-condensing <i>*All functions operate down to -40°C (-40°F.) LCD response is slower, increase display refresh setting.</i>
CONNECTIONS	Removable screw terminal blocks Inputs/Outputs: 12 to 24 AWG wire Digital I/O: 16 to 30 AWG RS-485: 12 to 24 AWG wire RJ45 Ethernet connection. USB ports: Micro-USB (Device) and Type A (Host)
TIGHTENING TORQUE	Screw terminal connectors: 5 lb-in (0.56 Nm) Digital I/O terminals: 2.5 lb-in (0.28 Nm)

ENCLOSURE	Enclosure Body: Thermoplastic Polyester, Color: Gray Display Window: Clear Polycarbonate, GE LEXAN HP12W Front Panel Keys: Silicone rubber
TAMPER PROOF ENCLOSURE	The field mount enclosure's cover is secured by a clasp that can be locked to prevent unauthorized access to the enclosure's interior.
MOUNTING	Wall-Mount: Four screws/bolts required (not provided) Pipe-Mount: (2) U-Bolts for 2" Pipe (See Ordering Information) Panel-Mount: Panel-mounting frame and twelve screws (provided) Cutout: 10.0" x 10.0" ±0.05" (254 mm x 254 mm ±1.3 mm) (H x W) Panel thickness: 0.07" – 0.35" (1.8 mm – 8.9 mm) Clearance behind panel: 6" (152 mm)
CONDUIT CONNECTIONS	There are four center punched marks on each side of the field enclosure. Holes must be drilled by the installer according to the desired conduit entry. Size: ½" or ¾" (16 mm or 21 mm) Clearance: 1.5" (38 mm) diameter
OVERALL DIMENSIONS	Panel-Mount: 10.85" x 10.85" x 4.87" (276 mm x 276 mm x 124 mm) (H x W x D) Field-Mount: 11.5" x 12.0" x 8.03" (292 mm x 305 mm x 204 mm) (H x W x D)
WEIGHT	Ex: PD9000-XY-4PI-8AI-10AO-10RY Panel-Mount: 7.4 lb (3.4 kg) approx. Field-Mount: 10.8 lb (4.9 kg) approx.
WARRANTY	3 years parts and labor

Totalizer

NUMBER OF TOTALIZERS	Up to 32 totalizers 15 digits with comma separator
TOTALIZER INPUTS	Calculates total based on selected rate channel, pulse input, digital input, or trigger event for non-rate channels. Reading stored in non-volatile memory, if power is lost.
MAXIMUM TOTAL	15 digits 999,999,999,999,999
RATE CHANNEL INPUT	4-20 mA input Pulse input Modbus input Digital Input
RATE & TOTAL DECIMAL POINT	Independent and user selectable from 0 to 15 places
TOTALIZER RESET	Via front panel keys or digital inputs
NON-RESETTABLE TOTAL	Total may be setup to be non-resettable to prevent unintentional reset. This can be changed in the Setup Totals menu.
TOTAL CONVERSION FACTOR	Input: Rate channel Total units may be different than rate units. Use the Total CF to convert to non-listed units (e.g. Gallons to MGal = 0.000001)
PULSE INPUT K-FACTOR	K-Factor = pulses/units of measure Calculates total directly from pulse input, digital input, or Modbus input. Create rate channel by entering K-Factor, units and time base in sec, min, hr, or day. Decimals: 0 to 15
COUNT DOWN	Total may be setup to count down
PRESET VALUE	Enter the preset value to count up or down Reset total sets total to the preset value
ROLL-OVER	Enter the value for total to roll-over to 0 Example: Roll-Over = 1,000,000 It goes to 0 after 1 million
NEGATIVE TOTAL	Allow total value to count below 0 for bi-directional flow based on rate channel
TOTAL BARGRAPH	Bargraph may be scaled to represent the expected maximum total
FUNCTION KEYS	Screen Setup: Assign F1-F4 to Reset Total, Enter Total, Add To, or Remove From total

Channel & Math Functions

SCALE FUNCTIONS	K-Factor	Converts number of pulses to volume or other units	
	Scale Factor	Apply multiplier to a channel	
	Scale Linear 2-Pt	Scale a channel	
	Scale Multi-Point	Multi-point scaling of a channel	
	Scale Square Root	Apply square root to a channel – Differential Pressure from two channels	
	Scale Exponent	Apply exponent for weirs and flumes open channel flow calculation	
	Round Horizontal Tank	Calculate volume in round horizontal tank with flat ends	
	Units Conversion	Convert standard units to custom units	
	MATH FUNCTIONS	Constant	Assign fixed value
		Summation	Add two or more channels
Difference		Subtract any two channels	
Abs Difference		Difference always positive	
Absolute Value		Convert channel value to positive	
Average		Find the average of channels	
Weighted Average		Assign % weight to two or more channels	
Multiply		Multiply two channels	
Divide		Divide two channels	
% Efficiency		Calculate input to output efficiency $((A-B)/A)*100\%$	

ADDITIONAL FUNCTIONS	Compare	
	Greatest	Greatest value in a group of channels
	Least	Smallest value in a group of channels
	Measure	
	Tare	Calculate net value when Tare function is applied via function key
	Maximum	Maximum value reached by the process
	Minimum	Minimum value reached by the process
	Percent (Bargraph)	% bargraph of any: 4-20 mA input, channel, total, timer, or mA output
	Duration	Keep track of time a condition has been present (e.g. high alarm active)
	Control	
Sampler	Trigger relay sample and select sampling time (e.g. Turn relay on for 30 sec every time total increases by 1,000 Gallons)	
On-Off Control	Set on & off control based on process value	
Relays		
Cycle Count	Number of relay cycles since last reset	
Runtime	Relay runtime (ON) hh:mm:ss	
Modbus		
Time Since Read	This is the time since a Modbus master device read a register	
Time Since Write	This is the time since a Modbus master device wrote to a register	

List of Engineering Units

None: Units not needed
Time: sec, min, hr, day
Distance (Height): cm, m, Inch, Feet, Ft-In, Yard, custom (new)
Volume: Gallons, GAL, L, IGAL, M3, BBL, BUSH, cuYD, cuFt, cuIn, LiBBL, BBBL, HECTL, custom (new)
Pressure: PSI, Pa, Bar, custom (new)
Weight: Gram, Oz, Lb, lb, custom (new)
Temperature: C, F, K, Ra
Percent: %, PCT, Percent, custom (new)
Amps: mA, Amps, custom (new)
Volts: V, mV, Volts, custom (new)
Counts: Pulses, Cycles, Counts, custom (new)
Logic: ON, OFF, OPEN, CLOSED, YES, NO, START, RUNNING, STOP, PUMP ON, PUMP OFF, OK, OKAY, ERROR, WARNING, custom (new)
Custom: Enter unit's name, base unit, factor, and type

4-20 mA Analog Inputs

NUMBER OF INPUTS	(4) Analog inputs/card (28) Analog inputs max, no other I/O
TYPICAL INPUT	4-20 mA
INPUT RANGE	0-24 mA
ACCURACY	±0.03% of full scale ±1 count
4-20 mA DISPLAY VALUE	Up to six full digits (Recommended) ±999,999 More digits may be used, but the stability will be affected. Increase the filter value and display update rate to get a more stable reading.
TRANSMITTER POWER SUPPLY	Isolated 24 VDC @ 200 mA/input Max current: 1,600 mA (All inputs) (8) Analog Input @ 200 mA max (28) Analog Input @ 20 mA max Available on AC or DC powered units
TEMPERATURE DRIFT	Better than: 20 ppm/°C from -40 to 60°C ambient
FILTER	Window: 0.5, 1, 2, 4, 8 sec, IIR: 16, 32 sec Glitch Filter: Discards a single sample caused by high frequency noise
FILTER BYPASS	0 to 100 % of full scale Filter is ignored, if the signal change is greater than bypass value
CHANNEL INPUT SCALE FUNCTION	Linear 2-Point, Multi-Point (up to 50 points) Square Root Programmable Exponent Scale Factor Round Horizontal Tank (Volume) None (mA Input Reading)
INPUT PROTECTION	Each 4-20 mA input is protected by an auto-resettable fuse, 30 VDC max. The fuse resets automatically after the fault condition is removed.
INPUT IMPEDANCE	125 Ω Typical Including auto-resettable fuse
ISOLATION	1500 V: Input-to-power line 500 V: Input-to-input, input-to-output All analog inputs and analog outputs are isolated from each other.
NORMAL MODE REJECTION	100 dB at 50/60 Hz
COMMON MODE REJECTION	90 dB at 50/60 Hz

Pulse Inputs

NUMBER OF INPUTS	(4) Pulse inputs/card (28) Pulse inputs max, no other I/O
INPUT TYPE	Active Square Wave, NPN, PNP, Reed Switch, Coil (Magnetic Pickup) Normal threshold: 1.2 V (0.8 to 3.0 V) High threshold: 2.5 V (2.0 V to 6.0 V) Coil threshold: 20 mV (Low) or 100 mV (High)
SIGNAL LEVEL	Active Square Wave: 0 to 30 V max Typical: 0 to 5 V Coil: 20 mVp-p to 30 Vp-p (Magnetic Pickup)
INPUT IMPEDANCE	Active, NPN, Reed: 10 kΩ pull-up to 5 V PNP: 10 kΩ pull-down to (S-) Coil: >2 kΩ (20 mV sensitivity), >10 kΩ (100 mV sensitivity)
ISOLATION	Pulse inputs are not isolated, (S-) terminal is connected to system GND
INPUT PROTECTION	±36 V, non-isolated
FREQUENCY RESPONSE & SIGNAL LEVEL	Active Square Wave 5 V: 0 to 100 kHz Coil (Magnetic Pickup): 0 to 50 kHz <u>Frequency – Signal level (Coil: 20 mV)</u> 20 mVp-p – 100 Hz 100 mVp-p – 10 kHz <u>Frequency – Signal level (Coil: 100 mV)</u> 100 mVp-p – 90 Hz 500 mVp-p – 5 kHz 20 Vp-p – 50 kHz
MINIMUM FREQUENCY	250 μHz High Gate: 4,000 sec
GATE	Low Gate: 1 to 99 sec High Gate: 2 to 4,000 sec (Must be higher than low gate)
ACCURACY	±1 count for K-Factor > 1 or 30 ppm
K-FACTOR	Programmable pulses/unit with up to 15 decimal resolution
SCALE PULSE INPUT	Linear 2-Point Multi-Point Scaling: 2 to 50 points

Modbus Inputs

NUMBER OF INPUTS	199 Modbus RTU
SCALE MB INPUT	Modbus input may be used as the input for creating channels and totals, the same way 4-20 mA inputs are used.
DATA TYPE	Bit-Logic Signed/Unsigned: 16 (Short), 32 (Long), 64 (Long-Long) Float 32 Float 64 (Double)
DECIMAL POINT	User selectable
COMM BREAK & TIMEOUT	Specify what value to hold on comm. break and how long to wait for new data before reporting a break condition.
INPUT ACTION	Specify what should happen when new data is written to the input register (e.g. add value to total).

Digital Inputs & Outputs

DIGITAL INPUTS	5 Inputs, non-isolated, 30 VDC max Standard feature on all ConsoliDator+ models Low: 0 to 1.2 V High: 2.8 to 30.0 V Internal pull-up: 5 k Ω to 5 V Max pulse frequency: 1 kHz @ 5 Vp-p +5 V terminal: Internal pull-up 100 Ω Note: Pulse inputs may be used as digital inputs
DIGITAL INPUT TYPES	Normally open switch: External excitation not required (Current: 1 mA) Open collector: 4.1 V open circuit voltage Logic level: 0 to 30 V
ASSIGNMENT & OPERATION	Active Low or Active High Functions: Remote front panel button, total functions, timer control, alarm functions, screen navigation, horn functions, reset relay information. Digital inputs can be used as input source for channels, totals, and alarms.
DIGITAL OUTPUTS	4 Outputs Standard feature on all ConsoliDator+ models Low: 0 V (no load), 1.5 V max @ 10 mA sink (External pull-up) High: 5.0 V (no load), 3.5 V @ 10 mA load Maximum current: 30 mA Output impedance: 100 Ω Output protection: 150 mA auto-resettable fuse Max frequency: 5 Hz
DIGITAL OUTPUT ASSIGNMENT	Digital outputs require logic units as the input Input sources: Digital input, Modbus input, channel, alarm, horn, always on, or always off
INPUT/OUTPUT PROTECTION	\pm 36 V, non-isolated

Relays

NUMBER OF RELAYS	(5) Relays/card (30) Relays max with (4) analog or (4) pulse inputs, no other I/O
RATING	SPDT (form C) Rated 10 A @ 120/240 VAC or 8 A @ 30 VDC resistive load NO contacts: 1/3 HP, 120 VAC, 30,000 cycles NC contacts: 1/8 HP, 120 VAC, 50,000 cycles Minimum load: 100 mA @ 5 VDC
ISOLATION	1500 VAC, 50/60 Hz for 1 min between coil and contacts
DEADBAND	0-100% of full scale, user selectable
ELECTRICAL NOISE SUPPRESSION	TVS diodes & snubbers on all contacts. Recommended, additional external suppressor: 0.01 μ F/470 Ω , 250 VAC (Order: PDX6901)
ASSIGNMENT & OPERATION	Any relay may be assigned to any alarm, channel, total, timer, digital input, Modbus input, pump alternation, horn, always on, or always off. Multiple relays may be assigned to the same alarm or channel. All relays are programmed independently. High & Low Alarm: Defined by set and reset points in the Alarm menu High or Low Alarm: Assign relay to any alarm or channel for on/off relay control <i>Note: Automatic reset only for channel</i> Multi-Source High or Low Alarm: Assign relay to two or more alarms. Indicate common high or low condition. Pulse Action: Set any relay for pulsing on/off timed relay control. Programmable pulse width (on/off time) and on/off delay. Sampling: Relay must be assigned to channel setup for Sampler function with user-defined total increment or set point and sampling time. Pump Alternation: Any relay may be setup to alternate with any relay in the group. Multiple alternation groups may be setup.
ACKNOWLEDGE	Front panel Ack key or digital input acknowledges alarms; relays associated with acknowledged alarm are turned off. Acknowledge all or any alarm.
ALARM RELAY	Assign any relay to be driven by any alarm; acknowledging the alarm turns off the relay.
TIME DELAY	Programmable on/off delays, 0.0 to 999.9 sec Independent for each relay.
AUTO INITIALIZATION	When power is applied to the controller, relays will reflect the state of the input to the controller.

4-20 mA Transmitter Outputs

NUMBER OF ANALOG OUTPUTS	(5) Analog outputs/card (35) Analog outputs max with no other I/O cards (Seven I/O slots)
OUTPUT RANGE	4.00 to 20.00 mA, nominal
CALIBRATION	Factory calibrated for 4-20 mA
SCALING RANGE	Any process range Reverse scaling allowed
ASSIGNMENT & OPERATION	Assign to any analog or pulse input, digital input, Modbus input, channel, total, timer, alarm, or fixed value (none). <i>Note: Multiple 4-20 mA outputs can be assigned to the same input.</i>
ACCURACY	±0.03% F.S. ±0.005 mA
TEMPERATURE DRIFT	20 ppm/°C from -40 to 60°C ambient. (Output & Input drifts are separate)
OUTPUT LOOP POWER	Powered by controller or externally by 12 to 32 VDC
OUTPUT LOOP RESISTANCE	Powered by controller: 10 to 600 Ω External 12 VDC: 10 to 200 Ω External 24 VDC: 10 to 600 Ω External 32 VDC: 10 to 1000 Ω
ISOLATION	1500 V: Output-to-power line 500 V: Output-to-output, output-to-input All analog inputs and analog outputs are isolated from each other.

Timers

NUMBER OF TIMERS	Up to 32
TIME FORMAT	hh:mm:ss with 0 decimals selected Seconds with 1 or more decimals
AUTOMATIC ACTIONS	Power Up: Timer action on power up Error: Action when an error is detected Reset: Event causes the timer to reset Start: Event triggers the timer to start Stop: Event causes the timer to stop
START / STOP RESET	The function keys and digital inputs can be used to start, stop, and reset the timers, regardless of the automatic actions selected.
ASSIGNMENT & OPERATION	Timers can be triggered, stop, and reset, by rising or falling signals from 4-20 mA input, pulse, digital, Modbus input, channel, total, other timers, alarm, mA output, relay, or Modbus output.
COUNT DOWN TIMER	Select count down and enter starting time
TIMER ALARM	Timer can be used to trigger alarms
BARGRAPH	Select bargraph during setup and scale the bargraph for 0 – 100% target time
TIMER CONTROL	Access timer control via the <i>View Timer</i> menu or assign a function key to timer control in the <i>Screens</i> menu
TIMER & RELAY	Timer can be assigned to drive relays based on selected set and reset points

Modbus® Serial Communications

COMPATIBILITY	RS-485 (EIA-485)
PROTOCOL	Modbus RTU
DEVICE ADDRESS	1 to 247
TRANSMIT DELAY	0 to 99 ms
BAUD RATE	1,200 to 115,200 bps
DATA	8 bit (1 start bit, 1 stop bit)
PARITY	Even, Odd, None with 1 stop bit, or None with 2 stop bits



Ethernet Communications

DEVICE	Lantronix Xport-05
PROTOCOL	Modbus TCP/IP (Default) Modbus UDP/IP Modbus RTU Over TCP/IP Modbus RTU Over UDP/IP
PORT SETTINGS (DO NOT CHANGE)	Protocol: RS232 Baud Rate: 9600 Data Bits: 8 Flow Control: None Parity: None, Stop Bits: 1 <i>Note: Do NOT change these settings</i>
NETWORK STACK	IPv4
ETHERNET MAC/PHY	10/100 Mbps
ADDITIONAL SPECIFICATIONS	Refer to the Lantronix Webpage https://www.lantronix.com/products/xport
ETHERNET PORT CONFIGURATION	Download the Lantronix DeviceInstaller software to configure the Ethernet port https://www.lantronix.com/products/xport

ConsoliDator+ Software

SYSTEM REQUIREMENTS	Windows® 7, 10
COMPATIBILITY	One software version for all models
CONNECTION	Micro-USB, RS-485, or Ethernet
CONFIGURATION	Configure inputs and outputs. Save controller settings file on PC for programming other controllers or to restore settings.

Safety Information

	
CAUTION: <i>Read complete instructions prior to installation and operation of the meter.</i>	WARNING: <i>Risk of electric shock or personal injury.</i>

	Hazardous voltages exist within enclosure. Installation and service should be performed only by trained service personnel.
Warning!	

Installation

Unpacking

Remove the instrument from its box. Inspect the packaging and contents for damage. Report any damages to the carrier. If any part is missing or the controller malfunctions, please contact your supplier or the factory for assistance.

Overall Dimensions

All dimensions are in inches and (mm).

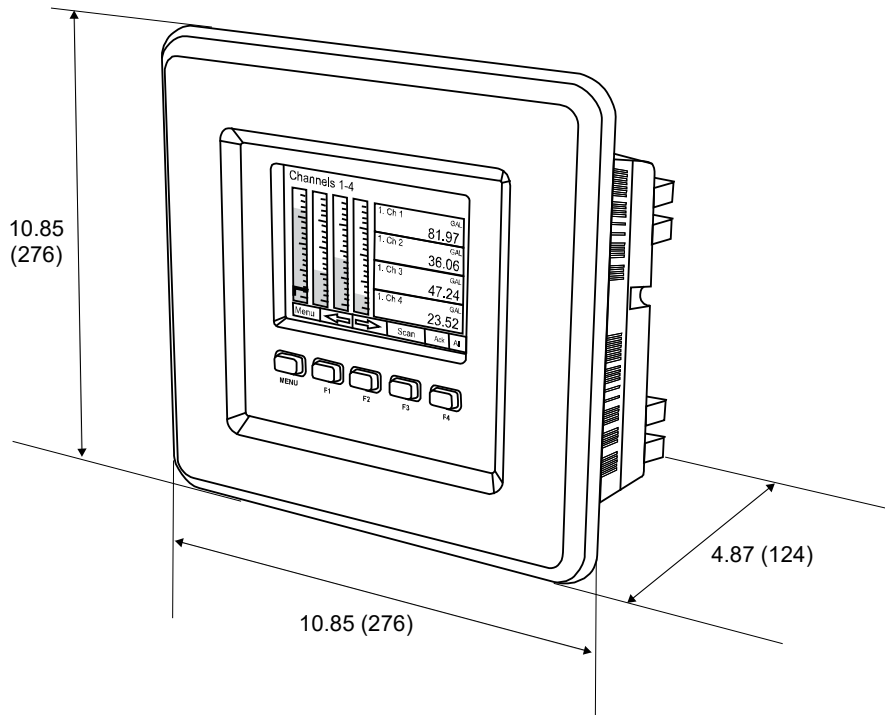

Figure 1. Panel Mount Overall Dimensions

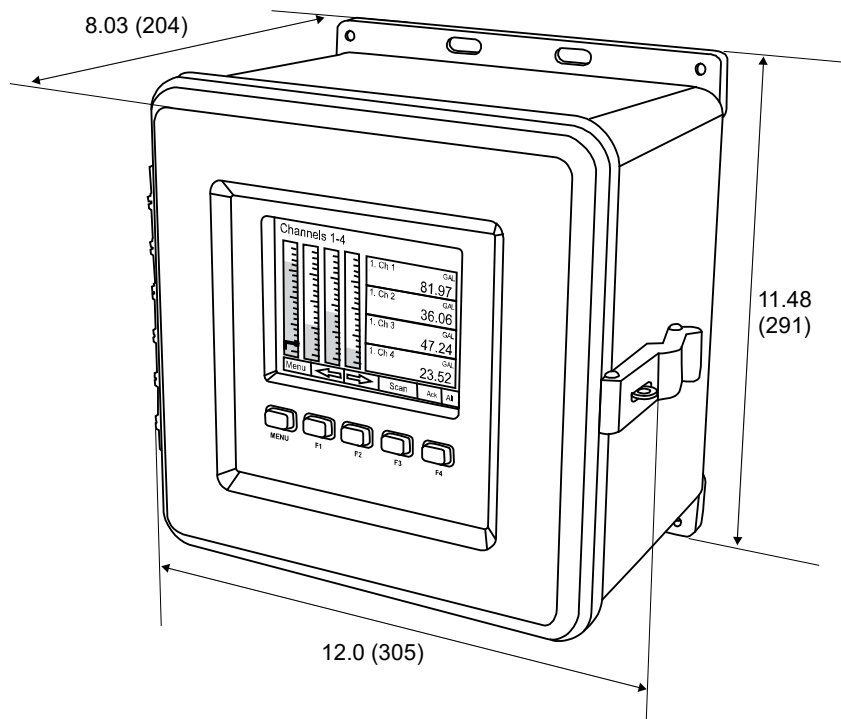

Figure 2. Field Mount Overall Dimensions

Panel Mounting (-GP & -GH Models)

- Prepare panel cutout per the dimensions provided
- Locate the panel mounting bracket and screws
- Inspect the controller to assure the gasket is securely in place
- Insert controller in the panel cutout, the latches on the top and bottom should hold it in place
- Insert the panel mounting bracket from the back of the panel, observe the orientation of the piece marked TOP
- Install the 12 screws provided

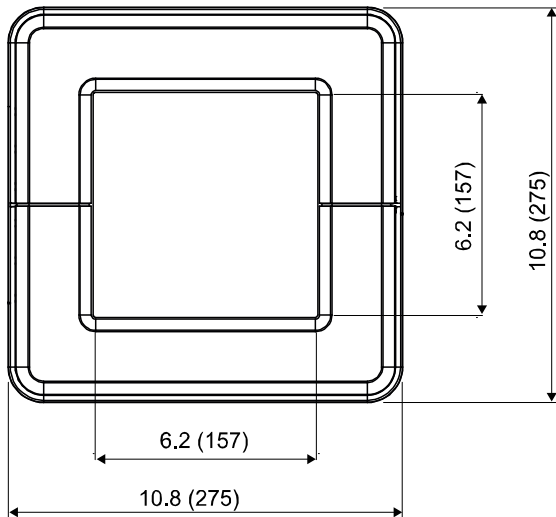

Figure 3. Front Panel Mount Dimensions

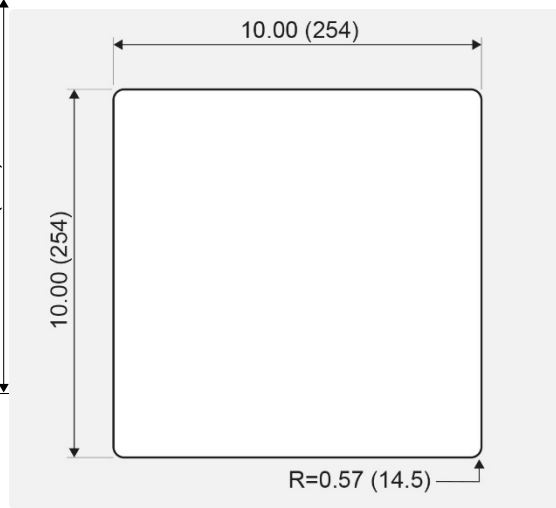
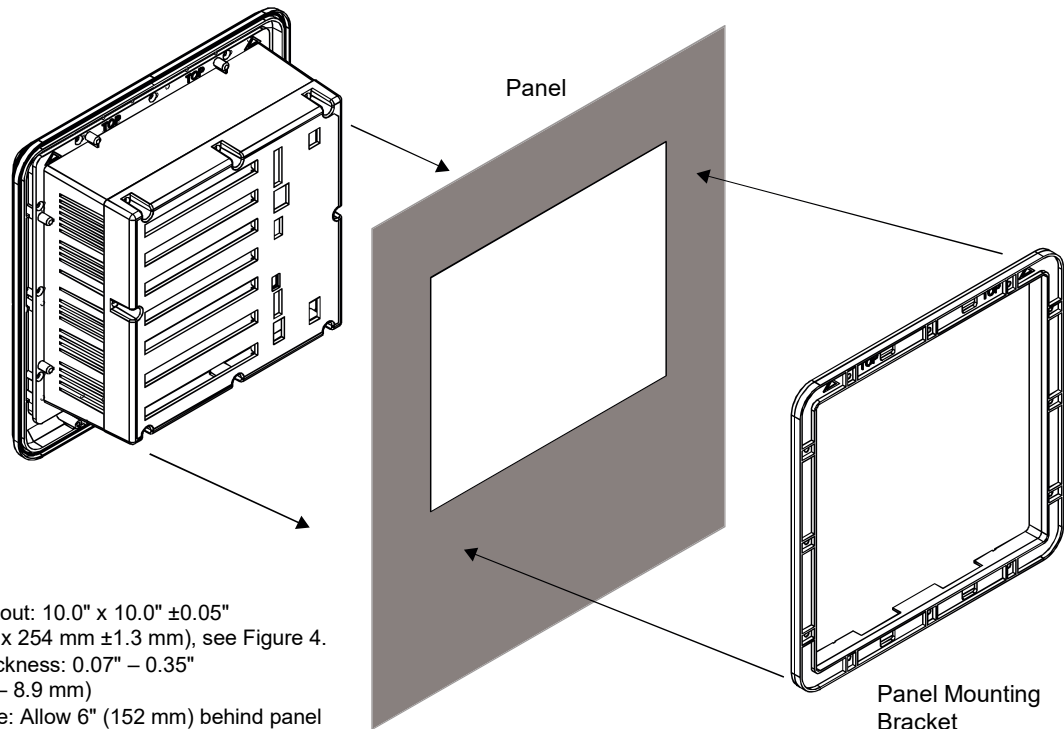

Figure 4. Panel Cutout Dimensions



Notes:

1. Panel cutout: 10.0" x 10.0" ± 0.05 " (254 mm x 254 mm ± 1.3 mm), see Figure 4.
2. Panel thickness: 0.07" – 0.35" (1.8 mm – 8.9 mm)
3. Clearance: Allow 6" (152 mm) behind panel

Figure 5. Panel Mount Installation

Wall Mounting Instructions (-FG & -FH Models)

- Obtain four screws appropriate for mounting holes and surface to be used for mounting
- Prepare four holes on the mounting surface per the dimensions provided below
- Secure the controller to the surface

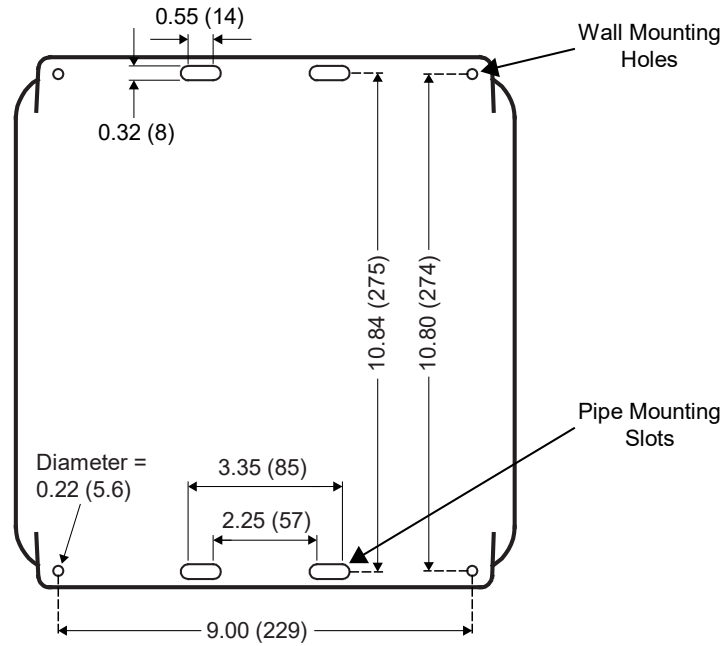

Figure 6. Wall & Pipe Mounting Dimensions

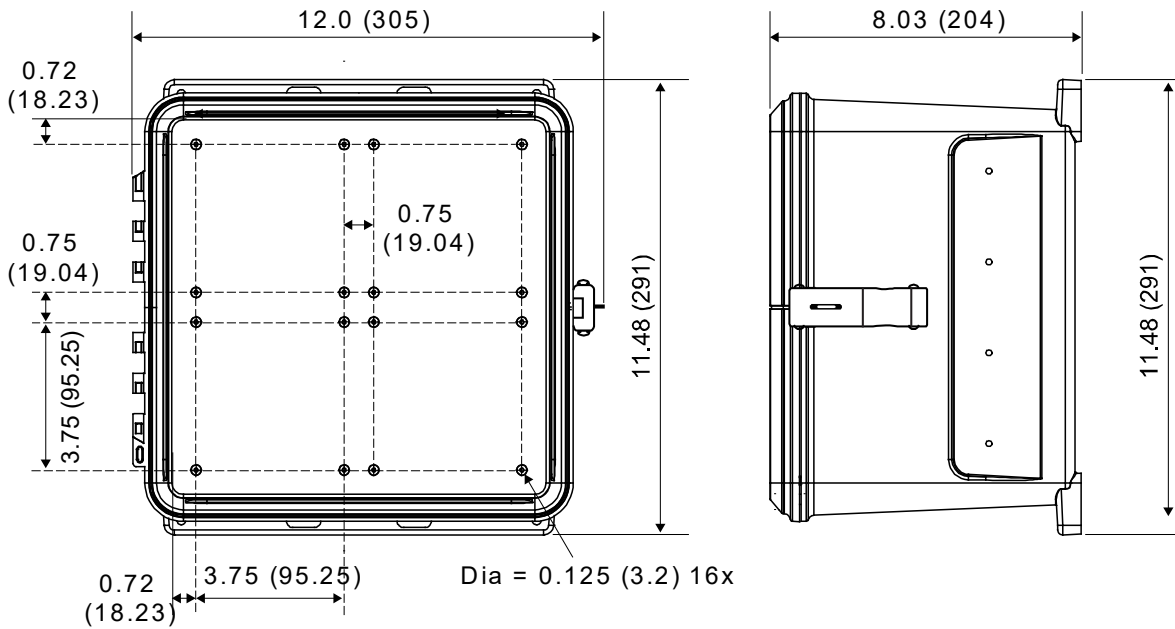

Figure 7. Wall Mount & Internal Boss Dimensions

Optional Internal Mounting Plate for Field Enclosure

The PDP9000EB optional internal mounting plate is installed on the inside back of the enclosure and allows for the mounting of other devices such as relays and power supplies.

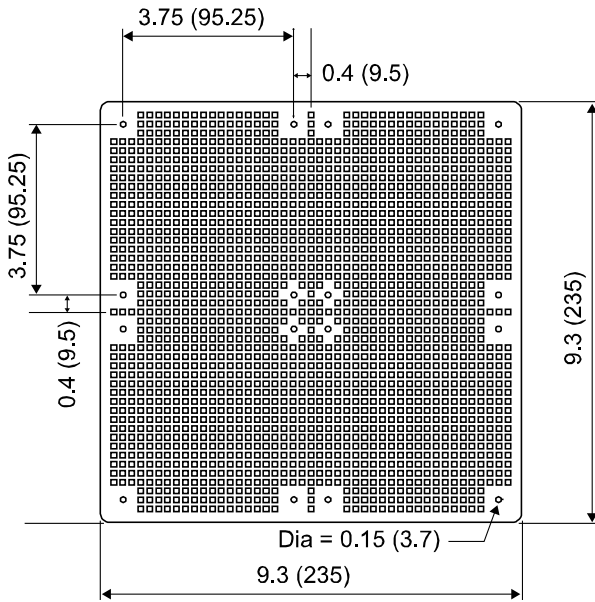

Figure 8. Mounting Plate Dimensions

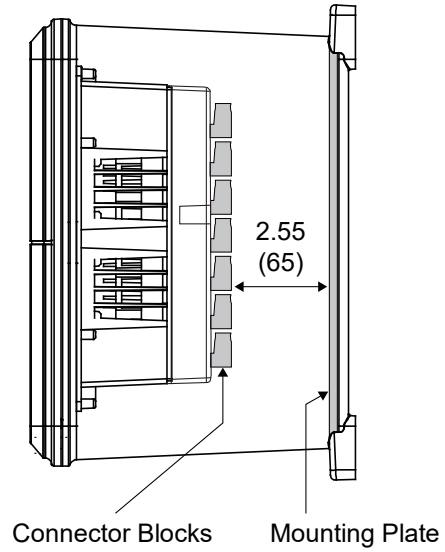

Figure 9. Clearance Inside Field Enclosure

Pipe Mounting

Four slotted flanges for NPS 1½" to 2½" or DN 40 to 65 mm pipe mounting are provided on the field mount ConsoliDator+ for easy installation onto a pipe. See Ordering Information, page 5 for available pipe mounting kits.



Figure 10. Pipe Mounted Field Controller

Conduit Connections

The controller includes four center punch marks on four sides of the field enclosure. (Top, bottom, and both sides) Holes must be drilled by the installer according to the desired conduit entry. Recommended hole sizes are 1/2" or 3/4" (16 mm or 21 mm) and a conduit connector clearance of 1.5" (38 mm) in diameter is recommended.

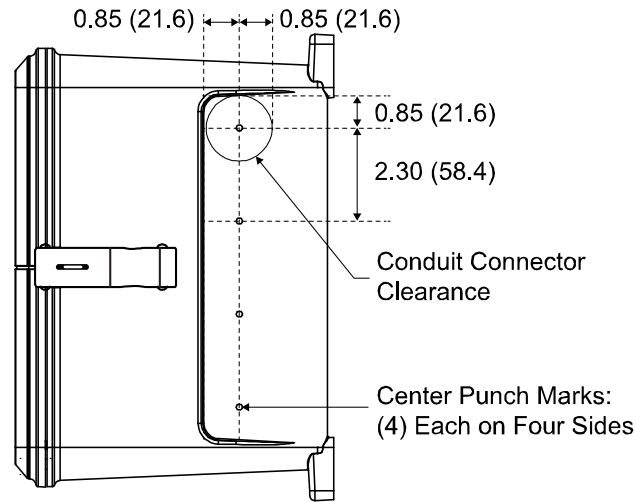

Figure 11. Conduit Hole Punch Mark Locations

Sun Hood for ConsoliDator+

Precision Digital offers a Sun Hood (PDA9000SH) accessory for installing in areas where bright sunlight impairs the visibility of the LCD screen on the ConsoliDator+. The Sun Hood is available for both the panel mount and field mount controllers. To install the sun hood onto the ConsoliDator+, remove the paper covering from the adhesive tape from the back of the sun hood. Then align the sun hood to the top left and right corners of the front panel of the ConsoliDator+ and firmly press it into position. See Figure 13.

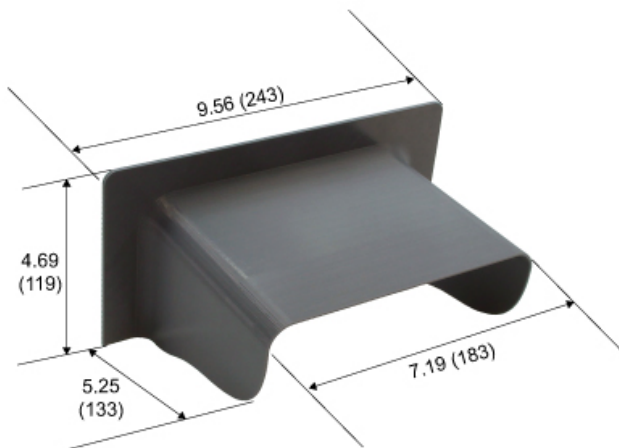

Figure 12. Sun Hood for ConsoliDator+



Figure 13. Sun Hood Installed on Field Mount Controller

Tamper Proof Enclosure

The field mount enclosure's cover is secured by a clasp that can be locked to prevent unauthorized access to the enclosure's interior.



Figure 14. Clasp on Side of the Enclosure

Connections

The back panel is labeled with the I/O boards that were installed at the factory. The removable connectors are labeled with the connection signal for each terminal. The following diagram shows what the back of PD9000-GP-4PI-8AI-10AO-10RY looks like. This model accepts (4) pulse and (8) analog inputs and has (10) 4-20 mA outputs and (10) relays. (5) digital inputs, (4) digital outputs, RS-485 serial capability and two USB connections (USB Host not functional at this time) are standard on all ConsoliDator+ models. Ethernet is an option. All units can be powered from AC or DC.

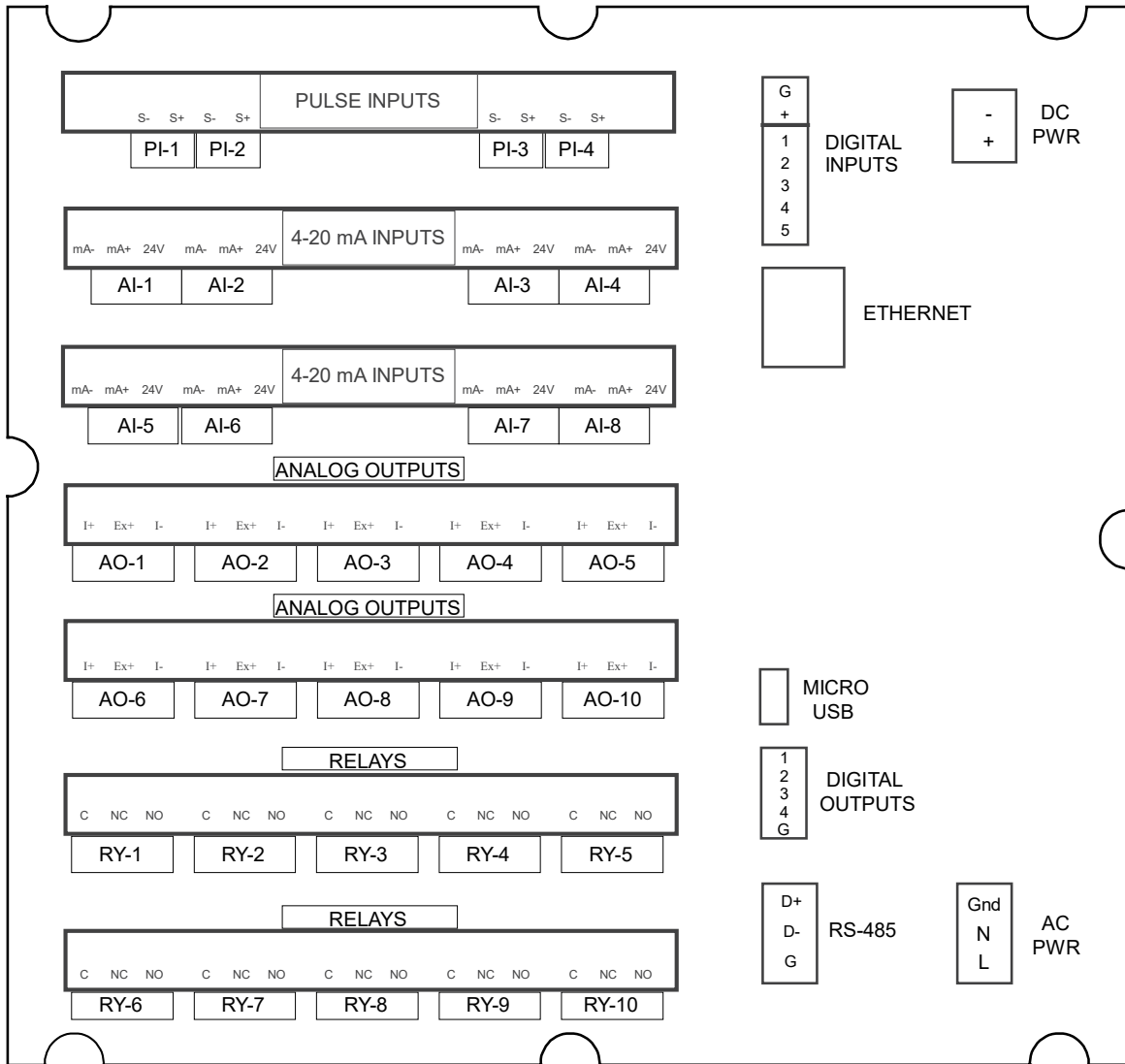

Figure 15. Connection Terminals for a PD9000-GP-4PI-8AI-10AO-10RY

Notes:

1. Each 4-20 mA input has its own isolated 24 VDC power supply to power the transmitter.
2. Each 4-20 mA output has its own isolated 24 VDC power supply to power the output loop.
3. Each relay is Form C and rated at 10 A.
4. Input / output connections are made to removable screw connectors.
5. Every ConsoliDator+ has five digital inputs (additional digital inputs can be obtained by using the Pulse Inputs).
6. Every ConsoliDator+ has four digital outputs.
7. Every ConsoliDator+ has RS-485 with Modbus.
8. All ConsoliDator+ models can be powered from either AC or DC Power.
9. Ethernet with Modbus TCP is an option.
10. Micro USB is used for programming the ConsoliDator+.



Use copper wire with 60°C or 60/75°C insulation for all line voltage connections. Observe all safety regulations. Electrical wiring should be performed in accordance with all applicable national, state, and local codes to prevent damage to the instrument and ensure personnel safety.

Power Connections

Power connections are made to one of the power terminal connectors. All units are capable of being powered either by AC or by DC for the ranges specified.

90-264 VAC Power

- Use three-terminal power connector as shown in Figure 16.
- Unit is protected internally with 1.25 A auto-resettable fuse. 2 A max, slow blow, 250 V min UL Recognized external fuse recommended.

24 VDC Power ± 10%

- Use two-terminal power connector as shown in Figure 16.
- Unit is protected internally with 3.7 A auto-resettable fuse. 4 A max, slow blow, 50 V min UL Recognized external fuse recommended.

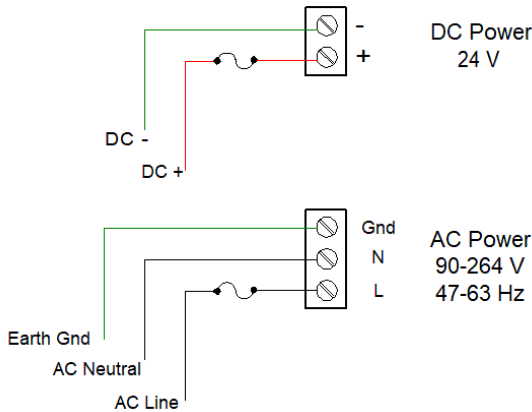

Figure 16. Power Connections

Note:
The controller may be powered by AC voltage with the 24 VDC power connection used as backup power.

Isolated Input Signal Connections

Isolated input signal connections are made to removable screw terminal connectors, which are labeled individually on the back panel of the controller. The back panel shows the type of input card installed in each slot (The top slot is #1 and the bottom is #7). Individual inputs are referenced as PI-1 to PI-4 for pulse inputs and AI-1 to AI-4, AI-5 to AI-8, etc for analog inputs.

4-20 mA Analog Input Connections

Analog 4-20 Input connections are made to screw terminal connectors (two inputs per connector). The following figures show examples for typical applications. Each of the 4-20 mA inputs may be connected in any of the modes shown below.

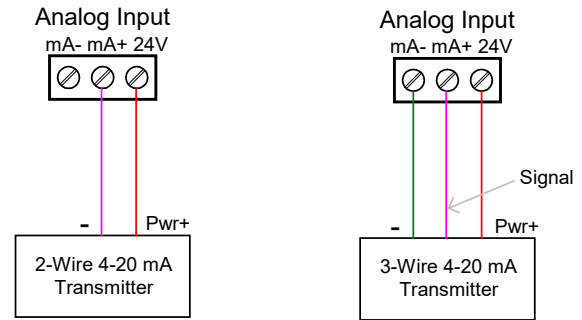

Figure 17. Transmitters Powered by ConsoliDator+'s Isolated 24 VDC Power Supply

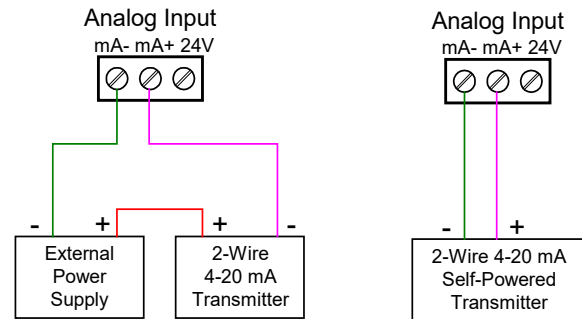

Figure 18. Transmitter Powered by Ext. Supply or Self-Powered

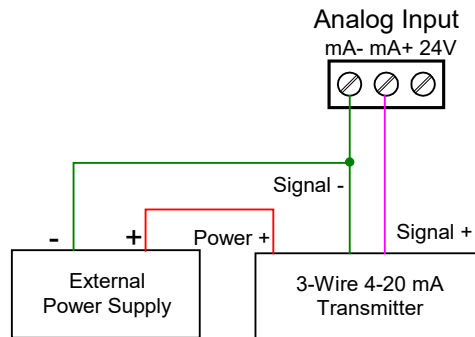

Figure 19. 3-Wire Transmitters Powered Externally

Flow Meter Pulse Input Connections

Flow Meter Pulse Inputs are wired to four-terminal connectors (two inputs per connector). A square wave waveform is used in the illustration, but the input is capable of reading many other types of signals within the voltage and frequency ranges specified.

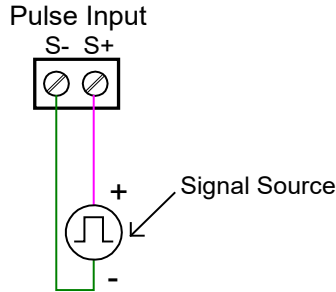

Figure 20. Flow Meter Pulse Input Connections

Digital Input Connections

Inputs are wired between terminals 1-5 of the digital input connector and the G terminal of the 2-position connector above the digital inputs. Normally open switch contacts may be used as shown in Figure 21. The diagram also shows a Digital Input using an NPN open collector transistor output from a live signal. Logic LO or switch closure appearing across the terminals is interpreted as ON. When using an open collector transistor, a logic HI at the base (marked "B" in Figure 21 *Error! Reference source not found.*) will be interpreted as ON. The 2-position connector has a +5 V terminal that may be used to provide excitation to some sensors requiring more than the pull-up provided on each digital input terminal.

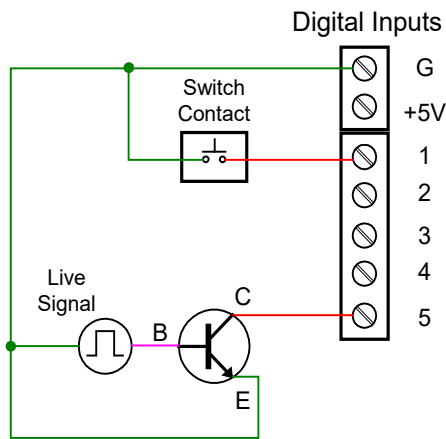

Figure 21. Digital Input from Switch Closure and Live Signal

Analog Output Connections

The following figures show examples for isolated 4-20 mA transmitter output connections. Terminal connectors are labeled individually. The analog outputs are isolated from each other and from the inputs. They are powered internally to provide an active 4-20 mA output loop. The outputs may be powered externally by connecting the positive voltage to the Ex+ terminal.

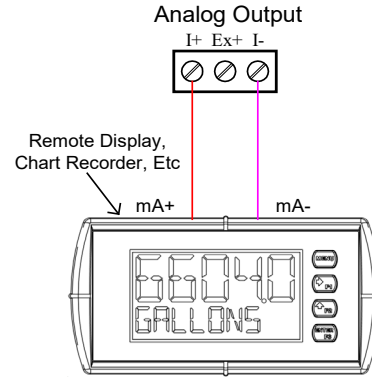

Figure 22. Active 4-20 mA Output Powered by Controller

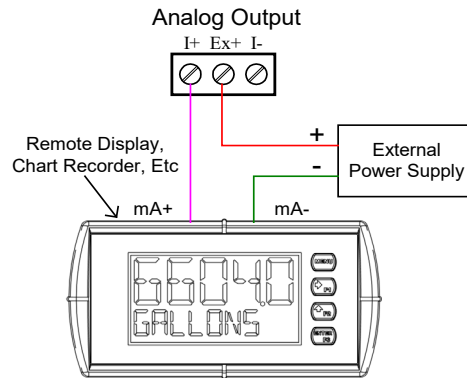

Figure 23. Passive 4-20 mA Output Powered by External Supply

Note: Analog inputs and outputs are isolated from each other

Digital Output Connections

The digital outputs may be used to drive digital inputs, alarm annunciators, or other devices such as solid-state relays that can be driven with low voltage signals.

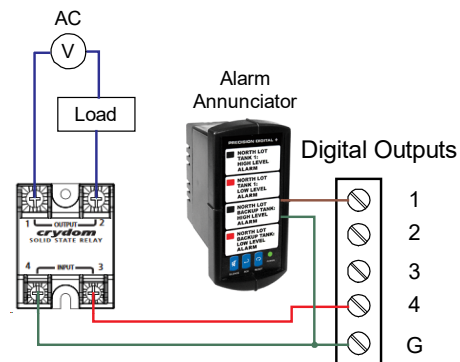

Figure 24. Digital Outputs Driving 5V Solid State Relay

Relay Connections

Relay connections are made to three-terminal connectors labeled individually. There are five relays per card.

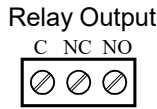

Figure 25. Relay Connections

Switching Inductive Loads

The ConsoliDator+ has internal circuitry to protect the relays from inductive loads, however, the use of suppressors (snubbers) is strongly recommended when switching inductive loads to prevent disrupting the microprocessor's operation. The suppressors also prolong the life of the relay contacts. Suppression can be obtained with resistor-capacitor (RC) networks assembled by the user or purchased as complete assemblies. Refer to the following circuits for RC network assembly and installation.

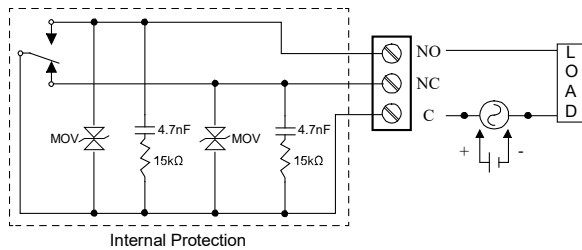

Figure 26. AC and DC Internal Inductive Loads Protection

For additional external protection choose R and C as follows:

- R: 0.5 to 1 Ω for each volt across the contacts
- C: 0.5 to 1 μF for each amp through closed contacts

Notes:

1. Use capacitors rated for 250 VAC.
2. RC networks may affect load release time of solenoid loads. Check to confirm proper operation.
3. Install the RC network at the instrument's relay screw terminals. An RC network may also be installed across the load. Experiment for best results.

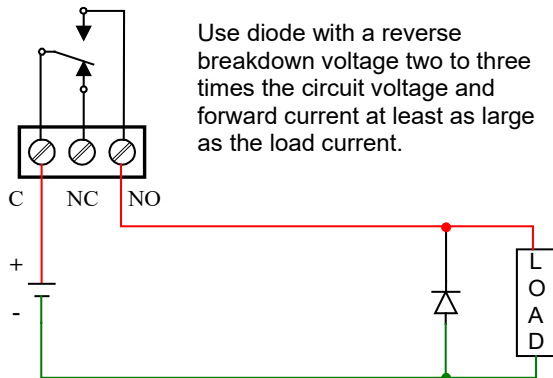

Figure 27. Low Voltage DC Loads Protection

RC Networks Available from Precision Digital

RC networks are available from Precision Digital and should be applied to each relay contact switching an inductive load. Part number: PDX6901.

Serial Communication Connections

The RS-485 port for serial communication (using Modbus protocol) has three terminals labeled D+, D-, and G. It is strongly recommended to use three-wire shielded cable and to always connect the ground terminal to the other equipment's ground to avoid differential voltage between the systems. Distances up to 4000 feet can be reached with RS-485. Up to 32 Modbus devices may be connected to a single RS-485 bus.

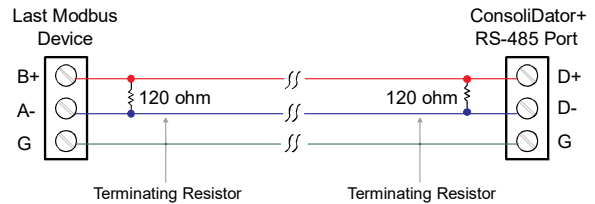

Figure 28. Serial Connections

Ethernet Option

The Ethernet port is available on the RJ45 connector. This allows the ConsoliDator+ to connect to a local area network. The Ethernet port option is configured using the Lantronix DeviceInstaller software, available for download from the Lantronix's Website at www.lantronix.com/products/xport. See page 13 for specifications and page 51 Ethernet Port Setup.

External Keypad Connections

Normally open pushbuttons may be wired to the digital inputs connector for use when the front panel of the controller is not accessible. The external keys may be assigned to replicate the Menu and F1-F4 function keys.

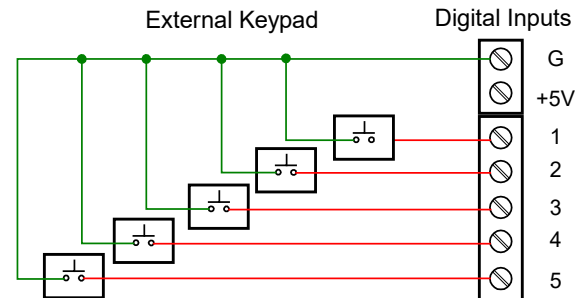

Figure 29. External Keypad Connections

Navigating and Editing

The device displays various screens throughout programming and operation. Functions are programmed within their respective menu screens and in many cases are accompanied by user prompts.

Soft-Keys and Buttons

The unit is equipped with five buttons located below the display. The function of each button corresponds to its soft-key, which appears at the bottom of the screen. Buttons assume different functions, which change according to the screen in view.

Screen Navigation



Menu Navigation



Selections are highlighted with green background for illustration purposes. The keys below are used to navigate through menus and edit settings. Other special keys appear throughout the programming process.

Note:

This is not a touch-screen display; the pushbuttons must be used to activate the soft-key

Key	Action
Menu	Enter menu
Right-key →	Step into menu/setting
Left-key ←	Exit/go back
Down-key ↓	Next screen/channel/setting
Up-key ↑	Previous screen/channel/setting
Stop	Stop automatic scan
Scan	Scan screens automatically
Ack	Acknowledge alarms/relays
Reset	Reset total/max/min
Setup	Enter the Setup menu
Edit	Modify selection
Enter	Execute keypad entry
Ok	Accept setting change
Save	Save all settings in view
Cancel	Discard changes
Delete	Delete channel/item
New	Create new channel/alarm
←	Move cursor left
→	Move cursor right
X→	Delete to the right
←X	Delete to the left
≡	Access additional settings or actions

Setup and Programming

There is **no need to recalibrate** the instrument when first received from the factory. The device is **factory calibrated** prior to shipment, for all input types and 4-20 mA outputs. The calibration equipment is certified to NIST standards.

Overview

Setup and programming are done through the front panel buttons or with the ConsoliDator+ Software. After power and signal connections have been completed and verified, apply power to the instrument.

Inputs, outputs, channels, and relays are configured individually. It is recommended that all inputs be configured before channels, outputs, and relays are programmed.

Shown below are typical screens that appear upon first power-up. Actual screens will vary with the amount of inputs initially detected. Screens may be edited, deleted, or added to fit the application.

For information on soft-keys and button functions, see Soft-Keys and Buttons on page 24.

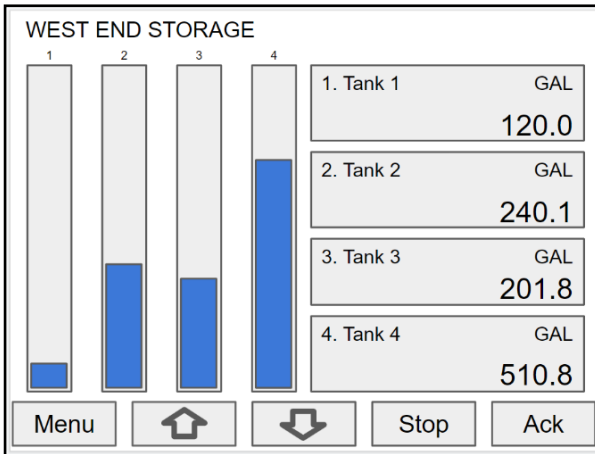

Typical screen view displaying 4 channels and 4 bargraphs representing the values of each channel.

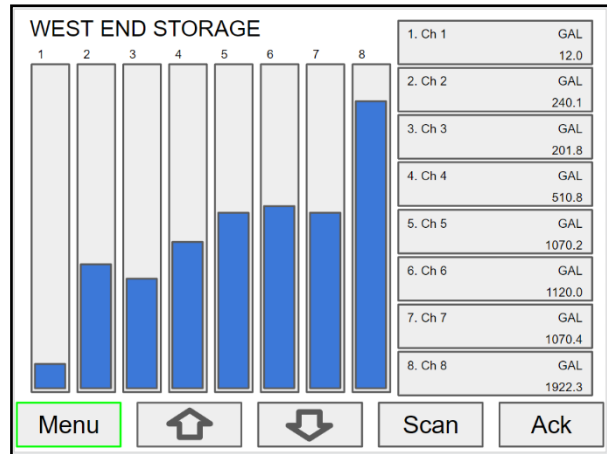

Typical screen view displaying 8 channels and 8 bargraphs representing the values of each channel.

Press the **Menu** key to begin setup and programming

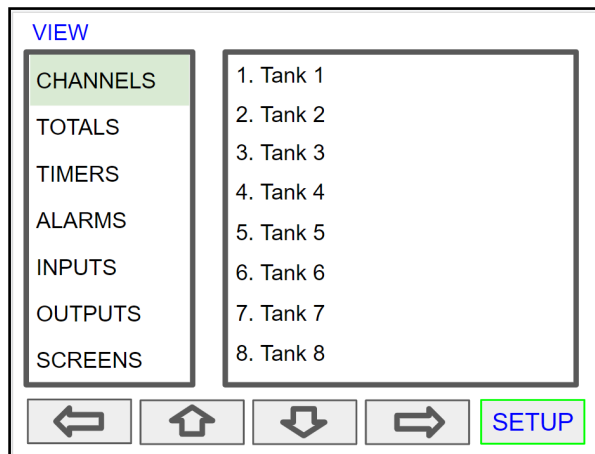

The View screen allows a user to view all the settings and values for Channels, Totals, Timers, etc. To program the instrument, press the **Setup** key.

Setup Menu

The *Setup* menu is the starting point during the programming process for setting up *Channels*, *Totals*, *Timers*, *Alarms*, *Inputs*, *Outputs*, *Screens*, and *System* settings. The number of channels shown on this screen is determined by the number of channels previously configured. More channels may be added to the list, by selecting *New* in the *Setup Channels* menu.

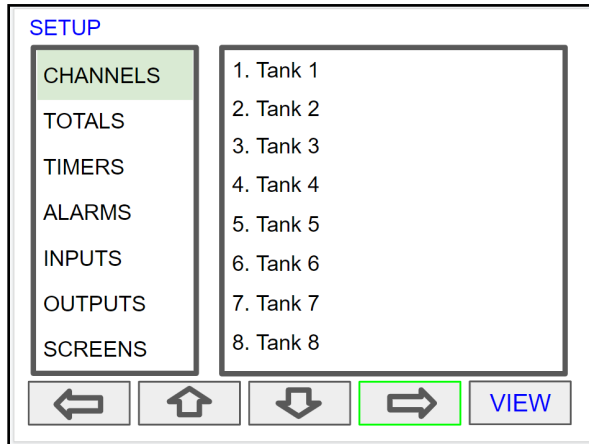

Press **Right Arrow** key to step into channels.

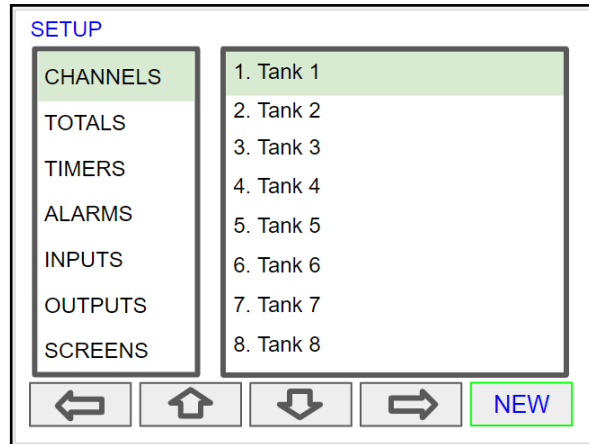

Press **New** key to create a new channel.
Go to page 30 for details.

Channel Parameters

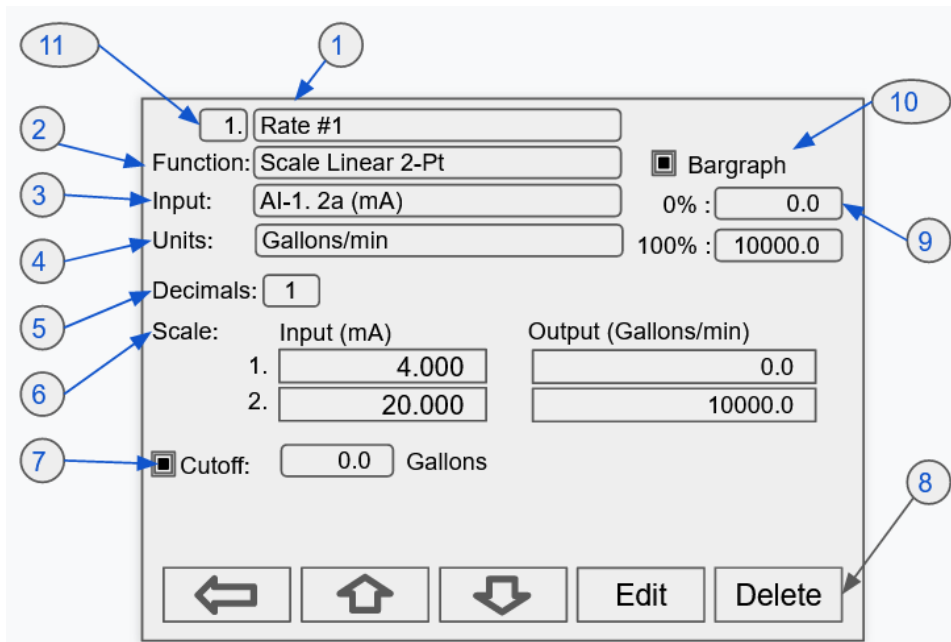

<p>1. Channel tag: User-editable</p> <p>2. Function*: This is the function applied to the input source</p> <p>➤ Scale</p> <ul style="list-style-type: none"> • Scale Factor • Scale Linear 2-Pt • Scale Multi-Point • Scale Square Root • Scale Exponent • Round Horz Tank* • Units Conversion** <p>➤ Math</p> <p>➤ Compare</p> <p>➤ Measure</p> <p>➤ Control</p> <p>➤ Relays</p> <p>➤ Modbus</p> <p>➤ Other</p> <p>Note: See next column for available Math and other functions.</p> <p>*Round Horz Tank: Available only if Input units is distance (height)</p> <p>**Use for custom units</p>	<p>➤ Math</p> <ul style="list-style-type: none"> • Constant • Summation • Difference • Absolute Difference • Absolute Value • Average • Weighted Average • Multiply • Divide • % Efficiency <p>➤ Compare</p> <ul style="list-style-type: none"> • Greatest • Least <p>➤ Measure</p> <ul style="list-style-type: none"> • Tare • Maximum • Minimum • Percent (Bargraph) • Duration <p>➤ Control</p> <ul style="list-style-type: none"> • Sampler • On-Off Control <p>➤ Relays</p> <ul style="list-style-type: none"> • Cycle Count • Runtime <p>➤ Modbus</p> <ul style="list-style-type: none"> • Time Since Read <p>➤ Other</p> <ul style="list-style-type: none"> • None (Reserved) 	<p>3. Input: Source for the channel (PV)</p> <ul style="list-style-type: none"> • mA Input (4-20 mA) • Pulse Input • Digital Input • Modbus Input • Channel • Total • Timer • Alarm • mA Output • Relay Output • Digital Output • Modbus Output 	<p>4. Units: Engineering units / time or none</p> <ul style="list-style-type: none"> • None • Time • Distance (Height) • Volume • Pressure • Weight • Temperature • Percent • Amps • Volts • Counts • Logic • Custom <p><i>Note: There is no units conversion</i></p> <p>5. Decimals: Number of decimals for the PV</p> <p>6. Input scale: Enter input and output values</p> <p>7. Cutoff: PV goes to zero below the cutoff value</p> <p>8. Soft keys: These change based on the screen in place</p> <p>9. Bargraph scale: Set the 0 and 100% values</p> <p>10. Display bargraph: Display on the screen</p> <p>11. Auto-generated channel #: User-editable to re-order channels</p>
--	--	--	--

Data Entry Keypad

The system provides a soft-keypad for entering values and tags; it contains numbers, alpha characters, and symbols.

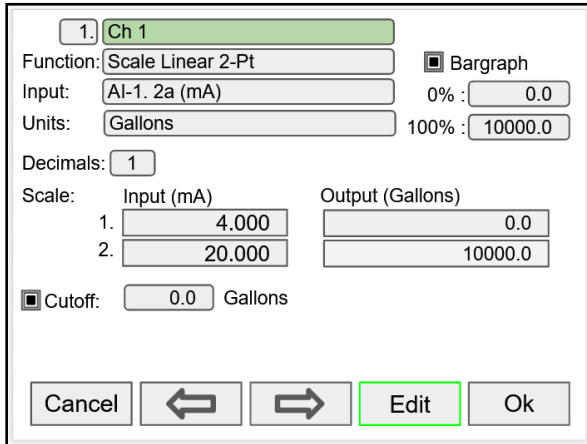

Press **Edit** key to start editing the channel configuration. The green background indicates the field to be edited. Press **Edit** key again to change the channel's tag, this opens the data entry keypad.

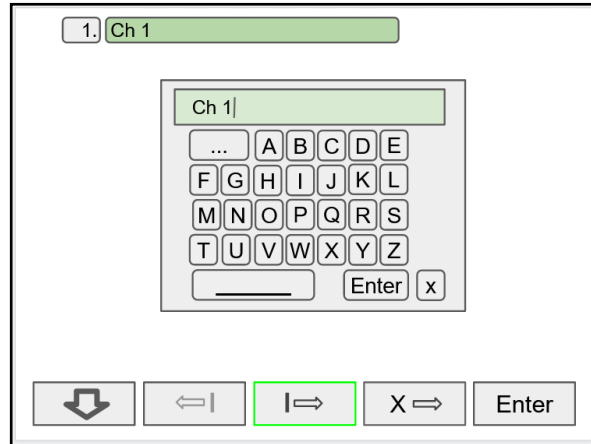

Use the Down Arrow key to navigate to the keypad. Use the **|>** and **<|** keys to move the cursor and use the **X->** key to delete characters. To enter characters in the selected text field, use the **arrow** keys to navigate through the popup keypad.

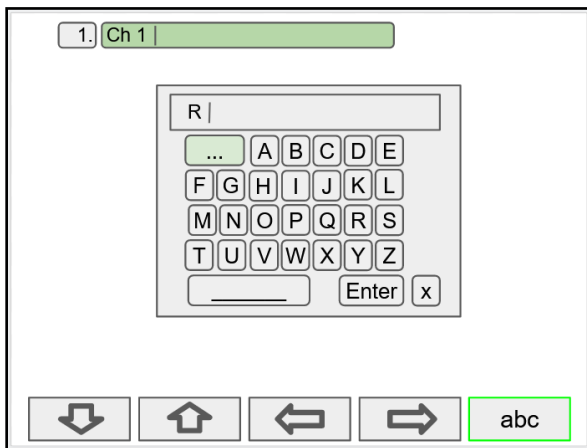

To change the character set navigate to the **three dots** and press the key indicating the next set of characters.

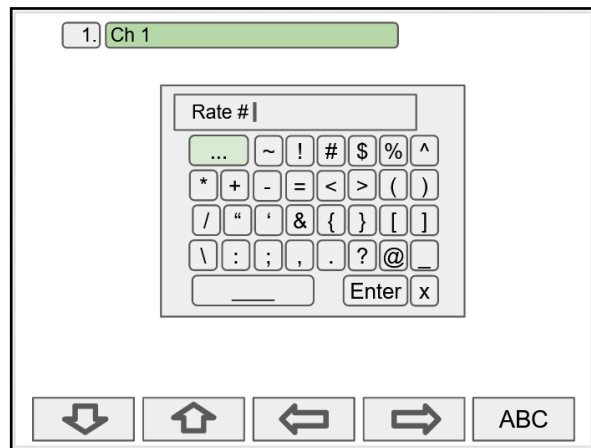

To enter symbols press the **three dots** and select the desired symbol.

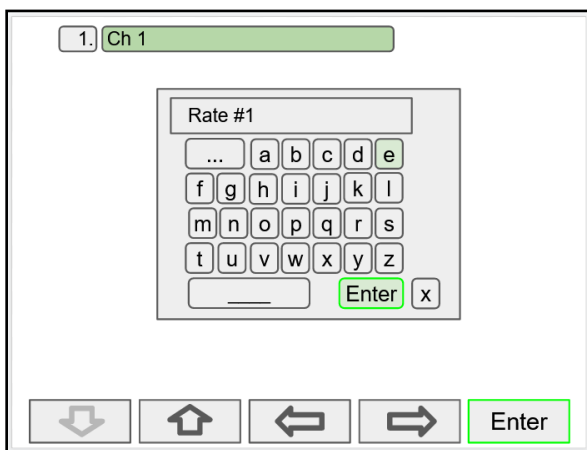

When done typing the characters in the selected field, press the **Enter** key.

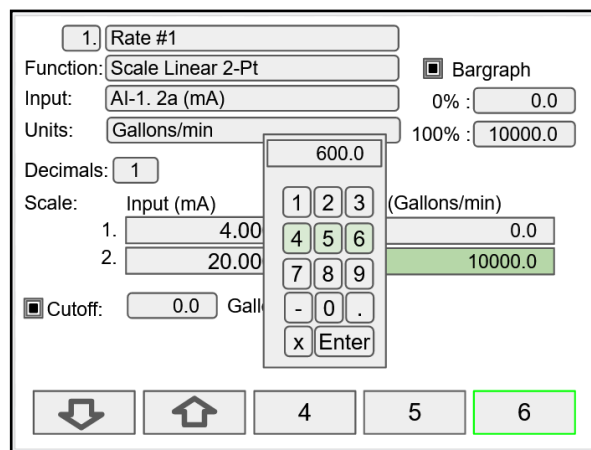

To enter numbers select the numeric keypad, move the cursor to the insertion point and enter the number using the soft keys. Press **Enter** to accept the changes.

1. Rate #1

Function: Scale Linear 2-Pt Bargraph

Input: AI-1. 2a (mA) 0% : 0.0

Units: Gallons/min 100% : 10000.0

Decimals: 1

Scale:	Input (mA)	Output (Gallons/min)
1.	4.000	0.0
2.	20.000	10000.0

Cutoff: 0.0 Gallons

Cancel [Home] [Down] [Left] Save

Press the **Save** key to save changes.

1. Rate #1

Function: Scale Linear 2-Pt Bargraph

Input: AI-1. 2a (mA) 0% : 0.0

Units: Gallons/min 100% : 600.0

Decimals: 1

Scale:	Input (mA)	Output (Gallons/min)
1.	4.000	0.0
2.	20.000	600.0

Cutoff: 0.0 Gallons

Cancel [Home] [Down] [Left] Save

Press the **Save** key to save the changes. The bargraph is automatically adjusted to reflect the scale entered.

The bargraph scaling may be changed without affecting the input scaling.

Setup Channels

The *Setup Channels* menu is used to configure each channel, enter a tag, select the input source, scale the input, and program other settings that will determine the channel's processing capabilities.

- Use the **Arrow** keys to navigate through the existing channels
- Press the **New** key to create a new channel
- Press the **Right Arrow** key to step into the channel setup
- Press the **Edit** key to make changes to a particular channel
- Press the **Delete** key to delete a channel

SETUP

CHANNELS	1. Ch 1
TOTALS	2. Ch 2
TIMERS	3. Ch 3
ALARMS	4. Ch 4
INPUTS	5. Ch 5
OUTPUTS	6. Ch 6
SCREENS	7. Ch 7
	8. Ch 8

[Left] [Home] [Down] [Right] New

Create New Channel

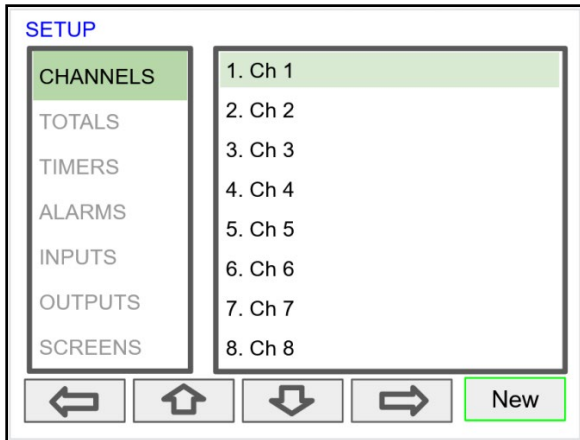

To create a new channel press the **New** key.

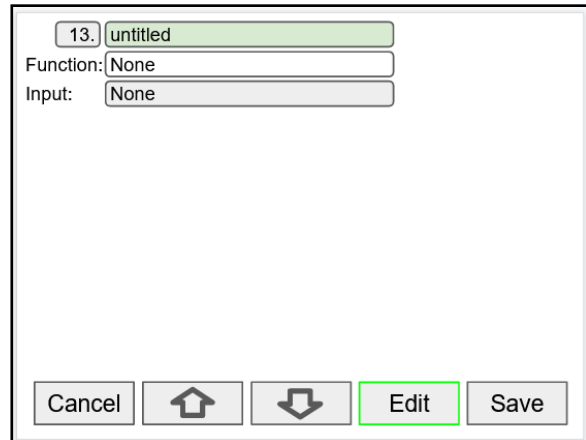

Press the **Edit** key to edit the channel tag and other settings. Press the **Up** and **Down** arrow keys to select setting to be edited.

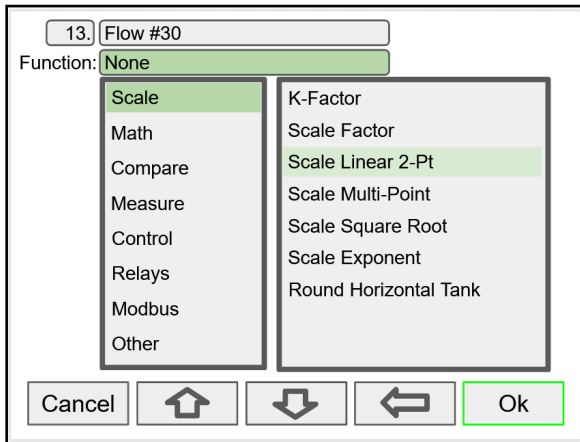

Select the function to be applied to the input and press the **OK** key.

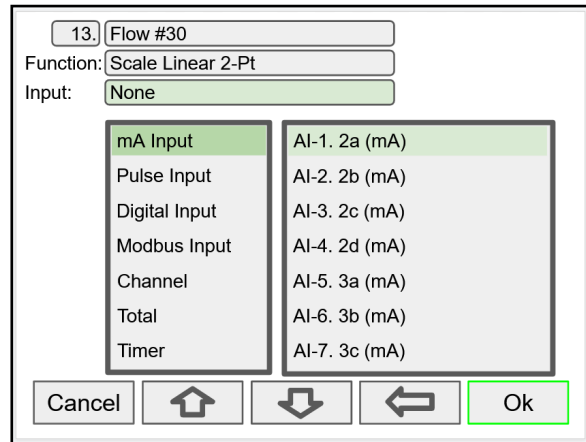

Select the input source for the channel.

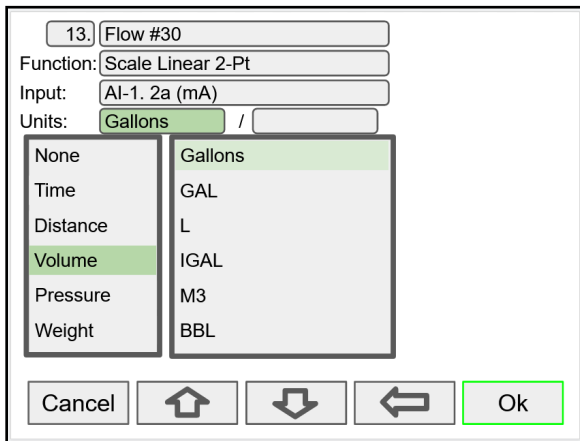

Select the engineering units, decimal point, enter scale points and press the **Ok** key.

Edit Channel

1. Rate #1

Function: Scale Linear 2-Pt Bargraph

Input: AI-1. 2a (mA) 0% : 0.0

Units: Gallons/min 100% : 10000.0

Decimals: 1

Scale:	Input (mA)	Output (Gallons/min)
1.	4.000	0.0
2.	20.000	10000.0

Cutoff: 0.0 Gallons

← ↑ ↓ Edit Ok

To edit a channel press the **Edit** key and navigate to the setting you want to change, press **Edit** again and make the changes required.

1. Rate #1

Function: Scale Linear 2-Pt Bargraph

Input: AI-1. 2a (mA) 0% : 0.0

Units: Gallons/hr 100% : 60000

Decimals: 0

Scale:	Input (mA)	Output (Gallons/hr)
1.	4.000	0
2.	20.000	60000

Cutoff: 0.0 Gallons

← ↑ ↓ Edit Save

After making all the changes, press the **Save** key.

Delete Channel

1. Rate #1

Function: Scale Linear 2-Pt Bargraph

Input: AI-1. 2a (mA) 0% : 0.0

Units: Gallons/min 100% : 10000.0

Decimals: 1

Scale:	Input (mA)	Output (Gallons/min)
1.	4.000	0.0
2.	20.000	10000.0

Cutoff: 0.0 Gallons

← ↑ ↓ Edit Delete

To delete a channel press the **Delete** key and follow the instructions.

1. Rate #1

Function: Scale Linear 2-Pt Bargraph

Input: AI-1. 2a (mA) 0% : 0.0

Units: Gallons/min 100% : 10000.0

Decimals: 1

Scale:	Input (mA)	Output (Gallons/min)
1.	4.000	0.0
2.	20.000	10000.0

Cutoff: 0.0 Gallons

ARE YOU SURE?

Delete this channel?

Cancel Ok

Press the **Ok** key to delete the channel or the **Cancel** key to cancel delete action.

2-Point Linear Scaling

Linear mode refers to basic 2-point scaling of a 4-20 mA signal in engineering units. The graph in Figure 30 shows the display response based on example scaling parameters. For this mode select [Scale Linear 2-Pt] from *Function* options, then enter your scaling parameters.

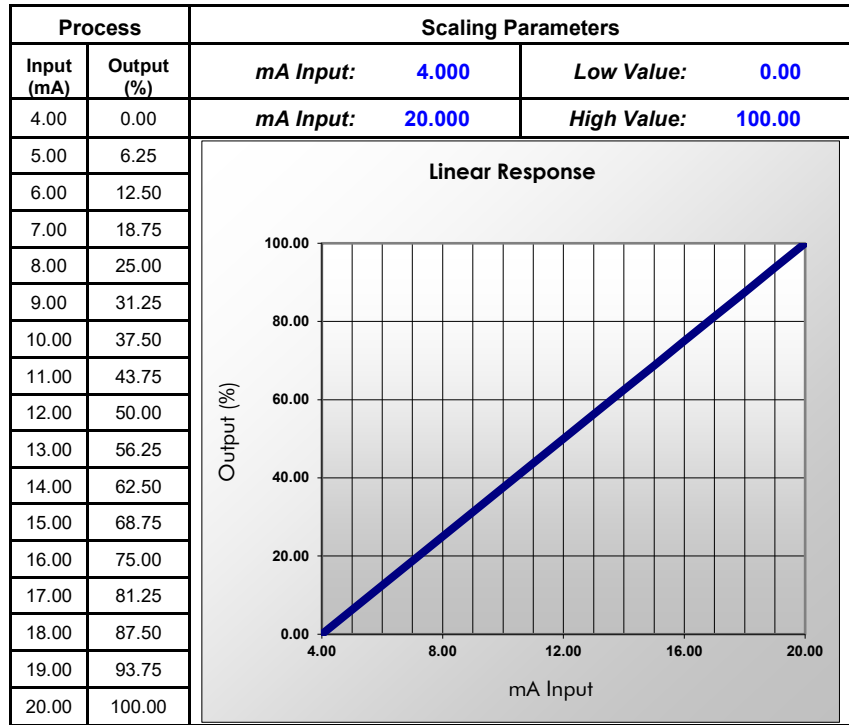

Figure 30. Linear Response Graph

Square Root Scaling

Square root mode refers to 2-point scaling with square root extraction typically used to linearize the signal from a differential pressure transmitter and display the flow rate in engineering units. The graph in Figure 31 shows the display response based on example scaling parameters. For this mode select [Scale Square Root] from *Function* options.

The square root mode supports low-flow cutoff which can be used to suppress readings below a programmed value. Below the cutoff value, the controller will display "0".

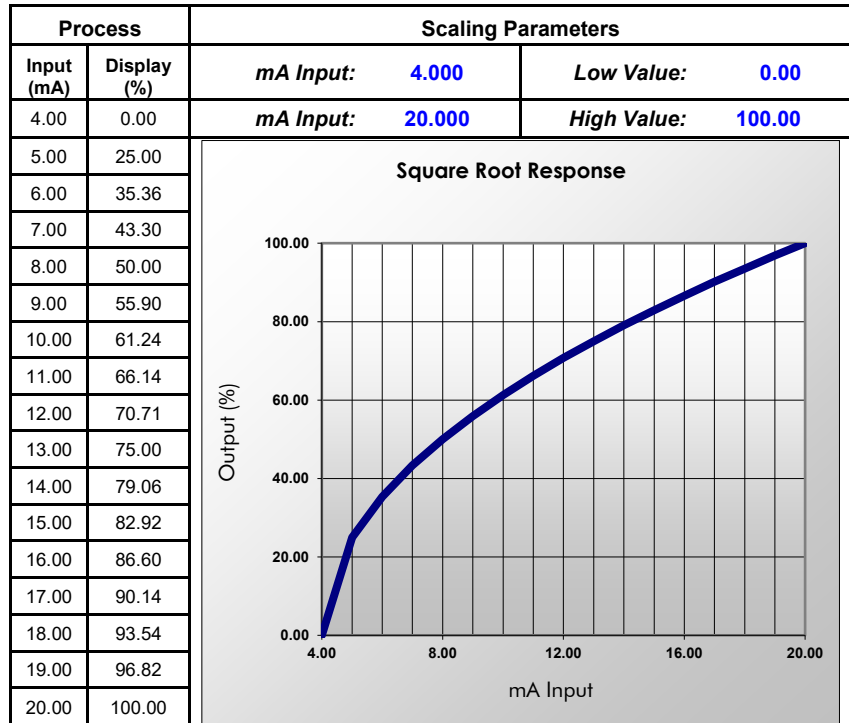

Figure 31. Square Root Response Graph

Scale Exponent

Exponent mode refers to 2-point scaling with programmable exponent, typically used in open-channel flow applications using weirs and flumes to linearize the signal from a level transmitter and display the flow rate in engineering units. The graph in Figure 32 shows the display response based on example parameters and exponent of "1.5". For this mode select [Scale Exponent] from *Function* options. The exponent mode supports low-flow cutoff which can be used to suppress readings below a programmed value. Below the cutoff value, the controller will display "0".

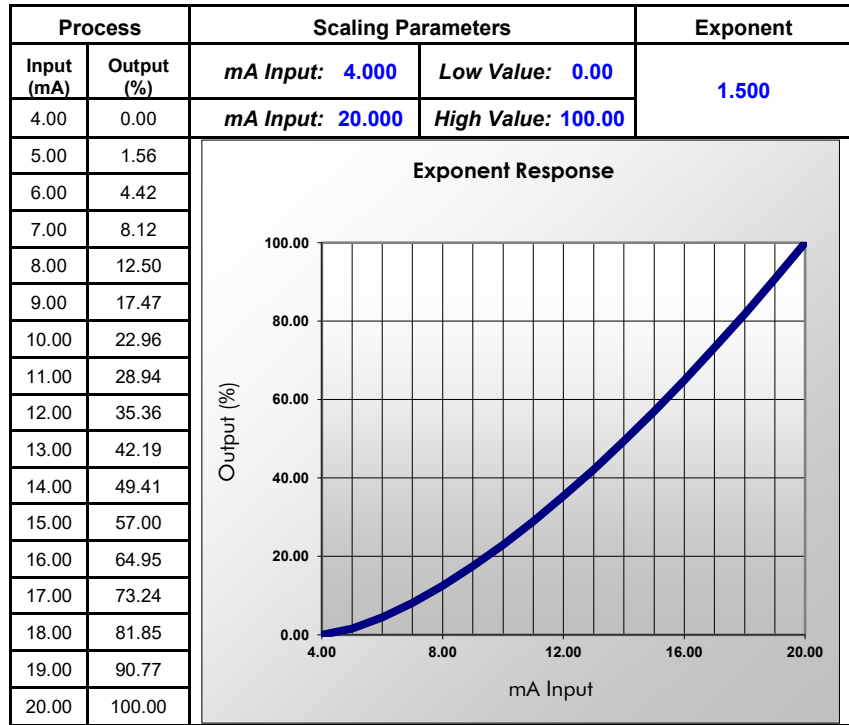

Figure 32. Exponent Response Graph

Open Channel Flow Application

The PD9000, in combination with an ultrasonic level transmitter, makes for an economical way to measure and display open channel flow rate and total in most weirs and flumes and take periodic samples. All the user needs to do is enter the exponent for the weir or flume into the PD9000 and the PD9000 automatically raises the input signal to that power. Sampling can be based on the total flow or the flow rate. For instance, to display open channel flow rate and total from a 3-inch Parshall flume and take a one pint sample every 100,000 gallons, the user would program the PD9000 as shown in the table above right.

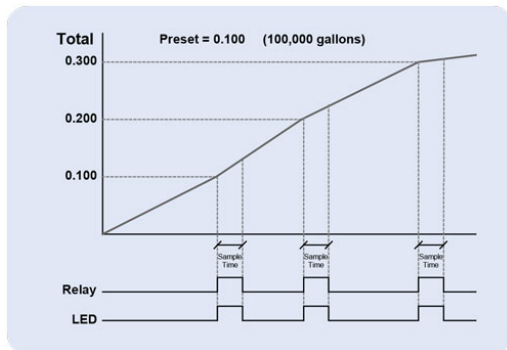

Figure 33. Total Relay Sampling Operation

Function	Desire	Programming
Open Channel Flow	3" Parshall flume	Create channel 1 to measure head height 4 mA = 0.000, 20 mA = 3.000 Ft
Flow Rate	Millions of Gallons per Day (MGD)	Create Ch 2 to measure flow rate Input for Ch 2: Ch 1 head height Scale Exponent: 1.547 0 Ft = 0.000 & 3.000 Ft = 3.508 Create custom unit = MG/day
Total	Millions of Gallons	Total 1 Input for Total 1: Ch 2 Flow Rate Units: MG Total Conversion Factor = 1 Roll-Over = 1,000 MG
Non-Resettable Grand Total	Program Grand Total so it cannot be reset	Total 2: Grand Total Input for Total 1: Ch 2 Flow Rate Units: MG Total Conversion Factor = 1 Select Non-Resettable function Roll-Over should be disabled
Screen (Display)	Open Channel Flow	Create screen to display: <ul style="list-style-type: none"> • Ch 1 Head Height • Ch 2 Flow Rate • Total 1 Running Total • Total 2 Grand Total Relay 1 Sampling Valve
Sampling	Sampler Channel Take a 1 pint sample every 100,000 gallons	Create Sampler channel 3 Function: Control – Sampler Input: Total 1 Sample Size: 0.1 million gallons Sample Time: 30 seconds
Sampling Relay	Relay to control valve	Setup relay 1 to control sampling valve Input to Relay 1: Ch 3 Every time the total increments by 0.1 MG the relay opens the valve for 30 sec

Round Horizontal Tank

The *Round Horizontal Tank* (RHT) function calculates the volume of round tank with flat ends, based on the diameter and length dimensions of the tank.

The input source for the channel calculating the volume, must be a level channel with units of distance (height). The RHT function linearizes the signal from a level transmitter and display the volume in engineering units. The graph in Figure 34 shows the display response based on tank example:

Diameter = 48.00 inches

Length = 120.00 inches

For this mode select [*Round Horz Tank*] from *Function* options.

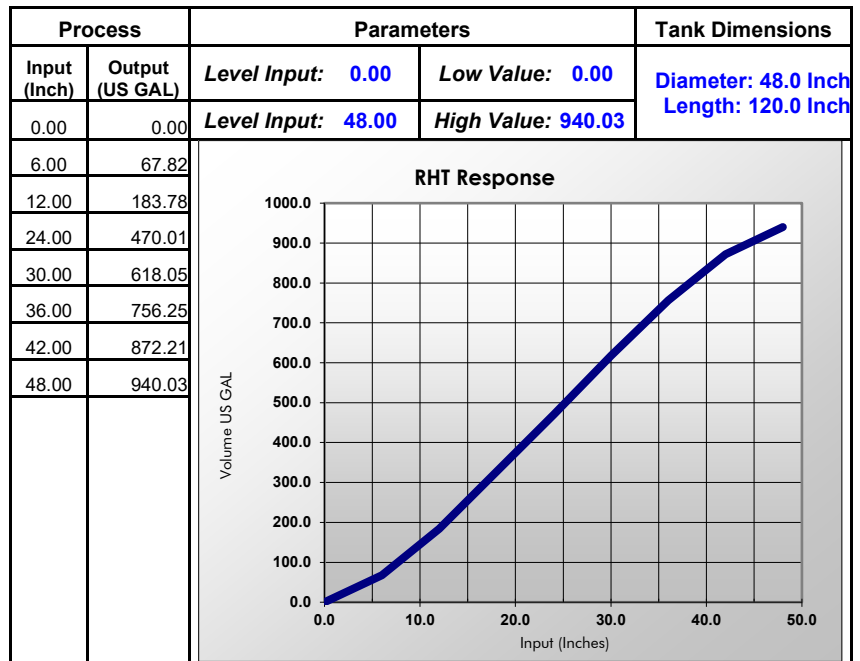

Figure 34. Round Horizontal Tank Volume Graph

Setup Math Functions

There are many math functions that can be applied to any channel, which allows the execution of simple or complex math functions. Math channels can be the source for other math channels, totalizers, alarms, and analog outputs.

Application:
VOC Destruction Efficiency in Thermal Oxidizer

$$\text{Thermal Oxidizer Efficiency} = (\text{Inlet VOC} - \text{Outlet VOC}) / \text{Inlet VOC}$$

4-20mA output = 0-100% efficient

$$\text{Efficiency} = ((\text{Ch1} - \text{Ch2}) / \text{Ch1}) * 100$$

Ch1 = Inlet VOC
Ch2 = Outlet VOC

AO-1 Source = Ch 20. VOC %Efficiency
AO-1 Scale: 4-20 mA = 0-100% efficiency

VOC: Volatile Organic Components

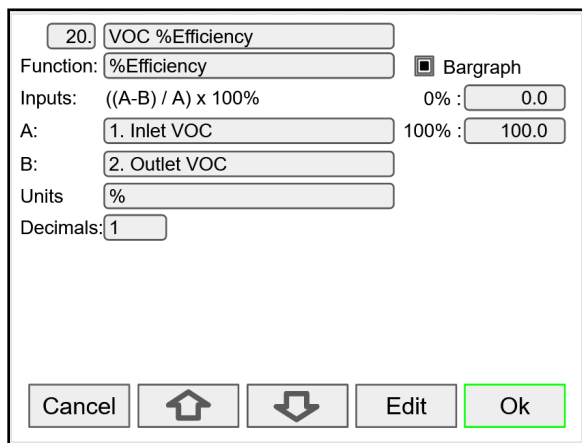
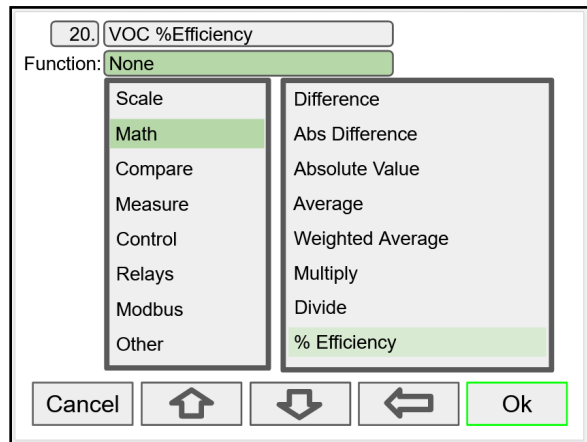

Enter the input sources for the math function, select the units and number of decimals, and press **Ok** and **Save**.

List of Math Functions

1. Constant
2. Summation
3. Difference
4. Absolute Difference
5. Absolute Value
6. Average
7. Weighted Average
8. Multiply
9. Divide
10. % Efficiency

Additional Functions

Compare

- Greatest
- Least

Measure

- Tare
- Maximum
- Minimum
- Percent (Bargraph)
- Duration

Control

- Sampler
- On-Off Control

Relays

- Cycle Count
- Runtime

Modbus

- Time Since Read

Setup Totalizers

The totalizers are setup the same way as the channels. The analog channel rate is integrated over the specified time unit to generate an accumulated total that can be configured to count up or down. Each total may be assigned as “non-resettable”, which means the total reset functions are not available for it.

The pulse inputs and digital inputs can be either integrated from a rate channel or they can be directly totaled based on the pulse count and K-Factor; this is the most accurate method because every pulse is counted.

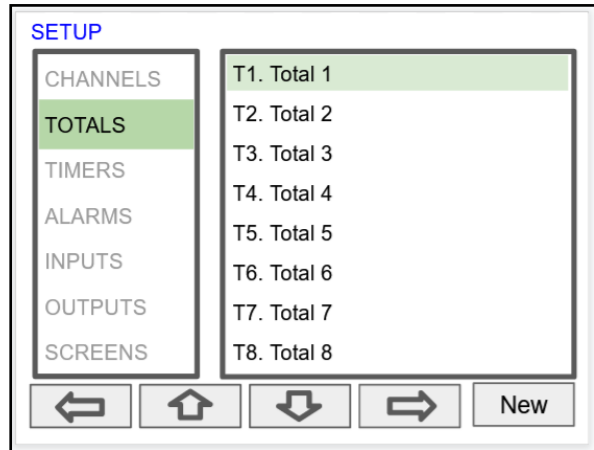

Setup Total with Rate Source

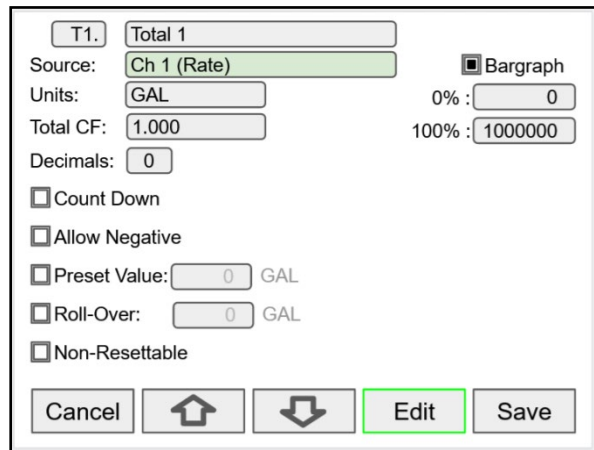
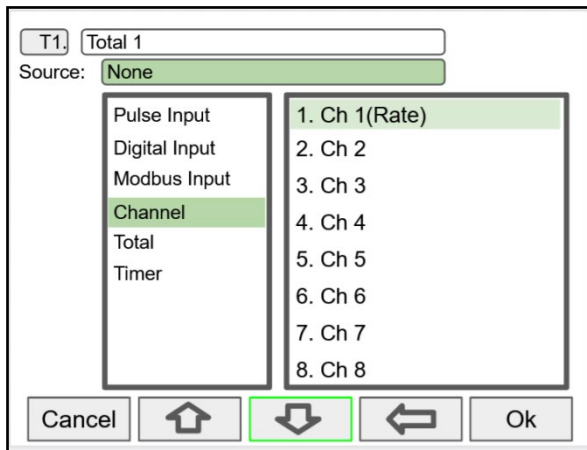

Note:
Total based on rate uses Total Conversion Factor (Total CF) to calculate total in non-standard engineering units.

Setup Total with Pulse Input Source

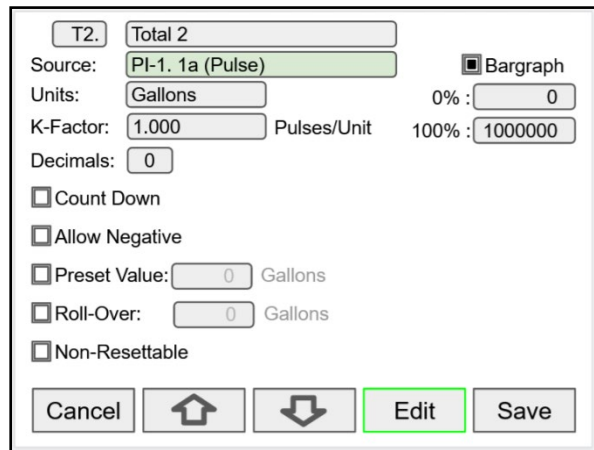
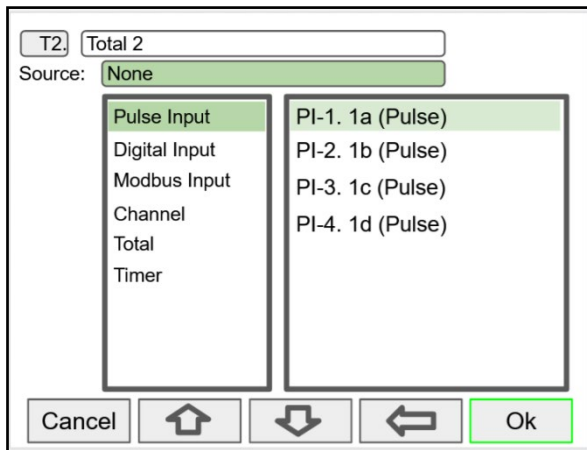

Setup Timers

Up to 32 timers may be setup to control and monitor various processes. The timers may be triggered by any input or output, such as an analog input rising above a certain threshold or a digital input going from low to high.

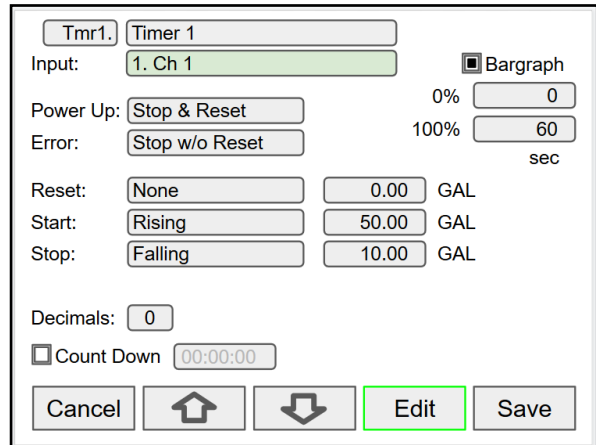
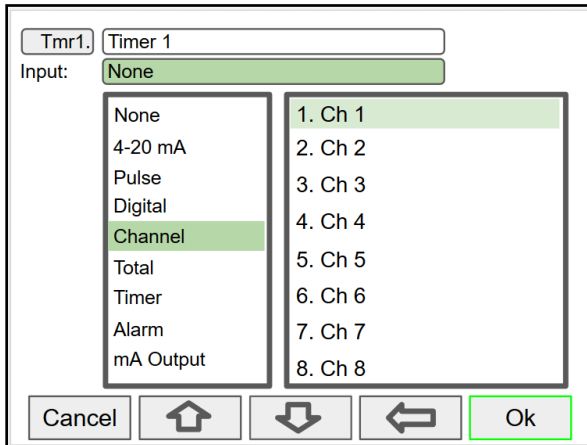
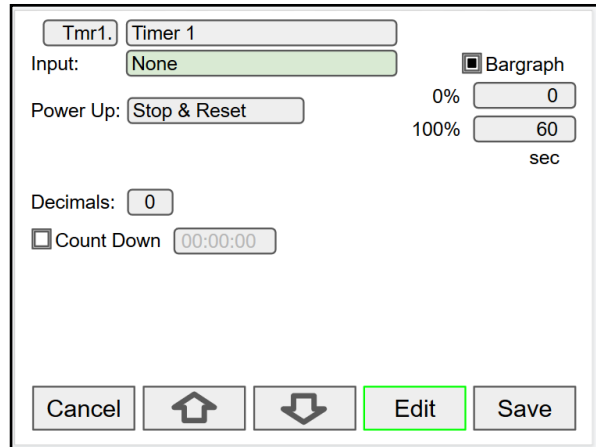
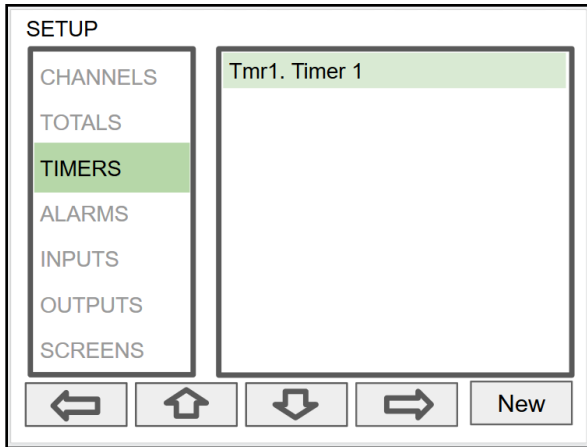

Timer Automatic Actions

The automatic timer actions are:

- Power Up: Timer action on power up
- Error: Timer action when an error is detected
- Reset: Event that causes the timer to reset
- Start: Event that triggers the timer to start
- Stop: Event that causes the timer to stop

Timer Function Keys & Digital Inputs

The function keys and digital inputs may be used to start, stop, and reset the timers, regardless of the automatic actions selected.

Time Format

The time format is hh:mm:ss with 0 decimals selected. If decimal is other than 0, the time is displayed in seconds with the number of decimals selected.

Count Down Timer

Select count down and enter the starting time count.

Timer Bargraph

The bargraph scaling follows the time format selected, based on decimal point.

Timer Alarms

Alarms may be setup to trigger on timer values, counting up or down. Go to the *Alarms* menu and select a timer as the source for the alarm.

Setup Alarms

The system is capable of handling up to 64 alarms; they can be driven by a single channel, multiple channels, digital inputs, time interval, or a combination of other alarms into logic AND & logic OR alarms. Set and reset point values determine if it is a high or low alarm and the dead band. Alarms may be setup as latching or non-latching (automatic) with on and off time delays.

1. Tag: 15-character user-defined
2. Type: Select alarm type
 - Single Source
 - Multi-Source
 - Time Interval
 - Alarms OR
 - Alarm AND
3. Input: This will depend on type selected
 - Type: Single and Multi-Source
 - Digital
 - Modbus
 - Channel
 - Total
 - Timer

Type: Alarms AND & OR
Inputs: Other alarms
4. Automatic: Resets when PV crosses the reset point
5. Ack Anytime (Latching): Ack alarm anytime
6. Break: Alarm status when sensor/comm. break is detected (e.g. Input < 0.01 mA)
 - Alarm On
 - Alarm Off
 - Stay (Maintain the state before the break)
7. On/Off Delays

Multi-Source Alarm

This alarm type behaves as a logic OR; if any of the sources crosses the set point, the alarm goes on.

If the first source is digital (logic), only sources with digital value (on = 1, off = 0) are available for selection.

If the first source is a PV channel or timer, digital inputs may be added as source.

Latching & Non-Latching Alarms

Reset (Ack)	Ack Anytime	Automatic
Auto & Manual	X	X
Auto Only	0	X
Manual Only	X	0
Manual Only After Cleared	0	0

Automatic reset and Ack anytime
Relay assigned to Horn activates on alarm condition

Automatic only: Alarm resets automatically at the reset point

Latching: Acknowledge only after the alarm condition has cleared

Manual Ack (Latching): Select Ack Anytime only

Logic OR Alarm

The inputs for the logic OR alarm are any existing alarms, regardless of the source or type. Any active alarm in the group triggers the OR alarm. The OR alarm can be used as a summary alarm.

Logic AND Alarm

The inputs for the logic AND alarm are any existing alarm, regardless of the source or type. All alarms in the group must be active in order to trigger the AND alarm.

Logic NOR & NAND Alarms

To create a NOR alarm, select an existing OR alarm and apply the **Not** function available during Setup – Edit. The same applies to the NAND alarm. Any input alarm may be inverted (Not) to create a specialized alarm logic.

Setup Inputs

The *Setup Inputs* screen is used to configure the hardware inputs, assigning a user-defined tag, and setting filter values.

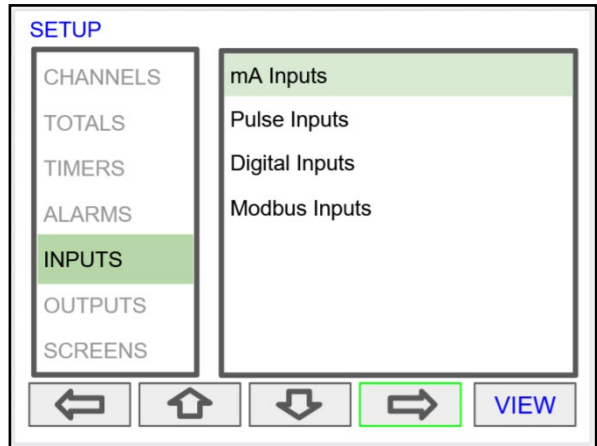

Setup 4-20 mA Inputs

The top line shows the slot # and input location (2b = slot #2, second input from the left). It also shows the actual current input.

The next line shows the input type and # (AI-2) with the default tag, which can be changed at any time.

- Filter*: Select filter time
- Bypass: If the signal change is greater than the bypass value, the reading jumps to the actual value \pm Bypass % of full scale.
- Glitch Filter: Eliminates short duration noise spikes
- Break Below: Set the mA value at which a sensor break is reported to the system.
- Disable Input Channel: This turns off the power to the input, but the settings are saved for future use. This should only be used to save power on unused inputs.

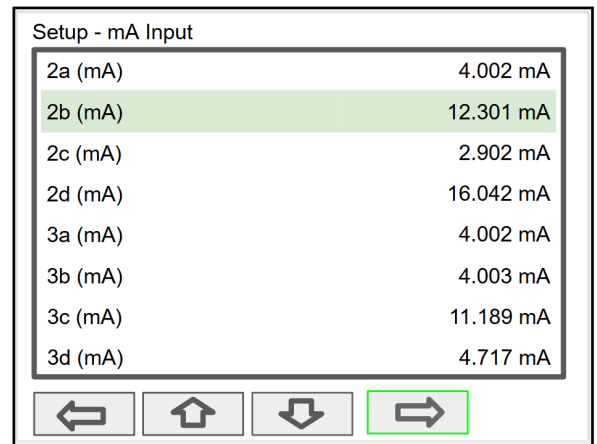

**Need more filtering?
If you need a more stable reading,
select IIR 16 sec or IIR32 sec setting.*

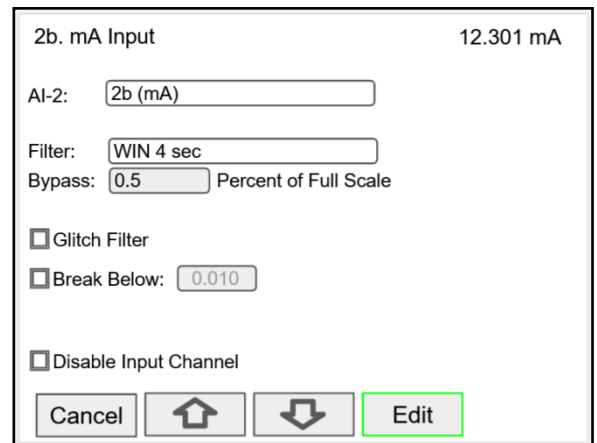

Setup Pulse Inputs

The top line shows the slot # and input location (1a = slot #1, first input from the left). It also shows the actual frequency, state of the input, and the number of pulses received since power up, to a maximum of 65,535.

The next line shows the input type and # (PI-1) with the default tag, which can be changed at any time.

- Type: Select the pulse input type.
- Low Gate: this is the time window used to calculate and update the rate.
- High Gate: This is the time window used to calculate slow rates before the rate goes to zero.
- Low Speed: This setting is used as a de-bounce filter for contact closure or switch inputs.

Threshold:
Is the voltage level at which a transition from high to low is detected. For example, the "Active 1.2V Thrshld" setting will detect a square wave signal when it falls below 1.2 V.

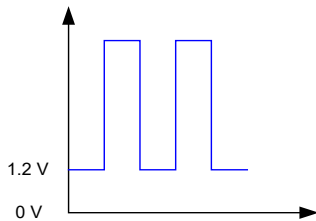

1a: Pulse Input 9999.99
65535

PI-1:

Type:

Low Gate:

High Gate:

Low Speed, 100 Hz max

1a: Pulse Input

PI-1:

Type:

Active 1.2V Thrshld

NPN 1.2V Thrshld

PNP 1.2V Thrshld

Reed Switch

Coil 20 mV Thrshld

Active 2.5V Thrshld

NPN 2.5V Thrshld

PNP 2.5V Thrshld

Coil 100 mV Thrshld

Low Gate:

High Gate:

Low Speed, 100 Hz

Setup Digital Inputs

The digital inputs may be assigned to perform various user functions, such as trigger alarm, acknowledge alarms, reset total, etc.

Pulse inputs may be used as digital inputs by setting them up according the type of input they are intended to accept. For example, to accept a contact closure the pulse input must be setup for *Reed Switch* type input.

Setup - Digital Input

DI-1. Digital Input 1	OFF
DI-2. Digital Input 2	ON
DI-3. Digital Input 3	OFF
DI-4. Digital Input 4	OFF
DI-5. Digital Input 5	ON
PI-1. 1a (Pulse)	ON
PI-2. 1b (Pulse)	ON
PI-3. 1c (Pulse)	ON
PI-4. 1d (Pulse)	ON

Digital Input Functions

Digital Input OFF

DI-1:

Active Low

Function:

Digital Input

DI-1:

Active

Function:

None	Ack Alarm
Button	Reset Alarm
Channel	Set Points
Total	
Timer	
Alarm	
Screens	
Horn	
Relay	

A digital input can be used to execute one of the listed functions and at the same time, it can be used to trigger an alarm or to totalize (count) how many times the function has been executed (e.g. Reset Total).

- None: Use digital input (DI) to trigger an alarm or timer
- Button: Digital input behaves as a front panel button
- Channel: Tare, Reset Tare, Reset Max, Reset Min
- Total: Access total functions
- Timer: Access timer functions
- Alarm: Access functions (Ack, Reset, Set Points)
- Screen: Next, Previous, Stop/Scan
- Horn: Silence, Snooze, Test
- Relay: Reset relay information

Digital Input

DI-1:

Active

Function:

Ack Alarm	All
Reset Alarm	A1. High Alarm 1
Set Points	A2. High Alarm 2
	A3. High Alarm 3
	A4. High Alarm 4
	A5. High Alarm 5
	A6. High Alarm 6

Note: The elements to be acted upon must be created before trying to setup the digital input; otherwise it is not available in the list of functions to execute. For example to assign the digital input to tare a channel, a Tare Channel must be created first.

Alarm Reset: The alarm condition is cleared, allowing the alarm to trigger again based on input.

Acknowledge: Input must cross reset point to trigger new alarm.

Setup Modbus Inputs

The controller is capable of accepting up to 199 Modbus inputs that may be used as the source for channels, math functions, alarms, relay control, etc. Once the data type is selected, the register number is display to the right.

- Enter Modbus Input tag
- Type: Select the data type
- Decimals: Number of decimals, if float
- Units: Select units or enter custom unit
- Break: Value or condition for comm. break
- Timeout: Select timeout to detect break
- Input Action: Select action when new value is received (e.g. Add to Total 1 the value written)

MB-1.

Type: Reg. No. 46701, 46702

Decimals:

Units:

Break: Default: GAL

Timeout:

Input Action:

Data Types

- Bit – Logic (Coil)
- Signed/Unsigned 16 (Short), 32 (Long), 64 (Long Long)
- Float 32, Float 64 (Double)

Setup All Outputs

The Setup Outputs screen is used to configure the hardware outputs, assigning a user-defined tag, scaling the mA outputs, associating relays with alarms, and configuring the digital outputs.

- mA Output: Configure analog outputs
- Relay Output: Configure relay outputs
- Digital Output: Configure digital outputs
- Modbus Output: Configure Modbus outputs

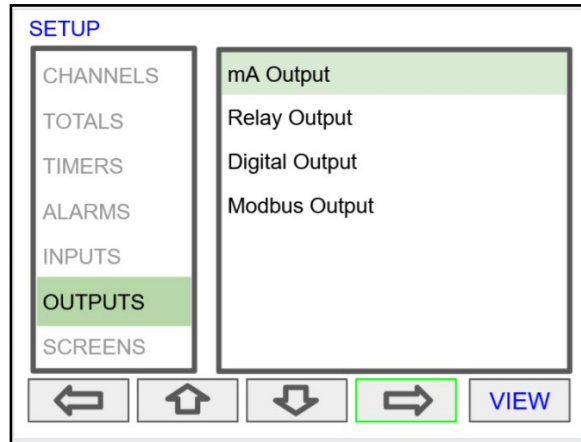

Setup 4-20 mA Outputs

The mA output may be assigned to any analog input, channel, alarm, or digital input. It may be scaled to any input and output value.

The top line indicates the slot # and position of the analog output (4a = slot #4, first position from the left). It also displays the actual mA output.

- AO-1: Analog output 1
- Input: Select source for the mA output
- Scale: Enter input and output values
- Sensor Break: mA output when sensor or communications break is detected
- Minimum: The minimum output allowed
- Maximum: The maximum output allowed
- Slew Rate: Rate of change in mA/sec
- Underrange: mA value when the PV goes below the low range value by more than 1%.
- Overrange: mA value when the PV goes above the high range value by more than 1%.

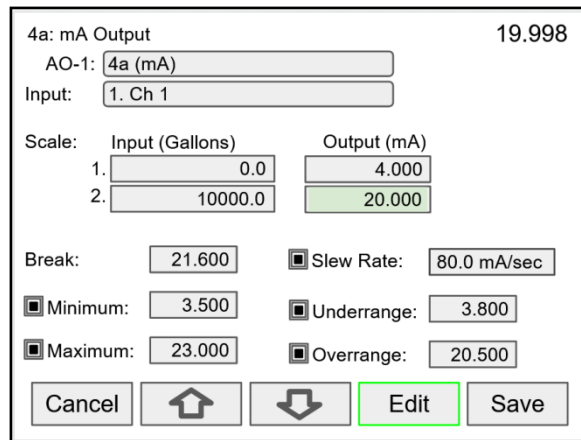

Setup Relay Output

The relays can be driven by a digital input, an alarm, or a channel. If the input source is a channel, set and reset points must be entered. These are the available setting depending on the source selected.

- Input: Select the source to drive the relay
- Set & Reset: Enter values to turn on & off the relay for Channel, Total, or Timer Input
- Pulse Output: Pulse relay on/off when set is active
- Break: The relay state when break detected
- Fail-Safe: Relay energized under normal conditions

*Function: Select **Other** to set relay to always on, always off, drive a relay-horn, or to alternate with another relay.*

Note: Relays driven directly by channel cannot be acknowledged; if Ack is required, use alarm to drive the relay.

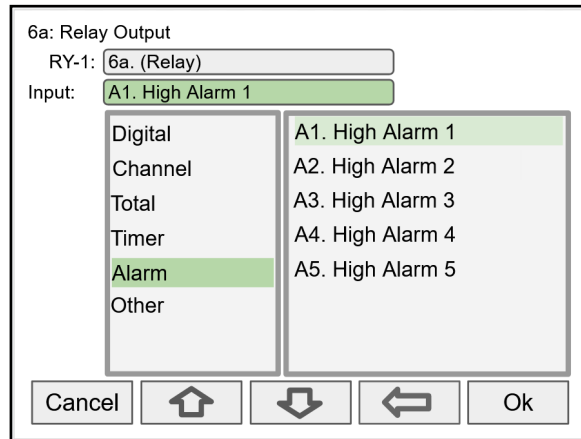

Relay Assigned to Channel

6b: Relay Output
 RY-2:
 Input:

Enable Alternation

Set (On): GAL/sec On Delay: sec
 Reset (Off): GAL/sec Off Delay: sec

Pulse Output

Break: On Time: sec
 Fail-Safe Off Time: sec

Relay Assigned to Alarm

6a: Relay Output
 RY-1:
 Input:

Enable Alternation

On Delay: sec
 Off Delay: sec

Pulse Output

Break: On Time: sec
 Fail-Safe Off Time: sec

Relays not assigned to alarms are used for automatic on/off control based on set & reset point.

Pump Alternation Relays

To setup a group of relays for pump alternation control, follow these steps.

1. Select the primary alternating relay
2. Select the input for alternation (e.g. Ch 1)
3. Enable alternation
4. Enable alternate on time and enter time
5. Enter the On & Off alternation points according to the number of relays to alternate
6. Select relay condition when input break is detected. Break point value must be entered in the Setup - Input menu for the 4-20 mA input.
7. Select fail-safe, if desired (Reverses the relay contacts state: NO closes and NC opens)
8. Enter the On & Off time delays
9. After saving the primary relay configuration, navigate to the next relay and configure it to alternate with the primary relay

Alternation Input Sources

Most level control applications use channels as the input. The channel is setup to read the signal from a level transmitter and display the level either in height or volume units. The continuous level monitoring allows for selecting multiple alternation points.

If the input is other than a channel, the alternation is limited to only one pump on at one time. A level switch could be connected to a digital input and the digital input will alternate the pumps for each on/off cycle.

Set (On) & Reset (Off) Points

Up to eight alternation points may be entered to alternate eight relays per group. The On & Off points determine if pumps are on when the level rises or when it falls.

On & Off Time Delays

To prevent turning pumps off and on at the same time, it's recommended to use On delays. The On & Off delays are common to all the relays in the alternation group.

Alternation Groups

An alternation group is made up of a primary relay and any number of relays selected to alternate with it.

Multiple alternation groups may be setup using different sources for each group. A relay should NOT be assigned to more than one group.

Alternate on Time

This is the maximum time any relay in the group will be continuously on. After the alternation time has elapsed, the relay will turn off and another relay will turn on. This feature is useful for applications where the level is maintained with one pump for a long time. Depending of the setup and conditions, it will help distribute the load among the pumps in the group.

Sensor Break

If *Relay On* is selected, only one of the alternation relays will be on when a break is detected.

6a: Relay Output

RY-1: 6a. Relay 1

Input: 1. Ch 1

Enable Alternation Alternate on Time: 00:05:00

	Set (On)	Reset (Off)
1.	40.00	25.00
2.	60.00	45.00
3.	80.00	65.00
4.	90.00	70.00

Break: Relay Off On Delay: 0.0 sec

Fail-Safe Off Delay: 0.0 sec

Buttons: Cancel, Home, Back, Edit, Save

Setup the Primary Alternation Relay.

6b: Relay Output

RY-2: 6b. Relay 2

Input: Alternation

- Digital
- Channel
- Total
- Timer
- Alarm
- Other
- Always Off
- Always On
- Horn
- Alternation

Buttons: Cancel, Home, Back, Forward, Ok

Setup the Additional Alternation Relays.

6b: Relay Output

RY-2: 6b. Relay 2

Input: Alternation

With: RY-1. 6a (Relay)

Fail-Safe

Buttons: Cancel, Home, Back, Edit, Ok

Select the Primary Relay to Alternate With.

Alternation Sequence

The first relay on is the first relay off, when more than one relay are activated.

Setup Digital Output

The Digital Output menu allows assigning the 4 outputs to various events generated by digital inputs, On/Off channels, alarms, and horn on state.

- Edit the digital output tag
- Select the input

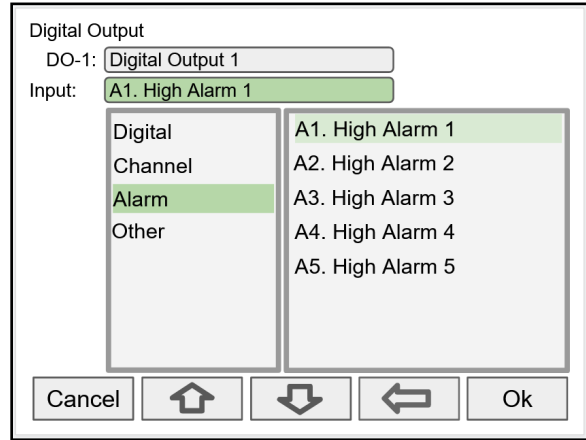

Setup Modbus Output

The *Modbus Output* menu allows assigning up to 64 Modbus register sets (1 to 4) to output any of the values available in the system (e.g. PV channels, Totals, Relay Runtime, etc.) and selecting the desired data type from bit-logic to float 64.

The function code is 0x03 and the registers are base-1 (e.g. Reg. Address 4400 = Reg. Number 44401).

- Edit the Modbus Output tag
- Select the source for the output
- Select the data type
- The register number is assigned by the system

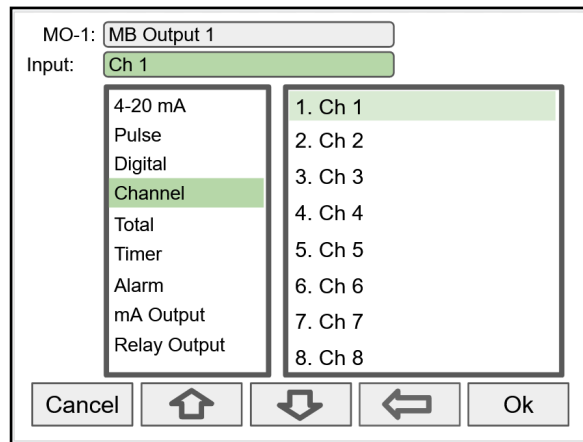

Select the input for Modbus Output.

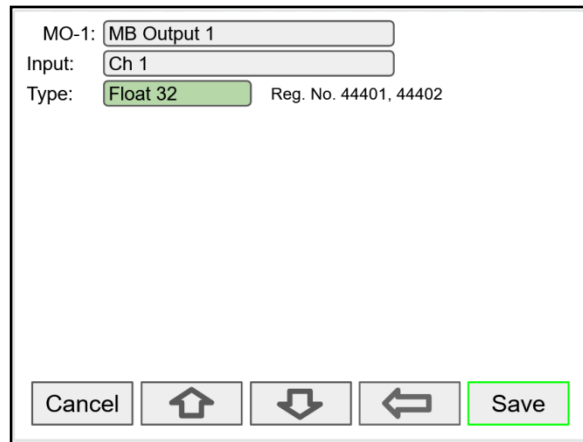
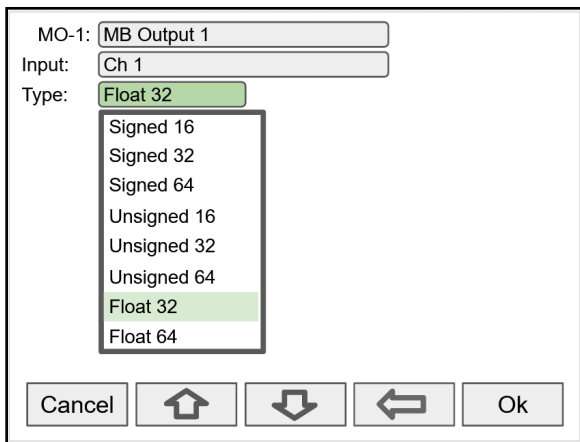

The register number is provided for each data type.

Select the data type.

Setup Screens

The *Setup Screens* menu is used to setup the screens that will be displayed during operation and to setup the actions assigned to the function keys F1-F4.

Screens Settings

Up to eight PVs and/or alarms may be displayed per screen. The screens can be setup to scan automatically, display bargraphs, and program the function keys to be used while the screen is visible.

These are the available settings:

- Title: User-defined title or tag
- Channels and alarms: Up to eight/screen
- Show Title: Select to display the title
- Show Channel #: Select to display the channel #
- Show Bargraphs: Select to display the bargraphs
- Bargraph Only: Select to display only the bargraphs
- Auto Scan: Select to scan the screens automatically
- Dwell Time: Number of seconds the screen is displayed before moving to the next screen
- F1 – F4: Assign functions to be executed by the function keys

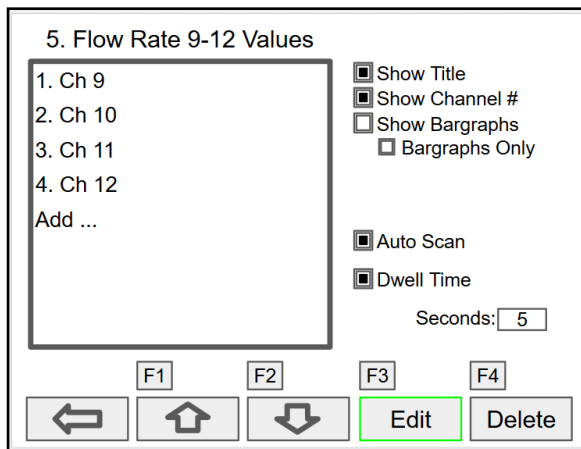
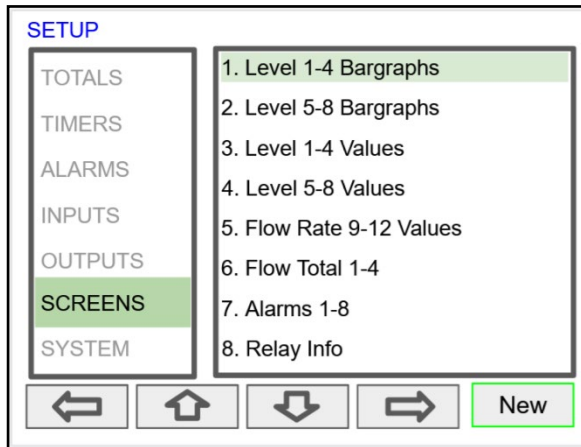

Setup Function Keys

The function keys are setup independently for each screen; this allows the customization of the function keys according to the process values being displayed. For example, if totals are being displayed, one function key can be setup to reset one or all totals.

- Channel
 - Tare (If applicable)
 - Minimum
 - Maximum
- Total
 - Reset Total
 - Reset (Confirm)
 - Enter Total
 - Add To
 - Remove From
- Timer
 - Timer Control
 - Reset
 - Start: (Reset) - (No Reset)
 - Stop: (Reset) – (No Reset)
 - Start (R) / Stop
 - Start / Stop
- Alarm
 - Ack
 - Reset Alarm
 - Set Points
- Screens
 - Previous Screen
 - Next Screen
 - Scan / Stop
- Horn
 - Silence
 - Snooze
 - Test
- Relay
 - Reset Info
 - Reset Info (Confirm)

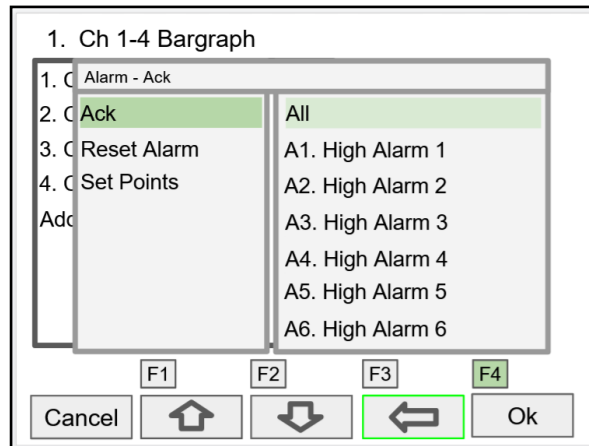

F4 Assigned to Acknowledge All Alarms

Setup System

The *Setup System* menu is used to configure settings that are used throughout the system.

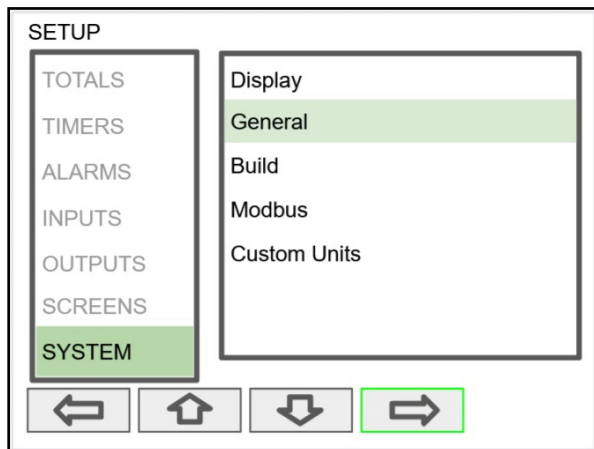

Modbus Settings

The Modbus settings must be configured to match the settings of other devices on the bus. The Modbus Id must be unique to each device on the bus.

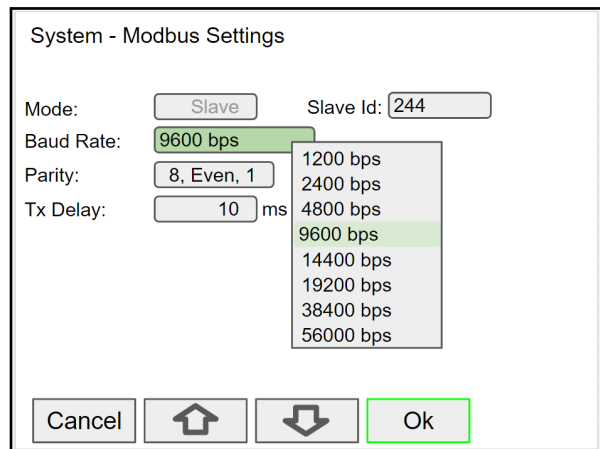

General Settings

The *General Settings* menu contains these options.

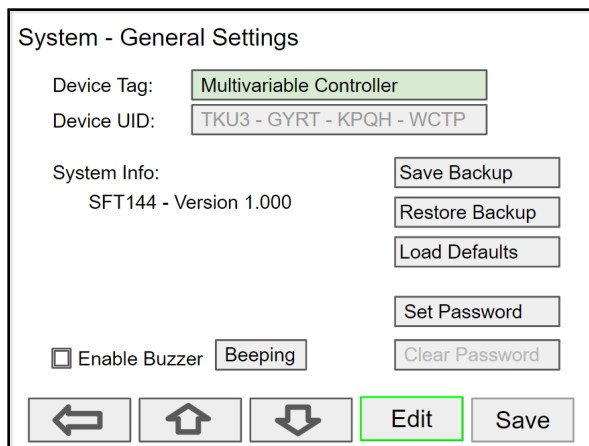

Display Settings

The *Display Settings* menu is used to adjust the backlight and to enable or disable the display of commas for all numeric values.

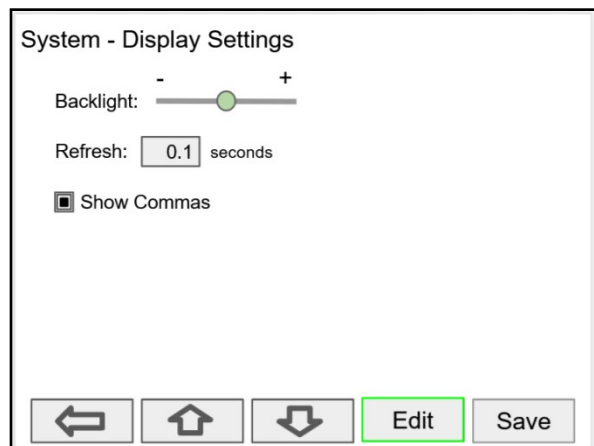

- Device Tag: Edit the device tag (saved on Enter)
- Device UID: Device unique Id
- Enable Buzzer: Enable/disable internal buzzer*
- Save Backup: The current configuration is saved
- Restore Backup: Load backup configuration
- Load Defaults: Load factory defaults
- Set Password: Enter password to lock the system
- Clear Password: Remove the current password

- Backlight: Change the display brightness
- Refresh: Edit display refresh rate
- Show Commas: Display commas for all numeric values greater than 1,000.

*Buzzer Sound Options: Beeping, Alarm, Solid, Warble, Carousel.

Note: The internal buzzer is associated with the alarm's Horn setting, which is available to drive any relay, if connected.

Set Password

The user may enter a 4-digit password to protect the system from unintentional changes.

System - General Settings

Device Tag:

Device UID:

System Info:
SFT144 - Version 1.000

Enable Buzzer

System - General Settings

Device Tag:

Device UID:

System Info:
SFT144 - Version 1.000

Set Password

Enable Buzzer

Password Protected Controller

The correct 4-digit password is required to make changes to the system.

If the password is not correct after 3 attempts, the system will not allow new tries until a timeout elapses. The timeout will continue increasing for every 3 new unsuccessful tries.

Remove Password Protection

To remove the password protection:

1. Enter the correct password
2. Go to the **System** menu – **General Settings**
3. Navigate to the **Clear Password** button
4. Press the **Clr Pwd** key

System - General Settings

Device Tag:

Device UID:

System Info:
SFT144 - Version 1.000

Enable Buzzer



CAUTION! Function keys and digital inputs are not password protected.

Ethernet Port Setup

The Ethernet port option is configured using the Lantronix DeviceInstaller software, available for download from the Lantronix's Website.

<https://www.lantronix.com/products/xport>



CAUTION!

Consult with your IT department to configure the Ethernet port and maintain network security.

Follow these steps, after installation of the DeviceInstaller software.

1. Connect an Ethernet cable to the Local Area Network
2. Launch the Lantronix DeviceInstaller; it will search for XPort devices on the Local Area Network (LAN) and display their status.
3. If more than one controller is connected to the network, determine which is the new controller to be assigned IP address. If necessary, disconnect the new controller and click **Device – Search**, take note of the IP addresses listed. Next, connect the new controller to the LAN and repeat the search; check the list to see which the new IP address is.

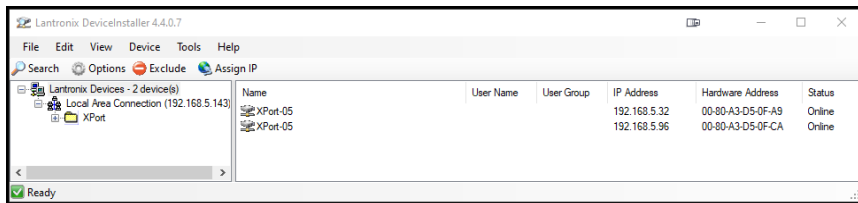

4. Double-click on the new device IP Address to be configured.

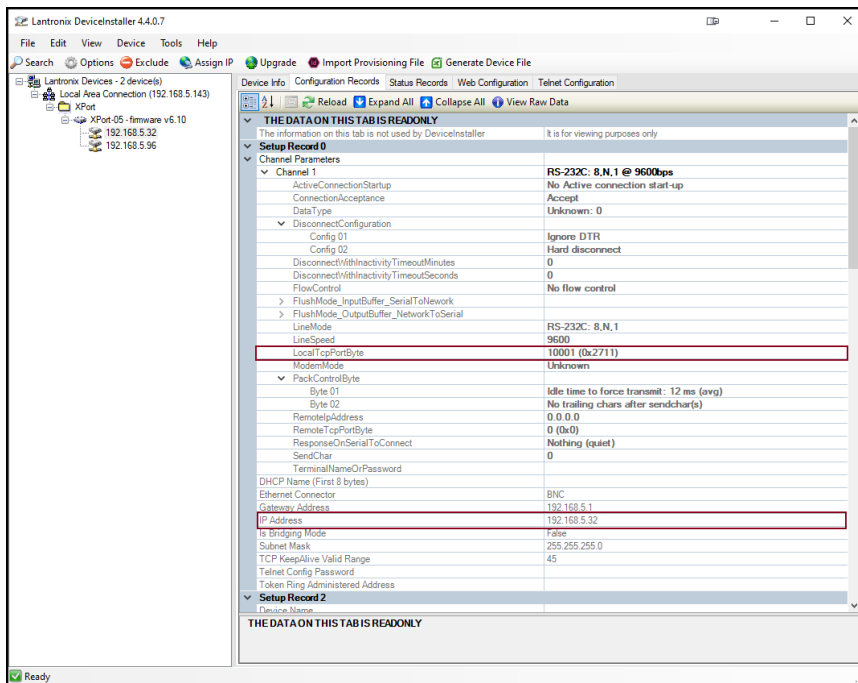

To communicate with a device connected over a LAN, you need the IP Address and the Local TCP Port.

5. Click on **Configuration Records** to find these settings, see the example above.
IP Address: 192.168.5.32; Local TCP Port: 10001 (0x2711)

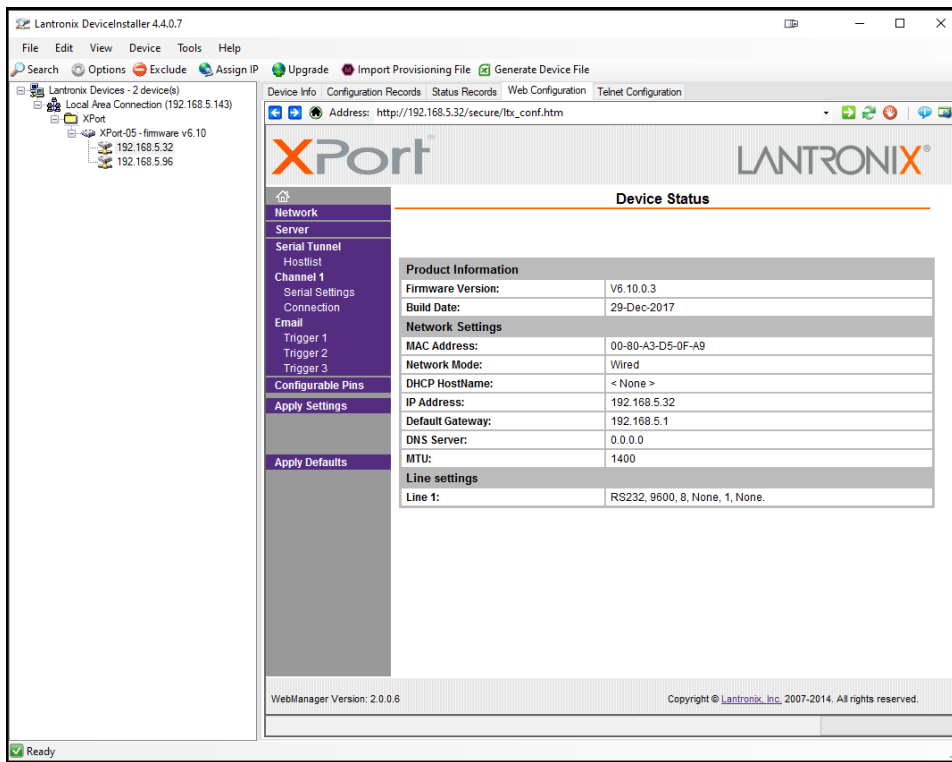

6. Click on **Web Configuration**

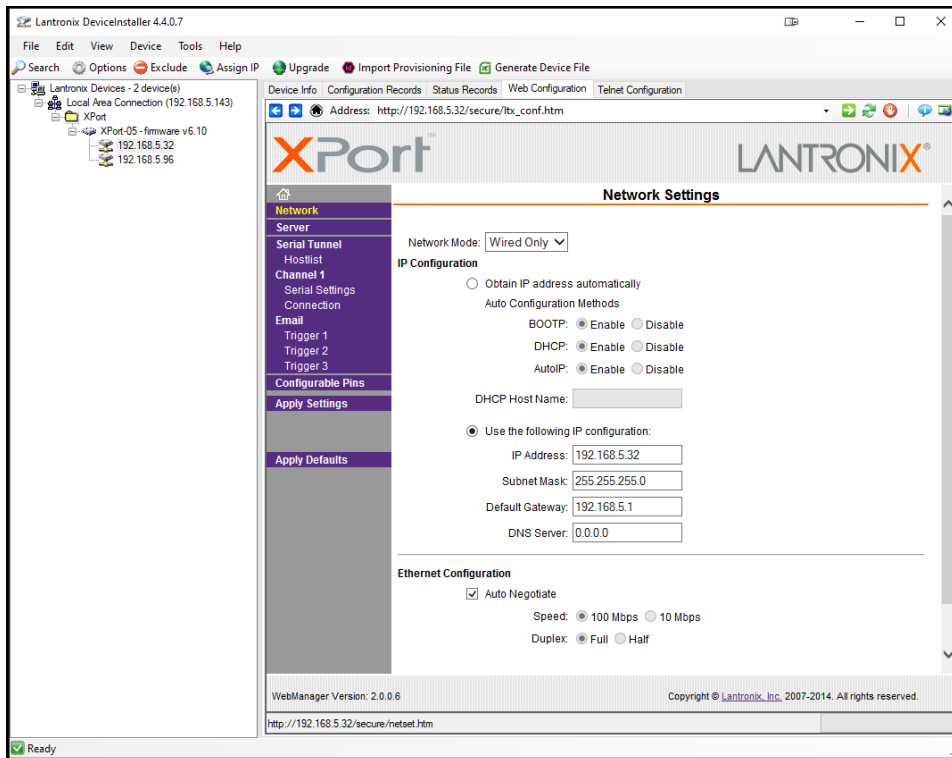

7. Click on **Network** to assign a new IP Address

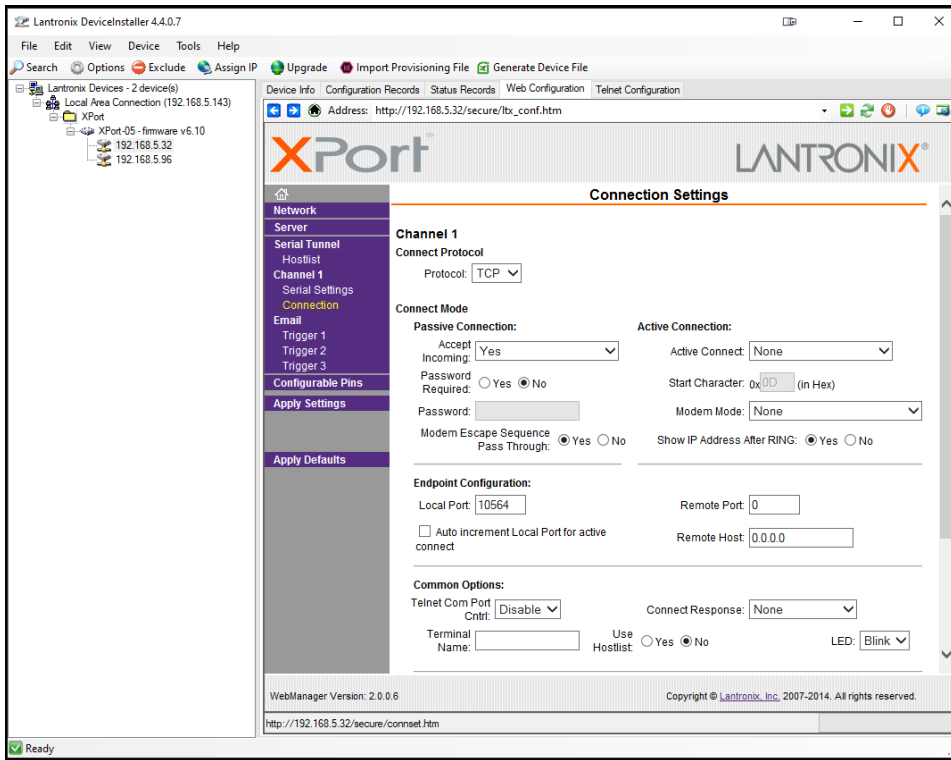

8. Click on **Channel 1 – Connection** to select the protocol: TCP or UDP.
Note: For UDP protocol, select **Datagram Type: 01**
9. Under **Endpoint Configuration**, enter the **Local Port** to be used to access the controller locally or from a remote location. This should be provided by your company’s IT department.
10. Click **OK** and then click **Apply Settings** for settings to be sent to the Ethernet device.

Test Ethernet Communication

Using Modbus Poll is an app that makes it easy to test your Ethernet connection. Below are some screenshot examples for Modbus TCP/IP connection.

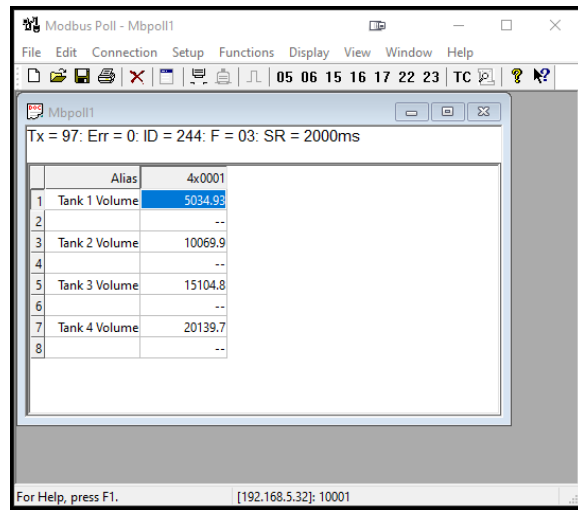
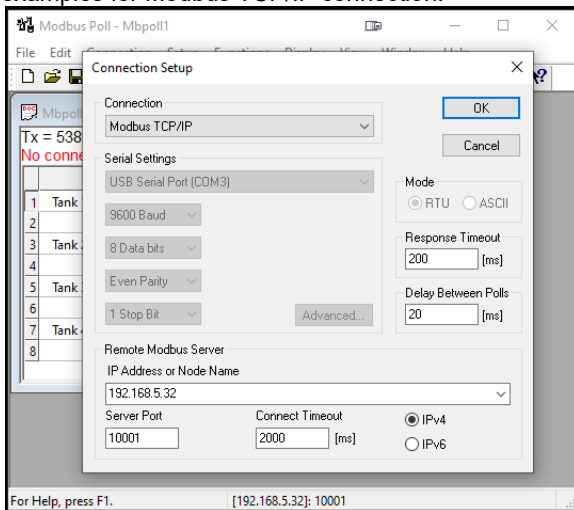

Note: You may download a trial copy of Modbus Poll from <https://www.modbustools.com/>

View Menu

The *View* menu is used to view individual channels, totals, timers, alarms, inputs, outputs, and screens. For example, it provides the details for the current PV, what inputs are the sources for the channel and what outputs are associated with the channel.

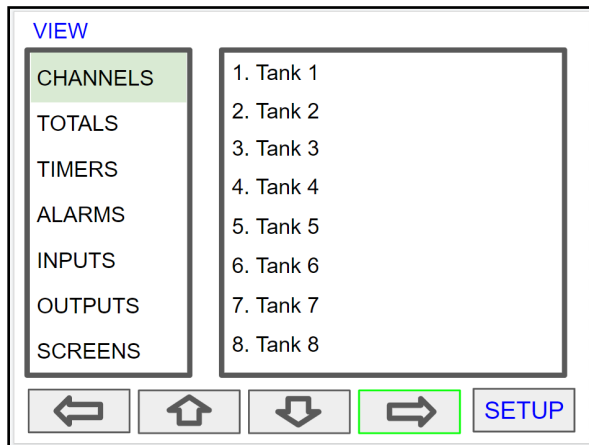

Press the **Right Arrow** key to step into viewing any channel.

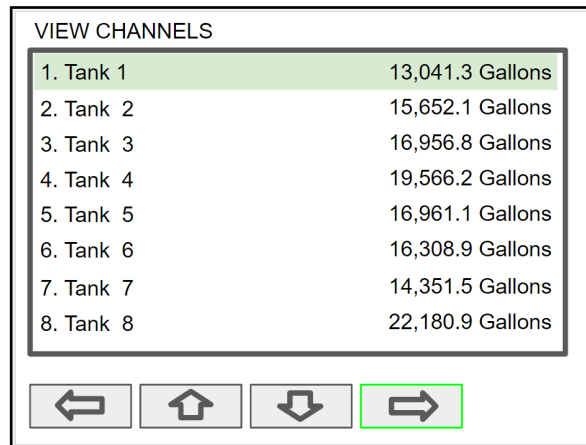

Select any channel using the **Up** or **Down Arrow** keys and Press the **Right Arrow** key again to step into viewing the channel details.

View Channel Details

Stepping into a channel allows the viewing of additional details for the inputs and outputs associated with that channel.

- Channel number and tag
- PV and units
- View the channel input source
- View alarms associated with channel
- View analog outputs assigned to channel

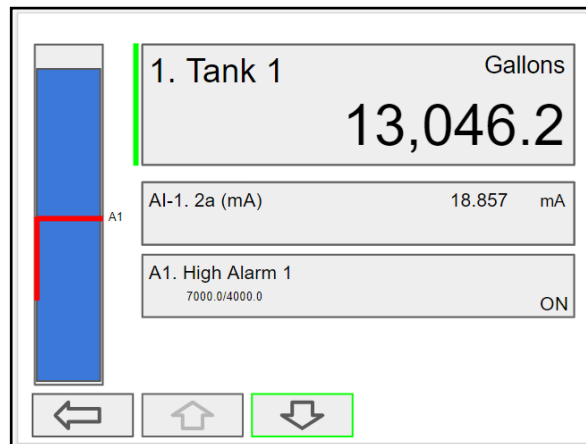

Press the **Down Arrow** key to step into viewing channel input source and then down again to view alarms and analog outputs.

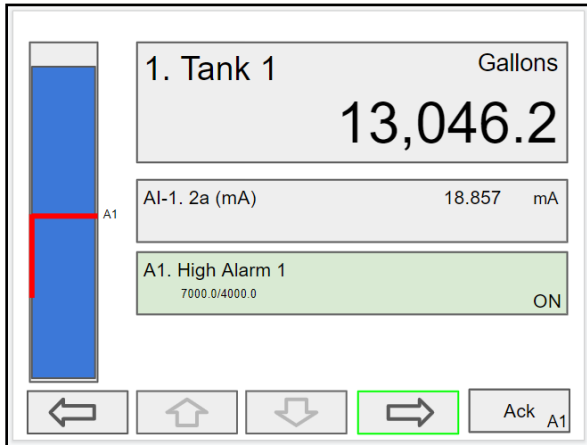

Press the **Right Arrow** key to view alarms details.

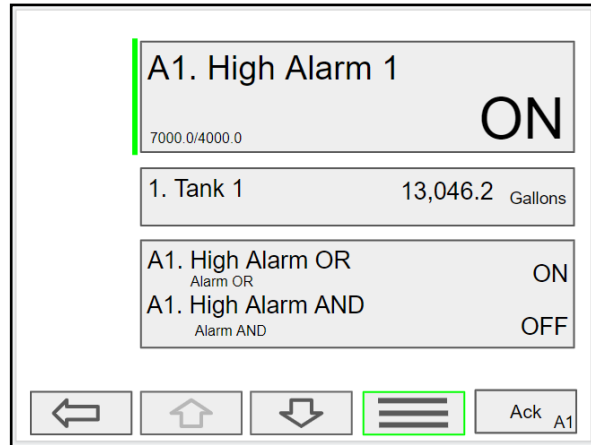

Press the **3-Bar** key to reset alarm or change set points.

View Totals

The *View Totals* menu displays the value of all the totals and allows resetting each total individually.

- Total number and tag
- Accumulated total and units
- Reset total key
- View source for total
- View alarms associated with total
- View analog outputs assigned to total

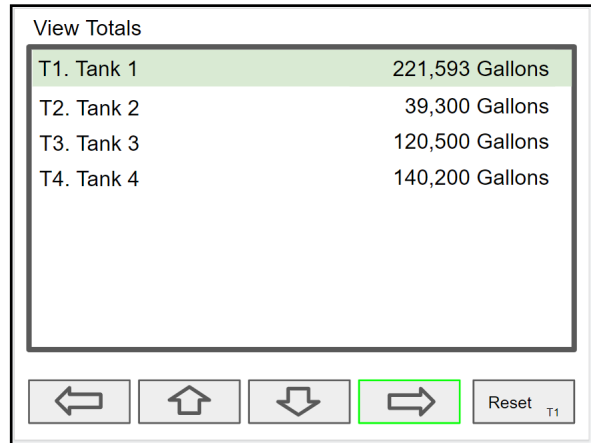

Press **Right Arrow** key to step into details of the selected total and view the source and associated outputs.

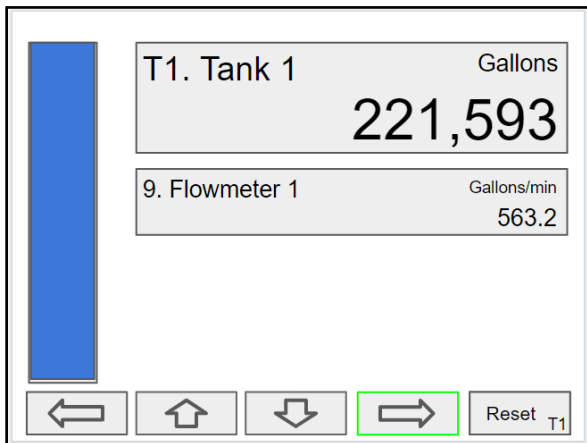

Press the **Right Arrow** key to select Total 1.

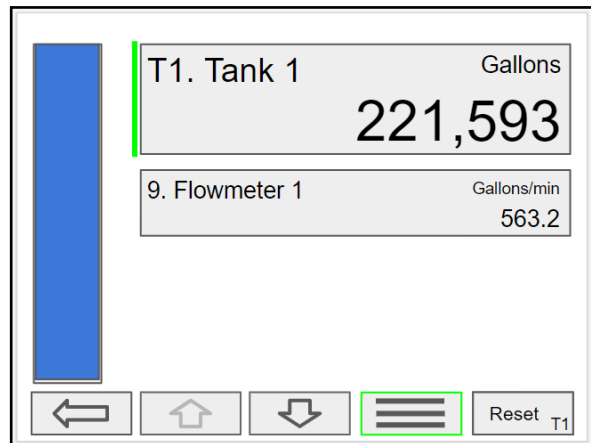

Press the **3-Bar** key to enter a new total, add to or remove from the total.

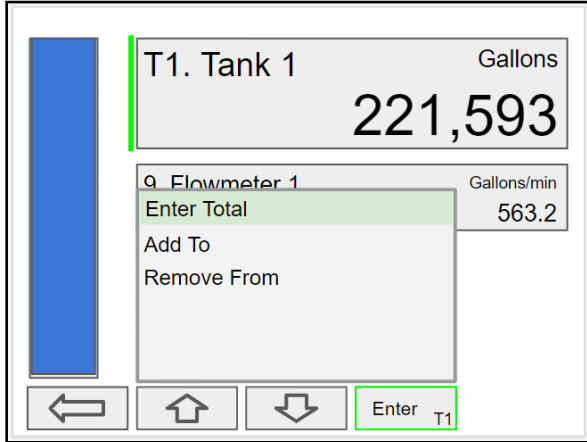

Press the **Enter** key to enter a new total.

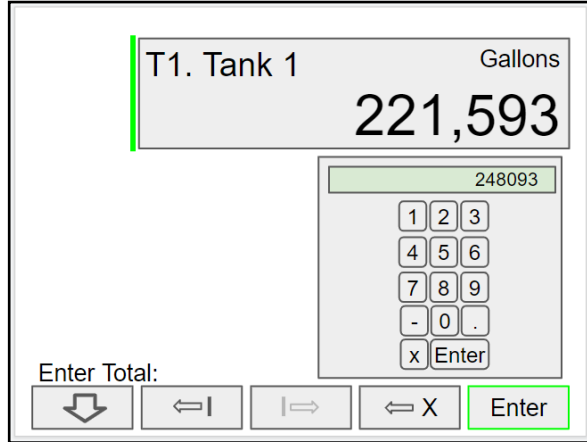

Using the numbers keypad, enter a new total and then press the **Enter** key to save.

View Timers

The *View Timers* menu displays the value of the existing timers.

Press the **Right Arrow** key to step into the details of the selected timer and view the associated inputs and outputs.

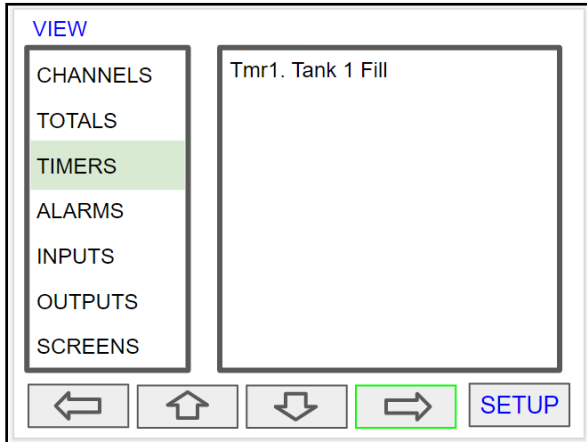

Press the **Right Arrow** key to step into viewing timer.

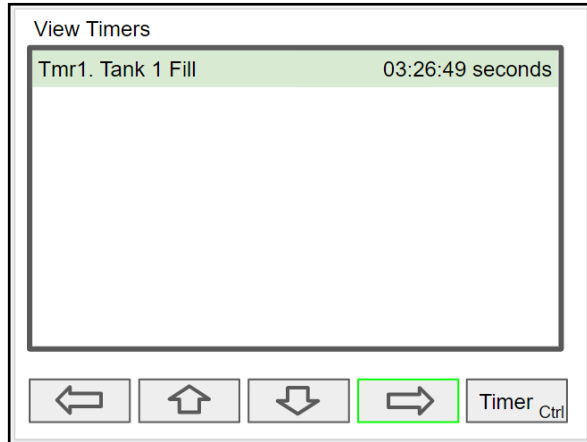

Press the **Right Arrow** key to view timer details.

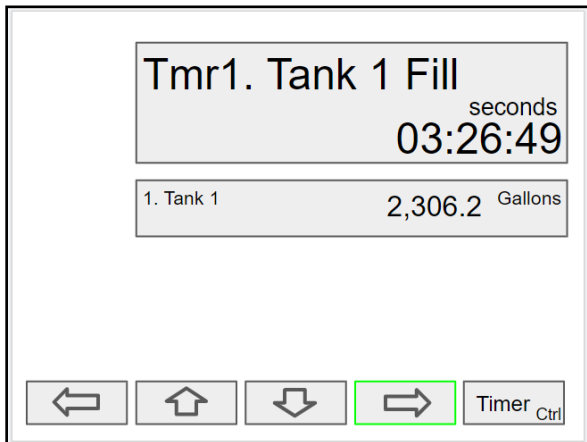

Press the **Right Arrow** key to select timer.

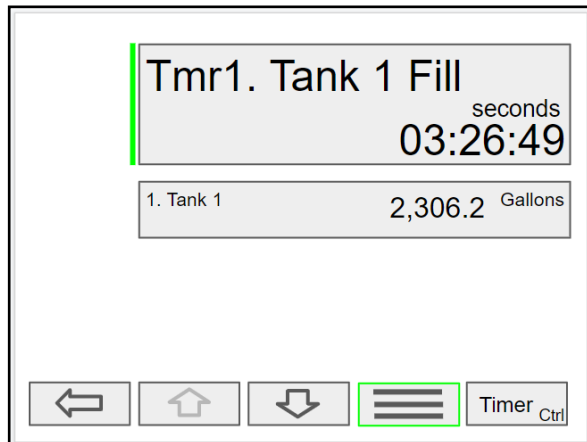

Press the **3-Bar** key to choose Reset, Start, or Stop.

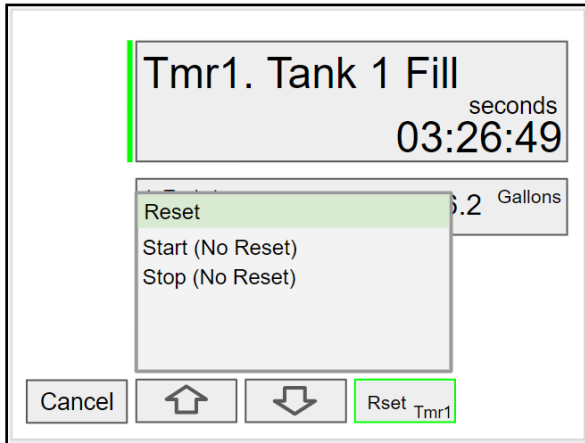

Press the **3-Bar** key to choose from Resetting, Starting, or Stopping the timer.

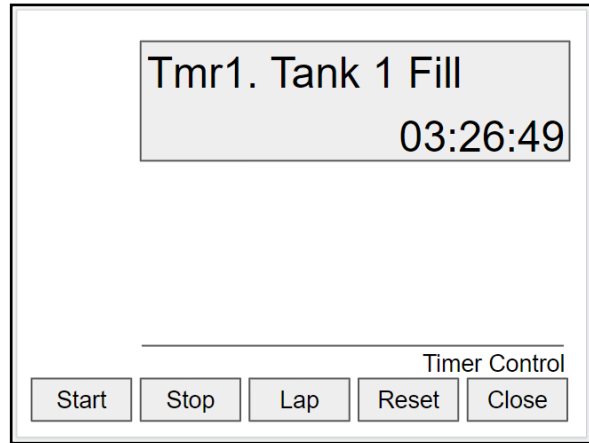

Press the **Timer Control** key (shown in the timer details screen) to access all timer control buttons.

View Alarms

The *View Alarms* menu displays the status of all the alarms and the details for each alarm.

- Alarm # and tag
- Set/Reset points
- Source for the alarm
- Outputs associated with the alarm
- Acknowledge the alarm

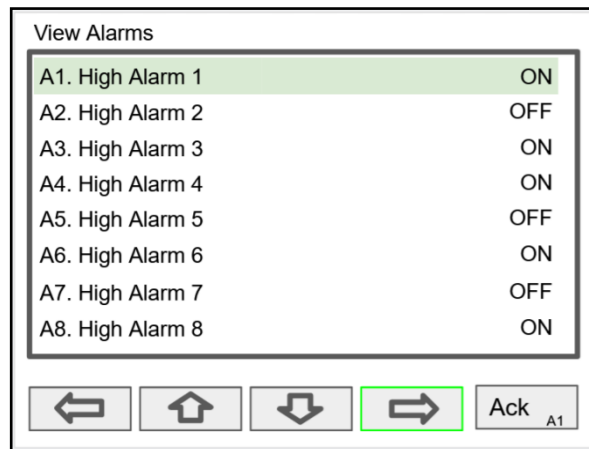

Press the **Right Arrow** key to view the alarm details.

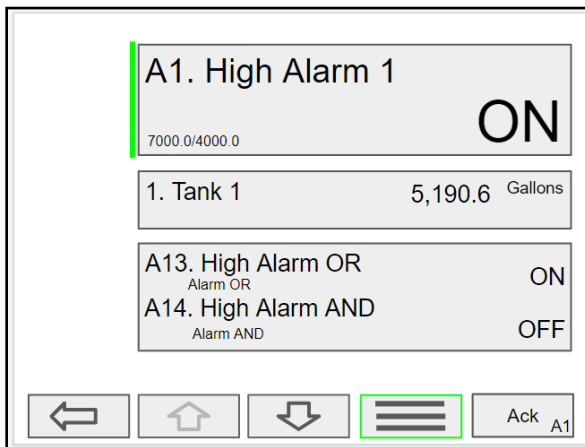

Press the **3-Bar** key to select Reset Alarm or change Set Points.

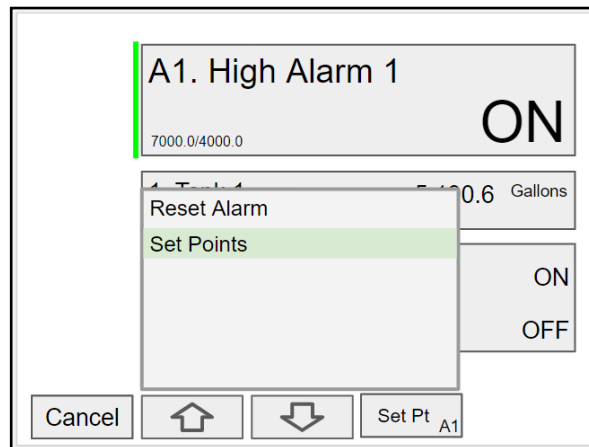

Press the **Set Point** key to Reset Alarms or change the Set Points.

View Inputs

The *View Inputs* menu displays the values and status of all the inputs and the details of the associated channels.

- Input # and tag
- mA input value
- Pulse input frequency
- Digital input status
- Modbus input value
- Associated channel(s)

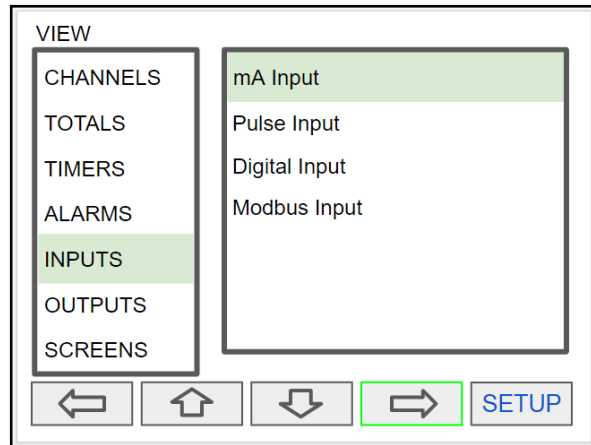

Press the **Right Arrow** key to select the mA Input.

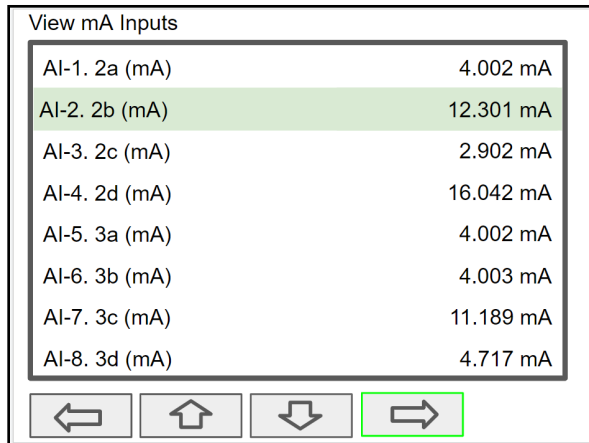

Press the **Right Arrow** key to view the mA Input details.

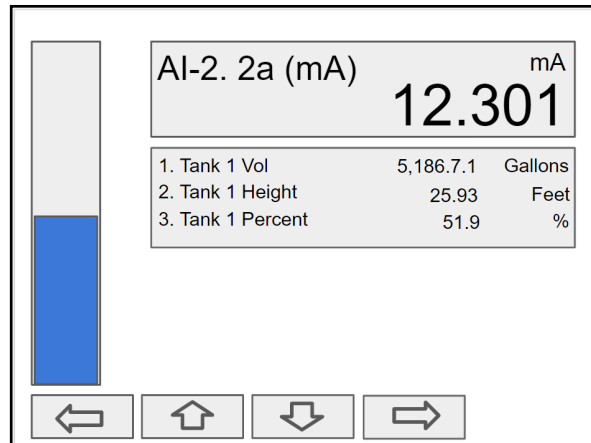

The above screen shows the Analog Input 2 details and the associated channels.

View Outputs

The *View Outputs* menu displays the values and status of all the outputs and the details of the associated channels.

- Output # and tag
- mA output value
- Relay output status
- Digital output status
- Number of cycles & runtime
- Associated input

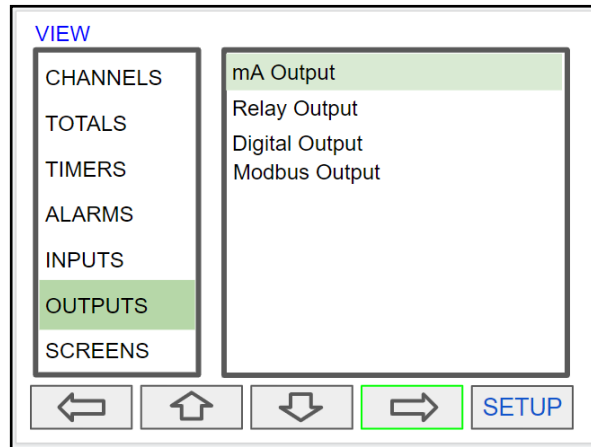

Press the **Right Arrow** key to select the mA Output.

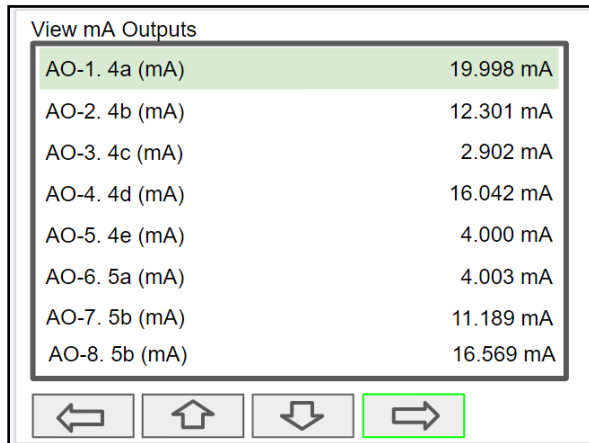

Press the **Right Arrow** key to view the mA Output details.

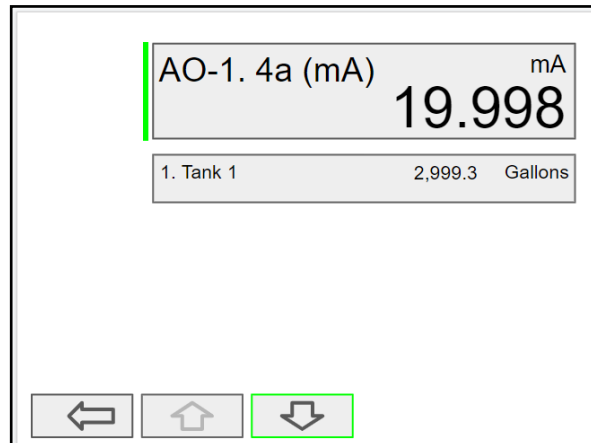

Press the **Down Arrow** key to view the associated channel details with the Analog Output 1.

View Screens

With the View Screens menu, the user can go to any available screen and view the details. The screens can be scanned continuously or can be stopped to stay on a particular screen.

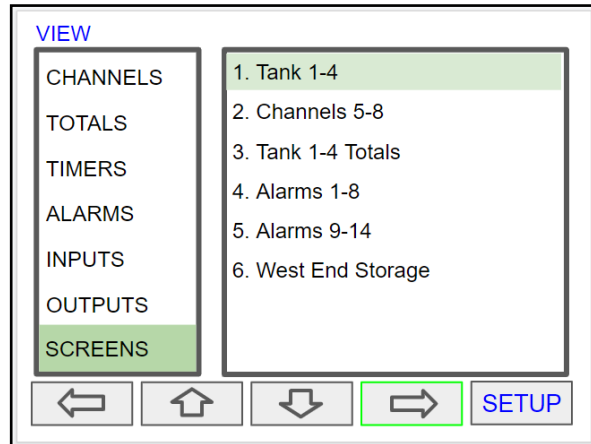

Press the **Right Arrow** key to view details of the the selected view screen.

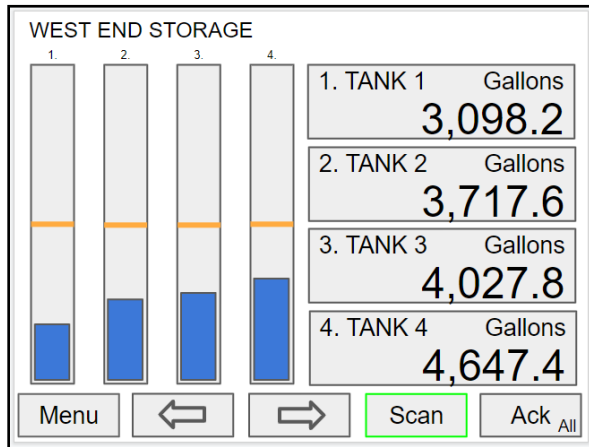

Press the **Scan** key to have all available screens continue to scan.

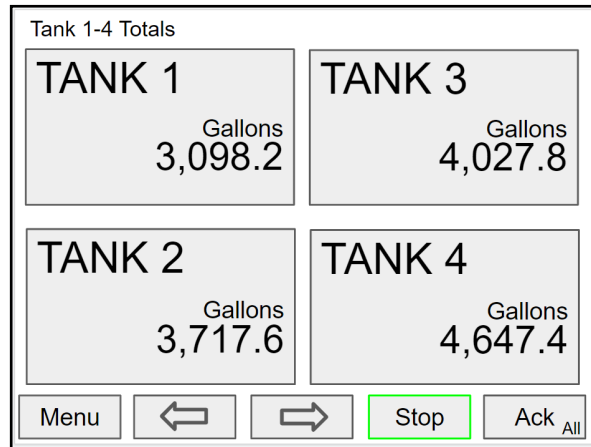

Press the **Stop** key to have all available screens stop scanning and stay on the current screen.

Operation

Viewing Screens

The controller displays various screens with bargraphs, numerical values, and relay status throughout operation, according to the user-selected setup. There are two basic modes of operation: Automatic scan or manual scan. The controller initializes in automatic scan mode. Press Stop key to stop the automatic scan and use the Up or Down keys (Previous or Next) to navigate through the various screens. Press the Scan key to resume automatic scanning.

The bargraphs are optional, they are enabled or disabled during Screens setup. The scaling of the bargraph is done during the setup of each channel and it can be different than the channel scaling values.

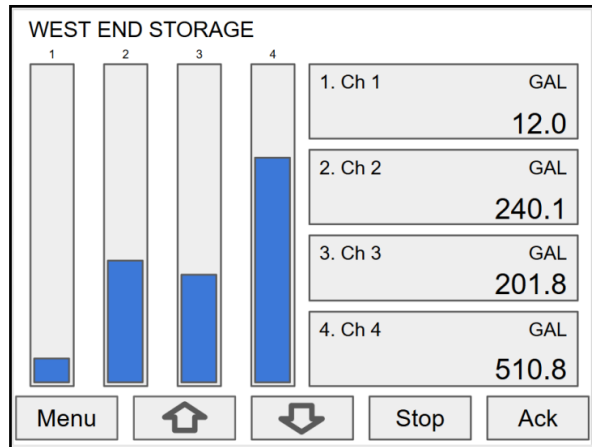

Individual Channel View

To view the details of any channel, press Menu and then press View – Channel. Select the channel of interest. Navigate through the different items using the navigation keys. A green bar indicates the selected item, press the R-key to step into and see more details about the inputs and outputs related to the channel in view.

If applicable, alarms may be acknowledged, and totals may be reset from these screens.

Low & High Alarm Indication

The alarm set points are indicated by an amber line at the corresponding value on the bargraph.

Active High Alarm: Indicated by red horizontal and vertical lines. The bottom of the vertical line is the reset point of the high alarm. The high alarm is indicated on the left side of the bargraph.

Active Low Alarm: Indicated by red horizontal and vertical lines. The top of the vertical line is the reset point of the low alarm. The low alarm is indicated on the right side of the bargraph.

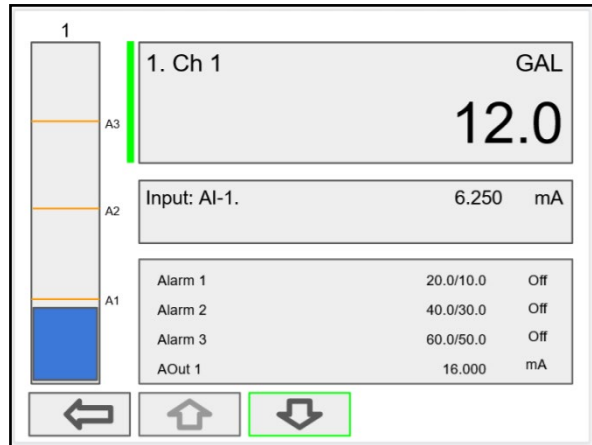

Alarm set points are indicated by amber horizontal lines.

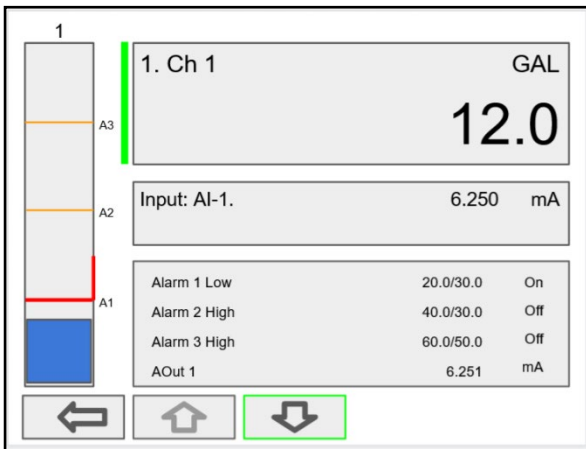

Low alarm indication

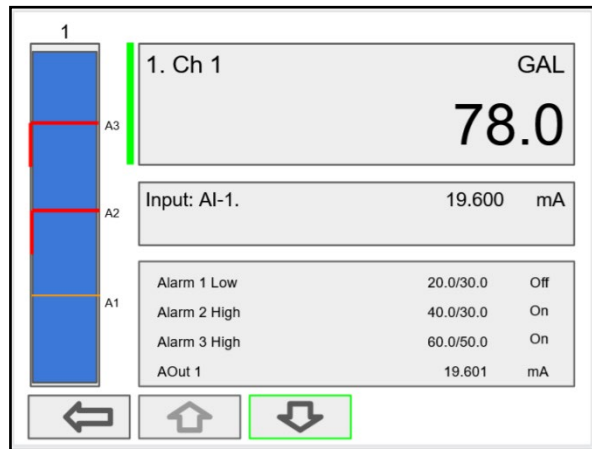

High alarm indication

Modbus® RTU Serial Communication

The controller is equipped with serial communication capability as a standard feature. Baud Rate, Parity, Slave ID (Address) and Transmit Delay are entered in the *System* menu, which appears in the main *Setup* menu. The baud rate and parity selected must match the settings for all other devices on the network. The Slave ID must be unique, so it will not interfere with other devices.

The controller supports the following Modbus functions:

Command	Name	Description
01	Read Coils (0x)	Read coil value
03	Read Holding Register (4x)	Read multiple bytes from holding registers.
05	Write Single Coil (Bit)	Set single coil value control
15	Write Multiple Coils (Bits)	Set multiple coil value control
06	Write Single Register	Set single value into specified holding register.
16	Write Multiple Registers	Set multiple values into specified holding registers.

The multi-channel controller can also work as a “Modbus Display/Controller” by writing the desired value to the selected Modbus input (MB-1 to MB-199). The Modbus input can be used the same way a 4-20 mA input is used; it can be brought into a channel to be displayed and generate alarms to control relays, generate 4-20 mA outputs, and Modbus outputs (MO-1 to MO-64).

Modbus Register Tables

Table 1. Default Register Numbers / Addresses

Reg. Number	Reg. Address	Description	Data Type	Function Codes	R/W
40001	0	Channel (1) Value	Float	03, 04	R
40003	2	Channel (2) Value	Float	03, 04	R
40005	4	Channel (3) Value	Float	03, 04	R
40007	6	Channel (4) Value	Float	03, 04	R
40009	8	Channel (5) Value	Float	03, 04	R
40011	10	Channel (6) Value	Float	03, 04	R
40013	12	Channel (7) Value	Float	03, 04	R
40015	14	Channel (8) Value	Float	03, 04	R
40017	16	Total (1) Value	Float	03, 04	R
40019	18	Total (2) Value	Float	03, 04	R
40021	20	Total (3) Value	Float	03, 04	R
40023	22	Total (4) Value	Float	03, 04	R
40025	24	Timer (1) Value	Float	03, 04	R
40027	26	Timer (2) Value	Float	03, 04	R
40029	28	Timer (3) Value	Float	03, 04	R
40031	30	Timer (4) Value	Float	03, 04	R
40033	32	Alarm (1) Status*	Short	03, 04	R
40034	33	Alarm (2) Status*	Short	03, 04	R
40035	34	Alarm (3) Status*	Short	03, 04	R
40036	35	Alarm (4) Status*	Short	03, 04	R
40037	36	Alarm (5) Status*	Short	03, 04	R
40038	37	Alarm (6) Status*	Short	03, 04	R
40039	38	Alarm (7) Status*	Short	03, 04	R
40040	39	Alarm (8) Status*	Short	03, 04	R

Alarm Status: 0: Off, 1: On, 2: On & Acknowledged

The table above contains some predefined registers and data types used. The following table contains the definitions of all accessible registers with their corresponding data type.

Register Numbers & Addresses

The register numbers and register addresses are calculated based on the formulas provided below. The values are available in various data types. Examples of register addresses (base 0) are provided on the right column. Register numbers refer to PLC Addresses (base 1). Function Code 03 Read Holding Registers (4x) are shown on this table and used throughout the system; other functions are also supported as indicated in the Function column.

Modbus input and output registers can be mapped by the user under the *Setup – Inputs – Modbus* menu; this allows assigning any parameter to the Modbus output registers and selecting the data type for input and output registers.

Table 2. Register Numbers / Register Addresses

Reg. Number	Reg. Address	Channel (N = 1 ... 99)	Data Type	Bits	Function	R/W	Reg. Address Examples
00101 + (N - 1)	100 + (N - 1)	Channel (N) Value	Bit	1	01, 02	R	Ch1 = 100
40101 + (N - 1)	100 + (N - 1)	Channel (N) Value	Short	16	03, 04	R	Ch1 = 100
40201 + 2(N - 1)	200 + 2(N - 1)	Channel (N) Value	Long	32	03, 04	R	Ch2 = 202
40401 + 2(N - 1)	400 + 2(N - 1)	Channel (N) Value	Float	32	03, 04	R	Ch3 = 404
40601 + 4(N - 1)	600 + 4(N - 1)	Channel (N) Value	Double	64	03, 04	R	Ch4 = 612
41001 + 4(N - 1)	1000 + 4(N - 1)	Channel (N) Value	Long Long	64	03, 04	R	Ch99 = 1392
		Total (N = 1 ... 32)					
42101 + (N - 1)	2100 + (N - 1)	Total (N) Value	Short	16	03, 04	R	Total 1 = 2100
42201 + 2(N - 1)	2200 + 2(N - 1)	Total (N) Value	Long	32	03, 04	R	Total 1 = 2202
42301 + 2(N - 1)	2300 + 2(N - 1)	Total (N) Value	Float	32	03, 04	R	Total 1 = 2302
42401 + 4(N - 1)	2400 + 4(N - 1)	Total (N) Value	Double	64	03, 04	R	Total 1 = 2404
42601 + 4(N - 1)	2600 + 4(N - 1)	Total (N) Value	Long Long	64	03, 04	R	Total 32 = 2724
		Timer (N = 1 ... 32)					
43101 + (N - 1)	3100 + (N - 1)	Timer (N) Value (sec)	Short	16	03, 04	R	Timer 1 = 3100
43201 + 2(N - 1)	3200 + 2(N - 1)	Timer (N) Value (sec)	Long	32	03, 04	R	Timer 1 = 3202
43301 + 2(N - 1)	3300 + 2(N - 1)	Timer (N) Value (sec)	Float	32	03, 04	R	Timer 1 = 3302
43401 + 4(N - 1)	3400 + 4(N - 1)	Timer (N) Value (sec)	Double	64	03, 04	R	Timer 32 = 3524
		Alarm (N = 1 ... 64)		64			
43601 + (N - 1)	3600 + (N - 1)	Alarm (N) Status	Short		03, 04	R	0: Off, 1: On, 2: On & Ack
		Modbus Output (N = 1 ... 64)					
04101 + (N - 1)	4100 + (N - 1)	Modbus Output (N) Value	Bit (0 or 1)	1	01, 02	R	MO-1 = 4100
44101 + (N - 1)	4100 + (N - 1)	Modbus Output (N) Value	Short	16	03, 04	R	MO-1 = 4100
44201 + 2(N - 1)	4200 + 2(N - 1)	Modbus Output (N) Value	Long	32	03, 04	R	MO-1 = 4202
44401 + 2(N - 1)	4400 + 2(N - 1)	Modbus Output (N) Value	Float	32	03, 04	R	MO-1 = 4402
44601 + 4(N - 1)	4600 + 4(N - 1)	Modbus Output (N) Value	Double	64	03, 04	R	MO-1 = 4604
45001 + 4(N - 1)	5000 + 4(N - 1)	Modbus Output (N) Value	Long Long	64	03, 04	R	MO-64 = 5252
		Modbus Input (N = 1 ... 199)					
06101 + (N - 1)	6100 + (N - 1)	Modbus Input (N) Value	Bit (0 or 1)	1	01, 02, 05, 15	R/W	MB-1 = 6100
46101 + (N - 1)	6100 + (N - 1)	Modbus Input (N) Value	Short	16	03, 04, 06, 16	R/W	MB-1 = 6100
46301 + 2(N - 1)	6300 + 2(N - 1)	Modbus Input (N) Value	Long	32	03, 04, 16	R/W	MB-1 = 6302
46701 + 2(N - 1)	6700 + 2(N - 1)	Modbus Input (N) Value	Float	32	03, 04, 16	R/W	MB-1 = 6702
47101 + 4(N - 1)	7100 + 4(N - 1)	Modbus Input (N) Value	Double	64	03, 04, 16	R/W	MB-1 = 7104
47901 + 4(N - 1)	7900 + 4(N - 1)	Modbus Input (N) Value	Long Long	64	03, 04, 16	R/W	MB-199 = 8692

Relay Control Via Modbus

To control the relays via Modbus, use the Write Single Coil command [command code 05] or Write Multiple Coils [command code 15] and send either the "ON" or "OFF" to the Modbus input associated with the target relay.

Setup Example:

Setup – MB-1.

1. Tag: Modbus Input 1
2. Type: Bit – Logic (Reg. No. 06101)
3. Units: Custom units = Pump 1 (Units used as label)
4. Break: Default = Off

Setup – RY-1.

1. Tag: Relay 1
2. Input: MB-1. Modbus Input 1

Operation: Write "1" to Reg. 06101 to turn relay 1 On; write "0" to turn relay 1 Off.

Troubleshooting Tips

Symptom	Check/Action
No display or only backlight is visible, but outputs still function normally.	<ol style="list-style-type: none"> 1. Ambient temperature is below -40°C and affects LCD visibility. 2. Grounding is inadequate or not connected. Check earth ground continuity.
"BREAK" is displayed	Check the 4-20 mA input; if less than the break value (e.g. 0.01 mA), it displays BREAK.
Display response seems slower than normal	Ambient temperature is too cold: Consider installing a heater with the instrument.
Display reading is unstable, it fluctuates too much	<ol style="list-style-type: none"> 1. Check signal source stability 2. Increase filter value 3. Increase display refresh rate
mA input not responding to signal changes (value frozen)	<ol style="list-style-type: none"> 1. Cycle the power or 2. Go to setup mA input and disable/enable input channel
Display locks up or the instrument does not respond at all	Cycle the power to reboot the microprocessor.
Settings reprogrammed, but instrument behavior remains as previously programmed	Cycle the power to reboot the microprocessor.
Relay and status do not respond to signal	<ol style="list-style-type: none"> 1. Check if relays are in manual control mode. 2. Check Setup menu alarm set and reset points.
Controller will not communicate with other device.	Check baud rates and parity settings. Make sure all serial devices have matching parameters.
Other symptoms not described above	Call Technical Support for assistance.

Model:	
Serial Number:	
Password:	

How to Contact Precision Digital

- For Technical Support please
Call: (800) 610-5239 or (508) 655-7300
Fax: (508) 655-8990
Email: support@predig.com
- For Sales Support or to place an order please
contact your local distributor or
Call: (800) 343-1001 or (508) 655-7300
Fax: (508) 655-8990
Email: sales@predig.com
- For the latest version of this manual please visit
www.predig.com

PRECISION DIGITAL CORPORATION

233 South Street • Hopkinton MA 01748 USA
Tel (800) 343-1001 • Fax (508) 655-8990



www.predig.com