



shadowspec

umbrellas with distinction



INTRODUCING A NEW CLASS OF SHADE

Curated shade for hospitality spaces

SHADOWSPEC UNITY™

page 4



Engineered and hand-built at the Heron Base, the Shadowspec Unity™ is our new flagship premium outdoor umbrella. We've created an umbrella that stands up to everyday use whilst being easy to use and quick to deploy.

SHADOWSPEC SERENITY™

page 10



Rotate your way to perfect shade with the exceptional design of the Shadowspec Serenity™. Our smart umbrella is designed to be adjustable and enduring. Lighten the load with Shadowlift technology and a built-in LED light.

Introducing a New Class of Shade.

Shadowspec's collection of outdoor umbrellas provide class and style to outdoor settings no matter the location. With over 25 years' experience in research, development and manufacture of shade and protection products, Shadowspec has built an unparalleled product range with a reputation of real-world value - supplying world-leading designs with enduring quality.

Shadowspec outdoor umbrellas are constructed from marine-grade materials including stainless steel and single-extrusion aluminum. Our comprehensive range of quick-ship stock and custom fabric colors provide exceptional UV sun protection, are water-repellent and color-fast. Our elegant, effortless shade systems are here to help you sculpt your outdoor space into an iconic, warm and welcoming space.

SU2

page 16



The hunt for shade at your cafe/restaurant, hotel or resort needn't travel any further. The SU2 Cafe & Resort Umbrella is here to provide your space with a steady, curated shade.

*Minimum Order Quantity & Lead Times apply.

SU10

page 22



The SU10 is engineered to work hard in a range of applications, al fresco dining, poolside at the resort or as a patio umbrella outside the cafe. The size, strength and clever design set the SU10 apart.

*Minimum Order Quantity & Lead Times apply.



SHADOWSPEC UNITY™

The Evolution of Shade. Innovative, modular and exclusive.

The Shadowspec Unity™ has been crafted with premium-grade aluminum and stainless steel to provide you with an umbrella that stands up and stands out.

Every component is designed and engineered to survive in the wild. Taking inspiration from nature, this flagship model is easy to open and looks stunning in any outdoor setting. It's an outdoor shade solution perfect for hospitality.

The Shadowspec Unity™ sits squarely (or octagonally) in a class of its own. You'll find no antiquated crank handles, cables or internal moving parts that create a laborious process and are prone to breakage.

You'll continue to be inspired by this brilliant, modern and modular outdoor shade umbrella. The needle-shifting features get better with every open and every new discovery of innovation you make.



PATENT-PENDING TECHNOLOGY

SHADOWLIFT™



Gas-assisted deployment for an easy lift.

SHADOWGLIDE™



Engineered to open or close in 3 seconds.

SHADOWHUB™



LED light technology built-in and App controlled.

SHADOWLOCK™



Integrated security and wind-protection.



Featuring Marine-Grade 316 Stainless Steel Spigot.

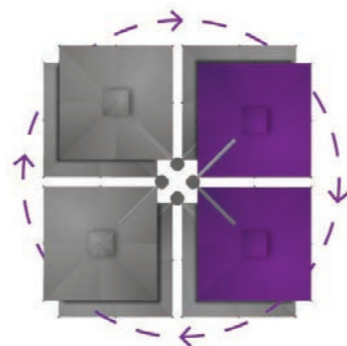

Rotates 360° (Ground Mounted).

Size & Configuration

Square Uno

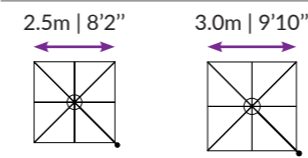

Square Duo

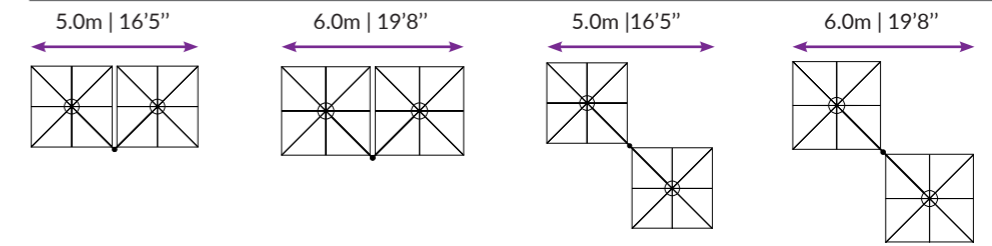

Square Trio

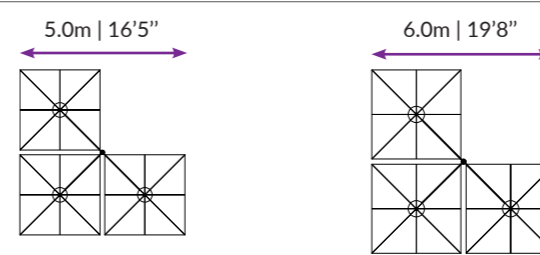

Square Quattro

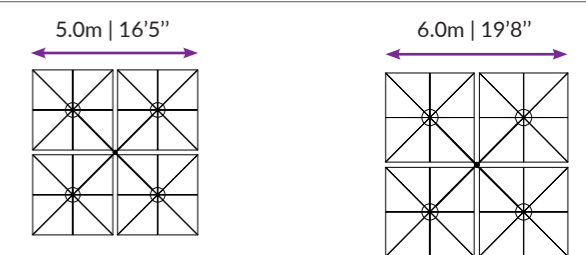

Canopy

Features

- 100% Sunbrella™ Marine solution-dyed fabric
- All fabrics can be cleaned, washed and are replaceable
- UV & Fade Resistant
- 10 year Sunbrella™ warranty
- Mold and Mildew Resistant
- Weight: 314 g/m2 / 9oz/yd²
- Sun protection - Skin Cancer Foundation's seal of approval



Quick-Ship Stock Colors

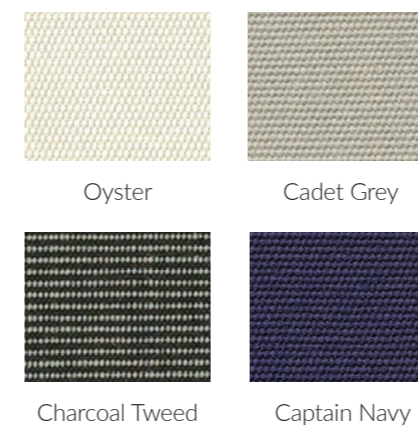

Trend Colors - Summer 20/21* (Non-stock)



*Trend colors are non-stock and lead times may vary for these colors. Full Sunbrella range is available as a custom color option.

BEST-IN-CLASS WARRANTY

Relax easy knowing your outdoor umbrella purchase is protected by the industry's best warranty (conditions apply) and customer support. 3 year warranty applies for commercial applications.





SHADOWSPEC UNITY™





SHADOWSPEC SERENITY™

Precision Engineered Ambience Effortless Protection for Prestigious Spaces.

The Shadowspec Serenity™ has been designed with careful consideration and consistency. The technology we've developed works in perfect harmony to give you the most advanced umbrella deployment system in the industry.

We're committed to evolving and innovating and our patent-pending technology is a prime example of that, giving you the ability to open or close the Serenity™ in just 3 seconds. The umbrella has been designed to be ready to go right out of the box; install it anywhere in your outdoor space and get the instant benefit of a rotatable shade solution.



PATENT-PENDING TECHNOLOGY

SHADOWLIFT™



Gas-assisted deployment for an easy lift.

SHADOWGLIDE™



Engineered to open or close in 3 seconds.

SHADOWHUB™



LED light technology built-in and App controlled.

SHADOWLOCK™



Integrated security and wind-protection.



Featuring Marine-Grade 316 Stainless Steel Spigot.

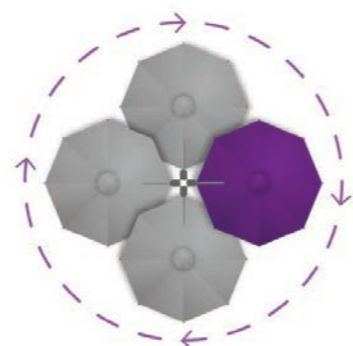

Rotates 360° (Ground Mounted)

Size & Configuration

Square

2.5m | 8'2"

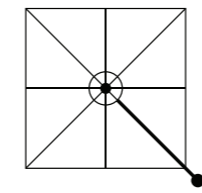

3.0m | 9'10"

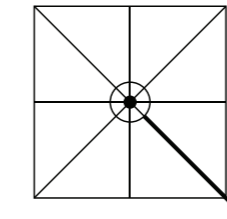

Octagon

3.5m | 11'6"

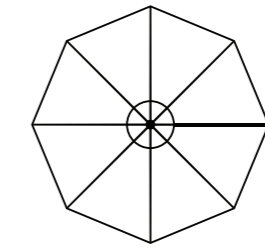

4.0m | 13'2"

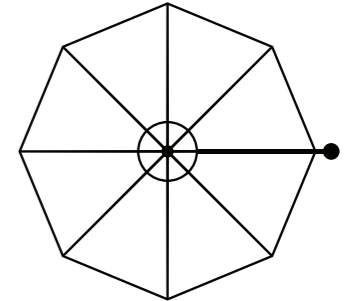

Canopy

Features

- 100% Sunbrella™ Marine solution-dyed fabric
- All fabrics can be cleaned, washed and are replaceable
- UV & Fade Resistant
- 10 year Sunbrella™ warranty
- Mold and Mildew Resistant
- Weight: 314 g/m2 / 9oz/yd²
- Sun protection - Skin Cancer Foundation's seal of approval



Quick-Ship Stock Colors

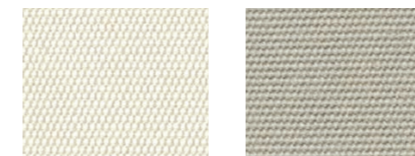

Oyster

Cadet Grey

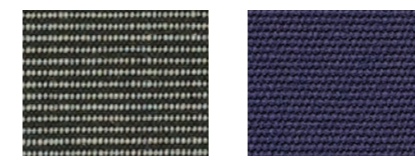

Charcoal Tweed

Captain Navy

Trend Colors - Summer 20/21* (Non-stock)

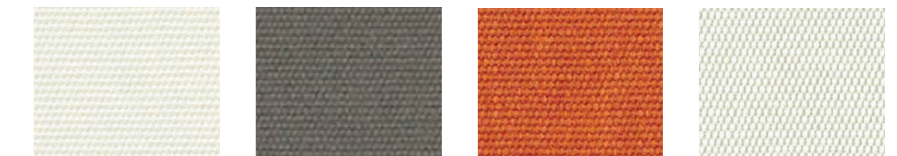

Natural

Charcoal Grey

Rust

Silver

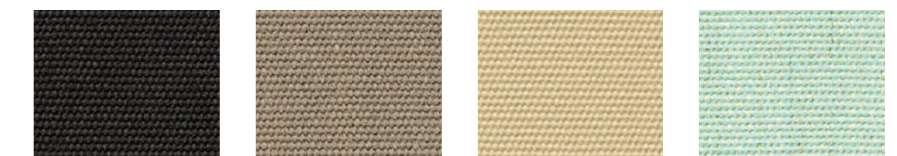

Black

Taupe

Linen

Sea

*Trend colors are non-stock and lead times may vary for these colors. Full Sunbrella range is available as a custom color option.

BEST-IN-CLASS WARRANTY

Relax easy knowing your outdoor umbrella purchase is protected by the industry's best warranty (conditions apply) and customer support. 3 year warranty applies for commercial applications.



Fabric Warranty



Frame Warranty

SHADOWSPEC SERENITY™





SU2

SU2

CAFE AND RESORT UMBRELLA

Stylish, resilient and individual. Ideal hospitality shade.

Meet our take on the classic market umbrella, the SU2 is easy to use, stable and enduring. The perfect umbrella for hospitality settings, offer your guests premium protection from the sun and rain whilst adding a certain style, class and functionality to your outdoor space.

The SU2 Cafe & Resort Umbrella is available in a variety of canopy shapes, sizes and colors, with both Surface Plate and Portable Base fixing options.

The SU2 is a popular hospitality product and we often supply custom branding, colors and designs to help your establishment expand their footprint out in front of the public.

Add a splash of style to your setting with a hospitality-level Cafe and Resort Umbrella.

*Minimum Order Quantity & Lead Times apply.



Features at a glance

- Simple and easy to open and close
- Heavy-duty double pulley system
- Commercial grade pulley rope
- Glass-filled nylon high-performance hubs and brackets
- Marine grade anodized aluminum frame and pole
- Stainless steel fastenings and components
- Commercial strength pole with a large diameter and thick aluminum wall.



Strut Arms

All Shadowspec SU2 Umbrellas have **eight** full strength 20mm x 33mm / 3/4" x 1 1/8" strut arms.

Size & Configuration

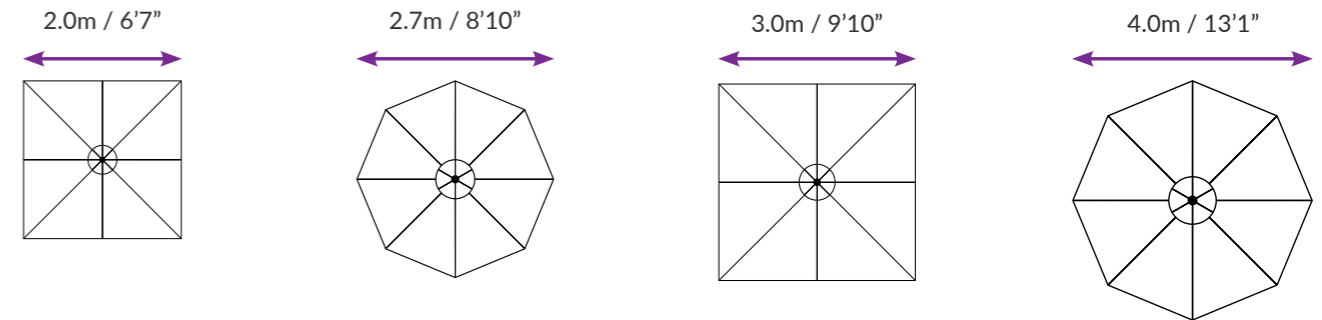

Canopy

- Premium 100% solution dyed canopy
- Maintenance: All fabrics can be washed and are replaceable
- Shade Rating: UPF 50+

Colors*



*other non stock colors available on request.

Custom Branding



We specialize in custom branding umbrellas with your logo/brand and message.

BEST-IN-CLASS WARRANTY

Relax easy knowing your outdoor umbrella purchase is protected by the industry's best warranty and customer support.



Fabric Warranty



Frame Warranty

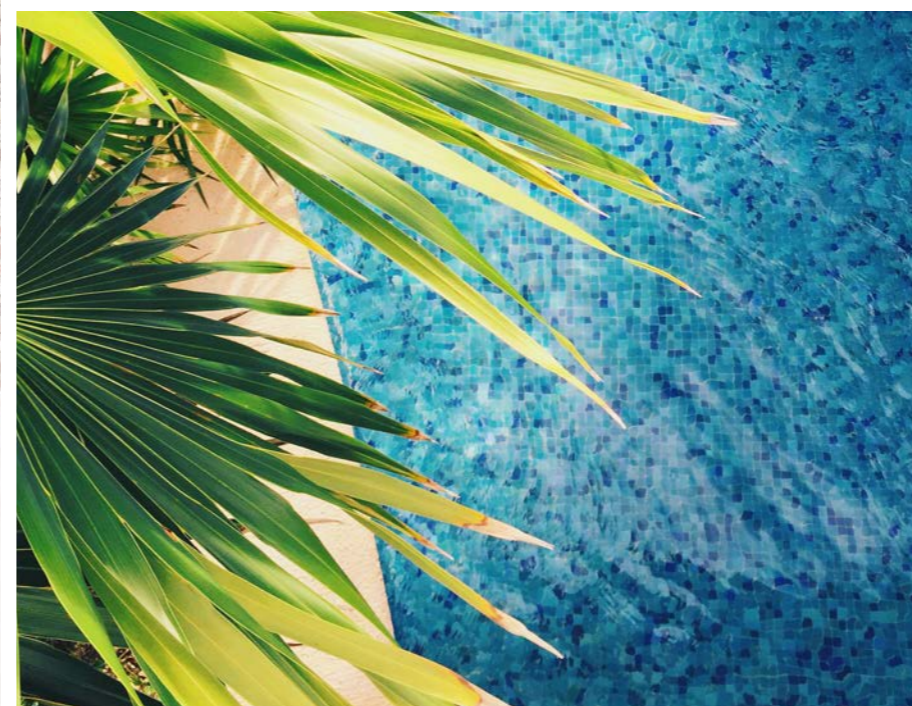
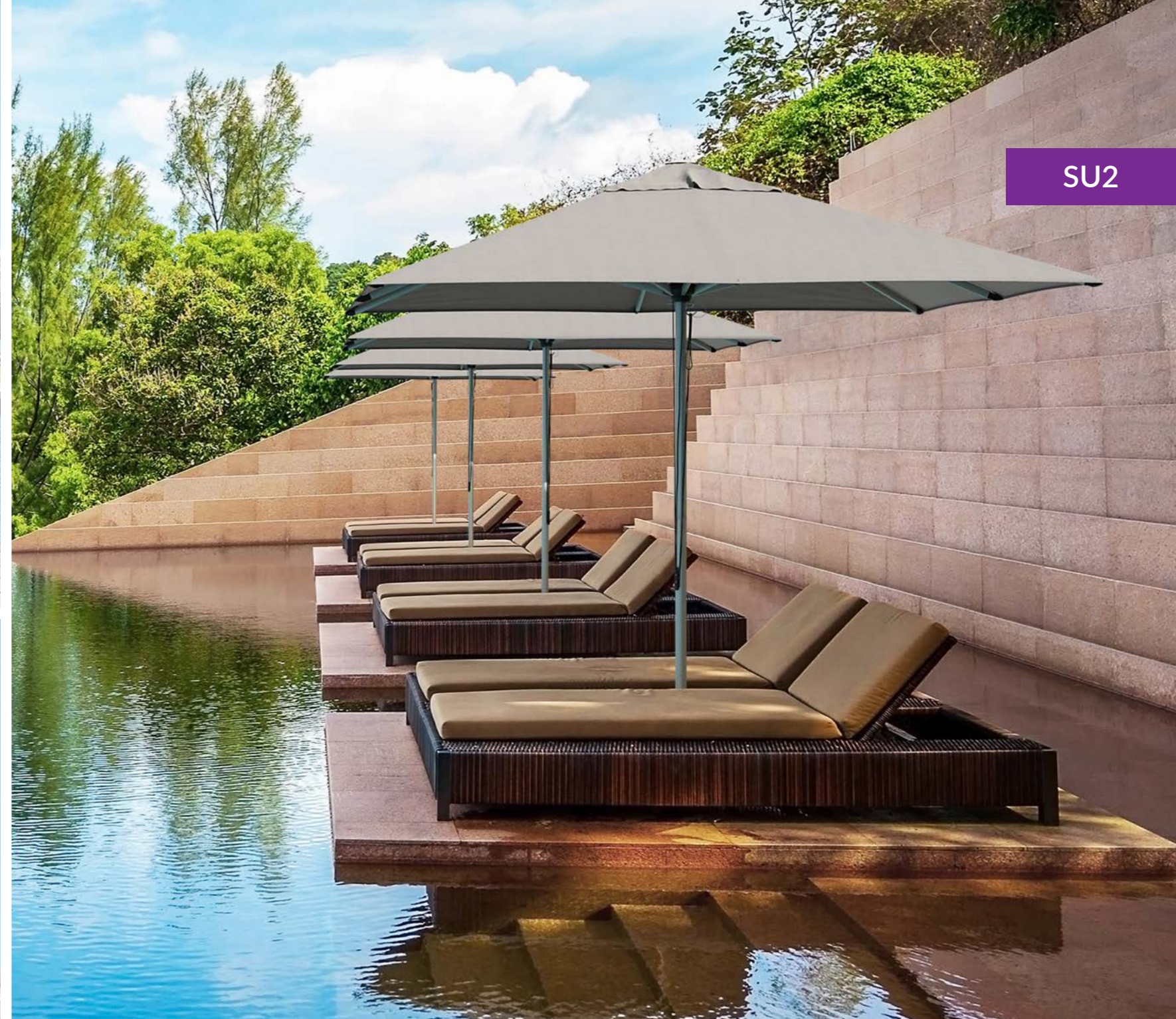



SU10

COMMERCIAL CENTRE POLE UMBRELLA

Tough, generous, and practical.
Heavy-duty protection for enduring spaces.

Designed to cover a wide range of applications and spaces. The heavy-duty SU10 Commercial Umbrella is engineered for hospitality proprietors to get the most out of their outdoor and alfresco spaces. Large outdoor umbrellas lower the setup time for staff and cover a substantial seating space, with just one product.

The true power of the SU10 is the telescopic mast design. This feature allows the SU10 to close above the standard height of the furniture. This large umbrella is available in multiple sizes, colors and configurations, with Surface Plate, In-ground Anchor or Portable Base mounting options.

*Minimum Order Quantity & Lead Times apply.



Size & Configuration

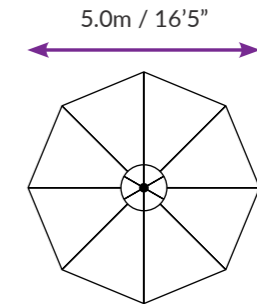
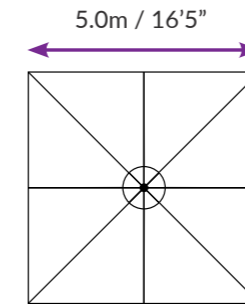
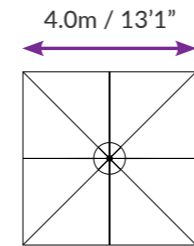

Canopy

- Premium Sunbrella Acrylic - 100% Solution Dyed
- Waterproof Rating: >300mm / 12" water column
- Maintenance: All fabrics can be washed and replaced
- Weight: 315 g/m2 / 9oz/yd²
- Colorfastness: 7-8/8
- Shade Rating: UPF 50+



Features at a glance

- Commercial grade aluminum frame structure
- Stainless steel hardware for longevity
- Durable high performance hub and fittings
- Telescopic mast enables umbrella to clear most furniture when closing
- Robust 82.5mm / IMM mast with 3.4mm wall thickness
- Custom designed protection cover included
- Tough, commercial grade 50 x 25mm strut arm profile

Accessories



Rain Gutter

Adjoining square umbrellas can be connected with removable rain gutters to increase weatherproof area.

Colors



Black

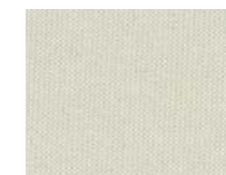

Oyster White



Ocean Blue

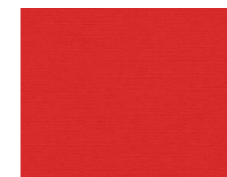

Logo Red



Charcoal Tweed



Sunflower Yellow

*Custom colors available on request. All colors are subject to availability. Please enquire regarding current lead times.

Custom Branding



We specialize in custom branding umbrellas with your logo/brand and message.

BEST-IN-CLASS WARRANTY

Relax easy knowing your outdoor umbrella purchase is protected by the industry's best warranty (conditions apply) and customer support. 3 year warranty applies for commercial applications.



Fabric Warranty



Frame Warranty



UMBRELLA FIXINGS

Mounting options for any spaces

Style and finish may vary across models

UNITY™ | SERENITY™ | SU10

Surface Plate

For deck, patio and concrete mounting.



In-Ground Anchor

For mounting with a concrete footing.



Free-Standing Base

For complete customized maneuverability.

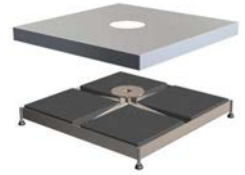

Concrete Pavers are required for ballast (not supplied).
Castor Wheels optional.

SU2

Surface Plate



Steel Flat Plate Base



Concrete Base



shadowspec
umbrellas with distinction