



swisslog
healthcare

Pneumatic Tube System



#SmartSolutions
...since 1953!

World's & South Asia's leading Swisslog Pneumatic Tube System [aka PTS] with clientele of over 465 in South Asia and over 12000 Worldwide [leading hospitals & healthcare providers, as at April 2019] are exclusively offered in the South Asian region by SNG.

With complete in-house design team SNG is competently placed to provide the most aptly designed bespoke solutions to its customers considering their architectural, structural, logistical & budgetary requirements. SNG has experienced, strong & expert in-house design, project's management & customer support teams, to ensure unmatched support to its clients, right from design to commissioning and after sales support, with a dedicated & centralized SNG Customer Care Centre.



Our customer support teams are located in Delhi, Mumbai, Chennai, Kolkata, Bangaluru, Hyderabad, Pune, Amdavad, Coimbatore, Vizag, Manipal, Kochi, Kathmandu & Colombo, with reach to all the corners of India & beyond to ensure quick response. SNG also has access facility via internet for remote diagnosis & serviceability.

Apart from the customer support, regular training sessions are also accorded to end users and their engineers for system's applications, operations, day-to-day trouble shooting & maintenance.



*For details, please refer to data sheets



Srishty Medical Private Limited

A 219
Road No.6
Mahipalpur NH-8
New Delhi-110037 INDIA

www.sngindia.org
customercare@sngindia.org
Mob. : +91 98100 07700



Sun Meditek Private Limited
MEDITEK



What is Pneumatic Tube System?

A Pneumatic Tube System is an in-house means of transport, which conveys various materials to different locations within a facility, building or campus.

Pneumatic Tube Systems are used for spontaneous transport of lab samples, reports & documents, cash, pharmaceuticals and drugs etc.

With a distribution network of tubes within the facility's buildings and campus, materials are transported in carriers to and from designated locations - providing automation and complementing the existing intra-facility logistics.

Swisslog Pneumatic Tube Systems are not merely equipment, but are detailed design solutions, customized specifically for customers and their needs. The systems are available in different tube diameters [Ø110mm, Ø160mm or Ø300mm]

How does a Pneumatic Tube System Function?

A Blower generates suction or compression that propels the carriers with flow of air through the tube network. Diverters create the possibility of extending the tube network in many directions. The system is more like a dialing facility, whereby, the user dials the destination address, places the carrier with contents into the station and then the air flow transports the carriers to the destination station.

Distance and height do not present any major challenge. Efficient positioning, designing, appropriate size of the blower units & no of lines offer limitless possibilities.



*For details, please refer to data sheets



Srishty Medical Private Limited

A 219
Road No.6
Mahipalpur NH-8
New Delhi-110037 INDIA

www.sngindia.org
customer@care@sngindia.org
Mob. : +91 98100 07700



Sun Meditek Private Limited
MEDITEK



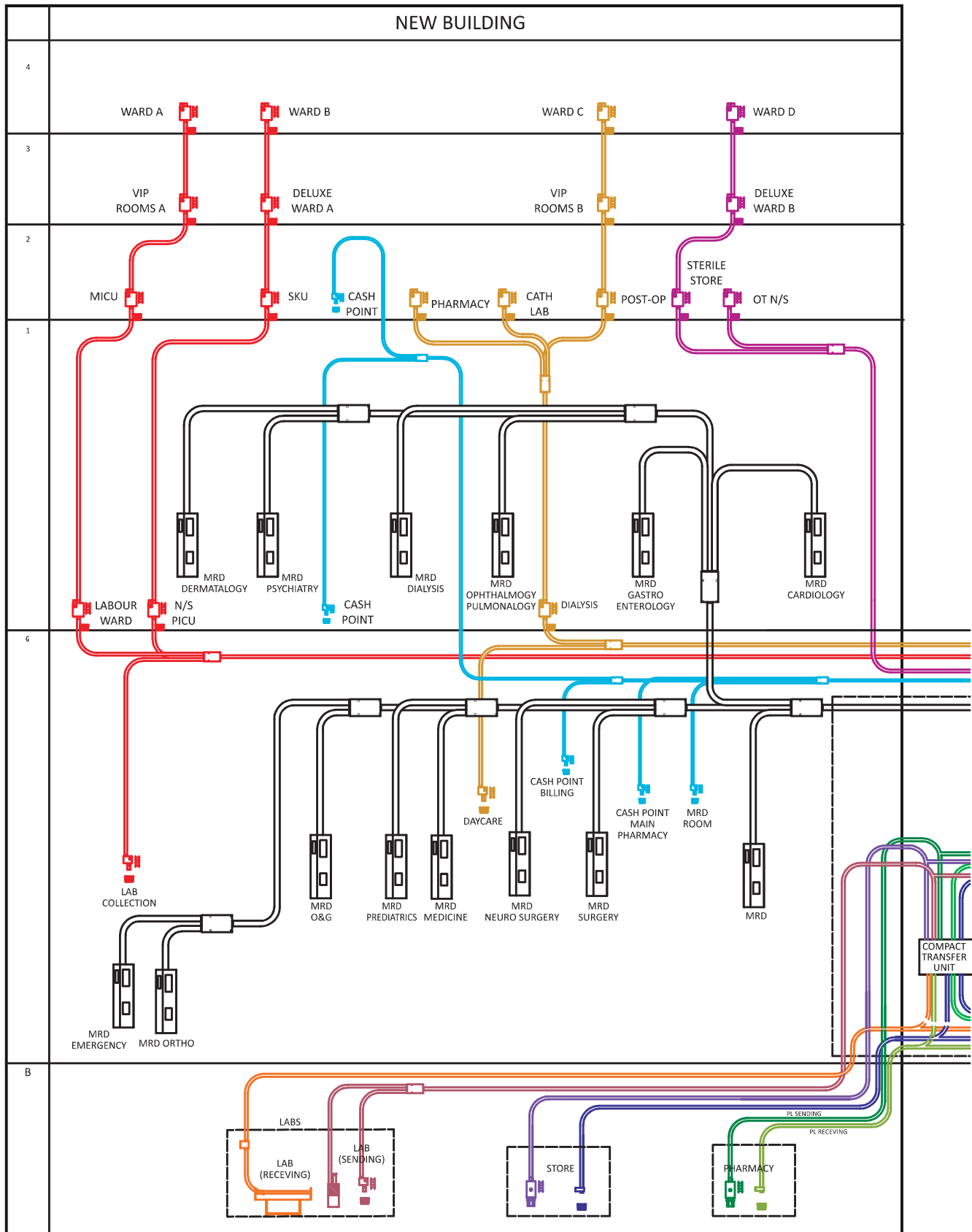

*For details, please refer to data sheets



Srishty Medical Private Limited

A 219
Road No.6
Mahipalpur NH-8
New Delhi-110037 INDIA

www.sngindia.org
customercare@sngindia.org
Mob. : +91 98100 07700



Sun Meditek Private Limited
MEDITEK



An example of an
SNG PTS solution
for a Hospital

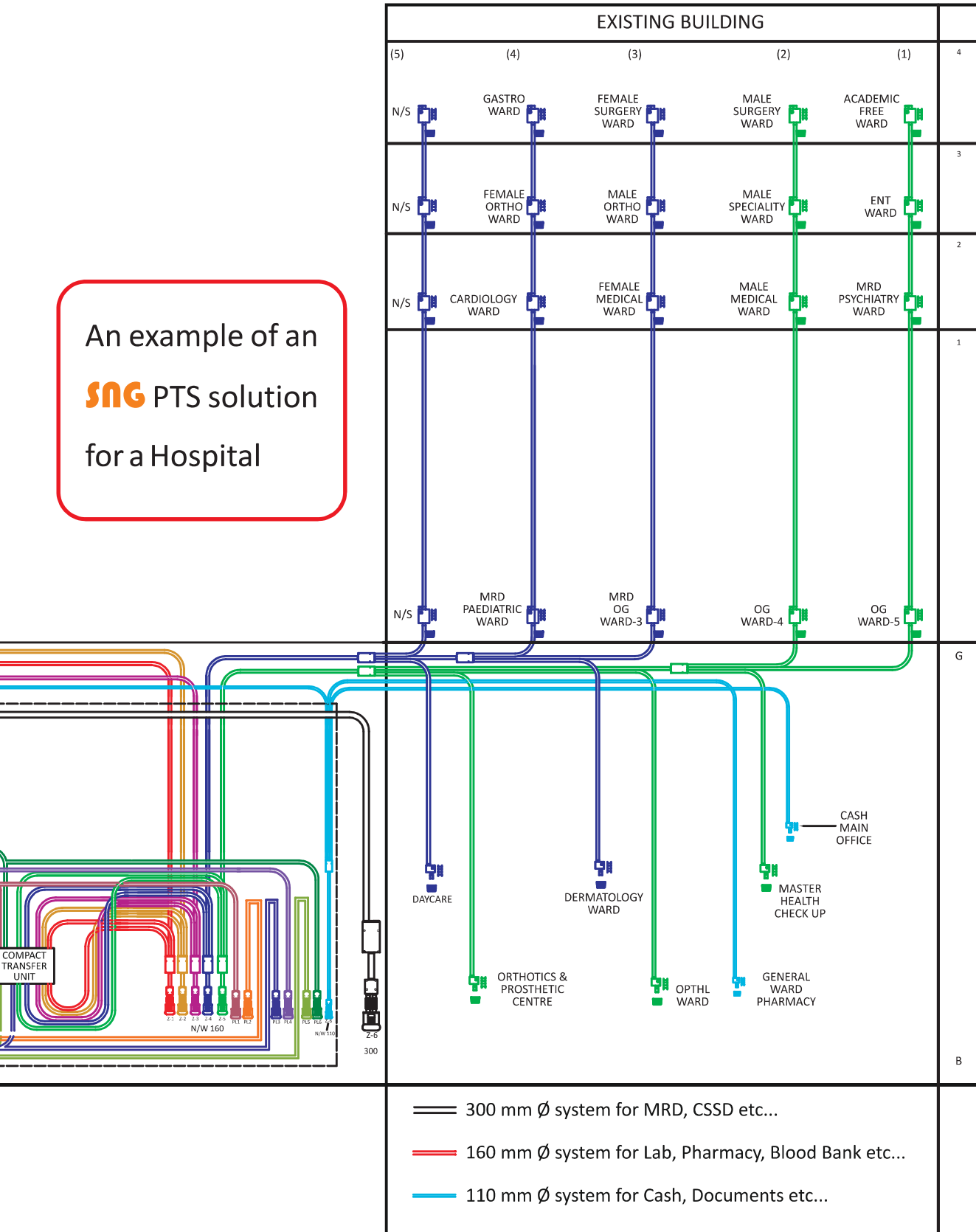

*For details, please refer to data sheets



Srishty Medical Private Limited

A 219
Road No.6
Mahipalpur NH-8
New Delhi-110037 INDIA

www.sngindia.org
customercare@sngindia.org
Mob. : +91 98100 07700



Sun Meditek Private Limited
MEDITEK



THE CONTROL SYSTEM



Swisslog Pneumatic Tube systems are fully PC & Software driven [Windows OS based], are user friendly and easy to maintain. The highly advanced TranspoNet control software offers various customized and project specific measures, based on the requirements of the industry, facility and customers. With the help of Pneumatic Tube System, it is possible to optimize the general in-house logistics automation and processes, while relieving staff for other important activities. The appropriate & correct implementation of the system enables improvement in quality, efficiency, safety & security, apart from possible reduction in cost of delivery of services & products.

Materials that are normally transported through Pneumatic Tube Systems are:

- * Laboratory Samples
- * Tissue Samples
- * Documents & Reports
- * Sections
- * Blood & Urine Samples
- * Hot samples [can also be transported using special tubes and carriers] etc.

*For details, please refer to data sheets



Srishty Medical Private Limited

A 219
Road No.6
Mahipalpur NH-8
New Delhi-110037 INDIA

www.sngindia.org
customercare@sngindia.org
Mob. : +91 98100 07700



Sun Meditek Private Limited
MEDITEK



THE CONTROL SOFTWARE

TranspoNet

TranspoNet Software offers powerful features to manage and maintain the Pneumatic Tube System with flexibility and efficiency.

Features and Functions:

T-Control [Standard]

- ▶ Mechanical and electrical control of the devices
- ▶ System Configuration
- ▶ Access and Timetable features for delivery
- ▶ Groups and Conditions
- ▶ Carrier management
- ▶ Powerline for multiple carrier transport & high traffic frequency
- ▶ System parameters settings for management and maintenance flexibility
- ▶ Priority Settings
- ▶ PIN Code Access
- ▶ Log Reports
- ▶ Real time communications speed display & monitoring

ComCentre & NetClient [Optional]

- ▶ Communication via voice messages SMS or email
- ▶ NetClient information service
- ▶ Connection with BMS / Fire Alarm Systems

T-Print [Optional]

- ▶ Print Module for reports and statistics



CONTROL SOFTWARE

Supervision [Optional]

- ▶ User Profiles and Rights
- ▶ System Graphic Visualization for monitoring, controlling and Maintenance
- ▶ Track and Trace tool for information and analysis [with or without RFID]
- ▶ Analysis Reports & Editing
- ▶ Carrier Call or Carrier Forward etc.
- ▶ Remote Access & Services etc.



From : Blood Bank
Sent : 10:35:10



*For details, please refer to data sheets



Srishty Medical Private Limited

A 219
Road No.6
Mahipalpur NH-8
New Delhi-110037 INDIA

www.sngindia.org
customer@care@sngindia.org
Mob. : +91 98100 07700



Sun Meditek Private Limited
MEDITEK





COMPACT STATION

[Ø160, Ø110]

Compact Bottom load station is an economical & fully automatic sending & receiving device; has been developed to meet the needs of customers who want to integrate modern pneumatic tube systems into their facilities with less and compact space. The Compact Station is an end station. Provided with integrated LCD Graphic Display with soft membrane key pad control panel [optionally 9" touch screen panel available].

Equipped with state of art, low maintenance linear gear drive mechanism and self adjusting optical seals for moving parts for low noise operations.

STATIONS



STANDARD STATION

[Ø160, Ø110]

Standard Top loading station is a fully automated sending and receiving device; for easy integration into most architectural configurations. Can be used as an end station or a through-run station. Provided with integrated LCD Graphic Display with soft membrane key pad control panel [optionally 9" touch screen panel available].

Equipped with state of art, low maintenance linear gear drive mechanism and self adjusting optical seals for moving parts for low noise operations.

*For details, please refer to data sheets



Srishty Medical Private Limited

A 219
Road No.6
Mahipalpur NH-8
New Delhi-110037 INDIA

www.sngindia.org
customercare@sngindia.org
Mob. : +91 98100 07700



Sun Meditek Private Limited
MEDITEK



FHC FRONT LOAD STATION

[Ø160, Ø110]

FHC Front Load Station is a fully automatic sending and receiving device, for easy integration into most architectural configurations. The loading port is located at an ergonomic height. Can be used as an end station or a through-run station. Provided with integrated LCD Graphic Display with soft membrane key pad control panel [optionally 9" touch screen panel available]. Optionally available top cover and bottom receiving cabinet with integrated carrier rack

Equipped with state of art, low maintenance linear gear drive mechanism and self adjusting optical seals for moving parts for low noise operations.



STATIONS

LC FRONT LOAD STATION

[Ø160]

LC Front Load station is an economical version fully automatic sending and receiving device with the loading port at an ergonomic height and a slender design for space saving. Can be used as an end station or a through station. The Station has integrated secure flap door which closes during sending process. Provided with integrated LCD Graphic Display with soft membrane key pad control panel [optionally 9" touch screen panel available].

Equipped with state of art, low maintenance linear gear drive mechanism and self adjusting optical seals for moving parts for low noise operations.



*For details, please refer to data sheets



Srishty Medical Private Limited

A 219
Road No.6
Mahipalpur NH-8
New Delhi-110037 INDIA

www.sngindia.org
customer@care@sngindia.org
Mob. : +91 98100 07700



Sun Meditek Private Limited
MEDITEK





TL FRONT LOAD STATION

[ØI60]

TL Front Load Station is a fully automatic sending and receiving device with the loading port at an ergonomic height and a smart box design, with an integrated secured motorized metal shutter door which opens during carrier loading & closes during carrier sending processes. The Station is provided with integrated LCD Graphic Display with soft membrane key pad control panel [optionally 9" touch screen panel available].

Equipped with state of art, low maintenance linear gear drive mechanism and self adjusting optical seals for moving parts for low noise operations.

STATIONS



ULTRA FRONT LOAD STATION

[ØI60]

Ultra Stations is the modern, advanced, fully automatic Front Load station, award winning futuristic design, for sending and receiving carriers. The Station has smart, ergonomic soft contoured design for maximum hygiene. The station housing is in high quality powder coated finished steel. The station's front panel is made of special polymer material with steel reinforcement with an integrated 9" Touch screen control panel that displays easy to use and access various functions and features. Optionally available with integrated receiving polymer basket.

Equipped with state of art, low maintenance linear gear drive mechanism and self adjusting optical seals for moving parts for low noise operations.

*For details, please refer to data sheets



#Smart Solutions...
...since 1953!



A 219
Road No.6
Mahipalpur NH-8
New Delhi-110037 INDIA

www.sngindia.org
customer@care@sngindia.org
Mob. : +91 98100 07700



Sun Meditek Private Limited
MEDITEK



HORIZONTAL LAB RECEIVING STATION

[Ø160, Ø110]

The laboratory receiving station has been developed for installation in laboratories for soft receiving of carriers horizontally length wise installed with motor slide gate and receiving bend to prevent damage to quality of samples.

Optionally available:

1. Stainless steel receiving platform with guide rails
2. Stainless steel receiving platform with guide rails and motorized conveying belts.



STATIONS

FLAP-LOG LAB RECEIVING STATION

[Ø160, Ø110]

The Flap Log laboratory receiving station has been developed for soft receiving of carrier horizontally, with special turn-around function that enable carriers to exit softly width-wise, which allows receiving of more carriers in less space. The carriers slow down, turn from a vertical position in the station to a horizontal position and roll-out to the special receiving platform.



*For details, please refer to data sheets



Srishty Medical Private Limited

A 219
Road No.6
Mahipalpur NH-8
New Delhi-110037 INDIA

www.sngindia.org
customercare@sngindia.org
Mob. : +91 98100 07700



Sun Meditek Private Limited
MEDITEK





OPENLOG STANDARD

AUTO UNLOAD STATION [ØI60]

The OpenLog Standard Station is a fully automatic unloading device for unloading of contents in the carrier and automatic return of carrier to its origin, without exiting the station, in a single line [ejection by gravitation].

*Smart Open carriers required.

STATIONS

OPENLOG+

AUTO UNLOAD STATIONS [ØI60]

The OpenLog+ Station is a fully automatic unloading device using carrier captive technology for automated unloading of contents in the carrier and automatic return of the carrier to its origin, without exiting the station, in the single line.

The OpenLog+ Station have special optimal unloading through mechanical brush, ensuring that the contents are completely unloaded.

OPENLOG+2

AUTO UNLOAD STATIONS [ØI60]

The OpenLog+2 Station is a fully automatic unloading device using captive carrier technology for automated unloading of the contents in the carrier and automatic return of carrier to its origin without exiting the station. OpenLog+2 Stations in two separate lines : one for auto unload and other for auto return of the carrier, thereby increasing throughput.

*Smart Open carriers required.

*For details, please refer to data sheets



OpenLog+



OpenLog+2



#Smart Solutions...
...since 1953!



Srishty Medical Private Limited

A 219
Road No.6
Mahipalpur NH-8
New Delhi-110037 INDIA

www.sngindia.org
customer@sgindia.org
Mob. : +91 98100 07700



Sun Meditek Private Limited
MEDITEK



MULTISEND STATION

[Ø160, Ø110]

The Multisend Station is equipped with three loading ports which allow upto 3 carriers to be loaded on to the station for sending multiple carriers in a sequence. The Station is provided with integrated LCD Display with soft membrane key pad control panel.

Equipped with state of art, low maintenance linear gear drive mechanism and self adjusting optical seals for moving parts for low noise operations.



AUTO RECEIVING STATION

[Ø160, Ø110]

The Auto Receiving Station allows continuous receiving of carriers enabling high throughput, especially in high traffic areas, such as pharmacy etc.

Equipped with state of art, low maintenance linear gear drive mechanism and self adjusting optical seals for moving parts for low noise operations.

AUTO RETURN STATION

[Ø160, Ø110]

The Auto Return Station is a fully automated carrier sending device for continuous sending of carriers to its origin or even provide carriers storage buffer which stores the carriers and sends it to stations which are carrier deficient.

Equipped with state of art, low maintenance linear gear drive mechanism and self adjusting optical seals for moving parts for low noise operations.

STATIONS



*For details, please refer to data sheets



Srishty Medical Private Limited

A 219
Road No.6
Mahipalpur NH-8
New Delhi-110037 INDIA

www.sngindia.org
customer@care@sngindia.org
Mob. : +91 98100 07700



Sun Meditek Private Limited
MEDITEK



STATION CONTROL PANEL



LCD GRAPHIC MONITOR KEYPAD

[Ø160, Ø110]

LCD Graphic Monitor Keypad is provided with easy to read and backlit LCD display with clear text information and display of directory, logs & various messages with integrated digital soft membrane keypad with easy to use telephone style layout with LED indicators.

CONTROL PANELS

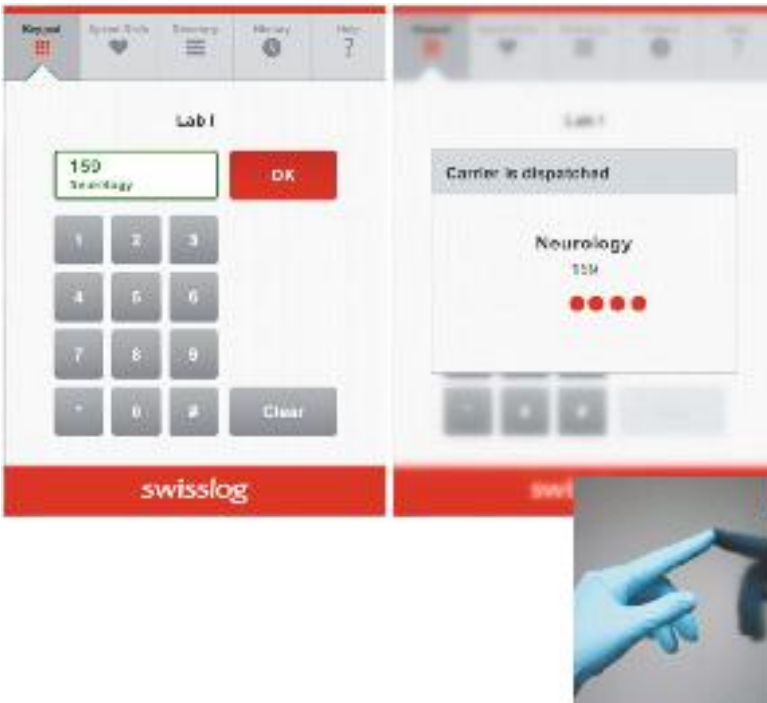

9" TOUCH SCREEN PANEL

[Ø160, Ø110]

9" Touch Screen Panel is a high quality & easy to use menu driven station control panel with illuminated screen display, with TFT-LCD Color display, Intuitive Operations and with Arrow Keys to navigate through menus. Can also be used with gloves.

*For details, please refer to data sheets



Srishty Medical Private Limited

A 219
Road No.6
Mahipalpur NH-8
New Delhi-110037 INDIA

www.sngindia.org
customer@sgindia.org
Mob. : +91 98100 07700



Sun Meditek Private Limited
MEDITEK



STATION ACCESS OPTIONS

For Advance Security Features, several options are available as follows:

Swipe Card Access



Contactless Access Cards



Bar Code Reader



Radio Frequency Identification [RFID] Technology



STATION OPTIONS

*For details, please refer to data sheets



Srishty Medical Private Limited

A 219
Road No.6
Mahipalpur NH-8
New Delhi-110037 INDIA

www.sngindia.org
customercare@sngindia.org
Mob. : +91 98100 07700



Sun Meditek Private Limited
MEDITEK













CARRIERS

Loading Dimensions [mm]	SafeSeal [Ø160]	SmartOpen [Ø160]	Standard [Ø160]	Standard [Ø110]
				
400 x 120			■	
330 x 120		■	■	
315 x 120	■			
230 x 120			■	
330 x 76				■
230 x 76				■
220 x 86				■

Other special sizes & special metallic carriers are available on request.

Cap Colour Options

SafeSeal [Ø160]	SmartOpen [Ø160]	Standard [Ø160]	Standard [Ø110]
	    	   	



*For details, please refer to data sheets



Srishty Medical Private Limited

A 219
Road No.6
Mahipalpur NH-8
New Delhi-110037 INDIA

www.sngindia.org
customercare@sngindia.org
Mob. : +91 98100 07700



Sun Meditek Private Limited
MEDITEK



STATION ACCESSORIES

a. CARRIER RACK

Wall mounted carrier rack constructed using stainless steel/ powder coated steel, for holding carriers.

b. CARRIER RECEIVING BASKET

Wall mounted carrier basket constructed using stainless steel/ powder coated steel, for receiving carriers on arrival.

c. UPHOLSTERY

Upholstery for carrier receiving basket used for reducing impact upon exit from station.



STATION ACCESSORIES

d. ARRIVAL INDICATOR

Audio/Visual arrival indicator for arrival notice of carriers in stations.

Available in Tower and Standard versions.



STANDARD VERSION

TOWER VERSION

*For details, please refer to data sheets



Srishty Medical Private Limited

A 219
Road No.6
Mahipalpur NH-8
New Delhi-110037 INDIA

www.sngindia.org
customer@care@sngindia.org
Mob. : +91 98100 07700



Sun Meditek Private Limited
MEDITEK



OPTIONAL ACCESSORIES FOR CARRIERS



Foam Inserts For
Vaccutainers



Foam Inserts For
Culture / Urine Containers



Foam Inserts For
Blood Bags



Cleaning Carrier



RFID

ACCESSORIES



Vaccuholder



Ziplock
& Zipper Bags

Bubble
Pouches



Leak Proof Sample Containers



*For details, please refer to data sheets



Srishty Medical Private Limited

A 219
Road No.6
Mahipalpur NH-8
New Delhi-110037 INDIA

www.sngindia.org
customercare@sngindia.org
Mob. : +91 98100 07700



Sun Meditek Private Limited
MEDITEK



SYSTEM COMPONENTS

LAN CONVERTER

An active communication LAN converter unit connects the PC control with system devices for high speed communications, based on RS485 protocols providing 70-120 dps.

POWER PACK

Power Packs are for boosting LVDC, low voltage supply and high speed network communication signal.



COMPOSITE CONTROL CABLE

The High speed RS485 protocol based system control composite cable for LVDC low voltage supply and high speed communications to/with various system devices. The Cable is also grounded and shielded from RF and EM interference. The Cable enables communication speeds of approx 70 -120 dps.

SYSTEM COMPONENTS

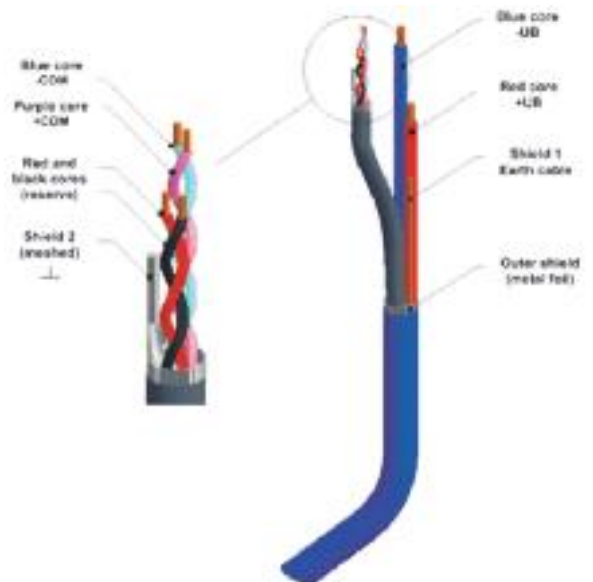
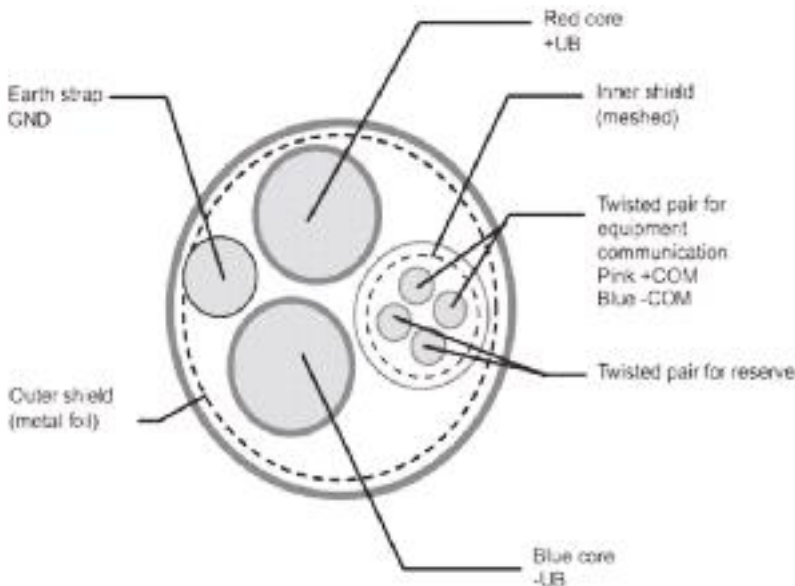

*For details, please refer to data sheets



A 219
Road No.6
Mahipalpur NH-8
New Delhi-110037 INDIA

www.sngindia.org
customer@sgindia.org
Mob. : +91 98100 07700



FORWARDING TUBES & BENDS

PVC-U Forwarding Tube -
Grey



PVC-U Forwarding Bend -
Grey



PVC-U Forwarding Tube –
Milky Transparent



PVC-U Forwarding Bend –
Milky Transparent



Plexiglas Forwarding Tube -
Clear Transparent



Plexiglas Forwarding Bend –
Clear Transparent



*Also Available Galvanized / Stainless Steel / Special Underground Tubes & Bends for special project requirements.

TUBES & ACCESSORIES

INSTALLATION ACCESSORIES

Tube Clamps



Tube Clips



PVC-U Sleeves



Zip Ties



Optical Tube Switch



Srishty Medical Private Limited

A 219
Road No.6
Mahipalpur NH-8
New Delhi-110037 INDIA

www.sngindia.org
customercare@sngindia.org
Mob. : +91 98100 07700



Sun Meditek Private Limited
MEDITEK



*For details, please refer to data sheets

SIDE CHANNEL BLOWER UNITS

Available from 1 KW - 8 KW with Volumetric Flow - 3m³/min to 11m³/min to suit the need of the system networks based on diameter, length of tube network & payload capacities etc.



Blower Unit



Air Switch Diverter Unit



Motor Contactor Unit

BLOWERS



STANDARD BLOWER ACCESSORIES :

- Airway Diverter Unit [Air Switch]
- Motor Contactor
- Silencer
- Vibration Dampers
- Air Filters
- Carrier Damper
- Throttle Device
- Optional VFD/ Slow Starter Device

*For details, please refer to data sheets



Srishty Medical Private Limited

A 219
Road No.6
Mahipalpur NH-8
New Delhi-110037 INDIA

www.sngindia.org
customer@care@sngindia.org
Mob. : +91 98100 07700



Sun Meditek Private Limited
MEDITEK



DIVERTER UNITS

[Ø160, Ø110]



The diverter units are used for branching/switching between lines and are manufactured using high quality steel with minimized electrostatic interference.

Equipped with state of art, low maintenance linear gear drive mechanism and self adjusting optical seals for moving parts for low noise operations.

* Available in 2-way, 3-way, 4-way and 6-way

DIVERTERS



*For details, please refer to data sheets



Srishty Medical Private Limited

A 219
Road No.6
Mahipalpur NH-8
New Delhi-110037 INDIA

www.sngindia.org
customer@care@sngindia.org
Mob. : +91 98100 07700



Sun Meditek Private Limited
MEDITEK



ZONE TRANSFER UNITS

DIVERTER BASED ZONE TRANSFER UNIT

[Ø160, Ø110]

The diverter based zone transfer units are used for branching/ switching between lines/zones and manufactured using high quality steel with minimized electrostatic interference.

*For maximum 2 zones



AUTOMATIC LINEAR COMPACT ZONE TRANSFER UNIT

[Ø160, Ø110]

The Linear Compact Zone Transfer Unit has been designed to connect various standard Zones & PowerLines for quick and high speed interchange of lines/ zones, thereby reducing wait time & increasing throughput while using less space for quick linear distance travels.

Several compact transfer units installed in different strategic places can be interconnected with Power line Technology. A single Automatic Compact Transfer Unit can connect between 2 - 16 lines [Available in 4, 8, 12 & 16 Zone Transfer Units]. Multiple Transfer Units can be linked and coupled for unlimited no of lines/ zones. The Units are designed to manage high speed carrier transfer including priority transports and can also store upto 10 carriers in each line [depending upon the availability of height].

ZONE TRANSFER



*For details, please refer to data sheets



Srishty Medical Private Limited

A 219
Road No.6
Mahipalpur NH-8
New Delhi-110037 INDIA

www.sngindia.org
customercare@sngindia.org
Mob. : +91 98100 07700



Sun Meditek Private Limited
MEDITEK





- Delhi
- Mumbai
- Chennai
- Kolkata
- Bengaluru
- Hyderabad
- Pune
- Amdavad
- Coimbatore
- Vizag
- Manipal
- Kochi
- Kathmandu
- Colombo



Srishty Medical Private Limited

Sun Meditek Private Limited
MEDITEK

A 219
Road No.6
Mahipalpur NH-8
New Delhi-110037 INDIA

www.sngindia.org
customercare@sngindia.org
Mob. : +91 98100 07700

