

ELEKTRİKLİ FRİTÖZ

ELECTRIC FRYERS



	KOD CODE	KRCS.SFE.5
	H L	300x570x290
		220V-50Hz / 2,5 KW
	L	5 lt
	°C	50°C -200°C
	KG	8 kg
	420x600x320	€ 245

SNACK SERİ ELEKTRİKLİ FRİTÖZ

SNACK SERIES ELECTRIC FRYERS



	KOD CODE	KRCS.SFE.33
	H L	400x570x290
		220V-50Hz / 5 KW
	L	3+3 lt
	°C	50°C -200°C
	KG	12 kg
	420x610x320	€ 375

	KOD CODE	KRCS.SFE.8
	H L	350x570x290
		220V-50Hz / 2,5 KW
	L	8 lt
	°C	50°C -200°C
	KG	9 kg
	380x610x320	€ 330

	KOD CODE	KRCS.SFE.55
	H L	600x570x290
		220V-50Hz / 5 KW
	L	5+5 lt
	°C	50°C -200°C
	KG	15 kg
	840x610x320	€ 395

- 
- Termostatik kontrol.
  - Paslanmaz çelik sepetler.
  - Hareketli ısıtıcılar kolay temizlik imkanı sağlar.
  - Tahliye musluğu ile emniyetli yağ boşaltma.
  - Limit termostat.
  - Kolay temizlenebilir ve hijyeniktir.
  - Paslanmaz çelik gövde.

- 
- Thermostatic controller.
  - Stainless steel baskets.
  - Moving heaters provide easy cleaning.
  - Front oil drainage valve.
  - Safety thermostat for overheating protection.
  - Easy to clean and hygienic.
  - Stainless steel body.

- 
- Paslanmaz çelik gövde
  - Pilot lamba termostat kontrollü (50°C - 200°C)
  - Güvenlik termostatı
  - Yağ boşaltma musluğu
  - Soğuk yağ bölgesi

- 
- Stainless steel body
  - Pilot lamp with thermostat control (50°C - 200°C)
  - Safety thermostat
  - oil drain cock
  - cold oil zone



☐ ELEKTRİKLİ SNACK SERİ PLEYT IZGARA

☐ ELEKTRİKLİ SNACK SERİ PLEYT IZGARA

☐ ELECTRIC SNACK SERIES PLATE GRILL

☐ ELECTRIC SNACK SERIES PLATE GRILL



	KOD CODE	KRCS.SIZPE.357		
		300x570x290		
		1200cm <sup>2</sup>		50°C -300°C
		220V-50Hz /1,5 KW		
		10 kg		
		390x610x330		€ 245

	KOD CODE	KRCS.SIZPE.557		
		500x570x290		
		2000cm <sup>2</sup>		50°C -300°C
		220V-50Hz / 2,5 KW		
		13 kg		
		630x610x330		€ 305



- Termostatik kontrol.
- Tam modüllerde iki bölgeyi ısıtma.
- Çıkarılabilir yağ toplama haznesi.
- Kolay temizlenebilir ve hijyeniktir.
- Paslanmaz çelik gövde.



- Thermostatic controller.
- Two separate heating zones.
- Removable oil collection drawer
- Easy to clean and hygienic.
- Stainless steel body



- Termostatik kontrol.
- Tam modüllerde iki bölgeyi ısıtma.
- Çıkarılabilir yağ toplama haznesi.
- Kolay temizlenebilir ve hijyeniktir.
- Paslanmaz çelik gövde.



- Thermostatic controller.
- Two separate heating zones.
- Removable oil collection drawer
- Easy to clean and hygienic.
- Stainless steel body

GAZLI SNACK SERİ PLEYT IZGARA

GAZLI SNACK SERİ PLEYT IZGARA

GAS SNACK SERIES PLATE GRILL

GAS SNACK SERIES PLATE GRILL



	KOD CODE	KRCS.SIZPG.357
		300x570x290
		1200cm <sup>2</sup>
		2422-GAR-7115/23
		4.1 KW 20 mbar
		SIZPG.357 (NG)
		10 kg
		390x610x330  € 275

	KOD CODE	KRCS.SIZPG.557
		500x570x290
		2000cm <sup>2</sup>
		2422-GAR-7115/23
		4.1 KW 20 mbar
		SIZPG.557 (NG)
		13 kg
		630x610x330  € 305

	KOD CODE	KRCS.SIZPGL.357
		300x570x290
		1200cm <sup>2</sup>
		2422-GAR-7115/23
		2.5 KW 30 mbar
		SIZPGL.357 (LPG)
		10 kg
		390x610x330  € 275

	KOD CODE	KRCS.SIZPGL.557
		500x570x290
		2000cm <sup>2</sup>
		2422-GAR-7115/23
		2.5 KW 30 mbar
		SIZPGL.557 (LPG)
		13 kg
		630x610x330  € 305

- Lpg ve Ng ile çalışabilme özelliği.
- Magnet emniyet ventilli ve pilotlu musluklar.
- Tam modüllerde iki bölge pişirme.
- Her brülör için piezzo çakmak ile kontrol.
- Çıkarılabilir yağ toplama haznesi.
- Kolay temizlenebilir ve hijyeniktir.
- Paslanmaz çelik gövde.

- Lpg or Natural Gas.
- Magnet safety valves with pilot.
- Two separate heating zones.
- Piezoelectric ignition system for each module.
- Removable oil collection drawer.
- Easy to clean and hygienic.
- Stainless steel body.

- Lpg ve Ng ile çalışabilme özelliği.
- Magnet emniyet ventilli ve pilotlu musluklar.
- Tam modüllerde iki bölge pişirme.
- Her brülör için piezzo çakmak ile kontrol.
- Çıkarılabilir yağ toplama haznesi.
- Kolay temizlenebilir ve hijyeniktir.
- Paslanmaz çelik gövde.

- Lpg or Natural Gas.
- Magnet safety valves with pilot.
- Two separate heating zones.
- Piezoelectric ignition system for each module.
- Removable oil collection drawer.
- Easy to clean and hygienic.
- Stainless steel body.



# FS FRIGO

KAFETERYA GRUBU

CAFETERIA GROUP

☐ ELEKTRİKLİ SNACK SERİ IZGARA

☐ ELEKTRİKLİ SNACK SERİ IZGARA

☐ ELECTRIC SNACK SERIES GRILL

☐ ELECTRIC SNACK SERIES GRILL



	<b>KOD CODE</b> KRCS.SIZDE.357
	300x570x290
	1200cm <sup>2</sup>
	220V-50Hz / 1,5 KW
	14 kg
	390x610x330
	€ 265

	<b>KOD CODE</b> KRCS.SIZDE.557
	500x570x290
	2000cm <sup>2</sup>
	220V-50Hz / 2,5 KW
	24 kg
	630x610x330
	€ 325



- Termostatik kontrol.
- Tam modüllerde iki bölge ısıtma.
- Çıkarılabilir yağ toplama haznesi.
- Kolay temizlenebilir ve hijyeniktir.
- Paslanmaz çelik gövde.



- Thermostatic controller.
- Two separate heating zones.
- Removable oil collection drawer
- Easy to clean and hygienic.
- Stainless steel body



- Termostatik kontrol.
- Tam modüllerde iki bölge ısıtma.
- Çıkarılabilir yağ toplama haznesi.
- Kolay temizlenebilir ve hijyeniktir.
- Paslanmaz çelik gövde.



- Thermostatic controller.
- Two separate heating zones.
- Removable oil collection drawer
- Easy to clean and hygienic.
- Stainless steel body



GAZLI SNACK SERİ IZGARA

GAS SNACK SERIES GRILL



GAZLI SNACK SERİ IZGARA

GAS SNACK SERIES GRILL



	KOD CODE	KRCS.SIZDG.357
	H L	300x570x290
		1200cm <sup>2</sup>
	CE	2422-GAR-7115/23
		4.1 KW 20 mbar
		SIZDG.357 (NG)
		14 kg
	390x610x330	€ 295

	KOD CODE	KRCS.SIZDG.557
	H L	500x570x290
		2000cm <sup>2</sup>
	CE	2422-GAR-7115/23
		4.1 KW 20 mbar
		SIZDG.557 (NG)
		24 kg
	630x610x330	€ 335

	KOD CODE	KRCS.SIZDGL.357
	H L	300x570x290
		1200cm <sup>2</sup>
	CE	2422-GAR-7115/23
		2.5 KW 30 mbar
		SIZDGL.357 (LPG)
		14 kg
	390x610x330	€ 295

	KOD CODE	KRCS.SIZDGL.557
	H L	500x570x290
		2000cm <sup>2</sup>
	CE	2422-GAR-7115/23
		2.5 KW 30 mbar
		SIZDGL.557 (LPG)
		24 kg
	630x610x330	€ 335

- Lpg ve Ng ile çalışabilme özelliği.
  - Magnet emniyet ventilli ve pilotlu musluklar.
  - Tam modüllerde iki bölge pişirme.
  - Her brulör için piezzo çakmak ile kontrol.
  - Çıkarılabilir yağ toplama haznesi.
  - Kolay temizlenebilir ve hijyeniktir.
  - Paslanmaz çelik gövde.

- Lpg or Natural Gas.
  - Magnet safety valves with pilot.
  - Two separate heating zones.
  - Piezoelectric ignition system for each module.
  - Removable oil collection drawer.
  - Easy to clean and hygienic.
  - Stainless steel body.

- Lpg ve Ng ile çalışabilme özelliği.
  - Magnet emniyet ventilli ve pilotlu musluklar.
  - Tam modüllerde iki bölge pişirme.
  - Her brulör için piezzo çakmak ile kontrol.
  - Çıkarılabilir yağ toplama haznesi.
  - Kolay temizlenebilir ve hijyeniktir.
  - Paslanmaz çelik gövde.

- Lpg or Natural Gas.
  - Magnet safety valves with pilot.
  - Two separate heating zones.
  - Piezoelectric ignition system for each module.
  - Removable oil collection drawer.
  - Easy to clean and hygienic.
  - Stainless steel body.



# FS FRIGO

KAFETERYA GRUBU

CAFETERIA GROUP

☐ ELEKTRİKLİ SNACK SERİ OCAK

☐ ELEKTRİKLİ SNACK SERİ OCAK

☐ ELECTRIC SNACK SERIES COOKER

☐ ELECTRIC SNACK SERIES COOKER



	KOD CODE	KRCS.SPOE.357
	H	350x570x290
	⚡	220V 50Hz / 3 KW
	Ø	2 ADET
	KG	10 kg
	☐	390x610x330 🚚 € 330

	KOD CODE	KRCS.SPOE.557
	H	500x570x290
	⚡	220V 50Hz / 6 KW
	Ø	4 ADET
	KG	15 kg
	☐	630x610x330 🚚 € 465



- 6 kademeli şalter.
- Kolay temizlenebilir ve hijyeniktir.
- Paslanmaz çelik gövde.



- 6 position switch.
- Easy to clean and hygienic.
- Stainless steel body.



- 6 kademeli şalter.
- Kolay temizlenebilir ve hijyeniktir.
- Paslanmaz çelik gövde.



- 6 position switch.
- Easy to clean and hygienic.
- Stainless steel body.

GAZLI SNACK SERİ OCAK

GAZLI SNACK SERİ OCAK

GAS SNACK SERIES COOKER

GAS SNACK SERIES COOKER



	KOD CODE	KRCS.SOG.357.CE
		350x570x290
		2 ADET
		2422-GAR-7115/29
		3.51 KW 20 mbar
		SOG.357.CE (NG)
		10 kg
	390x610x330	285

	KOD CODE	KRCS.SOG.557.CE
		500x570x290
		4 ADET
		2422-GAR-7115/29
		7.02 KW 20 mbar
		SOG.557.CE (NG)
		20 kg
	630x610x330	415

	KOD CODE	KRCS.SOGL.357.CE
		350x570x290
		2 ADET
		2422-GAR-7115/29
		2.48 KW 30 mbar
		SOGL.357.CE (LPG)
		10 kg
	390x610x330	285

	KOD CODE	KRCS.SOGL.557.CE
		500x570x290
		4 ADET
		2422-GAR-7115/29
		4.96 KW 30 mbar
		SOGL.557.CE (LPG)
		20 kg
	630x610x330	415

- Lpg ve Ng ile çalışabilme özelliği.
- Magnet emniyet ventilli musluklar.
- Özel emaye kaplı güçlü ızgara.
- Kademeli şalter.
- Çift yanışlı brülör.
- Her brülör için piezzo çakmak ile kontrol.
- Kolay temizlenebilir ve hijyeniktir.
- Paslanmaz çelik gövde.

- Lpg or Natural Gas.
- Magnet safety valves.
- Solid enamelled cast iron.
- Positioned switch.
- Double ring burner.
- Piezo electric ignition system for each module.
- Easy to clean and hygienic.
- Stainless steel body

- Lpg ve Ng ile çalışabilme özelliği.
- Magnet emniyet ventilli musluklar.
- Özel emaye kaplı güçlü ızgara.
- Kademeli şalter.
- Çift yanışlı brülör.
- Her brülör için piezzo çakmak ile kontrol.
- Kolay temizlenebilir ve hijyeniktir.
- Paslanmaz çelik gövde.

- Lpg or Natural Gas.
- Magnet safety valves.
- Solid enamelled cast iron.
- Positioned switch.
- Double ring burner.
- Piezo electric ignition system for each module.
- Easy to clean and hygienic.
- Stainless steel body

# FS FRIGO

🇹🇷 ELEKTRİKLİ SNACK SERİ PATATES DİNLENDİRME 🇹🇷 ELEKTRİKLİ SOSİSLİK

🇬🇧 ELECTRIC SNACK SERIES POTATO RESTING

🇬🇧 ELECTRIC SAUSAGE ROLLER



	<b>KOD CODE</b>	<b>KRCS.SPDE.35</b>
		350x570x290
		2/3 GN100
		220V-50Hz / 1 KW
		10 kg
		420x620x320  € <b>285</b>

	<b>KOD CODE</b>	<b>KRCS.SSE.1</b>
		390x380x550
		1 KAP
		220V 50Hz / 1 KW
		11 kg
		450x450x260  € <b>213</b>

	<b>KOD CODE</b>	<b>KRCS.SSE.3</b>
		545x440x550
		3 KAP
		220V 50Hz / 1 KW
		14 kg
		680x610x430  € <b>253</b>



- Kızartılmış patateslerin sıcak bekletilmesinde ve yağların süzülmesinde kullanılır.  
- Infrared seramik ısıtıcı.  
- Havuzda kızartma yağının süzülmesi için maksimum verim sağlayan özel form.  
- Kolay temizlenebilir ve hijyeniktir.  
- Paslanmaz çelik gövde.



- Operates in order to keep fries warm and drain oil.  
- Infrared ceramic heater.  
- Special form on the container, provides maximum efficiency in order to drain oil.  
- Easy to clean and hygienic.  
- Stainless steel body.



Paslanmaz malzemeden üretilmiştir. Otomatik termostat kontrollüdür. Açma kapama anahtarına sahiptir.



It is made of stainless material. It is automatic thermostat controlled. It has an on/off switch.

ELEKTRİKLİ SET ÜSTÜ BÖREKLİK

ELEKTRİKLİ SICAK TEŞHİR ÜNİTESİ

ELECTRIC COUNTER TOP PASTRY RACK

ELECTRIC HOT DISPLAY UNIT



	<b>KOD CODE</b>	<b>KRCS.SUBE.660</b>
	H L	600x600x550
		2500cm <sup>2</sup>
		220V-50Hz / 2 KW
		28 kg
		620x620x300  € <b>250</b>

	<b>KOD CODE</b>	<b>KRCS.SCTU.70</b>
	H L	700x570x700
		120 lt
		220V-50Hz / 1,5 KW
		50 kg
		780x670x900  € <b>950</b>

	<b>KOD CODE</b>	<b>KRCS.SUBE.860</b>
	H L	800x600x550
		3500cm <sup>2</sup>
		220V-50Hz / 2 KW
		31 kg
		820x620x300  € <b>288</b>

	<b>KOD CODE</b>	<b>KRCS.SCTU.85</b>
	H L	900x570x700
		160 lt
		220V-50Hz / 1,5 KW
		58 kg
		980x670x900  € <b>1125</b>

	<b>KOD CODE</b>	<b>KRCS.SUBE.1060</b>
	H L	1000x600x550
		4500cm <sup>2</sup>
		220V-50Hz / 2,5 KW
		35 kg
		1020x620x300  € <b>363</b>

Paslanmaz malzemeden üretilmiştir.  
Otomatik termostat kontrollüdür.  
Açma kapama anahtarına sahiptir.

It is made of stainless material.  
It is automatic thermostat controlled.  
It has an on/off switch.

- 220 V çalışma voltajı.  
- Termostat kontrollü.  
- Pleksiglas üst raf.

- 220 V operating voltage.  
- Safety thermostat.  
- Plexiglas top shelf.





☐ ELEKTRİKLİ TEKLİ EKONOMİK FRİTÖZ

☐ ELEKTRİKLİ ÇİFTLİ EKONOMİK FRİTÖZ

🇬🇧 ELECTRIC SINGLE ECONOMIC FRYER

🇬🇧 ELECTRIC DOUBLE ECONOMIC FRYER



	<b>KOD CODE</b> KRCS.EFE.3
	185x360x200
	220V-50Hz / 2,5 KW
	3 lt
	4,5 kg
	200x530x420  € 119

	<b>KOD CODE</b> KRCS.EFE.33
	370x360x200
	220V-50Hz / 5 KW
	3+3 lt
	9 kg
	400x595x420  € 203

	<b>KOD CODE</b> KRCS.EFE.5
	270x360x200
	220V-50Hz / 2,5 KW
	5 lt
	6 kg
	280x530x420  € 138

	<b>KOD CODE</b> KRCS.EFE.55
	565x360x200
	220V-50Hz / 5 KW
	5+5 lt
	11 kg
	585x530x420  € 225

	<b>KOD CODE</b> KRCS.EFE.8
	350x360x200
	220V-50Hz / 2,5 KW
	8 lt
	7 kg
	360x600x420  € 150

	<b>KOD CODE</b> KRCS.EFE.88
	665x450x200
	220V-50Hz / 5 KW
	8+8 lt
	12,5 kg
	575x680x420  € 263



- Termostatik kontrol.
- Paslanmaz çelik sepetler.
- Hareketli ısıtıcılar kolay temizlik imkanı sağlar.
- Tahliye musluğu ile emniyetli yağ boşaltma.
- Limit termostat.
- Kolay temizlenebilir ve hijyeniktir.
- Paslanmaz çelik gövde.



- Thermostatic controller.
- Stainless steel baskets.
- Moving heaters provide easy cleaning.
- Front oil drainage valve.
- Safety thermostat for overheating protection.
- Easy to clean and hygienic.
- Stainless steel body



- Termostatik kontrol.
- Paslanmaz çelik sepetler.
- Hareketli ısıtıcılar kolay temizlik imkanı sağlar.
- Tahliye musluğu ile emniyetli yağ boşaltma.
- Limit termostat.
- Kolay temizlenebilir ve hijyeniktir.
- Paslanmaz çelik gövde.



- Thermostatic controller.
- Stainless steel baskets.
- Moving heaters provide easy cleaning.
- Front oil drainage valve.
- Safety thermostat for overheating protection.
- Easy to clean and hygienic.
- Stainless steel body

GAZLI TEKLİ EKONOMİK FRİTÖZ

GAZLI ÇİFTLİ EKONOMİK FRİTÖZ

GAS SINGLE ECONOMIC FRYER

GAS DOUBLE ECONOMIC FRYER

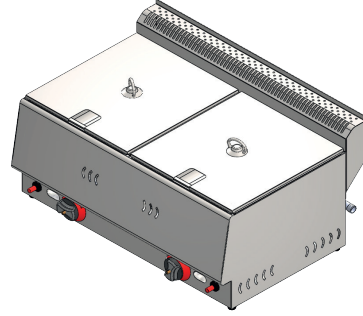
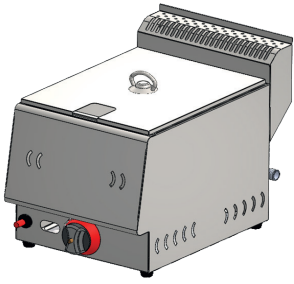

KOD CODE		KRC.S.EFG.5
		270x430x350
		5 lt
		2422-GAR-7115/11
		4.03 KW 20 mbar
		EFG.5 (NG)
		7 kg
		280x530x405  € 150

KOD CODE		KRC.S.EFG.55
		540x430x350
		5+5 lt
		2422-GAR-7115/11
		8.06 KW 20 mbar
		EFG.55 (NG)
		10 kg
		550x585x405  € 250

KOD CODE		KRC.S.EFG.8
		350x430x350
		8 lt
		2422-GAR-7115/11
		4.03 KW 20 mbar
		EFG.8 (NG)
		8 kg
		360x600x405  € 175

KOD CODE		KRC.S.EFG.88
		700x430x350
		8+8 lt
		2422-GAR-7115/11
		8.06 KW 20 mbar
		EFG.88 (NG)
		14,5 kg
		710x575x405  € 288

- 
- Lpg ve Ng ile çalışabilme özelliği.
  - Magnet emniyet ventilli musluklar.
  - Paslanmaz çelik sepetler.
  - Tahliye musluğu ile emniyetli yağ boşaltma.
  - Limit termostat.
  - Kolay temizlenebilir ve hijyeniktir.
  - Paslanmaz çelik gövde.

- 
- Lpg or Natural Gas.
  - Magnet safety valves.
  - Stainless steel baskets.
  - Front oil drainage valve.
  - Safety thermostat for overheating protection.
  - Easy to clean and hygienic.
  - Stainless steel body

- 
- Lpg ve Ng ile çalışabilme özelliği.
  - Magnet emniyet ventilli musluklar.
  - Paslanmaz çelik sepetler.
  - Tahliye musluğu ile emniyetli yağ boşaltma.
  - Limit termostat.
  - Kolay temizlenebilir ve hijyeniktir.
  - Paslanmaz çelik gövde.

- 
- Lpg or Natural Gas.
  - Magnet safety valves.
  - Stainless steel baskets.
  - Front oil drainage valve.
  - Safety thermostat for overheating protection.
  - Easy to clean and hygienic.
  - Stainless steel body



GAZLI TEKLİ EKONOMİK FRİTÖZ

GAZLI ÇİFTLİ EKONOMİK FRİTÖZ

GAS SINGLE ECONOMIC FRYER

GAS DOUBLE ECONOMIC FRYER

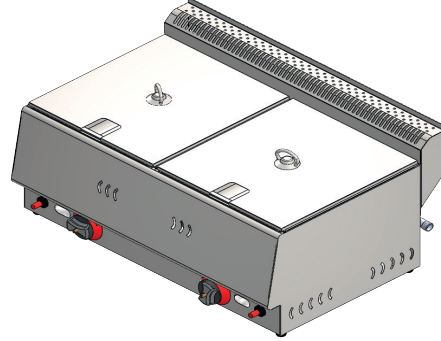
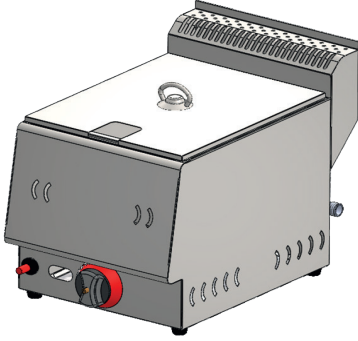

	KOD CODE	KRCS.EFGL.5
	H	270x430x350
	L	5 lt
	CE	2422-GAR-7115/11
	🔥	3.13 KW 30 mbar
	🔥	EFGL.5 (LPG)
	KG	7 kg
📦	280x530x405 🚚 € 150	

	KOD CODE	KRCS.EFGL.55
	H	540x430x350
	L	5+5 lt
	CE	2422-GAR-7115/11
	🔥	6.27 KW 30 mbar
	🔥	EFGL.55 (LPG)
	KG	10 kg
📦	550x585x405 🚚 € 250	

	KOD CODE	KRCS.EFGL.8
	H	350x430x350
	L	8 lt
	CE	2422-GAR-7115/11
	🔥	3.13 KW 30 mbar
	🔥	EFGL.8 (LPG)
	KG	8 kg
📦	360x600x405 🚚 € 175	

	KOD CODE	KRCS.EFGL.88
	H	700x430x350
	L	8+8 lt
	CE	2422-GAR-7115/11
	🔥	6.27 KW 30 mbar
	🔥	EFGL.88 (LPG)
	KG	14,5 kg
📦	710x575x405 🚚 € 288	

- Lpg ve Ng ile çalışabilme özelliği.
- Magnet emniyet ventilli musluklar.
- Paslanmaz çelik sepetler.
- Tahliye musluğu ile emniyetli yağ boşaltma.
- Limit termostat.
- Kolay temizlenebilir ve hijyeniktir.
- Paslanmaz çelik gövde.

- Lpg or Natural Gas.
- Magnet safety valves.
- Stainless steel baskets.
- Front oil drainage valve.
- Safety thermostat for overheating protection.
- Easy to clean and hygienic.
- Stainless steel body

- Lpg ve Ng ile çalışabilme özelliği.
- Magnet emniyet ventilli musluklar.
- Paslanmaz çelik sepetler.
- Tahliye musluğu ile emniyetli yağ boşaltma.
- Limit termostat.
- Kolay temizlenebilir ve hijyeniktir.
- Paslanmaz çelik gövde.

- Lpg or Natural Gas.
- Magnet safety valves.
- Stainless steel baskets.
- Front oil drainage valve.
- Safety thermostat for overheating protection.
- Easy to clean and hygienic.
- Stainless steel body

GAZLI EKONOMİK OCAK

GAS ECONOMIC FURNACE



GAZLI EKONOMİK OCAK

GAS ECONOMIC FURNACE

	KOD CODE	KRCS.EOG.3	
		800x290x180	
		3 ADET	
		2422-GAR-7115/29	
		12.09 KW 20 mbar	
		EOG.3 (NG)	
		14,5 kg	
		820x370x190	

	KOD CODE	KRCS.EOG.1	
		250x290x180	
		1 ADET	
		2422-GAR-7115/29	
		4.03 KW 20 mbar	
		EOG.1 (NG)	
		5 kg	
		380x370x190	

	KOD CODE	KRCS.EOG.4	
		600x600x180	
		4 ADET	
		2422-GAR-7115/29	
		16.12 KW 20 mbar	
		EOG.4 (NG)	
		21 kg	
		630x700x190	

	KOD CODE	KRCS.EOG.2	
		600x290x180	
		2 ADET	
		2422-GAR-7115/29	
		8.06 KW 20 mbar	
		EOG.2 (NG)	
		10,5 kg	
		610x370x190	

	KOD CODE	KRCS.EOG.6	
		900x600x180	
		6 ADET	
		2422-GAR-7115/29	
		24.18 KW 20 mbar	
		EOG.6 (NG)	
		26 kg	
		910x610x190	

- Lpg ve Ng ile çalışabilme özelliği.
- Magnet emniyet ventilli musluklar.
- Özel emaye kaplı güçlü ızgara.
- Kademeli şalter.
- Çift yanışlı brülör.
- Her brülör için piezzo çakmak ile kontrol.
- Kolay temizlenebilir ve hijyeniktir.
- Paslanmaz çelik gövde.

- Lpg or Natural Gas.
- Magnet safety valves.
- Solid enamelled cast iron.
- Positioned switch.
- Double ring burner.
- Piezo electric ignition system for each module.
- Easy to clean and hygienic.
- Stainless steel body.

- Lpg ve Ng ile çalışabilme özelliği.
- Magnet emniyet ventilli musluklar.
- Özel emaye kaplı güçlü ızgara.
- Kademeli şalter.
- Çift yanışlı brülör.
- Her brülör için piezzo çakmak ile kontrol.
- Kolay temizlenebilir ve hijyeniktir.
- Paslanmaz çelik gövde.

- Lpg or Natural Gas.
- Magnet safety valves.
- Solid enamelled cast iron.
- Positioned switch.
- Double ring burner.
- Piezo electric ignition system for each module.
- Easy to clean and hygienic.
- Stainless steel body.



GAZLI EKONOMİK OCAK

GAZLI EKONOMİK OCAK

GAS ECONOMIC FURNACE

GAS ECONOMIC FURNACE



KOD CODE	KRCS.EOGL.3
H	800x290x180
	3 ADET
	2422-GAR-7115/29
	7.43 KW 30 mbar
	EOGL.3 (LPG)
	14,5 kg
	820x370x190
	€ 338

KOD CODE	KRCS.EOGL.1
H	250x290x180
	1 ADET
	2422-GAR-7115/29
	2.48 KW 30 mbar
	EOGL.1 (LPG)
	5 kg
	380x370x190
	€ 150

KOD CODE	KRCS.EOGL.4
H	600x600x180
	4 ADET
	2422-GAR-7115/29
	9.91 KW 30 mbar
	EOGL.4 (LPG)
	21 kg
	630x700x190
	€ 425

KOD CODE	KRCS.EOGL.2
H	600x290x180
	2 ADET
	2422-GAR-7115/29
	4.96 KW 30 mbar
	EOGL.2 (LPG)
	10,5 kg
	610x370x190
	€ 238

KOD CODE	KRCS.EOGL.6
H	900x600x180
	6 ADET
	2422-GAR-7115/29
	14.87 KW 30 mbar
	EOGL.6 (LPG)
	26 kg
	910x610x190
	€ 600

- Lpg ve Ng ile çalışabilme özelliği.
- Magnet emniyet ventilli musluklar.
- Özel emaye kaplı güçlü ızgara.
- Kademeli şalter.
- Çift yanışlı brülör.
- Her brülör için piezzo çakmak ile kontrol.
- Kolay temizlenebilir ve hijyeniktir.
- Paslanmaz çelik gövde.

- Lpg or Natural Gas.
- Magnet safety valves.
- Solid enamelled cast iron.
- Positioned switch.
- Double ring burner.
- Piezo electric ignition system for each module.
- Easy to clean and hygienic.
- Stainless steel body.

- Lpg ve Ng ile çalışabilme özelliği.
- Magnet emniyet ventilli musluklar.
- Özel emaye kaplı güçlü ızgara.
- Kademeli şalter.
- Çift yanışlı brülör.
- Her brülör için piezzo çakmak ile kontrol.
- Kolay temizlenebilir ve hijyeniktir.
- Paslanmaz çelik gövde.

- Lpg or Natural Gas.
- Magnet safety valves.
- Solid enamelled cast iron.
- Positioned switch.
- Double ring burner.
- Piezo electric ignition system for each module.
- Easy to clean and hygienic.
- Stainless steel body.



🇹🇷 ELEKTRİKLİ TOST MAKİNESİ

🇬🇧 ELECTRIC TOASTER



	KOD CODE	KRC.S.TME.8	
	H L	330x380x220	
		8 DİLİM	
		220V-50Hz / 1.3 KW	
		18 kg	
	395x345x280		€ 163

🇹🇷 ELEKTRİKLİ TOST MAKİNESİ

🇬🇧 ELECTRIC TOASTER



	KOD CODE	KRC.S.TME.20	
	H L	500x380x260	
		20 DİLİM	
		220V-50Hz / 2.5 KW	
		26,5 kg	
	520x470x280		€ 225

	KOD CODE	KRC.S.TME.12	
	H L	410x390x265	
		12 DİLİM	
		220V-50Hz / 1.8 KW	
		22,5 kg	
	450x450x260		€ 190

	KOD CODE	KRC.S.YTME.12	
	H L	400x400x250	
		12 DİLİM	
		220V-50Hz / 1.8KW	
		22,5 kg	
	450x450x260		€ 288

	KOD CODE	KRC.S.TME88	
	H L	645x365x300	
		8+8 DİLİM	
		220V-50Hz / 2X1.3 KW	
		35 kg	
	670x400x320		€ 350



- Izgara olarak kullanabilme özelliği.
- Hijyenik ve emniyetli.
- Paslanmaz çelik gövde.



- Capable for operation as a grill.
- Hygienic and safe.
- Stainless steel body.



- Izgara olarak kullanabilme özelliği.
- Hijyenik ve emniyetli.
- Paslanmaz çelik gövde.



- Capable for operation as a grill.
- Hygienic and safe.
- Stainless steel body.



# FS FRIGO

KAFETERYA GRUBU

CAFETERIA GROUP

GAZLI TOST MAKİNESİ

GAZLI TOST MAKİNESİ

GAS TOASTERS

GAS TOASTERS



	KOD CODE	KRCS.TMG.12
		410x410x240
		12 DİLİM
		2422-GAR-7115/07
		7.02 KW 20 mbar
		TMG.12 (NG)
		23 kg
	450x450x260	
	€ 238	

	KOD CODE	KRCS.TMG.20
		515x440x260
		20 DİLİM
		2422-GAR-7115/07
		7.02 KW 20 mbar
		TMG.20 (NG)
		26,5 kg
	520x470x280	
	€ 275	

	KOD CODE	KRCS.TMGL.12
		410x410x240
		12 DİLİM
		2422-GAR-7115/07
		6.27 KW 30 mbar
		TMGL.12 (LPG)
		23 kg
	450x450x260	
	€ 238	

	KOD CODE	KRCS.TMGL.20
		515x440x260
		20 DİLİM
		2422-GAR-7115/07
		6.27 KW 30 mbar
		TMGL.20 (LPG)
		26,5 kg
	520x470x280	
	€ 275	



- Paslanmaz çelik taşıyıcı tel.
- Kolay temizlenebilen ve hijyeniktir.
- Paslanmaz çelik gövde.



- Stainless steel conveyor wire.
- Easy to clean and hygienic.
- Stainless steel body



- Paslanmaz çelik taşıyıcı tel.
- Kolay temizlenebilen ve hijyeniktir.
- Paslanmaz çelik gövde.



- Stainless steel conveyor wire.
- Easy to clean and hygienic.
- Stainless steel body

🇹🇷 ELEKTRİKLİ WAFFLE

🇬🇧 ELECTRIC WAFFLE



🇹🇷 ELEKTRİKLİ WAFFLE

🇬🇧 ELECTRIC WAFFLE



	<b>KOD CODE</b> KRCS.WMCE.1
	286x400x240
	Ø 20
	220V-50Hz / 1.3 KW
	18 kg
	340x390x210  € 225

	<b>KOD CODE</b> KRCS.WMCE.2
	555x400x240
	Ø 20 x 2
	220V-50Hz / 2.6 KW
	35 kg
	615x420x325  € 428

	<b>KOD CODE</b> KRCS.WMPE.1
	286x400x240
	Ø 20
	220V-50Hz / 1.6 KW
	18 kg
	340x390x285  € 228

	<b>KOD CODE</b> KRCS.WMPE.2
	555x400x240
	Ø 20 x 2
	220V-50Hz / 3.2 KW
	35 kg
	615x420x325  € 428

	<b>KOD CODE</b> KRCS.WMKE.1
	286x400x240
	Ø 20
	220V-50Hz / 1.3 KW
	18 kg
	340x390x285  € 225

	<b>KOD CODE</b> KRCS.WMKE.2
	555x400x240
	Ø 20 x 2
	220V-50Hz / 2.6 KW
	35 kg
	615x420x325  € 428

🇹🇷  
- Estetik ve fonksyonel tasarım.  
- Paslanmaz çelik gövde.

🇬🇧  
- Functionel design.  
- Stainless steel.

🇹🇷  
- Estetik ve fonksyonel tasarım.  
- Paslanmaz çelik gövde.

🇬🇧  
- Functionel design.  
- Stainless steel.



☐ ELEKTRİKLİ DÖKÜM IZGARA

☐ ELEKTRİKLİ DÖKÜM IZGARA

☐ ELECTRIC CASTING GRILL

☐ ELECTRIC CASTING GRILL



	KOD CODE	KRCS.EIZDE.30	
		300x400x200	
		1200cm	
		2422-GAD-1081/30	
		220V-50Hz / 1.3 KW	
		11,5 kg	
		320x580x210	€ 133

	KOD CODE	KRCS.EIZDE.70	
		700x400x200	
		2800cm <sup>2</sup>	
		2422-GAD-1081/30	
		220V-50Hz / 4.5 KW	
		37,5 kg	
		740x580x210	€ 275

	KOD CODE	KRCS.EIZDE.50	
		500x400x200	
		2000cm	
		2422-GAD-1081/30	
		220V-50Hz / 2.3 KW	
		20 kg	
		540x520x210	€ 233

- ☐
- Termostatik kontrol.
  - Tam modüllerde iki bölge ısıtma.
  - Çıkarılabilir yağ toplama haznesi.
  - Kolay temizlenebilir ve hijyeniktir.
  - Paslanmaz çelik gövde.

- ☐
- Thermostatic controller.
  - Two separate heating zones.
  - Removable oil collection drawer
  - Easy to clean and hygienic.
  - Stainless steel body.

- ☐
- Termostatik kontrol.
  - Tam modüllerde iki bölge ısıtma.
  - Çıkarılabilir yağ toplama haznesi.
  - Kolay temizlenebilir ve hijyeniktir.
  - Paslanmaz çelik gövde.

- ☐
- Thermostatic controller.
  - Two separate heating zones.
  - Removable oil collection drawer
  - Easy to clean and hygienic.
  - Stainless steel body.

GAZLI DÖKÜM IZGARA









GAS CASTING GRILL









GAZLI DÖKÜM IZGARA









GAS CASTING GRILL









	KOD CODE	KRCS.EIZDG.30	
	H L	300x400x200	
		1200cm <sup>2</sup>	
	CE	2422-GAR-7115/23	
		4.1 KW 20 mbar	
		EIZDG.30 (NG)	
		11 kg	
	320x580x210		€ 168

	KOD CODE	KRCS.EIZDGL.30	
	H L	300x400x200	
		1200cm <sup>2</sup>	
	CE	2422-GAR-7115/23	
		2.5 KW 30 mbar	
		EIZDGL.30 (NG)	
		11 kg	
	320x580x210		€ 168

	KOD CODE	KRCS.EIZDG.50	
	H L	500x400x200	
		2000cm <sup>2</sup>	
	CE	2422-GAR-7115/23	
		4.1 KW 20 mbar	
		EIZDG.50 (NG)	
		18 kg	
	540x520x210		€ 255

	KOD CODE	KRCS.EIZDGL.50	
	H L	500x400x200	
		2000cm <sup>2</sup>	
	CE	2422-GAR-7115/23	
		2.5 KW 30 mbar	
		EIZDGL.50 (NG)	
		18 kg	
	540x520x210		€ 255

	KOD CODE	KRCS.EIZDG.70	
	H L	700x400x200	
		2800cm <sup>2</sup>	
	CE	2422-GAR-7115/23	
		4.1 KW 20 mbar	
		EIZDG.70 (NG)	
		28 kg	
	740x580x210		€ 350

	KOD CODE	KRCS.EIZDGL.70	
	H L	700x400x200	
		2800cm <sup>2</sup>	
	CE	2422-GAR-7115/23	
		2.5 KW 30 mbar	
		EIZDGL.70 (NG)	
		28 kg	
	740x580x210		€ 350

- 
  - Lpg ve Ng ile çalışabilme özelliği.
  - Magnet emniyet ventilli ve pilotlu musluklar.
  - Tam modüllerde iki bölge pişirme.
  - Her brulör için piezzo çakmak ile kontrol.
  - Çıkarılabilir yağ toplama haznesi.
  - Kolay temizlenebilir ve hijyeniktir.
  - Paslanmaz çelik gövde.

- 
  - Lpg or Natural Gas.
  - Magnet safety valves with pilot.
  - Two separate heating zones.
  - Piezoelectric ignition system for each module.
  - Removable oil collection drawer.
  - Easy to clean and hygienic.
  - Stainless steel body.

- 
  - Lpg ve Ng ile çalışabilme özelliği.
  - Magnet emniyet ventilli ve pilotlu musluklar.
  - Tam modüllerde iki bölge pişirme.
  - Her brulör için piezzo çakmak ile kontrol.
  - Çıkarılabilir yağ toplama haznesi.
  - Kolay temizlenebilir ve hijyeniktir.
  - Paslanmaz çelik gövde.

- 
  - Lpg or Natural Gas.
  - Magnet safety valves with pilot.
  - Two separate heating zones.
  - Piezoelectric ignition system for each module.
  - Removable oil collection drawer.
  - Easy to clean and hygienic.
  - Stainless steel body.





☐ ELEKTRİKLİ DÜZ PLEYT IZGARA

☐ ELEKTRİKLİ DÜZ PLEYT IZGARA

☐ ELECTRIC FLAT PLATE GRILL

☐ ELECTRIC FLAT PLATE GRILL



	KOD CODE	KRCS.EIZPE.30	
		300x400x200	
		1200cm	
		2422-GAD-1081/30	
		220V-50Hz / 1.3 KW	
		10 kg	
	320x580x210		€ 125

	KOD CODE	KRCS.EIZPE.70	
		700x400x200	
		2800cm	
		2422-GAD-1081/30	
		220V-50Hz / 4.5 KW	
		23 kg	
	740x580x210		€ 213

	KOD CODE	KRCS.EIZPE.50	
		500x400x200	
		2000cm	
		2422-GAD-1081/30	
		220V-50Hz / 2.3 KW	
		16 kg	
	540x520x210		€ 163

- ☐
- Termostatik kontrol.
  - Tam modüllerde iki bölge ısıtma.
  - Çıkarılabilir yağ toplama haznesi.
  - Kolay temizlenebilir ve hijyeniktir.
  - Paslanmaz çelik gövde.

- ☐
- Thermostatic controller.
  - Two separate heating zones.
  - Removable oil collection drawer
  - Easy to clean and hygienic.
  - Stainless steel body.

- ☐
- Termostatik kontrol.
  - Tam modüllerde iki bölge ısıtma.
  - Çıkarılabilir yağ toplama haznesi.
  - Kolay temizlenebilir ve hijyeniktir.
  - Paslanmaz çelik gövde.

- ☐
- Thermostatic controller.
  - Two separate heating zones.
  - Removable oil collection drawer
  - Easy to clean and hygienic.
  - Stainless steel body.

GAZLI DÜZ PLEYT IZGARA











GAS FLAT PLATE GRILL











GAZLI DÜZ PLEYT IZGARA











GAS FLAT PLATE GRILL











	KOD CODE	KRCS.EIZPG.30	
		300x400x200	
		1200cm <sup>2</sup>	
		2422-GAR-7115/23	
		4.1 KW 20 mbar	
		EIZPG.30 (NG)	
		10 kg	
		320x580x210  € 163	

	KOD CODE	KRCS.EIZPGL.30	
		300x400x200	
		1200cm <sup>2</sup>	
		2422-GAR-7115/23	
		2.5 KW 30 mbar	
		EIZPGL.30 (LPG)	
		10 kg	
		320x580x210  € 163	

	KOD CODE	KRCS.EIZPG.50	
		500x400x200	
		2000cm <sup>2</sup>	
		2422-GAR-7115/23	
		4.1 KW 20 mbar	
		EIZPG.50 (NG)	
		15 kg	
		540x520x210  € 213	

	KOD CODE	KRCS.EIZPGL.50	
		500x400x200	
		2000cm <sup>2</sup>	
		2422-GAR-7115/23	
		2.5 KW 30 mbar	
		EIZPGL.50 (LPG)	
		15 kg	
		540x520x210  € 213	

	KOD CODE	KRCS.EIZPG.70	
		700x400x200	
		2800cm <sup>2</sup>	
		2422-GAR-7115/23	
		4.1 KW 20 mbar	
		EIZPG.70 (NG)	
		22 kg	
		740x580x210  € 283	

	KOD CODE	KRCS.EIZPGL.70	
		700x400x200	
		2800cm <sup>2</sup>	
		2422-GAR-7115/23	
		2.5 KW 30 mbar	
		EIZPGL.70 (LPG)	
		22 kg	
		740x580x210  € 283	

- Lpg ve Ng ile çalışabilme özelliği.
- Magnet emniyet ventilli ve pilotlu musluklar.
- Tam modüllerde iki bölge pişirme.
- Her brülör için piezzo çakmak ile kontrol.
- Çıkarılabilir yağ toplama haznesi.
- Kolay temizlenebilir ve hijyeniktir.
- Paslanmaz çelik gövde.

- Lpg or Natural Gas.
- Magnet safety valves with pilot.
- Two separate heating zones.
- Piezoelectric ignition system for each module.
- Removable oil collection drawer.
- Easy to clean and hygienic.
- Stainless steel body.

- Lpg ve Ng ile çalışabilme özelliği.
- Magnet emniyet ventilli ve pilotlu musluklar.
- Tam modüllerde iki bölge pişirme.
- Her brülör için piezzo çakmak ile kontrol.
- Çıkarılabilir yağ toplama haznesi.
- Kolay temizlenebilir ve hijyeniktir.
- Paslanmaz çelik gövde.

- Lpg or Natural Gas.
- Magnet safety valves with pilot.
- Two separate heating zones.
- Piezoelectric ignition system for each module.
- Removable oil collection drawer.
- Easy to clean and hygienic.
- Stainless steel body.



🇹🇷 ELEKTRİKLİ KREP VE PANCAKE

🇹🇷 ELEKTRİKLİ KREP VE PANCAKE

🇬🇧 ELECTRIC CREPE AND PANCAKE

🇬🇧 ELECTRIC CREPE AND PANCAKE



	KOD CODE	KRCS.FKRPE.1
	H	400x400x150
	⚡	220V 50Hz / 2.2 KW
	Ø	1 ADET
	KG	15 kg
	📦	470x520x280 🚚 € 300

	KOD CODE	KRCS.PNKE
	H	40x40x20
	⚡	220V 50Hz / 2.5 KW
	Ø	14 KAP
	KG	18,5 kg
	📦	470x510x280 🚚 € 275

- 🇹🇷
- 220 V 50 Hz. enerji.
  - Estetik ve fonksyonel tasarım.
  - Paslanmaz çelik gövde.

- 🇬🇧
- 220 V 50 Hz. energy.
  - Functionel design.
  - Stainlees steel body

- 🇹🇷
- 220 V 50 Hz. enerji.
  - Estetik ve fonksyonel tasarım.
  - Paslanmaz çelik gövde.

- 🇬🇧
- 220 V 50 Hz. energy.
  - Functionel design.
  - Stainlees steel body

GAZLI KREP VE PANCAKE

GAZLI KREP VE PANCAKE

GASO CREPE AND PANCAKE

GASO CREPE AND PANCAKE



	<b>KOD CODE</b> KRCS.FKRP.G.1
	400x400x150
	2422-GAR-7115/09
	4.03 KW 20 mbar
	15 kg
	470x520x280
	€ 313
	

	<b>KOD CODE</b> KRCS.PNKG
	40x40x20
	14 KAP
	2422-GAR-7115/09
	4.03 KW 20 mbar
	18 kg
	470x520x280
	€ 275

	<b>KOD CODE</b> KRCS.FKRPGL.1
	400x400x150
	2422-GAR-7115/09
	3.13 KW 30 mbar
	15 kg
	470x520x280
	€ 313
	

	<b>KOD CODE</b> KRCS.PNKGL
	40x40x20
	14 KAP
	2422-GAR-7115/09
	3.13 KW 30 mbar
	18 kg
	470x520x280
	€ 275

GAZLI KREP VE PANCAKE  
- Estetik ve fonksyonel tasarımı.  
- Paslanmaz çelik gövde.

GASO CREPE AND PANCAKE  
- Functionel design.  
- Stainless steel body.

GAZLI KREP VE PANCAKE  
- Estetik ve fonksyonel tasarımı.  
- Paslanmaz çelik gövde.

GASO CREPE AND PANCAKE  
- Functionel design.  
- Stainless steel body.



🇹🇷 ELEKTRİKLİ KREP

🇬🇧 ELECTRIC CREPE



🇹🇷 ELEKTRİKLİ KREP

🇬🇧 ELECTRIC CREPE



	KOD CODE	KRCS.KRPE.1
		360x460x150
		220V 50Hz / 2.2 KW
		1 ADET
		15 kg
		470x510x280

	KOD CODE	KRCS.KRPE.2
		750x460x150
		220V 50Hz / 4.4 KW
		2 ADET
		30 kg
		920x580x280

- 🇹🇷
- 220 V 50 Hz. enerji.
  - Estetik ve fonksyonel tasarım.
  - Paslanmaz çelik gövde.

- 🇬🇧
- 220 V 50 Hz. energy.
  - Functionel design.
  - Stainless steel body

- 🇹🇷
- 220 V 50 Hz. enerji.
  - Estetik ve fonksyonel tasarım.
  - Paslanmaz çelik gövde.

- 🇬🇧
- 220 V 50 Hz. energy.
  - Functionel design.
  - Stainless steel body



GAZLI KREP

GAZLI KREP

GASO CREPE

GASO CREPE



	KOD CODE	KRC.S.KRPG.1	
	H L	360x460x150	
	CE	2422-GAR-7115/09	
		4.03 KW 20mbar	
		15 kg	
	470x510x280		€ 218

	KOD CODE	KRC.S.KRPG.2	
	H L	750x460x150	
	CE	2422-GAR-7115/09	
		8.06 KW 20mbar	
		30 kg	
	920x580x280		€ 400

	KOD CODE	KRC.S.KRPL.1	
	H L	360x460x150	
	CE	2422-GAR-7115/09	
		3.13 KW 30mbar	
		15 kg	
	470x510x280		€ 218

	KOD CODE	KRC.S.KRPL.2	
	H L	750x460x150	
	CE	2422-GAR-7115/09	
		6.27 KW 30mbar	
		30 kg	
	920x580x280		€ 400

GAZLI KREP  
- Estetik ve fonksyonel tasarımı.  
- Paslanmaz çelik gövde.

GASO CREPE  
- Fonctionel design.  
- Stainless steel body.

GAZLI KREP  
- Estetik ve fonksyonel tasarımı.  
- Paslanmaz çelik gövde.

GASO CREPE  
- Fonctionel design.  
- Stainless steel body.



🇹🇷 ELEKTRİKLİ ÇAY MAKİNESİ

🇬🇧 ELECTRIC TEA MAKER



	KOD CODE	KRC.S.COM.40
		40 bardak / 5 lt
		220V 50Hz / 1 KW
		2.5 kg
		265x275x280  € 85

🇹🇷 ELEKTRİKLİ ÇAY MAKİNESİ

🇬🇧 ELECTRIC TEA MAKER



	KOD CODE	KRC.S.COM.60
		60 bardak / 7 lt
		220V 50Hz / 1.5 KW
		3 kg
		285x295x400  € 90

	KOD CODE	KRC.S.COM.80
		80 bardak / 9 lt
		220V 50Hz / 1.5 KW
		17 kg
		300x305x415  € 100

	KOD CODE	KRC.S.COM.120
		120 bardak / 12 lt
		220V 50Hz / 2 KW
		17 kg
		325x340x445  € 113



- Suyu kaynatan, paslanmayan şok tüp rezistans ile donatılmıştır.
- Özel model muslukları ile ergonomik kullanım sağlar.
- Avrupa birliği normlarına göre üretilmektedir.
- CE belgesine sahiptir.



- Boiling water, non-rusting equipped with shock tube resistor.
- Ergonomic with special model taps provides usage.
- According to European Union norms is produced.
- It has CE certificate.



- Suyu kaynatan, paslanmayan şok tüp rezistans ile donatılmıştır.
- Özel model muslukları ile ergonomik kullanım sağlar.
- Avrupa birliği normlarına göre üretilmektedir.
- CE belgesine sahiptir.



- Boiling water, non-rusting equipped with shock tube resistor.
- Ergonomic with special model taps provides usage.
- According to European Union norms is produced.
- It has CE certificate.

🇹🇷 ELEKTRİKLİ ÇAY MAKİNESİ

🇬🇧 ELECTRIC TEA MAKER



🇹🇷 ELEKTRİKLİ ÇAY MAKİNESİ

🇬🇧 ELECTRIC TEA MAKER



KOD CODE		KRCS.COM 160
	40 bardak / 15 lt	
	220V 50Hz / 2 KW	
	17 kg	
	340x350x470	€ 123

KOD CODE		KRCS.COM 250
	40 bardak / 22 lt	
	220V 50Hz / 2.2 KW	
	17 kg	
	390x390x530	€ 135

KOD CODE		KRCS.COM 350
	350 bardak / 36 lt	
	220V 50Hz / 3 KW	
	17 kg	
	340x340x470	€ 315

KOD CODE		KRCS.COM 500
	500 bardak / 50 lt	
	220V 50Hz / 3 KW	
	17 kg	
	390x390x530	€ 413



- Suyu kaynatan, paslanmayan şok tüp rezistans ile donatılmıştır.
- Özel model muslukları ile ergonomik kullanım sağlar.
- Avrupa birliği normlarına göre üretilmektedir.
- CE belgesine sahiptir.



- Boiling water, non-rusting equipped with shock tube resistor.
- Ergonomic with special model taps provides usage.
- According to European Union norms is produced.
- It has CE certificate.



- Suyu kaynatan, paslanmayan şok tüp rezistans ile donatılmıştır.
- Özel model muslukları ile ergonomik kullanım sağlar.
- Avrupa birliği normlarına göre üretilmektedir.
- CE belgesine sahiptir.



- Boiling water, non-rusting equipped with shock tube resistor.
- Ergonomic with special model taps provides usage.
- According to European Union norms is produced.
- It has CE certificate.

ÇORBA MAKİNASI

SOUP MACHINE



ÇORBA MAKİNASI

SOUP MACHINE



	KOD CODE	KRCS.CM.01
	H L   ϕ	
	⚡	220V - 50Hz / 1 KW
	⊙	8 lt
	KG	
		€ 303

	KOD CODE	KRCS.CM.02
	H L   ϕ	
	⚡	220V - 50Hz / 1KW
	⊙	12 lt
	KG	
		€ 345

- Çıkarılabilir paslanmaz çelik iç hazne.  
- Hijyenik ve emniyetli kullanım.

- Removable stainless steel reservoir.  
- Hygienic and safely usage.

- Çıkarılabilir paslanmaz çelik iç hazne.  
- Hijyenik ve emniyetli kullanım.

- Removable stainless steel reservoir.  
- Hygienic and safely usage.

ŞERBET-AYRAN MAKİNESİ

ŞERBET-AYRAN MAKİNESİ

SHERBET - AYRAN MACHINE

SHERBET - AYRAN MACHINE



	KOD CODE	10 LT SERBET-AYRAN
	H L	
	⚡	220V - 50Hz / 0.37 KW
	⚙️	80 kg/h
	KG	5 kg
	📦	€ 888

	KOD CODE	20 LT SERBET-AYRAN
	H L	
	⚡	220V - 50Hz
	⚙️	11000 dev/dk
	KG	
	📦	€ 938

	KOD CODE	10+10 LT SERBET-AYRAN
	H L	
	⚡	220V - 50Hz / 0.37 KW
	⚙️	80 kg/h
	KG	5 kg
	📦	€ 1563

	KOD CODE	20+20 LT SERBET-AYRAN
	H L	
	⚡	220V - 50Hz
	⚙️	11000 dev/dk
	KG	
	📦	€ 1675

ŞERBET-AYRAN MAKİNESİ

- Geniş musluk hortumu.
- Düşük çalışma ses seviyesi.
- Hazne kapağının düz formu sayesinde bardaklık olarak kullanabilme imkanı.
- İçecek ile temas eden tüm parçalar kolaylık çıkarılabilir ve temizlenebilir.

SHERBET - AYRAN MACHINE

- The low noise level of the class.
- Possibility to use the cup holder thanks to the flat form of the hopper cover.
- All parts in contact with the beverage removable and can be cleaned with ease.

ŞERBET-AYRAN MAKİNESİ

- Geniş musluk hortumu.
- Düşük çalışma ses seviyesi.
- Hazne kapağının düz formu sayesinde bardaklık olarak kullanabilme imkanı.
- İçecek ile temas eden tüm parçalar kolaylık çıkarılabilir ve temizlenebilir.

SHERBET - AYRAN MACHINE

- The low noise level of the class.
- Possibility to use the cup holder thanks to the flat form of the hopper cover.
- All parts in contact with the beverage removable and can be cleaned with ease.



☐ KUMDA KAHVE MAKİNASI

☐ SAND COFFEE MACHINE



	KOD CODE	KRCS.KKME 1
		Kumda kahve
		3 cezve
	⚡	220V 50Hz / 1 KW
	⚖	2.5 kg
	📏	435x445x265 🚚 € 205

☐ KUMDA KAHVE MAKİNASI

☐ SAND COFFEE MACHINE



	KOD CODE	KRCS.KKME 2
		Kumda kahve
		3+3 cezve
	⚡	220V 50Hz / 2 KW
	⚖	2.5 kg
	📏	870x445x265 🚚 € 413

	KOD CODE	KRCS.SKMK
	H L	100x70x220
		Közde kahve
	🔥	
	⚖	17 kg
	📏	110x80x160 🚚 € 1738

	KOD CODE	KRCS.SKKME 80
	H L	100x70x220
		Kumda kahve 3 cezve
	🔥	220V 50Hz / 1 KW
	⚖	17 kg
	📏	110x80x160 🚚 € 1738

☐  
- Bakır Gövde.

☐  
- Cooper Covered Body

☐  
- Bakır Gövde.

☐  
- Cooper Covered Body.





ELEKTRİKLİ SALAMANDER



ELECTRIC SALAMANDER



	<b>KOD CODE</b>	<b>KRCS.SIE.2</b>
	<b>H</b>	600x700x550
	<b>HC</b>	2 ADET
		220V 50Hz / 3 KW
	<b>KG</b>	24.5 kg
		710x470x510  € <b>425</b>

	<b>KOD CODE</b>	<b>KRCS.HSIE.2</b>
	<b>H</b>	600x700x550
	<b>HC</b>	2 ADET
		220V 50Hz / 3 KW
	<b>KG</b>	17 kg
		650x610x600  € <b>870</b>



- Termostatik kumanda.
- Isıtma sistemi yukarı ve aşağıya yakınlaştırılabilir.
- Kolay temizlenebilir ve hijyeniktir.
- Paslanmaz çelik gövde.



- Thermostatic controller.
- Slides can be adjusted on a different height.
- Easy to clean and hygienic.
- Stainless steel body



- Termostatik kumanda.
- Isıtma sistemi yukarı ve aşağıya yakınlaştırılabilir.
- Kolay temizlenebilir ve hijyeniktir.
- Paslanmaz çelik gövde.



- Thermostatic controller.
- Slides can be adjusted on a different height.
- Easy to clean and hygienic.
- Stainless steel body



 GAZLI SALAMANDER

 GAZLI SALAMANDER

 GAS SALAMANDER

 GAS SALAMANDER





	<b>KOD CODE</b> KRCS.SIG.2
	600x700x550
	2
	2422-GAR-7115/13
	7.02 KW 20 mbar
	26 kg
	610x550x630  € 488

	<b>KOD CODE</b> KRCS.SIG.3
	800x700x550
	3 ADET
	2422-GAR-7115/13
	10.53 KW 20 mbar
	30 kg
	810x570x600  € 563

	<b>KOD CODE</b> KRCS.SIGL.2
	600x700x550
	2
	2422-GAR-7115/13
	6.27 KW 30 mbar
	26 kg
	610x550x630  € 488

	<b>KOD CODE</b> KRCS.SIGL.3
	800x700x550
	3 ADET
	2422-GAR-7115/13
	9.41 KW 30 mbar
	30 kg
	810x570x600  € 563

- 
- Termostatik kumanda.
  - Isıtma sistemi yukarı ve aşağıya yakınlaştırılabilir.
  - Kolay temizlenebilir ve hijyeniktir.
  - Paslanmaz çelik gövde.

- 
- Thermostatic controller.
  - Slides can be adjusted on a different height.
  - Easy to clean and hygienic.
  - Stainless steel body

- 
- Termostatik kumanda.
  - Isıtma sistemi yukarı ve aşağıya yakınlaştırılabilir.
  - Kolay temizlenebilir ve hijyeniktir.
  - Paslanmaz çelik gövde.

- 
- Thermostatic controller.
  - Slides can be adjusted on a different height.
  - Easy to clean and hygienic.
  - Stainless steel body

🇹🇷 ELEKTRİKLİ DÖNER OCAĞI

🇹🇷 ELEKTRİKLİ DÖNER OCAĞI

🇬🇧 ELECTRIC DONER FURNACE

🇬🇧 ELECTRIC DONER FURNACE



	<b>KOD CODE</b>	<b>KRCS.DOE.2</b>
	<b>H</b>	530x785x628
	<b>2 ADET RADYAN</b>	
	<b>380V-50Hz / 3 KW</b>	
	<b>21 kg</b>	
	<b>550x340x635</b>	€ <b>463</b>

	<b>KOD CODE</b>	<b>KRCS.DOE.4</b>
	<b>H</b>	530x785x1050
	<b>4 ADET RADYAN</b>	
	<b>380V-50Hz / 6 KW</b>	
	<b>29.5 kg</b>	
	<b>550x340x1100</b>	€ <b>620</b>

	<b>KOD CODE</b>	<b>KRCS.DOE.3</b>
	<b>H</b>	530x785x805
	<b>3 ADET RADYAN</b>	
	<b>380V-50Hz / 4,5 KW</b>	
	<b>26 kg</b>	
	<b>550x340x810</b>	€ <b>540</b>

	<b>KOD CODE</b>	<b>KRCS.DOE.5</b>
	<b>H</b>	530x785x1220
	<b>5 ADET RADYAN</b>	
	<b>380V-50Hz / 7.5 KW</b>	
	<b>33.5 kg</b>	
	<b>550x340x1223</b>	€ <b>708</b>



- Ayarlanabilir döner şişi.
- Çift yöne dönebilme özelliği.
- Hijyenik ve emniyetli.
- Paslanmaz çelik gövde.



- Adjustable spear
- Dual direction option.
- Hygienic and safe.
- Stainless steel body.



- Ayarlanabilir döner şişi.
- Çift yöne dönebilme özelliği.
- Hijyenik ve emniyetli.
- Paslanmaz çelik gövde.



- Adjustable spear
- Dual direction option.
- Hygienic and safe.
- Stainless steel body.



GAZLI DÖNER OCAĞI

GAS DONER FURNACE



	<b>KOD CODE</b>	<b>KRCS.SDOG.1</b>
		400x475x440
		1 ADET RADYAN
		2422-GAD-1081/32
		1.7 KW 20 mbar
		<b>SDOG.1 (NG)</b>
		9 kg
		420x500x450  € <b>238</b>

GAZLI DÖNER OCAĞI

GAS DONER FURNACE



	<b>KOD CODE</b>	<b>KRCS.SDOG.2</b>
		540x785x700
		2 ADET RADYAN
		2422-GAD-1081/32
		3,45 KW 20 mbar
		<b>SDOG.2 (NG)</b>
		20 kg
		550x330x705  € <b>395</b>

	<b>KOD CODE</b>	<b>KRCS.SDOGL.1</b>
		400x475x440
		1 ADET RADYAN
		2422-GAD-1081/32
		1.2 KW 30 mbar
		<b>SDOGL.1 (LPG)</b>
		9 kg
		420x500x450  € <b>238</b>

	<b>KOD CODE</b>	<b>KRCS.SDOGL.2</b>
		540x785x700
		2 ADET RADYAN
		2422-GAD-1081/32
		2.4 KW 30 mbar
		<b>SDOGL.1 (LPG)</b>
		20 kg
		550x330x705  € <b>395</b>

- Lpg veya doğalgazla çalışabilme imkanı.
- Magnet emniyet ventilli musluklar.
- Ayarlanabilir döner şişi.
- Çift yöne dönebilme özelliği.
- Hijyenik ve emniyetli.
- Paslanmaz çelik gövde.

- Lpg or naturel gas.
- Magnet safety valve.
- Adjustable spear.
- Dual direction option.
- Hygienic and safe.
- Stainless steel body.

- Lpg veya doğalgazla çalışabilme imkanı.
- Magnet emniyet ventilli musluklar.
- Ayarlanabilir döner şişi.
- Çift yöne dönebilme özelliği.
- Hijyenik ve emniyetli.
- Paslanmaz çelik gövde.

- Lpg or naturel gas.
- Magnet safety valve.
- Adjustable spear.
- Dual direction option.
- Hygienic and safe.
- Stainless steel body.

GAZLI DÖNER OCAĞI

GAS DONER FURNACE



KOD CODE	KRCS.SDOG.3
540x785x850	
3 ADET RADYAN	
2422-GAD-1081/32	
5,2 KW 20 mbar	
SDOG.3 (NG)	
28 kg	
550x330x900  € 475	

GAZLI DÖNER OCAĞI

GAS DONER FURNACE



KOD CODE	KRCS.SDOG.4
540x785x970	
4 ADET RADYAN	
2422-GAD-1081/32	
6,9 KW 20 mbar	
SDOG.4 (NG)	
32 kg	
550x330x980  € 563	

KOD CODE	KRCS.SDOGL.3
540x785x850	
3 ADET RADYAN	
2422-GAD-1081/32	
3.6 KW 30 mbar	
SDOGL.3 (LPG)	
28 kg	
550x330x900  € 475	

KOD CODE	KRCS.SDOGL.4
540x785x970	
4 ADET RADYAN	
2422-GAD-1081/32	
4.8 KW 30 mbar	
SDOGL.4 (LPG)	
32 kg	
550x330x980  € 563	

- Lpg veya doğalgazla çalışabilme imkanı.  
- Magnet emniyet ventilli musluklar.  
- Ayarlanabilir döner şişi.  
- Çift yöne dönebilme özelliği.  
- Hijyenik ve emniyetli.  
- Paslanmaz çelik gövde.

- Lpg or naturel gas.  
- Magnet safety valve.  
- Adjustable spear.  
- Dual direction option.  
- Hygienic and safe.  
- Stainless steel body.

- Lpg veya doğalgazla çalışabilme imkanı.  
- Magnet emniyet ventilli musluklar.  
- Ayarlanabilir döner şişi.  
- Çift yöne dönebilme özelliği.  
- Hijyenik ve emniyetli.  
- Paslanmaz çelik gövde.

- Lpg or naturel gas.  
- Magnet safety valve.  
- Adjustable spear.  
- Dual direction option.  
- Hygienic and safe.  
- Stainless steel body.



GAZLI DÖNER OCAĞI

GAZLI DÖNER OCAĞI

GAS DONER FURNACE

GAS DONER FURNACE

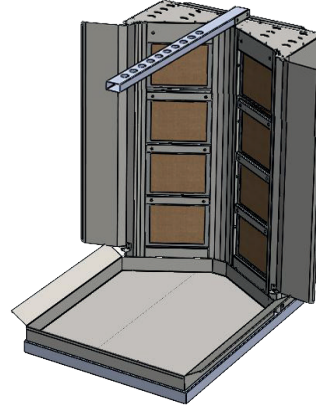

	<b>KOD CODE</b> KRCS.SDOG.5
	540x785x1140
	5 ADET RADYAN
	2422-GAD-1081/30
	8,6 KW 20 mbar
	SDOG.5 (NG)
	37 kg
	550x330x1150
	€ 650

	<b>KOD CODE</b> KRCS.SDOG.8
	660x785x970
	8 ADET RADYAN
	2422-GAD-1081/30
	13.8 KW 20 mbar
	SDOG.8 (NG)
	65 kg
	665x330x980
	€ 1438

	<b>KOD CODE</b> KRCS.SDOGL.5
	540x785x1140
	5 ADET RADYAN
	2422-GAD-1081/30
	6 KW 30 mbar
	SDOG.5 (LPG)
	37 kg
	550x330x1150
	€ 650

	<b>KOD CODE</b> KRCS.SDOGL.8
	660x785x970
	8 ADET RADYAN
	2422-GAD-1081/30
	9.6 KW 30 mbar
	SDOG.8 (LPG)
	65 kg
	665x330x980
	€ 1438



- Lpg veya doğalgazla çalışabilme imkanı.
- Magnet emniyet ventilli musluklar.
- Ayarlanabilir döner şişi.
- Çift yöne dönebilme özelliği.
- Hijyenik ve emniyetli.
- Paslanmaz çelik gövde.



- Lpg or naturel gas.
- Magnet safety valve.
- Adjustable spear.
- Dual direction option.
- Hygienic and safe.
- Stainless steel body.



- Lpg veya doğalgazla çalışabilme imkanı.
- Magnet emniyet ventilli musluklar.
- Ayarlanabilir döner şişi.
- Çift yöne dönebilme özelliği.
- Hijyenik ve emniyetli.
- Paslanmaz çelik gövde.



- Lpg or naturel gas.
- Magnet safety valve.
- Adjustable spear.
- Dual direction option.
- Hygienic and safe.
- Stainless steel body.



GAZLI DÖNER OCAĞI

GAS DONER FURNACE

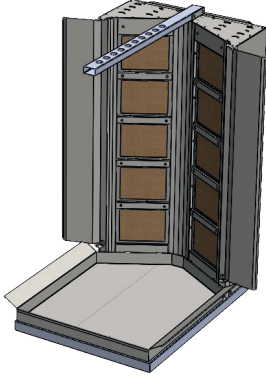

	<b>KOD CODE</b> KRCS.SDOG.10
	660x785x1140
	10 ADET RADYAN
	2422-GAD-1081/32
	17,5 KW 20 mbar
	SDOG.10 (NG)
	80 kg
	665x330x1150  € 1688

ÜSTTEN MOTORLU ELEKTRİKLİ DÖNER OCAĞI

ELECTRIC TOP MOTORIZED DONER FURNACE



	<b>KOD CODE</b> KRCS.UMDOE.2
	540x785x750
	2 ADET RADYAN
	380V-50Hz / 3 KW
	21 kg
	550x330x760  € 525

	<b>KOD CODE</b> KRCS.SDOGL.10
	660x785x1140
	10 ADET RADYAN
	2422-GAD-1081/32
	12 KW 30 mbar
	SDOGL.10 (LPG)
	80 kg
	665x330x1150  € 1688

	<b>KOD CODE</b> KRCS.UMDOE.3
	540x785x930
	3 ADET RADYAN
	380V-50Hz / 4,5 KW
	25 kg
	550x330x940  € 608

- 
- Lpg veya doğalgazla çalışabilme imkanı.
  - Magnet emniyet ventilli musluklar.
  - Ayarlanabilir döner şişi.
  - Çift yöne dönebilme özelliği.
  - Hijyenik ve emniyetli.
  - Paslanmaz çelik gövde.

- 
- Lpg or naturel gas.
  - Magnet safety valve.
  - Adjustable spear.
  - Dual direction option.
  - Hygienic and safe.
  - Stainless steel body.

- 
- Ayarlanabilir döner şişi.
  - Çift yöne dönebilme özelliği.
  - Hijyenik ve emniyetli.
  - Paslanmaz çelik gövde.

- 
- Adjustable spear
  - Dual direction option.
  - Hygienic and safe.
  - Stainless steel body.



ÜSTTEN MOTORLU ELEKTRİKLİ DÖNER OCAĞI

ÜSTTEN MOTORLU GAZLI DÖNER OCAĞI

ELECTRIC TOP MOTORIZED DONER FURNACE

GAS TOP MOTORIZED DONER FURNACE



	KOD CODE	KRCS.UMDOE.4
	H	540x785x1110
	HC	4 ADET RADYAN
	⚡	380V-50Hz / 6 KW
	KG	28.5 kg
	📦	550x330x1120 🚚 € 690

	KOD CODE	KRCS.UMSDOG.2
	H	540x785x896
	HC	2 ADET RADYAN
	CE	2422-GAD-1081/32
	🔥	5,2 KW 20 mbar
	🔥	UMSDOG.2 (NG)
	KG	19 kg
	📦	550x330x786 🚚 € 525

	KOD CODE	KRCS.UMDOE.5
	H	540x785x1300
	HC	5 ADET RADYAN
	⚡	380V-50Hz / 7,5 KW
	KG	33 kg
	📦	550x330x1310 🚚 € 765

	KOD CODE	KRCS.UMSDOGL.2
	H	540x785x886
	HC	2 ADET RADYAN
	CE	2422-GAD-1081/32
	🔥	2.4 KW 30 mbar
	🔥	UMSDOGL.2 (LPG)
	KG	19 kg
	📦	550x330x786 🚚 € 525



- Ayarlanabilir döner şişi.
- Çift yöne dönebilme özelliği.
- Hijyenik ve emniyetli.
- Paslanmaz çelik gövde.



- Adjustable spear
- Dual direction option.
- Hygienic and safe.
- Stainless steel body.



- Lpg veya doğalgazla çalışabilme imkanı.
- Magnet emniyet ventilli musluklar.
- Ayarlanabilir döner şişi.
- Çift yöne dönebilme özelliği.
- Hijyenik ve emniyetli.
- Paslanmaz çelik gövde.



- Lpg or naturel gas.
- Magnet safety valve.
- Adjustable spear.
- Dual direction option.
- Hygienic and safe.
- Stainless steel body.

ÜSTTEN MOTORLU GAZLI DÖNER OCAĞI

ÜSTTEN MOTORLU GAZLI DÖNER OCAĞI

GAS TOP MOTORIZED DONER FURNACE

GAS TOP MOTORIZED DONER FURNACE



	KOD CODE	KRCS.UMSDOG.3
	H L	540x785x910
		3 ADET RADYAN
		2422-GAD-1081/32
		5,2 KW 20 mbar
		UMSDOG.3 (LPG)
		23 kg
		550x330x900  € 613

	KOD CODE	KRCS.UMSDOG.4
	H L	540x785x1050
		4 ADET RADYAN
		2422-GAD-1081/32
		6,9 KW 20 mbar
		UMSDOG.4 (NG)
		26 kg
		550x330x950  € 688

	KOD CODE	KRCS.UMSDOGL.3
	H L	540x785x910
		3 ADET RADYAN
		2422-GAD-1081/32
		3.6 KW 30 mbar
		UMSDOGL.3 (LPG)
		23 kg
		550x330x900  € 613

	KOD CODE	KRCS.UMSDOGL.4
	H L	540x785x1050
		4 ADET RADYAN
		2422-GAD-1081/32
		4.8 KW 30 mbar
		UMSDOGL.4 (LPG)
		26 kg
		550x330x950  € 688

- Lpg veya doğalgazla çalışabilme imkanı.
  - Magnet emniyet ventilli musluklar.
  - Ayarlanabilir döner şişi.
  - Çift yöne dönebilme özelliği.
  - Hijyenik ve emniyetli.
  - Paslanmaz çelik gövde.

- Lpg or naturel gas.
  - Magnet safety valve.
  - Adjustable spear.
  - Dual direction option.
  - Hygienic and safe.
  - Stainless steel body.

- Lpg veya doğalgazla çalışabilme imkanı.
  - Magnet emniyet ventilli musluklar.
  - Ayarlanabilir döner şişi.
  - Çift yöne dönebilme özelliği.
  - Hijyenik ve emniyetli.
  - Paslanmaz çelik gövde.

- Lpg or naturel gas.
  - Magnet safety valve.
  - Adjustable spear.
  - Dual direction option.
  - Hygienic and safe.
  - Stainless steel body.



ÜSTTEN MOTORLU GAZLI DÖNER OCAĞI

ALTTAN MOTORLU ELEKTRİKLİ DÖNER OCAĞI

GAS TOP MOTORIZED DONER FURNACE

ELECTRIC BOTTOM MOTOR ROTARY FURNACE



	<b>KOD CODE</b> KRCS.UMSDOG.5
	540x785x1220
	5 ADET RADYAN
	2422-GAD-1081/32
	8,6 KW 20 mbar
	UMSDOG.5 (NG)
	31 kg
	550x330x1120  € 763

	<b>KOD CODE</b> KRCS.AMDOE.2
	540x785x760
	2 ADET RADYAN
	380V-50Hz / 3 KW
	33 kg
	550x790x770  € 688

	<b>KOD CODE</b> KRCS.UMSDOGL.5
	540x785x1220
	5 ADET RADYAN
	2422-GAD-1081/32
	6 KW 30 mbar
	UMSDOGL.5 (LPG)
	31 kg
	550x330x1120  € 763

	<b>KOD CODE</b> KRCS.AMDOE.3
	540x785x940
	3 ADET RADYAN
	380V-50Hz / 4.5 KW
	41 kg
	550x790x950  € 758

- Lpg veya doğalgazla çalışabilme imkanı.
- Magnet emniyet ventilli musluklar.
- Ayarlanabilir döner şişi.
- Çift yöne dönebilme özelliği.
- Hijyenik ve emniyetli.
- Paslanmaz çelik gövde.

- Lpg or naturel gas.
- Magnet safety valve.
- Adjustable spear.
- Dual direction option.
- Hygienic and safe.
- Stainless steel body.

- Alttan hareketli kızaklar döner etinin ısıtıcıya yaklaşmasını sağlar.
- Ayarlanabilir döner şişi.
- Çift yöne dönebilme özelliği.
- Hijyenik ve emniyetli.
- Paslanmaz çelik gövde.

- Sliding bottom housing of the spear provides shawarma meat to get closer to burner
- Adjustable spear
- Dual direction option.
- Hygienic and safe.
- Stainless steel body.

ALTAN MOTORLU ELEKTRİKLİ DÖNER OCAĞI

ALTAN MOTORLU GAZLI DÖNER OCAĞI

ELECTRIC BOTTOM MOTOR ROTARY FURNACE

GAS BOTTOM MOTOR DONER FURNACE



	KOD CODE	KRCS.AMDOE.4
	H L	540x785x1120
		4 ADET RADYAN
		380V-50Hz / 6 KW
		48 kg
		550x790x1220

	KOD CODE	KRCS.AMSDOG.2
	H L	540x785x750
		2 ADET RADYAN
		2422-GAD-1081/32
		5,2 KW 20 mbar
		AMSDOG.2 (NG)
	25 kg	
	550x790x760	€ 663

	KOD CODE	KRCS.AMDOE.5
	H L	540x785x1300
		5 ADET RADYAN
		380V-50Hz / 7,5 KW
		53 kg
		550x790x1310

	KOD CODE	KRCS.AMSDOGL.2
	H L	540x785x750
		2 ADET RADYAN
		2422-GAD-1081/32
		2.4 KW 30 mbar
		AMSDOGL.2 (LPG)
	25 kg	
	550x790x760	€ 663

- 
- Altan hareketli kızaklar döner etinin ısıtıcıya yaklaşmasını sağlar.
  - Ayarlanabilir döner şişi.
  - Çift yöne dönebilme özelliği.
  - Hijyenik ve emniyetli.
  - Paslanmaz çelik gövde.

- 
- Sliding bottom housing of the spear provides shawarma meat to get closer to burner
  - Adjustable spear
  - Dual direction option.
  - Hygienic and safe.
  - Stainless steel body.

- 
- Lpg veya doğalgazla çalışabilme imkanı.
  - Magnet emniyet ventilli musluklar.
  - Ayarlanabilir döner şişi.
  - Çift yöne dönebilme özelliği.
  - Hijyenik ve emniyetli.
  - Paslanmaz çelik gövde.

- 
- Lpg or naturel gas.
  - Magnet safety valve.
  - Adjustable spear.
  - Dual direction option.
  - Hygienic and safe.
  - Stainless steel body.





ALTAN MOTORLU GAZLI DÖNER OCAĞI

ALTAN MOTORLU GAZLI DÖNER OCAĞI

GAS BOTTOM MOTOR DONER FURNACE

GAS BOTTOM MOTOR DONER FURNACE



	<b>KOD CODE</b> KRCS.AMSDOG.3
	565x785x950
	3 ADET RADYAN
	2422-GAD-1081/32
	5,2 KW 20 mbar
	AMSDOG.3 (NG)
	38 kg
	550x790x960  € 750

	<b>KOD CODE</b> KRCS.AMSDOG.4
	565x785x1080
	4 ADET RADYAN
	2422-GAD-1081/32
	6,9 KW 20 mbar
	AMSDOG.4 (NG)
	45 kg
	550x790x1100  € 838

	<b>KOD CODE</b> KRCS.AMSDOGL.3
	565x785x950
	3 ADET RADYAN
	2422-GAD-1081/32
	3,6 KW 30 mbar
	AMSDOGL.3 (LPG)
	38 kg
	550x790x960  € 750

	<b>KOD CODE</b> KRCS.AMSDOGL.4
	565x785x1080
	4 ADET RADYAN
	2422-GAD-1081/32
	4,8 KW 30 mbar
	AMSDOGL.4 (LPG)
	45 kg
	550x790x1100  € 838

- Lpg veya doğalgazla çalışabilme imkanı.
- Magnet emniyet ventilli musluklar.
- Ayarlanabilir döner şişi.
- Çift yöne dönebilme özelliği.
- Hijyenik ve emniyetli.
- Paslanmaz çelik gövde.

- Lpg or naturel gas.
- Magnet safety valve.
- Adjustable spear.
- Dual direction option.
- Hygienic and safe.
- Stainless steel body.

- Lpg veya doğalgazla çalışabilme imkanı.
- Magnet emniyet ventilli musluklar.
- Ayarlanabilir döner şişi.
- Çift yöne dönebilme özelliği.
- Hijyenik ve emniyetli.
- Paslanmaz çelik gövde.

- Lpg or naturel gas.
- Magnet safety valve.
- Adjustable spear.
- Dual direction option.
- Hygienic and safe.
- Stainless steel body.



ALTAN MOTORLU GAZLI DÖNER OCAĞI

ALTAN MOTORLU GAZLI DÖNER OCAĞI

GAS BOTTOM MOTOR DONER FURNACE

GAS BOTTOM MOTOR DONER FURNACE

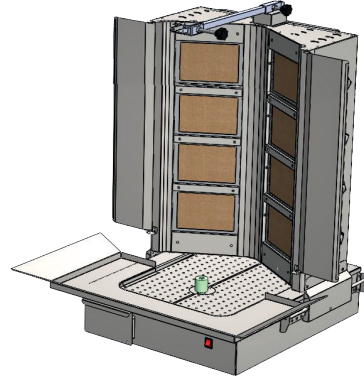

KOD CODE	KRCS.AMSDOG.5
H	565x785x1280
HC	5 ADET RADYAN
	2422-GAD-1081/32
	8,6 KW 20 mbar
	AMSDOG.5 (NG)
	50 kg
	550x790x1380  € 950

KOD CODE	KRCS.AMSDOG.8
H	990x910x1080
HC	8 ADET RADYAN
	2422-GAD-1081/32
	13.6 KW 20 mbar
	AMSDOG.8 (NG)
	90 kg
	1000x920x1100  € 1875

KOD CODE	KRCS.AMSDOGL.5
H	565x785x1280
HC	5 ADET RADYAN
	2422-GAD-1081/32
	6 KW 30 mbar
	AMSDOGL.5 (LPG)
	50 kg
	550x790x1380  € 950

KOD CODE	KRCS.AMSDOGL.8
H	990x910x1080
HC	8 ADET RADYAN
	2422-GAD-1081/32
	9.6 KW 30 mbar
	AMSDOGL.8 (LPG)
	90 kg
	1000x920x1100  € 1875

- 
- Lpg veya doğalgazla çalışabilme imkanı.
  - Magnet emniyet ventilli musluklar.
  - Ayarlanabilir döner şişi.
  - Çift yöne dönebilme özelliği.
  - Hijyenik ve emniyetli.
  - Paslanmaz çelik gövde.

- 
- Lpg or naturel gas.
  - Magnet safety valve.
  - Adjustable spear.
  - Dual direction option.
  - Hygienic and safe.
  - Stainless steel body.

- 
- Lpg veya doğalgazla çalışabilme imkanı.
  - Magnet emniyet ventilli musluklar.
  - Ayarlanabilir döner şişi.
  - Çift yöne dönebilme özelliği.
  - Hijyenik ve emniyetli.
  - Paslanmaz çelik gövde.

- 
- Lpg or naturel gas.
  - Magnet safety valve.
  - Adjustable spear.
  - Dual direction option.
  - Hygienic and safe.
  - Stainless steel body.

ALTAN MOTORLU GAZLI DÖNER OCAĞI

GAZLI LAVATAŞ DÖNER OCAĞI

GAS BOTTOM MOTOR DONER FURNACE

GAS LAVA STONE DONER FURNACE

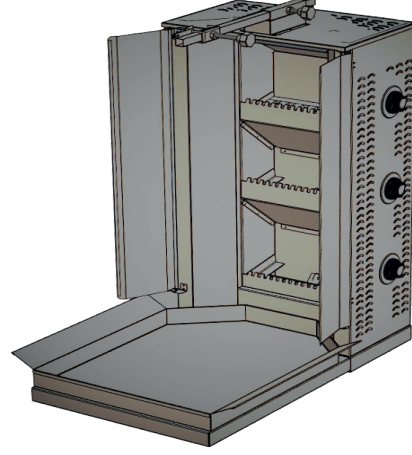
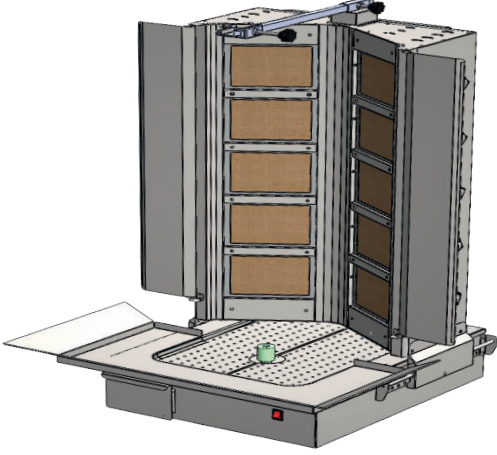

KOD CODE	KRCS.AMSDOG.10
H L	990x910x1150
	10 ADET RADYAN
	2422-GAD-1081/32
	17.5 KW 20 mbar
	AMSDOG.10 (NG)
	110 kg
	1000x920x1250  € 2275

KOD CODE	KRCS.DOLG.3
H L	520x750x930
	3 ADET RADYAN
	2422-GAD-1081/32
	5,2 KW 20 mbar
	DNR 3
	65 kg
	530x760x940  € 2169

KOD CODE	KRCS.AMSDOGL.10
H L	990x910x1150
	10 ADET RADYAN
	2422-GAD-1081/32
	12 KW 30 mbar
	AMSDOGL.10 (LPG)
	110 kg
	1000x920x1250  € 2275

KOD CODE	KRCS.DOLG.4
H L	520x750x1200
	4 ADET RADYAN
	2422-GAD-1081/32
	4.8 KW 30 mbar
	DNR 4
	85 kg
	530x760x1210  € 2890

- 
- Lpg veya doğalgazla çalışabilme imkanı.
  - Magnet emniyet ventilli musluklar.
  - Ayarlanabilir döner şişi.
  - Çift yöne dönebilme özelliği.
  - Hijyenik ve emniyetli.
  - Paslanmaz çelik gövde.

- 
- Lpg or naturel gas.
  - Magnet safety valve.
  - Adjustable spear.
  - Dual direction option.
  - Hygienic and safe.
  - Stainless steel body.

- 
- Lpg veya doğalgazla çalışabilme imkanı.
  - Magnet emniyet ventilli musluklar.
  - Ayarlanabilir döner şişi.
  - Çift yöne dönebilme özelliği.
  - Hijyenik ve emniyetli.
  - Paslanmaz çelik gövde.

- 
- Lpg or naturel gas.
  - Magnet safety valve.
  - Adjustable spear.
  - Dual direction option.
  - Hygienic and safe.
  - Stainless steel body.

🇹🇷 ELEKTRİKLİ PİLİÇ ÇEVİRME MAKİNESİ

🇹🇷 ELEKTRİKLİ PİLİÇ ÇEVİRME MAKİNESİ

🇬🇧 ELECTRIC CHICKEN ROSTER

🇬🇧 ELECTRIC CHICKEN ROSTER



	KOD CODE	KRCS.PLCDE.2
		840x500x670
		8 ADET
		230V- 22 mbar / 4 KW
		45 kg
		840x550x750  € 1000

	KOD CODE	KRCS.PLCDE.3
		900x500x800
		12 ADET
		230V- 22 mbar / 4,5 KW
		51 kg
		900x550x880  € 1125

	KOD CODE	KRCS.PLCDE.4
		1005x500x800
		15 ADET
		230V- 22 mbar / 5 KW
		57 kg
		1005x550x880  € 1188



- Pişirme tipi elektrikli olup,her rezistans ayrı ayrı kontrol edilebilir.
- Kapak camları temperlidir.
- Şiş ve cam kapak tutma kulpları ısıya dayanıklı bakalitir.
- Elektrik tesisatı yüksek ısıya dayanıklıdır.
- Çelik dişli sistemi sessiz bir çalışma imkanı sağlar.
- Paslanmaz çelik gövde.



- Roasting type operates electrically and each resistance may controlled separately.
- Heat resistant tempered glass doors.
- Spear and door handles are made of heat resistant bakelite.
- Steel gear system provides quiet operation.
- Electric system is resistant to high temperatures.
- Stainless steel body.
- Provides simple maintain and easy cleaning.



- Pişirme tipi elektrikli olup,her rezistans ayrı ayrı kontrol edilebilir.
- Kapak camları temperlidir.
- Şiş ve cam kapak tutma kulpları ısıya dayanıklı bakalitir.
- Elektrik tesisatı yüksek ısıya dayanıklıdır.
- Çelik dişli sistemi sessiz bir çalışma imkanı sağlar.
- Paslanmaz çelik gövde.



- Roasting type operates electrically and each resistance may controlled separately.
- Heat resistant tempered glass doors.
- Spear and door handles are made of heat resistant bakelite.
- Steel gear system provides quiet operation.
- Electric system is resistant to high temperatures.
- Stainless steel body.
- Provides simple maintain and easy cleaning.



GAZLI PİLİÇ ÇEVİRME MAKİNESİ

GAZLI PİLİÇ ÇEVİRME MAKİNESİ

GAS CHICKEN ROSTER

GAS CHICKEN ROSTER



	<b>KOD CODE</b> KRCS.PLCDG.2
	840x500x670
	8 ADET
	230V- 22 mbar / 5 KW
	45 kg
	840x550x750 € 1000

	<b>KOD CODE</b> KRCS.PLCDGL.2
	840x500x670
	8 ADET
	230V- 22 mbar / 5 KW
	45 kg
	840x550x750 € 1000

	<b>KOD CODE</b> KRCS.PLCDG.3
	900x500x800
	12 ADET
	230V- 22 mbar / 7 KW
	51 kg
	900x550x880 € 1125

	<b>KOD CODE</b> KRCS.PLCDGL.3
	900x500x800
	12 ADET
	230V- 22 mbar / 7 KW
	51 kg
	900x550x880 € 1125

	<b>KOD CODE</b> KRCS.PLCDG.4
	1005x500x800
	15 ADET
	230V- 22 mbar / 9 KW
	57 kg
	1005x550x880 € 1188

	<b>KOD CODE</b> KRCS.PLCDGL.4
	1005x500x800
	15 ADET
	230V- 22 mbar / 9 KW
	57 kg
	1005x550x880 € 1188



- Lpg ve doğalgaza uyumludur.
- Kumanda muslukları emniyet ventillidir.
- Pişirme tipi radyanlı olup,her radyan ayrı ayrı kontrol edilebilir.
- Kapak camları temperlidir.
- Çelik dişli sistemi sessiz bir çalışma imkanı sağlar.
- Şiş ve cam kapak tutma kulpları ı siya dayanıklı bakalitir.
- Elektrik tesisatı yüksek ısıya dayanıklıdır.
- Paslanmaz çelik gövde.
- Bakımı ve temizliği kolaydır.



- LPG or NG.
- Safety valve.
- Operates by radiant and each radiant can be controlled separately.
- Heat resistant tempered glass doors.
- Steel gear system provides quiet operation.
- Spear and door handles are made of heat resistant bakelite.
- Electrical fitting is durable to high temperatures.
- Stainless steel body.
- Easy cleaning.



- Lpg ve doğalgaza uyumludur.
- Kumanda muslukları emniyet ventillidir.
- Pişirme tipi radyanlı olup,her radyan ayrı ayrı kontrol edilebilir.
- Kapak camları temperlidir.
- Çelik dişli sistemi sessiz bir çalışma imkanı sağlar.
- Şiş ve cam kapak tutma kulpları ı siya dayanıklı bakalitir.
- Elektrik tesisatı yüksek ısıya dayanıklıdır.
- Paslanmaz çelik gövde.
- Bakımı ve temizliği kolaydır.



- LPG or NG.
- Safety valve.
- Operates by radiant and each radiant can be controlled separately.
- Heat resistant tempered glass doors.
- Steel gear system provides quiet operation.
- Spear and door handles are made of heat resistant bakelite.
- Electrical fitting is durable to high temperatures.
- Stainless steel body.
- Easy cleaning.

ELEKTRİKLİ KUMPIR MAKİNESİ

ELECTRIC PIPE MACHINE



ELEKTRİKLİ KUMPIR MAKİNESİ

ELECTRIC PIPE MACHINE



	KOD CODE	KRCS.KFE.2
		500x700x750
		2
		230V- 22 mbar / 3 KW
		45 kg
		600x760x900  € 1663

	KOD CODE	KRCS.KFE.3
		500x700x980
		3
		230V- 22 mbar / 4.5 KW
		51 kg
		600x760x1090  € 1900



- Her çekmece için ayrı rezistans.
- Çift izolasyonlu gövde.
- Termostat kontrollü.
- Paslanmaz çelik çekmeceler.



- Separated resistance in each drawer.
- Duble insulated body.
- Thermostat controlled.
- Stainless steel drawers



- Her çekmece için ayrı rezistans.
- Çift izolasyonlu gövde.
- Termostat kontrollü.
- Paslanmaz çelik çekmeceler.



- Separated resistance in each drawer.
- Duble insulated body.
- Thermostat controlled.
- Stainless steel drawers





GAZLI KUMPİR MAKİNESİ

GAZLI KUMPİR MAKİNESİ

GAS PIPE MACHINE

GAS PIPE MACHINE



	<b>KOD CODE</b>	<b>KRCS.KFG.2</b>
	<b>H</b>	500x700x950
		2
		4.3 KW
		45 kg
		600x760x1090
		<b>€ 1488</b>

	<b>KOD CODE</b>	<b>KRCS.KFG.3</b>
	<b>H</b>	500x700x1200
		3
		4.3 KW
		51 kg
		600x760x1270
		<b>€ 1725</b>

	<b>KOD CODE</b>	<b>KRCS.KFGL.2</b>
	<b>H</b>	500x700x950
		2
		4.3 KW
		45 kg
		600x760x1090
		<b>€ 1488</b>

	<b>KOD CODE</b>	<b>KRCS.KFGL.3</b>
	<b>H</b>	500x700x1200
		3
		4.3 KW
		51 kg
		600x760x1270
		<b>€ 1725</b>

- LPG ve NG ile çalışabilme özelliği.
- Her çekmece için ayrı brülör.
- Çift izolasyonlu gövde.
- Emniyet ventili ve piezo çakmak ile kontrol.
- Paslanmaz çelik çekmeceler.

- LPG or Naturel gas.
- Seperated burner in each drawer.
- Duple insulated body.
- Piezoelectric ignition system and safety valve.
- Stainless steel drawers.

- LPG ve NG ile çalışabilme özelliği.
- Her çekmece için ayrı brülör.
- Çift izolasyonlu gövde.
- Emniyet ventili ve piezo çakmak ile kontrol.
- Paslanmaz çelik çekmeceler.

- LPG or Naturel gas.
- Seperated burner in each drawer.
- Duple insulated body.
- Piezoelectric ignition system and safety valve.
- Stainless steel drawers.



KAHVE MAKİNESİ

COFFEE MACHINES



KAHVE MAKİNESİ

COFFEE MACHINES



	KOD CODE	LUNNA EPU2	
	H L	740x555x515	
	⚡	220/400 V -1N/3N 3.7 kW	
	HE		
	KG	62	
			€ 5300

	KOD CODE	LUNNA EVD2 TC	
	H L	740x555x515	
	⚡	220/400 V -1N/3N 3.7 kW	
	HE		
	KG	62	
			€ 5735

KAHVE MAKİNESİ

- 2-3 gruplu yarı otomatik espresso kahve makinesi
- Elektromekanik kontrol tuşu
- Standart ön demleme
- 2 adet buhar çubuğu
- Tekli sıcak su çıkışı
- Standart otomatik su seviyesi ayarı
- Dahili motor pompası
- Boiler kapasitesi: 10,5-17 Litre

COFFEE MACHINES

- 2-3 group semi-automatic espresso coffee machine
- Electro mechanical push buttons
- Pre-Infusion
- 2 Steam wands
- Single hot water outlet
- Water autolevel standart
- Built-in motor pump
- Boiler capacity: 10,5-17 Liter

KAHVE MAKİNESİ

- 2-3 gruplu yarı otomatik espresso kahve makinesi
- Her bir grup için 4 adet programlanabilir dozaj ayarı
- Standart ön demleme
- 2 adet buhar çubuğu
- Otomatik sıcak su çıkışı (2-3gr)
- Dahili motor pompası
- 122 mm yükseltilmiş grup
- Boiler kapasitesi: 10,5-17 Litre

COFFEE MACHINES

- 2-3 group semi-automatic espresso coffee machine
- 4 programable doses per group
- Pre-Infusion
- 2 Steam wands
- Automatic hot water outlet (2-3gr)
- Built-in motor pump
- Raised group 122 mm
- Boiler capacity: 10,5-17 Liter



KAHVE MAKİNESİ

KAHVE MAKİNESİ

COFFEE MACHINES

COFFEE MACHINES



	KOD CODE	TITAN II
	H L	360x220x520
	⚡	220V-1N 250 W
	H HC	
	KG	9 KG
		€ 1030

- Daha iyi bir tat deneyimi için sertleştirilmiş özel çelik 64 mm çapında dişliler
- Sağ veya sol elini kullananlar için tüm alüminyum alaşımlı döküm dağıtıcı
- Özel kaplamalı akıllı kılıf ortalama temizleme süresini kısaltır
- Hassas ve rahat dozajlama için doz başına 5-10 g arasında geniş dozajlama kapasitesi
- Statik tamper hızlı ve rahat bir tamping için sola veya sağa monte edilebilir
- Sessiz bir çalışma ortamı için düşük gürültü seviyesi
- Hazne kapasitesi: 1,2 kg
- Öğütme hızı: 2.0-2.5 g/s

- Hardened special steel 64 mm diameter burrs for a better taste experience
- All aluminum alloy casted dispenser for right- or lefthanded users
- Specially coated smart case reduces the average cleaning time
- Wide dispensing capacity from 5 - 10 g per dose for precise and convenient dosing
- Static tamper mountable left or right for a quick and convenient tamping
- Low noise level for a quiet working environment
- Hopper capacity: 1,2 kg
- Grind speed: 2.0 - 2.5 g/s

	KOD CODE	FLT 120
	H L	190x370x440
	⚡	220V-1N 2.4 kW
	H HC	1.8 lt cam pot kapasiteli
	KG	6.2 KG
		€ 470

	KOD CODE	FLT 250
	H L	190x370x680
	⚡	220V-1N 2.2 kW
	H HC	2.5 lt cam pot kapasiteli
	KG	6.5 KG
		€ 1190

- Filtre kahve makinesi
- Parçalayıcı (300 mm)
- Birbirinden bağımsız kullanılabilen ısıtıcılar
- Susuz çalışma koruması
- Hızlı demleme süresi (6 dakika)
- Kapasite: 144 fincan/saat
- 1.8 lt. cam pot kapasitesi
- Kapasite: 1,5 - 2 lt.
- Opsiyonel olarak 1 veya 2 cam potlu

- Filter coffee machine
- Hot plates that can be used separately
- Dry-boil protection
- Fast brewing time(6 min.)
- Capacity 144 Cup/hour
- 1.8 lt glass jug capacity
- Optional 1 or 2 glass jugs

- Filtre kahve makinesi
- Susuz çalışma koruması
- Hızlı demleme süresi (8 dakika)
- Kapasite: 144 fincan/saat
- 2,5Lt Termos kapasitesi

- Filter coffee machine
- Dry-boil protection
- Fast brewing time(8 min.)
- Capacity 144 Cup/hour
- 2,5 lt thermos capacity

BLENDER

BLENDER

BLENDERS

BLENDERS



	KOD CODE	BL25
	H	130x98x595
	⚡	220V-1N 250W
	KG	2.25
	€	325

	KOD CODE	BL25 L35
	H	130x98x705
	⚡	220V-1N 250W
	KG	2.40
	€	350

	KOD CODE	BL25-C
	H	130x98x595
	⚡	220V-1N 250W
	KG	3.15
	€	500

	KOD CODE	BL25 L35-C
	H	130x98x705
	⚡	220V-1N 250W
	KG	3.30
	€	520



AÇIKLAMA DESCRIPTION	BL25 Kol BL25 Arm	BL25 L35 Kol BL25 L35 Arm	BL40 Kol BL40 Arm	BL40 L50 Kol BL40 L50 Arm	BL40 L60 Kol BL40 L60 Arm	BL25 Çırpıcı BL25 Whisk	BL40 Çırpıcı BL40 Whisk
FİYAT PRICE	150 €	180 €	205 €	240 €	270 €	240 €	260 €

-Sabit hız ve paslanmaz çelik bıçak  
-Parçalayıcı (300 mm)  
-Çırpıcı Aparat (360 mm-Combi modeller için)  
-Easy lock sistemi ile kolay kullanım  
-Devir hızı: 13000 rpm

-Constant speed and stainless steel blade  
-Mixer arm 300 mm  
-Whisk (360 mm-Combi models only)  
-Easy to use with Easy lock system  
-Revolution: 13000 rpm

-Sabit hız ve paslanmaz çelik bıçak  
-Parçalayıcı (300 mm)  
-Çırpıcı Aparat (360 mm-Combi modeller için)  
-Easy lock sistemi ile kolay kullanım  
-Devir hızı: 13000 rpm

-Constant speed and stainless steel blade  
-Mixer arm 300 mm  
-Whisk (360 mm-Combi models only)  
-Easy to use with Easy lock system  
-Revolution: 13000 rpm



🇹🇷 BLENDER

🇬🇧 BLENDERS

🇹🇷 BLENDER

🇬🇧 BLENDERS



	KOD CODE	BL40
	H L	146x120x790
	⚡	220V-1N 400W
	HC	
	KG	3.90
		€ 480

	KOD CODE	BL40 L50
	H L	146x120x890
	⚡	220V-1N 400W
	HC	
	KG	4.10
		€ 505

	KOD CODE	BL40-C
	H L	146x120x790
	⚡	220V-1N 400W
	HC	
	KG	4.90
		€ 660

	KOD CODE	BL40 L50-C
	H L	146x120x890
	⚡	220V-1N 400W
	HC	
	KG	5.10
		€ 680



AÇIKLAMA DESCRIPTION	BL25 Kol BL25 Arm	BL25 L35 Kol BL25 L35 Arm	BL40 Kol BL40 Arm	BL40 L50 Kol BL40 L50 Arm	BL40 L60 Kol BL40 L60 Arm	BL25 Çırpıcı BL25 Whisk	BL40 Çırpıcı BL40 Whisk
FİYAT PRICE	150 €	180 €	205 €	240 €	270 €	240 €	260 €



-Sabit hız ve paslanmaz çelik bıçak  
-Parçalayıcı (300 mm)  
-Çırpıcı Aparat (360 mm-Combi modeller için)  
-Easy lock sistemi ile kolay kullanım  
-Devir hızı: 13000 rpm



-Constant speed and stainless steel blade  
-Mixer arm 300 mm  
-Whisk (360 mm-Combi models only)  
-Easy to use with Easy lock system  
-Revolution: 13000 rpm



-Sabit hız ve paslanmaz çelik bıçak  
-Parçalayıcı (300 mm)  
-Çırpıcı Aparat (360 mm-Combi modeller için)  
-Easy lock sistemi ile kolay kullanım  
-Devir hızı: 13000 rpm



-Constant speed and stainless steel blade  
-Mixer arm 300 mm  
-Whisk (360 mm-Combi models only)  
-Easy to use with Easy lock system  
-Revolution: 13000 rpm

🇹🇷 BLENDER

🇹🇷 BLENDER

🇬🇧 BLENDERS

🇬🇧 BLENDERS



	KOD CODE	BL40 L60
		146x120x990
		220V-1N 400W
		4.40
		€ 530

	KOD CODE	BL40 L60-C
		146x120x990
		220V-1N 400W
		5.40
		€ 780



AÇIKLAMA DESCRIPTION	BL25 Kol BL25 Arm	BL25 L35 Kol BL25 L35 Arm	BL40 Kol BL40 Arm	BL40 L50 Kol BL40 L50 Arm	BL40 L60 Kol BL40 L60 Arm	BL25 Çırpıcı BL25 Whisk	BL40 Çırpıcı BL40 Whisk
FİYAT PRICE	150 €	180 €	205 €	240 €	270 €	240 €	260 €



-Sabit hız ve paslanmaz çelik bıçak  
-Parçalayıcı (300 mm)  
-Çırpıcı Aparat (360 mm-Combi modeller için)  
-Easy lock sistemi ile kolay kullanım  
-Devir hızı: 13000 rpm  
--Hassas teknoloji  
--Kapasite: 1,5 - 2 lt.



-Constant speed and stainless steel blade  
-Mixer arm 300 mm  
-Whisk (360 mm-Combi models only)  
-Easy to use with Easy lock system  
-Revolution: 13000 rpm



-Sabit hız ve paslanmaz çelik bıçak  
-Parçalayıcı (300 mm)  
-Çırpıcı Aparat (360 mm-Combi modeller için)  
-Easy lock sistemi ile kolay kullanım  
-Devir hızı: 13000 rpm  
--Hassas teknoloji  
--Kapasite: 1,5 - 2 lt.



-Constant speed and stainless steel blade  
-Mixer arm 300 mm  
-Whisk (360 mm-Combi models only)  
-Easy to use with Easy lock system  
-Revolution: 13000 rpm



BAR EKİPMANLARI

BAR EKİPMANLARI

BAR EQUIPMENTS

BAR EQUIPMENTS



	<b>KOD CODE</b>	<b>TM-767 A</b>
		205x230x510
		220V 1.2KW
		1.5LT
		4.3 KG
		€ 910

	<b>KOD CODE</b>	<b>NO54</b>
		182x186x530
		220V-1N 0.23 KW
		6 KG
		€ 1460

	<b>KOD CODE</b>	<b>TM-767</b>
		205x230x510
		220V 1.2KW
		2LT
		4.3 KG
		€ 955



- Değişken hız kontrolü
- Çok fonksiyonlu
- Islak ve kuru uygulama
- İkisi bir arada paslanmaz çelik kesme bıçağı
- Üstün kalite, şeffaf konteyner
- Hassas teknoloji
- Kapasite: 1,5 - 2 lt.



- Variable speed control
- Multi function
- Wet and dry application
- Two in one stainless steel cutting blade
- Premium quality, transparent, container
- Precision technology
- Capacity: 1,5 - 2 lt.



- İçki karıştırıcı kase algılama ile otomatik motorlu aktivasyonu
- 2 adet kase ve 3 adet karıştırıcı
- Güçlü Motor
- 8.000 rpm ve 16.000 rpm iki hız



- Automatic motor activation with bowl detection
- 2 bowl and 3 mixer
- Powerful Engine
- Two speed 8000 rpm and 16000 rpm



BAR EKİPMANLARI

BAR EQUIPMENTS



BAR EKİPMANLARI

BAR EQUIPMENTS



	KOD CODE	NO53	€ 2770
		236x353x474	
		220V-1N 0.13kW	
		10	

	KOD CODE	NO62	€ 4100
		200x247x441	
		220V-1N 01.3 kW	
		9,5	



- Ticari buz kırıcı
- İnce ve kırık buz yapma özelliği
- 30 sn'de 1,2 kg buz kırma kapasitesi
- Kapasite: 140 kg./saat



- Commercial ice crusher
- Feature to fine and crushed ice
- 1.2 kg of ice-breaking capacity in 30 seconds
- Capacity: 140kg/hour



- 30 ön program hafızası
- LCD ekran ve 6 program tuşu
- Güçlü ve çok sessiz, gürültü önleme kapaklı
- Değişken devir hızı



- 30 pre-programmed memory
- LCD display with 6 program keys
- Powerful and very quiet, noise protection cover
- Variable revolution



BAR EKİPMANLARI

BAR EQUIPMENTS



	KOD CODE	NO11
	H	230x300x350
	L	
	⚡	220V-1N 0.13kW
	HC	
	KG	5
		€ 875



- Su geçirmez motor.
- Ağız yüksekliği 125 mm
- Devir hızı 1800 rpm



- Waterproof motor, High stability
- Blade height 125 mm
- Revolution: 1800 rpm

BAR EKİPMANLARI

BAR EQUIPMENTS



	KOD CODE	NO28
	H	320x480x570
	L	
	⚡	220V-1N 1.3kW
	HC	
	KG	24
		€ 7330



- Termal koruma
- Dakikada 1 lt.'den fazla sıvı çıkışı
- Powerful and quiet
- Yükleme ağızı çapı 68 mm
- Devir Hızı: 3600 rpm



- Thermal protection
- More than 1 Lt. per minute fluid output
- Güçlü ve sessiz
- Loading diameter: 68 mm
- Revolution: 3600 rpm

	KOD CODE	NO33
	H	180x180x420
	L	
	⚡	220V-1N 0.6kW
	HC	
	KG	3.9
		€ 930



- Sağlam paslanmaz çelik bıçaklar.
- Çalışır durumda malzeme eklemek için ekstra ağız.
- Kolay kullanım ve temizlik imkanı.
- Devir Hızı: 1600 rpm



- Stainless steel knives
- Extra mouth to add material while running
- Easy to use and cleaning
- Revolution: 1600 rpm

	KOD CODE	NO50
	H	260x470x450
	L	
	⚡	220V-1N 0.8kW
	HC	
	KG	14
		€ 3400



- Termal koruma
- Dakikada 1 Lt sıvı çıkışı
- Krom kaplı gövde
- Yükleme ağızı çapı: 79 mm
- Devir Hızı: 3600 rpm



- Thermal protection
- 1 Lt. of liquid output per minute
- Chrome-plated body
- Loading diameter: 79 mm
- Revolution: 3600 rpm