

apricot

Apricot FT//ex

Owner's Handbook

IBM and PS/2 are registered trademarks of International Business Machines Corporation. Intel is a registered trademark of Intel Corporation.

MS-DOS is a registered trademark of Microsoft Corporation.

Other brand and product names are trademarks and/or registered trademarks of their respective holders.

Information contained in this document is subject to change without notice and does not represent a commitment on the part of Apricot Computers Limited. The software described in this manual is furnished under a license agreement. The software may be used or copied only in accordance with the terms of this agreement.

It is against the law to copy any disk supplied for any other purpose than the purchaser's personal use.

All rights reserved; no use or disclosure without written consent.

Copyright © 1993

Published by
Apricot Computers Limited
3500 Parkside
Birmingham Business Park
B37 7YS

 MITSUBISHI ELECTRIC

Printed in the United Kingdom

Part no. 15220231

IMPORTANT SAFETY INSTRUCTIONS

1. Read these instructions carefully. Save these instructions for future reference.
2. Follow all warnings and instructions marked on the product.
3. Unplug this product from the wall outlet before cleaning. Do not use liquid cleaners or aerosol cleaners. Use a damp cloth for cleaning.
4. Do not use this product near water.
5. Do not place this product on an unstable cart, stand, or table. The product may fall, causing serious damage to the product.
6. Slots and openings in the cabinet and the back or bottom are provided for ventilation; to ensure reliable operation of the product and to protect it from overheating, these openings must not be blocked or covered. The openings should never be blocked by placing the product on a bed, sofa, rug, or other similar surface. This product should never be placed near or over a radiator or heat register, or in a built-in installation unless proper ventilation is provided.
7. This product should be operated from the type of power indicated on the marking label. If you are not sure of the type of power available, consult your dealer or local power company.
8. This product is equipped with a 3-wire grounding-type plug, a plug having a third (grounding) pin. This plug will only fit into a grounding-type power outlet. This is a safety feature. If you are unable to insert the plug into the outlet, contact your electrician to replace your obsolete outlet. Do not defeat the purpose of the grounding-type plug.

9. Do not allow anything to rest on the power cord. Do not locate this product where persons will walk on the cord.
10. If an extension cord is used with this product, make sure that the total ampere rating of the equipment plugged into the extension cord does not exceed the extension cord ampere rating. Also, make sure that the total rating of all products plugged into the wall outlet does not exceed 15 amperes.
11. Never push objects of any kind into this product through cabinet slots as they may touch dangerous voltage points or short out parts that could result in a fire or electric shock. Never spill liquid of any kind on the product.
12. Do not attempt to service this product yourself, as opening or removing covers may expose you to dangerous voltage points or other risks. Refer all servicing to qualified service personnel.
13. Unplug this product from the wall outlet and refer servicing to qualified service personnel under the following conditions:
 - a. When the power cord or plug is damaged or frayed
 - b. If liquid has been spilled into the product
 - c. If the product has been exposed to rain or water
 - d. If the product does not operate normally when the operating instructions are followed. Adjust only those controls that are covered by the operating instructions since improper adjustment of other controls may result in damage and will often require extensive work by a qualified technician to restore the product to normal condition.
 - e. If the product has been dropped or the cabinet has been damaged
 - f. If the product exhibits a distinct change in performance, indicating a need for service

14. Replace battery with the same type as the product's battery we recommend. Use of another battery may present a risk of fire or explosion. Refer battery replacement to a qualified serviceman.
15. Warning! Battery may explode if not handled properly. Do not recharge, disassemble or dispose of in fire. Keep away from children and dispose of used battery promptly.
16. Use only the proper type of power supply cord set (provided in your keyboard/manual accessories box) for this unit. It should be a detachable type: UL listed/CSA certified, type SVT/SJT, rated 6A 125V minimum, VDE approved or its equivalent. Maximum length is 15 feet (4.6 meters).

FCC Class B Radio Frequency Interference Statement

Note:

This equipment has been tested and found to comply with the limits for a Class B digital device, pursuant to Part 15 of FCC Rules. These limits are designed to provide reasonable protection against harmful interference in a residential installation. This equipment generates, uses, and can radiate radio frequency energy and, if not installed and used in accordance with the instructions, may cause harmful interference to radio communications. However, there is no guarantee that interference will not occur in a particular installation. If this equipment does cause harmful interference to radio or television reception, which can be determined by turning the equipment off and on, the user is encouraged to try to correct the interference by one or more of the following measures:

1. Reorient or relocate the receiving antenna.
2. Increase the separation between the equipment and receiver.
3. Connect the equipment into an outlet on a circuit different from that to which the receiver is connected.
4. Consult the dealer or an experienced radio/television technician for help.

Notice 1:

The changes or modifications not expressly approved by the party responsible for compliance could void the user's authority to operate the equipment.

Notice 2:

Shielded interface cables and A.C. power cord, if any, must be used in order to comply with the emission limits.

Table of Contents

About This Manual

1 System Housing

1.1	Getting Started	1-1
1.1.1	Selecting a Site	1-1
1.1.2	Unpacking the System	1-2
1.1.3	Positioning the System	1-3
1.1.4	Moving the System	1-5
1.2	Features	1-6
1.2.1	Front Panel	1-6
1.2.2	Rear Panel	1-8
1.3	Connecting the Components	1-10
1.4	Installing Options	1-14
1.4.1	ESD Precautions	1-14
1.4.2	Opening the System	1-14
1.4.3	Installing and Removing Expansion Boards....	1-20
1.4.4	Installing Drives	1-22
1.4.5	Arranging the Cables	1-28
2	System Board	
2.1	Major Components	2-2
2.2	Upgrading the Memory	2-4
2.2.1	Installing SIMMs	2-6
2.2.2	Removing SIMMs	2-7
2.2.3	Reconfiguring the System	2-7
2.3	Upgrading the CPU	2-8

2.4	SCSI Feature	2-9
2.4.1	Using SCSI	2-9
2.5	Jumper Settings	2-10
2.6	Error Messages	2-12
2.6.1	Software Error Messages	2-12
2.6.2	System Error Messages	2-12
2.6.3	Correcting Error Conditions	2-15
2.7	Address Maps and Interrupt Table	2-16
2.7.1	System Memory Map	2-16
2.7.2	I/O Address Map	2-18
2.7.3	Interrupt Levels	2-20
3	486 CPU Board	
3.1	Upgrading the CPU	3-3
3.1.1	Installing the Upgrade CPU	3-3
3.2	Upgrading the Second-Level Cache	3-4
3.3	Jumper Settings	3-6
4	Pentium CPU Board	
4.1	Upgrading to Dual CPUs	4-3
4.1.1	Installing the Second CPU	4-3
4.2	Upgrading the Second-Level Cache	4-4
4.3	Upgrading the Memory	4-5
4.4	Jumper Settings	4-6
5	Configuring the System	
5.1	Basic System Configuration (486 CPU)	5-3
5.1.1	The Real-Time Clock	5-5
5.1.2	Diskette Drives	5-5
5.1.3	Fixed Disk Drives	5-5

5.1.4	System Memory	5-6
5.1.5	Math Coprocessor	5-6
5.1.6	Video Display	5-6
5.1.7	Communication Settings.....	5-7
5.1.8	Memory Test	5-7
5.2	Basic System Configuration (Pentium CPU)	5-8
5.3	Advanced System Configuration (486 CPU)	5-9
5.3.1	Shadow RAM	5-11
5.3.2	Internal Cache	5-11
5.3.3	System Cache	5-11
5.3.4	SCSI I/O ROM Mapping	5-12
5.4	Advanced System Configuration (Pentium CPU)	5-13
5.5	System Security	5-15
5.5.1	Disk Drive Control	5-15
5.5.2	On Board Communication Ports	5-15
5.5.3	Setup Password	5-16
5.5.4	Power On Password	5-17
5.6	IDE Fixed Disk Types	5-18

6 EISA Configuration Utility

6.1	Functions	6-1
6.2	Program Menu Organization	6-2
6.3	Starting the ECU	6-2
6.3.1	Main Menu	6-3
6.3.2	Main Menu Selections	6-3
6.3.3	Configuring the Computer	6-4
6.3.4	EISA Board Configuration Files	6-5
6.3.5	Configure Computer - Basic Method	6-6

6.4	Advanced Configuration	6-7
6.4.1	Advanced Configuration Menu Selections	6-9
6.4.2	Using the Advanced Configuration Menus	6-14
6.4.3	Configuring an ISA Option Without a CFG file	6-18
6.5	Solving Resource Conflicts	6-18
6.6	Options in using the ECU	6-19
6.6.1	Starting the ECU From a Fixed Disk	6-19
6.6.2	Starting the Configure Computer Selection from MS-DOS	6-21

List of Figures

1-1	Standing the System Alone	1-3
1-2	Standing the System Against a Wall	1-4
1-3	Moving the System	1-5
1-4	Front Panel	1-6
1-5	Rear Panel	1-8
1-6	Connecting the Keyboard	1-10
1-7	Connecting a Mouse	1-11
1-8	Connecting a Monitor	1-11
1-9	Connecting a Printer	1-12
1-10	Connecting the Power Cables	1-13
1-11	Opening the Upper Front Panel Cover	1-15
1-12	Opening the Lower Front Panel Cover	1-16
1-13	Removing the Front Panel Cover and Frame	1-17
1-14	Opening the System Housing	1-18
1-15	Inside Components	1-19
1-16	Removing a Bracket	1-20
1-17	Installing a Board	1-21
1-18	Attaching the Drive Guides	1-22
1-19	Installing a 5.25-inch Diskette Drive	1-23
1-20	Removing a 5.25-inch Diskette Drive	1-24
1-21	Pulling Out a Fixed Disk Drive Drawer	1-25
1-22	Installing a Fixed Disk Drive	1-26
1-23	Inserting the Drive Drawer	1-27
1-24	Clipping the Cables with the Cable Clamp	1-28

- 2-1 System Board Layout 2-3
- 2-2 Installing a SIMM 2-6
- 2-3 System Board Jumper Settings 2-10
- 3-1 486 CPU Board Layout 3-2
- 3-2 486 CPU Board Jumper Locations 3-6
- 4-1 Pentium CPU Board Layout 4-2
- 4-2 Pentium CPU Board Jumper Locations 4-6
- 6-1 Advanced Configuration
(System—Open Selected) 6-7

List of Tables

1-1	Features and Functions of the Front Panel	1-7
1-2	Features and Functions of the Rear Panel	1-9
2-1	Memory Configurations with 486 CPU board	2-4
2-2	System Board Jumper Settings	2-11
2-3	System Error Messages	2-12
2-4	System Memory Map	2-16
2-5	System I/O Address Map	2-18
2-6	Interrupt Requests Used	2-20
3-1	Second-level Cache Upgrade (486 CPU Board)	3-5
3-2	486 CPU Board Jumper Settings	3-7
4-1	Second-level Cache Upgrade (Pentium CPU Board)	4-4
4-2	Memory Configurations with Pentium CPU board	4-6
4-3	Pentium CPU Board Jumper Settings	4-7
6-1	Advanced Configuration Menu Bar Selections	6-9

About This Manual

Audience

This User's Manual is intended for three types of reader:

- Users of application software in a business or personal-computing environment
- Business and technical buyers who want to develop software and hardware packages to customize the system for a specific environment
- System designers and programmers who intend to modify the system hardware and configure the system

Purpose and Scope

This manual tells you how to install, configure and operate the system.

In addition to giving information about the system hardware and software, it also explains how to install optional devices and how to deal with operating problems and error messages.

Organization

This manual consists of six chapters.

Chapter 1, **System Housing**, describes the different parts of the system unit such as switches, status indicators, connectors, and hardware components. It explains how to set up and start the system. It also shows how to install optional hardware devices. Guidelines for troubleshooting minor hardware problems are given at the end of the chapter.

Chapter 2, **System Board**, describes the features and components of the system board. It also includes jumper settings and memory configurations.

Chapter 3, **486 CPU Board**, describes the features of the 486 CPU board, CPU and second-level cache upgrade, and jumper settings.

Chapter 4, **Pentium CPU Board**, presents the features of the Pentium CPU board. It explains how to upgrade to dual Pentium CPUs, adjust jumper settings, and upgrade memory and second-level cache.

Chapter 5, **Configuring the System**, shows how to use the BIOS SETUP utility to configure your system. It includes a fixed disk type table at the end for your reference.

Chapter 6, **EISA Configuration Utility**, tells how to use the ECU utility bundled with your system to configure your computer and the boards or options you add to the system.

System Housing

This chapter describes the system housing features and the additional components that can be installed. It also has instructions on installing and removing these components.

1.1 Getting Started

The preinstallation process involves the following:

- Selecting a site
- Unpacking the components
- Positioning the system
- Moving the System

1.1.1 Selecting a Site

Consider the following when selecting a site for the system:

1. Find a place that is comfortable for you. Avoid dusty areas of extreme temperature and humidity.
2. Cable paths should not run near equipment that might cause electromagnetic or frequency interference such as radio transmitters, television sets, copying machines, heaters, or air conditioners.
3. Find a location close to an electrical outlet. Avoid using extension cords.
4. Leave enough space around the system for normal air circulation.

1.1.2 Unpacking the System

Unpack the contents of the system box and the accessory box. Save the packing materials in case you need to ship the system in the future.

The system box contains the system with one 3.5-inch diskette drive, a SCSI CD-ROM drive and at least one fixed disk drive installed.

The accessory box contains the following:

- Apricot FT//ex Owner's Handbook
- Power Connection Guide
- Graphics Accelerator Card User's Guide
- System Utilities Diskette
- EISA Configuration Diskette
- SCSI Drivers Pack
- MS-DOS 6.0
- Power cord
- Keyboard
- Mouse

For your convenience, Microsoft MS-DOS is pre-installed in a small (typically 15 Mbyte) primary DOS partition on your system's first fixed disk. A DOS mouse driver, *MOUSE.SYS*, is provided as part of the pre-installation. Note that this driver is not included on the DOS installation diskettes, and should therefore be backed up as soon as possible.

1.1.3 Positioning the System

Arrange the feet of the system in such a way that the system is standing stably. Figure 1-1 shows the correct position of the feet when standing the system alone.

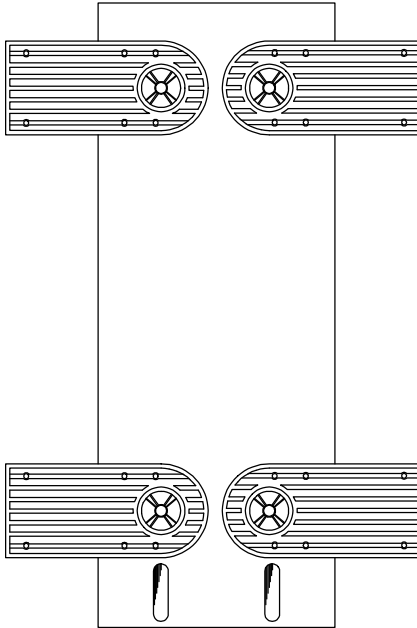

Figure 1-1 Standing the System Alone

When standing the system with the fan facing the wall, leave 5 - 10 cm space from the wall for normal air circulation, then position the feet as in Figure 1-2A.

When standing the system with the fan facing out, you can put the unit close to the wall and position the feet as in Figure 1-2B.

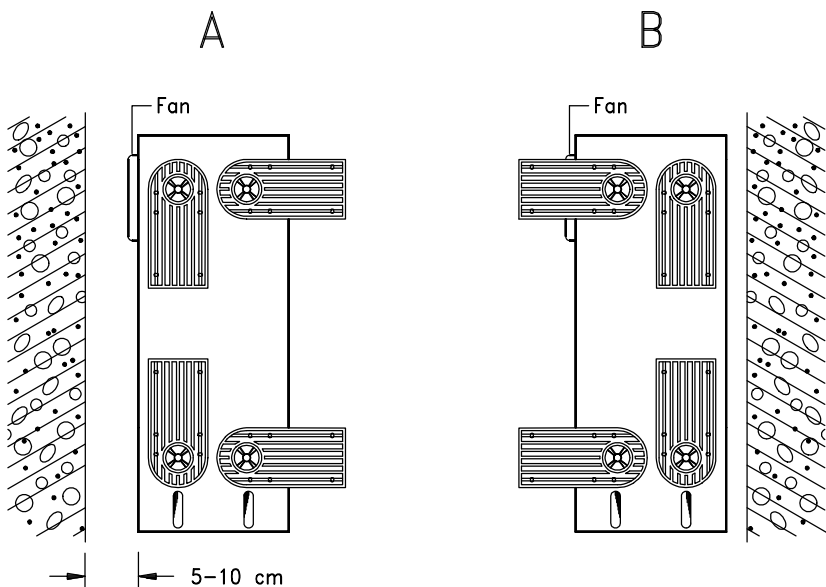

Figure 1-2 Standing the System Against a Wall

1.1.4 Moving the System

The system housing has a handle on top and two wheels at the base for easy moving.

Figure 1-3 shows how to move the system.

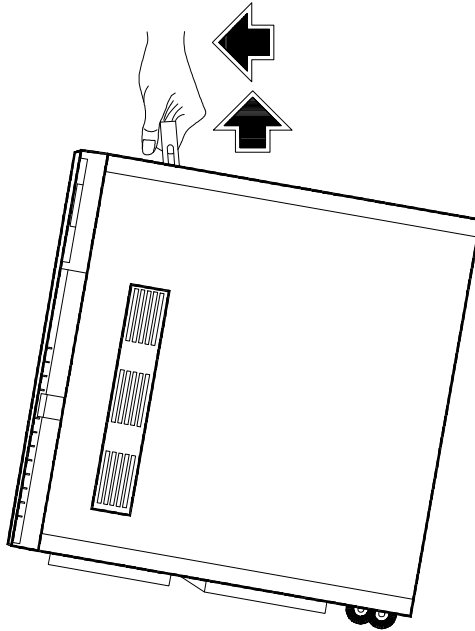
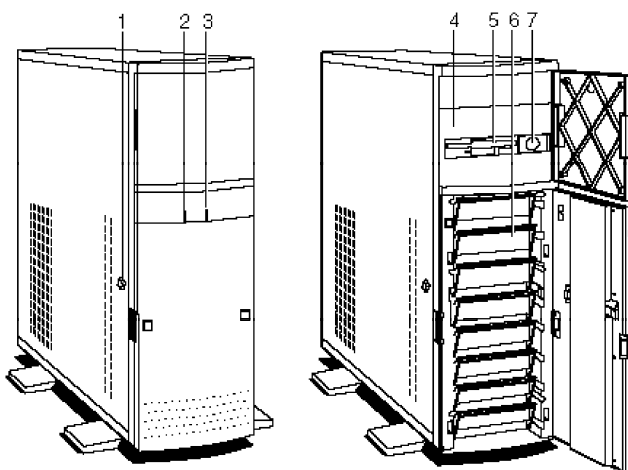

Figure 1-3 Moving the System

NOTE: *Be sure to close the feet of the system before moving it.*

1.2 Features

1.2.1 Front Panel



1. Keylock
2. Fixed Disk Drive LED
3. Power LED
4. 5.25-inch Drive Bays

5. 3.5-inch Diskette Drive
6. 3.5-inch Fixed Disk Drive Bays
7. Power Button

Figure 1-4 Front Panel

Table 1-1 Features and Functions of the Front Panel

Feature	Function
Keylock	Locks the system housing
Fixed Disk Drive LED	Indicates fixed disk drive activity
Power LED	Indicates that power is applied to the system
3.5-inch Diskette Drive	Accommodates a 3.5-inch diskette
Drive Bays	Holds the diskette drives and fixed disk drives
Power Button	Turns the system on or off

1.2.2 Rear Panel

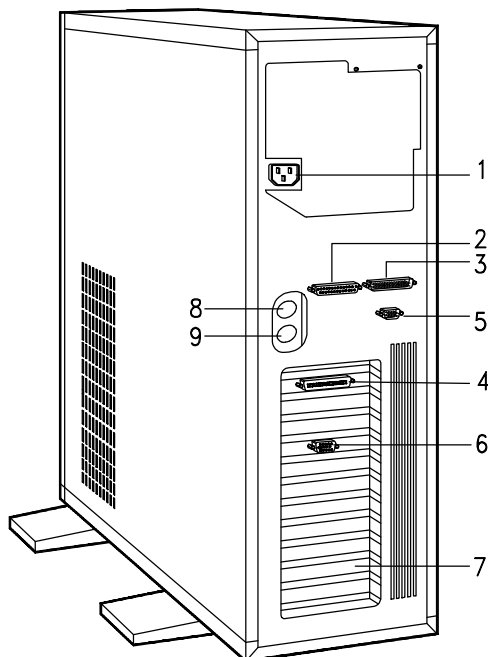

- | | |
|-------------------------|-----------------------|
| 1. Power Socket | 5. Serial Port 1 |
| 2. Parallel Port | 6. Video Port |
| 3. Serial Port 2 | 7. Expansion Slots |
| 4. SCSI Port (optional) | 8. Keyboard Connector |
| | 9. Mouse Connector |

Figure 1-5 Rear Panel

Table 1-2 Features and Functions of the Rear Panel

Feature	Function
Power Socket	Connects the power cable
Parallel Port	Connects a parallel printer
Serial Ports	Connects serial peripherals
SCSI Port (optional)	Connects peripheral devices for high-speed, parallel data transfer
Expansion Slots	For additional expansion boards
Keyboard Connector	Connects a PS/2-compatible keyboard
Mouse Connector	Connects a PS/2-compatible mouse
Video Port	Connects the video cable

1.3 Connecting the Components

CAUTION: *Make sure that the system is turned off before connecting the system components.*

Follow these steps to connect the components:

1. Plug the keyboard into the keyboard socket.

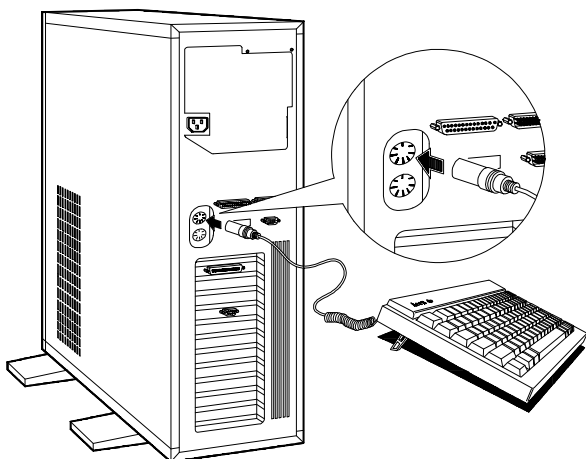

Figure 1-6 Connecting the Keyboard

2. Connect the mouse into the mouse connector.

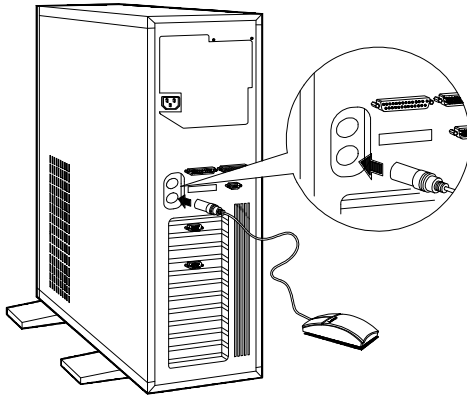

Figure 1-7 Connecting a Mouse

3. Connect the monitor cable into the video socket.

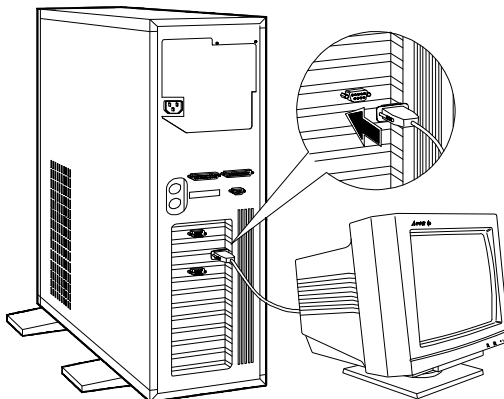

Figure 1-8 Connecting a Monitor

4. If you have a parallel printer, connect it to the parallel port.

If you have a serial printer or other serial peripherals, connect it to a serial port (Serial 1 or Serial 2).

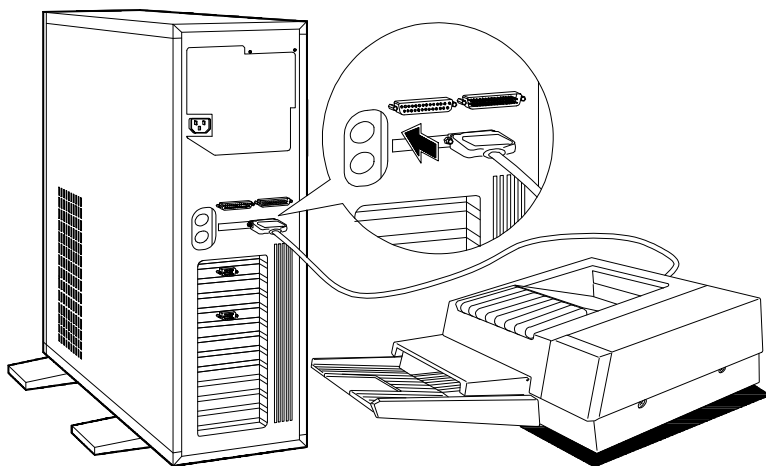

Figure 1-9 Connecting a Printer

5. Plug the female end of the power connector into the system power socket and the other end into a grounded electrical outlet.
6. Plug the monitor power cable into a grounded electrical outlet.

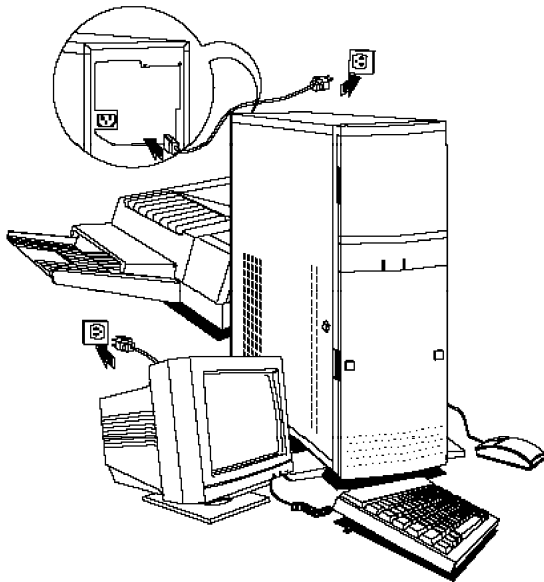

Figure 1-10 Connecting the Power Cables

1.4 Installing Options

This section tells you how to open the system housing and install additional components in the system.

1.4.1 ESD Precautions

Integrated circuits (ICs) on expansion boards are sensitive to static electricity. To avoid damaging the chips with electrostatic discharge (ESD), observe the following precautions:

1. Do not remove a board from its packaging until you are ready to install it.
2. Wear a wrist grounding strap before handling electronic components. Wrist grounding straps are available at most electronic component stores.

1.4.2 Opening the System

When you want to install disk drives and other internal components, you have to remove the front panel covers and open the system housing.

Follow these steps to open the system:

1. Turn off the system and unplug the power cable from the wall socket.
2. Open the upper front panel cover.

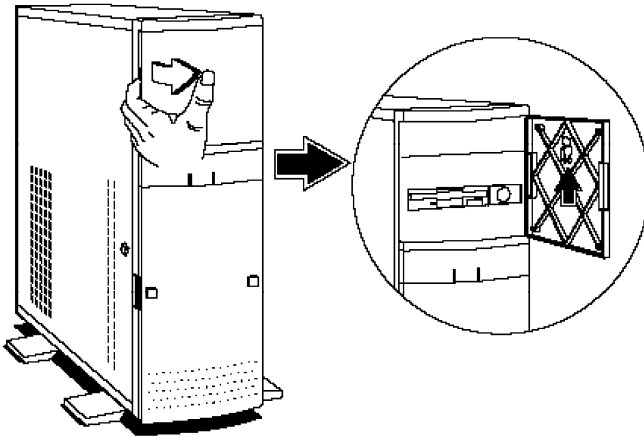

Figure 1-11 Opening the Upper Front Panel Cover

NOTE: *The front panel covers are reversible. You can also open them from the right side following the same procedure.*

3. Unlock the system housing using the key and open the lower front panel cover by pressing the button and pulling the cover.

NOTE: *You cannot open the lower front panel if the system is locked.*

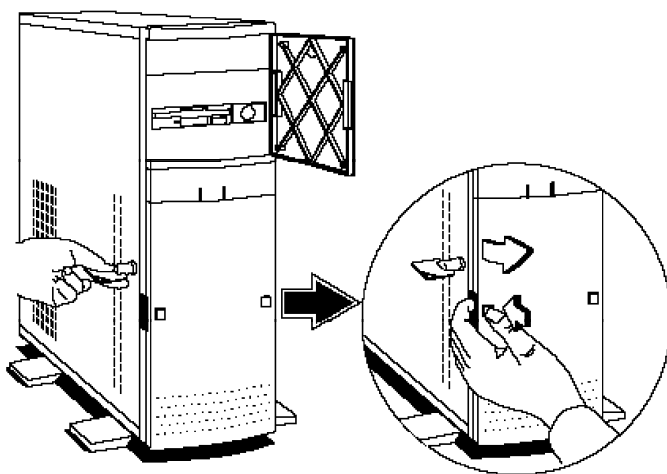

Figure 1-12 Opening the Lower Front Panel Cover

NOTE: *You cannot remove the key after you have unlocked the housing. You can remove it only when you lock the housing again.*

When installing drives in the 5.25-inch drive bays, you have to remove both the upper front panel cover and its frame.

4. To remove the front panel cover, hold it on both sides and pull.
5. To remove the upper front panel frame, press the latch under it and pull.

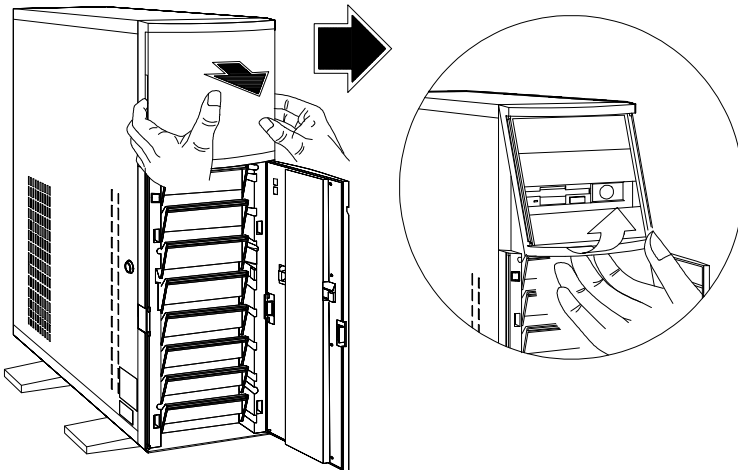

Figure 1-13 Removing the Front Panel Cover and Frame

- Pull on the key to swing the left side of the housing open.

NOTE: *If necessary, you may use a screwdriver to gently pry the side of the housing open.*

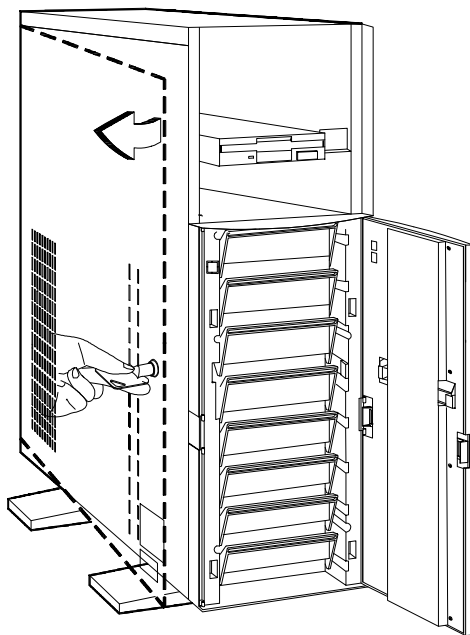
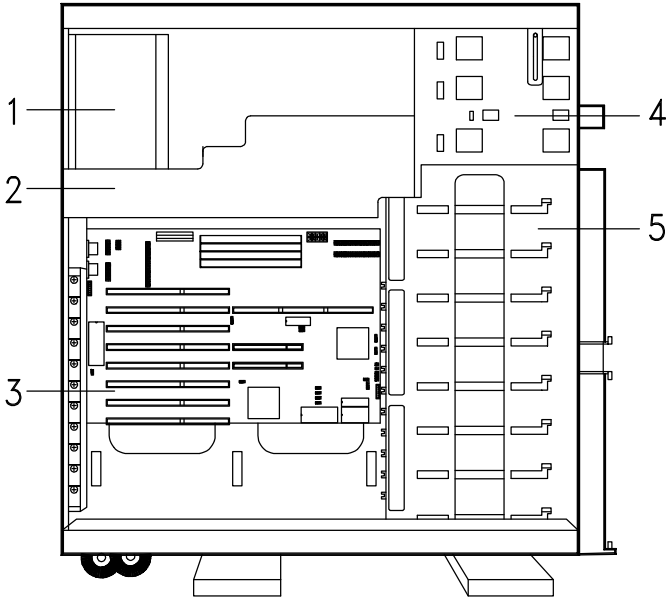

Figure 1-14 Opening the System Housing

Figure 1-15 shows the inside components.



1. *Switching Power Supply*
2. *Metal Plate (for cable clamp)*
3. *System Board*
4. *5.25-inch Drive Frame*
5. *3.5-inch Fixed Disk Drive Frame*

Figure 1-15 Inside Components

1.4.3 Installing and Removing Expansion Boards

Installing a Board

1. Study the expansion board's installation guide and configure any jumpers as directed.
2. Remove a bracket from any empty expansion slot. Save the screw to secure the new board. Keep the bracket for future use.

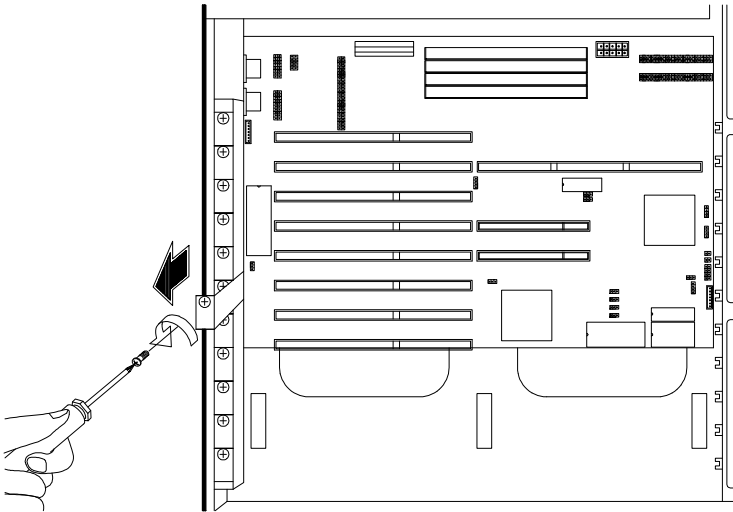

Figure 1-16 Removing a Bracket

3. Gently insert the board into the expansion slot.
Make sure that the board is properly inserted.

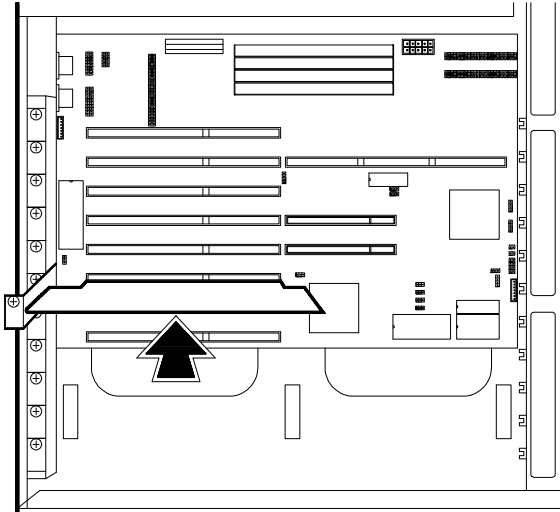

Figure 1-17 Installing a Board

4. Secure the board with the screw.

NOTE: *Do not neglect this step. The board uses the screw for grounding.*

Removing a Board

1. Unplug all cables connected to the board.
2. Remove the bracket screw and pull the board out of the slot.
3. Secure a bracket cover to the empty slot.

1.4.4 Installing Drives

You can install up to three 5.25-inch drives and one 3.5-inch drive on the upper frame, and eight externally accessible fixed disk drives on the lower frame of the system.

Installing a 5.25-inch Diskette Drive

1. Screw the drive guides on the sides of the diskette drive.

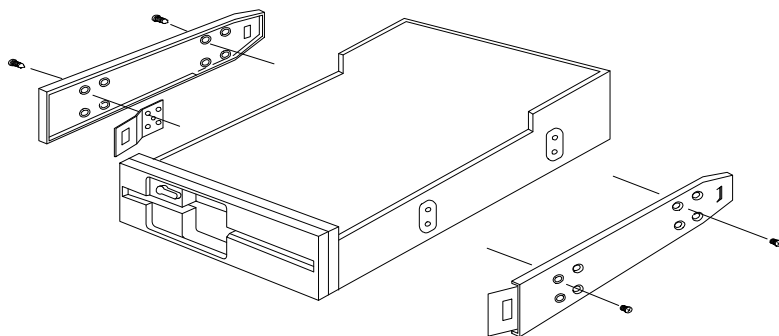

Figure 1-18 Attaching the Drive Guides

2. Insert the drive into a 5.25-inch drive bay.

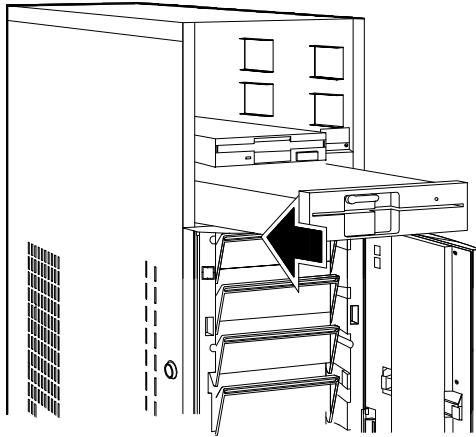

Figure 1-19 Installing a 5.25-inch Diskette Drive

3. Connect the diskette drive cables.

Removing a 5.25-inch Diskette Drive

Follow these steps to remove a 5.25-inch diskette drive:

1. Disconnect all the drive cables.
2. Press the metal tabs on the sides of the drive and pull the drive out.

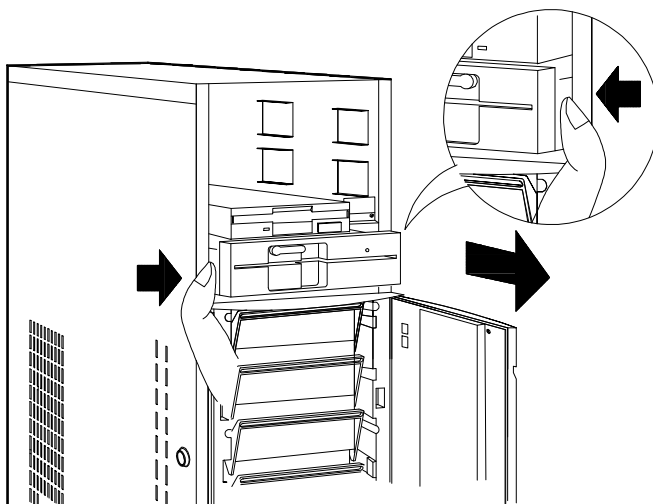

Figure 1-20 Removing a 5.25-inch Diskette Drive

Installing a Fixed Disk

NOTE: *When you purchase a fixed disk, make sure that you have all the cables necessary to install the drive. Don't forget to get the bad sector information from your dealer.*

Follow these steps to install a fixed disk:

1. Pull out a drive drawer.

NOTE: *It is better to install fixed disk drives starting from the lowest bay.*

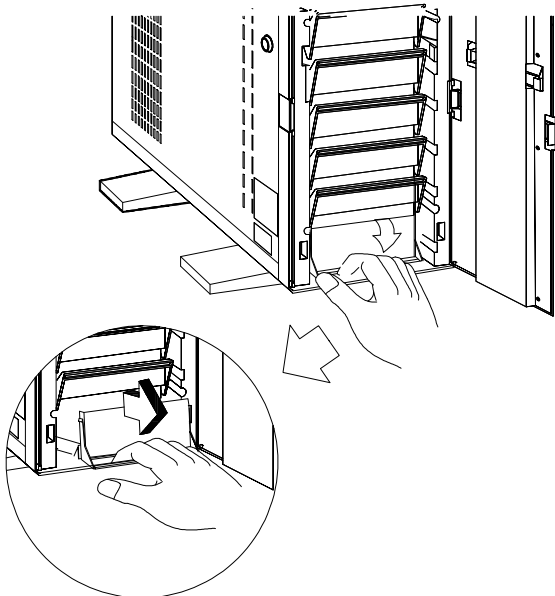

Figure 1-21 Pulling Out a Fixed Disk Drive Drawer

2. Put the fixed disk drive in the drawer and secure it with four screws under.

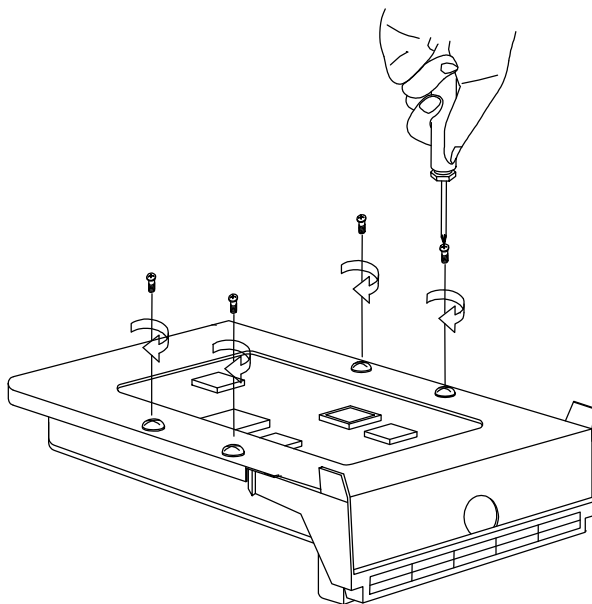

Figure 1-22 Installing a Fixed Disk Drive

3. Insert the drive drawer back to the housing.

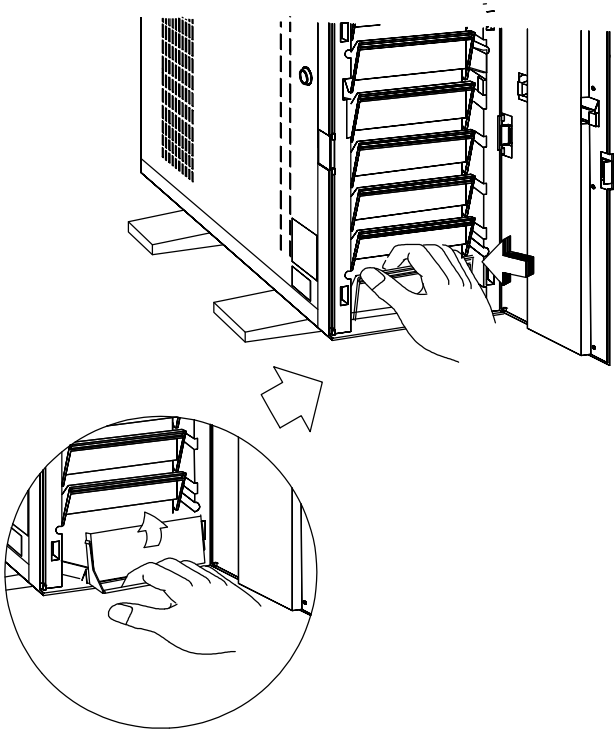

Figure 1-23 Inserting the Drive Drawer

4. Connect the fixed disk drive cables.

1.4.5 Arranging the Cables

After installing drives and connecting all the cables, clip the cables using the cable clamp attached to the metal plate between the power supply and the drive bays.

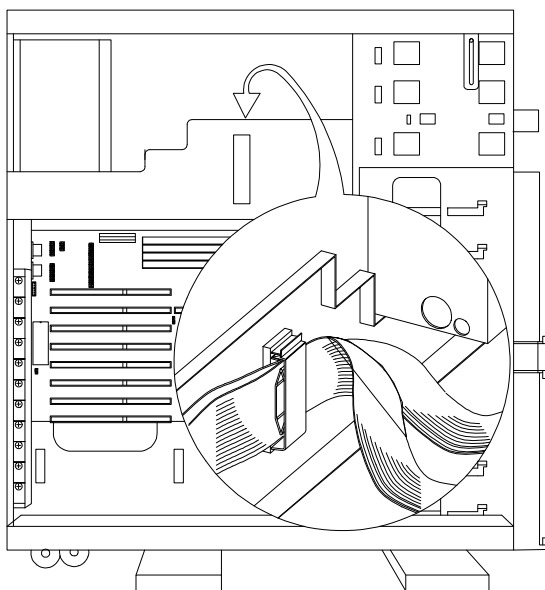

Figure 1-24 Clipping the Cables with the Cable Clamp

System Board

The system is a high-performance EISA machine designed with a 32/64-bit auto-detect and auto-switch architecture. It supports both the 486-series microprocessors and the new Pentium microprocessor, making it a long-range performance machine.

The system features the single-chip upgrade technology that makes CPU upgrades easy and economical, and the multiple CPU upgrade technology that can turn it into a multiprocessor system. It is fully compatible with the IBM PC/AT and is suitable for use as a multiuser file server, LAN file server or a CAD/CAE/CAM workstation.

The system board holds the 128-KB system ROM, eight 32-bit EISA expansion slots, two VESA local bus slots, a CPU board slot, four 72-pin DRAM banks, and two SCSI connectors (for SCSI models).

Standard features such as two serial ports, one parallel port, diskette drive interface, and embedded fixed disk drive interface also reside on the system board.

The system has 8-MB base memory and supports a maximum memory of 256 MB using 64-MB single-density SIMMs. When using the Pentium CPU board, the system supports up to 256-MB using 32-MB double-density SIMMs.

A graphics accelerator card can be used on the system high-speed 32-bit local bus to enhance video display capabilities.

2.1 Major Components

The system board has the following major components:

- Four 72-pin SIMM sockets labeled Bank 0 ~ Bank 3
- DRAM controller with page/faster page mode and burst read capability
- One CPU board slot
- Eight 32-bit EISA expansion slots supporting master/slave add-on cards
- Two VESA local bus slots supporting master/slave add-on cards
- Real-time clock and battery that lasts for approximately 5-7 years
- 128-KB Flash memory
- On-board Fast SCSI-2 host adapter
- 350-watt switching power supply

Figure 2-1 shows the system board layout and the location of the major components on the system board.

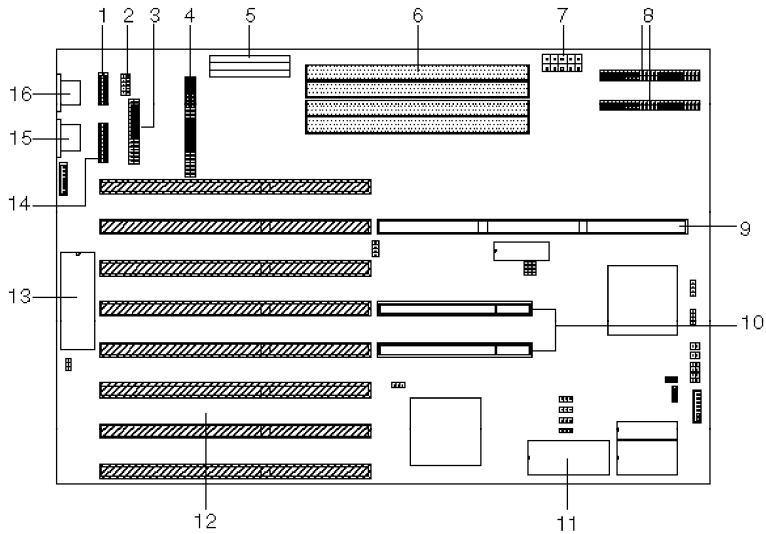

- | | | | |
|---|----------------------------|----|-------------------------|
| 1 | Serial 2 | 9 | CPU Board Slot |
| 2 | Serial 1 | 10 | VESA Local Bus Slots |
| 3 | Diskette Drive Connector | 11 | BIOS |
| 4 | Fixed Disk Drive Connector | 12 | EISA Slots |
| 5 | Power Connector 1 | 13 | Keyboard Controller |
| 6 | SIMM Sockets | 14 | PS/2 Mouse Connector |
| 7 | Power Connector 2 | 15 | PS/2 Keyboard Connector |
| 8 | SCSI Connectors | 16 | Parallel Port |

Figure 2-1 System Board Layout

2.2 Upgrading the Memory

The system comes with a standard 8-MB memory. You can upgrade the system memory by adding memory modules (SIMMs) into the SIMM sockets or by changing the SIMMs for higher memory configuration. The system supports three types of single-density SIMMs: 4-MB, 16-MB, and 64-MB.

NOTE: *On models using the Pentium CPU board, you can use only another four 72-pin SIMM sockets. See Chapter 4.*

Table 2-1 Memory Configurations

Bank0	Bank1	Bank2	Bank3	Total
4 MB				4 MB
4 MB	4 MB			8 MB
4 MB	4 MB	4 MB		12 MB
4 MB	4 MB	4 MB	4 MB	16 MB
16 MB				16 MB
4 MB	16 MB			20 MB
4 MB	4 MB	16 MB		24 MB
4 MB	16 MB	4 MB		24 MB
4 MB	4 MB	16 MB	4 MB	28 MB
4 MB	16 MB	4 MB	4 MB	28 MB
16 MB	16 MB			32 MB
4 MB	16 MB	16 MB		36 MB
16 MB	16 MB	4 MB		36 MB
4 MB	16 MB	16 MB	16 MB	52 MB
16 MB	16 MB	16 MB	4 MB	52 MB
16 MB	16 MB	16 MB	16 MB	64 MB
64 MB				64 MB
4 MB	4 MB	64 MB		72 MB
16 MB	64 MB			80 MB
4 MB	16 MB	64 MB		84 MB

Table 2-1 Memory Configurations (continued)

Bank0	Bank1	Bank2	Bank3	Total
16 MB	64 MB	4 MB		84 MB
4 MB	4 MB	16 MB	64 MB	88 MB
16 MB	64 MB	4 MB	4 MB	88 MB
16 MB	16 MB	64 MB		96 MB
16 MB	64 MB	16 MB		96 MB
4 MB	16 MB	16 MB	64 MB	100 MB
16 MB	64 MB	16 MB	4 MB	100 MB
16 MB	16 MB	16 MB	64 MB	112 MB
16 MB	64 MB	16 MB	16 MB	112 MB
64 MB	64 MB			128 MB
64 MB	64 MB	4 MB		132 MB
4 MB	4 MB	64 MB	64 MB	136 MB
64 MB	64 MB	4 MB	4 MB	136 MB
16 MB	64 MB	64 MB		144 MB
64 MB	64 MB	16 MB		144 MB
4 MB	16 MB	64 MB	64 MB	148 MB
64 MB	64 MB	16 MB	4 MB	148 MB
16 MB	16 MB	64 MB	64 MB	160 MB
16 MB	64 MB	16 MB	64 MB	160 MB
64 MB	64 MB	16 MB	16 MB	160 MB
64 MB	64 MB	64 MB		192 MB
16 MB	64 MB	64 MB	64 MB	208 MB
64 MB	64 MB	16 MB	64 MB	208 MB
64 MB	64 MB	64 MB	64 MB	256 MB

WARNING! Do not attempt the procedures described in this section unless you are a qualified service technician.

CAUTION: 1. Read and follow the electrostatic discharge (ESD) precautions in Chapter 1 before installing SIMMs.

2. *Be careful when inserting or removing SIMMs. Forcing a SIMM in or out of a socket can damage the socket.*

2.2.1 Installing SIMMs

1. Slip a SIMM at a 45° angle into a socket with the component side facing down.

NOTE: *Always install SIMMs from Bank 0.*

2. Gently press the SIMM up until the pegs of the socket slip into the holes on the SIMM and the holding clips lock the SIMM into position.

NOTE: *The SIMM should be at 90° angle when installed.*

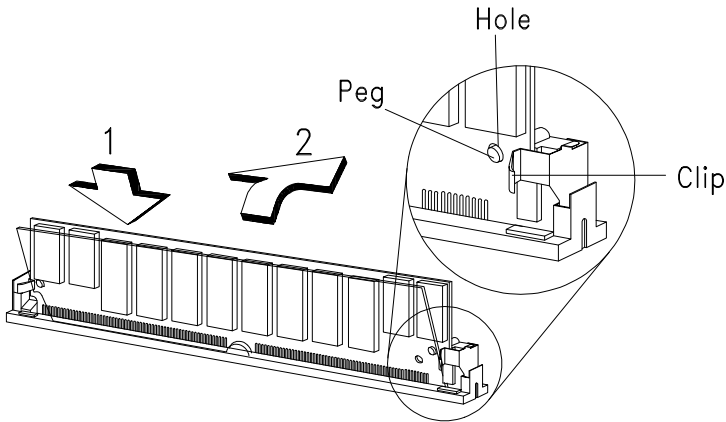

Figure 2-2 Installing a SIMM

2.2.2 Removing SIMMs

Follow these steps when removing SIMMs:

1. Press the holding clips on both sides of the SIMM outward to release it.
2. Press the SIMM downwards at about 45° angle.
3. Pull the SIMM out of the socket.

NOTE: *Always remove the SIMM from the highest bank first.*

2.2.3 Reconfiguring the System

Reconfigure the system after installing or removing SIMMs.

Follow these steps to reconfigure the system:

1. Reboot the system. A memory error message appears, indicating that the total memory does not match the value stored in CMOS.
2. Press Ctrl-Alt-Esc to run Setup.
A warning message indicating a wrong memory configuration appears.
3. Press Esc twice to exit Setup and reboot the system.

The system boots with the new memory configuration.

2.3 Upgrading the CPU

The system has a separate board that contains the CPU and the second-level cache. The single-chip upgrade technology gives you the flexibility to upgrade the CPU by just plugging in a higher 486 CPU chip, and changing a few jumper settings on the system board and on the CPU board.

The system also supports the Pentium CPU. And since this machine is designed as a multiprocessor system, you can install a second Pentium processor into the upgrade socket of the Pentium CPU board.

NOTE: *When upgrading to the Pentium CPU, you have to replace the 486 CPU board with the Pentium CPU board.*

The upgrade CPU or CPU board comes with its corresponding manual. Refer to Chapters 3 and 4 for detailed instructions on upgrading the CPU.

2.4 SCSI Feature

The system board features a single-chip Fast SCSI-2 host adapter that adds SCSI I/O capability to the system. The device consists of all the components found on the state-of-the-art SCSI host adapters such as an onboard microcontroller, bus master interface controller, and SCSI controllers. In EISA mode, this device can transfer at a full 33 MB/second burst transfer rate.

2.4.1 Using SCSI

There are four points to remember when using the SCSI feature of your system.

1. Open jumpers JP1 and JP2.
2. Set jumper JP8 to pins 2-3 to select IRQ11. Refer to the list of jumpers at the end of this chapter.

NOTE: *In this system, you can select only IRQ10 or IRQ11. For best system performance, use IRQ11.*

3. Use the SCSI connector CN1 before CN3.
CN3 does not work if CN1 is not used.
4. When installing the SCSI drivers in the EISA Configuration Utility (ECU), the option “Extended translation for device > 1 GByte” under BIOS Configuration, should be set to Enable for fixed disks with greater than 1 Gbyte capacity in DOS environment. Set it to Disable for other software environments.

NOTE: *Refer to the SCSI manual for more information.*

2.5 Jumper Settings

You have to change jumper settings on the system board when you upgrade the CPU or when you want to reconfigure the system.

Follow these steps to change a jumper setting:

1. Pull out the jumper cap from the jumper.
2. Position the jumper cap over the two pins for the desired setting.
3. Gently press the cap onto the pins.

Figure 2-3 shows the locations of the jumpers on the system board.

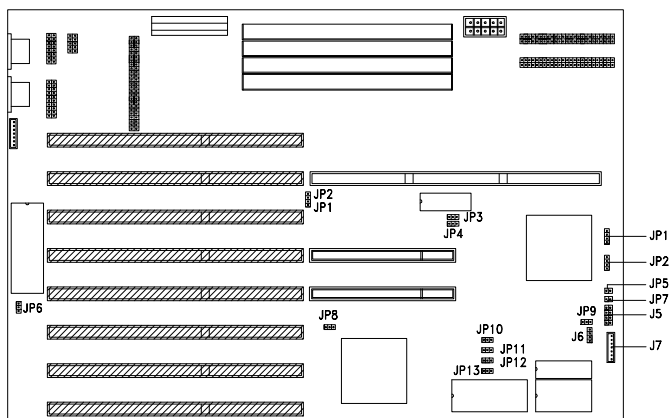

Figure 2-3 System Board Jumper Settings

Table 2-2 lists the system board jumpers and their corresponding settings.

Table 2-2 System Board Jumper Settings

Jumper	Settings	Function
High Speed Write for Local Bus JP3	1-2' 2-3	0 min. wait 1 min. wait
CPU Speed Select for VESA Local Bus JP4	1-2' 2-3	<=33 MHz > 33 MHz
Security Enable/Disable JP6	1-2 2-3'	Security enable Security disable
Reset Button Enable JP7	Closed' Open	Reset Enable Reset Disable
IRQ Select JP8	1-2 2-3'	IRQ 10 IRQ 11
Buzzer/Speaker Select JP9	1-2' 2-3	Onboard Buzzer External Speaker

2.6 Error Messages

Whenever you receive an error message of any type, do not continue using the computer. Note the message and take corrective action. This section describes the different types of error messages and corresponding corrective measures.

There are two general types of error messages:

- Software
- System

2.6.1 Software Error Messages

Software messages are returned by your operating system or application. These messages typically occur after you boot the operating system or when you run your application programs. If you receive this type of message, consult your application or operating system manual for help.

2.6.2 System Error Messages

A system error message indicates a problem with the computer itself. It normally appears during the power-on self-test, before the operating system prompt appears. Table 2-3 lists the system error messages.

Table 2-3 System Error Messages

Error Message	Corrective Action
Bad CMOS Battery	Replace the battery. Contact your dealer.
CMOS Checksum Error	Rerun the Setup program.
Equipment Configuration Error	Rerun the Setup program.

Table 2-3 System Error Messages (continued)

Error Message	Corrective Action
Diskette Drive Error	Diskette may be bad. If not, replace the diskette drive.
Diskette Drive Controller Error	Check and connect the control cable to the diskette drive or controller.
DRAM Configuration Error	Modify DRAM configuration to agree with one of the options in Table 2-1.
Fixed Disk Controller Error	Check and connect the control cable to the fixed disk drive or controller.
Fixed Disk 0 Error	Check all cable connections. Replace fixed disk.
Fixed Disk 1 Error	Check all cable connections. Replace fixed disk.
Fixed Disk 0 Extended Type Error	Rerun the Setup program.
Fixed Disk 1 Extended Type Error	Rerun the Setup program.
Keyboard Error	Check and connect the keyboard to the system unit.
Keyboard Interface Error	Contact your dealer.
Keyboard Locked	Unlock the keyboard.
I/O Parity Error	Contact your dealer.

Table 2-3 System Error Messages (continued)

Error Message	Corrective Action
Memory Error	Check SIMMs on the system board. Contact your dealer.
Memory Size Mismatch	Rerun Setup.
Pointing Device Error	Check and connect pointing device.
Pointing Device Interface Error	Contact your dealer.
Press F1 key to continue or Ctrl-Alt-Esc for Setup	Press F1 or Ctrl-Alt-Esc.
Press F1 to Setup or other key to continue	Press F1 and reconfigure the system.
Press Esc to turn off NMI, any other key to reboot	Press Esc to disregard NMI error. Press any other key to reboot the system.
Protected Mode Test Fail	Contact your dealer.
RAM BIOS Error	Contact your dealer.
RAM Parity Error	Check SIMMs on system board or contact your dealer.
Real Time Clock Error	Rerun Setup.
Shadow RAM Fail	Contact your dealer.
System Memory Address Error	Check SIMMs on system board or contact your dealer.

2.6.3 Correcting Error Conditions

As a general rule, if an error message says “Press F1 to continue,” it is caused by a configuration problem, which can be easily corrected. An equipment malfunction is more likely to cause a so-called fatal error, i.e., an error that causes complete system failure.

Here are some corrective actions for error messages:

1. Run Setup. You must know the correct configuration values for your system before you enter Setup, which is why you should write them down when the system is correctly configured. An incorrect Setup configuration is a major cause of power-on error messages, especially for a new system.
2. Remove the system unit cover, following the directions in Chapter 1. Check that the jumpers on the system board and any expansion boards are set correctly.
3. If you cannot access a new disk, it may be because your disk is not physically formatted. Physically format the disk first using the FDISK and FORMAT commands.
4. Check that all connectors and boards are securely plugged in. Review the sections in Chapter 1 for assistance.

If you go through the corrective steps above and still receive an error message, the cause may be an equipment malfunction.

If you are sure that your configuration values are correct and your battery is in good condition, the problem may lie in a damaged or defective chip.

In both cases, contact an authorized service centre for assistance.

2.7 Address Maps and Interrupt Table

2.7.1 System Memory Map

Table 2-4 System Memory Map

Address	Name	Function
00000000 ~ 0009FFFF	640 KB System Memory	Onboard DRAM
000A0000 ~ 000BFFFF	128 KB Video RAM	Reserved for Graphics Display Buffer (non-cacheable)
000C0000 ~ 000CFFFF	64-KB I/O Expansion ROM	Reserved for ROM on I/O Adapters
00D0000 ~ 00D3FFF	16-KB for SCSI BIOS	Reserved for SCSI BIOS
00D4000 ~ 00D7FFF	16-KB I/O Expansion ROM	Reserved for ROM on I/O Adapters
00D8000 ~ 00DBFFF	16-KB for SCSI BIOS	Reserved for SCSI BIOS
00DC000 ~ 00DFFFF	16-KB I/O Expansion ROM	Reserved for ROM on I/O Adapters
00E0000 ~ 00E7FFF	32 KB	Reserved for Extended System BIOS
00E8000 ~ 00EFFFF	32 KB	Reserved for Extended System BIOS

Table 2-4 System Memory Map (continued)

Address	Name	Function
00F0000 ~ 00FFFFFF	64 KB BIOS	System ROM BIOS (ROM) System RAM BIOS
0100000 ~ 0F9FFFFFF	System Memory	Onboard DRAM
0FA0000 ~ 0FFFFFF	384 KB I/O Card Memory	Reserved for Memory Map I/O Card (Non-cacheable)
1000000 ~ FFFFFFF	System Memory	Onboard RAM

2.7.2 I/O Address Map

Table 2-5 System I/O Address Map

Address Range (hex)	Device
000 ~ 01F	DMA Controller-1, 8273
020 ~ 027	Interrupt Controller-1, 8259
030 ~ 037	Interrupt Controller-1, 8259
040 ~ 047	System Timer (8254-1)
050 ~ 057	System Timer (8254-1)
060 ~ 06F	Keyboard Controller 8742
070 ~ 07F	Real-Time Clock, NMI Mask
080 ~ 09F	DMA Page Register 74LS612 Speed Status Register
0A0 ~ 0BF	Interrupt Controller-2, 8259
0C0 ~ 0DF	DMA Controller-2, 8237
0F0	Clear Math Coprocessor BUSY
0F1	Reset Coprocessor
0F8 ~ 0FF	Math Coprocessor
800 ~ 8FF	NV RAM Address

Table 2-5 System I/O Address Map (continued)

Address Range (hex)	Device
`C80 ~ C83	EISA Product System ID
`CFB	NV RAM Page Address (New Mode)
`4F0	SCSI Address, CPU and Memory Type Select 8K or 9K SRAM (in separate mode) Flash ROM Programming IRQ12 Enable, 3.5" Diskette 3 Mode Select
1F0 ~ 1F7	Fixed Disk
278 ~ 27F	Parallel Port 2
2F8 ~ 2FF	Serial Port 2
378 ~ 37F	Parallel Port 1
3B0 ~ 3BF	Monochrome Display
3C0 ~ 3CF	EGA, VGA, SVGA
3D0 ~ 3DF	CGA, VGA, SVGA
3F0 ~ 3F7	Floppy Disk Controller
3F7 ~ 3FF	Serial Port 1

2.7.3 Interrupt Levels

Table 2-6 *Interrupt Requests Used*

Interrupt	Interrupt Source
IRQ0	Timer Output 1
IRQ1	Keyboard
IRQ3	Serial Port 2
IRQ4	Serial Port 1
IRQ6	Floppy Disk
IRQ7	Printer Port
IRQ8	Real-Time Clock
IRQ12	PS/2 Mouse
IRQ13	Numeric Processor
IRQ14	Embedded Hard Disk

486 CPU Board

The 486 CPU board supports several 486 CPU types such as:

- 486SX/33
- 486DX/33
- 486DX/50
- 486DX2/50
- 486DX2/66
- P24T (Pentium Upgrade)

You can easily upgrade the CPU using single-chip upgrade technology. This means you only have to remove the old CPU, plug in the new one, and change a few jumper settings.

The 486 CPU board also carries a standard 256-KB second-level cache memory expandable to a maximum of 1 MB.

WARNING! *Do not attempt to make any hardware changes in your system if you are not a qualified technician. Ask your dealer for assistance.*

Figure 3-1 shows the CPU board layout.

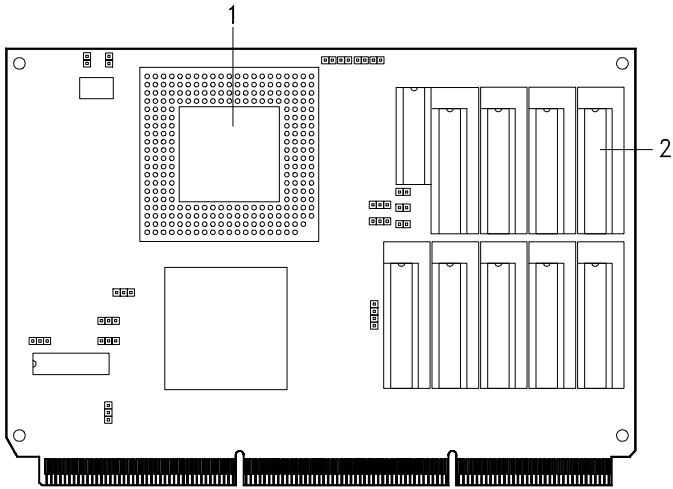

- 1 486 CPU Socket
- 2 Second-level Cache

Figure 3-1 486 CPU Board Layout

3.1 Upgrading the CPU

This section gives instructions for upgrading the CPU.

NOTE: *Read the electrostatic discharge (ESD) precautions in Chapter 1 before unpacking and installing the upgrade CPU.*

3.1.1 Installing the Upgrade CPU

Follow these steps to install the upgrade CPU:

1. Turn off the system and unplug the power cable from the wall socket.
2. Detach the CPU board from the system board.
3. Detach the heat sink by removing the clip and the four screws securing it to the CPU board.

The heat sink is a platform that protects the upgrade CPU from excessive heat.

4. Locate the CPU socket and remove the CPU installed in it.
5. Plug-in the upgrade CPU into the socket.

NOTE: *Make sure that pin 1 of the CPU corresponds to pin 1 of the socket. Insert the CPU pins into the socket pinholes gently but firmly. Be careful not to bend any pins.*

6. Change the appropriate jumper settings on the 486 CPU board. Refer to section 3.3 for the jumper settings.
7. Re-attach the heat sink to the board with the four screws and the clip.
8. Change the appropriate jumper settings on the system board. Refer to section 2.5 for the jumper settings.
9. Re-install the CPU board to the system board.
10. Reconnect the cables.

NOTE: *If you are upgrading to Pentium CPU, you have to change the 486 CPU board with a Pentium CPU board. Read the manual that comes with the Pentium CPU board for more information.*

3.2 Upgrading the Second-Level Cache

The 486 CPU board has a standard 256 KB of cache memory expandable to 1 MB. The cache memory is a high-speed buffer between the main memory and the CPU. It stores frequently-used instructions and data, greatly reducing the CPU memory access time and ultimately improves system performance.

NOTE: *Read the electrostatic discharge (ESD) precautions in Chapter 1 before handling chips.*

Follow these steps to upgrade the second-level cache:

1. Turn off the system and unplug the power cable from the wall socket.
2. Detach the CPU board from the system board.
3. Detach the heat sink by removing the clip and the four screws securing it to the CPU board.
4. Remove the original SRAM chips.
5. Carefully insert the new SRAM chips on the sockets. Be careful not to bend any pins.
6. Change the appropriate jumper settings. Refer to Table 3-2 for the settings.
7. Re-attach the heat sink to the board with the four screws and the clip.
8. Re-install the CPU board to the system board and connect the appropriate cables.

Table 3-1 lists the second-level cache upgrade options.

Table 3-1 Second-level Cache Upgrade (486 CPU Board)

Cache Size	SRAM	Tag RAM	Dirty RAM
64 KB	8K*8 x 8	8K*8 x 1	16K*1 x 1
128 KB	32K*8 x 4	8K*8 x 1	16K*1 x 1
256 KB	32K*8 x 8	32K*8 x 1	64K*1 x 1
1 MB	128K*8 x 8	128K*8 x 1	64K*1 x 1

3.3 Jumper Settings

You have to change some jumper settings on the CPU board when you upgrade the CPU.

Figure 3-2 shows the jumper locations on the 486 CPU board.

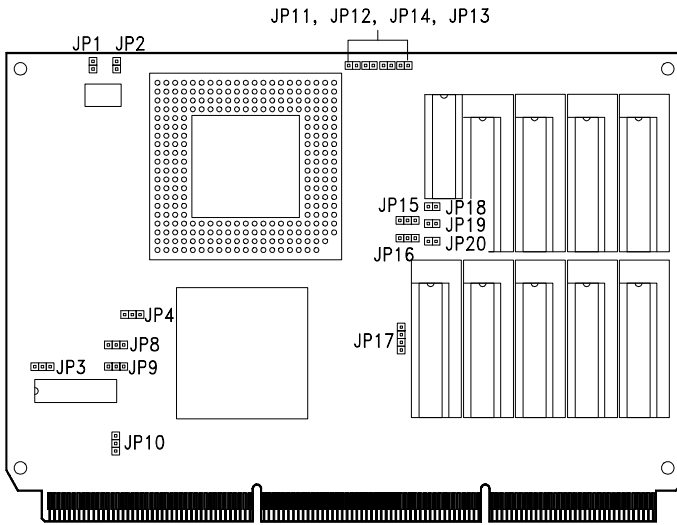

Figure 3-2 486 CPU Board Jumper Locations

Table 3-2 lists the jumpers on the 486 CPU board and their corresponding settings.

Table 3-2 486 CPU Board Jumper Settings

Jumper	Settings	Function
CPU Clock Frequency Setting		
JP1	Open	25 MHz (DX2-50) 33 MHz (DX2-66)
	Closed	40 MHz 50 MHz
JP2	Open	25 MHz (DX2-50) 40 MHz
	Closed	33 MHz (DX2-66) 50 MHz
PGA CPU Type Setting		
JP4	Open	486DX, 486DX2
	1-2	486SX
	2-3	487SX, ODP 486SX, P24T
LADS Setting for VESA Local Bus (Master Support)		
JP3	1-2	33 MHz
	2-3	50 MHz
Local Bus Enabling		
JP10	1-2	Disable
	2-3*	Enable
System Speed		
JP8	1-2	25 MHz, 33 MHz
	2-3	40 MHz, 50 MHz
JP9	1-2	25 MHz, 40 MHz
	2-3	33 MHz, 50 MHz

Table 3-2 486 CPU Board Jumper Settings (continued)

Jumper	Settings	Function
SRAM (Cache) Size JP11, JP19	Open Closed	64 KB 128 KB, 256 KB, 1 MB
JP12, JP20	Open Closed	64 KB, 128 KB 256 KB, 1 MB
JP13, JP14, JP18	Open Closed	64 KB, 128 KB, 256 KB 1 MB
SRAM (Cache) Size JP15, JP16	1-2 2-3	When using a single bank (128 KB) When using double banks (64 KB, 256 KB, 1 MB)

Pentium CPU Board

The Pentium CPU board contains the Pentium CPU, 512-KB second-level cache expandable to 1 MB, four 72-pin SIMM sockets, and another socket for a second Pentium CPU.

A system with a Pentium CPU Board can easily be upgraded to a multiprocessor system. To upgrade to two Pentium CPUs, simply install the second CPU into the upgrade socket.

When you upgrade to a higher speed Pentium CPU, you have to change the oscillator with a higher speed also.

WARNING! *Do not attempt to make any hardware changes in your system if you are not a qualified technician. Ask your dealer for assistance.*

Figure 4-1 shows the Pentium CPU board layout.

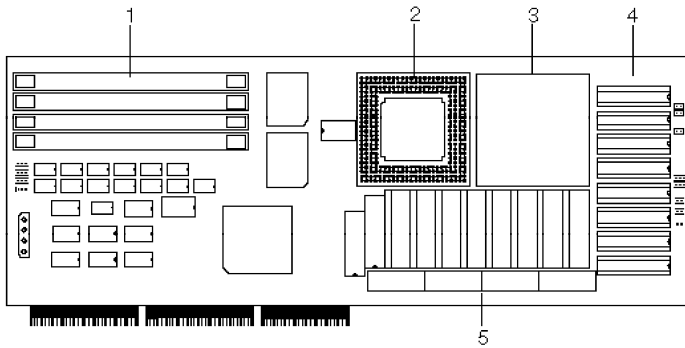

- 1 SIMM Sockets
- 2 Second Pentium CPU Socket
- 3 Pentium CPU
- 4 Upgrade SRAM Sockets
- 5 SRAM

Figure 4-1 Pentium CPU Board Layout

4.1 Upgrading to Dual CPUs

You can increase the system computing power by installing a second Pentium CPU into the upgrade socket on the Pentium CPU board.

NOTE: *Read the electrostatic discharge (ESD) precautions in Chapter 1 before unpacking and installing the upgrade CPU.*

4.1.1 Installing the Second CPU

Follow these steps to install the second Pentium CPU:

1. Turn off the system and unplug the power cable from the wall socket.
2. Detach the Pentium CPU board from the system board.
3. Detach the heat sink by removing the clip and the four screws securing it to the CPU board. (You do not need to remove the fan from the heat sink.)
4. Locate the second CPU socket and plug-in the new CPU.

NOTE: *Make sure that pin 1 of the CPU corresponds to pin 1 of the socket. Insert the CPU pins into the socket pinholes gently but firmly. Be careful not to bend any pins.*

5. Re-attach the heat sink to the board with the four screws and the clip.
6. Re-install the CPU board to the system board.
7. Reconnect the cables.
8. Reconfigure the system using the EISA Configuration Utility (ECU). Refer to Chapter 6 for details.

4.2 Upgrading the Second-Level Cache

The Pentium CPU board has a standard 512 KB of cache memory expandable to 1 MB.

NOTE: *Read the electrostatic discharge (ESD) precautions in Chapter 1 before handling chips.*

Follow these steps to upgrade the second-level cache:

1. Turn off the system and unplug the power cable from the wall socket.
2. Detach the CPU board from the system board.
3. Detach the heat sink by removing the clip and the four screws securing it to the CPU board. (You do not need to remove the fan from the heat sink.)
4. Remove the original SRAM chips.
5. Carefully insert the new SRAM chips on the sockets. Be careful not to bend any pins.
6. Change the appropriate jumper settings. Refer to Table 4-3 for the settings.
7. Re-attach the heat sink to the board with the four screws and the clip.
8. Re-install the CPU board to the system board and connect the appropriate cables.

Table 4-1 Second-level Cache Upgrade (Pentium CPU Board)

	SRAM Cache Size (15 ns)	Tag RAM (12 ns)	Dirty RAM (12 ns)
512 KB	32K*8 x 16	32K*8 x 1	16K*1 x 1
1 MB	128K*8 x 8	32K*8 x 1	64K*1 x 1

4.3 Upgrading the Memory

The Pentium CPU board has four 72-pin SIMM sockets that support up to 256-MB RAM using 4-MB, 8-MB, 16-MB, and 32-MB SIMMs.

With the additional four SIMM sockets, the system has a total of eight sockets for a maximum memory upgrade of 256 MB in 256 combinations.

NOTE: *You have to use the same type of SIMMs in each bank.*

You have to run Setup after installing additional memory.

The memory bank configuration of the system board changes when you are using the Pentium CPU board. Instead of one SIMM socket being one bank, two sockets are counted as one bank, as follows:

Memory Banks

System Board

Sockets 0 and 1	Bank 0
Sockets 2 and 3	Bank 1

Pentium CPU Board

Sockets 0 and 1	Bank 2
Sockets 2 and 3	Bank 3

You can upgrade the system memory using **any** combination of the SIMMs supported by the system.

Table 4-2 lists some examples of available memory configurations.

Table 4-2 Memory Configurations

System Board		Pentium CPU Board				Total	
Bank0	Bank1	Bank2	Bank3	Bank2	Bank3		
4MB	4MB					8MB	
4MB	4MB	8MB	8MB			24MB	
4MB	4MB	8MB	8MB	16MB	16MB	56MB	
4MB	4MB	8MB	8MB	16MB	16MB	32MB 32MB	120MB
4MB	4MB	4MB	4MB	4MB	4MB	4MB 4MB	32MB
8MB	8MB	8MB	8MB	8MB	8MB	8MB 8MB	64MB
16MB	16MB	16MB	16MB	16MB	16MB	16MB 16MB	128MB
32MB	32MB	32MB	32MB	32MB	32MB	32MB 32MB	256MB

4.4 Jumper Settings

You have to change some jumper settings on the CPU board when you install a second CPU.

Figure 4-2 shows the jumpers on the Pentium CPU board and their locations.

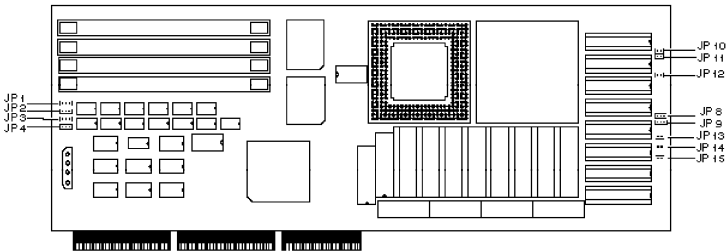

Figure 4-2 Pentium CPU Board Jumper Locations

Table 4-3 lists the jumpers on the Pentium CPU board and their corresponding settings.

Table 4-3 Pentium CPU Board Jumper Settings

Jumper	Settings	Function
Local Bus JP4	1-2* 2-3	Enable Disable
SRAM (Cache) Type JP8	1-2 2-3	When using a single bank When using double banks
JP9	1-2 2-3	When using a single bank When using double banks
SRAM (Cache) Size JP10, JP13	Open Closed	128 KB 256 KB, 512 KB, 1 MB
JP11, JP14	Open Closed	128 KB, 256 KB 512 KB, 1 MB
JP12, JP15	Open Closed	128 KB, 256 KB, 512 KB 1 MB

* Default Setting

Configuring the System

Most systems are already configured by the manufacturer or dealer. There is no need to run Setup when starting the computer unless you get a "Run Setup" message.

The Setup program loads configuration values into the battery-backed, nonvolatile memory called CMOS RAM. This memory area is not part of the system RAM.

NOTE: *If you repeatedly receive "Run Setup" error messages, check the computer's internal battery. If the battery is dead or not properly connected, the system cannot retain configuration values in CMOS RAM.*

You can access the Setup configuration values by pressing Ctrl-Alt-Esc.

Before running Setup, have the following information ready:

- Diskette drive type. The standard system diskette drive type is 1.44 MB.
- Fixed disk drive type. To determine your drive type, compare the information on the label pasted to your fixed disk (or supplied in vendor documentation) with the disk types listed in at the end of this chapter.

The values in the System Configuration are the basic hardware settings of your system. You have to change some of them if you add or remove any system component.

CAUTION: *Close all open files and leave your application program before entering Setup. You cannot exit back into an application. The system automatically reboots when you leave Setup.*

Press the key combination Ctrl-Alt-Esc to enter the BIOS Utility. The Setup main menu appears:

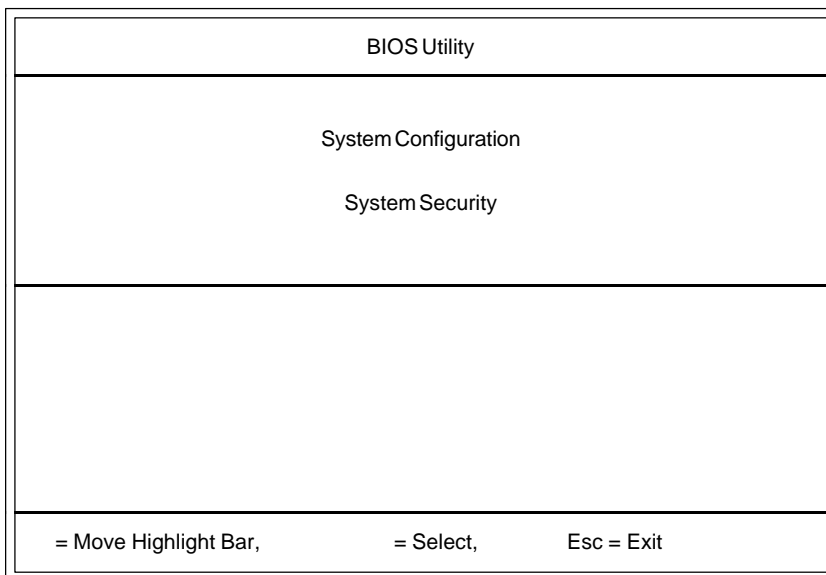

NOTE: *The BIOS version of the system depends on the CPU installed. The following sections discuss the 486 and Pentium versions separately.*

5.1 Basic System Configuration (486 CPU)

The following screen appears when you select System Configuration from the main menu:

System Configuration	Page 1	
Basic System Configuration Advanced System Configuration		
<div style="border: 2px solid black; padding: 10px;"><p>WARNING The following parameters in the Advanced System Configuration depend on CPU in use. Press F9 to set the default value for the best system performance. The system may hang if any of these parameters are set incorrectly.</p></div>		
= Move Highlight Bar,	= Select,	Esc = Exit

Select the first option to show the Basic System Configuration screens as in the following page.

Basic System Configuration

Page 1

Date ----- [MM/DD/YY]
 Time ----- [HH:MM:SS]

Diskette Drive A ----- [xx-MB xx-inch]
 Diskette Drive B ----- [xx-MB xx-inch]

	Cylinder	Head	Sector	Landing	Pre_Comp
Fixed Disk 0 ----- [xx]	xx	xx	xx	xx	None
Fixed Disk 1 ----- [xx]	xx	xx	xx	xx	None

Base Memory ----- [xxx] KB
 Extended Memory ----- [xxxx] KB
 Total Memory ----- [xxxx] KB
 Math Coprocessor ----- [Installed]
 Primary Display ----- [VGA/EGA]

= Move Highlight Bar, = Change Setting, PgDn/PgUp = Move Screen
 F9 = Default Setting, F10 = Bootable Setting, F1 = Help, Esc = Exit

BIOS Setup Utility ----- Page 2

Communication Status

Baud Rate ----- [110] BPS
 Parity ----- [None]
 Stop Bits ----- [1] Bits
 Data Length ----- [7] Bits

Memory Test ----- [Auto]

= Move Highlight Bar, = Change Setting, PgDn/PgUp = Move Screen
 F9 = Default Setting, F10 = Bootable Setting, F1 = Help, Esc = Exit

5.1.1 The Real-Time Clock

The real-time clock keeps the system date and time. After setting the date and time, you need not enter them every time you turn on the system unit. As long as the internal battery remains good (approximately seven years) and connected, the clock continues to keep the date and time accurately even when the power is off.

Date

Highlight this parameter to set the date. Enter the current date, following the month-day-year format. Whenever you want to change the date, simply highlight the Date parameter and enter the new date.

Time

Highlight this parameter and enter the current time in the hour-minute-second format to set the time. Whenever you want to change the time, simply highlight the Time parameter and enter the new time.

5.1.2 Diskette Drives

Highlight the Diskette Drive A parameter to enter the configuration value for the first diskette drive (drive A).

Press the left- and right-arrow keys to view the options.

Follow the same steps to enter the value for the Diskette Drive B parameter. Choose **None** if you don't have a second diskette drive.

5.1.3 Fixed Disk Drives

Know the type of your fixed disk before you set the fixed disk drive parameters.

NOTE: *See the label on the fixed disk or refer to the vendor's documentation for the fixed disk drive type. See also the list of fixed disk drive types at the end of this chapter.*

Move the highlight bar to the Fixed Disk 0 parameter to configure the fixed disk drive (drive C).

Use the arrow keys to select the value that corresponds to your fixed disk type.

Follow the same steps to set the value for Fixed Disk 1 parameter. Select **None** if you don't have a second fixed disk.

5.1.4 System Memory

The system detects the total amount of system memory during POST and sets the values of the memory parameters accordingly. If you install additional memory, the system automatically adjusts the values to show the new memory size.

5.1.5 Math Coprocessor

The system CPU already includes a math coprocessor so this parameter shows **Installed**.

5.1.6 Video Display

The video display is the monitor on which the operating system prompt appears when you boot the system. The system detects the video mode of your primary display and sets the corresponding configuration value. The value may be:

- Monochrome
- CGA 40 columns x 25 rows
- CGA 80 columns x 25 rows
- Special card (VGA/EGA)

5.1.7 Communication Settings

The Communication Settings parameters let you set the baud rate, parity, stop bit and data length for the first 9-pin serial port (COM 1).

- **Baud rate** : 110 to 9600 bits per second (BPS)
- **Parity** : Odd, Even, or None
- **Stop bits** : 1 or 2 stop bits
- **Data length** : 7- or 8-bit data word

There is one restriction on the options available for the communication status parameters. If your data length parameter is an 8-bit data word, you must select one of the following combinations:

- 1 stop bit and odd or even parity
- 2 stop bits and no parity

The default values are 9600 BPS, odd parity, 1 stop bit, and 7-bit data word.

5.1.8 Memory Test

When you set this parameter to Enable, the system tests the memory at power-on. When you set it to Disable, the system skips the memory test.

5.2 Basic System Configuration (Pentium CPU)

In the Pentium version, the following screen appears when you select System Configuration from the main menu:

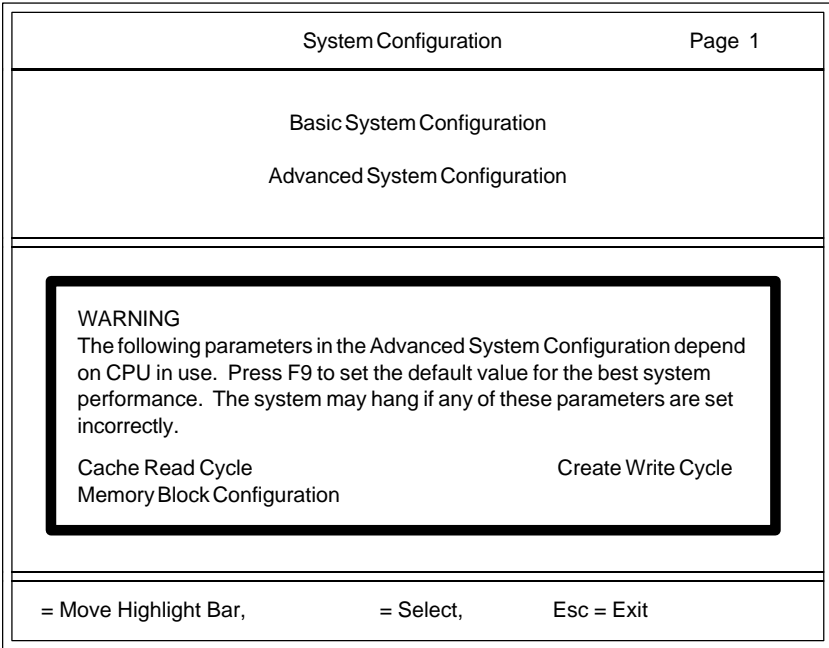

The Basic System Configuration screens are the same as the 486 version. Refer to section 5.1 for the descriptions of the parameters.

5.3 Advanced System Configuration (486 CPU)

The Advanced Configuration parameters let you adjust the other system features for better performance.

When you select Advanced System Configuration from the main menu, the following screens appear:

Advanced System Configuration		Page 1
Shadow RAM		
F0000H-FFFFFH (System BIOS) -----		[Enabled]
C0000H-C7FFFFH (Video BIOS) -----		[Enabled]
C8000H-CFFFFH -----		[Enabled]
D0000H-D7FFFFH -----		[Enabled]
D8000H-DFFFFH -----		[Enabled]
E0000H-E7FFFFH -----		[Disabled]
Internal Cache (CPU Cache) ----- [Enabled]		
System Cache (External Cache) ----- [Enabled]		
Cache Scheme -----		[Write Back]
Cache Burst Read Wait-State -----		[2-2-2]
Cache Write Cycle Insert Wait -----		[Disabled]
F0000h-FFFFh (System BIOS) -----		[Cacheable]
C8000h-C7FFFh (Video BIOS) -----		[Cacheable]
= Move Highlight Bar, = Change Setting, PgDn/PgUp = Move Screen F9 = Default Setting, F10 = Bootable Setting, F1 = Help, Esc = Exit		

Advanced System Configuration		Page 2
Hidden Refresh -----	[Enabled]	
CPU-DRAM Read Cycle Insert Wait -----	[Disabled]	
CPU-DRAM Write Cycle Insert Wait -----	[Disabled]	
SCSI I/O ROM Mapping -----	[0D0000H]	
= Move Highlight Bar, = Change Setting, PgDn/PgUp = Move Screen F9 = Default Setting, F10 = Bootable Setting, F1 = Help, Esc = Exit		

- * The parameter values on the screens may not be the same as the ones on your machine.

The default settings are the values initially stored in ROM. If in the future you change these settings, you can load the default settings again by pressing F9.

When you add a component to the system, you may have to change some settings. If the system does not boot, use the bootable settings to boot the system. To do this, press F10 before you turn on the power and hold it until you hear two beeps. The system then automatically sets the CMOS values to bootable settings.

5.2.1 Shadow RAM

The system reserves 384 KB of random access memory (RAM) for shadow RAM. This parameter has seven range addresses. When you set these addresses to Enable, the video BIOS, I/O ROM, and system BIOS functions run directly from the shadow RAM. When you set them to Disable, the functions run normally from ROM.

The address F0000h-FFFFFh is for system BIOS and C0000h-C7FFFh is for shadowing video BIOS. The next five address ranges, C8000h to EFFFFh, are for I/O ROM functions.

The System BIOS default setting is Enable while its bootable setting is Disable.

5.2.2 Internal Cache

The Internal Cache is the buffer in the CPU itself. The default setting is Enabled.

5.2.3 System Cache

Set the cache controller on and off with this parameter. The default setting is On. The bootable setting is Off.

Cache Scheme

The Cache Scheme parameter sets the cache to Write Back or Write Buffer modes. Write Back updates the cache but not the memory when there is a write instruction. It updates the memory only when the cache is already full. Write Buffer updates both the memory and the cache whenever there is a write instruction.

For better system performance, both the system default and bootable setting is Write Back.

Cache Burst Read Wait-State

This parameter sets cache read cycle for proper system operation. When it is set Enabled, the cache read delay is longer and the system is more stable.

Cache Write Cycle Insert Wait

This parameter sets cache write cycle for proper system operation. When it is set Enabled, the cache write delay is longer and the system is more stable.

F0000h-FFFFFh (System BIOS)

If the system BIOS is shadowed and set to Enabled, you may select Cacheable or Noncacheable for this parameter.

Cacheable allows the system BIOS to run directly from cache memory. The system functions faster. If it is set to Noncacheable, the system BIOS runs from RAM.

C0000h-C7FFFh (Video BIOS)

If the system BIOS is shadowed and set to Enabled, you may select Cacheable or Noncacheable for this parameter.

The Cacheable setting allows the video BIOS to run directly from cache memory. The system functions faster. If it is set to Noncacheable, the video BIOS runs from RAM.

5.3.4 SCSI I/O ROM Mapping

This parameter enables you to adjust the address type of the I/O ROM for the on-board SCSI BIOS when the address conflicts with another add-on card.

5.3 Advanced System Configuration (Pentium CPU)

In the Pentium BIOS version, when you select Advanced System Configuration from the main menu, the following screens appear:

Advanced System Configuration		Page 1
Shadow RAM		
F0000H-FFFFFH (System BIOS) -----		[Enabled]
C0000H-C7FFFH (Video BIOS) -----		[Enabled]
C8000H-CFFFFH -----		[Enabled]
D0000H-D7FFFH -----		[Enabled]
D8000H-DFFFFH -----		[Enabled]
E0000H-E7FFFH -----		[Disabled]
E8000H-EFFFFH -----		[Disabled]
Internal Cache (CPU Cache) ----- [Enabled]		
System Cache (External Cache) ----- [Enabled]		
Cache Scheme (For CPU Cache) -----		[Write Back]
Cache Read Cycle -----		[4-3-3-3]
Cache Write Cycle -----		[4-3-3-3]
F0000h-FFFFFh (System BIOS) -----		[Cacheable]
C8000h-C7FFFh (Video BIOS) -----		[Cacheable]
= Move Highlight Bar, = Change Setting, PgDn/PgUp = Move Screen F9 = Default Setting, F10 = Bootable Setting, F1 = Help, Esc = Exit		

Advanced System Configuration		Page 2
SCSI I/O ROM Mapping -----		[0D0000H]
Memory Block Configuration		
Block Size -----		[64 KB]
Starting Address (A31-A16) -----		[0000000000000000]
Reserved For -----		[Noncacheable]
= Move Highlight Bar, = Change Setting, PgDn/PgUp = Move Screen F9 = Default Setting, F10 = Bootable Setting, F1 = Help, Esc = Exit		

Most of the parameters on the preceding screens are the same as those in the 486 version, but some of them have different settings. Refer to section 5.3 for the descriptions of the similar parameters.

The following sub-sections describe the parameters exclusive to the Pentium version.

Cache Read Cycle

This parameter sets the length of the cache read cycle. The lower the setting, the shorter is the read cycle. When the setting is higher, the cache read delay is longer but the system is more stable.

Cache Write Cycle

This parameter sets the length of the cache write cycle. The lower the setting, the shorter is the write cycle. When the setting is higher, the cache write delay is longer but the system is more stable.

Memory Block Configuration

The sub-items under this parameter specify the size and location in the system memory that is reserved for caching.

5.5 System Security

The System Security option allows you to write protect the disk drives, set the boot drive, and set a system password.

System Security		Page 1
Disk Drive Control		
Diskette Drive -----	[Normal]	
Fixed Disk Drive -----	[Normal]	
System Boot Drive -----	[Auto]	
On Board Communication Ports		
Serial Port 1 -----	[Disabled]	
Serial Port 2 -----	[Disabled]	
Parallel Port -----	[Parallel 1(3BCh)]	
Setup Password -----	[None]	
Power On Password -----	[None]	
Operation Mode -----	[Before Booting]	
= Move Highlight Bar, = Change Setting, F1 = Help, Esc = Exit		

5.5.1 Disk Drive Control

The Disk Drive Control parameters give you the option to write-protect and disable the diskette and fixed disk drives, and set the drive where the system boots from when you turn on the system.

5.5.2 On Board Communication Ports

Serial Ports

The serial port can accommodate a modem, serial mouse, serial printer, and other serial devices. The default value is Disabled.

Parallel Port

The default setting of the parallel port refers to LPT1. The value in parenthesis is the base address expressed in hexadecimal. The other options are:

- [Parallel 2 (378h)] for LPT 2
- [Parallel 3 (278h)] for LPT 3

5.5.3 Setup Password

The Setup Password prevents unauthorized access to the BIOS Utility.

Setting a Password

1. Highlight the Setup Password parameter and press the left- or right-arrow key.

The password prompt appears.

A message below the menu prompts you to enter a password.

2. Type a password.

The password may consist of up to seven characters.

NOTE: *Be careful when typing your password because the characters do not appear on the screen when you type them.*

3. Press Enter.

Another prompt appears asking you to retype the password to verify your first entry.

4. Retype the password then press Enter.

After setting the password, the system automatically sets the Setup Password parameter to Present. The next time you want to enter the BIOS Utility, you have to key in your setup password.

NOTE: *After setting a password, you have to set jumper JP6 to pins 1-2 to enable the security feature.*

If You Forget Your Password

If you forget your password, you have to reset the configuration values stored in CMOS to their default values. When this happens, call your dealer for assistance.

5.5.4 Power On Password

The Power On Password secures your system against unauthorized users. To set this password, follow the same procedure as in setting a Setup Password in section 5.5.3.

Operation Mode

This item gives you an option to choose when the password prompt appears. You can select either Before Booting or After Booting.

When you choose Before Booting, the password prompt appears after the power on self-tests (POST). The system boots when you type in the correct password. If you key in a wrong password, an "X" appears. If you type a wrong password three times, the system hangs. When this happens, you have to reset the system or power it off and then on again.

When you choose After Booting, the system executes POST, boots and displays the DOS prompt. Type in your password. The password prompt does not appear here but the keyboard is locked until you type in the correct password.

5.6 Fixed Disk Types

Type	Cylinders	Heads	Write Precomp	Landing Zone	Sectors Per Track
0		(indicates SCSI or no fixed disk)			
1	306	4	128	305	17
2	615	4	300	615	17
3	615	6	300	615	17
4	940	8	512	940	17
5	940	6	512	940	17
6	615	4	0FFFFH	615	17
7	462	8	256	511	17
8	733	5	0FFFFH	733	17
9	900	15	0FFFFH	901	17
10	820	3	0FFFFH	820	17
11	855	5	0FFFFH	855	17
12	855	7	0FFFFH	855	17
13	306	8	128	319	17
14	733	7	0FFFFH	733	17
15	(reserved)				
16	612	4	0	663	17
17	977	5	300	977	17
18	977	7	0FFFFH	977	17
19	1024	7	512	1023	17
20	733	5	300	732	17
21	733	7	300	732	17
22	733	5	300	733	17
23	306	4	0	336	17
24	612	4	305	663	17
25	306	4	0FFFFH	340	17
26	612	4	0FFFFH	670	17
27	698	7	300	732	17
28	976	5	488	977	17
29	306	4	0	340	17
30	611	4	306	663	17
31	732	7	300	732	17
32	1023	5	0FFFFH	1023	17
33	751	8	0	0	17
34	755	16	0	0	17
35-36	(reserved)				
37	936	16	0FFFFH	936	17
38	981	5	0FFFFH	981	17
39	981	10	0FFFFH	981	17
40	762	8	0FFFFH	762	39

Type	Cylinders	Heads	Write Precomp	Landing Zone	Sectors Per Track
41	980	5	0FFFFH	980	17
42	832	8	0FFFFH	832	33
43	683	12	0FFFFH	683	38
44	513	16	0FFFFH	513	38
45	776	8	0FFFFH	776	33
46	683	16	0FFFFH	683	38
47	832	6	0FFFFH	832	33
48	615	2	300	615	34
49	989	16	0	989	63
50	823	4	0FFFFH	823	38
51	1001	15	0FFFFH	1001	17
52	1024	7	0FFFFH	0FFFFH	17
53	723	13	0FFFFH	0FFFFH	51
54	548	8	0FFFFH	548	38
55	1013	4	0FFFFH	0FFFFH	41
56	931	15	0FFFFH	0FFFFH	17
57	817	14	0FFFFH	0FFFFH	36
58	723	13	0FFFFH	0FFFFH	36
59	802	4	0FFFFH	802	39
60	1024	9	0FFFFH	1023	17
61	1224	7	0FFFFH	1223	17
62	1224	11	0FFFFH	1223	17
63	1224	15	0FFFFH	1223	17
64	1024	8	0FFFFH	1023	17
65	1024	11	0FFFFH	1023	17
66	918	11	0FFFFH	1023	17
67	925	9	0FFFFH	926	17
68	1024	10	0FFFFH	1023	17
69	1024	12	0FFFFH	1023	17
70	1024	13	0FFFFH	1023	17
71	1024	14	0FFFFH	1023	17
72	1024	2	0FFFFH	1023	17
73	1024	16	0FFFFH	1023	17
74	918	15	0FFFFH	1023	17
75	820	6	0FFFFH	820	17
76	1024	5	512	1023	17
77	1024	8	512	1023	17
78	1224	7	0FFFFH	1223	35
79	1224	11	0FFFFH	1223	35
80	1224	15	0FFFFH	1223	35
81	1024	7	0FFFFH	1223	17
82	1024	11	0FFFFH	1223	17
83	1024	15	0FFFFH	1223	17

Type	Cylinders	Heads	Write Precomp	Landing Zone	Sectors Per Track
84	776	8	0FFFFH	775	33
85	926	13	0FFFFH	926	17
86	805	4	0FFFFH	805	26
87	976	5	0FFFFH	976	17
88	745	4	0FFFFH	760	28
89	747	2	0FFFFH	760	28
90	782	2	0FFFFH	862	27
91	1366	8	0FFFFH	1366	38
92	816	15	0FFFFH	816	32
93~100		(reserved)			
255		user defined			

EISA Configuration Utility

Your system comes with an EISA configuration utility.

6.1 Functions

The EISA configuration utility (ECU) configures your computer and the boards or options added to the system.

The ECU does the following:

1. Resolves conflicts between DMA channels, interrupt (IRQ) lines, I/O port addresses, and memory requirements
2. Presents the option settings that specify those parameters
3. Presents settings for other functions that are necessary or desirable to make the presentation useful

Before you install an expansion board, whether ISA or EISA, you must run the EISA configuration utility (ECU) to configure the system. Follow this sequence:

- Run ECU and then specify board parameters
- Configure the board
- Install the board

Running ECU ensures conflict-free configuration of system components.

6.2 Program Menu Organization

The ECU is a menu-driven program organized into a main menu and various submenus, with help screens for all options.

Here is a summary of the program menu organization:

- LEARN ABOUT CONFIGURING YOUR COMPUTER
- CONFIGURE COMPUTER
 - Copy Configuration (CFG) Files
 - Configure Computer - Basic Method
 - Configure Computer - Advanced Method
 - Return to the Main Menu
- SET DATE AND TIME
- EXIT FROM THIS UTILITY

6.3 Starting the ECU

The EISA configuration utility runs on any ISA or EISA computer using MS-DOS version 3.2 or higher. It requires a minimum of 640-KB of memory, a 1.2-MB diskette drive, and a fixed disk drive. You may wish to use a mouse to move the cursor and to select options within the utility.

The ECU includes an executable file, SD.EXE (System Dispatcher) that helps you configure your system resources. To use the utility, do the following:

1. Turn on your computer. (Reset the system if power is already on.)
2. Insert the system utilities diskette in drive A.
3. Type SD, then press Enter. Your screen displays a logo.
4. Press any key to continue. Your screen should show a welcome screen.
5. Press Enter to leave the welcome screen and display the main menu.

If you are starting the ECU from a fixed disk, refer to *Options in Using the ECU*. The following sections describe how to use the main menu and the menu selections.

6.3.1 Main Menu

The main menu includes a help box at the lower right-hand side of the screen.

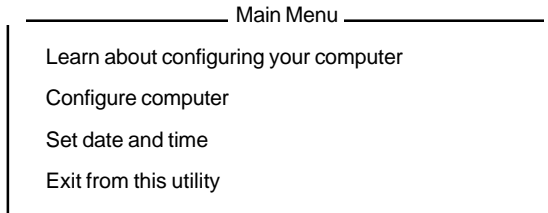

You can select options using either the keyboard or a mouse:

- Using the keyboard, move the cursor with the ↑ and ↓ keys to position it on the desired menu selection and then press Enter.
- Using a mouse, move the mouse cursor to the desired selection on the menu and click the left button on the mouse.

Press F1 for a detailed description of the menu option selected.

6.3.2 Main Menu Selections

LEARN ABOUT CONFIGURING YOUR COMPUTER

This selection is highlighted when you first enter the main menu. It gives an overview on how to configure your computer with this utility. Press Enter to choose this selection. Then press the ↑ and ↓ keys to move up or down the explanation.

CONFIGURE COMPUTER

This selection contains the following submenu:

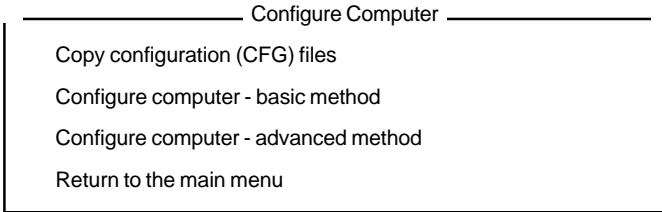

The options in this submenu are discussed in the following sections.

SET DATE AND TIME

This selection allows you to set your computer date and time. Once you set the date and time, your computer will keep track of it, even when the power is turned off.

EXIT FROM THIS UTILITY

This selection exits the utility. The system will reboot. If you do not have an operating system installed on your fixed disk, replace the system utilities diskette in the diskette drive with an operating system diskette.

6.3.3 Configuring the Computer

This section describes the first two selections in the submenu under the CONFIGURE COMPUTER selection in the main menu.

When you configure your system with the ECU, you would basically do the following:

1. Before you add boards or options, copy the configuration (CFG) file (contained in a diskette provided by the board manufacturer) to the ECU.
 - Select CONFIGURE COMPUTER on the main menu.

- Select **Copy configuration (CFG) files** to copy the CFG file for the board/option. (If you are configuring your computer with an ISA board that has no CFG file, refer to *Configuring an ISA Option Without a CFG file*.)
2. Choose a configuration method – Basic or Advanced – from the **CONFIGURE COMPUTER** submenu.
 - Use the basic method if you only need to add or delete boards/options and set up your computer.
 - Use the advanced method if you are adding or removing boards, and changing functions or resources (e.g., changing the parallel port assignment from LPT1 to LPT2, or changing the IRQ level).
 3. If you use the advanced method you will be instructed according to the selection you choose. Follow these instructions carefully, then install or remove the option(s).

6.3.4 EISA Board Configuration Files

EISA expansion board manufacturers include a configuration (CFG) file on a diskette with each board. This file normally includes information about the board I/O port address, memory address, DMA channel, interrupt level and power requirements.

The configuration utility and BIOS read and record the following information from the configuration file:

- Identity and characteristics of the board
- Programmable ports, switches, jumpers, and configuration software
- All board functions and configuration options

You must copy the corresponding CFG files onto your System Configuration diskette before you can add boards and options to your computer configuration.

6.3.5 Configure Computer – Basic Method

This selection guides you through the procedure for adding boards and options to your computer. When you choose this selection, the screen displays a graphical overview of the boards and options installed in your computer. (See sample screen below.) When there are no resource conflicts, the ECU saves this configuration information in a system configuration information (SCI) file.

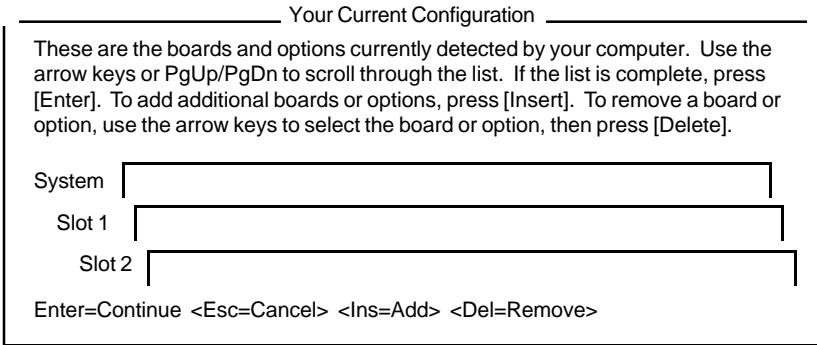

Sample Screen: Basic Configuration

Before you return to the main menu, write down or print the list of the switch, jumper, and software settings you need to change for ISA boards. If no CFG file accompanies an option or board you want to install, follow the instructions that go with the option to install it.

If there is a conflict of resources and you need to change functions, edit resources, or perform advanced tasks, move to the next option.

6.4 Advanced Configuration

The advanced configuration method includes such functions as:

- Changing resources or functions especially when resource conflicts occur.
- Printing configuration data about an installed board or the entire system. The **Print** function is under the System menu.
- Locking a configuration with the current settings; i.e., the resources of the boards locked in the system, do not change when you add new boards to the system. This feature can be used by selecting **Lock** from the Edit menu.
- Conversely, solving a resource conflict on a computer with locked boards. **Unlock** in the Edit menu does this function partly.

When you choose CONFIGURE COMPUTER – ADVANCED METHOD, the screen displays a graphical overview of the boards and options installed in your computer. At the top of the screen is a bar listing pull-down menus.

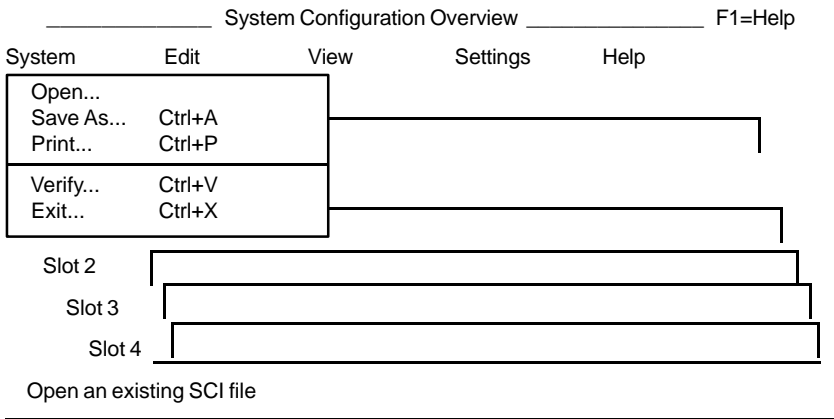

Figure 6-1 Advanced Configuration (**System—Open Selected**)

Use the pull-down menus to enter configuration data about your computer. As you enter information, the entries are verified (when Auto Verify is turned on). If the utility finds any resource conflicts, you must correct the errors by changing function and resource choices. When there are no resource conflicts, the configuration information is saved in an SCI file.

Before you return to the main menu, write down or print the list of the switch, jumper, and software settings you need to change for ISA boards. If no CFG file accompanies an option or board you want to install follow the instructions that go with the option to install it.

6.4.1 Advanced Configuration Menu Selections

Table 6-1 explains the selections available in the pull-down menus.

Table 6-1 Advanced Configuration Menu Bar Selections

Menu Bar Selection	Pull-Down Selection	Function
System	New	Creates a new configuration and system configuration information (SCI) file for a computer.
	Open	Opens an existing SCI file for editing.
	Save As	Makes a backup copy of the current configuration choices in a specified SCI.
	Print	Prints configuration data about the current option or the entire configuration on a printer.
	Verify	Verifies that the computer is correctly configured (the configuration is free of system resource conflicts).
	Exit	Prompts to either view the settings of the boards and options, save the configuration and exit, or exit without saving any changes. If the configuration has changed and is saved, the system restarts instead of exiting to the menu.

Table 6-1 Advanced Configuration; Menu Bar Selections (continued)

Menu Bar Selection	Pull-Down Selection	Function
Edit	Add	Adds a selected board or option to the current configuration.
	Move	Selects the current board and moves it to a selected available slot.
	Remove	Selects the current board and removes it from the current configuration.
	Change Function	Selects the current function and allows you to change the function choice. Only selectable when the detailed view is active.
	Change Resource	Selects the current function and allows you to change the system resources for the function. Only selectable when the detailed view is active.
	Revert to Saved	Sets all choices for the current board or the entire configuration to the last saved choices.
	Reset to Default	Sets all choices for the current board or the entire configuration to the manufacturer's default choices.

*Table 6-1 Advanced Configuration; Menu Bar Selections
(continued)*

Menu Bar Selection	Pull-Down Selection	Function
Edit	Lock	Secures all choices for the current board or the entire configuration to the current selections.
	Unlock	Unlocks all choices for the current board or the entire configuration.
View	Overview	Displays a general overview of the configuration.
	Detailed by Slot	Displays a detailed view of the configuration sorted by slot.
	Detailed by Type	Displays a detailed view of the configuration sorted by type of function.
	Switch and Jumper Settings	Selects the current board or option and displays information about its switches and jumpers.
	Software Settings	Selects the current board or option and displays information about software drivers.

*Table 6-1 Advanced Configuration; Menu Bar Selections
(continued)*

Menu Bar Selection	Pull-Down Selection	Function
View	Connections	Selects the current board or option and displays information about its external cable connections.
	Board Specifications	Selects the current board or option and displays information about identification and physical characteristics.
	Resources	Selects the current board or function and displays system resource summary information.
Settings	Auto Verify	Checks the system configuration for resource conflicts each time you change the configuration. Selecting Auto Verify turns Manual Verify off.
	Manual Verify	Your computer configuration is not checked for resource conflicts. You must select Verify from the System pulldown menu to check your system configuration.

*Table 6-1 Advanced Configuration; Menu Bar Selections
(continued)*

Menu Bar Selection	Pull-Down Selection	Function
Help	Help Topics	Displays an index of help topics which can be displayed on your screen.
	Help	Displays help information about the currently selected board, option or function. This menu item does the same function as pressing the F1 key.
	How to Use Keys	Displays a list of the key sequences which you can use.
	How to Use Help	Displays information about using help.
	Copyright Information	Displays copyright information about this utility.

6.4.2 Using the Advanced Configuration Menus

Getting Help

The bottom of the screen shows a line that contains a list of the keys you can use.

You can get help information about a selection on a menu or any object on a screen by pressing F1 while your cursor is on the selection or object. You can also display help information from the help topics index by selecting Help topics from the Help pull-down menu or by pressing Shift-F1.

Using Keys

Choosing Configure Computer from the main menu provides the following types of keys and key combinations:

- Keys for selecting pull-down menu items
- Key combinations which are a shortcut for selecting pull-down menu items (accelerators)
- Keys for moving the cursor while your computer configuration is displayed
- Keys for moving the cursor within a dialog box

If you press Shift-F1, the screen displays the help topics index. Then, use the arrow keys to select “Using the keyboard” and press Enter.

Using Menus

The menu bar at the top of the screen lists five pull-down menus in the Configure Computer – Advanced Method selection. Table 6-1 explains these menus. There are three ways to use the pull-down menus:

- Using the Keyboard

To make menu selections using the keyboard, follow these steps:

1. Press F10 to place the cursor on the menu bar.
2. Use the left and right arrow keys to position the cursor on the desired pull-down menu name.
3. Press Enter to display the pull-down menu.
4. Use the up and down arrow keys to position the cursor on the desired pull-down menu item.
5. Press Enter to execute the pull-down menu item. If the menu item ends in an ellipsis (...), a dialog box appears to prompt you for further information; otherwise, the menu item executes directly.

- Using Enhanced Letters

Each pull-down menu listed on the menu bar and each item on the pull-down menus have a single enhanced letter. To make a selection using enhanced letters, follow these steps:

1. Press and hold down the Alt key while pressing the enhanced letter for the desired pull-down menu. The screen displays the pull-down menu.
2. Press the enhanced letter that corresponds to the desired menu item to execute the menu item. If the menu item ends in an ellipsis (...), a dialog box appears to prompt you for further information; otherwise, the menu item executes directly.

- Using a Mouse

To make menu selections using a mouse, follow these steps:

1. Place the mouse cursor over the desired pull-down menu name on the menu bar; click the left button on the mouse. The pull-down menu appears.

2. Place the mouse cursor over the desired pull-down menu item and click the left button on the mouse to execute the menu item. If the menu item ends in an ellipsis (...), a dialog box appears to prompt you for further information; otherwise, the menu item executes directly.

Using Dialog Boxes

When you select a menu item that ends in an ellipsis (...), a dialog box appears to prompt you for further information. There are two ways to use a dialog box:

- **Using the Keyboard**

To move within a dialog using the keyboard, follow these guidelines:

1. Press Tab to move to the next field or area.
2. Press Shift-Tab to move to the previous field or area.
3. Use the arrow keys to move between items in a list.
4. Press space bar to turn a check box on or off.
5. Press Enter to select.
6. Press Esc to cancel the dialog box.

- **Using a Mouse**

To move within a dialog box using a mouse, follow these guidelines:

1. Place the mouse cursor over the desired choice in the dialog box and click the left button.
2. Place the mouse cursor on a check box and click the left button to turn the check box on or off.
3. Place the mouse cursor on a button and click the left mouse button.

Using Screens

When your configuration appears in an overview or a detailed view, use the following steps for moving the cursor:

- Using the Keyboard

To move the cursor on the screen using the keyboard, follow these guidelines:

1. Press Tab to move to the next option.
2. Press Shift-Tab to move to the previous option.
3. Press Ctrl-Home to move to the beginning of the information.
4. Press Page Down to move down one screen.
5. Press the down arrow key to move down one line.
6. Press Page Up to move up one screen.
7. Press the up arrow key to move up one line.
8. Press Ctrl-End to move to the end of the information.

- Using a Mouse

To move the cursor on the screen using a mouse, follow these guidelines:

1. Place the mouse cursor over the desired area on the screen and click the left button.
2. If the right side of the screen shows a scroll bar, place the mouse cursor over the arrow symbol at the top or bottom of the scroll bar and press the left button.

6.4.3 Configuring an ISA Option Without a CFG File

- Select CONFIGURE COMPUTER - ADVANCED METHOD.
- If a printer is attached to your system, print the resources used by the entire system with this selection:

System > Print

- Without a printer, select

View > Resources

and write down the resources used by the system

- Set jumpers/switches on the ISA board. Make sure that the board does not conflict with the system resources currently in use.

6.5 Solving Resource Conflicts

If the system uses the resources needed by an ISA option, you have to release those resources and reallocate other resources to the system.

- Make the system use other resources by selecting Edit > Change Resource or Change Function.
- Select System > Print to print a list of the resources.
- To see how to change the switch and jumper settings, select View > Switch and jumper settings. Note down this information.
- Exit from the utility.
- Turn off the system and set the jumpers and switches.

If you have used Edit > Lock, you need to unlock the configuration to make all resources available to the ECU.

- Select Edit > Unlock.

- Select the option to unlock either the entire system or the current board only. The highlight appears on the current board.
- Select OK to unlock the configuration.
- Select System → Verify.

6.6 Options in Using the ECU

6.6.1 Starting the ECU From a Fixed Disk

Although we recommend that you start this utility from the System Configuration diskette, you can start the utility from your fixed disk if you have MS-DOS installed on it.

Installing the Utility on a Fixed Disk

You must copy the utility files to your fixed disk before you can start the utility. To copy the files, insert the System Configuration diskette in drive A and type:

```
copy a:*. * [d:][path]
```

where

d: is the fixed drive that will contain the utility files

path is the path on the fixed drive that will contain the utility files

Starting the Utility

To run the utility, type the following command followed by Enter. (Items in brackets are optional and only the information within the brackets is entered.)

```
[d:][path]SD[/B][/H][/K][/M][/A]
```

The parameters after the path are explained as follows:

/B BIOS video mode

This parameter causes all screens to be displayed using BIOS Int 10H calls. Use this parameter on computers with non-standard displays. The default mode is to write directly to video memory.

/H High resolution display

If you have an EGA monitor, the utility appears in 43-line mode. If you have a VGA monitor, the utility appears in 50-line mode. If you do not enter this parameter, your screen displays 25 lines.

/M Monochrome display

This parameter causes the utility to display the screens in black and white.

/K Keyboard only mode

If you use this parameter, the computer will not support the use of a mouse device even if one is present. The default is to support a mouse if its driver is loaded in memory.

/A Expanded mode

This mode offers an expanded set of menus with additional functionality. This mode may also be activated by pressing Ctrl-A instead of Enter when the “Welcome” screen appears.

When the utility begins, a logo screen appears. Press any key to display a “Welcome” screen. To leave the “Welcome” screen and display the main menu press Enter.

6.6.2 Starting the Configure Computer Selection from MS-DOS

You can bypass the main menu and start the Configure Computer selection directly from MS-DOS. This allows you to use command line parameters to customize the operation of the utility. You must have MS-DOS and this utility installed on your fixed disk.

Use the following format to type the command that starts this selection from MS-DOS. (Items in brackets are optional and only the information within the brackets is entered.)

```
[d:][path]CF[/B][/H][/K][/M][/N][/T][/F]
```

The parameters /B, /H, /M, and /K are explained in the previous section. The rest of the parameters are described as follows:

/N Non-target modeling mode

This parameter runs the utility in non-target modeling mode. When you run this utility, the configuration which is stored in the SCI file named *system.sci* is displayed. When you save the configuration, it is normally saved to the *system.sci* file. However, with non-target modeling mode, you can create an SCI file for a computer other than the one on which you are running the utility, create multiple SCI files, and create one SCI file for multiple computers.

/T Detailed view by slot

This parameter causes the default view to be detailed by slot instead of overview.

/F Fast configuration operation

This is the automatic configuration mode. The utility determines the boards and options and configures the system without user assistance.

apricot

 MITSUBISHI ELECTRIC

Part No I5242531
Revision No 01

APRICOT COMPUTERS LIMITED
3500 PARKSIDE
BIRMINGHAM BUSINESS PARK
BIRMINGHAM B37 7YS
UNITED KINGDOM

mitsubishi electric europe GmbH
GOTHAER STRASSE 8
POSTFACH 1548
40835 RATINGEN
DEUTSCHLAND