



# Value-of-resilience from Solar Microgrids

## VOR123 Methodology

Craig Lewis  
Executive Director  
Clean Coalition  
650-796-2353 mobile  
[craig@clean-coalition.org](mailto:craig@clean-coalition.org)

## Mission

To accelerate the transition to renewable energy and a modern grid through technical, policy, and project development expertise.

### 100% renewable energy end-game

- 25% local, interconnected within the distribution grid and facilitating resilience without dependence on the transmission grid.
- 75% remote, dependent on the transmission grid for serving loads.

# Natural gas infrastructure is not resilient

- **Assertion:** Gas-driven generation is often claimed to be resilient.
- **Reality:** Gas infrastructure is not resilient and takes much longer to restore than electricity infrastructure.
- **Threats:** Gas infrastructure can be flat-out dangerous and is highly vulnerable to earthquakes, fires, landslides, and terrorism.



2010 San Bruno Pipeline Explosion

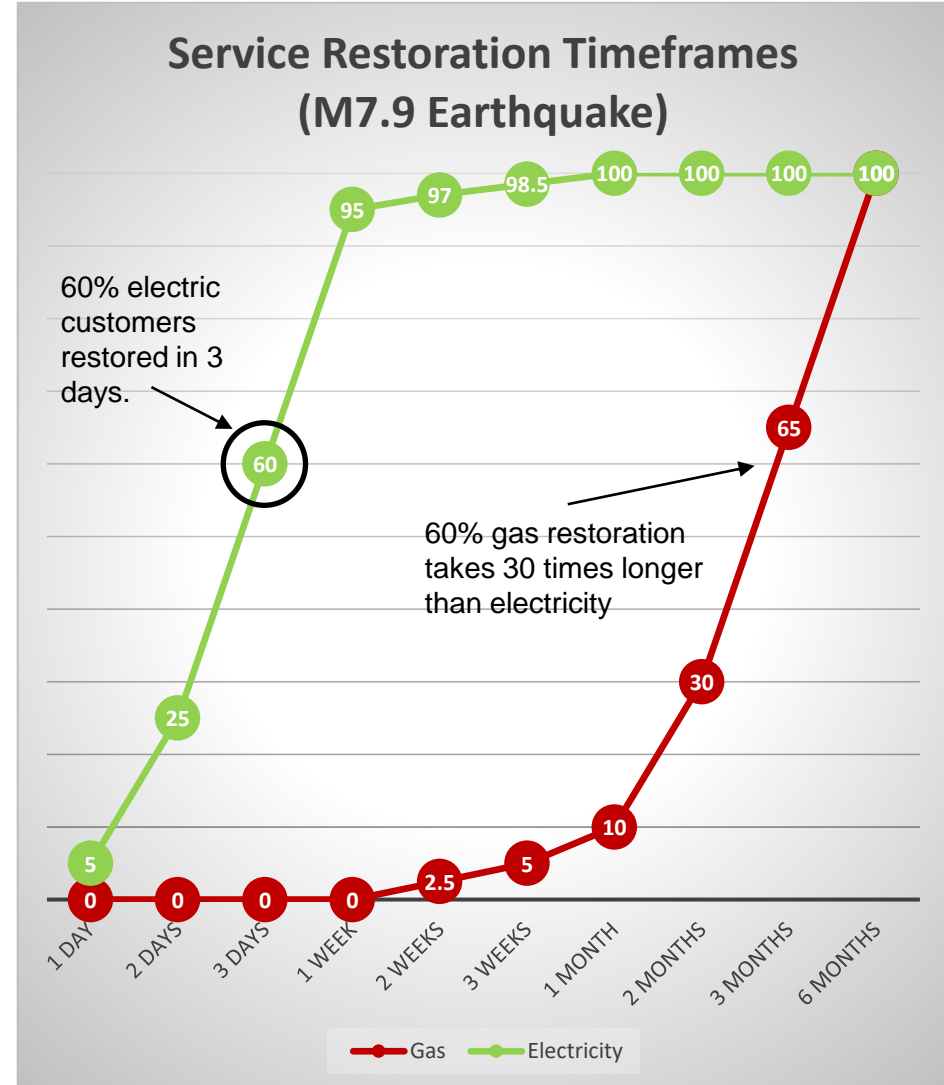

Source: The City and County of San Francisco Lifelines Study

# Value-of-resilience (VOR) depends on tier of load

- Everyone understands there is significant value to resilience provided by indefinite renewables-driven backup power, especially for the most critical loads
  - But, nobody has quantified this value of unparalleled resilience.
  - Hence, there is a substantial economic gap for renewables-driven microgrids.
- The Clean Coalition aims to establish a standardized [value-of-resilience](#) (VOR) for critical, priority, and discretionary loads that will help everyone understand that premiums are appropriate for indefinite renewables-driven backup power to critical loads and almost constant backup power to priority loads, which yields a configuration that delivers backup power to all loads a lot of the time
- The Clean Coalition's VOR approach aims to standardize resilience values for three tiers of loads:
  - Tier 1 are mission-critical & life-sustaining loads and warrant 100% resilience. Tier 1 loads usually represent about 10% of the total load.
  - Tier 2 are priority loads that should be maintained as long as long as doing so does not threaten the ability to maintain Tier 1 loads. Tier 2 loads usually represent about 15% of the total load.
  - Tier 3 are discretionary loads make up the remaining loads, usually about 75% of the total load. Maintained when doing so does not threaten Tier 1 & 2 resilience.



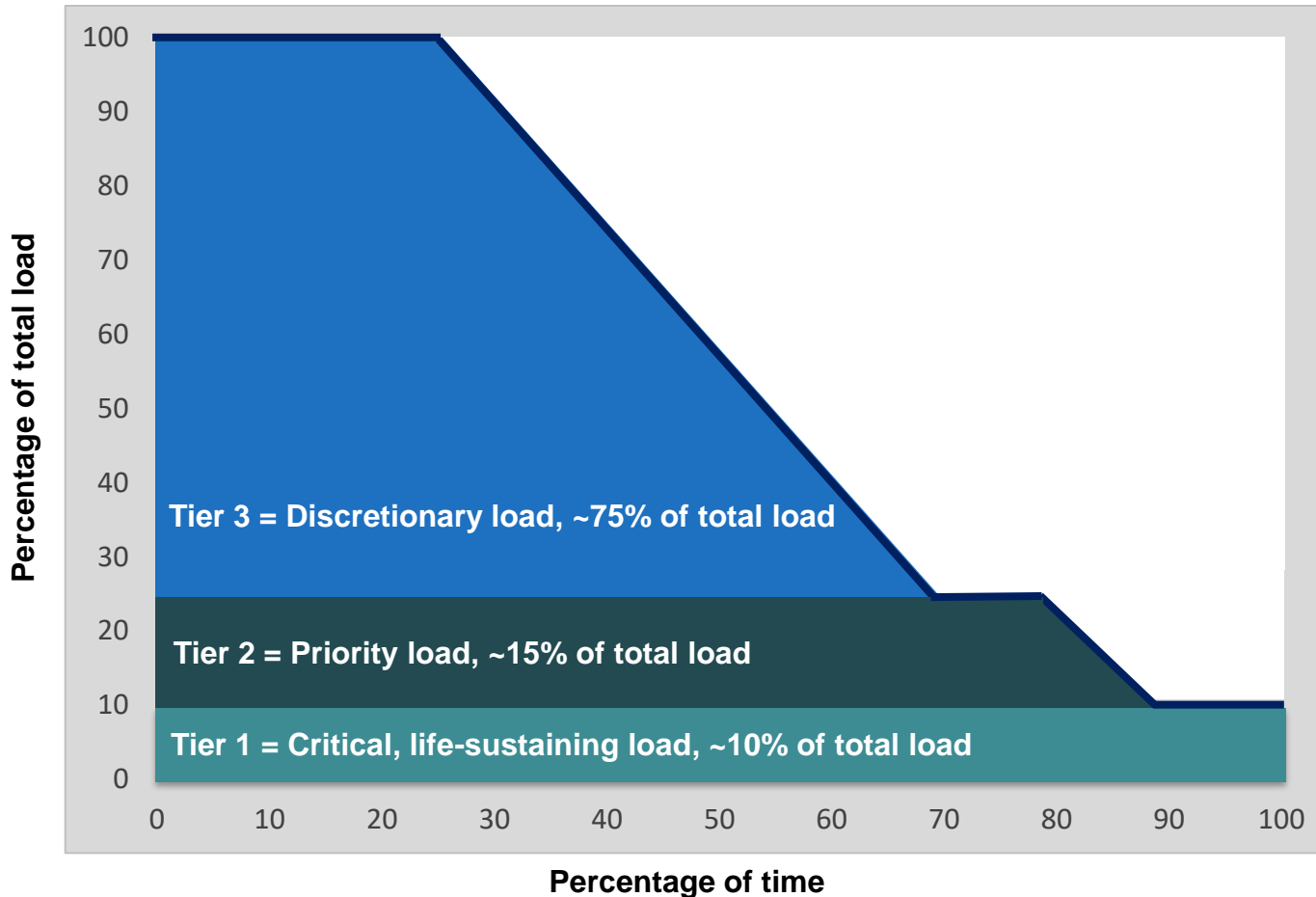

Percentage of time online for Tier 1, 2, and 3 loads for a Solar Microgrid designed for the University of California Santa Barbara (UCSB) with enough solar to achieve net zero and enough energy storage capacity to hold 2 hours of the nameplate solar (200 kWh energy storage per 100 kW solar).

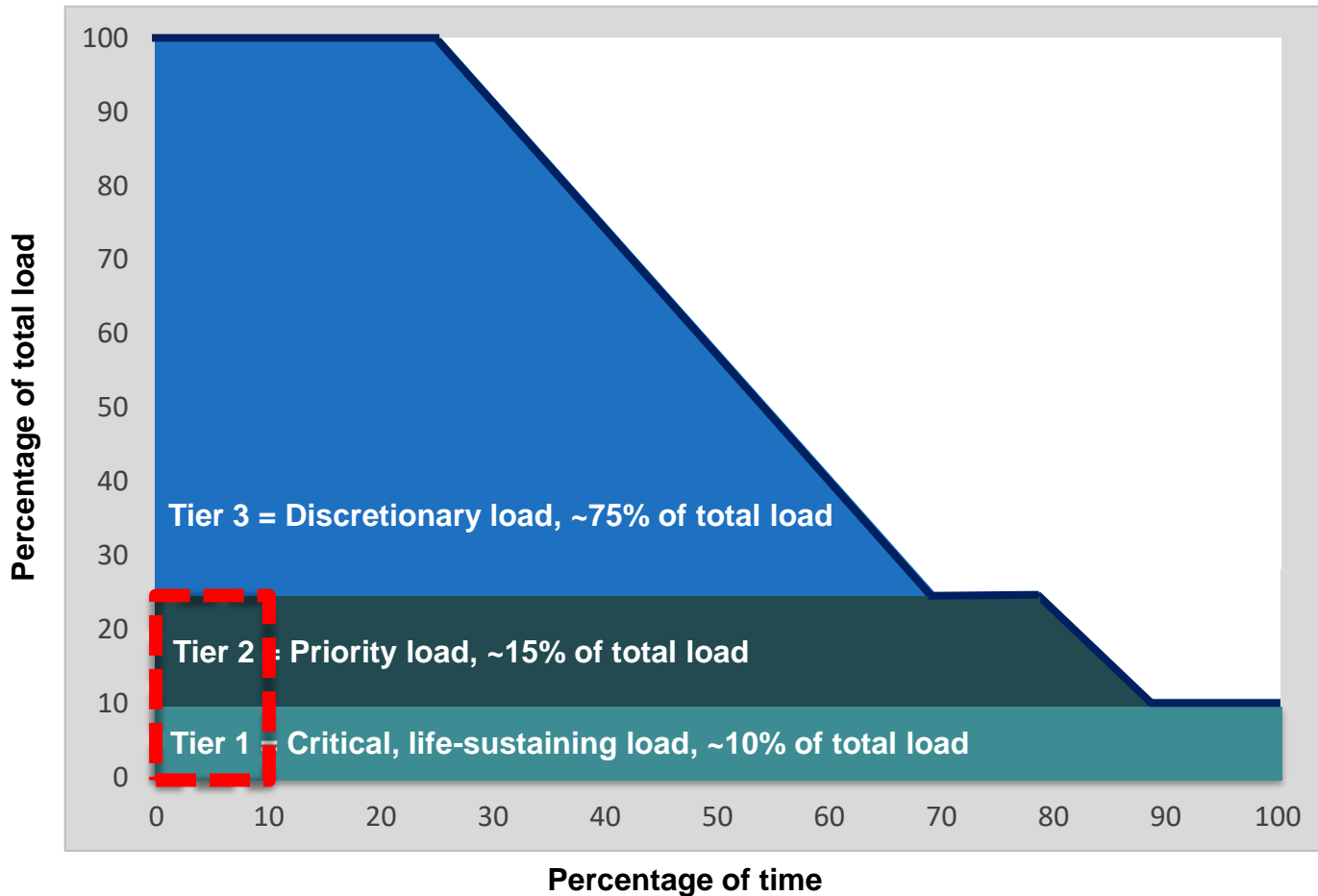

A typical diesel generator is configured to maintain 25% of the normal load for two days. If diesel fuel cannot be resupplied within two days, goodbye. This is hardly a solution for increasingly necessary long-term resilience. In California, Solar Microgrids provide a vastly superior trifecta of economic, environmental, and resilience benefits.

There are different VOR multipliers for each of the three load tiers. The following valuation ranges are typical for most sites:

- **Tier 1:** 100% resilience is worth 3 times the average price paid for electricity. In other words, indefinite energy resilience for critical loads is worth 3 times the average price paid for electricity. Given that the typical facility has a Tier 1 load that is about 10% of the total load, applying the 3x VOR Tier 1 multiplier warrants a 20% adder to the electricity bill.
- **Tier 2:** 80% resilience is worth 1.5 times the normal price paid for electricity. In other words, energy resilience that is provisioned at least 80% of the time for priority loads is worth 1.5 times the average price paid for electricity. Given that the typical facility has a Tier 2 load that is about 15% of the total load, applying the 1.5x VOR Tier 2 multiplier warrants a 7.5% adder to the electricity bill.
- **Tier 3:** Although a standard-size Solar Microgrid can provide backup power to Tier 3 loads a substantial percentage of the time, Tier 3 loads are by definition discretionary, and therefore, a Tier 3 VOR multiplier is negligible and assumed to be zero.

Taken together, the Tier 1 and Tier 2 premiums for a standard load tiering situation yields an effective VOR of between 25% and 30%. Hence, the Clean Coalition uses 25% as the typical VOR123 adder that a site should be willing to pay, including for indefinite renewables-driven backup power to critical loads — along with renewables-driven backup for the rest of the loads for significant percentages of time.

Importantly, the Clean Coalition has resolved on the general 25% premium figure after conducting numerous analytical approaches, including the following three primary methodologies:

- 1. Cost-of-service (COS):** This is the cost that suppliers will charge in order to offer the Solar Microgrid VOR across the Tier 1, 2, and 3 loads (VOR123). As evidenced by a case study of the Santa Barbara Unified School District (SBUSD), a COS that reflects a 25% resilience adder is sufficient to attract economically viable Solar Microgrids at the larger school sites.
- 2. Department of Energy (DOE) Multiplier:** The DOE researched VOR and determined that the overall value of critical load that is missed due to grid outages over an annual period is **\$117/kWh**. While the Clean Coalition stages Solar Microgrids to provide indefinite solar-driven backup power to critical loads, and considers 30 consecutive days to be a proxy for indefinite, the Clean Coalition assumed a **conservative annual cumulative outage time of 3 days for the DOE Multiplier VOR analysis**. The SBUSD case study yielded an overall 30% VOR adder to the 2019 electricity spend, as indicated in the table below.

**DOE Multiplier results for SBUSD prototype schools**

Prototypical School	Average Tier 1 Load (kW)	Tier 1 kWh/year missed (72 hours/year)	VOR (\$117/kWh)	Total 2019 electricity spend	DOE-derived VOR % of 2019 spend
Franklin ES	4.7	336	\$39,256	\$70,000	56%
La Cumbre JHS	2.8	202	\$23,587	\$78,000	30%
San Marcos HS	4.4	314	\$36,729	\$188,000	20%
Totals	11.8	851	\$99,572	\$336,000	30%

- 3. Market-Based:** This is essentially the market price, where supply meets demand, and the Direct Relief Solar Microgrid provides a local case study. Direct Relief has deployed a 320 kW PV and 676 kWh BESS Solar Microgrid, and while the PV is purchased via a roughly breakeven PPA, the BESS is leased at an annual cost of \$37,500. While the size of the Direct Relief BESS (676 kWh) is a bit smaller than the size of the San Marcos Solar Microgrid BESS (710 kWh), Direct Relief is paying a bit more (\$37,500/year) than the DOE Multiplier would value the San Marcos BESS (\$36,729/year, as shown in Table 2-2).

Direct Relief Solar Microgrid

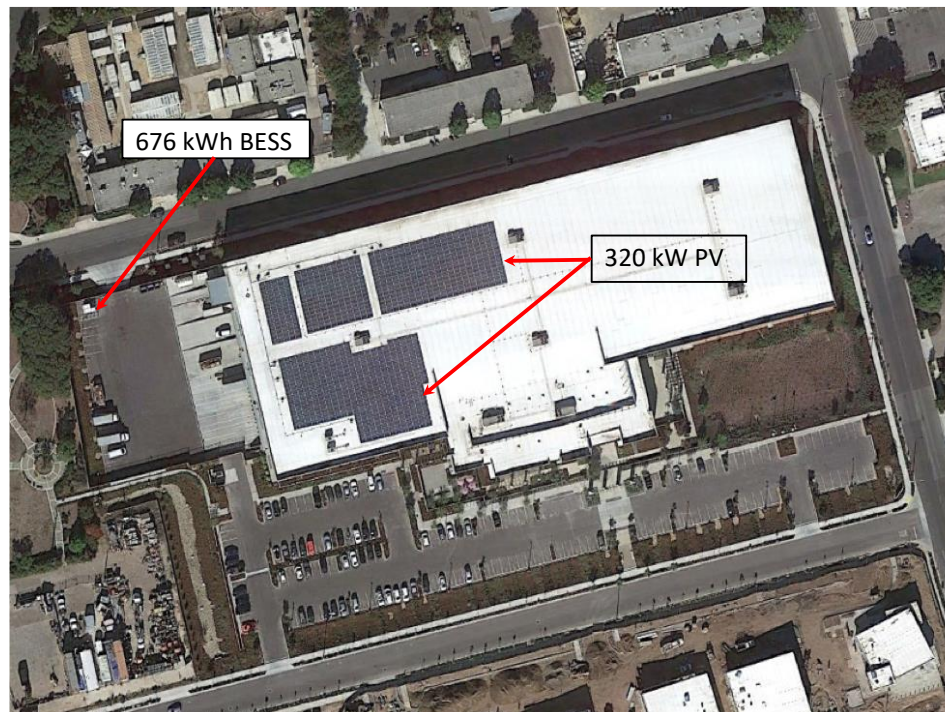

4. **Avoided Diesel Generator Cost:** This approach is analogous to the previous cost-of-service (COS) approach, except it calculates the adder needed for a diesel generator to fulfill the VOR123 level of resilience. For this calculation, we equate “indefinite backup” to 30 days, and assume such a grid outage occurs once per year, during which the loads need to be maintained according to the standard VOR123 profile. The result, for a diesel backup system sized for a 1 million kWh/year site in Santa Barbara, is a **21 % adder** to the electricity bill.

### Site Load Inputs

Total Site Annual Load (kWh)	1,000,000
Outage Duration (days)	30
Number of outages/year	1
Average cost of utility-purchased electricity (\$/kWh)	\$0.18
Average Site Power (kW)	114
Yearly cost of utility-purchased electricity	\$180,000

### VOR123 Parameters

Tier 1 % of time	100%
Tier 2 % of time	80%
Tier 3 % of time	30%
Tier 1 % of load	10%
Tier 2 % of load	15%
Tier 3 % of load	75%
<b>TCLR (kWh)</b>	36,575

### Diesel Genset Size Check

Diesel genset size (kW)	200
Peak load (kW)	171

### Diesel Tank Capacity Check

Diesel genset tank capacity (gallons)	3,000
Diesel used for TCLR (gallons)	3,040

### Financials

Diesel Genset Depreciation Life (years)	15
Diesel Genset Capex	\$350,000
Diesel Genset Opex (\$/year)	\$14,694
Diesel Genset Depreciated Capex (\$/year)	\$23,333
Diesel Genset Total Yearly Cost	\$38,027

<b>Cost of Diesel Genset backup energy (\$/kWh)</b>	<b>\$1.04</b>
<b>% adder of Diesel backup cost on top of utility-purchased electricity</b>	<b>21%</b>

# Diesel generator cost analysis

Input Variables		
Diesel Genset Size	kW	200
Diesel Tank Capacity	Gallons	3000
Capex Costs		
Genset equipment cost	\$/kW	\$270
Genset "Balance of Plant"	\$/kW	\$250
<b>Variable Capex Subtotal</b>	<b>\$/kW</b>	<b>\$520</b>
Structural design	\$	\$20,000
Installation	\$	\$25,000
<b>Fixed Capex Subtotal</b>	<b>\$</b>	<b>\$45,000</b>
Fuel tank cost	\$/gal	\$61
Fuel tank installation	\$/gal	\$6
<b>Fuel Tank Variable Subtotal</b>	<b>\$/gal</b>	<b>\$67</b>
Opex Costs		
Fuel		
Fuel cost	\$/gal	\$3.498
Number of tanks burned per year	integer	1
Maintenance		
Annual contract	\$/year	\$1,000
Annual parts	\$/year	\$2,000
Monthly run time	Hours/month	2
Annual staff hours	Hours/year	24
Labor cost/hr	\$/Hour	\$50
Labor cost	\$/year	\$1,200
<b>Annual Maintenance Subtotal</b>	<b>\$/year</b>	<b>4,200</b>
Totals for given Genset Size		
<b>Total Genset CapEx</b>	<b>\$</b>	<b>\$350,000</b>
<b>Total Genset OpEx</b>	<b>\$/year</b>	<b>\$14,694</b>

# Diesel generator efficiency data



Generator Size (kW)	1/4 Load (gal/hr)	1/2 Load (gal/hr)	3/4 Load (gal/hr)	Full Load (gal/hr)	1/4 load	1/2 load	3/4 load	full load
20	0.6	0.9	1.3	1.6	0.120	0.090	0.087	0.080
30	1.3	1.8	2.4	2.9	0.173	0.120	0.107	0.097
40	1.6	2.3	3.2	4.0	0.160	0.115	0.107	0.100
60	1.8	2.9	3.8	4.8	0.120	0.097	0.084	0.080
75	2.4	3.4	4.6	6.1	0.128	0.091	0.082	0.081
100	2.6	4.1	5.8	7.4	0.104	0.082	0.077	0.074
125	3.1	5.0	7.1	9.1	0.099	0.080	0.076	0.073
135	3.3	5.4	7.6	9.8	0.098	0.080	0.075	0.073
150	3.6	5.9	8.4	10.9	0.096	0.079	0.075	0.073
175	4.1	6.8	9.7	12.7	0.094	0.078	0.074	0.073
200	4.7	7.7	11.0	14.4	0.094	0.077	0.073	0.072
230	5.3	8.8	12.5	16.6	0.092	0.077	0.072	0.072
250	5.7	9.5	13.6	18.0	0.091	0.076	0.073	0.072
300	6.8	11.3	16.1	21.5	0.091	0.075	0.072	0.072
350	7.9	13.1	18.7	25.1	0.090	0.075	0.071	0.072
400	8.9	14.9	21.3	28.6	0.089	0.075	0.071	0.072
500	11.0	18.5	26.4	35.7	0.088	0.074	0.070	0.071
600	13.2	22.0	31.5	42.8	0.088	0.073	0.070	0.071
750	16.3	27.4	39.3	53.4	0.087	0.073	0.070	0.071
1000	21.6	36.4	52.1	71.1	0.086	0.073	0.069	0.071
1250	26.9	45.3	65.0	88.8	0.086	0.072	0.069	0.071
1500	32.2	54.3	77.8	106.5	0.086	0.072	0.069	0.071
1750	37.5	63.2	90.7	124.2	0.086	0.072	0.069	0.071
2000	42.8	72.2	103.5	141.9	0.086	0.072	0.069	0.071
2250	48.1	81.1	116.4	159.6	0.086	0.072	0.069	0.071

Average over generator size (Gallons/kWh)      **0.101**      **0.081**      **0.076**      **0.075**

Average over load (Gallons/kWh)	<b>0.083</b>
---------------------------------	--------------

## Key VOR123 concepts

# Load Management is fundamental to VOR123



Although there are multiple potential Load Management configurations, the minimal functionality anticipated to be cost-effectively implemented is referred to as **the Critical Load Panel (CLP) approach**.

The CLP name reflects the requirement for a smart critical load panel that maintains Tier 1 loads indefinitely and toggles Tier 2 loads. In the CLP approach, Tier 3 loads will be toggled as a group by toggling power to the Main Service Board (MSB). Figure 9 illustrates the CLP approach for SMHS, with Tier 1 and Tier 2 loads being served by new dedicated wire runs that connect to a new smart critical load panel.

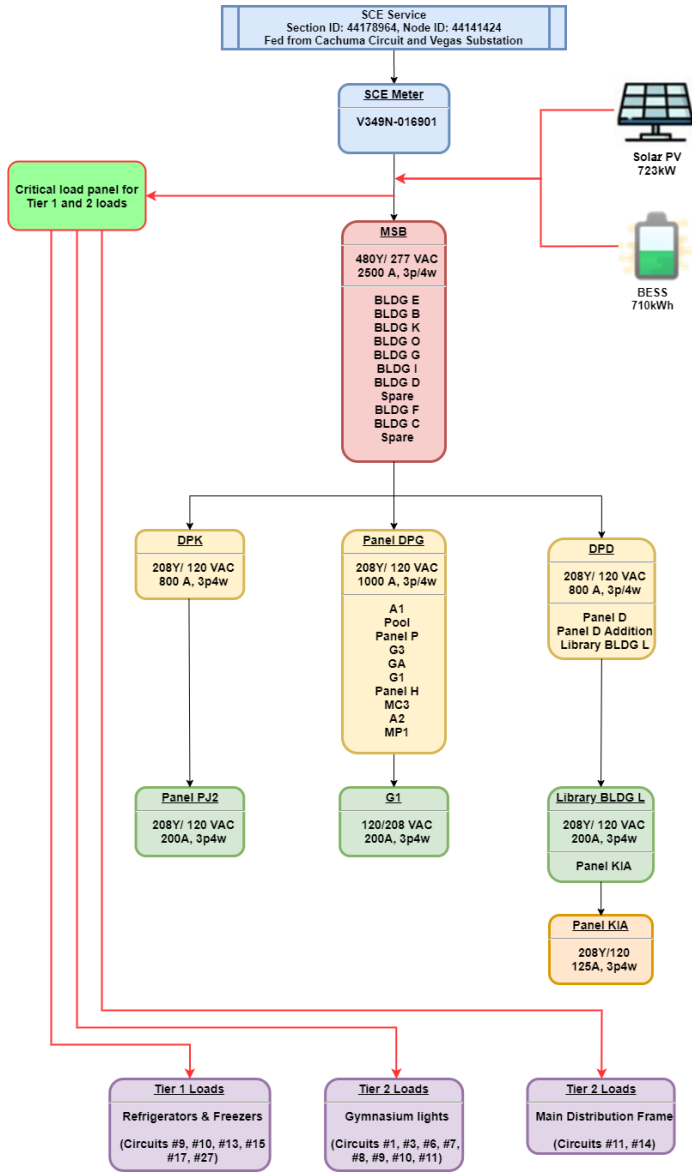

Top owner reserve is often in place to absorb battery energy storage system (BESS) degradation over time, while still delivering the contracted daily cycling energy capacity.

SOCr = the minimum state-of-charge (SOC) that is reserved for provisioning resilience. The SOCr can be dynamic and/or resized to between 0% and 100% of the contracted BESS energy capacity. A lower SOCr facilitates BESS operations that optimize daily economic performance, while a higher SOCr facilitates the provisioning of greater resilience.

Bottom owner reserve is often required to meet BESS warranty requirements that are imposed by BESS vendors.

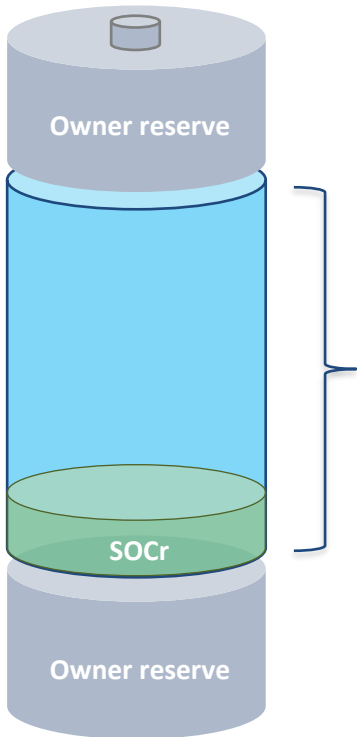

Contracted BESS energy capacity (kWh) that must be available for daily cycling over the contract duration for achieving specified economic & resilience performance.

### 5-day SOCr plot beginning Sat 12-Jan for San Marcos HS

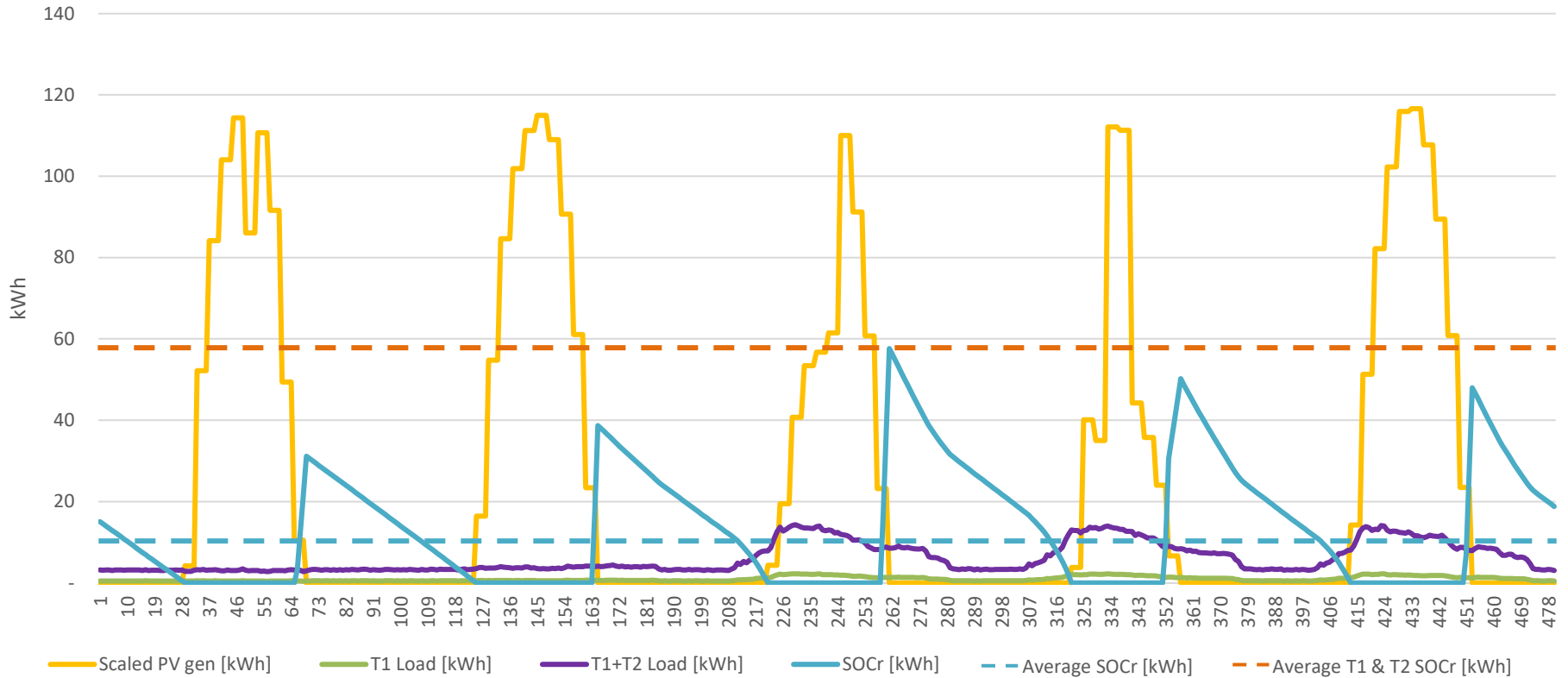

Goleta Load Pocket (GLP)  
Community Microgrid  
case study

# Goleta Load Pocket (GLP) and attaining resilience

The GLP is the perfect opportunity for a comprehensive Community Microgrid



- GLP spans 70 miles of California coastline, from Point Conception to Lake Casitas, encompassing the cities of Goleta, Santa Barbara (including Montecito), and Carpinteria.
- GLP is highly transmission-vulnerable and disaster-prone (fire, landslide, earthquake).
- **200 megawatts (MW) of solar and 400 megawatt-hours (MWh) of energy storage** will provide 100% protection to GLP against a complete transmission outage (“N-2 event”).
  - 200 MW of solar is equivalent to about 5 times the amount of solar currently deployed in the GLP and represents about 25% of the energy mix.
  - Multi-GWs of solar siting opportunity exists on commercial-scale built environments like parking lots, parking structures, and rooftops; and 200 MW represents about 7% of the technical siting potential.
  - Other resources like energy efficiency, demand response, and offshore wind can significantly reduce solar+storage requirements.

# Goleta Substation serves eight 66kV feeders



Goleta Substation serves eight 66kV feeders that in turn serve the entire GLP

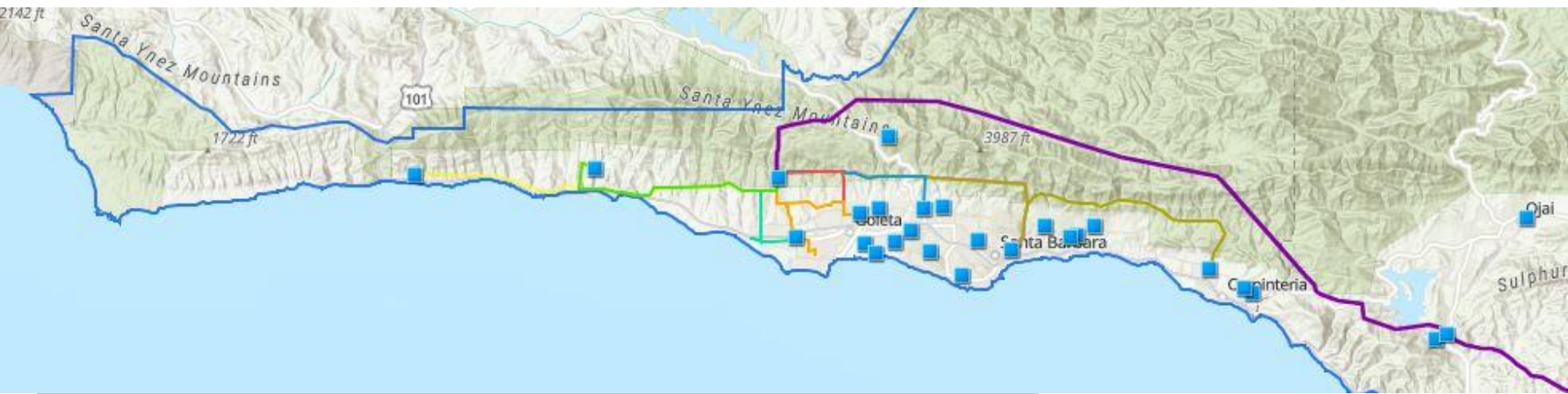

**Legend**

220 kV Transmission	Feeder #4157	Feeder #3559	Feeder #3565
Substations	Feeder #3556	Feeder #4169	Feeder #4311
SCE Service Area	Feeder #4156	Feeder #4227	

# Target 66kV feeder at the core of the GLP

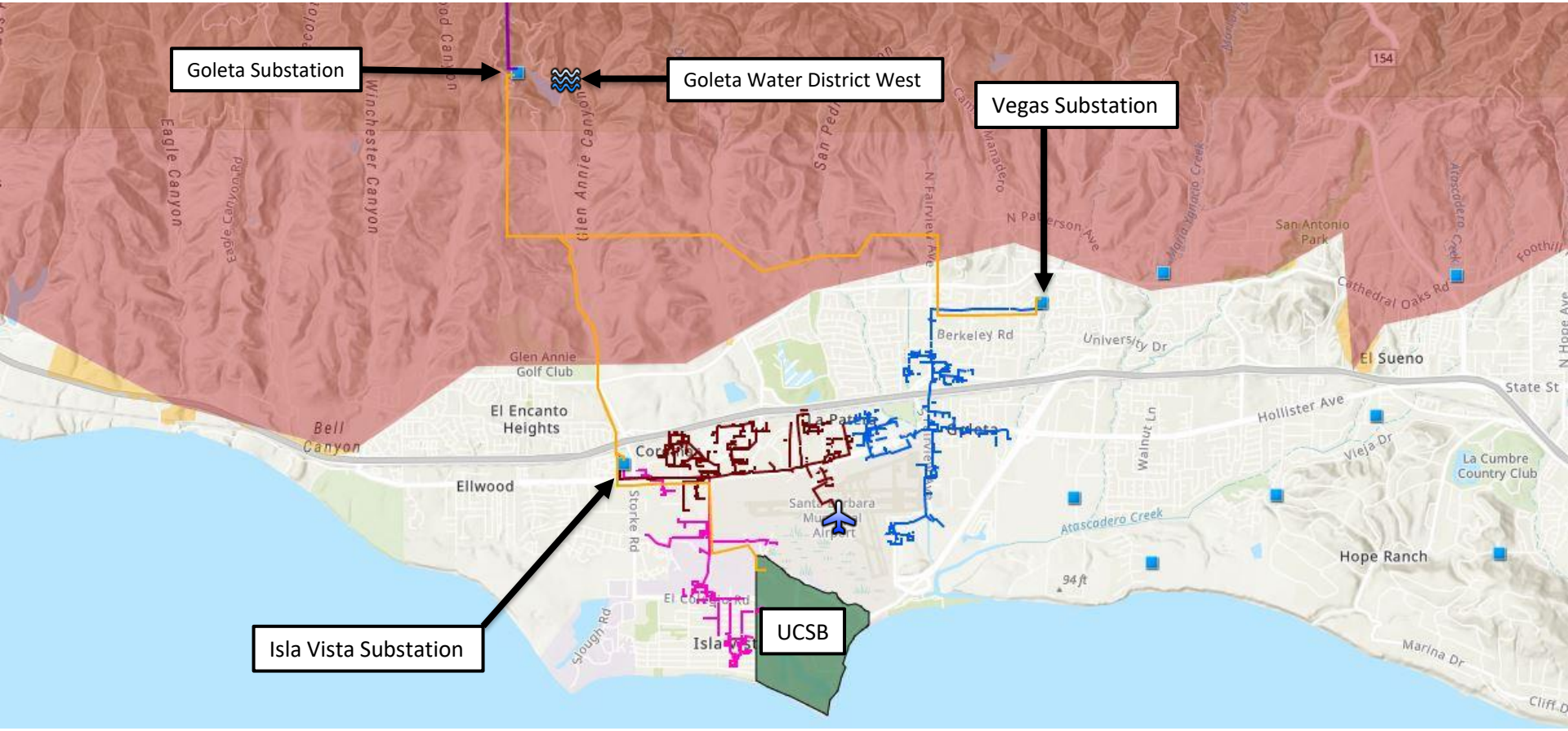

**Legend**

220 kV Transmission	16kV Gladiola Feeder	Tier 3 Fire Threat	Santa Barbara Airport
66 kV Feeder #4311	16kV Gaucho Feeder	Tier 2 Fire Threat	Sanitary or Water Districts
Substations	16kV Professor Feeder	University of California Santa Barbara (UCSB)	

# Target 66kV feeder serves critical GLP loads

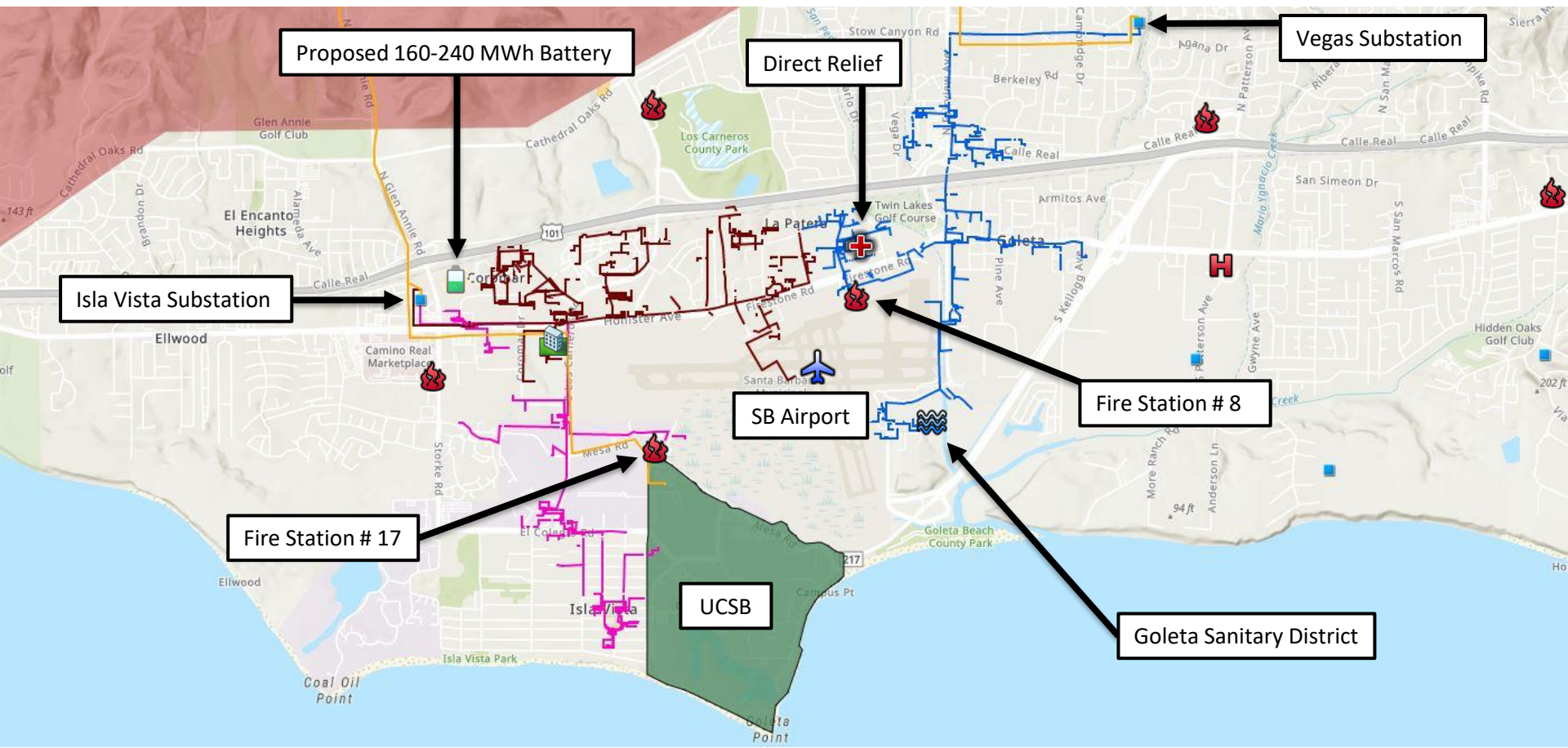

Legend			
	220 kV Transmission		16kV Gladiola Feeder
	16kV Gaucho Feeder		Tier 3 Fire Threat
	66 kV Feeder #4311		University of California Santa Barbara
	Substations		Fire Stations
	Santa Barbara Airport		Sanitary or Water Districts
			Goleta Valley Cottage Hospital
			Direct Relief
			Deckers
			Proposed 160-240 MWh Battery

# Target 66kV feeder grid area block diagram

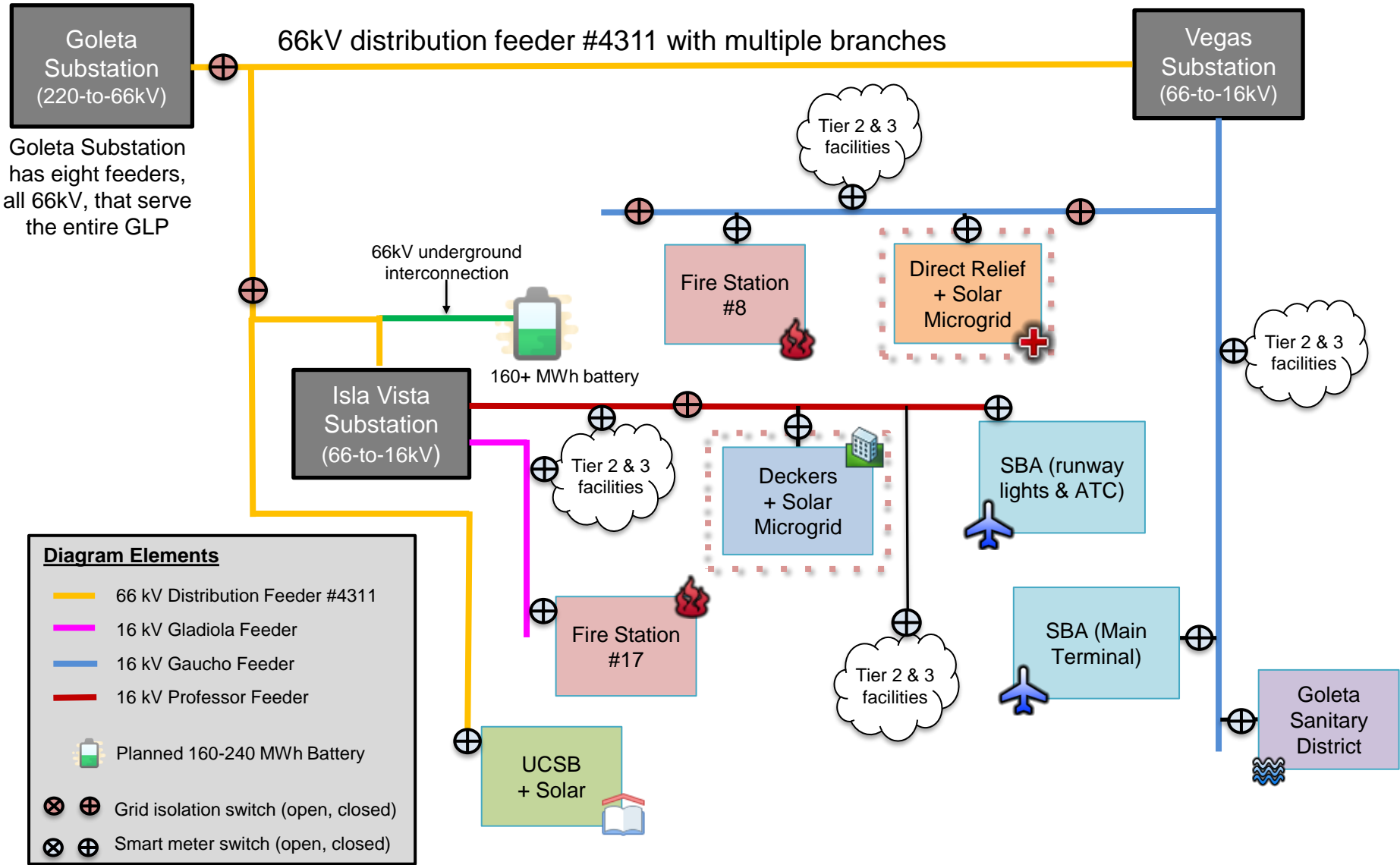

# Santa Barbara Unified School District (SBUSD) case study

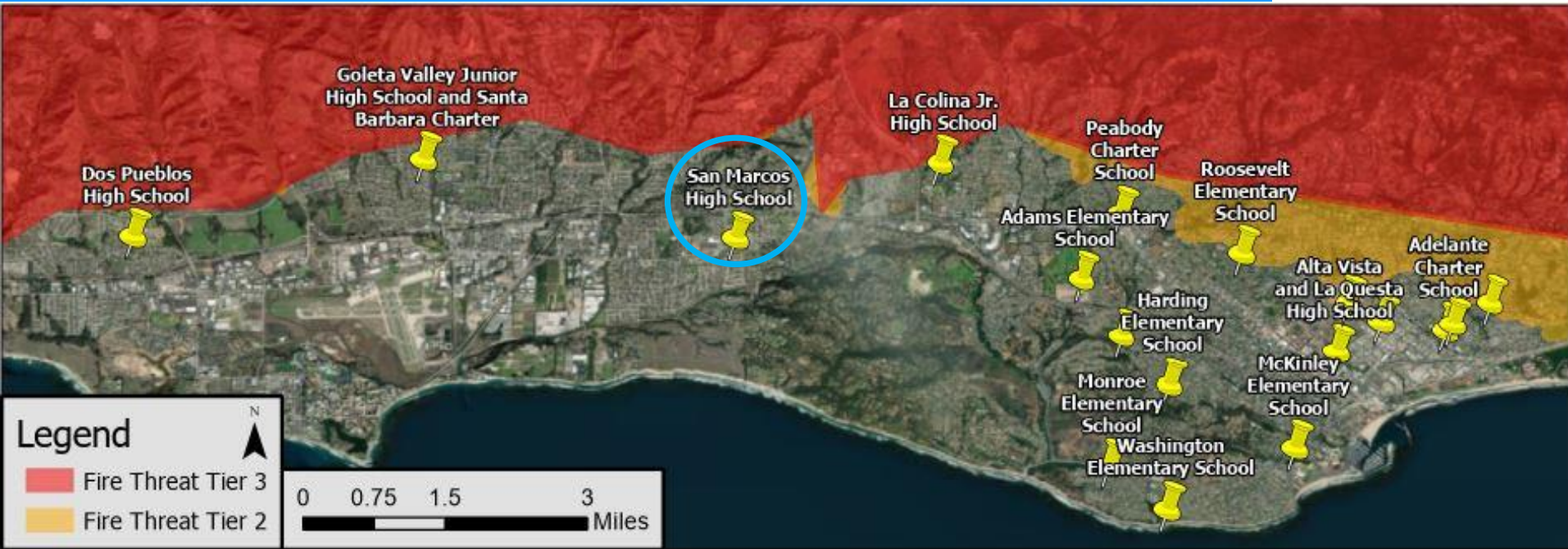

- The entire Santa Barbara region is surrounded by extreme fire risk (earthquake & landslide risk too) and is extremely vulnerable to electricity grid outages.
- The SBUSD is a major school district that increasingly recognizes the value-of-resilience (VOR) and has embraced the Clean Coalition's vision to implement Solar Microgrids at a number of its key schools and other critical facilities.
- SMHS is in the middle of the extensive SBUSD service area.

# Six SBUSD Solar Microgrid sites

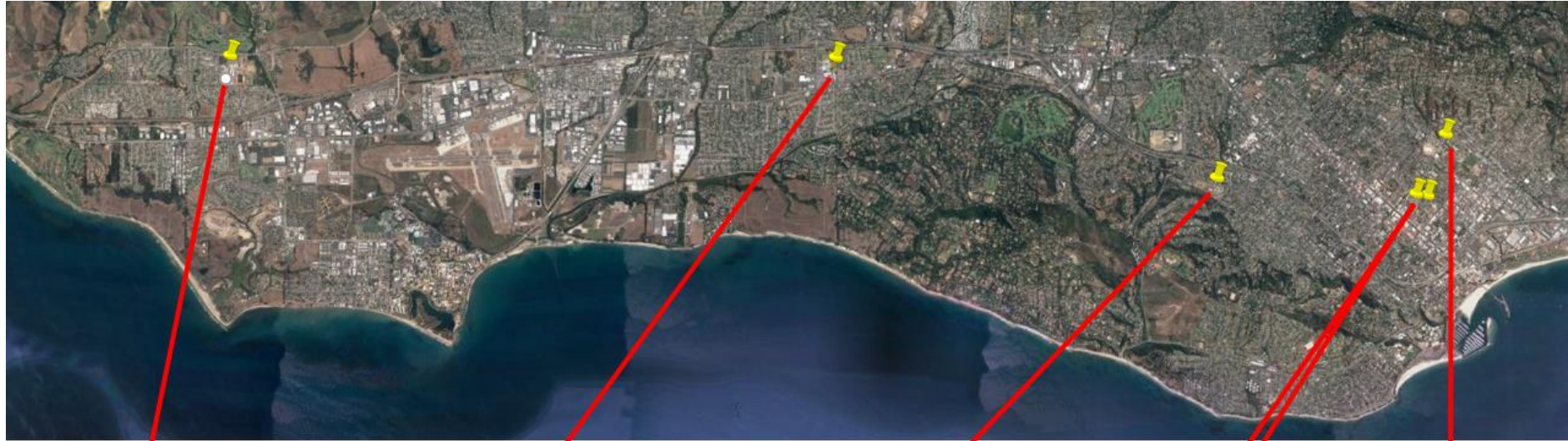

Dos Pueblos High School



San Marcos High School



La Cumbre Junior High School



District Food Warehouse  
& District Office



Santa Barbara High School

## Lifetime (28-year) Bill Savings and Added Value of Resiliency

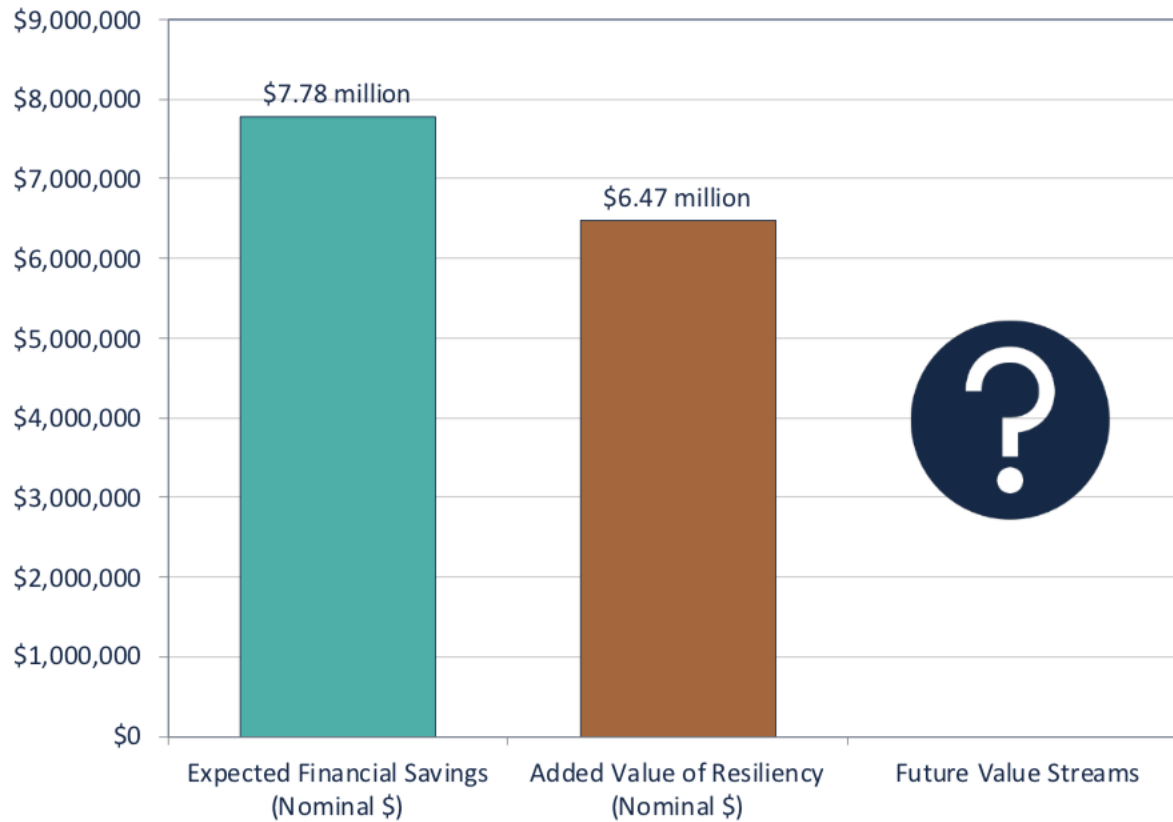

# San Marcos High School (SMHS) case study

# SMHS is vulnerable to distribution outages too

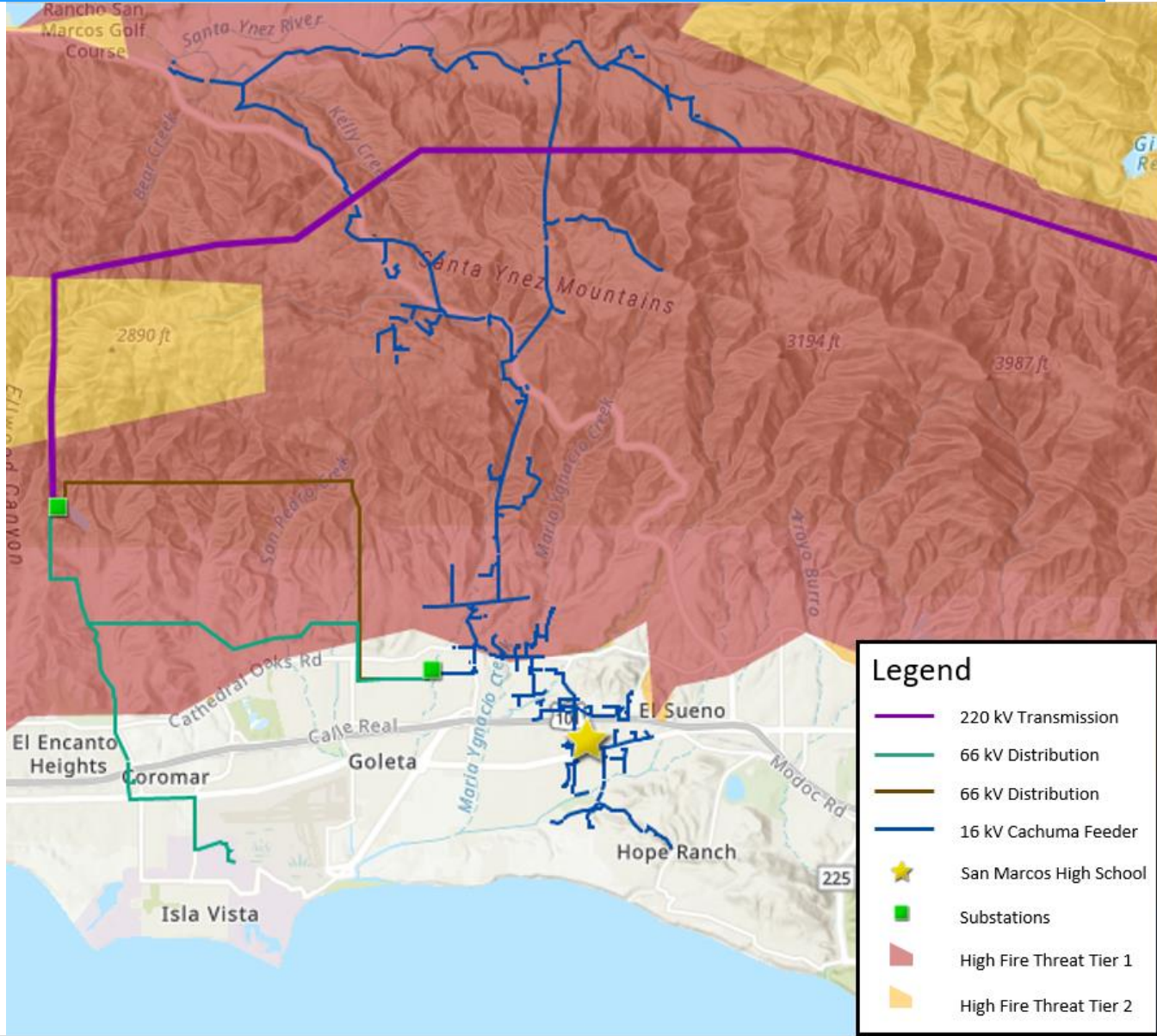

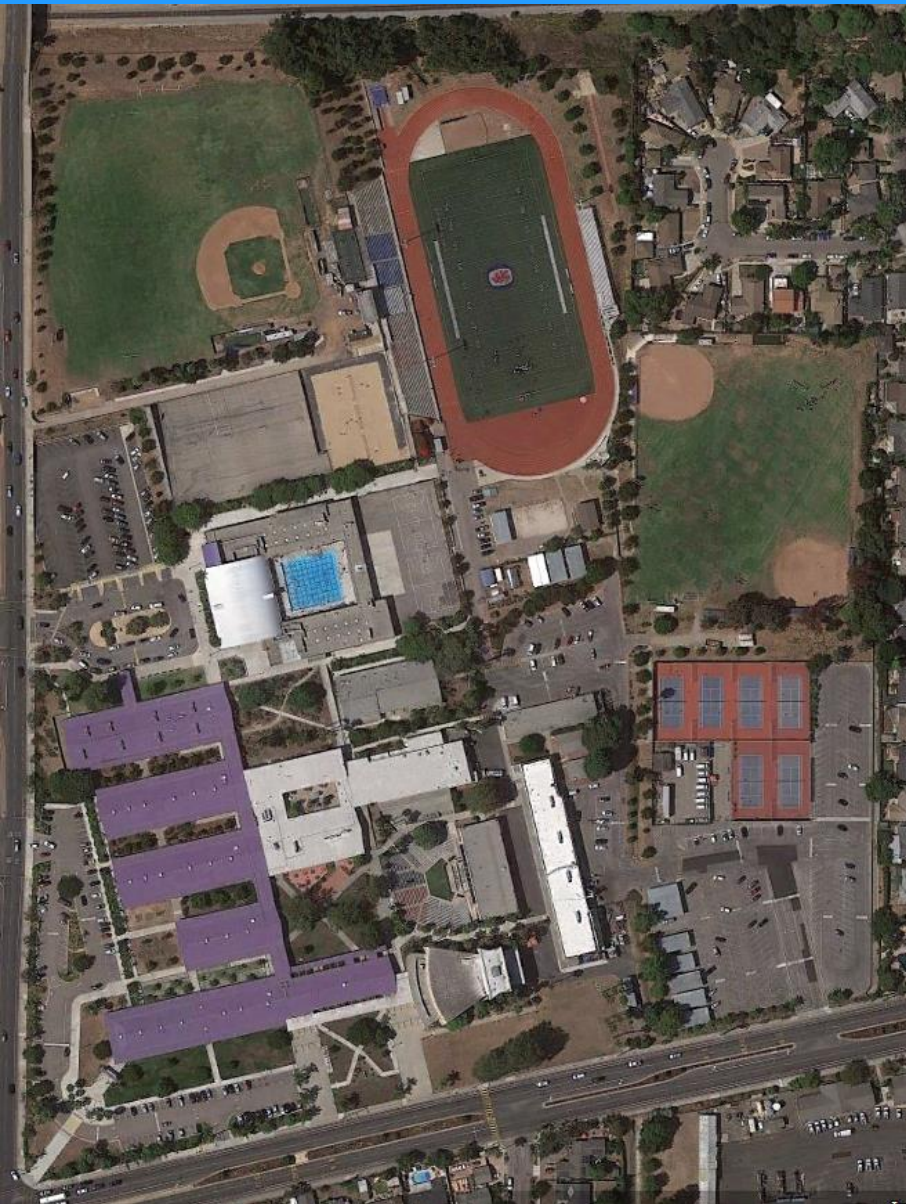

- SMHS is a large public high school serving 2,000+ students in grades 9 through 12.
- Red Cross designated facility.
- School features include:
  - Array of classroom buildings
  - Large pool
  - Gymnasium
  - Football stadium
  - Multiple baseball fields
  - Cafeteria
  - Outdoor Greek theater
  - Auditorium
  - Numerous tennis & basketball courts
- Craig Lewis in the Class of 1981.

The SMHS Solar Microgrid is intended to enable the school to operate independently during grid outages of any duration with **indefinite resilience for the most critical loads** and **resilience for all loads for significant percentages of time**.

- **Solar**
  - 725 kWp
  - Solar is entirely in the form of solar parking canopies
  - Net Zero Energy (NZE) is exceeded at 101%
- **Battery Energy Storage System (BESS)**
  - 700 kWh energy capacity
  - 350 kW power capacity
- **Critical (Tier 1) loads**
  - Food service refrigerators & freezers, maintained indefinitely
  - 4.36 kW of average load
  - 3.44% of total average load
- **Priority (Tier 2) loads**
  - Gym lights and Main Distribution Frame, maintained at least 80% of the time
  - 4.32 kW of average load
  - 3.41% of total average load

# SBUSD 2019 electricity costs & breakeven values

Site Name	2019 Cost & Values (¢/kWh)			
	Annual Cost/kWh	PV Value	PV+BESS Value	PV+BESS+ Resilience Value
Adams ES	17.8	12.7	14.5	19.0
Cleveland ES	18	12.2	13.4	17.9
Facilities & Maintenance Warehouse	15.8	11.6	16.4	20.4
SBUSD Office & La Cuesta HS	17.7	13.7	13.8	18.2
Dos Pueblos HS	14.9	10	12.2	15.9
Franklin ES (& Adelante Charter)	16.8	12	13.7	17.9
Goleta Valley JHS	16	11.5	12.5	16.5
La Colina JHS	16.2	12.1	13.1	17.2
La Cumbre JHS (& SB Community Academy)	15.6	12.2	12.9	16.8
Monroe ES	16.8	12.7	14.7	18.9
Roosevelt ES	17.8	12.6	16.1	20.6
Santa Barbara HS	14.5	11.9	14.6	18.2
Santa Barbara JHS	16.1	12.5	15.7	19.7
San Marcos HS	15.3	11.7	12.9	16.7
Washington ES	17.5	12.6	14.1	18.5
Weighted Average Total	16.1	11.6	13.5	17.5

# SBUSD 2020 costs & PPA estimates

Site Name	Year-1 PPA pricing, 3% escalator (¢/kWh)					
	Annual Cost/kWh	PV	PV+BESS	PV+BESS+ MLM	PV+BESS+ CLP	PV+BESS+F AM
Adams ES	17.8	13.0	15.5	18.5	22.5	23.5
Cleveland ES	18	14.0	15.5	22.0	29.0	31.0
Facilities & Maintenance Warehouse	14.9	13.5	13.5	13.5	19.0	20.5
SBUSD Office & La Cuesta HS	15.8	13.0	13.0	15.0	21.0	24.0
Dos Pueblos HS	16.8	10.5	11.5	12.0	12.5	13.0
Franklin ES (& Adelante Charter)	16	12.5	12.5	13.5	15.5	16.0
Goleta Valley JHS	16.2	12.0	13.5	15.0	17.5	18.5
La Colina JHS	17.7	12.0	13.5	15.5	18.5	20.0
La Cumbre JHS (& SB Community Academy)	15.6	12.0	12.0	13.0	15.0	16.5
Monroe ES	16.8	13.5	15.0	18.5	22.5	24.0
Roosevelt ES	17.8	13.0	16.0	18.5	22.5	23.5
Santa Barbara HS	15.3	11.5	12.5	13.5	14.5	15.5
Santa Barbara JHS	14.5	12.5	14.0	16.0	19.0	21.0
San Marcos HS	16.1	11.5	12.5	13.5	14.5	15.0
Washington ES	17.5	13.5	15.0	19.0	23.5	24.5
Weighted Average Total	16.1	11.7	12.8	14.1	16.0	17.0

## Notes

- Analyses estimated Power Purchase Agreement (PPA) pricing for three Load Management configurations, assuming 25-year PPAs starting in 2020 with 3% SCE electricity cost escalators.
- Solar Microgrid PPA prices in green are less than breakeven values, including 25% VOR123 adder.
- SCE raised its electricity costs by about 7% in 2019 and is proposing similar increases in each of the next three years.