







2019/20

COMPLETE PRODUCT RANGE



SYMBOLS & ABBREVIATIONS

	Skyline
	Mainline
	Weight
	Payload
	Uphill yarding
	Downhill yarding
SKA	Change of direction (about 1-2 m) triggers the clamps of the skyline clamp
ZIR	Through a time interval control, the change of direction system can be replaced. Release time of 3 to 25 seconds.
Z	Through a radio control system, the clamping operation between the Skyline- and mainlineclamp can be done any time even with released choker system.

K 300-T – TRACTOR MOUNTED YARDER FOR UPHILL LOGGING	4-5
K 300-H – TRAILER MOUNTED YARDER FOR UPHILL LOGGING	6-7
K 301-T – TRACTOR MOUNTED YARDER FOR UPHILL LOGGING	8-9
K 301-H – LIGHTWEIGHT & COMPACT TOWER YARDER FOR UPHILL LOGGING	10-11
K 307c-H – TRAILER UNIT FOR UPHILL- & DOWNHILL LOGGING	12-13
K 307-GH – TRUCK MOUNTED YARDER FOR UPHILL- & DOWNHILL LOGGING WITH PROCESSOR CRANE	14-15
KX 304 – EXCAVATOR BASED TOWER YARDER FOR UPHILL- & DOWNHILL LOGGING	16-17
K 507e-H – HYBRID YARDER	18-19
K 507-S – TRUCK MOUNTED YARDER FOR UPHILL & DOWNHILL LOGGING	20-21
K 507-X – TRACK BASED VERSION FOR UPHILL- & DOWNHILL LOGGING	22-23
K 507-GH – TRUCK BASED VERSION FOR UPHILL- & DOWNHILL LOGGING WITH PROCESSOR CRANE	24-25
K 602c-H – TRAILER MOUNTED YARDER FOR UPHILL- & DOWNHILL LOGGING	26-27
K 602-GH – TRUCK MOUNTED TOWER YARDER FOR UPHILL LOGGING WITH CRANE & PROCESSOR HEAD	28-29
K 602-A – TRUCK OR TRAILER MOUNTED YARDER FOR UPHILL LOGGING	30-31
K 702-A – CHASSIS FOR UPHILL- & DOWNHILL LOGGING	32-33
KX 800e – EXCAVATOR BASED HIGH PERFORMANCE HYBRID YARDER	34-35
CARRIAGES FOR UPHILL LOGGING	36
SLACK PULLING CARRIAGES FOR UPHILL & DOWNHILL LOGGING	37
ELECTRICAL SLACK PULLER	38
MOTORIZED SLACK PULLER	39



3 GUYLINE WINCHES

LIGHTWEIGHT LATTICE TUBE CONSTRUCTION

TURNABLE TOWERHEAD

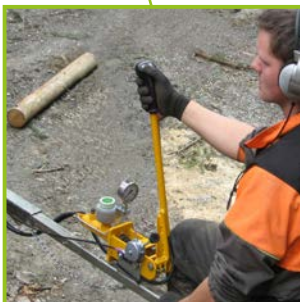

SINGLE-HAND OPERATION



ROBUST GEAR UNIT



HYDRAULIC TOWERLIFT

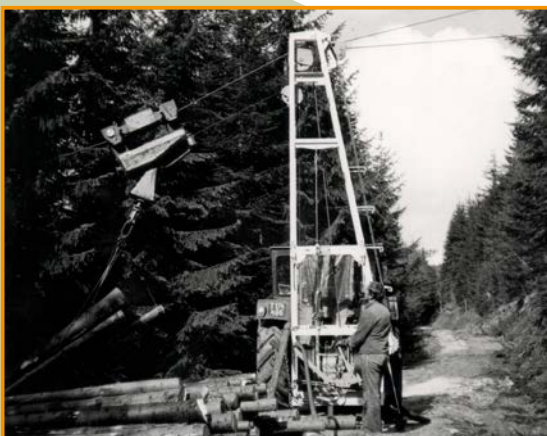

1979



1980



1986

The **K 300-T** is an internationally proven tractor / 3-point mounted yarder for uphill logging. It assures easy handling, reliable and rugged design, as well as short set up and dismantling times.

SPECIFICATIONS

LINE CAPACITY	STANDARD	ALTERNATIVE	LINE PULL
Skyline	1650' Ø 9/16" · 500 m Ø 14 mm swaged	1320' Ø 5/8" · 420 m Ø 15 mm	Skyline 4.48 t · 44 kN
Mainline	2260' Ø 5/16" · 550 m Ø 8 mm swaged	1480' 3/8" · 450 m Ø 9,5 mm swaged	Mainline 1.83 t · 18 kN
Guyline	3x100' Ø 5/8" / 2x30' 3x30 m Ø 16 mm / 2x10 m extensions	—	

LINE SPEED	
Without payload	user defined by brake
With payload	up to 705 ft/min · 215 m/min

POWER STATION	TOWER
· P.T.O. of the tractor (mechanically driven)	Standard 24' · 7.2 m
· Engine power of the tractor: minimum 49 HP (36 kW)	Tower extension 28' · 8.4 m
· Hydraulically operated single disk dry clutches on both drums	Operating range on the left side of the yarder

FEATURES

- Three-point attachment
- Most built yarder of all times
- Longlife components
- With CE-compliant integrated deadman circuit
- Often proven because of the robust and simple design
- Foldable tower 1.2 m (optional)
- Easy maintenance
- Worldwide in use
- Compact and reliable

CARRIAGE

	SKA 1	SKA 1-Z
	Ø 1/2"-1" · Ø 12-24 mm	Ø 1/2"-1" · Ø 12-24 mm
	Ø 5/16"-7/16" · Ø 8-11 mm	Ø 5/16"-7/16" · Ø 8-11 mm
	approx. 350 lbs · 160 kg	approx. 420 lbs · 190 kg
	approx. 1.5 t	approx. 1.5 t



1992

1998

TODAY



OVERRUN BRAKE



SIMPLE CONTROL



HAULBACKLINE (optional)



EASY ACCESSIBLE



CLEAN ANCHORING

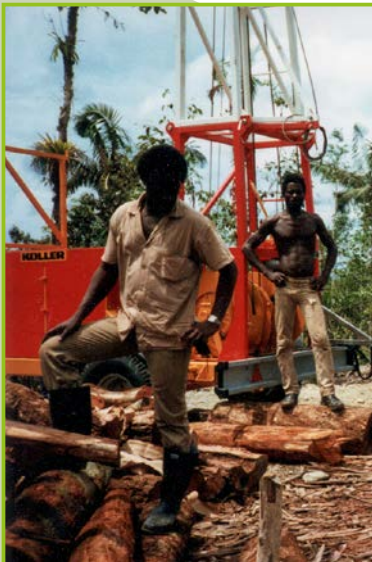



The **K 300-H** is a yarder for uphill logging with an optional haulbackline drum (K303H). Also for downhill logging and for flat terrain. It assures easy handling, reliable and rugged design, as well as very short set up and dismantling times.

SPECIFICATIONS

LINE CAPACITY	STANDARD	ALTERNATIVE	LINE PULL
Skyline	1650' Ø 9/16" · 500 m Ø 14 mm swaged	1320' Ø 5/8" · 420 m Ø 15 mm swaged	Skyline 4.48 t · 44 kN
Mainline	2260' Ø 5/16" · 550 m Ø 8 mm swaged	1480' Ø 3/8" · 450 m Ø 9,5 mm swaged	Mainline 1.83 t · 18 kN
Haulbackline	2900' Ø 3/8" · 970 m Ø 9 mm	2050' Ø 7/16" · 800 m Ø 10 mm	Haulbackline 1.83 t · 18 kN
Guyline	3x100' Ø 5/8" / 2x30' 3x30 m Ø 16 mm / 2x10 m extensions	4x100' Ø 5/8" / 2x30' 4x30 m Ø 16 mm / 2x10 m extensions	

LINE SPEED

Without payload	user defined by brake
With payload	up to 1115 ft/min · 340 m/min

POWER STATION

- Deutz 4-cylinder diesel engine with 101 HP (75 kW)
- Emission class EU-STAGE II
- Continuous hydrostatic transmission for all winches
- Hydraulically operated single disk dry clutches on the skyline / mainline drum and oil motor on the haulbackline drum

TOWER

Standard	24' · 7.2 m
Tower extension	28' · 8.4 m
Operating range	on the left side of the yarder

FEATURES

- Dead man's circuit
- Compact and reliable
- Lightweight and compact trailer unit
- Often proven because of the robust and simple design
- Overrun brake
- Foldable tower 1.2 m (optional)
- Available as a uphill- and downhill yarder (optional)

CARRIAGE

	SKA 1	SKA 1-Z	USKA 1,5
	Ø 1/2"-1" · Ø 12-24 mm	Ø 1/2"-1" · Ø 12-24 mm	Ø 9/16"-1" · Ø 14-24 mm
	Ø 5/16"-7/16" · Ø 8-11 mm	Ø 5/16"-7/16" · Ø 8-11 mm	Ø 3/8"-7/16" · Ø 9-11 mm
	approx. 350 lbs · 160 kg	approx. 420 lbs · 190 kg	approx. 760 lbs · 345 kg
	approx. 1.5 t	approx. 1.5 t	approx. 1.5 t





4 GUYLINE WINCHES



WITH FOLDABLE TOWER (optional)



NEATLY ARRANGED WINCHES



P.T.O. SHAFT



SIMPLE CONTROL





The **K 301-T** is a tractor / 3-point mounted yarder for uphill logging. It assures easy handling, reliable and rugged design, as well as very short set up and dismantling time. Particularly suitable for thinning and small wood harvesting operations.

SPECIFICATIONS

LINE CAPACITY	STANDARD	ALTERNATIVE	LINE PULL	
Skyline	1700' Ø 5/8" · 500 m Ø 16 mm swaged	1150' Ø 3/4" · 400 m Ø 18 mm swaged	Skyline	5.09 t · 50kN
Mainline	1800' Ø 3/8" · 630 m Ø 9 mm swaged	1250' Ø 7/16" · 500 m Ø 10 mm swaged	Mainline	2.65 t · 26 kN
Guyline	4x160' Ø 5/8" / 2x30' 4x50 m Ø 16 mm / 2x10 m extensions	-		

LINE SPEED

Without payload	user defined by brake
With payload	up to 605 ft/min · 185 m/min

POWER STATION

- P.T.O. driven of the tractor (mechanically driven)
- Engine power of the tractor: 66 kW (90 hp) with an auxiliary transmission
- Mainline- and skylinedrums are each driven by hydraulically operated single-disc Dry clutches coupled to the common constantly rotating winch shaft

TOWER

Standard	28' · 8.5 m
Tower extension	32' · 9.7 m
Operating range	360°

FEATURES

- 4 guylines
- Easy handling
- Great distance coverage
- Compact and cost effective solution
- With three-point mounting
- Working direction on both sides of the vehicle possible
- With CE-compliant integrated deadman circuit
- Foldable tower 1.2 m (optional)

CARRIAGE

	SKA 1	SKA 1-Z
	Ø 1/2"-1" · Ø 12-24 mm	Ø 1/2"-1" · Ø 12-24 mm
	Ø 5/16"-7/16" · Ø 8-11 mm	Ø 5/16"-7/16" · Ø 8-11 mm
	approx. 350 lbs · 160 kg	approx. 420 lbs · 190 kg
	approx. 1.5 t	approx. 1.5 t





FOLDABLE TOWER (optional)



PROTECTED TANK



ROBUST WINCH UNIT



4 GUYLINES



The **K 301-H** is a tractor / 3-point mounted yarder for uphill logging. It assures easy handling, reliable and rugged design, as well as very short set up and dismantling time. Particularly suitable for thinning and small wood harvesting operations.

SPECIFICATIONS

LINE CAPACITY	STANDARD	ALTERNATIVE	LINE PULL	
Skyline	1700' Ø 5/8" · 550 m Ø 16 mm swaged	1150' Ø 3/4" · 400 m Ø 18 mm swaged	Skyline	5.09 t · 50 kN
Mainline	1250' Ø 7/16" · 500 m Ø 10 mm swaged	1800' Ø 3/8" · 630 m Ø 9 mm swaged	Mainline	2.65 t · 26 kN
Guyline	4x160' Ø 5/8" / 2x33' 4x50 m Ø 16 mm / 2x10 m extensions	-		

LINE SPEED

Without payload	user defined by brake
With payload	up to 1115 ft / min · 340 m/min

POWER STATION

- Cummins QSB 4.5 diesel engine (EU-STAGE III A) with 110 PS
- Allison AT545 automatic transmission
- Cardan shaft
- Worm gear

TOWER

Standard	28' · 8.5 m
Tower extension	32' · 9.7 m
Operating range	360°

FEATURES

- Easy handling
- Proven components
- Powerful transmission for the mainline
- Large lockable storage spaces
- Hydraulic tower lift
- 180 Ah accumulators for a safe start at any temperature
- 200 liter diesel tank
- Optimal maintenance accessibility
- Cost effective
- Foldable tower 1.2 m (optional)

CARRIAGE

	SKA 1 	SKA 1-Z 
	Ø 1/2"-1" · Ø 12-24 mm	Ø 1/2"-1" · Ø 12-24 mm
	Ø 5/16"-7/16" · Ø 8-11 mm	Ø 5/16"-7/16" · Ø 8-11 mm
	approx. 350 lbs · 160 kg	approx. 420 lbs · 190 kg
	approx. 1.5 t	approx. 1.5 t





POWERFUL & ROBUST RADIAL COUPLING

CARRIAGE SUPPORT

MAINTENANCE FRIENDLY ENGINE COVER

FOLDABLE MAINLINE PULLEY FOR 360°



HYDRAULIC SUPPORT



CONTROL UNIT



FOLDABLE TOWER (optional)

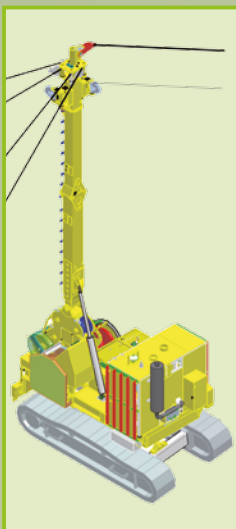



The **K 307c-H** is a handy tower yarder for uphill- and downhill yarding with optional haulback winch. It is mainly used for thinning and pre-use, but can also be used in end use operations.

SPECIFICATIONS

LINE CAPACITY	STANDARD	ALTERNATIVE	LINE PULL
Skyline	2800' Ø 5/8" · 840 m Ø 16 mm swaged	2165' Ø 3/4" · 660 m Ø 18 mm swaged	Skyline 7.14 t · 70 kN
Mainline	2500' Ø 3/8" · 840 m Ø 9 mm swaged	2165' Ø 7/16" · 660 m Ø 10 mm swaged	Mainline 3.06 t · 30 kN
Haulbackline	5400' Ø 3/8" · 1850 m Ø 9 mm swaged	4250' Ø 7/16" · 1500 m Ø 10 mm swaged	Haulbackline 3.06 t · 30 kN
Strawline	6800' Ø 3/16" · 1900 m Ø 5 mm	4430' Ø 1/4" · 1350 m Ø 6 mm	
Guyline	4x160' Ø 5/8" / 2x30' 4x50 m Ø 16 mm / 2x10 m extensions	-	

LINE SPEED

Without payload	up to 2100 ft / min · 640 m/min
With payload	up to 1150 ft / min · 350 m/min

POWER STATION

- 6-cylinder Cummins diesel engine with 168 kW (approx. 225 hp) power (TIER 5)
- Stepless hydrostatic drive for all winches
- Mainline- and skyline drums are each driven by hydraulically operated by pneumatic radial clutches coupled to the common constantly rotating winch shaft
- Very fast setup
- Long service intervals

TOWER

Standard	33' · 10.2 m
With foldable tower	33' · 10.2 m
Operating range	360°

FEATURES

- Fully automated with radio remote control
- Hydraulic oil micro filter system for longer service intervals and longer service life
- Foldable tower (optional)
- Almost maintenance free radial couplings
- Great range and high speeds
- No feed out of the mainline rope due to the pulley folding mechanism
- Wireless module to carry the display into the follower (optional)
- Mounting radio control (optional)
- Haulbackline winch and assembly winch with cable slack protection

CARRIAGE

	SKA 1-Z	USKA 1,5	ECKO FLEX	ECKO UP
	Ø 1/2"-1" · Ø 12-24 mm	Ø 9/16"-1" · Ø 14-24 mm	Ø 5/8"-3/4" · Ø 15-19 mm	Ø 5/8"-3/4" · Ø 15-19 mm
	Ø 5/16"-7/16" · Ø 8-11 mm	Ø 3/8"-7/16" · Ø 9-11 mm	Ø 3/8"-7/16" · Ø 9-10 mm	Ø 3/8"-7/16" · Ø 9-10 mm
	approx. 420 lbs · 190 kg	approx. 760 lbs · 345 kg	approx. 1322 lbs · 600 kg	approx. 1102 lbs · 500 kg
	approx. 1.5 t	approx. 1.5 t	approx. 2.0 t	approx. 1.5 t



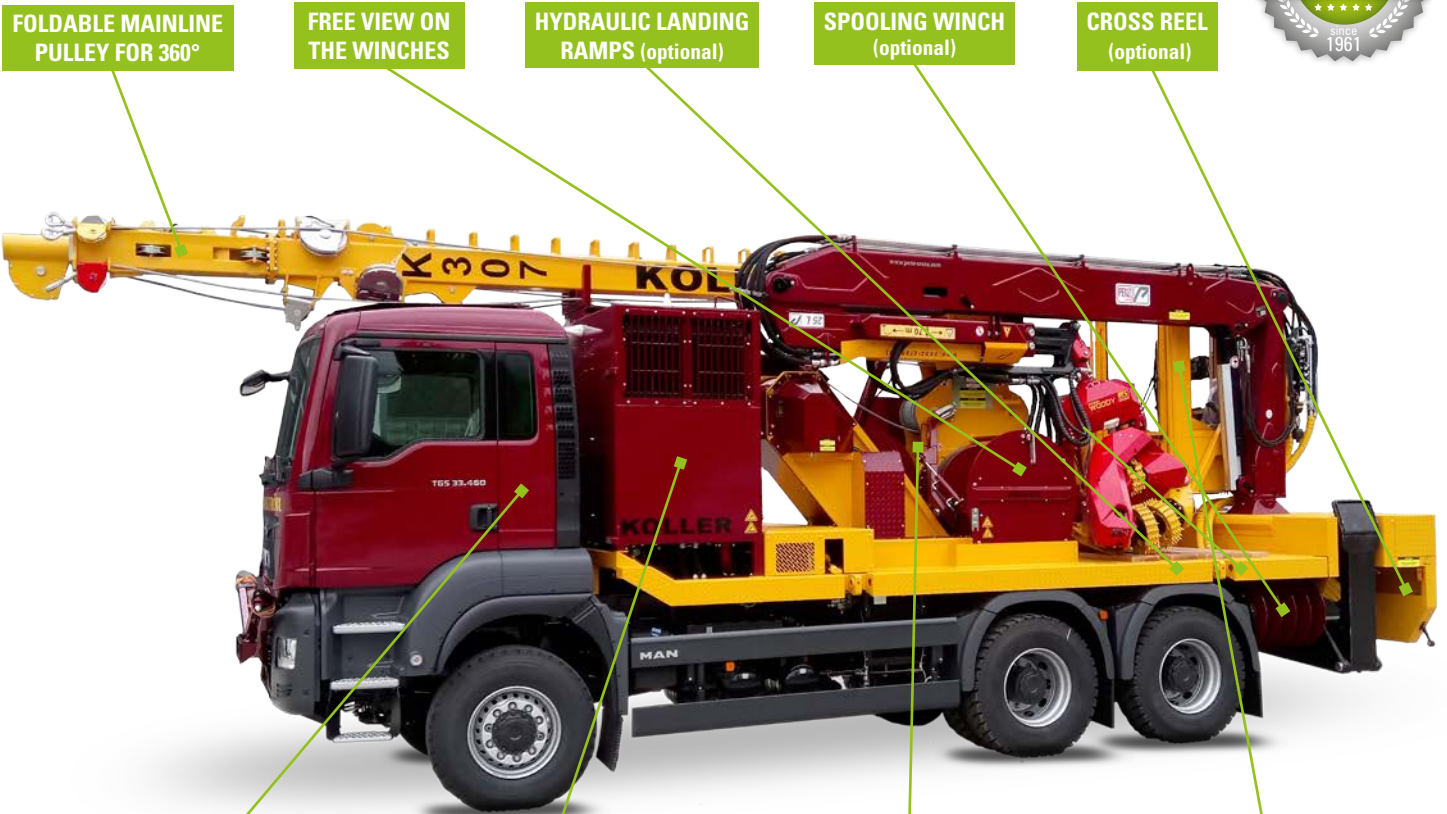

FOLDABLE MAINLINE PULLEY FOR 360°

FREE VIEW ON THE WINCHES

HYDRAULIC LANDING RAMPS (optional)

SPOOLING WINCH (optional)

CROSS REEL (optional)



CAB GUARD (optional)



LARGE TOOL BOX



HYDRAULIC SKYLINE GUIDANCE



ERGONOMIC CABIN

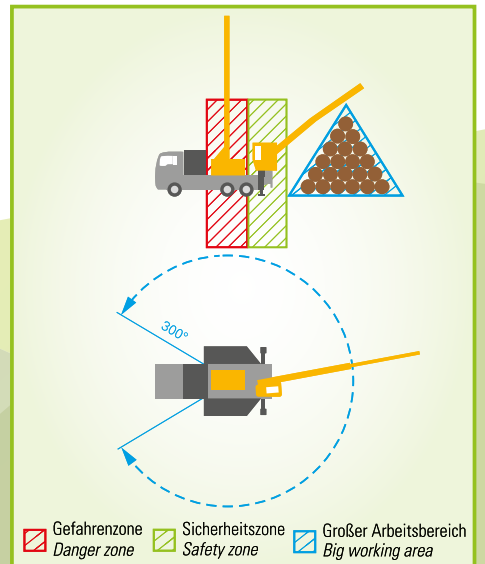



The **K 307-GH** is a compact tower yarder for uphill- and downhill yarding with optional haulback winch. It is mainly used for thinning and pre-use, but can also be used in end use. A transfer can be done only by one person.

SPECIFICATIONS

LINE CAPACITY	STANDARD	ALTERNATIVE	LINE PULL
Skyline	2800' Ø 5/8" · 840 m Ø 16 mm swaged	2165' Ø 3/4" · 660 m Ø 18 mm swaged	Skyline 7.14 t · 70 kN
Mainline	2500' Ø 3/8" · 840 m Ø 9 mm swaged	2165' Ø 7/16" · 660 m Ø 10 mm swaged	Mainline 3.06 t · 30 kN
Haulbackline	5400' Ø 3/8" · 1850 m Ø 9 mm swaged	4250' Ø 7/16" · 1500 m Ø 10 mm swaged	Haulbackline 3.06 t · 30 kN
Strawline	6800' Ø 3/16" · 1900 m Ø 5 mm	4430' Ø 1/4" · 1350 m Ø 6 mm	
Guyline	4x160' Ø 5/8" / 2x30' · 4x50 m Ø 16 mm / 2x10 m extensions	-	

LINE SPEED

Without payload	up to 2100 ft / min · 640 m/min
With payload	up to 1150 ft / min · 350 m/min

POWER STATION

- Truck diesel engine with e.g. 338 kW (460 hp) power (EURO6)
- Stepless hydrostatic drive for all winches
- Use of the direct (gearbox-independent) power take-off. It has been designed so that the full engine power can be used.
- Mainline- and skyline drums are each driven by hydraulically operated by pneumatic radial clutches coupled to the common constantly rotating winch shaft

TOWER

Standard	33' · 10.2 m
Operating range	360°

CRANE

Radius	31' · 9.4 m
--------	-------------

FEATURES

- Cabin
 - Very ergonomic design
 - Air-suspension comfort seat
 - Front and side entry
 - Temperature-controlled auxiliary heating
 - Air conditioning
 - Glazing with bullet-resistant polycarbonate panes in dangerous places (12/19 mm)
 - Tested cabin
 - Safety sensor on the front door
- Additional diesel fuel tank and fuel transfer pump (optional)
- Two hydraulically operated landing ramps (optional)
 - Robust and anti-slip construction
- Truck cab protection (optional)
 - Two large landing ramps
- Spooling winch or storage drum for guyline extensions (optional)
- Hydraulic oil micro filter system for longer maintenance intervals and longer service life
- Mounting radio (optional)
- Haulbackline winch and assembly winch with cable slack protection
- Very fast setup
- Long service intervals

CARRIAGE

	SKA 1-Z	USKA 1,5	ECKO FLEX	ECKO UP
	Ø 1/2"-1" · Ø 12-24 mm	Ø 9/16"-1" · Ø 14-24 mm	Ø 5/8"-3/4" · Ø 15-19 mm	Ø 5/8"-3/4" · Ø 15-19 mm
	Ø 5/16"-7/16" · Ø 8-11 mm	Ø 3/8"-7/16" · Ø 9-11 mm	Ø 3/8"-7/16" · Ø 9-10 mm	Ø 3/8"-7/16" · Ø 9-10 mm
	approx. 420 lbs · 190 kg	approx. 760 lbs · 345 kg	approx. 1322 lbs · 600 kg	approx. 1102 lbs · 500 kg
	approx. 1.5 t	approx. 1.5 t	approx. 2.0 t	approx. 1.5 t





NO GUYLINES NECESSARY



GOOD ACCESSIBLE WINCH UNIT



NEAT CONTROL UNIT



FAST ASSEMBLY OF THE TOWER





The **KX 304** is an excavator-based yarder for uphill as well as for downhill operations with an optional strawline. It is mainly used for thinning and pre-use but can also be used in end use. The set up time is very short because no guylines are necessary.

SPECIFICATIONS

LINE CAPACITY	STANDARD	ALTERNATIVE	LINE PULL
Skyline	2230' Ø 3/4" · 680 m Ø 18 mm swaged	–	Skyline 7.30 t · 72 kN
Winch W1+W2	5400' Ø 3/8" · 1830 m Ø 9 mm swaged	4200' Ø 7/16" · 1458 m Ø 10 mm swaged	Mainline 3.06 t · 30 kN
Haulbackline	5400' Ø 3/8" · 1830 m Ø 9 mm swaged	4200' Ø 7/16" · 1458 m Ø 10 mm swaged	Haulbackline 3.06 t · 30 kN
Strawline	6800' Ø 7/16" · 1900 m Ø 6 mm	–	

LINE SPEED

up to 2165 ft/min · 660 m/min

POWER STATION

- Excavator as carrier vehicle with 183 hp
- Emission class EU-STAGE V (depending on target market)
- Chain chassis
- Stepless hydrostatic drive for all winches

TOWER

Standard	28' · 8.5 m
Operating range	in arm direction

FEATURES

- High speeds and high excavator performance for maximum delivery performance with extremely low fuel consumption
- Ergonomic operation from the cab with automatic route programming
- Ideal for road transport with removable tower via fast coupling system and low transport height of 3.3m at 2.99m width
- Ideal height for transport on a low loader
- Low maintenance costs
- Fast route assembly and always a safe stand
- Haulbackline winch and assembly winch with cable slack protection
- With KollerMultiMatik - radio remote control (optional)
- No guylines necessary

CARRIAGE

	SKA 1-Z	USKA 1,5	ECKO FLEX	ECKO UP
	Ø 1/2"-1" · Ø 12-24 mm	Ø 9/16"-1" · Ø 14-24 mm	Ø 5/8"-3/4" · Ø 15-19 mm	Ø 5/8"-3/4" · Ø 15-19 mm
	Ø 5/16"-7/16" · Ø 8-11 mm	Ø 3/8"-7/16" · Ø 9-11 mm	Ø 3/8"-7/16" · Ø 9-10 mm	Ø 3/8"-7/16" · Ø 9-10 mm
	approx. 420 lbs · 190 kg	approx. 760 lbs · 345 kg	approx. 1322 lbs · 600 kg	approx. 1102 lbs · 500 kg
	approx. 1.5 t	approx. 1.5 t	approx. 2.0 t	approx. 1.5 t





SMALL ENGINE FOR A LOW FUEL CONSUMPTION



WINCHES WITH A CONSTANT PULL



STORAGE BOXES



INTERNALLY GUIDED GUYLINES



CLEAR DISPLAY





The **K 507e-H** is a revolution from Koller. The winches are driven purely by electric motors. A small diesel engine drives the generator. A constant pulling force is possible over all layers. The technology combines maximum flexibility with the lowest possible consumption!

SPECIFICATIONS

LINE CAPACITY		STANDARD	LINE PULL	
Skyline		3280' Ø 3/4" · 1000 m Ø 18 mm swaged	Skyline	9.68 t · 95 kN (constant)
Mainline		6560' Ø 7/16" · 2000 m Ø 10 mm swaged	Mainline	3.06 t · 30 kN (constant)
Haulbackline		6560' Ø 7/16" · 2000 m Ø 10 mm swaged	Haulbackline	3.06 t · 30 kN (constant)
Strawline		6560' Ø 1/4" · 2000 m Ø 6 mm		
Guyline		4x250' Ø 3/4" 4x75 m Ø 20 mm extensions		

LINE SPEED

Without payload	up to 1800 ft /min · 640 m/min
With payload	up to 900 ft /min · 350 m/min

POWER STATION

- 3-cylinder Deutz diesel engine with 36 kW (49.5 hp) power
- Energy storage for power peaks, start / stop diesel engine operation and energy recovery
- Stepless electric drive for working and assembly winches

TOWER

Standard	36' · 11 m
Operating range	360°

FEATURES

- 2 to 4 times longer maintenance interval compared to conventional motors
- All winches can be operated independently of each other (pulling / braking)
- Constant pull through the entire diameter of the winch
- No complicated exhaust treatments (no particle filter and Ad-blue)
- Diesel consumption reduction over 50% even during uphill operation
- During assembly, no running diesel engine
- Minimized noise during operation
- Very low oil quantities in the system therefore reduced environmental hazard potential
- Automated with radio remote control
- Mounting radio (optional)
- Mounting winch can be used during operation via mounting radio

CARRIAGE

	USKA 1,5	USKA 2,5	MSK 4	ECKO FLEX
	Ø 9/16"-1" · Ø 14-24 mm	Ø 1 1/16"-1 1/8" · Ø 18-28 mm	Ø 1 1/16"-1 1/4" · Ø 18-32 mm	Ø 5/8"-3/4" · Ø 15-19 mm
	Ø 3/8"-7/16" · Ø 9-11 mm	Ø 3/8"-9/16" · Ø 10-14 mm	Ø 3/8"-9/16" · Ø 10-14 mm	Ø 3/8"-7/16" · Ø 9-10 mm
	approx. 760 lbs · 345 kg	approx. 790 lbs · 360 kg	approx. 1719 lbs · 780 kg	approx. 1322 lbs · 600 kg
	approx. 1.5 t	approx. 2.5 t	approx. 3.2 t	approx. 2.0 t





SHORT LENGTH

SHORT OVERHANG

LESS THAN 26 TONS (no route approval required)



HYDRAULIC SUPPORT



SLACK LINE PROTECTION

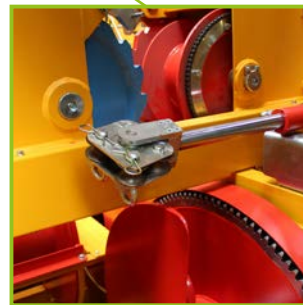

HYDRAULIC SKYLINE GUIDANCE





The **K 507-S** is an evolution of the K507 truck version. This powerful universal machine was designed for use with follower units (excavator processor). The space requirement is similar to the trailer-based yarders without sacrificing the benefits of a truck.

SPECIFICATIONS

LINE CAPACITY	STANDARD	ALTERNATIVE	LINE PULL
Skyline	3600' Ø 3/4" · 1000 m Ø 20 mm swaged	2550' Ø 7/8" · 800 m Ø 22 mm swaged	Skyline
Winch W1+W2	3950' Ø 1/2" · 1350 m Ø 12 mm swaged	5150' Ø 7/16" · 1600 m Ø 11 mm swaged Also 5500' Ø 7/16" · 1700 m Ø 11 mm as HBL	Winch W1 + W2
Strawline	1150' Ø 1/4" · 1800 m Ø 6 mm	–	12.24 t · 120 kN
Guyline	4x250' Ø 3/4" / 2x50' 4x75 m Ø 20 mm / 2x15 m extensions	–	5.10 t · 50 kN

LINE SPEED

Without payload	up to 1655 ft/min · 504 m/min
With payload	up to 1260 ft/min · 384 m/min

POWER STATION

- Truck diesel engine with 309 kW (approx. 420 hp) power (EURO6)
- Use of the direct (gearbox-independent) power take-off. It has been designed so that the full engine power can be used.
- Stepless hydrostatic drive for all winches







TOWER

Standard	39' · 12 m
Operating range	360°

FEATURES

- Additional diesel fuel tank and fuel transfer pump (optional)
- Hydraulic oil micro filter system for longer maintenance intervals and longer service life
- Robust and anti-slip construction
- Two large landing ramps (optional)
- Truck cab protection (optional)
- Removable storage box at the rear (optional)
- Cross reel (optional)
- Wireless module to carry the display into the follower (optional)
- Mounting radio (optional)
- Ideal also for operations in flat terrain
- Haulbackline winch and assembly winch with cable slack protection

CARRIAGE

	USKA 2,5  	MSK 4  	ECKO BOOST  
	Ø 1 1/16"-1 1/8" · Ø 18-28 mm	Ø 1 1/16"-1 1/4" · Ø 18-32 mm	Ø 1 1/16"-1 1/8" · Ø 18-28 mm
	Ø 3/8"- 9/16" · Ø 10-14 mm	Ø 3/8" – 9/16" · Ø 10-14 mm	Ø 3/8"- 9/16" · Ø 10-14 mm
	approx. 790 lbs · 360 kg	approx. 1719 lbs · 780 kg	approx. 2156 lbs · 978 kg
	approx. 2,5 t	approx. 3,2 t	approx. 4,0 t





NEW ENGINE COVER

TELESCOPIC TOWER (optional)

WIDE TRACKS



SPOOLING WINCH



IDEAL LIGHTING



BIG STORAGE COMPARTMENTS





The **K 507-X** is a further development of the K 507 based on a self-propelled track unit. This makes it possible to drive in almost any terrain. Thanks to its own engine, which can be used at temperatures as low as -20 °C, even applications the wintertime are no problem!

SPECIFICATIONS

LINE CAPACITY	STANDARD	ALTERNATIVE	LINE PULL	
Skyline	3600' Ø 3/4" · 1000 m Ø 20 mm swaged	2550' Ø 7/8" · 800 m Ø 22 mm swaged	Skyline	12.24 t · 120 kN
Winch W1+W2	3950' Ø 1/2" · 1350 m Ø 12 mm swaged	5150' Ø 7/16" · 1600 m Ø 11 mm swaged Also 5500' Ø 7/16" · 1700 m Ø 11 mm as HBL	Winch W1+W2	5.10 t · 50 kN
Strawline	1150' Ø 1/4" · 1800 m Ø 6 mm	–		
Guyline	4x250' Ø 3/4" / 2x50' 4x75 m Ø 20 mm / 2x15 m extensions	–		

LINE SPEED

Without payload	up to 1655 ft/min · 504 m/min
With payload	up to 1260 ft/min · 384 m/min

POWER STATION

- 6-cylinder Cummins diesel engine with 194 kW (260 hp) EU-STAGE III A (depending on target market)
- Stepless hydrostatic drive for all winches

TOWER

Standard	37' · 11.4 m
Telescopic tower	37' - 48' · 11.4-14.7 m (three working positions)
Operating range	300°

FEATURES

- Additional diesel fuel tank and fuel transfer pump (optional)
- Hydraulic oil micro filter system for longer maintenance intervals and longer service life
- Removable storage box at the rear (optional)
- Two large landing ramps
- Cross reel (optional)
- Robust and anti-slip construction
- Wireless module to carry the display into the follower (optional)
- Mounting radio (optional)
- Ideal also for operations in flat terrain
- Lighting equipment (optional)
- Haulbackline winch and assembly winch with cable slack protection

CARRIAGE

	USKA 2,5	MSK 4	ECKO BOOST
	Ø 1 1/16"-1 1/8" · Ø 18-28 mm	Ø 1 1/16"-1 1/4" · Ø 18-32 mm	Ø 1 1/16"-1 1/8" · Ø 18-28 mm
	Ø 3/8"-9/16" · Ø 10-14 mm	Ø 3/8" – 9/16" · Ø 10-14 mm	Ø 3/8"-9/16 · Ø 10-14 mm
	approx. 790 lbs · 360 kg	approx. 1719 lbs · 780 kg	approx. 2156 lbs · 978 kg
	approx. 2,5 t	approx. 3,2 t	approx. 4,0 t





TELESCOPIC TOWER
(optional, 3 positions)

FREE VIEW ON THE WINCHES
in every crane position

HYDRAULIC LANDING RAMPS (optional)

SPOOLING WINCH (optional)

CROSS REEL (optional)



TRUCK CAB PROTECTION
(optional)



BIG STORAGE COMPARTMENT WITH TOOL BOX



HYDRAULIC SUPPORT



ERGONOMIC CABIN

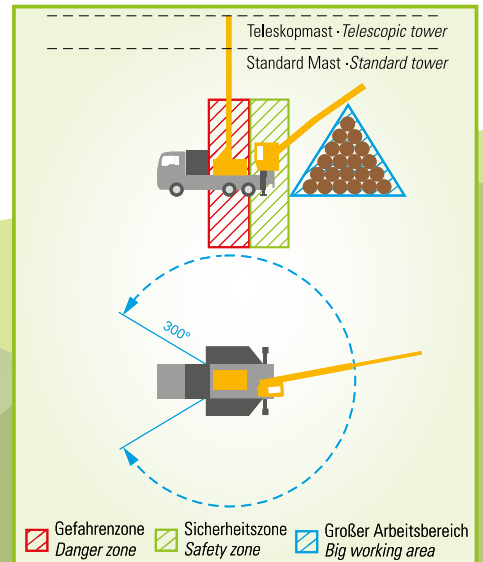



The **K 507-GH** is a strong mountain harvester for uphill and downhill as well as for flat terrain. It is mainly used for pre- & end use. The device has two equal working winches, which can be combined with each other in the working mode.

SPECIFICATIONS

LINE CAPACITY	STANDARD	ALTERNATIVE	LINE PULL
Skyline	3600' Ø 3/4" · 1000 m Ø 20 mm swaged	2550' Ø 7/8" · 800 m Ø 22 mm swaged	Skyline 12.24 t · 120 kN
Winch W1+W2	3950' Ø 1/2" · 1350 m Ø 12 mm swaged	5150' Ø 7/16" · 1600 m Ø 11 mm swaged Also 5500' Ø 7/16" · 1700 m Ø 11 mm as HBL	Winch W1+W2 5.10 t · 50 kN
Strawline	1150' Ø 1/4" · 1800 m Ø 6 mm	–	
Guyline	4x250' Ø 3/4" / 2x50' 4x75 m Ø 20 mm / 2x15 m extensions	–	

LINE SPEED

Without payload	up to 1655 ft/min · 504 m/min
With payload	up to 1260 ft/min · 384 m/min

POWER STATION

- Truck diesel engine - depending on equipment - 338kW (approx. 460 hp) or 368 kW (approx. 500 hp) power (EURO6)
- Mainline- and skyline drums are each driven by hydraulically operated by pneumatic radial clutches coupled to the common constantly rotating winch shaft
- Stepless hydrostatic drive for all winches
- Use of the direct (gearbox-independent) power take-off. It has been designed so that the full engine power can be used.

TOWER

Standard	37' · 11.4 m
Telescopic tower	37'-48' · 11.4-14.7 m (three working positions)
Operating range	300°

CRANE

Radius	31' · 9.4 m
--------	-------------

FEATURES

- Cabin
 - *Very ergonomic design*
 - *Air-suspension comfort seat*
 - *Front and side entry*
 - *Temperature-controlled auxiliary heating*
 - *Air conditioning*
 - *Glazing with bullet-resistant polycarbonate panes in dangerous places (12/19 mm)*
 - *Tested cabin*
 - *Safety sensor on the front door*
 - Ideal also for operations in flat terrain
- Two hydraulically operated landing ramps (optional)
 - *Robust and anti-slip construction*
- Truck cab protection (optional)
 - *Two large landing ramps*
- Additional diesel fuel tank and fuel transfer pump (optional)
- Spooling winch or storage drum for guyline extensions (optional)
- Hydraulic oil micro filter system for longer maintenance intervals and longer service life
- Mounting radio (optional)
- Haulbackline winch and assembly winch with cable slack protection

CARRIAGE

	USKA 2,5	MSK 4	ECKO BOOST
	Ø 1 1/16"-1 1/8" · Ø 18-28 mm	Ø 1 1/16"-1 1/4" · Ø 18-32 mm	Ø 1 1/16"-1 1/8" · Ø 18-28 mm
	Ø 3/8"-9/16" · Ø 10-14 mm	Ø 3/8"-9/16" · Ø 10-14 mm	Ø 3/8"-9/16" · Ø 10-14 mm
	approx. 790 lbs · 360 kg	approx. 1719 lbs · 780 kg	approx. 2156 lbs · 978 kg
	approx. 2,5 t	approx. 3,2 t	approx. 4,0 t





TOWERHEAD WITH FOLDABLE BLOCKS

TELESCOPIC TOWER (optional)

LARGE STORAGE COMPARTMENTS

POWERFUL & ROBUST RADIAL COUPLING

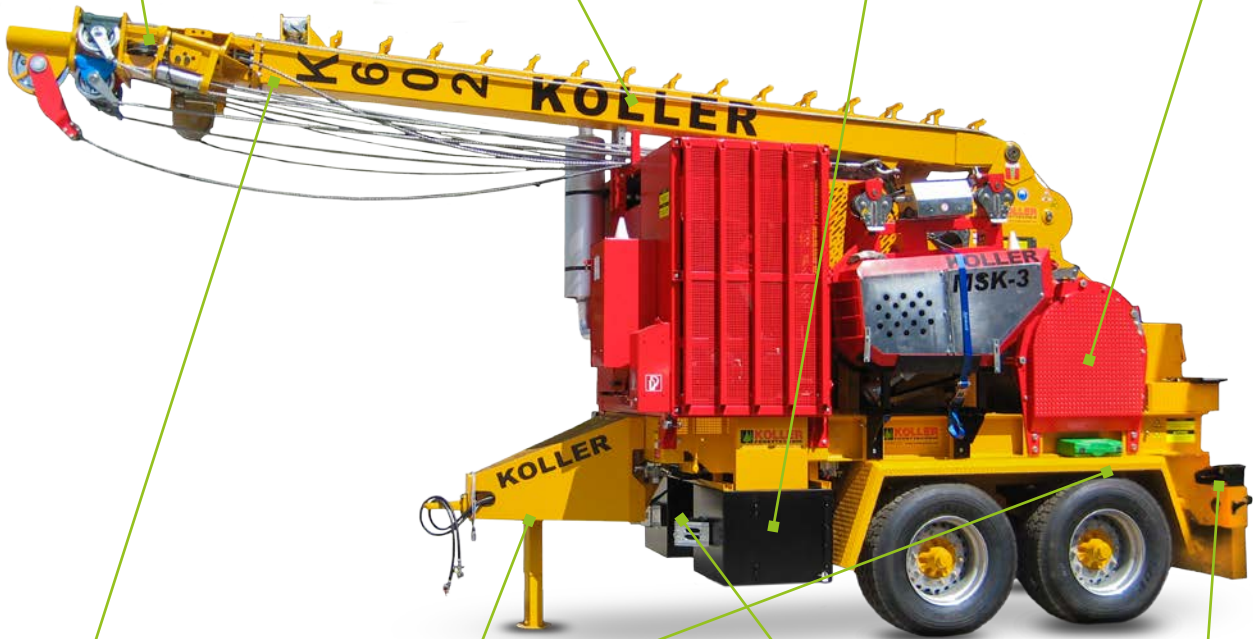

FOLDABLE TOWER (optional)



TOWER STABILIZATION WITH HYDRAULIC SUPPORTS



SUPPORTING AXLEDRIVE (optional)



PORTABLE DISPLAY (optional)

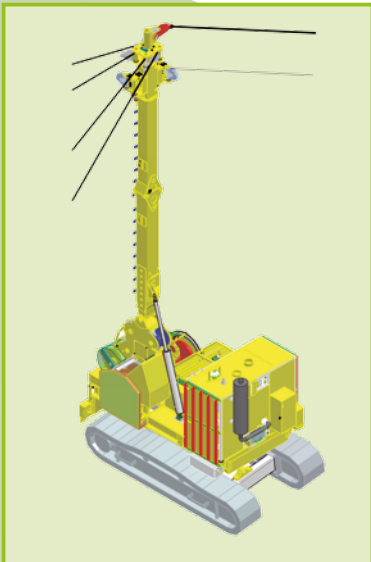



The **K 602c-H** is a strong tower yarder for uphill- and downhill and flat terrain operations with an optional haul backline. It is mainly used for pre- and end-use. As a chassis, a tandem axle trailer is used with compressed air brake system.

SPECIFICATIONS

LINE CAPACITY	STANDARD	ALTERNATIVE	LINE PULL
Skyline	2723' Ø 13/16" · 830 m Ø 20 mm swaged	2132' 7/8" · 660 m Ø 22 mm swaged	Skyline 10.70 t · 105 kN
Mainline	2100' Ø 1/2" · 730 m Ø 12 mm swaged	1800' 1/2" · 630 m Ø 13 mm swaged	Mainline 6.11 t · 60 kN
Haulbackline	4429' Ø 1/2" · 1350 m Ø 12 mm swaged	5249' Ø 7/16" · 1600 m Ø 11 mm swaged	Haulbackline 4.60 t · 45 kN
Strawline	5577' Ø 1/4" · 1700 m Ø 6 mm	–	
Guyline	4x160' Ø 13/16" / 2x50' 4x50 m Ø 20 mm / 2x15 m extensions	5x160' Ø 13/16" / 2x33' 5x50 m Ø 20 mm / 2x10 m extensions	

LINE SPEED

Mainline	up to 1968 ft/min · 600 m/min
Haulbackline	up to 1655 ft/min · 504 m/min

POWER STATION

- 6-cylinder Cummins diesel engine with 186 kW (approx. 250 hp) (EU-STAGE V)
- Stepless hydrostatic drive for all winches
- Optional with drive axle drive from the tower yarder engine

TOWER

Standard	35' · 10.8 m
Tower extension	possible up to 47' · 14.3 m
Foldable tower	35' · 10.8 m
Telescopic tower	34'-45' · 10.4-13.6 m (two working positions)
Operating range	360°

FEATURES

- Additional diesel fuel tank and fuel transfer pump (optional)
- Hydraulic oil micro filter system for longer service intervals and longer service life
- Mainline and haulbackline pulley swiveling -to cover 360° working angle without having to unthread the ropes.
- Large storage compartments
- Wireless module to carry the display into the follower (optional)
- Mounting radio control (optional)
- Haulbackline winch and assembly winch with cable slack protection
- 5th guyline drum for uphill machines (optional)

CARRIAGE

	MSK 10	SKA 2,5-Z	USKA 2,5	MSK 4	ECKO BOOST
	Ø 3/4"-1" · Ø 18-25 mm	Ø 1 1/16"-1 1/8" · Ø 18-28 mm	Ø 1 1/16"-1 1/8" · Ø 18-28 mm	Ø 1 1/16"-1 1/4" · Ø 18-32 mm	Ø 1 1/16"-1 1/8" · Ø 18-28 mm
	Ø 3/8"-5/8" · Ø 10-16 mm	Ø 3/8"-9/16" · Ø 10-14 mm	Ø 3/8"-9/16" · Ø 10-14 mm	Ø 3/8"-9/16" · Ø 10-14 mm	Ø 3/8"-9/16" · Ø 10-14 mm
	approx. 1320 lbs · 600 kg	approx. 680 lbs · 310 kg	approx. 790 lbs · 360 kg	approx. 1719 lbs · 780 kg	approx. 2156 lbs · 978 kg
	approx. 4.0 t	approx. 2.5 t	approx. 2,5 t	approx. 3,2 t	approx. 4,0 t





SPOOLING WINCH (optional)

LARGE STORAGE COMPARTMENTS

HYDRAULIC LANDING RAMPS (optional)

FREE VIEW ON THE DRUMS in every crane position

TELESCOPIC TOWER (optional, 2 positions)



ERGONOMIC CABIN



LARGE TOOL BOX

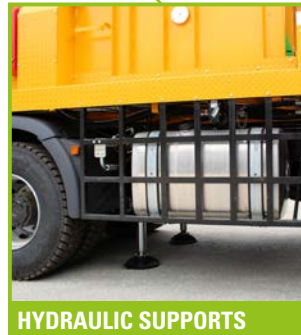

HYDRAULIC SUPPORTS



TRUCK CABIN GUARD (optional)

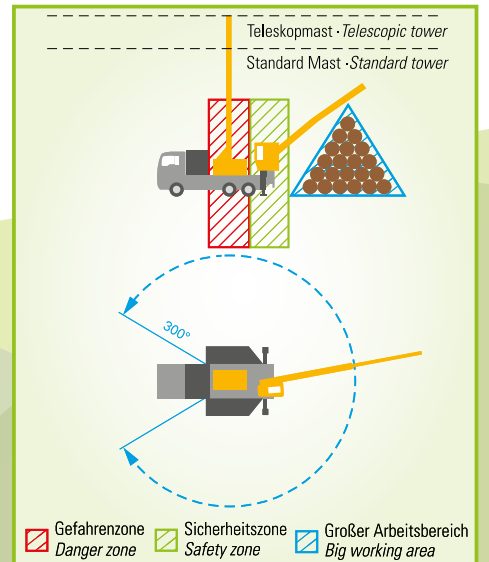

The **K 602-GH** is a strong and robust tower yarder for uphill operations. It is mainly used for pre- and end-use. It convinces by high pulling forces at high speeds.

SPECIFICATIONS

LINE CAPACITY	STANDARD	ALTERNATIVE	LINE PULL
Skyline	2723' Ø 13/16" · 830 m Ø 20 mm swaged	2132' 7/8" · 660 m Ø 22 mm swaged	Skyline 10.70 t · 105 kN
Mainline	2100' Ø 1/2" · 730 m Ø 12 mm swaged	1800' 1/2" · 630 m Ø 13 mm swaged	Mainline 6.11 t · 60 kN
Strawline	5577' Ø 1/4" · 1700 m Ø 6 mm	–	
Guyline	4x160' Ø 13/16" / 2x50' 4x50 m Ø 20 mm / 2x15 m extensions	5x160' Ø 13/16" / 2x33' 5x50 m Ø 20 mm / 2x10 m extensions	

LINE PULL

Mainline	up to 1968 ft/min · 600 m/min
Haulbackline	up to 1655 ft/min · 504 m/min

POWER STATION

- Truck diesel engine with 338 kW (approx. 460 hp / EURO 6) power
- Stepless hydrostatic drive for all winches
- Use of the direct (gearbox-independent) power take-off. It has been designed so that the full engine power can be used.
- Hydraulically powered guyline winches – operated by radio control in both directions

TOWER

Standard	35' · 10.7 m
Tower extension	possible up to 47' · 14.3 m
Telescopic tower	34'-45' · 10.4-13.6 m (two working positions)
Operating range	300°

FEATURES

- Cabin
 - Very ergonomic design
 - Air-suspension comfort seat
 - Front and side entry
 - Temperature-controlled auxiliary heating
 - Air conditioning
 - Glazing with bullet-resistant polycarbonate panes in dangerous places (12/19 mm)
 - Tested cabin
 - Safety sensor on the front door
- Two hydraulically operated landing ramps (optional)
 - Robust and anti-slip construction
- Truck cab protection (optional)
 - Two large landing ramps
- Additional diesel fuel tank and fuel transfer pump (optional)
- Spooling winch or storage drum for guyline extensions (optional)
- Hydraulic oil micro filter system for longer maintenance intervals and longer service life
- Mounting radio (optional)
- Haulback winch and strawline winch with slack rope protection

CARRIAGE

	MSK 10 	SKA 2,5-Z 	MSK 4  	ECKO BOOST  
	Ø 3/4"-1" · Ø 18-25 mm	Ø 1 1/16"-1 1/8" · Ø 18-28 mm	Ø 1 1/16"-1 1/4" · Ø 18-32 mm	Ø 1 1/16"-1 1/8" · Ø 18-28 mm
	Ø 3/8"-5/8" · Ø 10-16 mm	Ø 3/8"-9/16" · Ø 10-14 mm	Ø 3/8"-9/16" · Ø 10-14 mm	Ø 3/8"-9/16" · Ø 10-14 mm
	approx. 1320 lbs · 600 kg	approx. 680 lbs · 310 kg	approx. 1719 lbs · 780 kg	approx. 2156 lbs · 978 kg
	approx. 4.0 t	approx. 2.5 t	approx. 3.2 t	approx. 4.0 t





FOLDABLE TOWER POSSIBLE

CARRIER VEHICLE INDEPENDENT



ENORMOUS STORAGE



CLEAR HANDLING

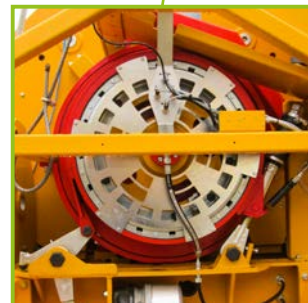

RADIO CONTROL (optional)



The **K 602-A** is a powerful yarder for uphill logging. The machine is equipped with a self-supporting frame, allowing a simple assembly on various trucks or trailers as well as easy worldwide export. It is principally used for selective cuts and for general wood harvesting operations.

SPECIFICATIONS

LINE CAPACITY	STANDARD	ALTERNATIVE	LINE PULL
Skyline	2723' Ø 13/16" · 830 m Ø 20 mm swaged	2165' Ø 7/8" · 660 m Ø 22 mm swaged	Skyline 14.27 t · 140 kN
Mainline	2100' Ø 1/2" · 730 m Ø 12 mm swaged	1250' Ø 1/2" · 630 m Ø 13 mm swaged	Mainline 7.13 t · 70 kN
Strawline	4250' Ø 1/4" · 1.500 m Ø 6 mm	—	
Guyline	4x160' Ø 13/16" / 2x50' 4x50 m Ø 20 mm / 2x15 m extensions	5x160' Ø 13/16" / 2x33' 5x50 m Ø 20 mm / 2x15 m extensions	

LINE SPEED

Without payload	user defined by brake
With payload	up to 1148 ft/min · 350 m/min

POWER STATION

- Motorization depending on the target market up to EU-STAGE V i.e. 6-cylinder Cummins diesel engine with 168 kW (225 HP) power
- Allison automatic transmission
- Mainline- and skylinedrums are each driven by hydraulically operated single-disc Dry clutches coupled to the common constantly rotating winch shaft

TOWER

Standard	34' · 10.5 m
Tower extension	possible up to 46'11" · 14.3 m
Telescopic tower	up to 44'7" · 10.4-13.6 m (two working positions)
Operating range	360°

FEATURES

- Automation with radio remote control (optional)
- Worldwide in use
- Easy maintenance due to simple design
- Extremely strong machine
- Spacious storage space behind truck cab (optional)
- Very low fuel consumption (about 4 liters per hour)
- High speeds at high loads due to torque converter and automatic transmission or powershift transmission
- Almost any carrier vehicle possible
- Mounting radio (optional)
- Wireless module for carrying the display into the following machine (optional)

CARRIAGE

	MSK 10 	SKA 2,5-Z 	MSK 4 
	Ø 3/4"-1" · Ø 18-25 mm	Ø 1 1/16"-1 1/8" · Ø 18-28 mm	Ø 1 1/16"-1 1/4" · Ø 18-32 mm
	Ø 3/8"-5/8" · Ø 10-16 mm	Ø 3/8"-9/16" · Ø 10-14 mm	Ø 3/8"-9/16" · Ø 10-14 mm
	approx. 1320 lbs · 600 kg	approx. 680 lbs · 310 kg	approx. 1719 lbs · 780 kg
	approx. 4.0 t	approx. 2.5 t	approx. 3.2 t





GUYLINE GUIDANCE WITHIN THE TOWER TUBE

CARRIER VEHICLE INDEPENDENT

FOLDABLE TOWER POSSIBLE



POWERFUL WINCH UNIT



SECURE CABIN



CONTROL UNIT (optional)





The **K 702-A** is the strongest and fastest Koller tower yarder for uphill and downhill as well as for flat terrain. The machine is built on a self-supporting frame, which facilitates a simple construction on various trucks or trailers as well as worldwide export.

SPECIFICATIONS

LINE CAPACITY	STANDARD	ALTERNATIVE	LINE PULL
Skyline	2550' Ø 7/8" · 800 m Ø 22 mm swaged	2296' Ø 1" 700 m Ø 24 mm swaged	Skyline 12.23 t · 120 kN
Winch W1+W2	2800' Ø 9/16" · 900 m Ø 14 mm swaged	–	Winch W1+W2 8.15 t · 80 kN
Strawline	5100' Ø 1/4" · 1700 m Ø 6 mm	–	
Guyline	4x160' Ø 7/8" / 2x50' 4x50 m Ø 22 mm / 2x15 m extensions	–	

LINE SPEED

Winch W1+W2 up to 2165 ft/min · bis 660 m/min

POWER STATION

- Motorization depending on target market up to emission level EU-STAGE V e.g. 6-cylinder Cummins diesel engine with 186 kW (approx. 250 hp) power
- John Deere powershift transmission
- Winch 1 + winch 2 are each about large-dimensioned, maintenance-free Compressed air-radial couplings coupled to the common winch shaft
- Stepless hydrostatic drive for skyline and strawline

TOWER

Standard	39' · 12 m
Tower extension	49' · 15 m
Operating range	on the left or right side of the yarder

FEATURES

- Very high speeds at high loads due to converter and powershift transmission
- Easy maintenance due to simple design
- Extremely strong machine
- The guylines are driven by separate hydraulic motors
- Very low fuel consumption (about 4 liters per hour)
- Guy ropes are guided in the tower tube, so no disturbing ropes in the area of the working ropes
- Automation with radio remote control (optional)
- Mounting radio (optional)
- Wireless module to carry the display into the follower (optional)

CARRIAGE

	MSK 10	SKA 2,5-Z	USKA 2,5	MSK 4
	Ø 3/4"-1" · Ø 18-25 mm	Ø 1 1/16"-1 1/8" · Ø 18-28 mm	1 1/16"-1 1/8" · Ø 18-28 mm	1 1/16"-1 1/4" · Ø 18-32 mm
	Ø 3/8"-5/8" · Ø 10-16 mm	Ø 3/8"-9/16" · Ø 10-14 mm	Ø 3/8"- 9/16" · Ø 10-14 mm	Ø 3/8"-9/16" · Ø 10-14 mm
	approx. 1320 lbs · 600 kg	approx. 680 lbs · 310 kg	approx. 790 lbs · 360 kg	approx. 1719 lbs · 780 kg
	approx. 4.0 t	approx. 2.5 t	approx. 2.5 t	approx. 3.2 t





PULLEYS WITH BIG DIAMETERS



STRAWLINE DRUM



WINCH UNIT 2 FOR DIFFERENT WORKING MODES



WINCH UNIT 1





The **KX 800e** is the revolution in the excavator yarder sector. With this device it is possible to combine 3 different working modes in one machine. This is made possible by the electric winches, which can generate up to 1000 hp (!) of power. Above all, the constant traction over all layers is an unbeatable advantage.

SPECIFICATIONS

OPERATING MODE	LINE PULL UP TO		SPEED UP TO (EMPTY-FULL)		LINE CAPACITY (FOR EXAMPLE)	
	MAINLINE	SKYLINE/HAULBACK	MAINLINE	SKYLINE/HAULBACK	MAINLINE	SKYLINE/HAULBACK
Running Skyline	100 kN (10 t) constant	100 kN (10 t) constant	8.9 - 12 m/s (29,2-39,4 ft/s)	8.9 - 12 m/s (29,2-39,4 ft/s)	760 m Ø 5/8" 540 m Ø 3/4" *	950 m Ø 3/4" 780 m Ø 13/16" * 650 m Ø 7/8" (1350 m Ø 5/8" **)
Live Skyline	90 kN (9 t) constant	approx. 160 kN (16 t)			760 m Ø 5/8" 540 m Ø 3/4" *	
Standing Skyline	63 kN (6.3 t) constant				600 m Ø 9/16" * 430 m Ø 5/8" 700 m Ø 1/2" 600 m Ø 9/16" *	
Strawline	15 kN (1.5 t) constant/up to 32 kN (3.2 t)		up to 1.5 m/s (5 ft/s)		1450 m Ø 3/8"	

* **Best rope selection for all operating modes without need for rope change.**





** Rope change on the drum when switching between Running Skyline and Live Skyline / Standing Skyline mode may be necessary in case a long range for Running Skyline is desired.

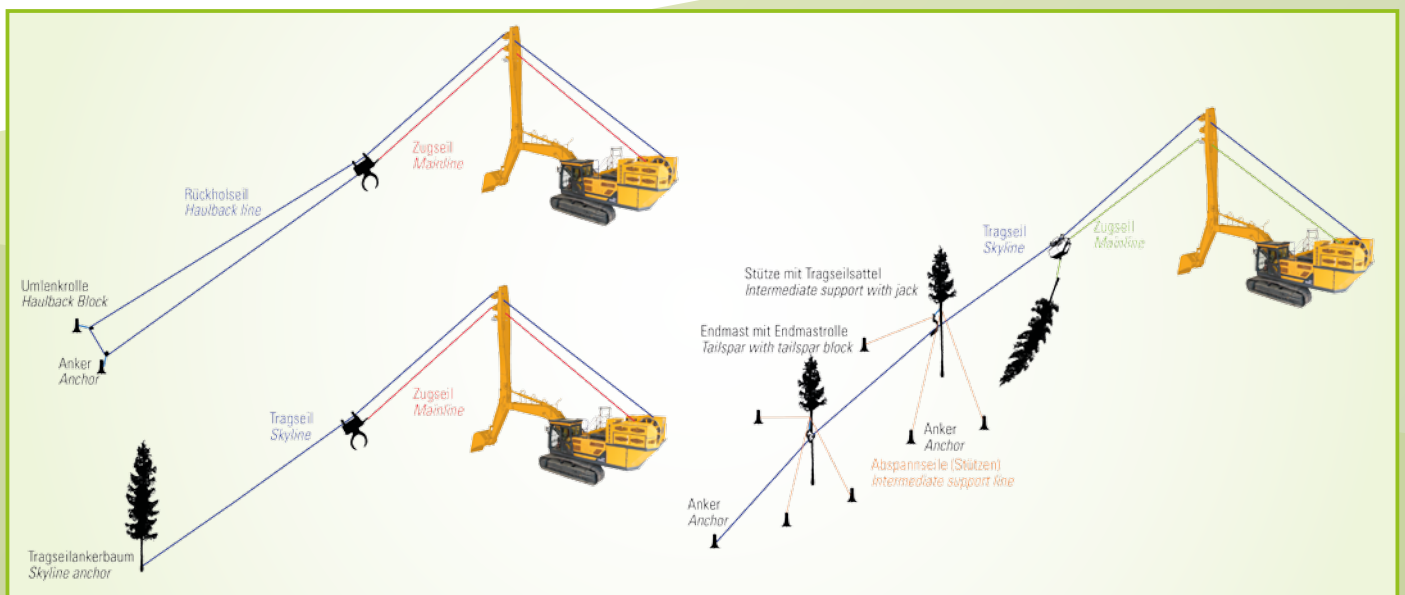

FEATURES





- Excavator as carrier vehicle with 212 kW (288 hp) power
- Supported working modes: **Running Skyline - Live Skyline - Standing Skyline**
- For uphill and downhill operation and flat terrain
- Without guy lines - very fast installation and movement between corridor
- With super caps as energy storage which provide a lot of additional power to the available diesel engine power. The hybrid technology provides up to 3 times more power to the net excavator engine capacity!
- Two completely electric powered and independent winches
- Constant traction over all cable layers on the winches
- Tower height 10 m/33'
- Split mainline drum for a fast change between the modes
- The winches are coupled purely electrically in the Running Skyline mode and thus the mechanical wear or additional maintenance is equal to zero (without mechanical or hydraulic coupling)
- Up to 800 kW (1359 hp) net power per winch
- radio remote control available (optional)
- Low maintenance and long service life
- Robust construction of the machine
- Low transport height

WORKING MODES



	SKA 1 		FEATURES
		\emptyset 1/2" - 1" · \emptyset 12-24 mm	<ul style="list-style-type: none"> · Gravity operation for uphill operation · Skyline clamp and load hook release by reversing the direction of carriage travel (FWS) · Optionally with timer (ZIR) · Drive with 2 pulleys
		\emptyset 5/16" - 7/16" · \emptyset 8-11 mm	
		approx. 350 lbs · 160 kg	
		approx. 1.5 t	

	SKA 1-Z 		FEATURES
		\emptyset 1/2" - 1" · \emptyset 12-24 mm	<ul style="list-style-type: none"> · Gravity operation for uphill operation · With radio control and cable clamp · Drive with 2 pulleys · Can be converted to FWS (SKA-1) · Emergency clamp during the run is possible
		\emptyset 5/16" - 7/16" · \emptyset 8-11 mm	
		approx. 420 lbs · 190 kg	
		approx. 1.5 t	

	SKA 2,5 		FEATURES
		\emptyset 1 1/16" - 1 1/8" · \emptyset 18-28 mm	<ul style="list-style-type: none"> · Gravity operation for uphill operation · Skyline clamp and load hook release by reversing the direction of carriage travel (SKA) · Drive with 4 pulleys · Optionally with timer (ZIR)
		\emptyset 3/8" - 9/16" · \emptyset 10-14 mm	
		approx. 595 lbs · 270 kg	
		approx. 2.5 t	

	SKA 2,5-Z 		FEATURES
		\emptyset 1 1/16" - 1 1/8" · \emptyset 18-28 mm	<ul style="list-style-type: none"> · Gravity operation for uphill operation · With radio control and cable clamp · Drive with 4 pulleys · Can be converted to SKA-mode (SKA-2,5) · Emergency clamp during the run is possible
		\emptyset 3/8" - 9/16" · \emptyset 10-14 mm	
		approx. 680 lbs · 310 kg	
		approx. 2.5 t	

SKA – The skyline clamping and loadhook release are triggered by reversing the direction of carriage travel (3-6 ft / 1-2 m)

ZIR – The normal cycling system can be upgraded with a time cycle system. Tripping time from 3 up to 25 seconds.

Z – The switching operation of the skyline and mainline clamp can be activated anytime also with reeled-out choker.



USKA 1,5		FEATURES
	Ø 9/16" - 1" · Ø 14-24 mm	<ul style="list-style-type: none"> · For uphill and downhill operations · Slack pulling storage drum and traction pulley · Radio-controlled skyline and mainline clamp · Spooling length 70 m at Ø 10 mm · Emergency clamp during the run is possible · Drive with 2 pulleys
	Ø 3/8" - 7/16" · Ø 9-11 mm	
	approx. 760 lbs · 345 kg	
	approx. 1.5 t	







USKA 2,5		FEATURES
	Ø 1 1/16" - 1 1/8" · Ø 18-28 mm	<ul style="list-style-type: none"> · For uphill and downhill operations · Slack pulling storage drum and traction pulley · Radio-controlled skyline and mainline clamp · Spooling length 75 m with Ø 12 mm · Emergency clamp during the run is possible · Drive with 4 pulleys
	Ø 3/8" - 9/16" · Ø 10 - 14 mm	
	approx. 790 lbs · 360 kg	
	approx. 2.5 t	







WORLDWIDE AT WORK · DECADES PROVEN











ECKO UP 		FEATURES
	Ø 5/8"-3/4" · Ø 15-19 mm	<ul style="list-style-type: none"> · Electric slack puller for uphill operations · Drive with 2 pulleys · Energy storage is charged when moving · Emergency clamping and cable break protection · Mainline outlet angle of 125 ° allows trouble-free operation even with low skyline · No diesel engine and therefore very quiet · Unlimited spooling length
	Ø 3/8"-7/16" · Ø 9-10 mm	
	approx. 1102 lbs · 500 kg	
	approx. 1.5 t	







ECKO FLEX  		FEATURES
	Ø 5/8"-3/4" · Ø 15-19 mm	<ul style="list-style-type: none"> · Electric slack puller for uphill and downhill operations · Using a high power capacitor as energy storage · Jacks from different manufacturers can be used (Koller, Stuefer, Wyssen) · Wear-free, shock-resistant, Insensitive to cold, no fire hazard · High spooling force with low rope wear · No restrictions on maximum tilt position while pulling · Mainline outlet angle of 125 ° allows trouble-free operation even with low skyline · Pre-lowering the load while driving · Energy storage is charged when pulling · Emergency clamping by radio and cable break protection · Strong derailing protection · Unlimited spout length · No diesel engine and therefore very quiet · Drive with 2 pulleys
	Ø 3/8"-7/16" · Ø 9-10 mm	
	approx. 1322 lbs · 600 kg	
	approx. 2.0 t	









ECKO BOOST  		FEATURES
	Ø 11/16"-1 1/8" · Ø 18-28 mm	<ul style="list-style-type: none"> · Electric slack puller for uphill and downhill operations · Using a high-power capacitor as energy storage · Energy storage is charged when pulling · Wear-free, shock-resistant, Insensitive to cold, no fire hazard · High spooling force with low rope wear · No restrictions on maximum tilt position while pulling · Emergency clamping by radio and cable break protection · Pre-lowering the load while driving · BOOST technology for temporarily higher tension load · Mainline outlet angle of 125 ° allows trouble-free operation even with low skyline · Various saddles passable (Koller, Stuefer, Wyssen) · Strong derailing protection · Unlimited spout length · No diesel engine and therefore very quiet
	Ø 3/8"- 9/16" · Ø 10-14 mm	
	approx. 2156 lbs · 978 kg	
	approx. 4.0 t	



MSK 10 		FEATURES
	Ø 1 1/16"-1" · Ø 18-25 mm	<ul style="list-style-type: none"> · Engine slack puller for uphill operations · Slack pulling force up to 250kg (550lbs) · Spooling speed approx. 1.2 m/s (3,93 ft/s) · Drive by 7.7 kW (10.5 hp) diesel engine · Radio-controlled skyline- and mainline clamp · Active hydraulic power clamp for the skyline · Drive with 2 pulleys · Unlimited spooling length · Engine start-stop via radio
	Ø 3/8"-5/8" · Ø 10-16 mm	
	approx. 1320 lbs · 600 kg	
	approx. 4.0 t	



MSK 4  		FEATURES
	Ø 1 1/16"-1 1/4" · Ø 18-32 mm	<ul style="list-style-type: none"> · Proven and improved MSK-3 technology · Jacks from different manufacturers can be used (Koller, Stuefer, Wyssen) · Engine slack puller for uphill and downhill operations · Slack pulling force up to 620kg (1366 lbs) · 2 spooling speeds (approx. 0.8 and 1.2 m/s; approx. 2,62 ft/s and 3,93 ft/s) · Powered by 5.5 kW (7.5 hp) diesel engine · Radio-controlled skyline- and mainline clamp · Emergency clamping by radio and cable break protection · Drive with 4 pulleys · Unlimited spooling length · Engine start-stop via radio · Laterally swiveling skyline clamp · Strong derailing protection · Clutch system with brake function
	Ø 3/8"-9/16" · Ø 10-14 mm	
	approx. 1719 lbs · 780 kg	
	approx. 3.2 t	



Derailing protection for Wyssen jacks



KOLLER ...AND IT'S DONE!



The quality of our products is the result of experience and continuous development since 1961. By using the highest quality and reliable components and the know-how of our employees, we can guarantee you an extremely high productivity and a very good value stability.

Your local dealer

Koller Forsttechnik GmbH

Kufsteiner Wald 26
A-6334 Schwoich / Kufstein
T: +43 5372 63257 · F: DW -7
www.kollergmbh.com

 /KollerForsttechnik

 /user/KollerForsttechnik

 /kollergroup