

Product Price Guide

arielplastics.com

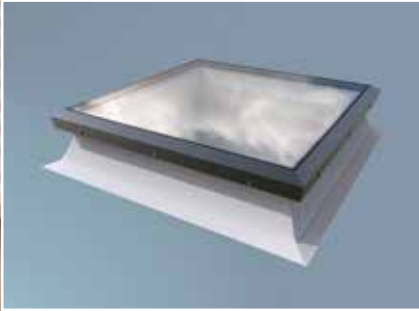

Roof Ventilation & Drainage
Roofing Sheets
Rooflights
Flat Glazing
Cladding

ariel[®]
the proof's on the roof

This price list supersedes all previous issues. All goods sold are subject to our standard Terms and Conditions of Sale (available on request from the Sales Office). Ariel Plastics Ltd reserves the right to amend specifications without prior notice.

Reproduction of all or any part of this publication, unless authorised in writing by Ariel Plastics Ltd, will be a breach of copyright.

Carrier Deliveries

Customers requiring a chargeable Next Day carrier service must submit their orders before 12:00 noon. Please note that carriers will not take goods longer than 4m and wider than 1m. Although we expect the carrier to deliver on a next day service, carriers are increasingly unable to guarantee this on all occasions. Basic carrier cost is £30.00, please contact sales office for full details.

Terms & Conditions

Please provide full delivery address with postcode, contact name and phone numbers and details of any site restrictions which may affect delivery. For details of the delivery schedule and delivery zones go to pages 78-79.

Ordering

When ordering please clearly state Product Code, Description and Quantity. 48 hour Hi-Lights Service orders must be placed by 12.30pm. All other orders must be received by 4.00pm.

Prices

Irrespective of any prices stated on your orders, the prices charged by Ariel Plastics will be list prices less your agreed customer discount. List Prices exclude VAT.

Non Price List Products

Any goods not stated on the price list will be subject to extended lead times and a minimum order value of £250.00 net. These products are all non-returnable.

Cut to Size

Cut to size is a bespoke product and therefore non-returnable.

Cutting Charge

We reserve the right to apply a cutting charge for complicated or large cutting requests. Please contact the customer services department for details.

Quotations

Quotations will normally be processed within 24 hours. Earlier processing may be available on request. Complicated and structural quotations can take up to 48 hours to be fully processed.

Cancelled Orders

We reserve the right to charge up to £30.00 for any orders cancelled after the order cut off time to cover administration and/or delivery costs. Cancelled orders must be notified in writing before cut off time. Cut off time is 4.00pm.

Minimum Order Charges

Orders under £250.00 net will be subject to a £30.00 delivery charge.

Site Deliveries

Site deliveries are subject to a minimum order value of £250.00 and a one off charge of £30.00 (mainland GB only).

48hr Hi-Lights Service

Orders must be received by Ariel Plastics by 12.30pm. 48hr delivery is only available to mainland GB (excluding postcode areas beginning KW, IV, AB and PH). All Mardome returns must be in a re-saleable condition and rooflights will be subject to a 50% restocking charge plus £50 collection charge. All rooflights are subject to a £20 delivery charge. Please note that a £45 failed delivery charge applies to all rooflights. *Flat Glass Rooflights are Non Returnable.*

Fixing Guides

Available to download from www.arielplastics.com

Collection

Goods may only be collected by prior arrangement.

Notification of Claims

The seller shall be entitled to reject any claim for DEFECTIVE goods unless such a claim is notified in writing to the Seller within 48 hours of delivery, or, if the alleged defect is not immediately apparent, within such longer period as the seller may reasonably allow in the circumstances. Mardomes are bespoke items and will incur a 50% restocking charge plus £50 collection charge if cancelled or returned. Returns must be in a re-saleable condition.

Flat Glass Rooflights are Non Returnable.

The Seller shall be entitled to reject any claim for SHORTAGES of the goods unless such claim is notified to the Seller in writing within 48 hours of the date of delivery of any consignment in which it is said a shortage has occurred. Upon collection of goods, the Seller shall be entitled to credit goods only which are deemed resaleable.

The Seller will notify the Buyer within 48 hours of any rejections or discrepancies. It is recommended that orders are checked for completeness and defective parts before installation work commences. Failure to do so may affect the claim.

Contents

ROOF VENTILATION & DRAINAGE	Roof Ventilation	04
	Universal Ridge System	08
	Dry Hip Systems	09
	Roof Drainage	10
ROOFLINE	Dry Verge Systems	14
ROOFING & GLAZING SHEET	Multiwall Polycarbonate Sheet	16
	Self Supporting Roofing System	30
	Easy Fit DIY Roofing System	32
	Modular Panel Glazing System	33
	Corrugated Polycarbonate	34
	PVC Sheet	36
	Corrugated Bitumen	40
	Bituminous Tile Strip	44
	Metal Roofing System	46
	Galvanised Corrugated Sheet	47
Flat Glazing	48	
ROOFLIGHTS	Polycarbonate Dome Rooflights	54
	Flat Glass Rooflights	60
PROTECTIVE SHEET	Polypropylene Sheet	65
CUT TO SIZE SERVICE	Multiwall Polycarbonate Sheet	68
	Flat Polycarbonate Sheet	72
	Solid PETg Sheet	74
	Acrylic Sheet	75
	Foam PVC Sheet	76
	Foam PVC Solid Sheet	77
	Delivery Schedules	78



Corovent

Roof Ventilation

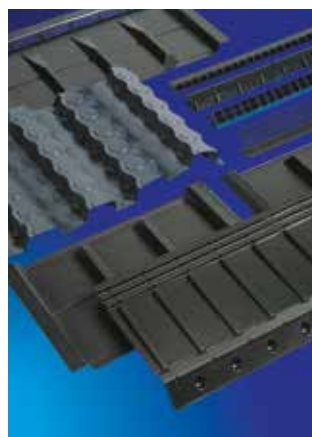

SLATE, TILE AND RIDGE VENTILATION

An extensive range of **Corovent** Slate, Tile and Ridge ventilation products have been specially designed to eliminate the risk of condensation.

A comprehensive range of tile vents are available to match most roof tiles, with specials available on short lead times. Our tile matching service ensures that Corovent will always blend in discreetly with existing tiles, even on a weathered roof.

*Not suitable for roofs less than 20° pitch

EAVES VENTILATION

The wide range of eaves ventilation products and accessories can eliminate condensation by providing adequate airflow in the roof void, and avoids damage to the eaves and roof-felt finishing.

- Maintenance free
- Corrosion and rot resistant
- Strong and flexible

Our tile matching service ensures the Corovent will blend in with existing roof tiles.









Roof Vents PG72/76/77

	Code	PG	Disc	Cowl Vents	Qty	Price £
	CV10K	072	780	Cowl Vent - ventilation area 10,000mm ² including felt sleeve	1	52.40
	CV20K	072	780	Cowl Vent - ventilation area 20,000mm ² including felt sleeve	1	55.65
	CP10K	072	780	As CV10K but including a 110mm Pipe Adaptor	1	59.02
	CP20K	072	780	As CV20K but including a 110mm Pipe Adaptor	1	77.92
	CT1C	076	780	110mm dia flexi-tube including clips	1	34.18
	CT1E	076	780	110mm PVC Coated flexi-tube including clips (1m length)	1	11.28
	FW1	072	780	Felt weir	1	2.74
	Code	PG	Disc	Roofline Vents (when ordering state whether slate or tile version)	Qty	Price £
	DV10K	072	780	Discrete Roof Vent 10,000mm ²	1	109.01
	DP10K	072	780	Discrete Roof Vent & pipe adaptor	1	124.99
	RV10K	072	780	Roofline vent for slate or interlocking tiles 10,000mm ² vent area (includes felt weir)	1	109.01
	RP10K	072	780	As RV10K but fitted with a 110mm dia pipe adaptor	1	124.99
	COA1	072	780	110mm dia. outlet can be cut to provide 125mm dia sections	1	18.51
	RV8K	072	780	Roofline vents for plain tiles 8000mm ² ventilation area	1	49.22
	RP8K	072	780	As RV8K but including a 110mm dia pipe adaptor	1	58.18
	NSA110	072	780	110mm dia adaptor to site convert RV8K to RP8K	1	11.70
	UNI/SLATE	077	780	Slate Universal Vent 8000mm ² ventilation area	1	50.40
	Code	PG	Disc	Economy Vents	Qty	Price £
	HV1	076	780	7200mm ² vent area: 600x300mm slates	10	21.24
	HV2	076	780	7200mm ² vent area: 500x250mm slates	10	21.24
	HP1*	077	780	Vent terminal for 600x300mm slates	1	55.08
	Code	PG	Disc	Ridgeline Vents	Qty	Price £
	TV3N	072	780	Ridge vent 12,500mm ² vent area, suits most concrete & clay ridges	1	109.01
	TV31N	072	780	As TV3N with fitted extension sleeve	1	120.70
	TV3SN-110	072	780	As TV3N with fitted extension sleeve incl. 110mm dia pipe adaptor	1	126.67
	TV3SN-125	072	780	As TV3N with fitted extension sleeve incl. 125mm dia pipe adaptor	1	126.67
	NES	072	780	Narrow extension sleeve for short ridge vent less than 400mm long	1	11.70
	WES	072	780	Wide extension sleeve for standard ridge vent more than 400mm long	1	11.70
	WSA110	072	780	110mm dia adaptor for wide extension sleeve	1	11.70
	WSA125	072	780	125mm dia adaptor for wide extension sleeve for passive vent system	1	11.70





When ordering tile vents please state manufacturer, tile and colour for matching purposes.
*Includes soil pipe adaptor & flexi-tube.





Eaves Ventilation

	Code	PG	Disc	Product Description	Qty	Price £
	CF1	077	780	1m Eaves Comb Filler	300	0.69
	FT60	077	780	Eaves Fascia Tray 600mm long	50	2.26
	FT150	077	780	Eaves Fascia Tray 1500mm long	10	4.28
	RT50	077	780	6M Roll 300mm Wide Rafter Tray	10	10.32
	RT66	077	780	Rafter Tray Continuous 6m long roll 400mm wide, provides 25mm per LM air gap to fit common rafter spacings 600, 450, 400mm	4	13.77
	RT99	077	780	6M Roll 600mm Wide Rafter Tray	20	20.63
	RT132	077	780	6m Rafter Tray as above but 800mm wide, for low pitched roofs	4	27.50
	RT198	077	780	6M Roll 1200mm Wide Rafter Tray	4	43.73

Eaves & Fascia Ventilation

	Code	PG	Disc	Eaves Ventilation	Qty	Price £
	RT60	077	780	600mm Single Rafter Tray - provides 10mm per LM air gap	50	1.45
	RR46	077	780	Refurbishment Rafter Tray (48cm Long x 35cm Wide)	50	2.73
	Code	PG	Disc	Overfascia Vents	Qty	Price £
	OV10	077	780	Low profile - 1m x 10mm air gap	50	1.72
	FV10	077	780	Heavy duty - 1m x 10mm air gap	50	3.89
	FV25	077	780	Heavy duty - 1m x 25mm air gap	50	4.76

Soffit Vents

	Code	PG	Disc	Soffit Vents	Qty	Price £
	SD20W	077	780	Disc vent 2000mm ² ventilation area - white (80mm dia.)	50	0.68
	SV10W	077	780	10mm continuous air gap - each 2.44m long - white	10	6.67

Check out our website



Check out our website where you will find a selection of resources including product guides, certification, datasheets, installation guides and videos.

If you can't find what you're looking for or require additional guidance
Email info@arielplastics.com
 or **Call** 01246 281111.



arielplastics.com

Corovent URS

Universal Ridge System



Corovent Universal Ridge is designed to provide a totally dry fixed and weathertight ridge that is fast and simple to install. Every ridge unit is mechanically fixed eliminating the need for mortar completely.

- Unique jointing system for versatility
- Accommodates most known ridge tiles
- Can be used with both half round & angled ridges
- Dry fix is the fastest way to install ridge tiles
- No wet trades needed
- Smooth line providing a discreet appearance

The Corovent dry fix system is supplied as a complete system with all components to fix 6m of ridge.



Universal Dry Fix Ridge System (vented)

Code	PG	Disc	Product Description	Outer Qty	Price £
URS6/B	071	780	1 Dry Fix Roll Out 6m x 300mm 13 Dry Ridge Unions, Fixing Caps & Screws 10 Dry Ridge Union Brackets	1	102.21
URS6/RT	071	780	Dry Fix Roll Out 6m x 300mm	1	52.69
URS6/USB	071	780	Dry Ridge Unions, Fixing Caps & Screws	13	7.60

Designed for standard ridge tiles at 450mm width.

Corovent DHS

Dry Hip System



Corovent DHS provides a mechanically fixed, weathertight and attractive finish to the hip line without the use of mortar bedding. The Corovent DHS is fully compatible with Corovent URS Dry Ridge System.

- Quick & easy to install
- No special tools required
- Mortar free
- UV stable
- Water resistant

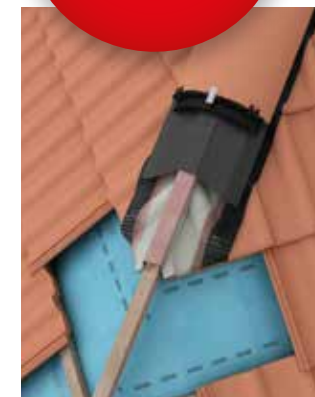

Dry Fix Hip System

Code	PG	Disc	Product Description	Outer Qty	Price £
URS6/B	071	780	1 Dry Fix Roll Out 6m x 300mm 13 Dry Ridge Unions, Fixing Caps & Screws 10 Dry Ridge Union Brackets	1	102.21
UHS6/FIX	071	780	4 75mm x 4.8 S/S Screws 4 Sealing Washers 50 25mm x 3.5 mm S/S ARS Nails	1	21.75
UHS6/TT	071	780	Tile Ties	30	1.23
UHS6/HST	071	780	PVC Hip Tray (1m Length)	1	11.91

Alternative to PVC Tray

Code	PG	Disc	Product Description	Outer Qty	Price £
HST3	071	780	GRP Hips Support Tray (3m Length)	1	23.35

The above items can also be sold separately. A PVC or a GRP Tray can be used.

Corodrain

Roof Drainage

The **Corodrain** range of BBA approved valley troughs are manufactured in GRP as an economic and durable alternative to using lead and all conform to NFRC Technical Bulletin 28.

Corodrain valley troughs can be used on both slate and tiled roofs and with any combination of double or interlocking slates, clay or concrete tiles. Corodrain can also provide a weatherproof seal between roofs of terraced houses or where a new roof needs to join an existing roof.

- A cost effective alternative to lead
- More resistant to damage and theft
- Maintenance free
- UV light and acid rain resistant
- Smooth finish inhibits growth of moss or build up of debris
- Significant reduction in installation time
- ISO 9001 & BBA Approved
- Largest range of lengths available



D-Valleys	A-Valleys	B-Valleys	Unequal Pitches	Dry Valleys
Standard Corodrain valley troughs for use with single and double lap tiles. Both standard (type:HD) and heavy duty (type:DX). They incorporate sanded strips (min. width 35mm) for the mortar to bond to.	Narrow Corodrain valley troughs for use with single and double lap tiles in limited applications. Both standard (type:HA) and heavy duty (type:AX). They incorporate sanded strips (min. width 35mm) for the mortar to bond to.	Standard Corodrain valley troughs for use with double lap slates and tiles, which are dry bedded. Both standard (type:HB) and heavy duty.	B & D-Valleys are designed for use where the differential between two rafter pitches is 15° or less. Industry standards recommend A-Valleys should only be used for pitch differences of 10° or less.	Dry fix valley trough completely eliminates risk of water coming into contact with the batten. No wet trades are required so it can be fitted in any weather.

Corodrain Standard Range

	Code	PG	Disc	Valley Trough (BBA Approved)	Outer Qty	Price £
A Type	Standard Weight - 360mm width (1.83kg/m²)					
	HA30	078	790	A type 3m long universal	10	28.95
	HB30	078	790	B type 3m long slate	10	28.95
B Type	HE30	078	790	E type 3m std valley trough (1.66kg/m²)	10	26.05
	Standard Weight - 410mm width (1.83kg/m²)					
E Type	HD30	078	790	D type 3m long universal	10	33.58
Heavy Weight - 360mm width (2.44kg/m²)						
D Type	AX30	078	790	A type 3m universal heavy weight	10	52.11
Heavy Weight - 410mm width (2.44kg/m²)						
BD30	DX30	078	790	D type 3m universal heavy weight	10	58.43
Diamond 60 - (2.44kg/m²)						
	BD30	078	790	B type 3m diamond 60 slate	10	64.81
	DD30	078	790	D type 3m diamond 60 universal	10	68.32

	Code	PG	Disc	Joining Gutter	Outer Qty	Price £
	HC30	078	790	3m long joining gutter	10	28.95

	Code	PG	Disc	Abutment Soaker	Outer Qty	Price £
	AS30	078	790	3m long abutment soaker	10	53.00
	AS30L	078	790	3m long abutment soaker lipped	10	57.78

	Code	PG	Disc	Slate Starter Strip	Outer Qty	Price £
	US30	077	790	3m long universal slate starter strip	10	47.61

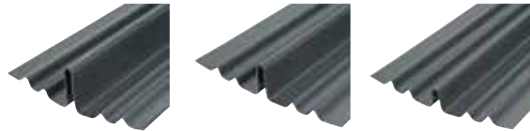

105mm upstand 80mm upstand 55mm upstand

Traditional Dry Fix Valley

Code	PG	Disc	Product Description	Width mm	Length mm	Price £
DVU30DW105	071	790	Traditional Dry Fix Valley - 105mm Upstand	370	3000	61.52
DVU30DW80	071	790	Traditional Dry Fix Valley - 80mm Upstand	370	3000	61.52
DVU30DW55	071	790	Traditional Dry Fix Valley - 55mm Upstand	370	3000	61.52



110mm upstand 90mm upstand 70mm upstand

Universal Dry Fix Valley

Code	PG	Disc	Product Description	Width mm	Length mm	Price £
DVU30SW110	071	790	Dry Fix Valley Standard - 110mm Upstand	280	3000	52.16
DVU30SW90	071	790	Dry Fix Valley Standard - 90mm Upstand	280	3000	52.16
DVU30SW70	071	790	Dry Fix Valley Standard - 70mm Upstand	280	3000	52.16
DVU30VT110	071	790	Dry Fix Valley Over Batten - 110mm Upstand	280	3000	66.02
DVU30VT70	071	790	Dry Fix Valley Over Batten - 70mm Upstand	280	3000	66.02

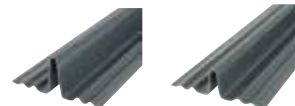

100mm upstand 70mm upstand

Universal Dry Fix Joining Gutter

Code	PG	Disc	Product Description	Width mm	Length mm	Price £
DBG30HW100	071	790	Dry Joining Gutter Heavyweight 100mm Upstand	280	3000	77.56
DBG30HW70	071	790	Dry Joining Gutter Heavyweight 70mm Upstand	280	3000	77.56

Code	PG	Disc	Product Description	Price £
DVBRACKET	071	790	Dry Valley Support Bracket Galvanised (pack of 5)	19.10
DVCLIP	071	790	Dry Valley Tile Clips (pack of 20)	53.81

**Need a price?
Get a no obligation
quote today!**

For a no obligation quote on any Ariel product please contact our team now

T: 01246 561104

E: quotes@arielplastics.com



Coroverge

Universal Dry Verge System



Coroverge is a mortar free dry verge system which acts as a closure on the roof verge of houses, garages and porches to protect tiles from wind uplift, pest infestation and weather degradation in accordance with BS5534.

- 100% mortar free dry fix verge
- Fully adjustable for batten gauges of 260-350mm
- Hardwearing and durable
- Quick and easy to install
- Selection of popular colours

COLOURS AVAILABLE

- > Anthracite Grey
- > Brown
- > Terracotta

APPLICATIONS

- > House Roof Verge
- > Garage Roof Verge
- > Porch Roof Verge

Universal Dry Verge Components

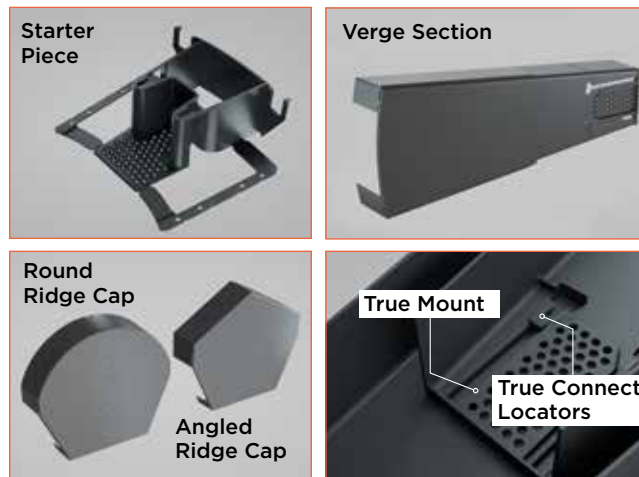

Manufactured from modern plastic material, Coroverge is very quick and easy to install.

Combining strength and resilience with an attractive finish, the Coroverge Dry Verge System is available in a selection of popular colours.

Universal Dry Verge System

Code	PG	Disc	Product Description	Colour	Price £
UVS/AG	071	051	Universal Dry Fix Verge Section	Anthracite Grey	5.75
UVS/BR	071	051	Universal Dry Fix Verge Section	Brown	5.75
UVS/TC	071	051	Universal Dry Fix Verge Section	Terracotta	5.75
UVSSP/AG	071	051	True Line Starter Piece	Anthracite Grey	7.24
UVSSP/BR	071	051	True Line Starter Piece	Brown	7.24
UVSSP/TC	071	051	True Line Starter Piece	Terracotta	7.24
UVSA/AG	071	051	Angled Ridge Cap	Anthracite Grey	8.05
UVSA/BR	071	051	Angled Ridge Cap	Brown	8.05
UVSA/TC	071	051	Angled Ridge Cap	Terracotta	8.05
UVSHR/AG	071	051	Half Round Ridge Cap	Anthracite Grey	8.45
UVSHR/BR	071	051	Half Round Ridge Cap	Brown	8.45
UVSHR/TC	071	051	Half Round Ridge Cap	Terracotta	8.45
UVS/BFIX	071	051	Batten End Clips Fixing Pack (Bag of 10)	S. Steel	36.72

Corotherm

Polycarbonate Insulating Roofing Sheet

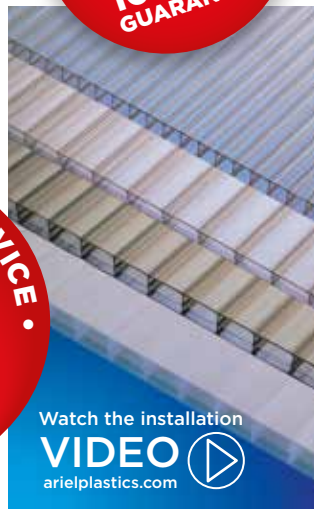

Watch the installation VIDEO arielplastics.com

Corotherm multiwall polycarbonate sheet is a lightweight impact resistant glazing and roofing material.

- Range of tints, thicknesses & sheet sizes
- Very strong and resistant to impact
- Fire rated 'Class 1' for safety
- Minimum condensation risk
- UV protected for durability
- Largely self-cleaning
- Guaranteed 10 year warranty

Ideal wherever heat insulation, reduced condensation, or simply a more attractive glazing material is required.

TINTS AVAILABLE

- > Clear
- > Bronze
- > Opal
- > Bronze Opal
- > Heatguard Opal

APPLICATIONS

- > Conservatories
- > Extensions
- > Car Ports
- > Porches
- > Swimming Pool Covers

Whether you are installing a veranda, canopy or carport **Corotherm multiwall polycarbonate sheet is the ideal choice.** This lightweight impact resistant glazing material is easy to handle, cut and install. For use in projects around the home and garden, Corotherm sheets are available in a range of thicknesses in light transmitting and solar controlling tints.

KEY INSTALLATION POINTS

Make sure UV protected side of sheet is facing outwards.

Allow minimum of 10° roof slope for water drainage.

The Ariel purlin supported glazing bar (for glazing bar base and cap see page 28) should be supported at intervals no greater than 1500mm.

Rafter glazing bars should be fully supported by rafters.

The lines of the flutes on the sheet must only run from the top to the bottom of the slope. They cannot be run from side to side.

Sheets cannot be joined top to bottom.

Glazing bars/F section cannot be joined - must be used as a continuous section.

When using F section run a suitable low-modulus silicone sealant down the inner top face of the enclosure before inserting sheet.

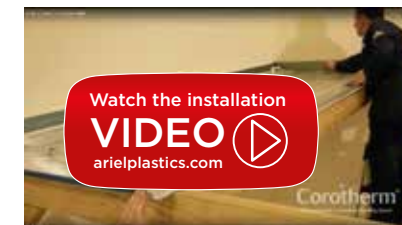

Energy Efficiency - Relative U-Values*

Sheet Thickness (mm)	Corotherm	Single Glass	Double Glass	Argon Filled Cavity
6 (Twinwall)	3.7	5.7	2.65	1.6
10 (Twinwall)	3.2	5.6	2.65	1.6
16 (Triplewall)	2.4	5.4	2.65	1.6
25 (Sevenwall)	1.4	-	2.65	1.6

ACCESSORIES



- Rafter Glazing Bar Cap & Base
- Glazing Bar Base
- Glazing Bar End Cap
- Glazing Bar Cap
- Side Flashing
- End Cap
- Fixing Button
- Breather Tape
- Aluminium Sealing Tape

Corotherm

4mm Clear Twinwall

4mm for side cladding only, not suitable for roofing

Code	PG	Disc	Product Description	Width mm	Length mm	Price £
76880	030	762	Corotherm Clear Twinwall Sheet	610	1220	12.58
76881	030	762	Corotherm Clear Twinwall Sheet	1220	1220	24.93

6mm Clear Twinwall

6mm for side cladding only, not suitable for roofing

Code	PG	Disc	Product Description	Width mm	Length mm	Price £
76265	030	762	Corotherm Clear Twinwall Sheet	1050	6000	171.95
76160	030	762	Corotherm Clear Twinwall Sheet	2100	6000	343.92

10mm Clear Twinwall

Code	PG	Disc	Product Description	Width mm	Length mm	Price £
76104	030	763	Corotherm Clear Twinwall Sheet	700	2000	55.18
76523	030	763	Corotherm Clear Twinwall Sheet	700	2500	68.95
76100	030	763	Corotherm Clear Twinwall Sheet	700	3000	82.77
76238	030	763	Corotherm Clear Twinwall Sheet	700	4000	110.35
76525	030	763	Corotherm Clear Twinwall Sheet	700	6000	165.52
76624	030	763	Corotherm Clear Twinwall Sheet	900	2000	70.96
76610	030	763	Corotherm Clear Twinwall Sheet	900	2500	88.64
76664	030	763	Corotherm Clear Twinwall Sheet	900	3000	106.40
76607	030	763	Corotherm Clear Twinwall Sheet	900	4000	141.87
76608	030	763	Corotherm Clear Twinwall Sheet	900	6000	212.80
76653	030	763	Corotherm Clear Twinwall Sheet	980	2000	77.24
76650	030	763	Corotherm Clear Twinwall Sheet	980	2500	96.56
76654	030	763	Corotherm Clear Twinwall Sheet	980	3000	115.86
76655	030	763	Corotherm Clear Twinwall Sheet	980	4000	154.47
76652	030	763	Corotherm Clear Twinwall Sheet	980	6000	231.73
76215	030	763	Corotherm Clear Twinwall Sheet	1050	2000	82.77
76218	030	763	Corotherm Clear Twinwall Sheet	1050	2500	103.46
76230	030	763	Corotherm Clear Twinwall Sheet	1050	3000	124.14
76245	030	763	Corotherm Clear Twinwall Sheet	1050	4000	165.52
76260	030	763	Corotherm Clear Twinwall Sheet	1050	6000	248.27
76782	030	763	Corotherm Clear Twinwall Sheet	1220	2000	96.14
76697	030	763	Corotherm Clear Twinwall Sheet	1220	2500	120.19
76790	030	763	Corotherm Clear Twinwall Sheet	1220	3000	144.23
76820	030	763	Corotherm Clear Twinwall Sheet	1220	4000	192.31
76764	030	763	Corotherm Clear Twinwall Sheet	1220	6000	288.49

10mm Clear Twinwall

Code	PG	Disc	Product Description	Width mm	Length mm	Price £
76637	030	763	Corotherm Clear Twinwall Sheet	1600	2000	126.10
76331	030	763	Corotherm Clear Twinwall Sheet	1600	2500	157.64
76645	030	763	Corotherm Clear Twinwall Sheet	1600	3000	189.16
76625	030	763	Corotherm Clear Twinwall Sheet	1600	4000	252.20
76307	030	763	Corotherm Clear Twinwall Sheet	1600	6000	378.33
76170	030	763	Corotherm Clear Twinwall Sheet	2100	2000	165.52
76520	030	763	Corotherm Clear Twinwall Sheet	2100	2500	206.91
76185	030	763	Corotherm Clear Twinwall Sheet	2100	3000	248.27
76200	030	763	Corotherm Clear Twinwall Sheet	2100	4000	331.04
76155	030	763	Corotherm Clear Twinwall Sheet	2100	6000	496.54

10mm Bronze Twinwall

Code	PG	Disc	Product Description	Width mm	Length mm	Price £
76216	030	765	Corotherm Bronze Twinwall Sheet	1050	2000	86.89
76231	030	765	Corotherm Bronze Twinwall Sheet	1050	3000	130.35
76246	030	765	Corotherm Bronze Twinwall Sheet	1050	4000	173.84
76261	030	765	Corotherm Bronze Twinwall Sheet	1050	6000	260.74
76171	030	765	Corotherm Bronze Twinwall Sheet	2100	2000	164.00
76186	030	765	Corotherm Bronze Twinwall Sheet	2100	3000	260.74
76201	030	765	Corotherm Bronze Twinwall Sheet	2100	4000	347.64
76156	030	765	Corotherm Bronze Twinwall Sheet	2100	6000	521.48

16mm Clear Triplewall

Code	PG	Disc	Product Description	Width mm	Length mm	Price £
76876	030	764	Corotherm Clear Triplewall Sheet	610	2000	71.57
76849	030	764	Corotherm Clear Triplewall Sheet	610	2500	89.46
76874	030	764	Corotherm Clear Triplewall Sheet	610	3000	107.33
76898	030	764	Corotherm Clear Triplewall Sheet	610	4000	143.12
76899	030	764	Corotherm Clear Triplewall Sheet	610	6000	214.66
76709	030	764	Corotherm Clear Triplewall Sheet	700	2000	82.10
76543	030	764	Corotherm Clear Triplewall Sheet	700	2500	102.63
76103	030	764	Corotherm Clear Triplewall Sheet	700	3000	123.18
76251	030	764	Corotherm Clear Triplewall Sheet	700	4000	164.23
76105	030	764	Corotherm Clear Triplewall Sheet	700	6000	187.19



16mm Clear Triplewall

Code	PG	Disc	Product Description	Width mm	Length mm	Price £
76630	030	764	Corotherm Clear Triplewall Sheet	800	2000	93.85
76364	030	764	Corotherm Clear Triplewall Sheet	800	2500	117.31
76679	030	764	Corotherm Clear Triplewall Sheet	800	3000	140.80
76286	030	764	Corotherm Clear Triplewall Sheet	800	4000	187.69
76900	030	764	Corotherm Clear Triplewall Sheet	800	6000	281.51
76671	030	764	Corotherm Clear Triplewall Sheet	900	2000	105.56
76639	030	764	Corotherm Clear Triplewall Sheet	900	2500	131.97
76613	030	764	Corotherm Clear Triplewall Sheet	900	3000	158.37
76620	030	764	Corotherm Clear Triplewall Sheet	900	4000	211.15
76612	030	764	Corotherm Clear Triplewall Sheet	900	6000	316.70
76659	030	764	Corotherm Clear Triplewall Sheet	980	2000	114.94
76656	030	764	Corotherm Clear Triplewall Sheet	980	2500	143.66
76660	030	764	Corotherm Clear Triplewall Sheet	980	3000	172.44
76661	030	764	Corotherm Clear Triplewall Sheet	980	4000	229.94
76658	030	764	Corotherm Clear Triplewall Sheet	980	6000	344.89
76210	030	764	Corotherm Clear Triplewall Sheet	1050	2000	123.18
76521	030	764	Corotherm Clear Triplewall Sheet	1050	2500	153.96
76225	030	764	Corotherm Clear Triplewall Sheet	1050	3000	184.77
76240	030	764	Corotherm Clear Triplewall Sheet	1050	4000	246.30
76255	030	764	Corotherm Clear Triplewall Sheet	1050	6000	369.50
76841	030	764	Corotherm Clear Triplewall Sheet	1220	2000	143.12
76766	030	764	Corotherm Clear Triplewall Sheet	1220	2500	178.86
76715	030	764	Corotherm Clear Triplewall Sheet	1220	3000	214.66
76769	030	764	Corotherm Clear Triplewall Sheet	1220	4000	286.21
76758	030	764	Corotherm Clear Triplewall Sheet	1220	6000	429.32
76621	030	764	Corotherm Clear Triplewall Sheet	1600	2000	187.68
76674	030	764	Corotherm Clear Triplewall Sheet	1600	2500	234.61
76616	030	764	Corotherm Clear Triplewall Sheet	1600	3000	281.54
76614	030	764	Corotherm Clear Triplewall Sheet	1600	4000	375.40
76316	030	764	Corotherm Clear Triplewall Sheet	1600	6000	563.05
76165	030	764	Corotherm Clear Triplewall Sheet	2100	2000	232.36
76540	030	764	Corotherm Clear Triplewall Sheet	2100	2500	307.94
76180	030	764	Corotherm Clear Triplewall Sheet	2100	3000	369.50
76195	030	764	Corotherm Clear Triplewall Sheet	2100	4000	492.68
76150	030	764	Corotherm Clear Triplewall Sheet	2100	6000	739.05



16mm Bronze Triplewall

Code	PG	Disc	Product Description	Width mm	Length mm	Price £
76918	030	766	Corotherm Bronze Triplewall Sheet	610	2000	75.16
76919	030	766	Corotherm Bronze Triplewall Sheet	610	2500	93.93
76845	030	766	Corotherm Bronze Triplewall Sheet	610	3000	112.70
77112	030	766	Corotherm Bronze Triplewall Sheet	610	4000	150.27
77073	030	766	Corotherm Bronze Triplewall Sheet	610	6000	225.39
76234	030	766	Corotherm Bronze Triplewall Sheet	700	2000	86.24
76707	030	766	Corotherm Bronze Triplewall Sheet	700	2500	107.77
76183	030	766	Corotherm Bronze Triplewall Sheet	700	3000	129.32
76239	030	766	Corotherm Bronze Triplewall Sheet	700	4000	172.44
76106	030	766	Corotherm Bronze Triplewall Sheet	700	6000	258.68
76871	030	766	Corotherm Bronze Triplewall Sheet	800	2000	98.52
76867	030	766	Corotherm Bronze Triplewall Sheet	800	2500	123.17
76846	030	766	Corotherm Bronze Triplewall Sheet	800	3000	147.78
76792	030	766	Corotherm Bronze Triplewall Sheet	800	4000	197.06
76971	030	766	Corotherm Bronze Triplewall Sheet	800	6000	295.62
76852	030	766	Corotherm Bronze Triplewall Sheet	900	2000	110.87
76746	030	766	Corotherm Bronze Triplewall Sheet	900	2500	138.58
76755	030	766	Corotherm Bronze Triplewall Sheet	900	3000	166.28
76796	030	766	Corotherm Bronze Triplewall Sheet	900	4000	221.70
76635	030	766	Corotherm Bronze Triplewall Sheet	900	6000	332.57
76756	030	766	Corotherm Bronze Triplewall Sheet	980	2000	120.68
76213	030	766	Corotherm Bronze Triplewall Sheet	980	2500	150.90
76761	030	766	Corotherm Bronze Triplewall Sheet	980	3000	181.08
76767	030	766	Corotherm Bronze Triplewall Sheet	980	4000	241.40
77183	030	766	Corotherm Bronze Triplewall Sheet	980	6000	362.14
76211	030	766	Corotherm Bronze Triplewall Sheet	1050	2000	129.32
76248	030	766	Corotherm Bronze Triplewall Sheet	1050	2500	161.65
76226	030	766	Corotherm Bronze Triplewall Sheet	1050	3000	193.99
76241	030	766	Corotherm Bronze Triplewall Sheet	1050	4000	258.68
76256	030	766	Corotherm Bronze Triplewall Sheet	1050	6000	387.99
76768	030	766	Corotherm Bronze Triplewall Sheet	1220	2000	150.27
77074	030	766	Corotherm Bronze Triplewall Sheet	1220	2500	187.83
76704	030	766	Corotherm Bronze Triplewall Sheet	1220	3000	225.39
76754	030	766	Corotherm Bronze Triplewall Sheet	1220	4000	300.52
77236	030	766	Corotherm Bronze Triplewall Sheet	1220	6000	450.81

Corotherm

16mm Bronze Triplewall

Code	PG	Disc	Product Description	Width mm	Length mm	Price £
76786	030	766	Corotherm Bronze Triplewall Sheet	1600	2000	197.06
76757	030	766	Corotherm Bronze Triplewall Sheet	1600	2500	246.36
76789	030	766	Corotherm Bronze Triplewall Sheet	1600	3000	295.62
77115	030	766	Corotherm Bronze Triplewall Sheet	1600	4000	394.15
76743	030	766	Corotherm Bronze Triplewall Sheet	1600	6000	591.20
76166	030	766	Corotherm Bronze Triplewall Sheet	2100	2000	244.02
76214	030	766	Corotherm Bronze Triplewall Sheet	2100	2500	323.33
76181	030	766	Corotherm Bronze Triplewall Sheet	2100	3000	387.99
76178	030	766	Corotherm Bronze Triplewall Sheet	2100	4000	517.32
76151	030	766	Corotherm Bronze Triplewall Sheet	2100	6000	775.99

16mm Opal Triplewall

Code	PG	Disc	Product Description	Width mm	Length mm	Price £
76934	030	766	Corotherm Opal Triplewall Sheet	610	2000	75.16
77375	030	766	Corotherm Opal Triplewall Sheet	610	2500	93.93
77053	030	766	Corotherm Opal Triplewall Sheet	610	3000	112.70
77080	030	766	Corotherm Opal Triplewall Sheet	610	4000	150.27
606116OH	030	766	Corotherm Opal Triplewall Sheet	610	6000	225.39
76742	030	766	Corotherm Opal Triplewall Sheet	700	2000	86.24
77262	030	766	Corotherm Opal Triplewall Sheet	700	2500	107.77
76233	030	766	Corotherm Opal Triplewall Sheet	700	3000	129.32
77082	030	766	Corotherm Opal Triplewall Sheet	700	4000	172.44
607016OH	030	766	Corotherm Opal Triplewall Sheet	700	6000	258.68
76793	030	766	Corotherm Opal Triplewall Sheet	800	2000	98.52
77018	030	766	Corotherm Opal Triplewall Sheet	800	2500	123.17
77266	030	766	Corotherm Opal Triplewall Sheet	800	3000	147.78
76954	030	766	Corotherm Opal Triplewall Sheet	800	4000	197.06
77187	030	766	Corotherm Opal Triplewall Sheet	800	6000	295.62
77113	030	766	Corotherm Opal Triplewall Sheet	900	2000	110.87
76873	030	766	Corotherm Opal Triplewall Sheet	900	2500	138.58
76972	030	766	Corotherm Opal Triplewall Sheet	900	3000	166.28
77184	030	766	Corotherm Opal Triplewall Sheet	900	4000	221.70
609016OH	030	766	Corotherm Opal Triplewall Sheet	900	6000	332.57

Corotherm

16mm Opal Triplewall

Code	PG	Disc	Product Description	Width mm	Length mm	Price £
77086	030	766	Corotherm Opal Triplewall Sheet	980	2000	120.68
77119	030	766	Corotherm Opal Triplewall Sheet	980	2500	150.90
76810	030	766	Corotherm Opal Triplewall Sheet	980	3000	181.08
76981	030	766	Corotherm Opal Triplewall Sheet	980	4000	241.40
77281	030	766	Corotherm Opal Triplewall Sheet	980	6000	362.14
76212	030	766	Corotherm Opal Triplewall Sheet	1050	2000	129.32
77027	030	766	Corotherm Opal Triplewall Sheet	1050	2500	161.65
76227	030	766	Corotherm Opal Triplewall Sheet	1050	3000	193.99
76242	030	766	Corotherm Opal Triplewall Sheet	1050	4000	258.68
76257	030	766	Corotherm Opal Triplewall Sheet	1050	6000	387.99
76994	030	766	Corotherm Opal Triplewall Sheet	1220	2000	150.27
77191	030	766	Corotherm Opal Triplewall Sheet	1220	2500	187.83
76847	030	766	Corotherm Opal Triplewall Sheet	1220	3000	225.39
77195	030	766	Corotherm Opal Triplewall Sheet	1220	4000	300.52
76676	030	766	Corotherm Opal Triplewall Sheet	1220	6000	450.81
77088	030	766	Corotherm Opal Triplewall Sheet	1600	2000	197.06
77224	030	766	Corotherm Opal Triplewall Sheet	1600	2500	246.36
77081	030	766	Corotherm Opal Triplewall Sheet	1600	3000	295.62
77208	030	766	Corotherm Opal Triplewall Sheet	1600	4000	394.15
77149	030	766	Corotherm Opal Triplewall Sheet	1600	6000	591.20
76167	030	766	Corotherm Opal Triplewall Sheet	2100	2000	244.02
76727	030	766	Corotherm Opal Triplewall Sheet	2100	2500	323.33
76182	030	766	Corotherm Opal Triplewall Sheet	2100	3000	387.99
79196	030	766	Corotherm Opal Triplewall Sheet	2100	4000	517.32
76152	030	766	Corotherm Opal Triplewall Sheet	2100	6000	775.99

Corotherm

25mm Clear Sevenwall

Code	PG	Disc	Product Description	Width mm	Length mm	Price £
2070255CH	030	900	Corotherm Clear Sheet	700	2000	106.48
2570255CH	030	900	Corotherm Clear Sheet	700	2500	133.11
3070255CH	030	900	Corotherm Clear Sheet	700	3000	159.73
4070255CH	030	900	Corotherm Clear Sheet	700	4000	212.96
6070255CH	030	900	Corotherm Clear Sheet	700	6000	319.42
2080255CH	030	900	Corotherm Clear Sheet	800	2000	121.69
2580255CH	030	900	Corotherm Clear Sheet	800	2500	152.13
3080255CH	030	900	Corotherm Clear Sheet	800	3000	182.53
4080255CH	030	900	Corotherm Clear Sheet	800	4000	243.39
6080255CH	030	900	Corotherm Clear Sheet	800	6000	365.07
2090255CH	030	900	Corotherm Clear Sheet	900	2000	136.90
2590255CH	030	900	Corotherm Clear Sheet	900	2500	171.10
3090255CH	030	900	Corotherm Clear Sheet	900	3000	205.32
4090255CH	030	900	Corotherm Clear Sheet	900	4000	273.80
6090255CH	030	900	Corotherm Clear Sheet	900	6000	410.70
2010255CH	030	900	Corotherm Clear Sheet	1050	2000	159.73
2510255CH	030	900	Corotherm Clear Sheet	1050	2500	199.63
3010255CH	030	900	Corotherm Clear Sheet	1050	3000	239.60
4010255CH	030	900	Corotherm Clear Sheet	1050	4000	319.42
6010255CH	030	900	Corotherm Clear Sheet	1050	6000	479.16
2016255CH	030	900	Corotherm Clear Sheet	1600	2000	243.39
2516255CH	030	900	Corotherm Clear Sheet	1600	2500	304.20
3016255CH	030	900	Corotherm Clear Sheet	1600	3000	365.07
4016255CH	030	900	Corotherm Clear Sheet	1600	4000	486.76
6016255CH	030	900	Corotherm Clear Sheet	1600	6000	730.17
2021255CH	030	900	Corotherm Clear Sheet	2100	2000	319.42
2521255CH	030	900	Corotherm Clear Sheet	2100	2500	399.31
3021255CH	030	900	Corotherm Clear Sheet	2100	3000	479.16
4021255CH	030	900	Corotherm Clear Sheet	2100	4000	638.87
6021255CH	030	900	Corotherm Clear Sheet	2100	6000	958.32

Corotherm

25mm Bronze Sevenwall

Code	PG	Disc	Product Description	Width mm	Length mm	Price £
2070255BH	030	901	Corotherm Bronze Sheet	700	2000	111.80
2570255BH	030	901	Corotherm Bronze Sheet	700	2500	139.75
3070255BH	030	901	Corotherm Bronze Sheet	700	3000	167.71
4070255BH	030	901	Corotherm Bronze Sheet	700	4000	223.61
6070255BH	030	901	Corotherm Bronze Sheet	700	6000	335.42
2080255BH	030	901	Corotherm Bronze Sheet	800	2000	127.76
2580255BH	030	901	Corotherm Bronze Sheet	800	2500	159.73
3080255BH	030	901	Corotherm Bronze Sheet	800	3000	191.66
4080255BH	030	901	Corotherm Bronze Sheet	800	4000	255.54
6080255BH	030	901	Corotherm Bronze Sheet	800	6000	383.32
2090255BH	030	901	Corotherm Bronze Sheet	900	2000	143.75
2590255BH	030	901	Corotherm Bronze Sheet	900	2500	179.66
3090255BH	030	901	Corotherm Bronze Sheet	900	3000	215.62
4090255BH	030	901	Corotherm Bronze Sheet	900	4000	287.54
6090255BH	030	901	Corotherm Bronze Sheet	900	6000	431.27
2010255BH	030	901	Corotherm Bronze Sheet	1050	2000	167.71
2510255BH	030	901	Corotherm Bronze Sheet	1050	2500	209.65
3010255BH	030	901	Corotherm Bronze Sheet	1050	3000	251.55
4010255BH	030	901	Corotherm Bronze Sheet	1050	4000	335.42
6010255BH	030	901	Corotherm Bronze Sheet	1050	6000	503.12
2016255BH	030	901	Corotherm Bronze Sheet	1600	2000	255.54
2516255BH	030	901	Corotherm Bronze Sheet	1600	2500	319.42
3016255BH	030	901	Corotherm Bronze Sheet	1600	3000	383.32
4016255BH	030	901	Corotherm Bronze Sheet	1600	4000	511.10
6016255BH	030	901	Corotherm Bronze Sheet	1600	6000	766.66
2021255BH	030	901	Corotherm Bronze Sheet	2100	2000	335.42
2521255BH	030	901	Corotherm Bronze Sheet	2100	2500	419.29
3021255BH	030	901	Corotherm Bronze Sheet	2100	3000	503.12
4021255BH	030	901	Corotherm Bronze Sheet	2100	4000	670.83
6021255BH	030	901	Corotherm Bronze Sheet	2100	6000	1006.26

Corotherm

25mm Opal Sevenwall

Code	PG	Disc	Product Description	Width mm	Length mm	Price £
2070255OH	030	901	Corotherm Opal Sheet	700	2000	111.80
2570255OH	030	901	Corotherm Opal Sheet	700	2500	139.75
3070255OH	030	901	Corotherm Opal Sheet	700	3000	167.71
4070255OH	030	901	Corotherm Opal Sheet	700	4000	223.61
6070255OH	030	901	Corotherm Opal Sheet	700	6000	335.42
2080255OH	030	901	Corotherm Opal Sheet	800	2000	127.76
2580255OH	030	901	Corotherm Opal Sheet	800	2500	159.73
3080255OH	030	901	Corotherm Opal Sheet	800	3000	191.66
4080255OH	030	901	Corotherm Opal Sheet	800	4000	254.87
6080255OH	030	901	Corotherm Opal Sheet	800	6000	383.32
2090255OH	030	901	Corotherm Opal Sheet	900	2000	143.75
2590255OH	030	901	Corotherm Opal Sheet	900	2500	179.66
3090255OH	030	901	Corotherm Opal Sheet	900	3000	215.62
4090255OH	030	901	Corotherm Opal Sheet	900	4000	287.54
6090255OH	030	901	Corotherm Opal Sheet	900	6000	431.27
2010255OH	030	901	Corotherm Opal Sheet	1050	2000	167.71
2510255OH	030	901	Corotherm Opal Sheet	1050	2500	209.65
3010255OH	030	901	Corotherm Opal Sheet	1050	3000	251.55
4010255OH	030	901	Corotherm Opal Sheet	1050	4000	335.42
6010255OH	030	901	Corotherm Opal Sheet	1050	6000	503.12
2016255OH	030	901	Corotherm Opal Sheet	1600	2000	255.54
2516255OH	030	901	Corotherm Opal Sheet	1600	2500	319.42
3016255OH	030	901	Corotherm Opal Sheet	1600	3000	383.32
4016255OH	030	901	Corotherm Opal Sheet	1600	4000	511.10
6016255OH	030	901	Corotherm Opal Sheet	1600	6000	766.66
2021255OH	030	901	Corotherm Opal Sheet	2100	2000	335.42
2521255OH	030	901	Corotherm Opal Sheet	2100	2500	419.29
3021255OH	030	901	Corotherm Opal Sheet	2100	3000	503.12
4021255OH	030	901	Corotherm Opal Sheet	2100	4000	670.83
6021255OH	030	901	Corotherm Opal Sheet	2100	6000	1006.26

Corotherm

25mm Bronze Opal Sevenwall

Code	PG	Disc	Product Description	Width mm	Length mm	Price £
2070255BOH	030	902	Corotherm Bronze Opal Sheet	700	2000	122.50
2570255BOH	030	902	Corotherm Bronze Opal Sheet	700	2500	153.06
3070255BOH	030	902	Corotherm Bronze Opal Sheet	700	3000	183.70
4070255BOH	030	902	Corotherm Bronze Opal Sheet	700	4000	244.92
6070255BOH	030	902	Corotherm Bronze Opal Sheet	700	6000	367.35
2010255BOH	030	902	Corotherm Bronze Opal Sheet	1050	2000	183.70
2510255BOH	030	902	Corotherm Bronze Opal Sheet	1050	2500	229.61
3010255BOH	030	902	Corotherm Bronze Opal Sheet	1050	3000	275.49
4010255BOH	030	902	Corotherm Bronze Opal Sheet	1050	4000	367.35
6010255BOH	030	902	Corotherm Bronze Opal Sheet	1050	6000	551.04
2021255BOH	030	902	Corotherm Bronze Opal Sheet	2100	2000	367.35
2521255BOH	030	902	Corotherm Bronze Opal Sheet	2100	2500	459.20
3021255BOH	030	902	Corotherm Bronze Opal Sheet	2100	3000	551.04
4021255BOH	030	902	Corotherm Bronze Opal Sheet	2100	4000	734.71
6021255BOH	030	902	Corotherm Bronze Opal Sheet	2100	6000	1102.07

25mm Heatguard Opal Sevenwall

Code	PG	Disc	Product Description	Width mm	Length mm	Price £
2070255HOH	030	902	Corotherm Heatguard Opal Sheet	700	2000	122.50
2570255HOH	030	902	Corotherm Heatguard Opal Sheet	700	2500	153.06
3070255HOH	030	902	Corotherm Heatguard Opal Sheet	700	3000	183.70
4070255HOH	030	902	Corotherm Heatguard Opal Sheet	700	4000	244.92
6070255HOH	030	902	Corotherm Heatguard Opal Sheet	700	6000	367.35
2010255HOH	030	902	Corotherm Heatguard Opal Sheet	1050	2000	183.70
2510255HOH	030	902	Corotherm Heatguard Opal Sheet	1050	2500	229.61
3010255HOH	030	902	Corotherm Heatguard Opal Sheet	1050	3000	275.49
4010255HOH	030	902	Corotherm Heatguard Opal Sheet	1050	4000	367.35
6010255HOH	030	902	Corotherm Heatguard Opal Sheet	1050	6000	551.04
2021255HOH	030	902	Corotherm Heatguard Opal Sheet	2100	2000	367.35
2521255HOH	030	902	Corotherm Heatguard Opal Sheet	2100	2500	459.20
3021255HOH	030	902	Corotherm Heatguard Opal Sheet	2100	3000	551.04
4021255HOH	030	902	Corotherm Heatguard Opal Sheet	2100	4000	734.71
6021255HOH	030	902	Corotherm Heatguard Opal Sheet	2100	6000	1102.07

Accessories Multiwall polycarbonat

Code	PG	Disc	Rafter Glazing Bar Kit (for 10/16mm sheet only)	Colour	Length mm	Price £
76486	045	761	Rafter Glazing bar cap, base & end cap	White	3000	63.26
76551	045	761	Rafter Glazing bar cap, base & end cap	White	4000	83.24
BSYT	045	761	Rafter Glazing bar cap, base & end cap	White	6000	123.17
Code	PG	Disc	Aluminium Purlin Supported Glazing Bar Base (10/16mm sheets only)	Colour	Length mm	Price £
76118	045	761	Glazing bar base - used with cap	Alumin.	3000	52.05
76119	045	761	Glazing bar base - used with cap	Alumin.	4000	69.35
76347	045	761	Glazing bar base - used with cap	Alumin.	6000	104.01
Code	PG	Disc	PVC Purlin Supported Glazing Bar Top Cap (10/16mm sheets only)	Colour	Length mm	Price £
76110	045	761	Glazing bar cap - used with base	White	3000	22.91
76111	045	761	Glazing bar cap - used with base	White	4000	30.56
76348	045	761	Glazing bar cap - used with base	White	6000	45.80
76460	045	761	Glazing bar cap - used with base	Brown	3000	30.24
76461	045	761	Glazing bar cap - used with base	Brown	4000	40.29
76468	045	761	Glazing bar cap - used with base	Brown	6000	60.45
Code	PG	Disc	Rafter Glazing Bar Kit (10/16/25mm sheet)	Colour	Length mm	Price £
BHPO	045	761	Glazing bar cap & base - with end cap	White	3000	81.51
BHPR	045	761	Glazing bar cap & base - with end cap	White	4000	107.92
BHOR	045	761	Glazing bar cap & base - with end cap	White	6000	160.97
BJOP	045	761	Glazing bar cap & base - with end cap	Brown	3000	84.65
BYTO	045	761	Glazing bar cap & base - with end cap	Brown	4000	112.22
BGTY	045	761	Glazing bar cap & base - with end cap	Brown	6000	166.92
Code	PG	Disc	Side Flashing	Colour	Length mm	Price £
76112	045	761	10mm Side Flashing	White	3000	20.10
76113	045	761	10mm Side Flashing	White	4000	26.77
76346	045	761	10mm Side Flashing	White	6000	40.18
76342	045	761	10mm Side Flashing	Brown	3000	25.16
76343	045	761	10mm Side Flashing	Brown	4000	33.45
76466	045	761	10mm Side Flashing	Brown	6000	50.22
76114	045	761	16mm Side Flashing	White	3000	20.10
76115	045	761	16mm Side Flashing	White	4000	26.77
76341	045	761	16mm Side Flashing	White	6000	40.18
76463	045	761	16mm Side Flashing	Brown	3000	25.16
76464	045	761	16mm Side Flashing	Brown	4000	33.45
76465	045	761	16mm Side Flashing	Brown	6000	50.22



Accessories Multiwall polycarbonat

Code	PG	Disc	Side Flashing	Colour	Length mm	Price £
BCOS	045	761	25mm Side Flashing	White	3000	30.73
BMOJ	045	761	25mm Side Flashing	White	4000	40.76
BGVV	045	761	25mm Side Flashing	White	6000	60.84
BYKZ	045	761	25mm Side Flashing	Brown	3000	33.45
BHSS	045	761	25mm Side Flashing	Brown	4000	44.68
BPWP	045	761	25mm Side Flashing	Brown	6000	66.77
Code	PG	Disc	Sheet End Cap	Colour	Length mm	Price £
76123	045	761	6mm Sheet End Cap - pack of 2	Clear	2100	19.10
76116	045	761	10mm Sheet End Cap - pack of 2	White	2100	19.10
76462	045	761	10mm Sheet End Cap - pack of 2	Brown	2100	24.31
76117	045	761	16mm Sheet End Cap - pack of 2	White	2100	19.10
76467	045	761	16mm Sheet End Cap - pack of 2	Brown	2100	24.31
BRBP	045	761	25mm Sheet End Cap - pack of 2	White	2100	26.98
BRTU	045	761	25mm Sheet End Cap - pack of 2	Brown	2100	29.62
Code	PG	Disc	Glazing Bar End Cap	Colour	Length	Price £
76489	045	761	10/16mm Glazing Bar End Cap	White	-	3.28
BEFT	045	761	25mm Glazing Bar End Cap	White	-	3.28
BUZT	045	761	25mm Glazing Bar End Cap	Brown	-	4.93
Code	PG	Disc	Fixing Buttons	Colour	Length	Price £
76567	045	761	10mm Super Fixing Buttons - Pack of 10	White	-	22.39
76569	045	761	10mm Super Fixing Buttons - Pack of 10	Brown	-	22.39
76568	045	761	16mm Super Fixing Buttons - Pack of 10	White	-	22.39
76570	045	761	16mm Super Fixing Buttons - Pack of 10	Brown	-	22.39
BVUT	045	761	25mm Super Fixing Buttons - Pack of 10	White	-	23.20
BHUP	045	761	25mm Super Fixing Buttons - Pack of 10	Brown	-	23.20
Code	PG	Disc	Tapes & Sealant	Colour	Length mm	Price £
BSTP	045	761	10/16mm Breather Tape (38mm x 10m)	Blue	10,000	35.34
BMNO	045	761	10/16mm Aluminium Sealing Tape	Alumin.	10,000	7.61
BVTP	045	761	25mm Breather Tape (45mm x 10m)	Blue	10,000	41.34
BZOP	045	761	25mm Aluminium Sealing Tape (45mm x 10m)	Alumin.	10,000	8.96
76585	045	761	Flashing Tape (225mm x 10m)	Grey	10,000	81.66
76590	045	761	Low Modulus Silicone Sealant (310ml)	White	-	14.91



Self supporting roofing system



A professionally engineered **Self Supporting Roofing System** which free-spans 4.0m and accommodates 16mm, 25mm and 35mm Corotherm Multiwall Polycarbonate Roofing sheets (pg 16-29).

- Professionally engineered
- Innovative design
- Accommodates 16, 25 & 35mm sheet
- Easy to install
- Low maintenance

APPLICATIONS

- > Car Ports
- > Canopies
- > Conservatories
- > Replacement Roofing



Designed with flexibility in mind, this lean to roofing system is suitable for a wide variety of applications. Easy to install and available in a range of sizes - the Self Supporting Roofing System is the tradesman's choice.

Self Supporting Posts

Code	PG	Disc	Product Description	Colour	Price £
SSGP2	046	920	Self Supporting Goal Posts 2.5m (pack of 2)	White	381.41

Intermediate Bars*

Aluminium Glazing Bar with co-extruded PVC underclad and top capping

Code	PG	Disc	Product Description	Colour	Price £
SSBI25	046	920	2.5m Intermediate Bar	White	171.51
SSBI30	046	920	3.0m Intermediate Bar	White	205.72
SSBI35	046	920	3.5m Intermediate Bar	White	239.37
SSBI40	046	920	4.0m Intermediate Bar	White	274.30

*End caps included

End Bars*

Aluminium Glazing Bar with co-extruded PVC underclad and top capping

Code	PG	Disc	Product Description	Colour	Price £
SSBE25	046	920	2.5m End Bars	White	171.48
SSBE30	046	920	3.0m End Bars	White	205.72
SSBE35	046	920	3.5m End Bars	White	240.05
SSBE40	046	920	4.0m End Bars	White	274.30

*End caps included

End Caps

Code	PG	Disc	Product Description	Colour	Price £
SSEC	046	920	Bar End Caps	White	21.19

Wall Plates - Aluminium Wall Plate with PVC underclad and flashing

Code	PG	Disc	Product Description	Colour	Price £
SSBW30	046	920	3.0m Wall Plate	White	317.78
SSBW40	046	920	4.0m Wall Plate	White	423.70
SSBW50	046	920	5.0m Wall Plate	White	529.62

Standard Eaves Beam - Aluminium Eaves Beam with PVC Cladding

Code	PG	Disc	Product Description	Colour	Price £
SSEB3	046	920	3.0m Standard Eaves Beam	White	304.39
SSEB4	046	920	4.0m Standard Eaves Beam	White	337.73
SSEBC	046	920	Standard Eaves Beam Connector	White	16.72

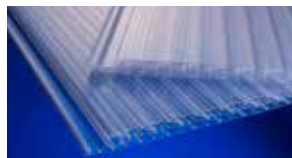

APPLICATIONS

- > Carports
- > Pool covers
- > Canopies
- > Veranda covers
- > Patio covers

**NO
GLAZING
BARS**

Manufactured from damage resistant polycarbonate, **Corotherm Clickfit** is the easy fit DIY roofing system that guarantees long-term performance. Requiring no glazing bars, the easy fit panels simply click and lock together to provide an instant roof. Perfect for DIY use, only standard tools are required to install. Simply cut panels to the required length, screw into place, click and lock the next panel and finish with a U profile.

- Simple DIY installation
- Hardwearing & durable
- No specialist tools required

Clickfit DIY Polycarbonate

Code	PG	Disc	Item Description	Tint	Price £
83001	32	500	Corotherm Clickfit Polycarb Sheet 16mm x 3000mm x 500mm	Clear	85.04
83011	32	500	Corotherm Clickfit Polycarb Sheet 16mm x 3000mm x 500mm	Opal	89.28
83031	32	500	Corotherm Clickfit F-Profile Aluminium 16mm x 3m	-	44.76
83041	32	500	Corotherm Clickfit U-Profile Aluminium 16mm x 3m	-	19.04
84001	32	500	Corotherm Clickfit Polycarb Sheet 16mm x 4000mm x 500mm	Clear	113.39
84011	32	500	Corotherm Clickfit Polycarb Sheet 16mm x 4000mm x 500mm	Opal	119.11
84031	32	500	Corotherm Clickfit F-Profile Aluminium 16mm x 4m	-	60.43
84041	32	500	Corotherm Clickfit U-Profile Aluminium 16mm x 4m	-	24.63
83051	32	500	Corotherm Clickfit Channel Washer*	-	0.66
BMNO	45	761	10/16mm Aluminium Sealing Tape 38mm x 10m	-	7.61
BSTP	45	761	10/16mm Breather Tape 38mm x 10m	-	35.34
76590	45	761	Low Modulus Silicone Sealant 310ml White	-	14.91

4m sizes also available POA. * Please use 4mm panhead stainless steel screws and 6mm drill piece, for expansion.



Corotherm
Topfit

Polycarbonate Standing Seam

APPLICATIONS

- > Pitched rooflights
- > Curved rooflights
- > Canopies
- > Vertical façades
- > Cladding & partitioning

Corotherm Topfit is a versatile modular panel glazing system with extruded standing seam profile. With a range of accessories the system can be adapted to suit a wide range of roofing and façade designs.

- High light transmission
- Thermally insulating multiwall panels
- Watertight
- 200 times stronger than glass
- Suitable for cold curving
- Free thermal expansion
- Longlife UV weather protection

Corotherm Topfit 16mm 7wall Polycarbonate Standing Seam Glazing System

Code	PG	Disc	Item Description	Tint	Price £
88100	32	500	Corotherm Topfit Polycarb Sheet 16mm x 6000mm x 1000mm	Clear	408.19
88600	32	500	Corotherm Topfit Polycarb Sheet 16mm x 6000mm x 600mm	Clear	244.92
88051	32	500	Corotherm Topfit PC Cap 6000mm	-	59.09
88061	32	500	Corotherm Topfit Aluminum mullion profile 6000mm	-	128.31
88071	32	500	Corotherm Topfit Standing Seam Clip (each)	Clear	2.44
88031	32	500	Corotherm Topfit F-Profile Aluminium 16mm x 6m	-	125.32
88041	32	500	Corotherm Topfit U-Profile Aluminium 16mm x 3m	-	33.42
88081	32	500	Corotherm Topfit Polycarb Cap	Clear	0.71
BZOP	45	761	Aluminium Sealing Tape 25mm x 10m	-	8.96
BVTP	45	761	Breather Tape 25mm x 10m	-	41.34
76590	45	761	Low Modulus Silicone Sealant 310ml White	-	14.91

Engineered to last, mega tough **Corolite** and **Corolite CST** polycarbonate sheets combine strength and impact resistance with glass like clarity and light transmission. This hardwearing and durable rooflight material is ideal for roofing applications which demand a sheet that punches above its weight for guaranteed long-term performance.

- High natural light transmission • Optically clear
- Damage and impact resistant • Lightweight and easy to handle
- Weather resistant • Longlife UV protection
- Excellent fire performance • Chemical resistance
- 10 year limited warranty*



APPLICATIONS

- > Patio Canopies
- > Awnings
- > Greenhouses
- > Carports
- > Gazebos & Pergolas



APPLICATIONS

- > Rooflights
- > Vertical Glazing
- > Screens
- > Cladding



*When fitted to manufacturers instructions

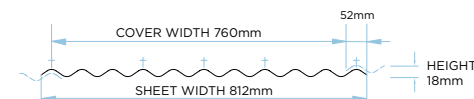

Corolite Iron Profile 10/3"

Code	PG	Disc	Product Description	Colour	Width mm	Thickness mm	Length mm	Price £
27004	067	067	Corrugated Polycarbonate Sheet	Clear	812	1	1830	37.53
27008	067	067	Corrugated Polycarbonate Sheet	Clear	812	1	2440	50.05
27012	067	067	Corrugated Polycarbonate Sheet	Clear	812	1	3050	62.59

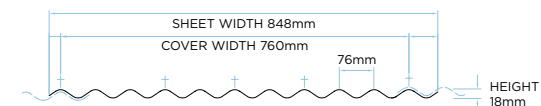

Corolite Iron Profile 10.5/3"

Code	PG	Disc	Product Description	Colour	Width mm	Thickness mm	Length mm	Price £
76902	067	067	Corrugated 3" Polycarbonate Sheet	Clear	848	0.8	1800	43.19
76904	067	067	Corrugated 3" Polycarbonate Sheet	Clear	848	0.8	2400	57.60
76906	067	067	Corrugated 3" Polycarbonate Sheet	Clear	848	0.8	3000	71.99

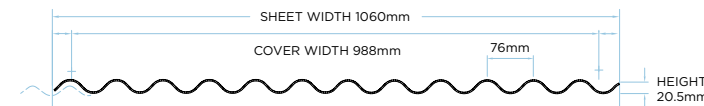

Corolite CST Iron Profile 13/3" Twinwall

Code	PG	Disc	Product Description	Colour	Width mm	Thickness mm	Length mm	Price £
75004	067	067	Corrugated Twinwall Sheet	Clear	1060	2.5	1830	67.27
75008	067	067	Corrugated Twinwall Sheet	Clear	1060	2.5	2440	89.67
75012	067	067	Corrugated Twinwall Sheet	Clear	1060	2.5	3050	112.11

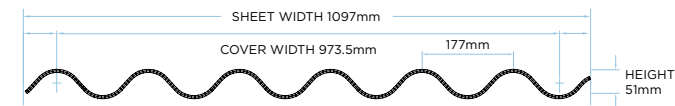

Corolite CST 177/51 Triplewall

Code	PG	Disc	Product Description	Colour	Width mm	Thickness mm	Length mm	Price £
76004	067	067	Corrugated Triplewall Sheet	Clear	1097	6	1830	109.00
76008	067	067	Corrugated Triplewall Sheet	Clear	1097	6	2440	145.41
76012	067	067	Corrugated Triplewall Sheet	Clear	1097	6	3050	181.74

Vistalux

Corrugated PVC

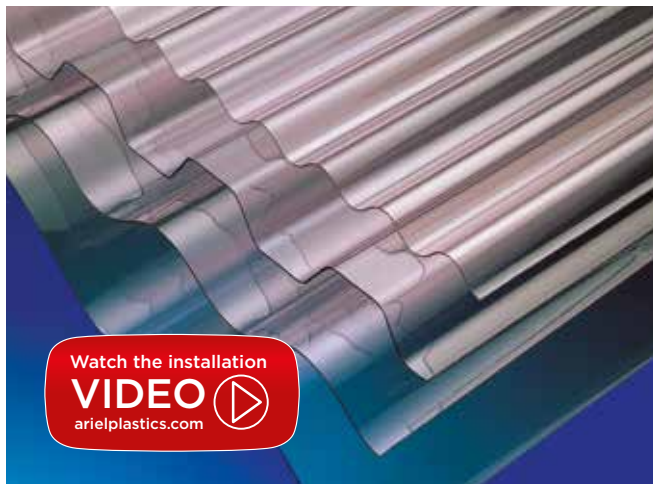

Economic, lightweight and easy to install, **Vistalux** is a versatile corrugated rooflight sheet for car ports, canopies and gazebos. It is easy to cut, drill and install with standard DIY tools and is available in a choice of corrugated profiles in clear or translucent tint options.

- Clear or translucent
- Range of profiles
- Sheet weights: Lightweight 0.8mm, Heavy Duty 1.1mm, Superweight 1.3mm
- UV resistant for durability
- Largely self-cleaning
- 10 year warranty

STORAGE ADVICE
Do not store sheets in direct sunlight as this can cause distortion.

APPLICATIONS

- > Car Ports
- > Covered Walkways
- > Porches
- > Splash Barriers
- > Cloches & Cold Frames
- > Planthouses
- > Side Cladding

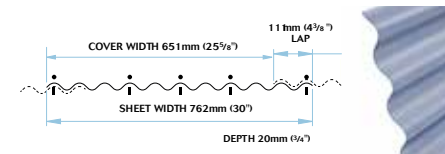

Vistalux ASB 3"

(matches Asbestos profile)

Code	PG	Disc	Product Description	Thickness mm	Colour	Width mm	Length mm/ft	Price £
18004	056	180	Lightweight Sheet	0.8	Clear	762	1830/6	20.42
18006	056	180	Lightweight Sheet	0.8	Clear	762	2135/7	23.87
18008	056	180	Lightweight Sheet	0.8	Clear	762	2440/8	27.27
18010	056	180	Lightweight Sheet	0.8	Clear	762	2745/9	30.70
18012	056	180	Lightweight Sheet	0.8	Clear	762	3050/10	34.04
19004	056	190	Heavy Duty Sheet	1.1	Clear	762	1830/6	30.99
19006	056	190	Heavy Duty Sheet	1.1	Clear	762	2135/7	36.11
19008	056	190	Heavy Duty Sheet	1.1	Clear	762	2440/8	41.26
19010	056	190	Heavy Duty Sheet	1.1	Clear	762	2745/9	46.42
19012	056	190	Heavy Duty Sheet	1.1	Clear	762	3050/10	51.57
19016	056	190	Heavy Duty Sheet	1.1	Clear	762	3660/12	61.90
20002	056	200	BS Superweight Sheet	1.3	Clear	762	1525/5	30.67
20004	056	200	BS Superweight Sheet	1.3	Clear	762	1830/6	36.74
20006	056	200	BS Superweight Sheet	1.3	Clear	762	2135/7	42.87
20008	056	200	BS Superweight Sheet	1.3	Clear	762	2440/8	49.01
20010	056	200	BS Superweight Sheet	1.3	Clear	762	2745/9	55.13
20012	056	200	BS Superweight Sheet	1.3	Clear	762	3050/10	61.29
20016	056	200	BS Superweight Sheet	1.3	Clear	762	3660/12	73.51

Vistalux ASB 3" Accessories

Code	PG	Disc	Product Description	Price £
35000	058	350	3" Super Fixings (Pack of 10)	2.95
37001	058	370	3" Wall Flashings Clear PVC 695mm	13.34
39000	058	390	3" Polyethylene Eaves Filler (Pack of 6) 680mm	8.31
ERDP	058	360	3" Adjustable Ridge Clear PVC - 685mm	31.26
36000	058	360	3" Adjustable Ridge Clear PVC - 1090mm wide*	31.26
38011	058	350	Sealing Strip 15m	10.99

*2 pieces required to make 1 metre ridge.



Fixings (35000) Eaves Filler (39000) Flashing (37001) Ridge (36000) Sealing Strip (38011)

Vistalux ASB 6"
(matches Asbestos profile)

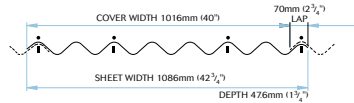

Code	PG	Disc	Product Description	Thickness mm	Colour	Width mm	Length mm/ft	Price £
22002	056	220	BS Superweight Sheet	1.3	Clear	1086	1525/5	45.86
22004	056	220	BS Superweight Sheet	1.3	Clear	1086	1830/6	57.71
22006	056	220	BS Superweight Sheet	1.3	Clear	1086	2135/7	67.52
22008	056	220	BS Superweight Sheet	1.3	Clear	1086	2440/8	76.96
22010	056	220	BS Superweight Sheet	1.3	Clear	1086	2745/9	86.73
22012	056	220	BS Superweight Sheet	1.3	Clear	1086	3050/10	96.20
22016	056	220	BS Superweight Sheet	1.3	Clear	1086	3660/12	115.54

Vistalux ASB 6" Accessories

Code	PG	Disc	Product Description	Price £
35002	058	350	6" Fixings (Pack of 10)	20.86
76853	058	390	6" Polyethylene Eaves Filler (Pack of 6) 950mm	16.91
38011	058	350	Ariel Sealing Strip per 15m	10.99

Vistalux 8/3"
(matches corrugated iron profile)

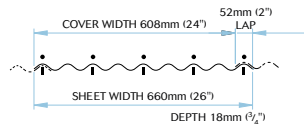

Code	PG	Disc	Product Description	Thickness mm	Colour	Width mm	Length mm/ft	Price £
21004	056	210	Heavy Duty Sheet	1.1	Clear	660	1830/6	30.99
21008	056	210	Heavy Duty Sheet	1.1	Clear	660	2440/8	41.26
21012	056	210	Heavy Duty Sheet	1.1	Clear	660	3050/10	51.57

Vistalux 8/3" Accessories

Code	PG	Disc	Product Description	Price £
35000	058	350	3" Super Fixings (Pack of 10)	2.95
38011	058	350	Sealing Strip 15m	10.99
39010	058	370	C. Iron Wall Flashing PVC (Clear) *710mm	13.32
39003	058	390	C. Iron Eaves Filler (Pack of 6, White) *810mm	13.69

*Nominal measurement.

Corolux Miniature Profile

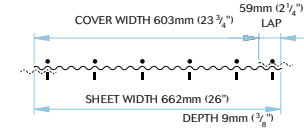

Code	PG	Disc	Product Description	Thickness mm	Colour	Width mm	Length mm/ft	Price £
11004	055	110	Lightweight Sheet	0.8	Translucent	662	1830/6	14.30
11008	055	110	Lightweight Sheet	0.8	Translucent	662	2440/8	19.05
11012	055	110	Lightweight Sheet	0.8	Translucent	662	3050/10	23.86
12004	055	120	Lightweight Sheet	0.8	Clear	662	1830/6	19.05
12008	055	120	Lightweight Sheet	0.8	Clear	662	2440/8	25.46
12012	055	120	Lightweight Sheet	0.8	Clear	662	3050/10	31.77

Corolux Miniature Profile Accessories

Code	PG	Disc	Product Description	Price £
34000	058	340	Miniature Profile Fixings (Pack of 10)	0.84
37002	058	370	Mini Wall Flashings Clear PVC 710mm	12.58
39002	058	390	Miniature Polyethylene Eaves Filler (Pack of 6) 690mm	5.66
38011	058	350	Ariel Sealing Strip per 15m	10.99

Visit the Ariel website
for the latest product information
and merchant support
arielplastics.com



Coroline

Corrugated Bituminous Roofing Sheet

Onduline®

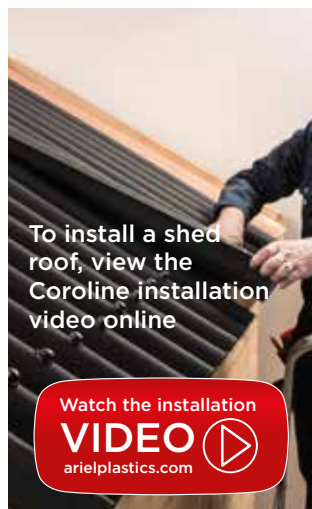

To install a shed roof, view the Coroline installation video online

Watch the installation
VIDEO
arielplastics.com

Environmentally friendly roofing options, **Coroline** and **Onduline** corrugated bitumen sheets are tough, lightweight roofing and cladding materials made from bitumen saturated organic fibres. Coroline is 2.6mm thick, Onduline is 3mm thick and Onduline Mini is 2.6mm thick.

- Economical • Resilient • Simple to fix
- Environmentally friendly
- Guaranteed waterproof for 15 years*
- High insulation & sound absorbency values
- Compatible with most commercially available construction materials

*When fitted to manufacturers instructions

APPLICATIONS

- > Garden Sheds
- > Garages
- > Stables
- > Agricultural Buildings



PROPERTIES	COROLINE	ONDULINE MINI	ONDULINE
Sheet Size	2000mm x 950mm	2000mm x 866mm	2000mm x 950mm
Cover Width	855mm	768mm	855mm
Thickness	2.6mm	2.6mm	3mm
Sheet Weight	5.6kg	5.8 kg	6.4kg
Material Weight	2.9kg/m ²	3.4kg/m ²	3.3kg/m ²
Corrugation	38mm height 95mm width	24mm height 48mm width	38mm height 95mm width

Coroline

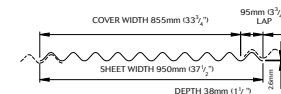

Corrugated Bitumen (Sheet thickness 2.6mm)

Code	PG	Disc	Product Description	Colour	Length mm	Price £
CBS	060	740	Coroline Sheet - 950mm width	Black	2000	19.35
CBR	060	740	Ridge - 1000mm width	Black	-	9.93
74502	060	740	Fixings - Pack of 20	Black	-	2.63
74503	060	740	Fixings - Pack of 400	Black	-	46.06
CGS	060	740	Coroline Sheet - 950mm width	Green	2000	25.10
CGR	060	740	Ridge - 1000mm width	Green	-	12.00
74522	060	740	Fixings - Pack of 20	Green	-	2.63
74523	060	740	Fixings - Pack of 400	Green	-	46.06
CRS	060	740	Coroline Sheet - 950mm width	Red	2000	25.10
CRR	060	740	Ridge - 1000mm width	Red	-	12.00
74512	060	740	Fixings - Pack of 20	Red	-	2.63
74513	060	740	Fixings - Pack of 400	Red	-	46.06
CBRS	060	740	Coroline Sheet - 950mm width	Brown	2000	25.10
CBRR	060	740	Ridge - 1000mm width	Brown	-	12.00
74512	060	740	Fixings - Pack of 20	Brown	-	2.63
74513	060	740	Fixings - Pack of 400	Brown	-	46.06
74575	060	740	Coroline Eaves Fillers - 840mm width Pack of 6	-	-	18.92
74200	060	740	PVC Sheet - 950mm width (1.2mm thick)	Translucent	2000	32.89

Coroline Ridges, Eaves Fillers and Translucent sheet can be used with Onduline - Coroline discounts will apply. Ridge cover = 875mm

Onduline®

Corrugated Bitumen (Sheet thickness 3mm)

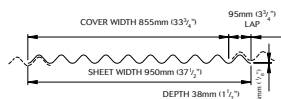

Code	PG	Disc	Product Description	Colour	Length mm	Price £
OBS	061	570	Onduline Sheet - 950mm width	Black	2000	23.67
OVB	061	570	Verge	Black	1000	13.83
OBF2	061	570	Fixings - Pack of 20	Black	-	2.45
OBF4	061	570	Fixings - Pack of 400	Black	-	41.52
OGS	061	570	Onduline Sheet - 950mm width	Green	2000	31.54
OVG	061	570	Verge	Green	1000	17.17
OGF2	061	570	Fixings - Pack of 20	Green	-	2.45
OGF4	061	570	Fixings - Pack of 400	Green	-	41.52
ORS	061	570	Onduline Sheet - 950mm width	Red	2000	31.54
OVR	061	570	Verge	Red	1000	17.17
ORF2	061	570	Fixings - Pack of 20	Red	-	2.45
ORF4	061	570	Fixings - Pack of 400	Red	-	41.52
OBRS	061	570	Onduline Sheet - 950mm width	Brown	2000	31.54
OVBR	061	570	Verge	Brown	1000	17.17
OBRF2	061	570	Fixings - Pack of 20	Brown	-	2.45
OBRF4	061	570	Fixings - Pack of 400	Brown	-	41.52

Onduline Verges can be used with Coroline - Onduline discounts will apply.

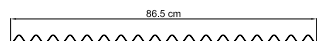

Corrugated Bitumen Mini Profile (Sheet thickness 2.6mm)

Code	PG	Disc	Product Description	Colour	Length mm	Price £
CM18B	060	740	Onduline Mini Sheet - 866mm width	Black	2000	22.23
CM18G	060	740	Onduline Mini Sheet - 866mm width	Green	2000	29.65
CMBF2	060	740	Onduline Mini Fixings - pack 20	Black	-	2.42

Corrugated Bitumen Accessories

Code	PG	Disc	Product Description	Colour	Width mm	Price £
OBA	061	570	Apron Flashing	Black	930	30.29
FT150	077	780	Ondutle Eaves Tray	-	1500	4.28
OBG	061	570	Batten Cloaking Piece	-	1220	11.07
OVS	061	570	Ventilator Strip	-	1010	10.60

• Verge cover = 875mm • Apron Flashing cover = 846mm • Eaves Tray cover = 1350mm
• Batten Cloaking Piece Cover = 1120mm

Onduline®

EASYLINE

**NEW
ROOFING
SHEET**



Onduline Easyline is designed specifically for DIY projects, such as renovations of garden sheds, leisure houses, play houses, wood shelters, carports and many other outbuildings.

APPLICATIONS

- > Garden Sheds
- > Garages
- > Stables
- > Agricultural Buildings

- Easy to carry, handle and install
- Lightweight and flexible
- Smaller sized roofing sheets
- Easy transportation - fits in most car boots
- Ideal for small roof application
- Guaranteed waterproof for 10 years



Onduline Easyline Black Intense (Sheet thickness 2.6mm)

Code	PG	Disc	Product Description	Price £
OBE	061	270	Onduline Black Easyline Intense Display Pallets incl 200 Sheets - 45 Ridges - 60 packs Fixings (Screws)	6348.50
OBES	061	270	Onduline Black Easyline Intense Sheet (1m x 760mm)	20.00
OBER	061	270	Onduline Black Easyline Intense Ridge (1000mm)	19.50
OBEF	061	270	Onduline Black Easyline Intense Fixings (Pk100)	22.85



Ideal for use on domestic buildings, garden buildings and timber frame roofing projects, **Bardoline Classic Roofing Shingle** are manufactured from high quality materials, using the latest production technology to produce an attractive, durable and weatherable roof finish.

- Durable and hardwearing
- Environmentally friendly
- Guaranteed waterproof for 10 years
- Choice of colours
- Easy fix using DIY tools

APPLICATIONS

- > Play Houses
- > Tool Sheds
- > Kennels
- > Garden Rooms
- > Summer Houses



Ideal for use on domestic buildings, garden buildings and timber frame roofing projects.

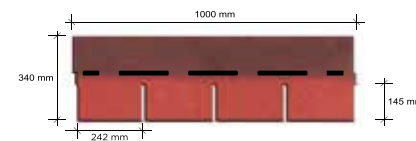

Bardoline Shingle Tile

Code	PG	Disc	Product Description	Colour	Width mm	Length mm	Price £
CGSH2	068	642	Bardoline Shingles (2m ² per pack)	Green	340	1000	48.58
CGDS225	068	642	Bardoline Detail Strip Roll	Green	300	7500	39.14
CRSH2	068	642	Bardoline Shingles (2m ² per pack)	Red	340	1000	48.58
CRDS225	068	642	Bardoline Detail Strip Roll	Red	300	7500	39.14
CSSH2	068	642	Bardoline Shingles (2m ² per pack)	Slate	340	1000	48.58
CSDS225	068	642	Bardoline Detail Strip Roll	Slate	300	7500	39.14

SLATE



RED



GREEN



Corotile

Lightweight Metal Roofing System



APPLICATIONS

- > Chalets
- > Play houses
- > Tool sheds
- > Garden offices
- > Stables
- > Garages

Corotile is an innovative lightweight metal roofing system which is easy to fit on any size of roof. Its distinct profile and charcoal finish can enhance a wide variety of small building projects, from tool sheds to garden offices.

The cover length for Corotile is 985mm and the cover width is 635mm; these are the minimum overlaps.

- Easy to install
- Strong & secure
- Lasts 20+ years
- 15 year guarantee

Metal Roofing System

Code	PG	Disc	Product Description	Colour	Width mm	Price £
CTPANEL	069	944	Corotile Panel - 1140mm length	Charcoal Grey	860mm	56.30
CTBARGE	069	944	Corotile Barge Covers - 90mm	Charcoal Grey	910mm	39.88
CTRIDGE	069	944	Corotile Ridge - 340mm	Charcoal Grey	910mm	34.94
CTCAP	069	944	Corotile End Cap	Charcoal Grey	-	17.69
CTFIX	069	944	Corotile Screws & Washers (Pk of 10)	Charcoal Grey	-	3.74

Corozinc

Galvanised Corrugated Sheet



Suitable for roofing and cladding, Ariel's galvanised corrugated roofing sheet is available in the 8/3 profile in various lengths. Cover width is 610mm.

- Extremely hardwearing
- Zinc coated on both sides
- Choice of lengths available
- Easy fix using DIY tools

APPLICATIONS

- > Out Houses
- > Tool Sheds
- > Kennels
- > Garages

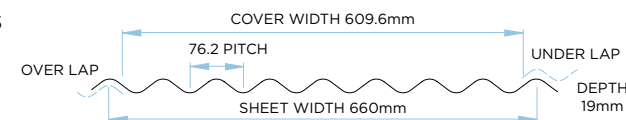

Corozinc Galvanised Sheet

Code	PG	Disc	Product Description	Width mm	Length mm	Price £
55002	073	025	Galvanised Corrugated 8/3 Roof Sheet	660	1525	35.95
55004	073	025	Galvanised Corrugated 8/3 Roof Sheet	660	1830	43.12
55006	073	025	Galvanised Corrugated 8/3 Roof Sheet	660	2135	50.33
55008	073	025	Galvanised Corrugated 8/3 Roof Sheet	660	2440	57.50
55010	073	025	Galvanised Corrugated 8/3 Roof Sheet	660	2745	64.69
55012	073	025	Galvanised Corrugated 8/3 Roof Sheet	660	3050	71.87
55016	073	025	Galvanised Corrugated 8/3 Roof Sheet	660	3660	86.25

Corozinc Galvanised Sheet Accessories

Code	PG	Disc	Product Description	Width mm	Length mm	Price £
55052	073	025	Galvanised Corrugated 8/3 Angle 105°	200	2500	60.95
55054	073	025	Galvanised Corrugated 8/3 Barge 90°	200	2500	60.95
55056	073	025	Galvanised Corrugated 8/3 Ridge 145°	200	2500	60.95
55058	073	025	Galvanised Corrugated Fixings (100pk)	-	38	45.84



NOTE

It is advisable when fitting roof sheets to ensure that they are overlapping by at least one corrugation and to work from left to right on a building when installing. This product range should be handled with care and can only be offloaded with a forklift truck.

Flat Glazing

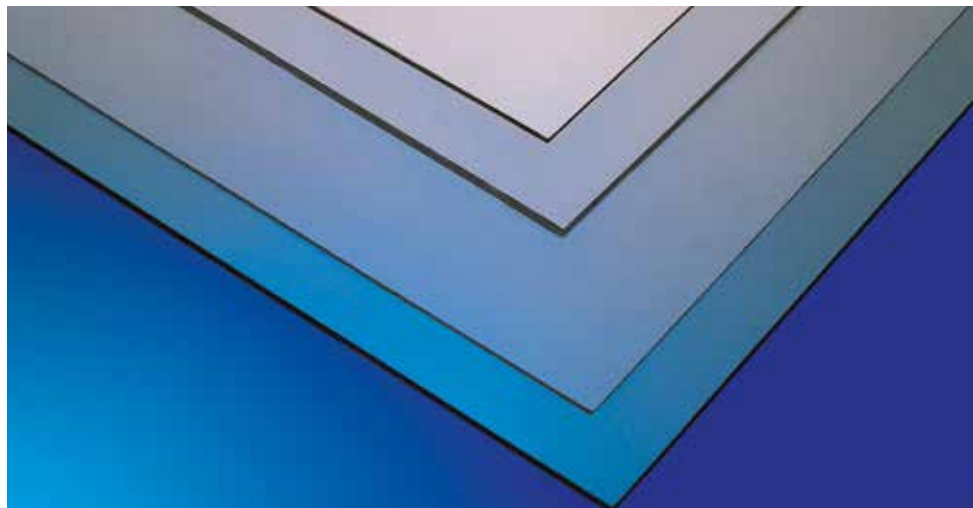

Ariel Plastics offer an extensive range of **flat glazing** options in clear acrylic sheet and polystyrene sheet for a range of applications. Acrylic sheet offers UV protection.

- Flexible
- Light in weight
- Range of sizes

PROPERTIES	LITEGLAZE	STYRENE
Impact Resistance	Good 7 times that of glass	Good 5 times that of glass
Suitable for exterior use	Yes	No
Optical Clarity	Good	Good
Light Transmission	92%	92%
Material Weight	2.38kg/m ²	2.1kg/m ²

Acrylic Sheet Exterior
Polystyrene Sheet Interior Grade

Ariel is here to help and assist with any requirements to find the right material to keep people safe.



We have a wide range of suitable products in a variety of sizes and thicknesses which can be used to create protective screens and partitions which will have an important role to play in providing a physical barrier to help maintain social distance and keep people safe.

Ariel products are ideal as they can all be easily cut, drilled and bent to suit the available space for quick installation. They are portable and come in transparent and translucent options which are easy to clean.



Applications

Protective Screens & Partitions

Uses: Retail, Manufacturing, Distribution, Public Spaces, Reception Desks, Open Plan Offices, Canteens etc.

Liteglaze

Clear Acrylic Sheet Exterior Grade

INTERIOR &
EXTERIOR USE

APPLICATIONS

- > Secondary Double Glazing
- > Replacement Windows (Planhouses & Sheds)
- > Cloches & Coldframes
- > Room Dividers
- > Display Cases & Door Panels

FEATURES

- Safer & stronger than glass
- Easily transportable
- Light in weight
- UV resistant
- Flexible
- Suitable for interior & exterior use

Acrylic Sheet Range

UV Protected both sides. Suitable for interior and exterior use.

Code	PG	Disc	Product Description	Thickness mm	Width mm	Length mm	Price £
66000	064	660	Acrylic Sheet	2	600	1200	40.25
66002	064	660	Acrylic Sheet	2	600	1800	60.41
66001	064	660	Acrylic Sheet	2	1200	1200	80.51
66003	064	660	Acrylic Sheet	2	1200	1800	120.79
66004	064	660	Acrylic Sheet	2	1200	2400	161.05
66025	064	660	Acrylic Sheet	4	600	1200	80.51
66032	064	660	Acrylic Sheet	4	600	1800	121.45
66021	064	660	Acrylic Sheet	4	1200	1200	161.05
66019	064	660	Acrylic Sheet	4	1200	1800	241.52
66031	064	660	Acrylic Sheet	4	1200	2400	322.05
66040	064	660	Acrylic Sheet	6	600	1200	104.53
66043	064	660	Acrylic Sheet	6	900	1200	156.79
66046	064	660	Acrylic Sheet	6	600	1800	172.46

Acrylic Sheet Accessories

Code	PG	Disc	Product Description	Colour	Depth mm	Length mm	Price £
76711	064	660	Liteglaze Glazing Strip	White	10	1830	10.26

Styrene

Clear Polystyrene Sheet

INTERIOR
USE ONLY

APPLICATIONS

- > Splashbacks & Wallpaper Protection
- > Display Cases & Cupboard Fronts
- > Room Dividers
- > Interior Door Panels
- > Lightweight Shelving
- > Picture Framing

FEATURES

- Safer & stronger than glass
- Easily transportable
- Light in weight
- Economical
- Suitable for interior use only

Clear Polystyrene Sheet Standard Range - Only suitable for interior use.

Code	PG	Disc	Product Description	Thickness mm	Width mm	Length mm	Price £
64120	065	645	Polystyrene Sheet	2	600	1200	27.86
64122	065	645	Polystyrene Sheet	2	600	1800	41.74
64121	065	645	Polystyrene Sheet	2	900	1200	41.74
64124	065	645	Polystyrene Sheet	2	1200	1200	55.68
64125	065	645	Polystyrene Sheet	2	1200	1800	83.49
64126	065	645	Polystyrene Sheet	2	1200	2400	111.33
64130	065	645	Polystyrene Sheet	4	600	1200	52.41
64133	065	645	Polystyrene Sheet	4	600	1800	78.58
64131	065	645	Polystyrene Sheet	4	900	1200	78.58
64132	065	645	Polystyrene Sheet	4	1200	1200	104.76
64134	065	645	Polystyrene Sheet	4	1200	1800	157.15
64136	065	645	Polystyrene Sheet	4	1200	2400	209.53

Brett Martin Flat Glass Mardome

STOCK RANGE OF HIGH QUALITY ROOFLIGHTS

Our 48 hour Hi-Lights service delivers a selection of high quality rooflight options in 12 key sizes which satisfy the requirements of most projects and will be delivered from stock within 48 hours* of placing the order.

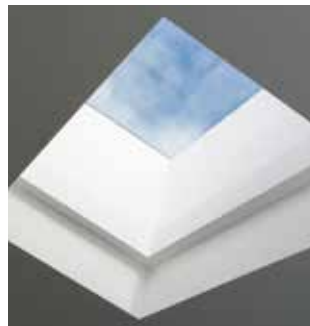

APPLICATIONS

Designed for the flat and low pitch roofs of new builds and extensions, our rooflight range can transform open plan living areas, kitchens, bathrooms, hallways and a range of commercial spaces by creating wonderfully light, bright and airy rooms where windows simply are not possible.



*terms and conditions apply



Combining sleek styling with quality engineering, Ariel's range delivers the most inspiring rooflight solutions.



Mardome
Polycarbonate Rooflight



Brett Martin
Flat Glass Rooflight



Unbeatable Service

Simply place your order with Ariel Plastics by 12.30pm and items in the Hi-lights service range will be delivered to site within 48 hours. This stock service is available for the rooflights listed on pages 56-62 in this product price guide. Other sizes are available on a made to order leadtime.



High Quality Products

Energy Efficient

The performance of the complete range has been developed to deliver an exceptionally energy efficient rooflight choice. Flat glass and triple glazed polycarbonate options meet the requirements of Part L of the Building Regulations.

polycarbonate and glass glazing options combine to deliver a highly secure rooflight.

Quality Guaranteed

Our rooflights come with a 10 year product warranty for complete peace of mind.



High Security

Tamper proof security fixings and impact resistant

Mardome

POLYCARBONATE DOME ROOFLIGHT RANGE



- Thermally efficient single, double, triple glazed options with U values as low as 0.96 W/m²K
- Sloped multiwall PVC kerb with 150mm waterproofing termination height as standard
- Direct fix kerb to fit to existing builders upstand
- Up to 27% more daylight area than other rooflights
- 10 year warranty

Polycarbonate Glazing

Ultra clear and resilient polycarbonate with added Longlife UV protection for long term performance.

- Single Glazed
- Double Glazed
- Triple Glazed



Security Fixings

Secure fixings with tamper proof caps for added security.

PVC Kerb

Thermally efficient robust PVC kerb. Direct fix glazing unit also available.

Prefinished Lightwell

For clean lines and pristine internal finish.

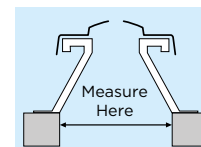

Mardome with Kerb

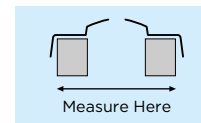

For builders upstand

Dome & Kerb Sizes

When the Mardome is to be supplied with a kerb, measure overall dimensions of the opening (length x width). When the Mardome is to suit a builders upstand, measure the external dimensions of the upstand (length x width).

Standard roof opening sizes are detailed in this brochure. All domes in the range can also be specified to be fixed directly to an existing builders upstand, where necessary being supplied with a 'direct fix' adaptor.

Thermal Performance

To achieve varying degrees of insulation Mardome are available in single, double and triple skin polycarbonate glazed units. Options to further improve thermal efficiency include glass inner glazing. An average U-value for the rooflight area of 2.2 W/m²K is required to satisfy Part L Building Regulations 2013. To assist compliance with Part L, Ariel Plastics recommend installing no less than triple skin glazed rooflights.

Thermal Efficiency

Material	U-value*
Double Skin Polycarbonate	2.7 W/m ² K
Triple Skin Polycarbonate	1.8 W/m ² K

*Centre pane U-value is a measure of the thermal efficiency of the glazing type.

Glazing

All rooflights are glazed with an outer skin of impact resistant Marlon FSX Longlife UV protected polycarbonate. This outer skin glazing is available in a dome or pyramid shape. Select from clear, textured, opal and bronze tints.

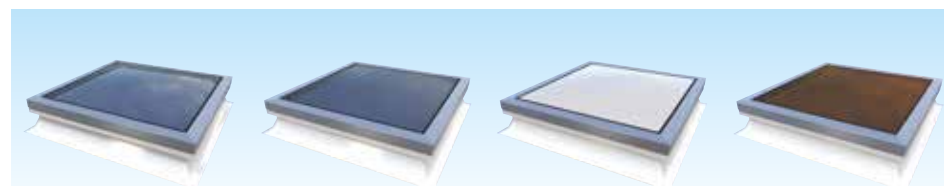

Clear	Textured	Opal	Bronze
Maximum light transmission and clarity	Combines privacy with high levels of light transmission	Maximised privacy Soft diffused light transmission with reduced solar heat gain	Reduces solar glare and heat gain with a lower light transmission

Mardome

POLYCARBONATE DOME ROOFLIGHT RANGE



Double Glazed with PVC kerb providing 150mm waterproofing termination height

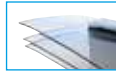

		Rooflight Size = finished roof opening size					
		600 x 600mm	600 x 900mm	750 x 750mm	900 x 900mm	1050 x 1050mm	1200 x 1200mm
Double Glazed with PVC Kerb	Code	M001	M002	M003	M004	M005	M006
	Price £	250.00	319.00	310.00	358.00	419.00	523.00
Double Glazed Opening with PVC Kerb	Code	M007	M008	M009	M010	M011	M012
	Price £	396.00	499.00	476.00	545.00	613.00	739.00

Part L Compliant Triple Glazed with PVC kerb providing 150mm waterproofing termination height

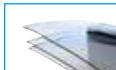

		Rooflight Size = finished roof opening size					
		600 x 600mm	600 x 900mm	750 x 750mm	900 x 900mm	1050 x 1050mm	1200 x 1200mm
Triple Glazed Mardome with PVC Kerb	Code	M013	M014	M015	M016	M017	M018
	Price £	325.00	412.00	404.00	463.00	541.00	684.00
Triple Glazed Opening Mardome with PVC Kerb	Code	M019	M020	M021	M022	M023	M024
	Price £	471.00	592.00	570.00	649.00	735.00	900.00

Mardome

POLYCARBONATE DOME ROOFLIGHT RANGE



Direct Fix without Kerb

		Rooflight Size = external upstand distance					
		600 x 600mm	600 x 900mm	750 x 750mm	900 x 900mm	1050 x 1050mm	1200 x 1200mm
Direct Fix Single Glazed	Code	M025	M026	M027	M028	M029	M030
	Price £	125.00	153.00	155.00	175.00	210.00	265.00
Direct Fix Double Glazed	Code	M031	M032	M033	M034	M035	M036
	Price £	165.00	205.00	207.00	232.00	279.00	368.00
Direct Fix Triple Glazed	Code	M037	M038	M039	M040	M041	M042
	Price £	240.00	299.00	301.00	337.00	401.00	529.00



Mardome Reflex

Mardome Reflex is a glazing only unit designed specifically for refurbishment projects where the glazing only needs to be replaced and can be easily fixed to existing kerbs or upstands. The unit is supplied with a fixing kit including weathertight washers and cover plugs.

Reflex Range

Size mm	Glazing Skin		
	x3	x2	x1
450 x 450	218	165	125
600 x 600	218	165	125
600 x 900	273	205	153
600 x 1200	363	268	201
750 x 750	273	207	155
750 x 900	297	224	168
900 x 900	305	232	175
900 x 1200	499	367	265
1050 x 1050	367	279	210
1200 x 1200	501	368	265
1200 x 1800	798	561	365
1200 x 2400	1,153	794	475
1350 x 1350	678	499	350

Mardome Trade

Mardome Trade is the base rooflight, offering a competitively priced dome unit with a host of additional extras to satisfy a range of project requirements and budgets.



Mardome Trade Range - Non-opening

Size mm	With PVC Kerb			To Fit Builders Upstand					
	Glazing Skin			Unvented			Vented		
	x3	x2	x1	x3	x2	x1	x3	x2	x1
600 x 600	325	250	211	240	165	125	327	252	213
600 x 900	412	319	266	299	205	153	410	317	264
600 x 1200	516	398	332	385	268	201	510	393	326
750 x 750	404	310	259	301	207	155	402	308	257
750 x 900	447	343	288	327	224	168	444	340	284
900 x 900	463	358	302	337	232	175	458	353	296
900 x 1200	667	509	408	524	367	265	659	502	400
1050 x 1050	541	419	350	401	279	210	533	411	341
1200 x 1200	684	523	421	529	368	265	672	511	409
1200 x 1800	1,014	745	549	830	561	365	997	728	532
Options									
Manual Vent	32	32	32	-	-	-	Vent included		

Mardome Trade



Mardome Trade Range - Opening Options

Additional Extras

Size mm	Manual Opening with PVC Kerb		Manual Opening to Fit Builders Upstand		Powered Opening	Powered Opening with Remote & Rain Sensor	Access Hatch
	Glazing Skin		Glazing Skin				
	x3	x2	x3	x2			
600 x 600	471	396	441	366	143	519*	-
600 x 900	592	499	557	464	170	546*	-
600 x 1200	837	719	799	682	169	545*	-
750 x 750	570	476	536	442	155	531*	-
750 x 900	630	526	595	491	170	546*	72
900 x 900	649	545	612	507	170	546*	72
900 x 1200	868	710	828	671	170	546*	72
1050 x 1050	735	613	694	572	170	546*	72
1200 x 1200	900	739	856	696	170	546*	72
1200 x 1800	1,410	1,141	1,361	1,091	383	759*	-

*Not available for 48 hour delivery.

ROOFLIGHT ACCESSORIES

Security Grille

Range of sizes available POA.



Opening Poles

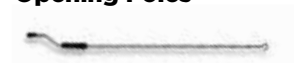

Code	Description	Price £
M100	2m Opening Pole	30.00
M101	3m Opening Pole	42.00

Brett Martin Flat Glass



FLAT GLASS ROOFLIGHT RANGE

Flat Glass is the latest addition to our range of modular rooflights manufactured in the UK. This elegant glass rooflight provides quality features at highly competitive prices, delivered in as little as 48 hours from order. Manufactured with a laminated inner pane for safe and stylish daylighting to all types of buildings.

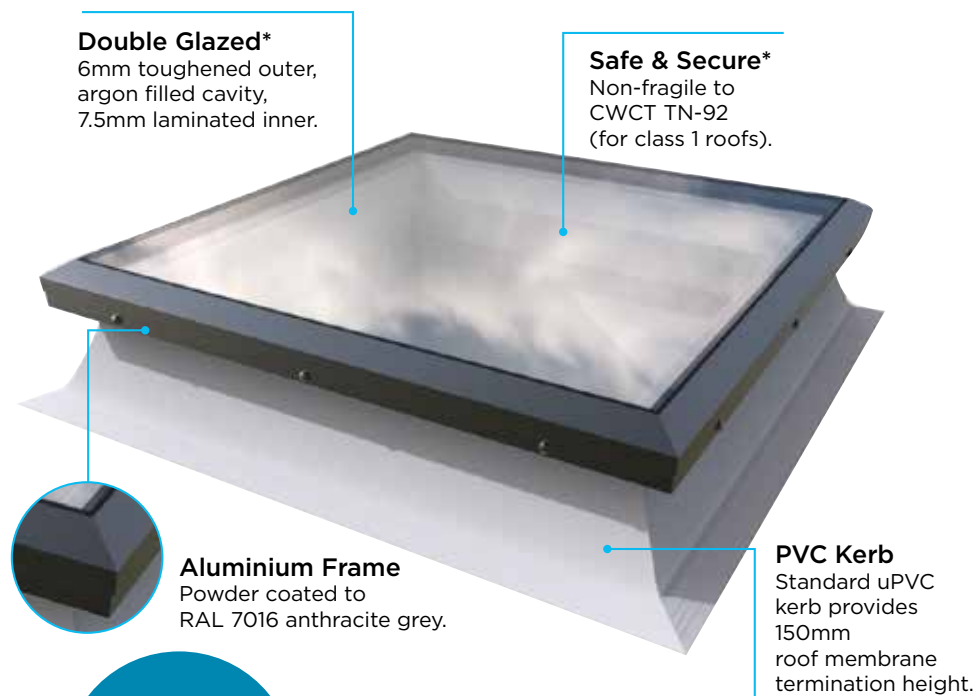

PLEASE NOTE
A manual handling guide for Flat Glass rooflights is available from the Ariel website.

**This applies to our 10 standard Flat Glass sizes, our non-standard sizes remain with a 9.5mm laminated inner pane and are non-fragile to CWCT TN-92 for class 2 roofs. We retain the right to supply our standard sizes with a 9.5mm laminated inner pane.*



- BENEFITS**
- > Suitable for flat and low pitched roofs of 2° - 15°.
 - > Flexibility with a choice of opening, ventilation, kerb and fixing options.
 - > Glass specification* is non fragile to CWCT TN-92 for class 1 roofs.
 - > Highly secure non-opening units have **Secured by Design** accreditation.
 - > Components of powered opening rooflights are completely concealed for an unobstructed light well.



Additional size, ventilation and opening options available. Price on request.



Brett Martin Flat Glass

FLAT GLASS ROOFLIGHT RANGE

Flat Glass on Builders Upstand
(Unvented, non-opening)



Rooflight Size = external upstand distance									
Size	600 x 600mm	750 x 750mm	900 x 600mm	900 x 900mm	1000 x 1000mm	1200 x 600mm	1200 x 900mm	1200 x 1200mm	1500 x 1000mm
Code	MGT001	MGT002	MGT003	MGT004	MGT005	MGT006	MGT007	MGT008	MGT009
Price £	424.00	483.00	493.00	586.00	637.00	562.00	717.00	814.00	847.00

Flat Glass on 150mm PVC Kerb
(Unvented, non-opening)

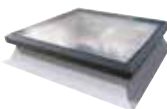

Rooflight Size = finished roof opening size									
Size	600 x 600mm	750 x 750mm	900 x 600mm	900 x 900mm	1000 x 1000mm	1200 x 600mm	1200 x 900mm	1200 x 1200mm	1500 x 1000mm
Code	MGT010	MGT011	MGT012	MGT013	MGT014	MGT015	MGT016	MGT017	MGT018
Price £	537.00	611.00	622.00	731.00	791.00	705.00	876.00	988.00	1026.00

Flat Glass on Builders Upstand including Trickle Vent
(Vented, non-opening)



Rooflight Size = external upstand distance									
Size	600 x 600mm	750 x 750mm	900 x 600mm	900 x 900mm	1000 x 1000mm	1200 x 600mm	1200 x 900mm	1200 x 1200mm	1500 x 1000mm
Code	MGTV001	MGTV002	MGTV003	MGTV004	MGTV005	MGTV006	MGTV007	MGTV008	MGTV009
Price £	545.00	614.00	625.00	731.00	788.00	703.00	872.00	979.00	1017.00

Flat Glass on 150mm PVC Kerb including Trickle Vent
(Vented, non-opening)

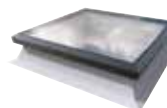

Rooflight Size = finished roof opening size									
Size	600 x 600mm	750 x 750mm	900 x 600mm	900 x 900mm	1000 x 1000mm	1200 x 600mm	1200 x 900mm	1200 x 1200mm	1500 x 1000mm
Code	MGTV010	MGTV011	MGTV012	MGTV013	MGTV014	MGTV015	MGTV016	MGTV017	MGTV018
Price £	569.00	643.00	654.00	763.00	823.00	737.00	908.00	1020.00	1058.00

Brett Martin Flat Glass

MADE TO ORDER RANGE

Extended lead times apply.
Not available for 48 hour delivery



Flat Glass on Builders Upstand with Manual Opening
(Unvented, opening)

Rooflight Size = external upstand distance								
Size	600 x 600mm	750 x 750mm	900 x 600mm	900 x 900mm	1000 x 1000mm	1200 x 600mm	1200 x 900mm	1200 x 1200mm
Code	MGT019	MGT020	MGT021	MGT022	MGT023	MGT024	MGT025	MGT026
Price £	570.00	639.00	643.00	746.00	803.00	733.00	900.00	1004.00

Flat Glass on 150mm PVC Kerb with Manual Opening
(Unvented, opening)

Rooflight Size = finished roof opening size								
Size	600 x 600mm	750 x 750mm	900 x 600mm	900 x 900mm	1000 x 1000mm	1200 x 600mm	1200 x 900mm	1200 x 1200mm
Code	MGT027	MGT028	MGT029	MGT030	MGT031	MGT032	MGT033	MGT034
Price £	595.00	668.00	672.00	778.00	838.00	767.00	936.00	1044.00

Flat Glass on Builders Upstand with Manual Opening including Trickle Vent
(Vented, opening)

Rooflight Size = external upstand distance								
Size	600 x 600mm	750 x 750mm	900 x 600mm	900 x 900mm	1000 x 1000mm	1200 x 600mm	1200 x 900mm	1200 x 1200mm
Code	MGTV019	MGTV020	MGTV021	MGTV022	MGTV023	MGTV024	MGTV025	MGTV026
Price £	602.00	671.00	675.00	778.00	835.00	765.00	932.00	1036.00

Flat Glass on 150mm PVC Kerb with Manual Opening including Trickle Vent
(Vented, opening)

Rooflight Size = finished roof opening size								
Size	600 x 600mm	750 x 750mm	900 x 600mm	900 x 900mm	1000 x 1000mm	1200 x 600mm	1200 x 900mm	1200 x 1200mm
Code	MGTV027	MGTV028	MGTV029	MGTV030	MGTV031	MGTV032	MGTV033	MGTV034
Price £	627.00	700.00	704.00	810.00	870.00	799.00	968.00	1076.00

Brett Martin Flat Glass

MADE TO ORDER RANGE

Extended lead times apply.
Not available for 48 hour delivery



Flat Glass on Builders Upstand with Powered Opening
(Unvented, opening)

Rooflight Size = external upstand distance								
Size	600 x 600mm	750 x 750mm	900 x 600mm	900 x 900mm	1200 x 600mm	1200 x 900mm	1200 x 1200mm	1500 x 1000mm
Code	MGT035	MGT036	MGT037	MGT038	MGT040	MGT041	MGT042	MGT043
Price £	773.00	840.00	843.00	947.00	933.00	1480.00	1585.00	1624.00

Flat Glass on 150mm PVC Kerb with Powered Opening
(Unvented, opening)

Rooflight Size = finished roof opening size								
Size	600 x 600mm	750 x 750mm	900 x 600mm	900 x 900mm	1200 x 600mm	1200 x 900mm	1200 x 1200mm	1500 x 1000mm
Code	MGT044	MGT045	MGT046	MGT047	MGT049	MGT050	MGT051	MGT052
Price £	797.00	869.00	872.00	979.00	967.00	1516.00	1625.00	1666.00

Flat Glass on Builders Upstand with Powered Opening including Trickle Vent
(Vented, opening)

Rooflight Size = external upstand distance								
Size	600 x 600mm	750 x 750mm	900 x 600mm	900 x 900mm	1200 x 600mm	1200 x 900mm	1200 x 1200mm	1500 x 1000mm
Code	MGTV035	MGTV036	MGTV037	MGTV038	MGTV040	MGTV041	MGTV042	MGTV043
Price £	805.00	872.00	875.00	979.00	965.00	1512.00	1617.00	1656.00

Flat Glass on 150mm PVC Kerb with Powered Opening including Trickle Vent
(Vented, opening)

Rooflight Size = finished roof opening size								
Size	600 x 600mm	750 x 750mm	900 x 600mm	900 x 900mm	1200 x 600mm	1200 x 900mm	1200 x 1200mm	1500 x 1000mm
Code	MGTV044	MGTV045	MGTV046	MGTV047	MGTV049	MGTV050	MGTV051	MGTV052
Price £	829.00	901.00	904.00	1011.00	999.00	1548.00	1657.00	1698.00

Covershield
Protective Sheet

For the temporary protection of surfaces during construction, building and refurbishment work.

Covershield Protective Sheet is a lightweight and extremely strong polypropylene material for the protection of surfaces, fixtures and fittings during construction, building and refurbishment work.

Tough and durable, Covershield is tear, puncture and impact-resistant. At only 2mm in thickness Covershield is also very easy to cut, curve, crease and tape into place to fit a variety of different surfaces. It is this versatility and ease of use which makes Covershield an effective alternative to plywood or other timber products for the temporary protection of stairs, columns, walls, floors, doors and windows.

Covershield is available in both white fire retardant and black recycled options for residential and commercial building use.



- Effective protection for floors, doors, walls, and windows
- Lightweight, strong, waterproof, non-toxic and resistant to chemicals
- Easy to cut, crease and bend
- Available in standard and flame retardant sheets

APPLICATIONS

- > Stairs
- > Columns
- > Walls
- > Floors
- > Doors
- > Windows

Protective Sheet

Code	PG	Disc	Product Description	Colour	Size (mm)	Thickness (mm)	Price £
SHIELDFR	040	040	Covershield Flame Retardant Flat Protective Sheet	White	1200 x 2400	2mm	12.10
SHIELDSTD	040	040	Covershield Standard Flat Protective Sheet	Black	1200 x 2400	2mm	10.84

Leave the cutting to our trained experts

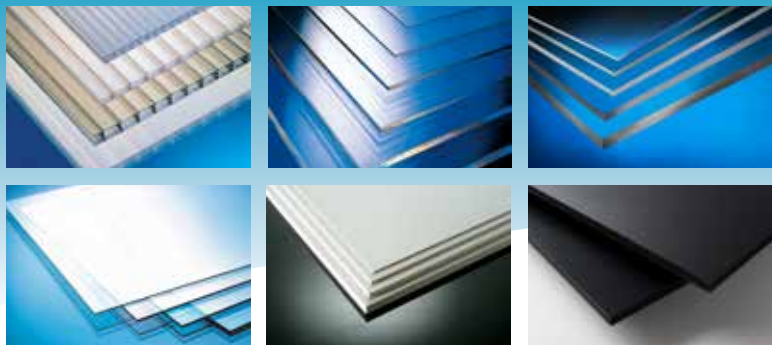

Ariel provides a quick and easy **Cut to Size Service** for Polycarbonate, PETg, Foam PVC, Acrylic and Styrene sheet delivered within 48 hours nationwide.

Terms & Conditions

Delivery 48hr -
Cut off time on day of order 3pm.
Delivery charges.
1: Yard (invoice address) Free.
2: Site £20.00.
Mainland GB only -
excluding Postcode areas
beginning KW,IV,AB & PH.

Cut To Size Sheet is a bespoke product and non returnable



A full range of **Styrene Sheet** is available on request

Precision edge cutting

ariel

Cut to Size Service

Order Cut to Size Plastic from Ariel in 3 simple steps:



Step 1

Choose your material and size



Step 2

Complete your order form - which can be downloaded from our website



Step 3

We deliver it within 48hrs



Multiwall Polycarbonate

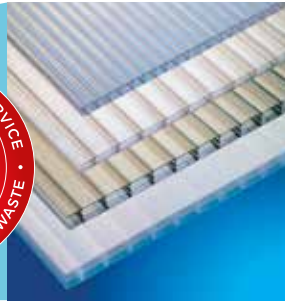

Multiwall polycarbonate is a lightweight, impact resistant glazing and roofing sheet that is very easy to handle and install. It has a protective UV layer which safeguards against the effects of weathering for a longer lasting sheet. A full range of installation accessories are also available.

At a glance:

- A range of thicknesses and tints
- Very strong and durable
- Impact resistant
- UV protected
- Class 1 fire rating

Use for:

- Lean to
- Patio Covers
- Car Ports
- Greenhouses
- Cold Frames



Cut to Size Prices

Code	PG	Disc	Product Description	Thickness mm	Colour	Sqm Price £	Max. Dimensions mm
BMR10C	050	952	Multiwall Polycarbonate	10	Clear	32.76	4000 x 2100
BMR10B	050	952	Multiwall Polycarbonate	10	Bronze	32.76	4000 x 2100
BMR10O	050	952	Multiwall Polycarbonate	10	Opal	32.76	4000 x 2100
BMR16C	050	953	Multiwall Polycarbonate	16	Clear	52.12	4000 x 2100
BMR16B	050	953	Multiwall Polycarbonate	16	Bronze	52.12	4000 x 2100
BMR16O	050	953	Multiwall Polycarbonate	16	Opal	52.12	4000 x 2100
BMR25C	050	954	Multiwall Polycarbonate	25	Clear	65.52	4000 x 2100
BMR25B	050	954	Multiwall Polycarbonate	25	Bronze	65.52	4000 x 2100
BMR25O	050	954	Multiwall Polycarbonate	25	Opal	65.52	4000 x 2100
BMR25BO	050	954	Multiwall Polycarbonate	25	Bronze Opal	75.49	4000 x 2100
BMR25HO	050	954	Multiwall Polycarbonate	25	Heatguard Opal	75.49	4000 x 2100
BMR35C7	050	955	Multiwall Polycarbonate	35	Clear	75.23	4000 x 2100
BMR35B7	050	955	Multiwall Polycarbonate	35	Bronze	75.23	4000 x 2100
BMR35O7	050	955	Multiwall Polycarbonate	35	Opal	75.23	4000 x 2100
BMR35BO7	050	955	Multiwall Polycarbonate	35	Bronze Opal	86.60	4000 x 2100
BMR35HO7	050	955	Multiwall Polycarbonate	35	Heatguard Opal	86.60	4000 x 2100



10mm Clear



10mm Bronze

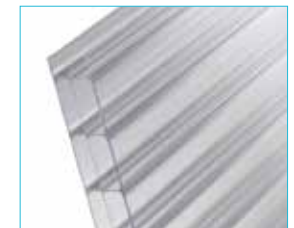

16mm Clear



16mm Opal



25mm Bronze Opal



25mm Heatguard Opal

Self Supporting Roof (suitable for 16, 25 & 35mm sheet)

Code	PG	Disc	Product Description	Colour	Price £
BMSSGP2	050	951	Self supporting goal posts (2)	White	381.41
BMSSBI25	050	951	2.5m Intermediate bar	White	171.51
BMSSBI30	050	951	3.0m Intermediate bar	White	205.72
BMSSBI35	050	951	3.5m Intermediate bar	White	239.37
BMSSBI40	050	951	4.0m Intermediate bar	White	274.30
BMSSBE25	050	951	2.5m End bar	White	171.48
BMSSBE30	050	951	3.0m End bar	White	205.72
BMSSBE35	050	951	3.5m End bar	White	240.05
BMSSBE40	050	951	4.0m End bar	White	274.30
BMSSEC	050	951	Bar end caps	White	21.19
BMSSBW30	050	951	3.0m Wall plate	White	317.78
BMSSBW40	050	951	4.0m Wall plate	White	423.70
BMSSBW50	050	951	5.0m Wall plate	White	529.62
BMSSEB3	050	951	3.0m standard eaves beam	White	304.39
BMSSEB4	050	951	4.0m standard eaves beam	White	337.73
BMSSEBC	050	951	Eaves beam connector	White	16.72

Polycarbonate Accessories (suitable for 10, 16 & 25mm sheet)

Code	PG	Disc	Product Description	Colour	Length mm	Unit Price £
BMBHPO	050	950	Glazing bar cap and base with end cap	White	3000	81.51
BMBHPR	050	950	Glazing bar cap and base with end cap	White	4000	107.92
BMBHOR	050	950	Glazing bar cap and base with end cap	White	6000	£160.97
BMBJOP	050	950	Glazing bar cap and base with end cap	Brown	3000	84.65
BMBYTO	050	950	Glazing bar cap and base with end cap	Brown	4000	112.22
BMBGTY	050	950	Glazing bar cap and base with end cap	Brown	6000	166.92
BMBEFT	050	950	Glazing bar end cap	White	-	3.28
BMBUZZT	050	950	Glazing bar end cap	Brown	-	4.93

Tapes

Code	PG	Disc	Product Description	Price £
BM76585	050	950	Flashing tape 225mm x 10m Grey	81.66
BMBT16/10	050	950	10/16mm Breather tape 38mm x 10m	35.34
BMBT25/10	050	950	Breather tape 45mm x 10m	41.34

Side Flashing

Code	PG	Disc	Product Description	Width	Colour	Length mm	Price £
BM76112	050	950	10mm Side Flashing	10mm	White	3000	20.10
BM76113	050	950	10mm Side Flashing	10mm	White	4000	26.77
BM76346	050	950	10mm Side Flashing	10mm	White	6000	40.18
BM76342	050	950	10mm Side Flashing	10mm	Brown	3000	25.16
BM76343	050	950	10mm Side Flashing	10mm	Brown	4000	33.45
BM76466	050	950	10mm Side Flashing	10mm	Brown	6000	50.22
BM76114	050	950	16mm Side Flashing	16mm	White	3000	20.10
BM76115	050	950	16mm Side Flashing	16mm	White	4000	26.77
BM76341	050	950	16mm Side Flashing	16mm	White	6000	40.18
BM76463	050	950	16mm Side Flashing	16mm	Brown	3000	25.16
BM76464	050	950	16mm Side Flashing	16mm	Brown	4000	33.45
BM76465	050	950	16mm Side Flashing	16mm	Brown	6000	50.22
BMBCOS	050	950	25mm Side Flashing	25mm	White	3000	30.73
BMBMOJ	050	950	25mm Side Flashing	25mm	White	4000	40.76
BMBGVV	050	950	25mm Side Flashing	25mm	White	6000	60.84
BMBYKZ	050	950	25mm Side Flashing	25mm	Brown	3000	33.45
BMBHSS	050	950	25mm Side Flashing	25mm	Brown	4000	44.68
BMBPWP	050	950	25mm Side Flashing	25mm	Brown	6000	66.77

End Caps & Fixing Buttons

Code	PG	Disc	Product Description	Price £
BMSEC10W	050	950	10mm end closure white 2.1 linear metre	4.55
BMSEC10B	050	950	10mm end closure brown 2.1 linear metre	5.77
BMS16W	050	950	16mm end closure white 2.1 linear metre	4.55
BMS16B	050	950	16mm end closure brown 2.1 linear metre	5.77
BMB25W	050	950	25mm end closure white 3.5 linear metre	6.39
BMB25B	050	950	25mm end closure brown 3.5 linear metre	7.04
BMB35W	050	950	35mm end closure white 3.5 linear metre	8.96
BMB35B	050	950	35mm end closure brown 3.5 linear metre	9.88
BM76567	050	950	10mm super fixing buttons white - Pack of 10	22.39
BM76569	050	950	10mm super fixing buttons brown - Pack of 10	22.39
BM76568	050	950	16mm super fixing buttons white - Pack of 10	22.39
BM76570	050	950	16mm super fixing buttons brown - Pack of 10	22.39
BMBVUT	050	950	25mm super fixing buttons white - Pack of 10	23.20
BMBHUP	050	950	25mm super fixing buttons brown - Pack of 10	23.20

Flat Polycarbonate

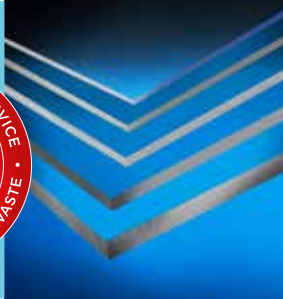

Polycarbonate is the perfect substitute for glass. It is a very light weight yet at 200 times stronger than glass it is an exceptionally strong, impact resistant glazing material. With a double sided UV protection to both sides of the sheet it is the ideal material for exterior glazing. The protective UV layer provides a longer sheet life expectancy, prevents yellowing and guards against loss of strength.

At a glance:

- Virtually unbreakable
- Very lightweight
- UV Resistant
- Class 1 fire rating

Use for:

- Canopies
- Patio Covers
- Walkways
- Greenhouses
- Glazing



Cut to Size Prices

Code	PG	Disc	Product Description	Thickness mm	Colour	Sqm Price £	Max. Dimensions mm
F2C	043	401	Solid Polycarbonate	2	Clear	26.81	3050 x 2050
F3C	043	401	Solid Polycarbonate	3	Clear	40.22	3050 x 2050
F4C	043	401	Solid Polycarbonate	4	Clear	53.62	3050 x 2050
F5C	043	401	Solid Polycarbonate	5	Clear	67.02	3050 x 2050
F6C	043	401	Solid Polycarbonate	6	Clear	80.44	3050 x 2050
F8C	043	401	Solid Polycarbonate	8	Clear	107.26	3050 x 2050
F10C	043	401	Solid Polycarbonate	10	Clear	134.06	3050 x 2050
F12C	043	401	Solid Polycarbonate	12	Clear	160.87	3050 x 2050
F3O	043	401	Solid Polycarbonate	3	Opal	42.30	3050 x 2050
F5O	043	401	Solid Polycarbonate	5	Opal	70.51	3050 x 2050

Full Sheet Prices

Code	PG	Disc	Product Description	Thickness mm	Colour	Price £	Sheet Size mm
79500	043	405	Solid Polycarbonate	2	Clear	167.63	3050 x 2050
79501	043	405	Solid Polycarbonate	3	Clear	251.46	3050 x 2050
79502	043	405	Solid Polycarbonate	4	Clear	335.28	3050 x 2050
79503	043	405	Solid Polycarbonate	5	Clear	419.11	3050 x 2050
79504	043	405	Solid Polycarbonate	6	Clear	502.92	3050 x 2050
79505	043	405	Solid Polycarbonate	8	Clear	670.57	3050 x 2050
79506	043	405	Solid Polycarbonate	10	Clear	838.21	3050 x 2050
79507	043	405	Solid Polycarbonate	12	Clear	1,005.85	3050 x 2050
79600	043	405	Solid Polycarbonate	3	Clear	119.73	2440 x 1220
79601	043	405	Solid Polycarbonate	4	Clear	159.63	2440 x 1220
79602	043	405	Solid Polycarbonate	6	Clear	239.45	2440 x 1220
79508	043	405	Solid Polycarbonate	3	Opal	264.50	3050 x 2050
79509	043	405	Solid Polycarbonate	5	Opal	440.84	3050 x 2050

Solid PETg Sheet



PETg is the ideal printing and thermoforming material. It is suitable for both screen and digital printing making it an ideal product for signage, point of sale displays, light boxes and graphic arts. It can also be easily heat bent and formed into complex shapes for fabricated items.

At a glance:

Optically clear
Printable
Thermoformable
Easy to fabricate

Use for:

Signs
Posters
POS Displays
Light Boxes



Cut to Size Prices

Code	PG	Disc	Product Description	Thickness mm	Colour	Sqm Price £	Max. Dimensions mm
P2C	043	402	Solid PETg Sheet	2	Clear	23.10	3050 x 2050
P3C	043	402	Solid PETg Sheet	3	Clear	34.65	3050 x 2050
P4C	043	402	Solid PETg Sheet	4	Clear	46.20	3050 x 2050
P5C	043	402	Solid PETg Sheet	5	Clear	57.73	3050 x 2050
P6C	043	402	Solid PETg Sheet	6	Clear	69.29	3050 x 2050

Full Sheet Prices

Code	PG	Disc	Product Description	Thickness mm	Colour	Price £	Sheet Size mm
79700	043	406	Solid PETg Sheet	2	Clear	144.40	3050 x 2050
79701	043	406	Solid PETg Sheet	3	Clear	216.60	3050 x 2050
79702	043	406	Solid PETg Sheet	4	Clear	288.81	3050 x 2050
79703	043	406	Solid PETg Sheet	5	Clear	361.01	3050 x 2050
79704	043	406	Solid PETg Sheet	6	Clear	433.20	3050 x 2050

Acrylic Sheet

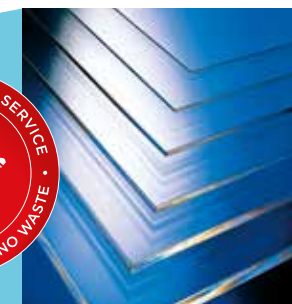

With a superior gloss finish and scratch resistance, Acrylic is a preferred material for projects which require its high end appeal and durability. It can also be flame polished for a clear, shiny edge finish which replicates glass. Excellent weatherability means Acrylic is an excellent glazing material whilst ease of workability makes it suitable for fabrication.

At a glance:

High gloss surface
Optically clear sheet
Half the weight of glass
Scratch resistant
Weatherable

Use for:

POS Displays
Poster Covers
Picture Framing
Splashbacks
Glazing



Cut to Size Prices

Code	PG	Disc	Product Description	Thickness mm	Colour	Sqm Price £	Max. Dimensions mm
A2C	043	403	Solid Acrylic Sheet	2	Clear	21.64	3050 x 2050
A3C	043	403	Solid Acrylic Sheet	3	Clear	32.46	3050 x 2050
A4C	043	403	Solid Acrylic Sheet	4	Clear	43.29	3050 x 2050
A5C	043	403	Solid Acrylic Sheet	5	Clear	54.10	3050 x 2050
A6C	043	403	Solid Acrylic Sheet	6	Clear	64.91	3050 x 2050

Full Sheet Prices

Code	PG	Disc	Product Description	Thickness mm	Colour	Price £	Sheet Size mm
79800	043	407	Solid Acrylic Sheet	2	Clear	135.30	3050 x 2050
79801	043	407	Solid Acrylic Sheet	3	Clear	202.94	3050 x 2050
79802	043	407	Solid Acrylic Sheet	4	Clear	270.60	3050 x 2050
79803	043	407	Solid Acrylic Sheet	5	Clear	338.25	3050 x 2050
79804	043	407	Solid Acrylic Sheet	6	Clear	405.90	3050 x 2050

Foam PVC Sheet

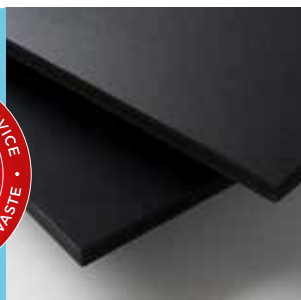

Foam PVC is a versatile multi-purpose board. Its foamed structure makes it extremely lightweight yet exceptionally stiff and rigid. It also has a smooth satin surface finish which is highly resilient to knocks and scratches. It is really easy to work with and can be printed, cut, routed, bonded, painted and decorated, and can also be heat bent to shape.



At a glance:

- Lightweight
- Smooth satin surface
- Printable
- Workable

Use for:

- Signage
- Point of sale
- Model making
- Crafts and hobbies



Cut to Size Prices

Code	PG	Disc	Product Description	Thickness mm	Tint	Sqm Price £	Max. Dimensions mm
E3W	043	404	Foam PVC Sheet	3	White	16.00	2440 x 1220
E5W	043	404	Foam PVC Sheet	5	White	25.51	2440 x 1220
E10W	043	404	Foam PVC Sheet	10	White	50.03	2440 x 1220
E3B	043	404	Foam PVC Sheet	3	Black	18.67	2440 x 1220
E5B	043	404	Foam PVC Sheet	5	Black	31.25	2440 x 1220
E10B	043	404	Foam PVC Sheet	10	Black	62.70	2440 x 1220



H-Section Bar



J-Section Trim



Internal Corner



External Corner



H-Section Bar Top



H-Section Bar Base

Foam PVC Solid Sheet



This economical range of PVC cladding sheet is suitable for wall and ceiling cladding. The premium surface in matt, gloss or satin finish provides a super tough, clinically clean finish.



At a glance:

- White matt, gloss or satin surface finish
- Lightweight & easy to install
- Hardwearing & easy to clean
- Excellent fire performance

Use for:

- Out houses
- Garages
- Screens & partitions
- Changing rooms
- Animal housing



PVC Cladding Full Sheet Prices

Code	PG	Disc	Product Description	Thickness mm	Price £	Sheet Size mm
67008	066	933	Standard Matt Cladding (PVC Foam)	3	58.32	2440 x 1220
68008	066	933	Premium Gloss Cladding (PVC Foam)	3	121.55	2440 x 1220
69008	066	933	Premium Satin Cladding (Solid PVC)	2.5	135.54	2440 x 1220

PVC Cladding Accessories

Code	PG	Disc	Product Description	Colour	Length mm	Price £
76130	066	933	H-Section Division Bar	White	3000	17.78
76131	066	933	J-Section Starter Trim	White	3000	12.10
76132	066	933	Internal Corner	White	3000	11.74
76133	066	933	External Corner	White	3000	13.99
76134	066	933	H-Section Division Bar Top	White	3000	10.60
76135	066	933	H-Section Division Bar Base	White	3000	12.88
76136	066	933	Fix All High Tack 290ml	-	-	22.55

Slight colour variation between cladding sheet and accessories is to be expected.

Delivery Schedule (England & Wales)

Order cut-off time Zone	Mon 3.30pm	Tue 3.30pm	Wed 3.30pm	Thur 3.30pm	Fri 3.30pm
A	Fri	Tue	Tue	Thur	Thur
Lead time	4	5	4	5	4
B	Fri	Fri	Tue	Wed	Thur
Lead time	4	3	4	4	4
C	Fri	Tue	Tue	Wed	Thur
Lead time	4	5	4	4	4
D	Tue	Tue	Tue	Thur	Fri
Lead time	5/6	5	4	5	5
E	Fri	Fri	Tue	Thur	Thur
Lead time	4	3	4	5	4
F	Fri	Tue	Tue	Fri	Fri
Lead time	4	5	4	5/6	5
G	Fri	Tue	Tue	Fri	Fri
Lead time	4	5	4	5/6	5
H	Fri	Tue	Tue	Wed	Thur
Lead time	4	5	4	4	4
J	Fri	Tue	Tue	Thur	Thur
Lead time	4	5	4	5	4
K	Fri	Tue	Tue	Fri	Fri
Lead time	4	5	4	5/6	5
L	Fri	Tue	Tue	Fri	Fri
Lead time	4	5	4	5/6	5
M	Fri	Tue	Tue	Wed	Fri
Lead time	4	5	4	4	5
N	Fri	Tue	Tue	Wed	Fri
Lead time	4	5	4	4	5
O	Fri	Fri	Tue	Wed	Thur
Lead time	4	3	4	4	4
P	Fri	Fri	Tue	Thur	Thur
Lead time	4	3	4	5	4

Delivery Schedule (Scotland)

Order cut-off time Zone	Mon 3.30pm	Tue 3.30pm	Wed 3.30pm	Thur 3.30pm	Fri 3.30pm
Borders	Thur	Thur	Tue	Tue	Tue
Lead time	3	2	4	3	3
Central	Fri	Fri	Fri	Wed	Wed
Lead time	4	3	2	4	4
Dumfries	Thur	Thur	Tue	Tue	Tue
Lead time	3	2	4	3	3
Fife	Fri	Fri	Fri	Tue	Tue
Lead time	4	3	2	3	3
Grampian	Wed	Wed	Wed	Wed	Wed
Lead time	6/7	5/6	4/5	4	8
Highland	Wed	Wed	Wed	Wed	Wed
Lead time	6/7	5/6	4/5	4	8
Lothian	Fri	Fri	Fri	Wed	Wed
Lead time	4	3	2	4	4
Strathclyde	Fri	Fri	Fri	Wed	Wed
Lead time	4	3	2	4	4
Tayside	Fri	Fri	Fri	Tue	Tue
Lead time	4	3	2	3	3

Notes

- Refer to GB Postcodes Zone Table for zone location.
- Delivery days shown will, where appropriate, always be the second of any two day run.
- Please utilise this delivery schedule to organise your most beneficial ordering pattern.
- Delivery schedules should be used as a guide, actual delivery day may be rescheduled at short notice due to reasons beyond our control.

 Denotes following week

 Denotes 8 working day delivery

GB Postcode Delivery Zones

Postcode Prefix	Zone	Postcode Prefix	Zone	Postcode Prefix	Zone
AL1 - 10	O	HP1-27	O	SP1 - 10	M
B1 - 98	C	HR1 - 9	F	SR1 - 8	D
B74,75,77,78,79	B	HU1-20	H	SS0 - 17	P
BA1 - 22	L	HX1-7 B	B	ST1-18	B
BB1 - 18	E	IG1-11	P	ST19-21	F
BD1 - 22	B	IM1-9*	E	SW1,3,5-7,10	M
BD23 - 24	H	IP1-12	P	SW2,4,8,9,11-20	N
BH1 - 25	M	IP13-33	P	SY1 - 25	F
BLO - 9	B	JE1-4*	M	TA1-7,9-24	L
BNI-3,5-7,9-18	N	KT1-24	N	TA8	C
BN 8,20-27	J	L1-70	E	TF1 - 13	F
BN41-45	N	LA1-6,10	E	TN1 - 40	J
BRI-8	J	LA7-9,11-23	K	TQ1 - 14	L
BS1 - 49	C	LD1 - 8	F	TR1 - 27	L
CA1-7,10-15,18-28	K	LE1-7,11-15,16,65,67	B	TS1 - 29	D
CA8,9,16,17	D	LE8-10,17-19	C	TW1 - 20	M
CB1,5,8-10,22	P	LL11-78	G	UB1 - 11	O
CB2,3,11	O	LN1-5,7-13	B	W1-14	M
CB4,6,7,21,23-25	A	LS1-13,15,18-20,26-28	B	WB-D,F-K,M,S-U,W	O
CF10 - 83	F	LS14,16,17,21-25,29	H	WA1-14,16	E
CH1-6,9-66	E	LU1-7	O	WA15	B
CH7,8	G	M1-24,31-37,40,43,50,60,90	B	WC1	O
CM0-15,17, 25-77	P	M25-30,38,41,44-46	E	WD1	O
CM16,18,20-24	O	ME1-20	J	WF1	B
CO1-16	P	MK1-46	O	WN1	E
CRO-9	J	NI - 22	O	WR1-6,8,9,13-15	F
CT1-21	J	NE1 - 71	D	WR7,10-12	C
CV1 - 47	C	NG1 - 34	B	WS1,2,5,10	C
CV9,13	B	NN1 - 29	C	WS3,4,6-9,11-15	B
CW1-10	L	NP7 - 44	F	WV1-4,11-13 C	O
CW4,11,12	B	NR1 - 35	A	WV5-10,14-16 F	F
DA1-18	J	NW1 - 11	O	YO1 - 62 H	H
DE175	B	OL1 - 16	B		
DH1-9	D	OX1-4,9,33,39,44,49	O		
DL1,2,5,12-17	D	OX5,7,15-20, 25-29	C		
DL6-11	H	OX10-14	M		
DNI-12,14,17,21,22	B	PE1 - 38	A		
DN15,16,18-20,23,41	A	PL1 - 35	L		
DT1-5,10,11	M	PO1-12,17-22	N		
DT6-9	L	PO30-41*	N		
DY1 - 10	C	PR1 - 26	E		
DY11 - 14	F	RG1 - 45	M		
E1-19	P	RH1 - 20	N		
E20	O	RM1 - 20	P		
EC1	O	S1 - 81	B		
EC2-4	P	SA1 - 73	F		
EN1-10	P	SE1 - 28	J		
EX1-39	L	SG1 - 19	O		
FY1-8	E	SK1 - 23	B		
GL1 - 56	C	SLO - 9	M		
GL14 - 19	F	SM1 - 7	N		
GU1-47	N	SN1,11,25,26	M		
GY1-9*	M	SN12,13	L		
HAO-9	O	SN14-16	C		
HDI-9	B	SO14 - 53	M		
HG1-5	H				

Scotland

Postcode Prefix	Zone
AB10-56	Grampian
DG1-16	Dumfries
DD1-11	Tayside
EH1-2, 4, 6-29, 31-42, 47-48, 50, 52-55	Lothian
EH3,5,30,49,51	Central
EH43-46	Borders
FK1-21	Central
TD1-15	Borders
G1-84	Strathclyde
IV1-63	Highlands
KA1-30	Strathclyde
KY1-16	Fife
KW1-17	Highlands
ZE1-3	Highlands
ML1-12	Strathclyde
HS1-9	Highlands
PA1-78	Strathclyde
PH1-50	Perthshire

*Off Shore destinations - delivery to agreed mainland port.

Visit the all new Ariel website

For the latest product information
and merchant support

www.arielplastics.com

Speedwell Industrial Estate
Staveley
Derbyshire
S43 3JP

Tel: 01246 281111
Fax: 01246 561111
Email: info@arielplastics.com

Blairlinn Road
Cumbernauld
Glasgow
G67 2TF

Tel: 01236 725536
Fax: 01236 725871
Email: scotland@arielplastics.com



Q09125

Orderline email:
sales@arielplastics.com

Ariel Plastics Customer Services:
APCustomerservices@arielplastics.com



All reasonable care has been taken in the compilation of the information contained within this price list. Ariel Plastics reserves the right to amend specifications and prices without prior notice.

All recommendations on the use of our products are made without guarantee as conditions of use are beyond the control of Ariel Plastics. It is the customer's responsibility to ensure that the product is fit for its intended purpose and that the actual conditions of use are suitable.

A large red circle contains the text 'Call us: 01246 281111' at the top. Below this, it says 'Press #1 for Sales' and 'Press #2 for our Cut to Size Ninja Experts'. To the left of the text is a white cartoon character of a Ninja Expert, wearing a white gi and a red headband with a white mask, holding a red tool.