

MVFAC-3000 User Manual



Virginia Controls, LLC
2513 Mechanicsville Turnpike
Richmond, Virginia 23223

Tel: (804) 225-5530
Fax: (804) 225-0116

email: eng@vacontrols.com
website: www.vacontrols.com

Revision 2.22 (11-15-2021)

Table of Contents

1.	TABLE OF FIGURES	7
2.	PRE-INSTALLATION INSTRUCTIONS AND NOTES.....	8
2.1	General Notes	8
2.2	Important Precautions and Notes	8
3.	CONTROLLER INSTALLATION AND WIRING.....	10
3.1	Controller Installation	10
3.1.1	Controller Location Selection and Environment.....	10
3.1.2	Controller Grounding.....	11
3.2	Car and Hoistway Wiring	11
3.2.1	Floor Switches.....	11
3.2.2	Car Top Selector.....	12
3.2.3	Leveling Switches.....	12
3.2.4	Terminal Landing Normal Slowdown Switches.....	12
3.2.5	Terminal Landing Normal Limit Switches	12
3.2.6	Terminal Landing Final Limit Switches.....	13
3.2.7	Emergency Terminal Landing Limit Switch	13
3.2.8	Hoistway Access Zone Switches.....	13
3.2.9	Door Open and Close Limit Switches	13
3.3	Machine Room Wiring	13
3.3.1	Incoming Power	14
3.3.2	Grounding	14
3.3.3	Motor Wiring	14
4.	START-UP INSTRUCTIONS	15
4.1	Before Applying Power	15
4.1.1	Power and Grounding.....	15
4.1.2	Input/Output Wiring.....	15
4.2	Applying Power	16
4.3	Temporary Run Connections	16
5.	FINAL ADJUSTMENTS	17

5.1	Inspection Operation	17
5.2	Floor Position and Slowdown	18
5.3	Position Indicators	18
5.4	Independent Service	18
5.5	Car and Hall Calls.....	19
5.6	Door Operation	19
5.7	Fire Service.....	20
5.8	Failure Timers.....	20
5.8.1	Stuck Button Timer	20
5.8.2	Running Timer.....	20
5.8.3	Start / Stop Sequence Timer	20
5.8.4	Leveling Timer.....	21
5.8.5	Redundancy Faults.....	21
5.8.6	Door Fault Timers	21
5.8.7	Door Check Fault or Door Lock Monitoring.....	22
5.8.8	Door Zone Faults.....	22
5.8.9	Resetting Shutdown Faults	22
5.9	Field Adjustable Features.....	23
5.10	Zoned Duplex Operation	23
5.10.1	Common Circuits.....	23
5.10.2	Next Car	23
5.10.3	Car Start	24
5.10.4	Homing.....	24
5.10.5	Communication.....	25
5.11	ETSD Monitoring System Setup.....	26
5.11.1	Setup of the UCM (Unintended Car Movement) System	27
5.11.2	Setup of the O-S (Over Speed) System	30
5.11.3	Setup of the ETSD (Emergency Terminal Stopping Device) System	37
5.12	A-B Micro PLC Setup	40
5.12.1	SPECIAL ADJUSTMENTS with ETSD/UCM BOARD, HSC.....	40
5.12.2	SPECIAL FAULTS for ETSD/UCM BOARD, HIGH SPEED COUNTER	40
5.12.3	ADJUST MODE.....	41
5.12.4	ALLEN-BRADLEY MICRO830 HSC SETUP.	42
5.12.5	CALIBRATE THE HIGH SPEED COUNTER.	42
5.12.6	TROUBLESHOOTING.....	43
5.12.7	ALLEN-BRADLEY PLC OUTPUTS and INPUTS	43
5.12.8	SPEED CODES	43

6.	CONTROLLER HARDWARE DESCRIPTION	44
6.1	Transformers.....	44
6.2	Fuses	45
6.3	12VDC Power Supply	45
6.4	Safety Interface.....	46
6.4.1	Bypass Switches.....	46
6.4.2	Inspection Switches	46
6.4.3	Phase Monitor	46
6.4.4	Digiset Timer	47
6.5	Microprocessor	48
6.5.1	CPU.....	48
6.5.2	Input/Output Boards	56
6.5.3	I/O Board Connectors	59
6.6	ETSD Monitoring System	62
6.6.1	Unintended Car Movement (UCM) System.....	63
6.6.2	Over-Speed System (O-S) System	66
6.6.3	Emergency Terminal Slowdown Device (ETSD) System.....	69
6.6.4	ETSD Monitoring System Routine Maintenance.....	72
6.6.5	ETSD Board Specifications	76
6.6.6	Speed (Photo) Sensor & Cable Specifications.....	78
7.	MVFAC-3000 SCREENS AND DIAGNOSTICS	79
7.1	Run Mode.....	79
7.1.1	Run Mode Screens.....	79
7.1.2	Show I/O Status	81
7.1.3	Show Fault Log.....	81
7.1.4	Show Internal Memory.....	97
7.1.5	Show Car Status	99
7.1.6	Go To Set-Up Mode	103
7.1.7	Effect of Diagnostic Modes on Scan Time	103
7.2	Set-Up Mode.....	104
7.2.1	How to Enter Set-Up Mode	104
7.2.2	How to Exit Set-Up Mode	104
7.2.3	Set-Up Mode Screens	104
7.2.4	Reset Settings	105
7.2.5	Change Settings	106
7.2.6	Change Features	118
7.2.7	Show Fault Log.....	120
7.2.8	Show Internal Memory.....	120

7.2.9	Set the Time	121
7.2.10	Enter Password	121
7.2.11	Test I/O Boards	122
8.	CONTROLLER NOMENCLATURE.....	124
9.	PARTS LIST	125
10.	TROUBLESHOOTING SUGGESTIONS	127
10.1	Locating Faults	127
10.1.1	Resetting Faults.....	128
10.1.2	Troubleshooting I/O Board Communication Problems	128
10.2	I/O Board Replacement	129
10.3	Factory Assistance	129
10.4	Changes for Program Revisions	130
10.4.1	Program Revision 3B.....	130
10.4.2	Program Revision 3C.....	130
11.	CONTROLLER MAINTENANCE.....	131
11.1	Periodic Maintenance.....	131
11.2	Parts Replacement.....	131
11.2.1	CPU Exchange	131
11.2.2	EPROM Memory Chip Exchange	132
11.2.3	Input/Output Board Exchange.....	133
12.	FREQUENTLY ASKED QUESTIONS	134
12.1	Questions on Field Devices.....	134
12.2	Questions on Field Devices.....	134
12.3	Questions on the Controller	135
13.	DRIVE SPECIAL INSTRUCTIONS	137
13.1	Over Speed Test.....	137

14. ETSD MONITORING SYSTEM TESTING138

14.1 UCM System Testing..... 138

 14.1.1 Equipped for Rope Brake Operation (Static Test)..... 138

 14.1.2 Equipped for Em. Brake Operation (Dynamic Test)..... 138

14.2 O-S System Testing 139

14.3 ETSD System Testing..... 139

1. Table of Figures

- Figure 1: ETSD Monitoring System Hardware..... 26
- Figure 2: UCM SELECT Jumper 27**
- Figure 3: "OSC" and "ETSC" Calibration Switches (in RUN position) 27
- Figure 4: SHTDFT and ETSDFT Inputs 28
- Figure 5: ETSDFT & SHTDFT Input Indicators..... 28**
- Figure 6: EX1, EX2, ET1, ET2, RBP1 & RBP2 Output Indicators 29**
- Figure 7: ETSD Tape..... 30**
- Figure 8: Speed Sensor & Mounting Bracket..... 30**
- Figure 9: "PHOTO" Connector on ETSD Board..... 31**
- Figure 10: Installed ETSD Tape & Speed Sensor 32**
- Figure 11: Sensor Green POWER LED Indicator..... 33**
- Figure 12: Sensor Yellow SENS. LED Indicator 33**
- Figure 13: PHOTO-1 Indicator 33**
- Figure 14: PHOTO-0 Indicator 34**
- Figure 15: Sensor L/D Switch & SENS. Potentiometer 34**
- Figure 16: Output Indicators 35**
- Figure 17: O-S TUNED Indicator 35**
- Figure 18: State LEDs and DIP Switches..... 36**
- Figure 19: Output Indicators 38**
- Figure 20: ETS TUNED Indicator 38**
- Figure 21: State LEDs and DIP Switches..... 39**
- Figure 22 - ETSD Monitoring System 62
- Figure 23 - UCM TRIP Indicator..... 64
- Figure 24 - O-S TRIP Indicator 67**
- Figure 25 - O-S RESET Push Button 67**
- Figure 26 - ETS TRIP Indicator 70**
- Figure 27 - ETS RESET Push Button 71**
- Figure 28 - ETSD Tape 72
- Figure 29 - Speed Sensor..... 73
- Figure 30 - +24V & +3.3V LED Indicator Test Points and Supply Terminals..... 73
- Figure 31 - Sensor POWER LED Indicator..... 74**

Figure 32 - Sensor SENS. LED Indicator	74
Figure 33 - PHOTO-1 Indicator	75
Figure 34 - ETSD Board	77
Figure 35 - Speed (Photo) Sensor & Cable	78

2. Pre-Installation Instructions and Notes

2.1 General Notes

It is strongly recommend that you read this manual carefully before proceeding with the installation.

Important information is highlighted by the headings WARNING, CAUTION, or NOTE. These words are defined as follows:

WARNING - Warnings are used to indicate instructions which, if not followed correctly, will probably result in personal injury or substantial damage to equipment.

CAUTION - Cautions are used to indicate instructions or information which, if not observed, may result in some damage to equipment if care is not taken.

NOTE - Notes are used to indicate instructions or information which is especially helpful in understanding and operating the equipment, and which will usually speed up the installation process.

2.2 Important Precautions and Notes

The following general rules and safety precautions must be observed for safe and reliable operation of your system.

WARNING: If you need to change the EPROM program chip on the CPU board, make sure you read the instructions and know exactly how to install the new chip. Plugging the EPROM chip in upside-down may damage the chip. Static electricity can damage the EPROM, so avoid touching the pins on the chip, and ground yourself (by touching the controller cabinet) before touching the chip or the controller. Do not expose the EPROM program chip to bright light, and do not remove the label over the EPROM program chip window.

WARNING: The elevator controller must be installed by experienced field installation personnel. The field installation personnel must know and follow all the rules and regulations pertaining to the safe installation and running of elevators. Additional information for specific devices (such as the valves, door operator, etc.) is the responsibility of the manufacturers of those devices.

WARNING: This equipment is designed and built to comply with ANSI A17.1, ASME A17.5 and CAN/CSA B44.1 and must be installed by a qualified contractor. It is the responsibility of the contractor to make sure that the final installation complies with all applicable local, state and national codes, and is installed safely.

WARNING: The 3 phase AC power supply to this equipment must come from a fused disconnect switch or circuit breaker which is sized in accordance with all applicable national, state and local electrical codes, in order to provide the necessary overload protection for the controller and motor. Incorrect motor branch circuit protection may create a hazardous condition.

WARNING: Proper grounding is vital for the safe operation of your system. Bring the ground wire to the ground stud that is labeled "GND" or "G". You must choose the proper conductor size. See national electrical code article 250-95, or the related local applicable code.



Pay special attention to points highlighted in this manner. They are of special consideration and are frequently overlooked.

3. Controller Installation and Wiring

3.1 Controller Installation

3.1.1 Controller Location Selection and Environment

Mount the controller in a location that provides:

- adequate support for the weight of the controller,
- adequate lighting for installation and maintenance,
- convenient access for the routing of required conduits and cables,
- convenient access to other devices in the machine room,
- a minimum of vibration (supply additional bracing or reinforcement if required).

For improved controller reliability:

- Keep the machine room clean.
- Do not install the controller in a dusty area.
- Do not install the controller in a carpeted area, or area where static electricity is a problem.
- Keep room temperature between 0°C to 40°C (0°F to 104°F), and 95% non-condensing relative humidity. Extended high temperatures will shorten the life of electronic components. Provide adequate ventilation or air-conditioning as required if necessary.
- Avoid condensation on the equipment. Keep the controller away from sources of condensation and water (such as open windows) as these can create a hazardous condition and can damage the equipment.
- Do not install the controller in a hazardous location and where excessive amounts of vapors or chemical fumes may be present. A NEMA 4 or NEMA 12 rated enclosure can be provided if necessary.
- Make sure power line fluctuations are within the drive ratings.
- High levels of radio frequency emissions may cause interference with the controller and drive micro-processors, and produce unexpected and even dangerous results. This could be caused by hand-held communications devices used near the controller.
- Long term operation of the controller without the door or cover in place is not recommended.

3.1.2 Controller Grounding

3.1.2.1 Grounding of the controller must conform to all applicable codes. Proper grounding is essential to the safe operation of the equipment. It will also reduce the likelihood of noise-induced problems, which could include CPU crashes, or I/O communication errors.

- The grounding wire should be sized per the applicable codes.
- Connect the ground to a good building ground, such as the structural steel of the building, or a cold water pipe.

3.2 Car and Hoistway Wiring

Review the schematics and field wiring diagrams before attempting to hook up the controller.

3.2.1 Floor Switches

The Floor Switches, if used, are normally open contacts that should close under each of the following conditions:

1. the car is at the slowdown point above the floor, OR
2. the car is at the slowdown point below the floor, OR
3. the car is at the floor (optional), OR
4. the car is between the up and down slowdown points of that landing (optional).

Conditions (1) and (2) are required to change the floor relays and initiate slowdown. Condition (3) is required at the terminal landings, but is optional at the intermediate landings. Condition (4) is optional.

There are many acceptable methods of providing the floor switch signals, such as by having a single Floor Switch at floor level, and an adjustable length cam on the car, or by having two Floor Switches per floor, and a fixed length cam on the car. The Floor Switches may be mounted on the car if they are in separate rows. It is recommended that the method used allow for separate adjustment of the up and down slowdown distances.

NOTE: Recommended slowdown distance is about 6" for every 25fpm of car speed, for speeds of up to 200fpm. Minimum recommended target length for the floor switches is 1".

If there are short floors, refer to the schematic for special instructions, if required.

NOTE: The terminal landing Floor Switches must be maintained while the car is within door zone of the terminal landing.

3.2.2 Car Top Selector

The pulsing-type Car Top Selector provides Floor Change/Slowdown signals and Leveling signals, as shown on the car top selector sheet in the schematic. The signals should be a normally open contact that closes as described below.

1. UP SLOWDOWN closes at the Slowdown distance below the floor.
2. DOWN SLOWDOWN closes at the Slowdown distance above the floor.
3. UP and DOWN LEVEL, and DOOR ZONE/LOW LEVEL. (See "Leveling Sws")

NOTE: Recommended slowdown distance is about 6" for every 25fpm of car speed, for speeds of up to 200fpm. Minimum recommended target length for the floor switches is 1".

 An extra reset target is required at each terminal landing, as shown on the schematic, so that the Up Slowdown Switch is closed when the car is in the leveling zone at the top landing, and the Down Slowdown Switch is closed when the car is in the leveling zone at the bottom landing. These targets are used to reset the floor position at the terminal landings.

3.2.3 Leveling Switches

The Up Level Switch is a normally open contact that closes when the car is in the leveling zone below the floor, and the Down Level Switch is a normally open contact that closes when the car is in the leveling zone above the floor. Adjust the distance between the Up Level Switch and the Down Level Switch to be equal to the length of the leveling vane/target plus the desired Dead Zone distance (usually 1/4" to 1/2"). The actual length of the leveling target is not critical (except in some short floor situations) and is usually 6-10". Position the leveling vane/target so that when the car is floor level the Up and Down Leveling Switches are centered around the vane/target, and both switches are open.

The Door Zone Switch is a switch (or switches) activated by the leveling vane/target when the car is within 3" of floor level. If the leveling vane/target is 6" long, then only one switch is required, mounted between the Up and Down Leveling Switches, otherwise two switches wired in series should be provided.

3.2.4 Terminal Landing Normal Slowdown Switches

The Terminal Landing Normal Slowdown Limit Switch is a normally closed contact that opens when the car is closer to a terminal landing than the minimum slowdown distance. It will prevent the car from running into the terminal landing at full speed. It should be adjusted to open approximately one inch beyond the point where the normal slowdown (from the floor switches or the car top selector) is initiated.

3.2.5 Terminal Landing Normal Limit Switches

 The Terminal Landing Normal Limit Switch (sometimes called a Directional Limit Switch) is a normally closed contact that opens when the car has traveled 1" past floor level at a terminal landing. The car should not be on the Terminal Landing Normal Limit Switch when the car is floor level at the terminal landing. The Limit Switch will prevent the car from traveling further away from the normal area of car travel, but allows the car to run back towards the normal area of car travel.

3.2.6 Terminal Landing Final Limit Switches

The Terminal Landing Final Limit Switch, where required by code, is a normally closed contact that opens when the car has gone a considerable distance beyond floor level at a terminal landing. It will prevent any further movement of the car in either direction. Consult the applicable codes for the proper setting of this switch.

3.2.7 Emergency Terminal Landing Limit Switch

The Emergency Terminal Landing Slowdown Switch should be installed as required by the applicable codes. It is a normally closed contact that opens after the car has gone beyond the Terminal Landing Normal Limit Switch.

3.2.8 Hoistway Access Zone Switches

The Hoistway Access Limit Switches limit the motion of the car on Hoistway Access, by disabling the car if it moves away from the access floor. Install the zone switches to stop the car from running down if the top of the car goes below floor level at the top access floor, and to stop the car from running up if the car goes above the second floor while on Hoistway Access at the bottom floor.

3.2.9 Door Open and Close Limit Switches

The Door Open Limit Switch is open when the doors are fully open, and closed at all other times. It will de-energize the door open relays in the door operator when the doors have opened fully.

The Door Close limit Switch is open when the doors are fully closed, and closed at all other times. It will de-energize the door close relays in the door operator when the doors have closed fully.



NOTE: Many problems in operation can be attributed to failures in the Door Open or Close Limit Switches (including long door times, improper door operation on Fire Service, inability to go on to or to clear Fire Service, etc.) Always check the Door Open and Close Limit Switches if unusual operation of the elevator is observed.

NOTE: It is recommended that the Door Close Limit Switch be adjusted so that, as the doors are closing, the Car Door Contact closes before the Door Close Limit opens. Consult the Door Operator Manufacturer's installation instructions for further details on the adjustment of the doors.

NOTE: 2000 (or later) code compliant controllers will not run without the Door Close Limit operation properly.

NOTE: If a solid state door operator unit is being used, check the appropriate schematics to see if any changes are required on the actual operator. These may include changing resistors in the operator, and adding a diode for proper open and close torque.

3.3 Machine Room Wiring

Mount the controller firmly and install all required conduits before wiring the controller. Note where duct has been provided in the controller for customer access, before deciding where to locate conduit openings.

WARNING: Do not allow any metal shavings to get into relays or contactors, or in or behind the electronic components, as these could cause serious damage to personnel or the equipment.

3.3.1 Incoming Power

WARNING: THE 3 PHASE AC POWER SUPPLY TO THIS EQUIPMENT MUST COME FROM A FUSED DISCONNECT SWITCH OR CIRCUIT BREAKER WHICH IS SIZED IN ACCORDANCE WITH ALL APPLICABLE NATIONAL, STATE AND LOCAL ELECTRICAL CODES, IN ORDER TO PROVIDE THE NECESSARY OVERLOAD PROTECTION FOR THE CONTROLLER AND MOTOR. INCORRECT MOTOR BRANCH CIRCUIT PROTECTION MAY CREATE A HAZARDOUS CONDITION.

Incoming AC power wiring should be done by a qualified and licensed electrician, using the appropriate size wires for the installation. Consider the motor size and type of starter, and also the length of wire required from the main power distribution center in determining the proper wire size.

Proper branch circuit protection and disconnect device(s) must be provided, as required by applicable local, state and national codes.

3.3.2 Grounding

WARNING: PROPER GROUNDING IS VITAL FOR THE SAFE OPERATION OF YOUR SYSTEM. BRING THE GROUND WIRE TO THE GROUND STUD THAT IS LABELED "GND" OR "G1". YOU MUST CHOOSE THE PROPER CONDUCTOR SIZE AND MINIMIZE THE RESISTANCE TO GROUND BY USING SHORTEST POSSIBLE ROUTING. SEE NATIONAL ELECTRICAL CODE ARTICLE 250-95, OR THE RELATED LOCAL APPLICABLE CODE.

Proper grounding is vital for the safe operation of your system, and will also reduce the likelihood of noise-induced problems, which could include CPU crashes, or I/O communication errors.

- The grounding wire should be sized per the applicable codes.
- Connect the ground to a good building ground, such as the structural steel of the building, or a cold water pipe.
- Connect the ground on the controller to the stud labeled "GND" or the terminal "G1", as shown on the controller schematic.

3.3.3 Motor Wiring

Connect the motor as shown on the schematic. Consult the applicable codes for proper wire sizing and circuit protection for the motor being used.

Refer to the schematic for the location of the motor connections to the Drive.

Connect the encoder as shown on the schematic, if required.

4. Start-Up Instructions

If it is desired to run the car temporarily, during construction, the microprocessor must still be used to move the car. All normal inputs and safety devices will be required for the microprocessor to run the car. If a safety device is not installed yet, all necessary safety precautions should be made before jumping out the device. It remains the responsibility of the installing technicians to make sure that the elevator is run in a safe mode, and that all operators are aware of any safety devices that may have been disabled.

4.1 Before Applying Power

The system has been programmed and tested for the specific elevator system, so no further changes should be made without consulting with Virginia Controls.

4.1.1 Power and Grounding

WARNING: Confirm that the voltage of the incoming power matches the controller before applying power to the controller.

Check the system for improper grounds before applying power to the controller.

With the power off, remove the fuses from the secondary of the main control circuit transformer ("CCXF"). Check the safety circuit (terminals 1 through 6, and 14, 16, 18, 19) for grounds. Using a Volt-Ohm meter connect one lead to terminal 35 (ground) and touch the other lead to each terminal to be tested. The resistance should be considerably greater than 100 ohms.

NOTE: If the fuses are not removed, the meter will read a short through the windings of the main control circuit transformer.

With the fuses still removed, apply power to the controller, and verify that the voltage at the secondary of the main control circuit transformer ("CCXF") is 110-125VAC.

4.1.2 Input/Output Wiring

NOTE: The input/output boards are equipped with quick disconnect terminal blocks. During the initial installation, you may want to remove the terminal blocks, hook up your field wires to the terminal blocks, test the field wiring for no shorts to ground or hot (terminal 1) before plugging these terminals back into the I/O boards.

With the power off, and the fuses removed, check each input point for grounds, as described in the previous section, "Power and Grounding". If a ground is observed, check the schematic to determine if this is correct (it usually is NOT!).

With the power off check each output for grounds, also check for shorts to the hot side (terminal 1). Note that some field devices, such as buzzers, will have very low resistance.

WARNING: Each output point should be isolated from ground and the hot side.

4.2 Applying Power

Remove all fuses before applying power. Reinsert the fuses, one circuit at a time, checking each circuit before adding the next.

It is recommended that you start up the controller in Inspection mode, which can be done by opening the Inspection Switch, or removing the field wire(s) from terminal 23.

WARNING: The field wire in terminal 23 is HOT. If it is removed, make sure it is insulated and labeled. Reconnect it when the car is to be taken off Inspection Operation.

4.3 Temporary Run Connections

The controller should be connected as shown on the schematic, with all safety devices installed. If the installing company needs to run the car before all safety devices are installed, they will assume the responsibility for the safe operation of the elevator.

Make sure that any special operation inputs (such as Fire Service, Emergency Power, etc) are in the proper state to allow the car to run. If necessary, and if it is safe to do so, jump these out during construction.

Refer to the appropriate section for the type of Drive supplied for instructions on starting up the Drive. Also refer to the schematic for connections, and parameters that may require adjustment.

5. Final Adjustments

When the controller is ready to be run in automatic, it is recommended that EITHER a factory reset be performed OR the values of the settings and features be verified. If the program is custom (the job number will be in the bottom line of the banner) then a factory reset is recommended. If the job is not custom, then if a factory reset is done, all the values and settings for the job must be re-entered. Refer to the section Controller Diagnostics/Set-up Mode/Reset Settings, or in Controller Maintenance/Frequently Asked Questions/How Do I Reset All Settings and Features Back to the Original Values.

A factory reset can be done by:

1. Turning off the power;
2. Put the car on inspection;
3. Jump terminals 1 to 21 and 1 to 22;
4. Turn on the power for 15 seconds;
5. Turn off the power, and remove the jumpers, and continue as normal.

Alternatively, the keypad can be used. Press **[Nxt]** until the menu item "Go to Setup Menu" is displayed, then press **[Ent]** 3 times. (The screen will show a warning, then go to the Setup Menu, where the first item is Reset (factory) Settings). The password "911" should be entered when requested. Press **[Esc]** to return the elevator to service.

As the wiring is completed, the following modes of operation can be checked and used.

5.1 Inspection Operation

To run the car on Inspection Operation, the safety string (including the door contacts, terminal landing normal slowdowns, normals and finals) should be operational.

The Doors Closed and Gate Closed inputs on the I/O board should be on.

The Inspection Input should be de-energized.

Pressing the Up Run and Run Buttons will energize the Up Inspection Input, which will cause the Up Direction and Door Close outputs to come on. (The Inspection Run Inputs may be connected to the Car Call Inputs. See the schematic for the actual connections for each particular job)

When the Doors Closed input comes on, the up run outputs for the motor and the valves will energize, and the car will run up.

(Down direction is similar)

NOTE: If Hoistway Access is used to get on top of the car, then the doors will be open when Top of Car Inspection is initiated. In this case, the doors will close when the Up (or Down) Run and Run (or Enable) buttons are pressed. If it is required that the doors should only operate manually on Inspection, then the Bit Feature to "Disable Door Close on Inspection" should be enabled. In this case the doors must be closed manually or by means of the Door Close button on the Door Operator (if provided).

NOTE: If 2000 (or later) Code is provided, then the controller is expecting terminal 3 to go low when the Inspection Run Buttons are not being pressed. If a temporary run station is being used that is not wired as shown on the schematics, then the controller will show a fault if terminal 3 does not go low when the car stops. The redundancy fault can be temporarily defeated by turning Switch 3 on the CPU Slide Switch S2 to the ON position. This will also turn on the Fire Audible Visible output, as a reminder to turn off the defeat when the car is ready for full operation.

5.2 Floor Position and Slowdown

The program is in EPROM (Electrically Programmable Read Only Memory). The floor relays and fire service relays are maintained in the micro-processor RAM memory and are held through power loss by a battery on the CPU board. The floor relays may need to be reset when the controller is initially installed. This will be accomplished when the elevator hits any floor switch. With a pulsing type selector, the floor position is reset at either terminal landing when a slowdown switch and the Door Zone switch are energized at the same time.

NOTE: If floor switches are used, they should be maintained at the terminal landings, so that they are energized whenever the car is in the slowdown zone at that landing.

Make your final adjustments for the slowdown targets. All slowdown distances should be equal.

If a pulsing selector arrangement is used, remember to install the reset targets at the terminal landings.

5.3 Position Indicators

Verify that the floor position changes properly as the car goes past each landing. Floor change should take place at the slowdown point before each landing.

If the Position Indicator does not match the actual car position, run the car to a terminal landing reset target (with pulsing selector only).

5.4 Independent Service

Independent Service is useful for final tune-up of the car. Initiate Independent Service by turning on the Independent Service Switch in the car, or by jumping the Independent Service Switch input.

On Independent Service, the hall calls will be canceled. The car will run from car calls only, and will park with the doors open. To close the doors, jump terminal 1 to terminal 28 ("Door Close Button" input). This jumper may be left on, if desired, so that the car may be run by jumping the desired car call input.

NOTE: To run the car from the machine room, without the doors opening, turn off the DOL Cutout Switch. This will de-energize the Door Open Limit Sw Input, and prevent the doors from opening.

NOTE: If the car does not run, verify that no door protective device (Door Open Button, Safety Edge, Electric Eye, Infra-red Curtain) is holding the doors open. Verify that the car is not stuck in leveling. Verify that the Door Contacts input is energized and the Door Close Limit input is de-energized.

5.5 Car and Hall Calls

To observe the operation of the car and hall calls, the system must be in automatic operation (LED D1 on the CPU board should be on.) Verify that all car and hall calls work.

NOTE: On DUPLEX systems the doors must be allowed to operate for the calls to be canceled properly.

Each call will be canceled when the car initiates slowdown for the call, or when the doors start to re-open for the call if the car is already at the floor.

If both hall calls are entered at an intermediate landing, and no other calls are in the system, the doors will close after answering one of the calls, then re-open in response to the other call.

5.6 Door Operation

Verify that any required changes to the door operator, as shown on the door operator drawings, have been made correctly.

Check the Door Open and Close Limits for proper operation.

If the doors attempt to open for too long, the open cycle will be stopped. The car will then respond to other calls, and try to open the doors again.

If the doors fail to close properly within a preset time, the doors will re-open, and try to close again. If the doors closed, but the car does not run in response to a call, the doors will re-cycle, and the car will try again.

For very slow doors, the Door Stuck Timer, which initiates the Door Open and Door Close Fail, as described above, may need to be increased. It is normally set at 15 seconds.

If Nudging Operation is activated, the Electric Eye will be disabled when the Nudging Timer has tripped AND the doors are fully open. If the nudging timer trips while the doors are closing, the Nudging Buzzer will turn on, and the Electric Eye will remain active. If the doors do reopen fully, then the Electric Eye will be cut out. The Safety Edge Input remains active on nudging.

5.7 Fire Service

Fire Service Phase 1 may be initiated by turning off a Smoke Sensor input, or by energizing the Hall Fire Switch "On" input.

Confirm that the car returns to the correct Main and Alternate landings.

Confirm that the car operates as required on Car Fire Service (Phase 2) operation.

NOTE: To reset Hall Fire Service (Phase 1), most codes require the Bypass input be energized. To disable Hall Fire Service, jump the Hall Bypass input on. On 2000 (or later) Fire Code, Fire Service (Phase 1) is reset when the Hall Fire Switch is turned from Bypass to Off.



NOTE: If Car Fire Service (Phase 2) appears to be operating incorrectly, check the Door Open and Close Limits for proper operation. Most codes require that the doors be fully open before allowing a change in the mode of operation on Car Fire Service. Most codes require that Hall Fire Service (Phase 1) be in effect for the car to return automatically to the main fire landing when the Car Fire Switch is turned to the off position.

5.8 Failure Timers

5.8.1 Stuck Button Timer

If a car or hall call button remains on for an adjustable time, and other calls are registered, the stuck button call will be ignored, and the car will answer the other call(s). The car will return to the stuck button call as it answers other calls, and the stuck button timer sequence will be repeated.

5.8.2 Running Timer

If the car runs for an adjustable time, without changing floors, then running shutdown operation will be initiated. The Shutdown LED on the CPU will come on. The Shutdown could be caused by a problem with the motor starter circuit(s); or a problem with the drive system; or a problem with the selector. The car will stop immediately. It will then be shut down, with only the Door Open Button and door protective devices being operational. The fault can be reset by cycling the Main Line Disconnect Switch, or by putting the car on "Inspection" then back to "Automatic".

NOTE: With 2010 and later codes, the shutdown must be manually reset by means of a Fault Reset Input. Refer to the schematic for the location of this input.

NOTE: If a Reverse Phase Relay or Emergency Power circuitry is supplied, these will also initiate a shutdown signal if the inputs are not energized.

5.8.3 Start / Stop Sequence Timer

A sequence fault timer monitors key inputs from the drive system, such as Drive Enabled, Brake Micro Switch, and contacts of the key drive contactors. If these fail to change state properly as the car starts or stops, then the car will be shut down. The fault can be reset by cycling the Main Line Disconnect Switch, or by putting the car on "Inspection" then back to "Automatic".

NOTE: With 2010 and later codes, the shutdown must be manually reset by means of a Fault Reset Input. Refer to the schematic for the location of this input.

5.8.4 Leveling Timer

A leveling timer is provided that will cut out leveling if the car has been leveling for over 15 seconds. This prevents the car from stalling in leveling. The car will not be shut down, but will not be allowed to relevel until the car has run to another floor.

If the car stops between floors, it will run down until it energizes the Door Zone Input, or a Leveling Switch Input. This prevents the car from parking between floors. If the car runs down for over 1 minute while looking for a floor, it will stop, and return to normal operation.

5.8.5 Redundancy Faults

Redundancy Fault Checking is provided for controllers with 2000 code and later. The exact checks vary depending on the code, and installed features.

The basic principle is to verify that inputs from external relays and circuits match the current outputs. This verifies the external circuits are operating properly and no critical circuits are jumped. A brief delay is allowed before registering the fault, to allow the signals from the external devices to synchronize with the outputs.

If a fault is detected, the car will shut down at the next stop, and a fault will be logged. The Fault Log will indicate which general fault was detected, and the status information for that fault will help in determining which specific fault was detected.

The fault is reset by cycling the power. On jobs with 2010 code and later, and if a Manual Reset is enabled, then the fault must be reset by momentarily jumping the Fault Reset Input (or Shutdown Defeat). Check the schematics for the location of the Fault Reset Input.

Refer to the Fault Log section of this Manual for details. The Redundancy Faults include:

RED1ROP - Redundancy Fault in the ESB Stop Sw Bypass circuit or the Rope Brake Monitoring circuit.

RED2RUN - Redundancy Fault in the Running or Leveling circuits, such as the circuits that bypass the Door Contacts during leveling.

RED3SAF - Redundancy Fault in the Safety circuits, such as the Door Check contacts, or the Car or Hall Door contacts.

RED4INS - Redundancy Fault in the Inspection Door Bypass circuits.

SafeFlt - the Safe Input failed to operate properly.

BrakeSw - the Brake Micro Sw failed to operate properly.

Drv.Run - the Drive Run input failed to operate properly.

RED-UCM - a Redundancy Fault was detected in the ETSD/UCM board.

5.8.6 Door Fault Timers

Door Open Fault. If a door open sequence is initiated and the doors fail to open fully in an adjustable time, then a Door Open Fault is generated. The doors will stop opening. The probable causes are: (1)

Door Open Limit Switch failure, (2) door operator failure, (3) door control circuitry failure. This fault can be disabled on Manual Door systems.

The Door Open Fault will stop the door open sequence. It does not latch, and does not need to be reset. The door time will expire as normal, the doors will close, and the car will continue to answer calls.

Door Close Fault. The doors failed to close properly when they were parking, or when the car was ready to run for the next call. This fault will not be caused by keeping the doors open through the normal means (Door Open Button, Safety Edge, Infra-red Unit, etc.), but only if the doors should be closing but were not able to close. The probable causes are: (1) Door Close Limit Switch failure, (2) Door Contacts failure, (3) door operator failure, (4) door control circuit failure.

The fault will stop the door close sequence. In automatic, it will reopen the doors, and allow them to try to close again. The fault does not latch and does not need to be reset.

Both faults are tripped by timers, and the time delay is set by the Doors Stuck setting, as shown on the Adjustment Sheet in the schematics.

5.8.7 Door Check Fault or Door Lock Monitoring

The Door Check Fault (or Door Lock Monitoring) checks that the Car and Hall Door contacts are not jumped. When the doors are fully open, relays are used to monitor the Car and Hall Door Contacts separately. If either of these inputs is on while the doors are open, then a fault is logged. The doors are held open until the fault is cleared.

Various codes, notably NYC code, require slightly different operation. In NYC code, when the car is on Fire Service Phase 2, the Hall Door Contacts are not monitored but only the Car Door Contact.

Refer to the Fault Log section of this Manual for further details.

5.8.8 Door Zone Faults

A Door Zone Fault is generated if the Door Zone Input comes on or stays on when it should not. The fault indicates the Door Zone Switch was energized when the car was running Fast Speed or when the car was slowing down and before it hit an Up or Down Leveling Switch. The car will shut down when it stops at the next landing.

There are several situations that can give this fault that may not seem to be a problem with the Door Zone Switch, but which ultimately the MVFAC-3000 sees as the Door Zone Input being on when it should not be. In most cases the FSU or FSD relay did not energize properly on a floor-to-floor run. These situations include:

- The Level Lockout Timer is too short. It must be long enough for the FSU or FSD relays to energize and cut out the Door Zone Input.
- The UL or DL inputs are failing.
- There is a failure in the Up or Down Normal Limit Sw, preventing FSU or FSD from energizing to cut out the Door Zone Input.
- There is a loose wire or bad connection on terminal 6, 14, 14X, 16, 16X, 21 or 22 which is preventing FSU or FSD from energizing properly.

The fault is reset by Fire Service, Inspection or cycling the power. It is disabled if Redundancy is disabled.

5.8.9 Resetting Shutdown Faults

Most faults can be reset by cycling Inspection or by cycling the power.

With 2010 and later codes, shutdown faults must be reset manually. Redundancy Faults can also be set to require a manual reset. In this case a power cycle or Inspection Sw cycle are not manual resets, as they may have been caused by a power outage. Shutdown faults are reset by momentarily jumping the Fault Reset Input (see the schematic for the location of this input).

5.9 Field Adjustable Features

Refer to the section on changing Settings and Features to see the features that are adjustable.

The controller is already set up for the specific job when it is shipped from Virginia Controls. It is recommended that the "Reset Settings" sequence be performed, or the settings and features be checked, when the controller is first powered up. This sequence is described in the section Controller Diagnostics/Set-up Mode/Reset Settings, or in Controller Maintenance/Frequently Asked Questions/How Do I Reset All Settings and Features Back to the Original Values.

The settings or features that most often need adjustment are the door times, and fire service return floors.

5.10 Zoned Duplex Operation

The Duplex System will keep one car at the Main Dispatch Landing, as the Lobby Car, and allow the other car, or the Free Car, to stop at it's last call. The Lobby Car will answer calls in the Lobby Zone, and the Free Car will answer all other calls. The Lobby Car may leave the lobby to assist the Free Car under various load conditions as described below under Start Control. The "Lobby Zone" is an adjustable group of landings but the factory preset value is normally the Lobby/Main landing and any landings below the Lobby/Main landing. All other landings are in the "Upper Zone". If a car is "Next" in a zone, then it will answer calls in that zone, otherwise it will answer calls in the other zone. If both cars are in service, a car will always be homed to the Main Lobby level.

5.10.1 Common Circuits

Several circuits need to be energized when either car is on. These include the Hall Calls, Fire Service, and some other circuits that may be required for a particular job (such as Emergency Power, Hospital Service, etc.). These circuits get their power from either car by means of the VR (Voltage) relay. (See the schematic.)

Install each car separately. The Hall Calls and Hall Fire signals may be wired to either car, then cross-connected to the other car.

WARNING: Be careful not to mix the power supplies from one car with the other car. Signals that are common to both controllers must be connected to a common supply, as shown on the schematic.

5.10.2 Next Car

A "Next Car" is selected for the Lobby Zone and the Upper Zone. This car will be assigned hall calls in the respective zone. The other car may answer calls in a zone where it is not "Next", but it will not normally be sent to calls outside its zone. The "Next Car" assignments can be seen in the communication signals (see below).

5.10.3 Car Start

The Car START feature controls when the car will respond to registered Hall Calls by controlling the internal direction circuits. When the START circuit is energized the car will immediately begin to respond to Hall Calls. There is a separate start circuit for the Lobby Zone and the Upper Zone. A car will always respond to Car Calls immediately.

The START circuit is energized if ANY of the following conditions are true:

1. The car is Next in that zone.
2. The car is in the other zone, and is NOT next in that zone. (This means that both cars are in the other zone, so the car that is not next in the other zone will be pulled into this zone.)
3. The call(s) in this zone have been registered for a preset time. (This allows the other car to help in heavy traffic situations.)
4. The car is not in normal group operation.
5. The other car is not in normal group operation.
6. The other car has a call behind it.
7. Emergency Power is activated, and this car is assigned to run.

5.10.4 Homing

If there are no cars at the Main Dispatch landing, the "Next" car in the Lobby Zone will home, or return, to the Main Dispatch Landing. If there is no "Next Car" in the Lobby Zone, then the first available car will home to the Lobby. If desired, the "Free" car can be set up to home to a specific (adjustable) landing in the upper zone, or to home to the Main landing. (See the separate description on Feature Adjustments.)

A car will home if the following conditions have been met for 10 seconds:

1. The car is in group operation (not on Inspection, Independent Service, Fire Service, Load Weighing etc.).
2. The Stop Switch is not thrown.
3. The car is not stuck.
4. The doors are closed.
5. The car is not at the Main Dispatch Landing.
6. The car is not running.
7. The other car is in group operation.
8. The other car is not next in the Lobby Zone.
9. The other car is not running down.
10. The other car is not homing.

5.10.5 Communication

Confirm that the termination jumpers have been installed to connect the termination resistors. These are two small jumpers just below the Duplex Communication Connector block in the upper left corner of the CPU. (Refer to the diagram of the CPU below)

Connect the communication cable from the Duplex Communication Connector block of one car to the other car. The negative terminal on one car only should be connected to ground.

When both cars are in operation, the LED L4 should flash repeatedly. This indicates the two CPUs are communicating properly.

If LED L4 is not flashing, check the communication cable, the termination jumpers, and the grounding. If these look OK, but the CPUs are not communicating, do a factory reset on both cars. Memory location 0508 shows the number of successful communications (it should be constantly changing when both cars are operating) and memory location 0509 shows the number of bad communication attempts (this should be 0). (Note: These memory locations are subject to change.)

5.11 ETSD Monitoring System Setup

The ETSD board by Virginia Controls is a hardware system for traction elevator controllers that provides a level of redundancy for a specific set of control functions required by the A17.1 Safety Code for Elevators and Escalators.

See Section 6.6.5 for additional details.

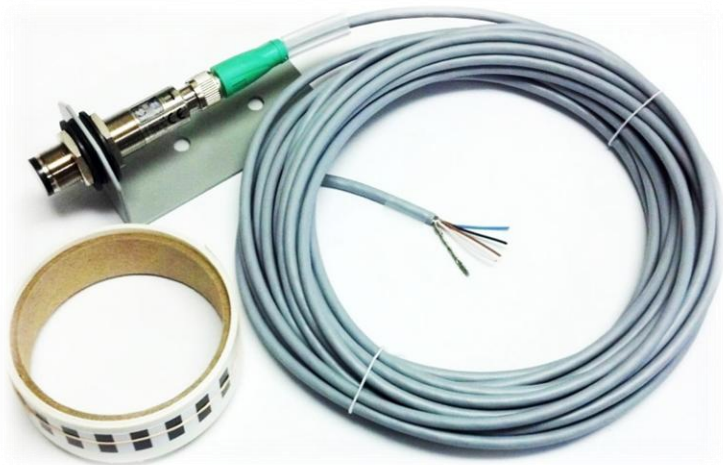
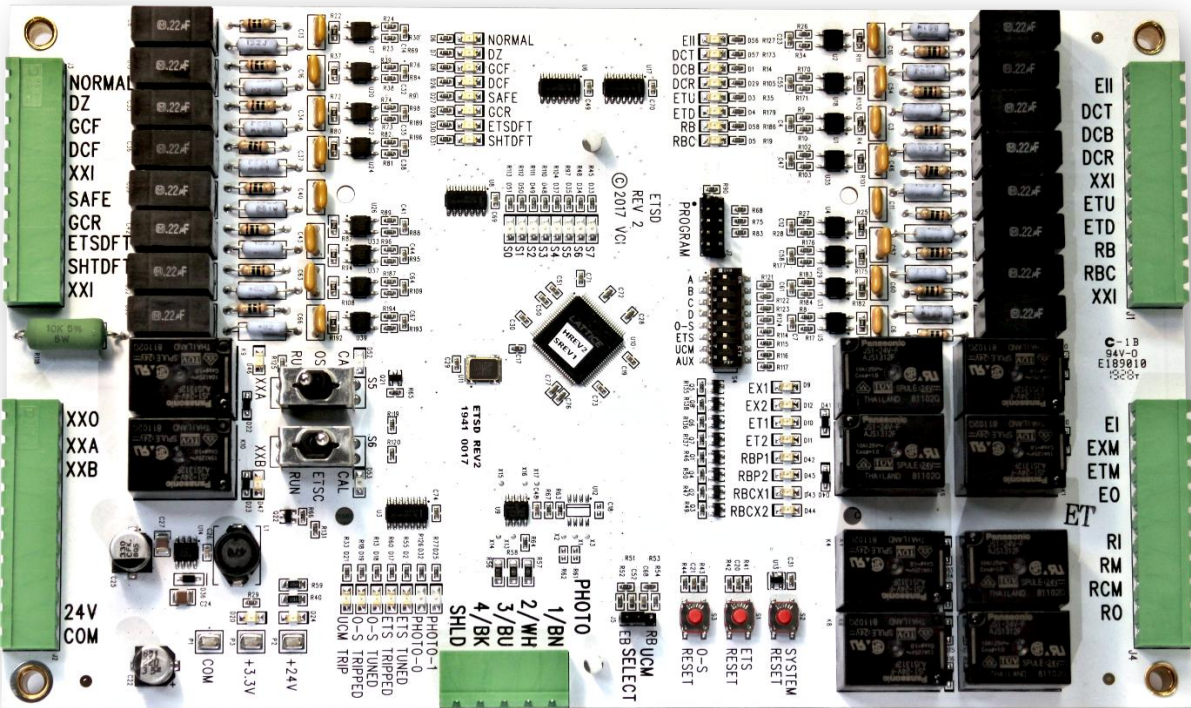

Figure 1: ETSD Monitoring System Hardware

5.11.1 Setup of the UCM (Unintended Car Movement) System

1. With power off, verify that UCM Select Jumper is set to "RB" for use with a Rope Brake device, or set to "EB" for use with a Hoist Machine Emergency Brake.

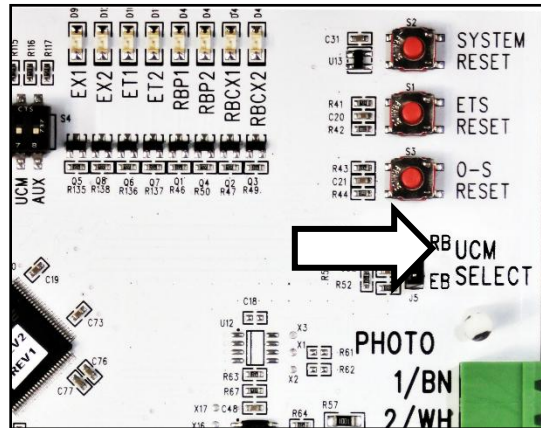

Figure 2: UCM SELECT Jumper

NOTE: Follow the prints for setting the UCM Select Jumper. If a label was applied to the board for setting this jumper, then follow it, but it should agree with the prints.

2. Verify the "OSC" & "ETSC" Calibration Switches are down in the "RUN" position.

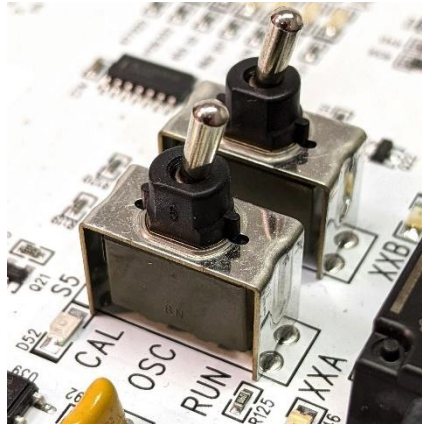

Figure 3: "OSC" and "ETSC" Calibration Switches (in RUN position)

3. To begin installation, and with power still removed from controller, defeat the UCM System (and O-S & ETSD Systems) by placing a jumper from controller TB-1 (120VAC) to ETSD Inputs SHTDFT and ETSDFT at bottom of ETSD Board.

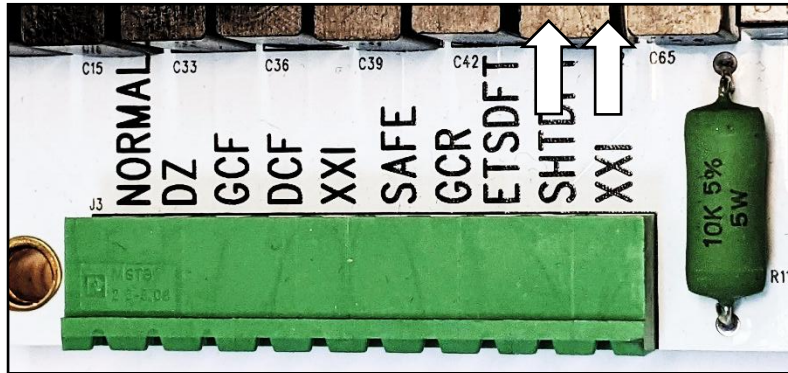

Figure 4: SHTDFT and ETSDF Inputs

4. Power up the controller and verify that ETSD Board Input LED's: "EII, ETSDF & SHTDFT" are lit.

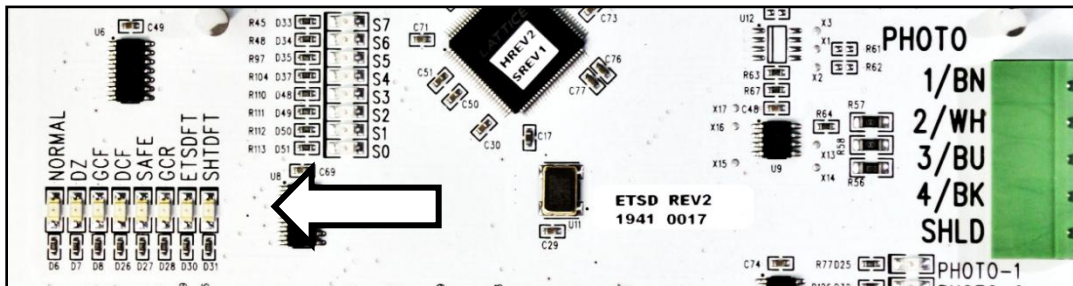

Figure 5: ETSDF & SHTDFT Input Indicators

5. Other Input LED's may be lit as well, but also verify that ETSD Board Relay Output LED's: "EX1, EX2, ET1, ET2, RBP1 & RBP2" are lit to permit temporary movement of the elevator.

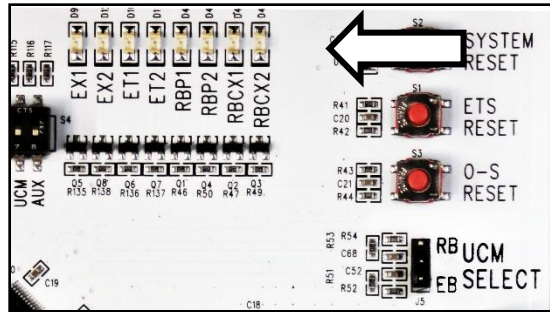

Figure 6: EX1, EX2, ET1, ET2, RBP1 & RBP2 Output Indicators

6. Construction of the elevator may now proceed until it is decided that the O-S System should be tuned.
7. Once the O-S System is tuned (see next Section, "Setup of the O-S System"), remove the jumper from controller TB-1 (120VAC) to ETSD Board Input SHTDFT.
8. Removal of the jumper from controller TB-1 (120VAC) to ETSD Board Input ETSDFT occurs when ETSD System is tuned per the final section, "Setup of the ETSD System" – required when contract speed is greater than 200FPM.

5.11.2 Setup of the O-S (Over Speed) System

The un-tuned O-S System was previously defeated in the “Setup of the UCM System” Section by a jumper from controller TB-1 to ETSD Input SHTDFT.

During construction, once the elevator is running in a controlled and consistent manner, the O-S System can be tuned while on Inspection, therefore start here!

NOTE: An un-tuned O-S System powers up with “O-S TRIP” & “O-S TUNED” LED’s off.

1. Apply the ETSD Speed Sensor Tape around a machined surface of a sheave (either machine driver or deflector sheave) that is and will remain relatively free of oil and grease. Note, the ETSD Tape runs at, or close to, rope speed at rope diameter on sheave.



Figure 7: ETSD Tape

NOTE: The ETSD Tape is $\frac{5}{8}$ ” wide by 10 feet long and should be trimmed to length and can be shaved in width once installed on sheave.

2. Ensure that the ETSD Tape does not come in contact with the brake pad surfaces of the main or emergency brakes of a gearless machine, nor lap over into a rope groove of any sheave.
3. If not already assembled, mount the Speed Sensor in its steel 90° angle mounting bracket with 1” of its threaded barrel extending through the bracket, and with the controls & LED’s of the sensor facing outward for viewing. Note the arrangement/order of the grommet & washers.



Figure 8: Speed Sensor & Mounting Bracket

IMPORTANT NOTE: The rubber grommet & washers are provided to isolate the speed sensor electrically from the mounting bracket & motor, otherwise damage may occur.

4. Use the mounting bracket to position the Speed Sensor +5" ($\pm 1/4$ ") away from the ETSD Tape at an angle that is nearly perpendicular to the tape but slightly off by approximately 10°.
5. With power off, route the 30ft Speed Sensor Cable through a metal conduit to the ETSD Board.

NOTE: Be sure the metal conduit is grounded at the motor end, and ground the separate metal conduit containing motor leads in the same manner, if possible.

6. Wire the cable per markings at the 5-Pole "PHOTO" connector (removable) on ETSD board. Shorten the cable at the ETSD Board once routing of the conduit is determined. Do not coil the cable within controller.

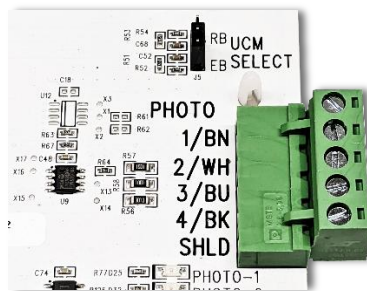

Figure 9: "PHOTO" Connector on ETSD Board

7. Check the braided/bare Drain wire of the Speed Sensor Cable at the "SHLD" terminal of ETSD Board. Check for a 14Ga Green GND wire at the #8 nut at lower-right ETSD Board mounting stud.
8. Align and plug in the connector (whether straight or right-angle style) on the Speed Sensor Cable to the connector end of the mounted Speed Sensor, then finger tighten this connection.



Figure 10: Installed ETSD Tape & Speed Sensor

9. Power up controller, and verify that the Green "POWER" LED is lit on the Speed Sensor.

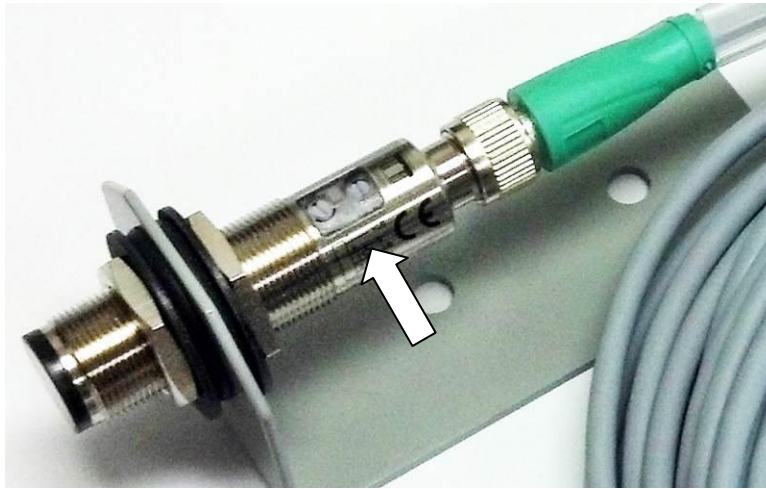

Figure 11: Sensor Green POWER LED Indicator

10. Verify that the Yellow "SENS." LED of Speed Sensor and the "PHOTO -1" LED on the ETS Board are lit only when the red light beam of the Speed Sensor is pointed at a white segment of the ETS Tape.

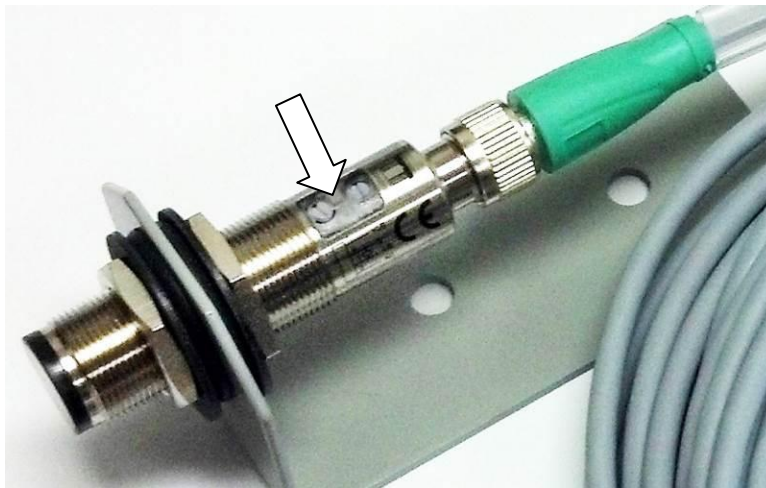

Figure 12: Sensor Yellow SENS. LED Indicator

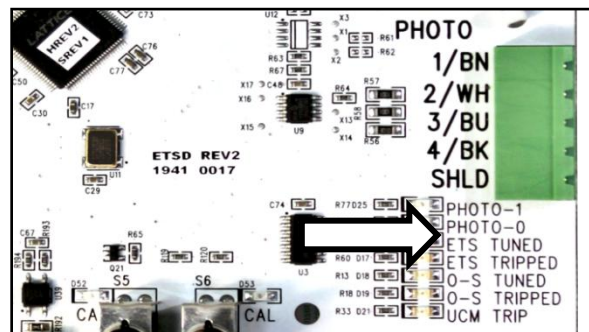

Figure 13: PHOTO-1 Indicator

- Verify that the “PHOTO-0” LED on the ETSD Board lights only when the red light beam is pointed at a black segment of the ETSD Tape.

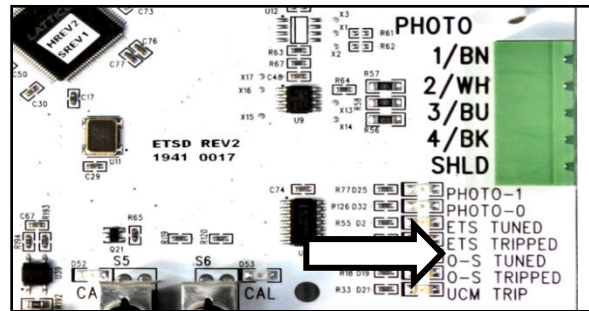

Figure 14: PHOTO-0 Indicator

- Important Step: Perform the following checks to ensure that “PHOTO-1” LED on the ETSD Board lights only when the sensor is pointed at a white segment of the ETSD Tape, and to prevent “PHOTO-0 & PHOTO-1” LED’s from oscillating while the sheave is still, and perhaps pointed at a black segment:

- “L/D” (Light/Dark) Switch of Speed Sensor is set to “L” or Light position. (Check carefully!)
- “SENS.” Potentiometer of Speed Sensor (2-turn w/clutch) is set on turn - middle.
- Speed Sensor is about 5” ($\pm 1/4$ ”) away from the ETSD Tape.
- Speed Sensor is aligned slightly off (approx. 10°) perpendicular from tape.

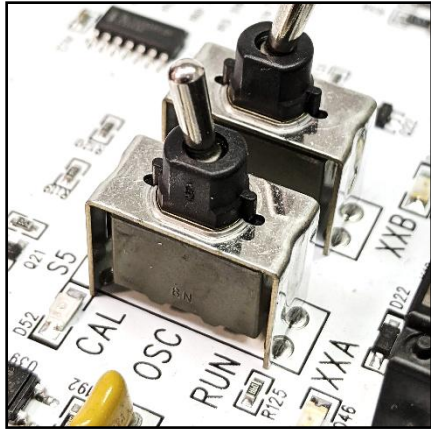

Figure 15: Sensor L/D Switch & SENS. Potentiometer

- Important: Increasing the angle of the sensor off ($\approx 10^\circ$) perpendicular with the tape, or adjusting the “SENS.” Potentiometer per the P+F Adjustment Instructions included with the Sensor, may be required to eliminate these issues.

NOTE: The goal of these steps is a focused ($< 1/16$ ” Dia.) red light beam on the ETSD Tape having maximum sensitivity to white segments while rejecting the black segments.

NOTE: ETSD “PHOTO-1 & PHOTO-0” LED’s should never oscillate when the red light beam is resting on a seam or edge between white & black segments of the ETSD Tape.



13. Power down controller, and remove the jumper between controller TB-1 and ETSD Board Input SHTDFT at bottom of ETSD board. (The jumper at ETSD Board Input ETSDFT remains for now.)

14. Move the “OSC” Calibration Switch from the “RUN” to “CAL” position. Verify OSC “CAL” LED lights in next step.

15. Power up controller, and verify that ETSD Board Input LED’s: “EII & ETSDFT” are lit.

16. Other Input LED’s may be lit as well, but also verify that ETSD Board Relay Output LED’s: “EX1, EX2, ET1, ET2, RBP1 & RBP2” are lit to permit temporary movement of the elevator.

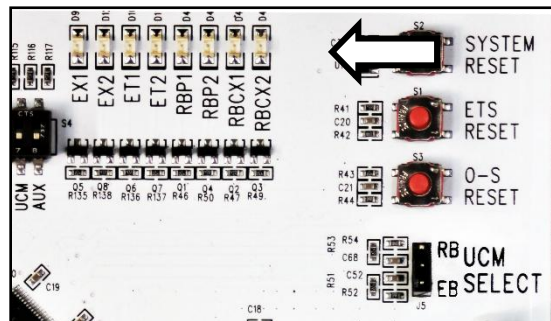

Figure 16: Output Indicators

17. Set the drive for an Inspection speed of 150FPM and run the car for about 5 seconds.

NOTE: Car speed should be checked with hand tachometer, or repeat when available.

18. If elevator contract speed is 150FPM or lower, then set the drive (in previous step) to approx. 80% of contract speed, but still comfortably above desired operational Inspection speed.

19. When the elevator comes to a stop, move the “OSC” Switch from the “CAL” to “RUN” position with power on. The “O-S TUNED” LED will light, indicating a valid calibration of the O-S System.

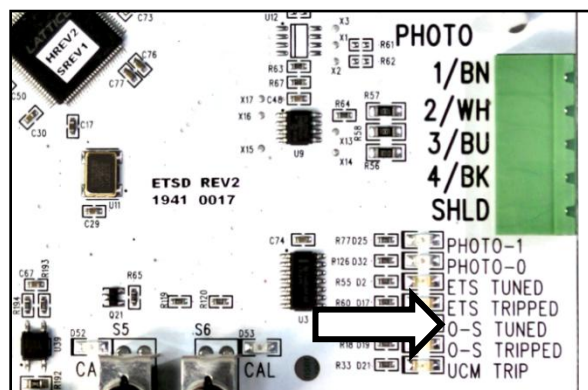

Figure 17: O-S TUNED Indicator

20. Verify ETSD Board Input LED’s: “EII & ETSDFT” are lit, and that ETSD Board Relay Output LED’s: “EX1 & EX2” are also lit. Other I/O LED’s may be lit as well, and that the “OSC CAL” LED is off.

21. Return the drive to its former Inspection Speed setting (30-50FPM).

22. If contract speed is 150fpm or lower, limit the Inspection Speed setting on the drive to not more than 50%-60% of contract speed – therefore, well below the O-S Calibration.
23. The UCM & O-S Systems are now operational.

NOTE: The ETSD System alone remains defeated until final adjustments are made on Normal operation.

24. **Important:** If the O-S System should fault intermittently, it is most likely caused by “noise” that is picked up by the Speed Sensor Cable due to its proximity to the motor leads of the Drive, or by a poorly aligned or mis-adjusted Speed Sensor. See Step 12 (above) and Steps 25 & 26 (below).
25. **Important:** Car speed can be monitored on LED’s “S0-S7” by only turning on “AUX” DIP Switch. These LED’s show car speed as a binary count that should ramp up & down smoothly with Accel & Decel, and appear stable at constant speed, with dithering (or flashing) on the lowest one or two bits only.

LED’s “S0-S7” represent an 8 Bit count (1, 2, 4, etc.) where each bit accounts for 5FPM (or, one ¼” of tape travel sampled over 250mS). Example: LED’s “S1 + S2 + S3 + S4” = (2 + 4 + 8 + 16) x 5 = 150FPM.

Leave the “AUX” DIP Switch in the ON / Up position for speed monitoring.

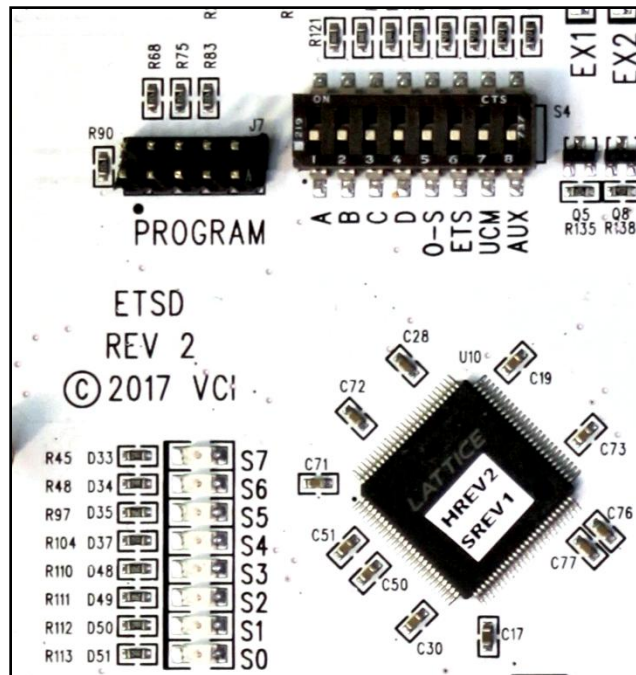

Figure 18: State LEDs and DIP Switches

26. **Important:** While running, if LED’s “S0-S7” flash off and on randomly, without a pattern: check that the Speed Sensor Cable is ran separate and away from line & motor leads; check conduit grounding; and check the alignment and adjustment of the Speed Sensor per Step 12. Then, recalibrate O-S System.

5.11.3 Setup of the ETSD (Emergency Terminal Stopping Device) System

The un-tuned ETSD System remained defeated in the “Setup of the O-S System” Section by a jumper from controller TB-11 to ETSD Input ETSDFT.

If the elevator contract speed is 200FPM or less, then the ETSD System is not tuned, and the jumper from controller TB-1 to ETSD Input ETSDFT remains in place. Stop here!

If contract speed is greater than 200fpm, proceed with ETSD tuning.

The ETSD System can be tuned only after the O-S System has been tuned.

An un-tuned ETSD System powers up with “ETSD TRIP” & “ETSD TUNED” LED’s off.

NOTE: Minimum ETS Switch Cam lengths are 6ft for 200-500FPM to provide approximately 0.5 Sec of dwell time. The ETS Switches may also be maintained to the Final Limit Switch as most cam lengths are the height of the car.

Once the elevator has been fully adjusted for Normal operation (Contract Speed set along with Accel/Decel & Jerk Rates), and the ETS Switches and Cam are installed, then ETSD System can be tuned.

Table 1: Recommended ETS Switch Placement (one N.C. switch per terminal & direction)

Car Speed (FPM)	Switch Placement
225	2’-3”
250	2’-6”
300	3’-6”
350	4’-3”
400	5’-3”
450	6’-6”
500	7’-6”

1. Power down controller, and remove the jumper between controller TB-1 and ETSD Board Input ETSDFT at the bottom of ETSD Board.
2. Move the “ETSC” Calibration Switch from the “RUN” to “CAL” position. Verify ETSC “CAL” LED lights in next step.
3. Power up controller, and verify that ETSD Board Input LED’s: “EII & NORMAL” are lit.
4. Other Input LED’s may be lit as well, but also verify that ETSD Board Relay Output LED’s: “EX1, EX2, ET1, ET2, RBP1 & RBP2” are lit to permit movement of the elevator.

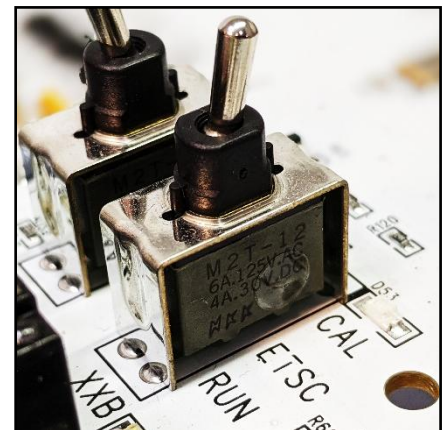

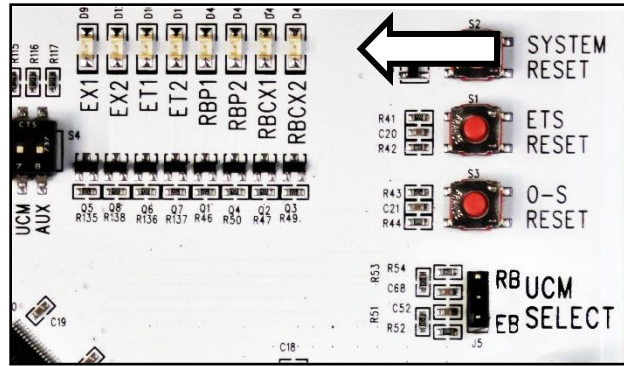

Figure 19: Output Indicators

5. Set the drive for a High Speed setting of 90% of contract speed, and send the elevator on a multi-floor run on Normal operation. Verify that the elevator obtains this speed.
6. When the elevator comes to a stop, move the “ETSC” Switch from the “CAL” to “RUN” position with power on. The “ETS TUNED” LED will light, indicating a valid calibration of the ETSD System.

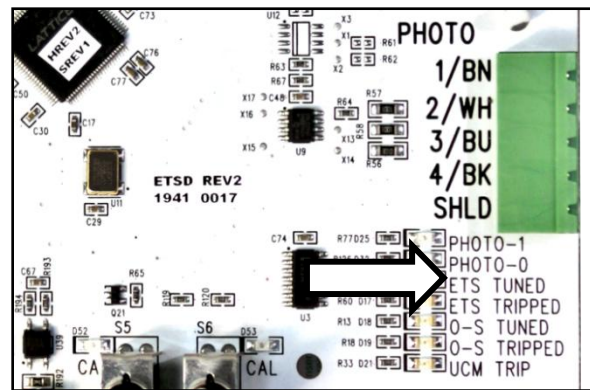

Figure 20: ETS TUNED Indicator

7. Verify ETSD Board Input LED “EII” is lit, and that Relay Output LED’s: “EX1 & EX2” are also lit. Other Input & Output LED’s may be lit as well, and that the “ETS CAL” LED is off.
8. Return the drive to its former High (Contract) Speed setting.
9. If on Normal Operation and the car is not on an ETS Switch, then ETSD Board Relay Output LED’s: “ET1 & ET2” should be lit. If lit, remove a wire from ETSD Board Input ETU or Input ETD and verify that ETSD Board Relay Output LED’s: “ET1 & ET2” turn off. Replace ETU or ETD Input wire.
10. The UCM, O-S & ETSD Systems are now operational. Run the elevator into the terminal landings. If the ETSD System should fault intermittently, then move the ETS Switch(es) toward the terminal landing(s) by 6” to 1’ (depending on car speed) to eliminate nuisance ETSD faults.
11. Important: If the ETSD System persists with nuisance faults, it is most likely caused by “noise” that is picked up by the Speed Sensor Cable due to its proximity to the motor leads of the Drive, or by a poorly aligned or mis-adjusted Speed Sensor. See Step 12 of Section 5.11.2, and Steps 12 & 13 (below).
12. Important: Car speed can be monitored on LED’s “S0-S7” by only turning on “AUX” DIP Switch. These LED’s show car speed as a binary count that should ramp up & down smoothly with Accel & Decel and appear stable at constant speed, with dithering (or flashing) on the lowest one or two bits only.

LED's "S0-S7" represent an 8 Bit count (1, 2, 4, etc.) where each bit accounts for 5FPM (or, one ¼" of tape travel sampled over 250mS). Example: LED's "S1 + S2 + S6" = (2 + 4 + 64) x 5 = 350FPM.

Leave the "AUX" DIP Switch in the ON / Up position for speed monitoring.

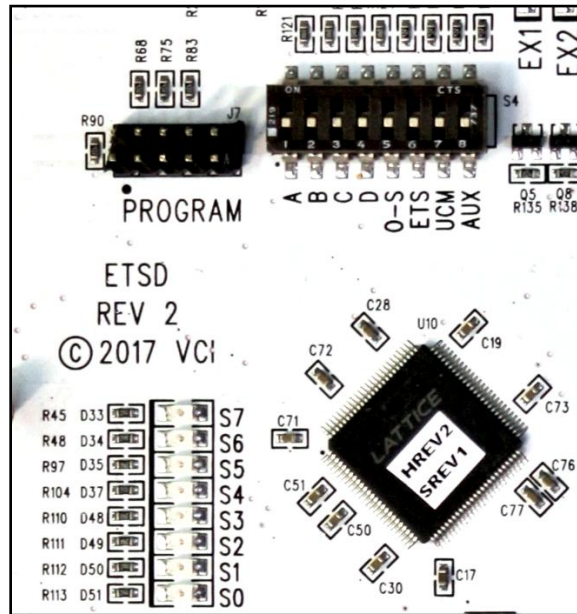

Figure 21: State LEDs and DIP Switches

13. Important: While running, if LED's "S0-S7" flash off and on randomly, without a pattern: check that the Speed Sensor Cable is ran separate and away from line & motor leads; check conduit grounding; and check the alignment and adjustment of the Speed Sensor per Step 12 of Section 5.11.2.

Then, recalibrate both O-S & ETSD Systems.

5.12 A-B Micro PLC Setup

Where speed checking is required, a separate Allen-Bradley Micro PLC may be provided. This is connected to the encoder to monitor the speed of the car, and generate a fault if an overspeed condition is detected.

5.12.1 SPECIAL ADJUSTMENTS with ETSD/UCM BOARD, HSC

This section shows the standard definitions of any Custom Times and Features used for ETSD/UCM Board. Refer to the Installation and Adjustment Manual for all other adjustments and for instructions on changing the values of the features shown below.

NAME and DESCRIPTION

HSC FAULT DELAY. (Value is in tenths of a second) This sets the delay before a High Speed Counter fault is initiated. The car will shut down, and the cause of the fault will be logged.

HSC START DELAY. (Value is in tenths of a second) This sets the delay after the start of a run before the speed is checked for movement, and for proper direction.

ETS FAULT DELAY. (Value is in tenths of a second) This sets the delay before an Emergency Terminal Speed fault is initiated. The car will shut down, and the cause of the fault will be logged.

UCM FAULT DELAY. (Value is in tenths of a second) This sets the delay before an ETSD/UCM Monitoring Fault is logged. It should be set long enough to prevent nuisance faults.

1FR HOLD DELAY. (Value is in tenths of a second) This sets the delay to hold the 1FR output when the car is running full speed and slows down. It allows the car to pass the leveling zone of the previous floor, so that it stops at the correct floor.

ENABLE ETSD/UCM BOARD. Enable this bit feature when the ETSD/UCM Board is used. It enables the Rope Brake check and Redundancy Faults used with the ETSD/UCM Board.

DISABLE UCM BOARD REDUNDANCY FAULTS. Enable this bit feature to disable Redundancy Faults from the UCM Board.

ENABLE HIGH SPEED COUNTER. Enable this bit feature when using an external PLC with a High Speed Counter. This can be turned off temporarily during setup to disable HSC faults.

ENABLE EMERGENCY TERMINAL SLOWDOWNS (ETS). Enable this bit feature when using an ETS system with the ETSD/UCM Board.

ENABLE ONE AND TWO FLOOR RUN SPEEDS. Enable this bit feature when a separate speed is provided for One Floor Runs.

ENABLE LONG FLOOR FROM ? to ?. Enable one of these bit features when there is a long floor at the specified floors. The car will then run full speed between those two floors.

5.12.2 SPECIAL FAULTS for ETSD/UCM BOARD, HIGH SPEED COUNTER

When an ETSD/UCM Board or a High Speed Counter Processor is used, additional checks are used that check for proper operation. The message "REDUCM" on the main status screen indicates a problem with

the ETSD/UCM board. “HSC-ETS” indicates a speed related problem. Go to the Fault Log and check the status line to determine the cause. Refer to the Fault Log to get the detailed fault information. See the section for Fault Log later in this manual for a description of the Fault Status bits for these faults.

5.12.3 ADJUST MODE

Adjust Mode allows various parameters to be set using the 10 inputs on the top of the A-B Micro 830 PLC.

WARNING: The inputs to the Allen-Bradley Micro830 PLC are 115VAC. **DO NOT MIX THE VOLTAGES.** See the prints and PLC documentation for details of the PLC wiring.

1. Make sure the car cannot not run.
2. Jump Input I-09 on. Leave the jumper on until step 5. Light 9 on the front of the PLC will come on. If it does not, verify the input common is connected and that you are jumping to the correct terminal.
3. After I-09 has been on for at least 1 second, jump I-08 on.
4. Output 4 will go off, and output 5 will come on, indicating the Adjust Mode has been initiated.
5. Remove the jumper to I-09 then remove the jumper to I-08. Output 0 will come on.
6. Jump In0 to I-07 to select the value to be changed, see the table below. Leave the jumpers on until step 9.

I-00	I-01	I-02	I-03	FUNCTION
ON	OFF	OFF	OFF	Car Speed, in FPM
OFF	ON	OFF	OFF	Speed to trip 10fpm Speed Indication
ON	ON	OFF	OFF	Speed to trip Doors Open Speed Indication
OFF	OFF	ON	OFF	Speed to trip Inspection Speed Indication
ON	OFF	ON	OFF	Speed to trip 90% of Contract Speed Indication
OFF	ON	ON	OFF	Speed to trip 95% of Contract Speed Indication
ON	ON	ON	OFF	Speed to trip 100% of Contract Speed Indication
OFF	OFF	OFF	ON	Speed to trip 110% of Contract Speed Indication
ON	OFF	OFF	ON	Delay Before Accepting New Speed in milliseconds

7. Jump Input I-09 on. The previous selection is stored. Output 0 will go off, and Output 1 will come on.
8. Remove the jumper to I-09.
9. Change the jumpers to I-00 to I-07 to select the lower 8 bits of the desired value to be entered, according to the table shown below. Leave the jumpers on until step 12.
10. Jump Input I-08 on. The previous selection is stored. Output 1 will go off, and Output 2 will come on.
11. Remove the jumper to I-08.
12. Change the jumpers to I-00 to I-07 to select the upper 8 bits of the desired value to be entered, according to the table shown below. Leave the jumpers on until step 14.
13. Jump Input I-09 on. The previous selection is stored. Output 2 will go off, and Output 3 will come on.
14. Remove any jumpers to all inputs, I-00 to I-09.

15. Jump Input I-08 on. The value is stored for the selected register, and the Adjust Mode is completed. Outputs 3 and 5 will go off. Output 4 will come on. Remove the jumper to Input I-08. If an additional value needs to be changed, repeat the complete procedure again from step 1.

NOTE: If the process needs to be interrupted, cycle the power. Output 5 will go off, indicating the Adjust Mode has been cancelled. Output 4 will come on, indicating the PLC is in normal mode.

To reset all values back to the factory default, jump I-01 while the PLC is NOT in Adjust Mode.

DETERMINING THE JUMPERS FOR ADJUST MODE STEPS 9 and 12.

The desired value must be broken down into a binary number, then the appropriate inputs turned on to give that number. The following table shows the value for each jumper applied in steps 9 and 12.

INPUT	VALUE in LOWER 8 bits, IF INPUT IS ON (Step 9)	VALUE in UPPER 8 bits, IF INPUT IS ON (Step 12)
I-00	1	256
I-01	2	512
I-02	4	1024
I-03	8	2048
I-04	16	4096
I-05	32	8192
I-06	64	16384
I-07	128	32768

For example, the (decimal) value 350 is (256 + 64 + 16 + 8 + 4 + 2). To set this value jump I-01, I-02, I-03, I-04, I-06 in step 9 and IN00 in step 12.

The (decimal) value 25 is (16 + 8 + 1). To set this value jump I-00, I-03, I-04 in step 9 and nothing in step 12.

5.12.4 ALLEN-BRADLEY MICRO830 HSC SETUP.

(Used on controllers that run at 200FPM and above)

During installation, on the Allen-Bradley PLC, jump input I-00 on.

Verify that Output 0 on the Allen-Bradley PLC comes on when the car runs up.

If it does not, check the encoder wiring, then swap wires A+ and B+, also swap A- and B-.

If faults are being generated in the main PLC, it may be necessary to either jump the Shutdown Defeat Input on the main PLC, or turn off the HSC selection in the Adjustable Features of the main PLC.

5.12.5 CALIBRATE THE HIGH SPEED COUNTER.

1. Power should be ON.

2. Jump Input I-00. (If it was already on, then take it off and put it back on)
3. Run the car UP at contract speed. Speed Code outputs O-01, O-02 and O-03 should all be on.
4. Output O-00 must come on when the car runs up.
5. When the car stops, remove the jumper to Input I-00.
6. Calibration is complete.

It can be repeated at any time by repeating the steps shown above.

5.12.6 TROUBLESHOOTING

1. Verify that Output 0 on the Allen-Bradley PLC comes on when the car runs up. If it does not, check the encoder wiring, then swap wires A+ and B+, also swap A- and B-.
2. Verify that the A and B lights on the HSC Module flash when the car moves. This is most noticeable when the car is going very slowly.
3. Jump input I-01 on the Allen-Bradley PLC to reset all speed set points back to the factory default values.

5.12.7 ALLEN-BRADLEY PLC OUTPUTS and INPUTS

O-00	On when the car is running up	I-00	Initiate HSC Calibration
O-01	Speed Code 1	I-01	Reset all settings to factory default
O-02	Speed Code 2	I-02-7	Used for Adjust Mode
O-03	Speed Code 3	I-08	Used for Adjust Mode
O-04	HSC is OK	I-09	Initiate Adjust Mode
O-05	Adjust Mode		

5.12.8 SPEED CODES

O-01	O-02	O-03	Speed
Off	Off	Off	Less than 10fpm
On	Off	Off	Between 10fpm and Doors Open Speed (30fpm)
On	On	Off	Between Doors Open Speed and Inspection Speed (150fpm)
Off	On	Off	Between Inspection Speed (150fpm) and 90% of Contract Speed
Off	On	On	Between 90% and 95% of Contract Speed
On	On	On	Between 95% and 105% of Contract Speed
On	Off	On	Between 105% and 110% of Contract Speed
Off	Off	On	Over 110% of Contract Speed

6. Controller Hardware Description

The controller consists of the Microprocessor system, Power Supply section, and Relay Interface.

The Microprocessor system consists of the Central Processor Board (CPU), which has the microprocessor central processing unit, the EPROM memory chip, and the appropriate hardware to communicate to the LCD display, Keypad, and Input/Output boards.

The program is in EPROM (Electrically Programmable Read Only Memory). The floor position and fire service functions are maintained in battery backed RAM memory. The floor position may need to be reset when the controller is initially installed.

The Power Supply section includes the required transformers and fuses to power the Microprocessor system and the Relay Interface.

The Relay Interface includes the required relays and contactors to interface the field signals and devices to the microprocessor. This usually includes relays or contactors for signals required for each specific job.

6.1 Transformers

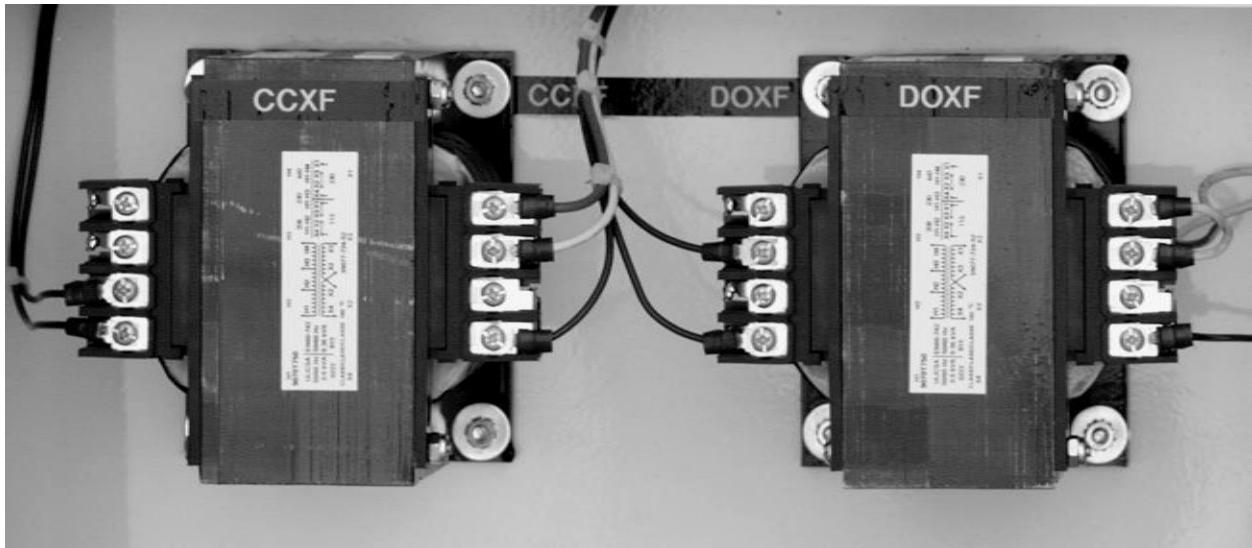

“CCXF” is the Control Circuit Transformer. This will provide the controller with 115VAC. The primary connections will vary depending on the Building Power. See the schematic for sizing and wiring information.

“DOXF” is the Door Circuit Transformer(s). The size and quantity of these transformers will depend on the type of doors used. See the schematic for sizing and wiring information.

6.2 Fuses

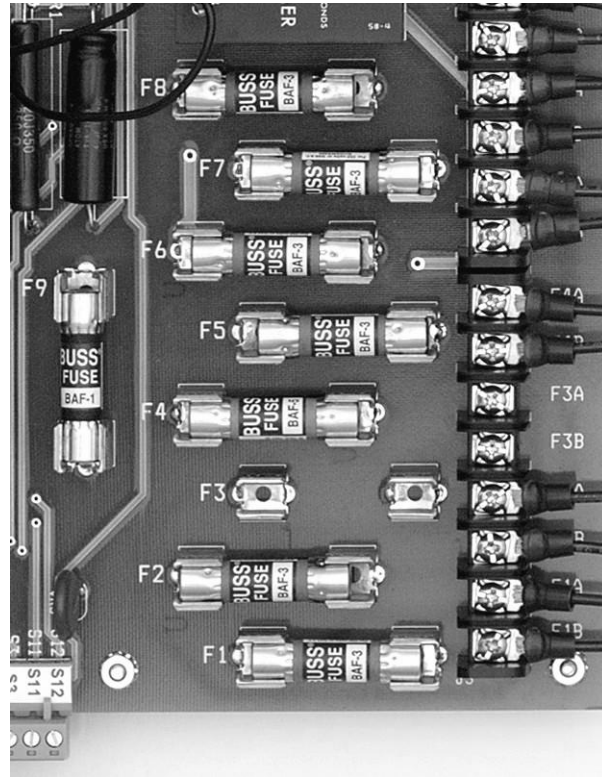

The fuse type and rating is shown on the schematic.

NOTE: Only replace fuses with fuses of the same type and rating.

6.3 12VDC Power Supply

The 12VDC Power Supply supplies 12VDC for the micro-processor.

The Power Supply has onboard circuit protection. If the output is shorted, the output will be turned off. If the Power Supply output is 0volts, remove the load from the Power Supply, then measure the output again. If the output is now 12VDC, check the load to make sure it is not shorted.

6.4 Safety Interface

The Safety Relay Interface may be provided as a printed circuit board, or as discrete surface mounted relays, or a combination of both.

The Safety Relay Interface provides interface signals to the Drive, Brake, Door Operator, and Safety String.

Refer to the schematic to see which type of interface is used.

6.4.1 Bypass Switches

The Bypass Switches bypass the Door Contacts, as required by the appropriate codes. They are only used on Inspection, and will force the car onto Inspection operation.

6.4.2 Inspection Switches

The Inspection Switches allow the elevator to be run on Inspection, in accord with the appropriate codes.

6.4.3 Phase Monitor

The unit provides protection for the pump motor by continuously measuring the voltage of each of the three phases using a microcomputer circuit designed to sense under and over voltage, voltage unbalance, phase loss and phase reversal.

A trip delay is provided to prevent nuisance tripping.

A restart delay is provided to prevent short cycling after a momentary power outage.

Upon application of line voltage, the restart delay begins. The output relay is de-energized during restart delay and the LED flashes green.

Under normal conditions, the output energizes and the LED glows green after the restart delay.

Under voltage, over voltage and voltage unbalance must be sensed for a continuous trip delay period before the output is de-energized. The output will not de-energize if the fault is corrected during the trip delay. The LED flashes red during the trip delay, then glows red when the output is de-energized.

The restart delay begins as soon as the output relay de-energizes. If the restart delay is completed when the fault is corrected, the output relay will energize immediately.

The output relay will not energize if a fault or phase reversal is sensed as the three phase voltage is applied. The LED alternately flashes green then red if a phase reversal is sensed.

Reset is automatic upon correction of a fault.

The technical characteristics of the phase monitor can be determined from the part number as follows:

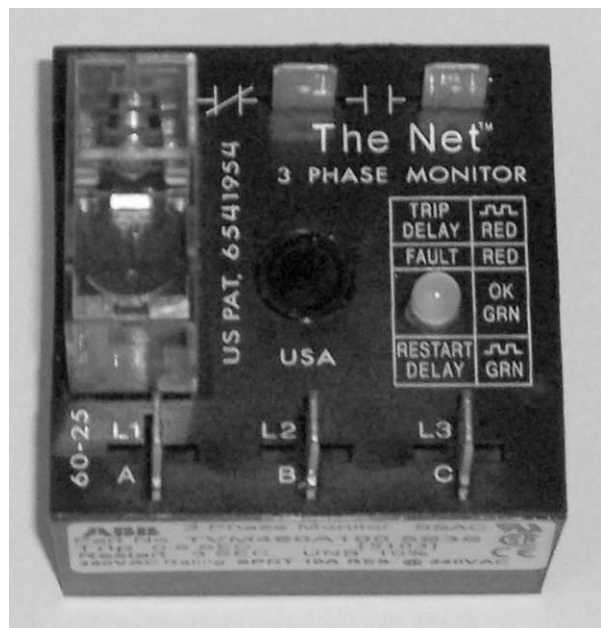

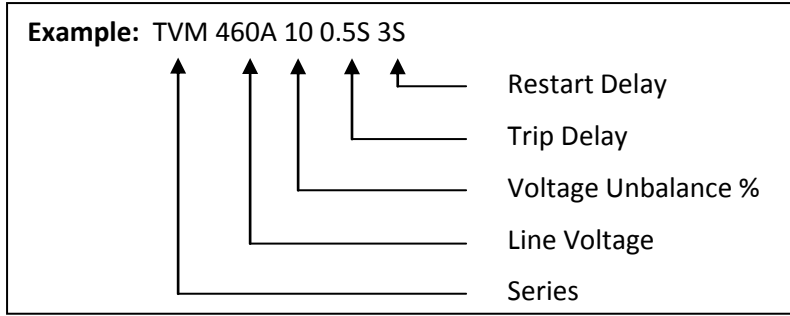

6.4.4 Digiset Timer

This unit is a universal voltage solid-state timer that will operate from 19 VAC up to 265 VAC and from 10 VDC up to 120 VDC. Any time period between 0.1 second and 102.3 seconds is available in 0.1 second increments and can be set with the dip switch.

Application of input voltage to the timer starts the time delay. At the end of the delay period, the load is energized. To reset, remove the input voltage to the timer.

To select a time period, simply add up the selected switches in the "ON" position for the total time delay in seconds.

This timer provides a delay in the Up Run circuit.

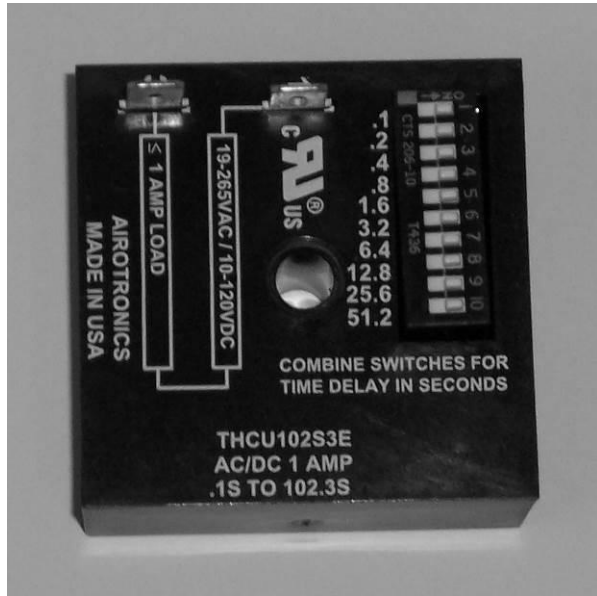

6.5 Microprocessor

6.5.1 CPU

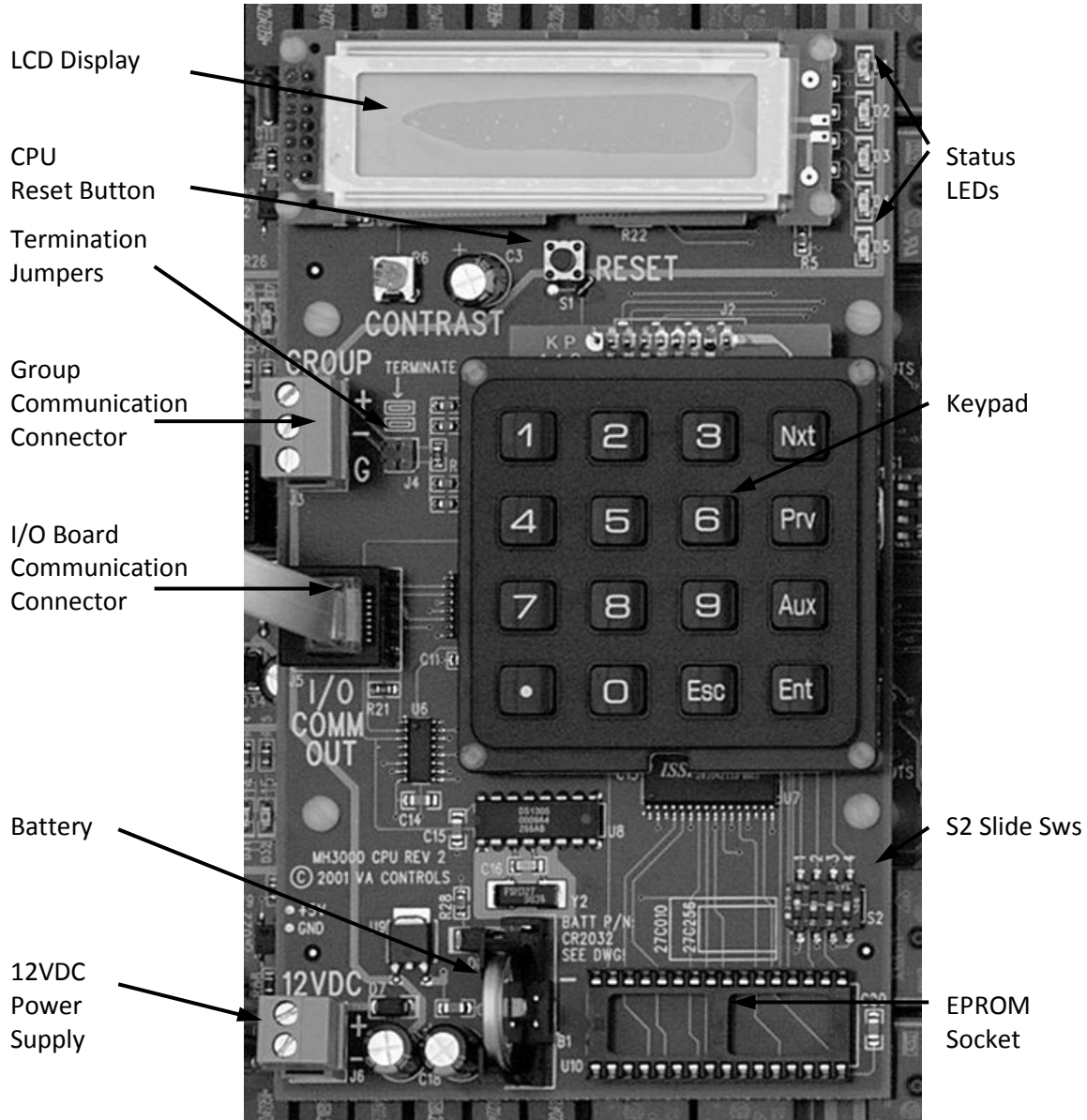

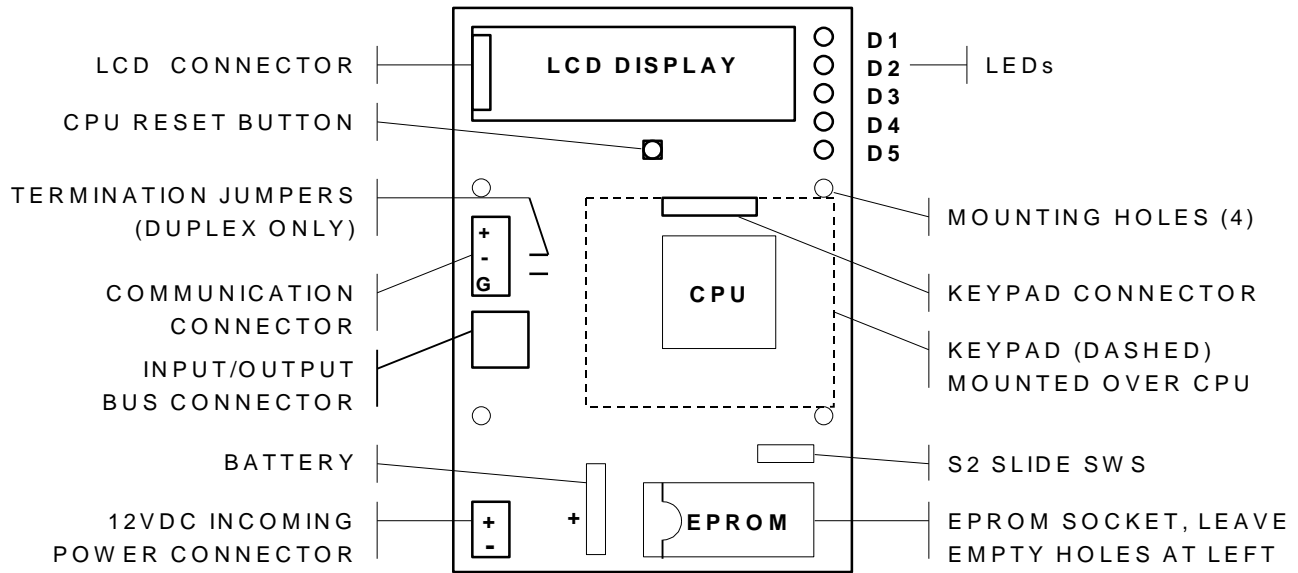

The Central Processing Unit (CPU) board contains the hardware that controls the inputs and outputs which control the elevator. This section describes the major components on the board, and the function of the connectors and LEDs.

6.5.1.1 CPU Battery

The CPU battery maintains the Real Time Clock, and also the status of key parameters and functions in the RAM memory. The battery life is approximately 5 years.

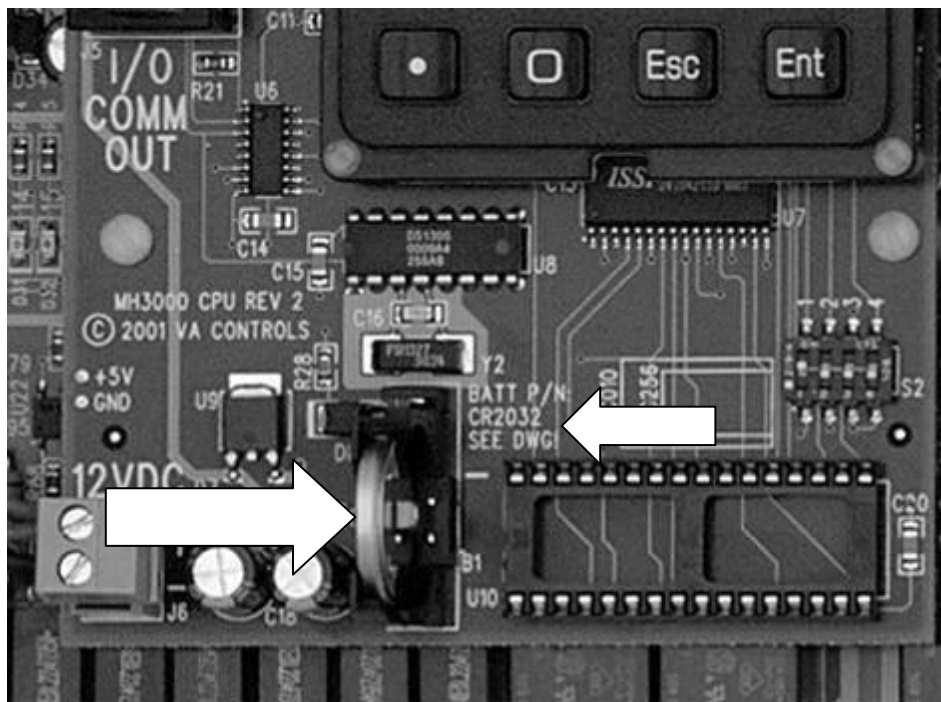

WARNING: Replace the battery with RENATA 3V Lithium battery, Part No. CR2032 Only. Use of another battery may present a risk of Fire or Explosion.

WARNING: Orient the battery properly in the battery holder. The positive side of the battery is marked on the battery, and faces towards the power connector and away from the EPROM socket.

WARNING: Do not use a metal (or conducting) device to remove or install the battery.

To replace the battery, remove the old battery by gently pushing the top of the battery towards the EPROM socket, until it is clear of the black housing, and then slide it out of the socket. Insert the new battery by sliding the edge under the metal retaining finger, then aligning it in the black housing. Be careful not to short out the battery. Dispose of the old battery properly – do NOT incinerate the battery.

6.5.1.2 LED Description

There are five LEDs located at the upper right edge of the CPU board.

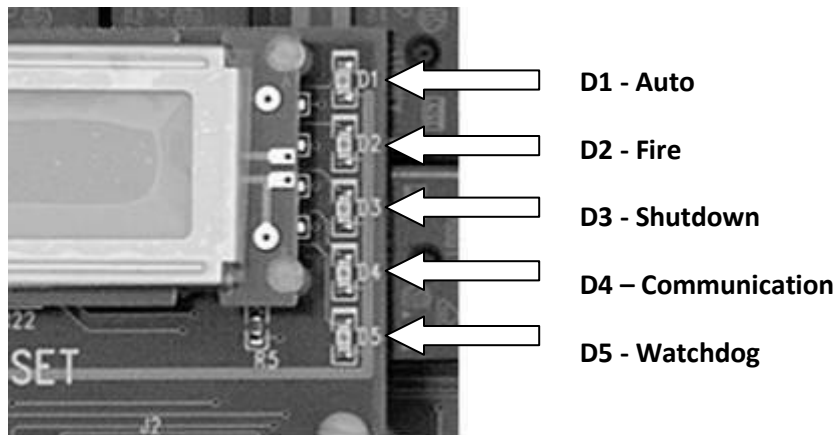

The function of these LEDs during normal monitoring is noted on the schematic. The normal description for these LEDs is as follows:

- D1 "Automatic Operation". This LED should be lit during normal operation. It will go out when the car is on Inspection Service, Independent Service, Fire Service, Low Oil Shutdown, or any other mode that will cause the car to ignore Hall Calls.
- D2 "Fire Service". This LED should be off during normal operation. It will be lit if the car is on Fire Service Phase 1 (Hall) or Phase 2 (Car).
- D3 "Shutdown". This LED should be off during normal operation. It will be lit if the Up Run timer indicated the car has been running up for a preset adjustable time without passing a floor. This could be caused by a low oil level; a problem with the motor starter circuit(s); or a problem with the up valve circuit(s). The car will stop running up, then return to the lowest landing and cycle the doors. It will then be shut down, with only the Door Open Button and door re-opening devices being operational. The fault can be reset by cycling the Main Line Disconnect Switch, or by putting the car on "Inspection" then back to "Automatic".

NOTE: If a Reverse Phase Relay or Emergency Power circuitry is supplied, these will also initiate a shutdown signal if the inputs are not energized.

- D4 "Communication Error". This LED should be off during normal operation on a Simplex. It will be lit if the CPU has failed to communicate properly with an Input/Output board. This could be caused by a loose or faulty cable between the boards, improper addressing of the I/O board(s)

(see the section on I/O board addressing), or incorrect setting of the number of I/O boards in the CPU (see the section on adjustable settings). Refer to the section on I/O Boards for a description of the communication Status LED on the I/O Board.

On Duplex or Group systems, the LED also monitors the communication with the other CPU. It will flash if the communication with the other car(s) is operating normally. If the LED stays off, then the communication has failed (see the section under Duplexing, Communication). If the LED stays on, then either the Group communication has failed, or the communication to the I/O boards has failed, as described above. Check the LEDs on the I/O boards to determine if they are communicating properly, then check the BADCOMM address as described in the Duplex Communication section.

- D5 "Watchdog". This LED will flash regularly (about once per second) if the CPU is operating properly. NOTE: The LED will flash every 10 seconds if the car is not in the run mode. If the LED stops flashing, reset the CPU by cycling the Main Line Disconnect Switch, or pressing the Reset Button on the CPU.

NOTE: If the diagnostic mode is changed to monitor the Internal Memory, or the Setup Mode is selected, then the operation of the LEDs will change, as described in the appropriate sections.

6.5.1.3 Reset Button

The Reset Button is located just below the LCD Display.



It is used to reset the CPU if a lock-up occurs (such as if LED D5 stops flashing when in the normal operating mode).

WARNING: Pressing the Reset Button will reset the CPU, causing all outputs to be turned off and the car to stop immediately.

NOTE: The Reset Button should not normally need to be used.

Pressing this Reset Button is NOT the same as doing a factory reset. The Reset Button restarts the CPU just as if the power had been cycled; whereas a factory reset will reset the settings and features to the factory default values.

6.5.1.4 CPU Connectors

6.5.1.4.1 Duplex Communication Connector

The Duplex Communication Connector is a terminal block located on the left side of the CPU board.

A shielded twisted pair is used to connect the two CPU boards together. The shield is connected to the CPU board mounting screw (which is grounded) at ONE END OF THE CABLE ONLY. The termination jumpers next to the connector are factory installed on duplex systems.

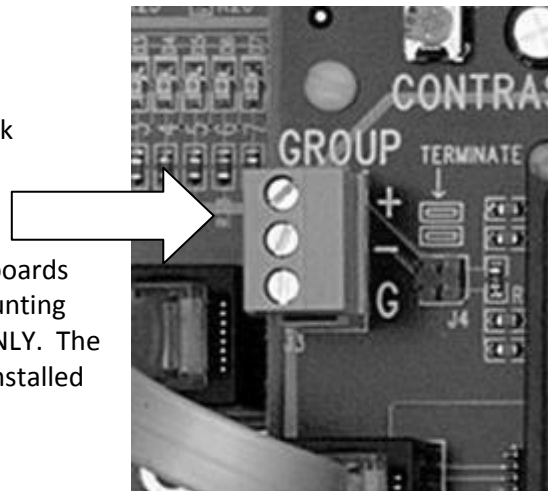

6.5.1.4.2 LCD Display Connector

The LCD Display Connector is located at the top left of the CPU board.

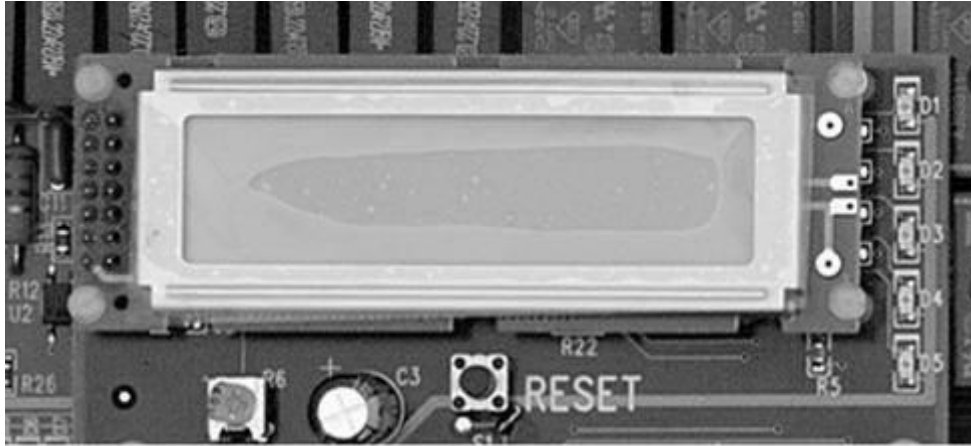

The LCD display is mounted directly on the connector. The LCD display can be removed for replacement. If it is removed, then set switch 1 on the Slide Switch S2 to the OFF position before turning the power back on. This will ensure the CPU does not try to write to the LCD screen while it is removed. It is recommended that the LCD display AND the Keypad be removed together, since if the LCD display only is removed, and the keypad is activated, the CPU will probably lock up. Make sure the power is turned OFF before removing either the keypad or the LCD display.

6.5.1.4.3 Keypad Connector

The connector for the Keypad is located behind the keypad. The connector is an 8-pin connector. If the keypad is removed, make sure the connector is lined up properly when replacing the keypad. Make sure the power is OFF when removing or installing the keypad.

6.5.1.4.4 Incoming Power Connector

The Incoming Power Connector is a terminal block located in the bottom left corner of the CPU board.

The incoming power is 12VDC from the power supply located near the CPU.

If the CPU board is replaced, the incoming power wires must be connected to the correct terminals. The upper terminal is "+" and the lower terminal is "-". The connector is shaped so that the mating terminal plug cannot be inserted upside down.

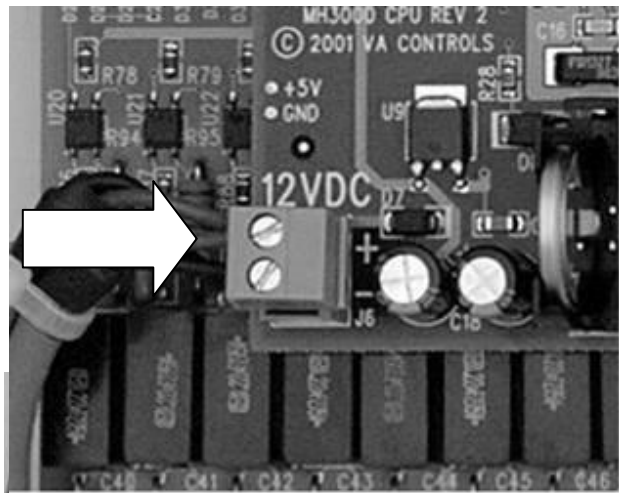

6.5.1.4.5 Input/Output Bus Connector

The Input/Output Bus Connector is on the left of the CPU board.

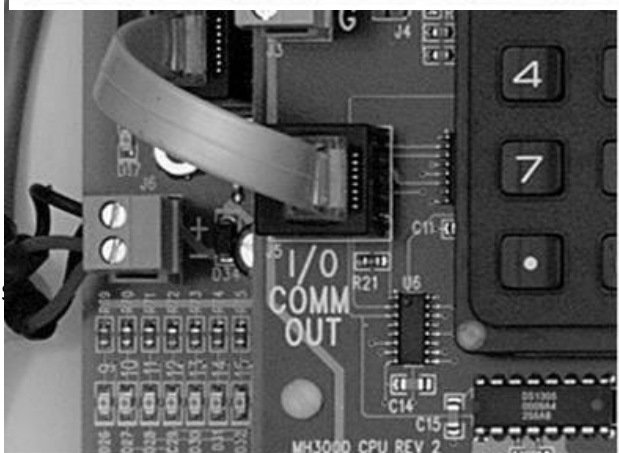

An RJ45 style cable is used to connect to the first I/O board.

The other I/O boards are connected to each other using a daisy chain method, with the CPU connecting to the I/O COMM IN of board #1, then the I/O COMM OUT of board #1 connects to I/O COMM IN of board #2, and so on for all I/O boards.

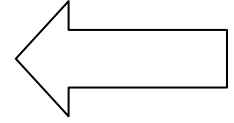

6.5.1.5 S2 Slide Switch

The S2 Slide Switch is used to set various operating modes or features in the CPU. It is located on the lower right of the CPU board, just above the program chip.

Currently only the first and third switches are used. If the other switches are assigned a particular function, this will be indicated on the paperwork for the particular job.

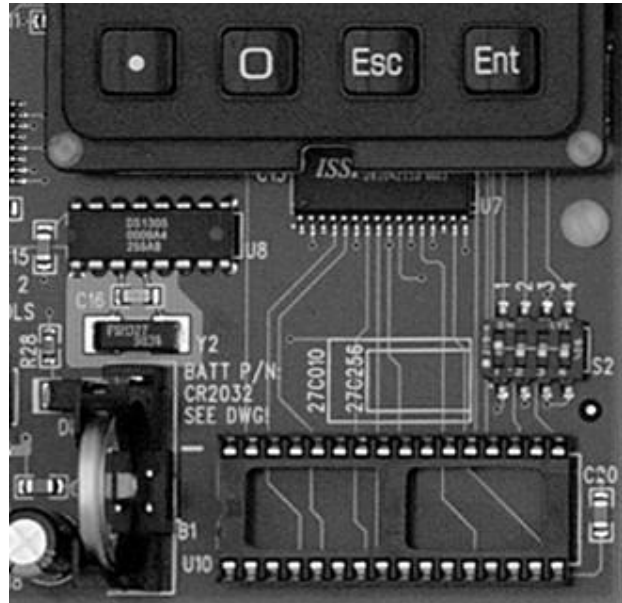
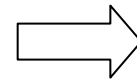

6.5.1.5.1 Switch 1 on S2 Slide Switch

If switch 1 is ON, then the LCD Display will show the “Car Status” screen on power up.

If switch 1 is OFF, then the LCD Display will be blank on power up. To activate the display and show the “Car Status” screen, press any key. This mode should be used if the LCD is to be removed for any reason. It is recommended that if the LCD Display is removed that you also remove the keypad, since pressing a key with the LCD removed could lock up the CPU as it attempts to write to the LCD Display.

6.5.1.5.2 Switch 3 on S2 Slide Switch

If switch 3 is ON, then the Redundancy Fault Defeat is enabled. This will prevent a fault from the Redundancy checks, or a Door Zone Fault. This can be used during initial installation to allow the car to be run without generating these faults. As a reminder to turn the defeat off after installation, the Fire Audible Visible will be enabled.

If switch 3 is OFF, then the Redundancy Faults will function as normal.

6.5.2 Input/Output Boards

Refer to the picture or diagram of the IO boards shown below to identify the key components.

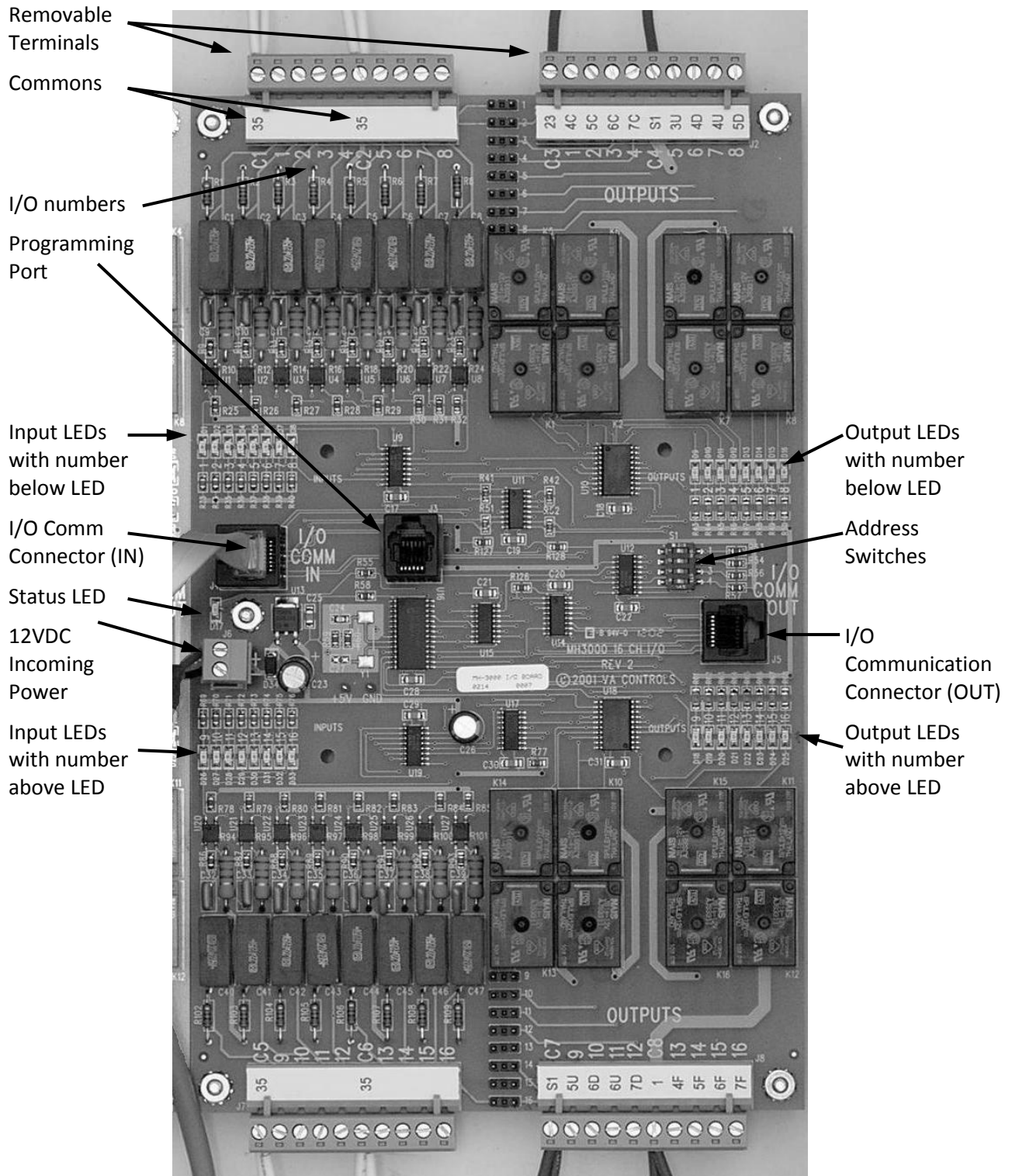

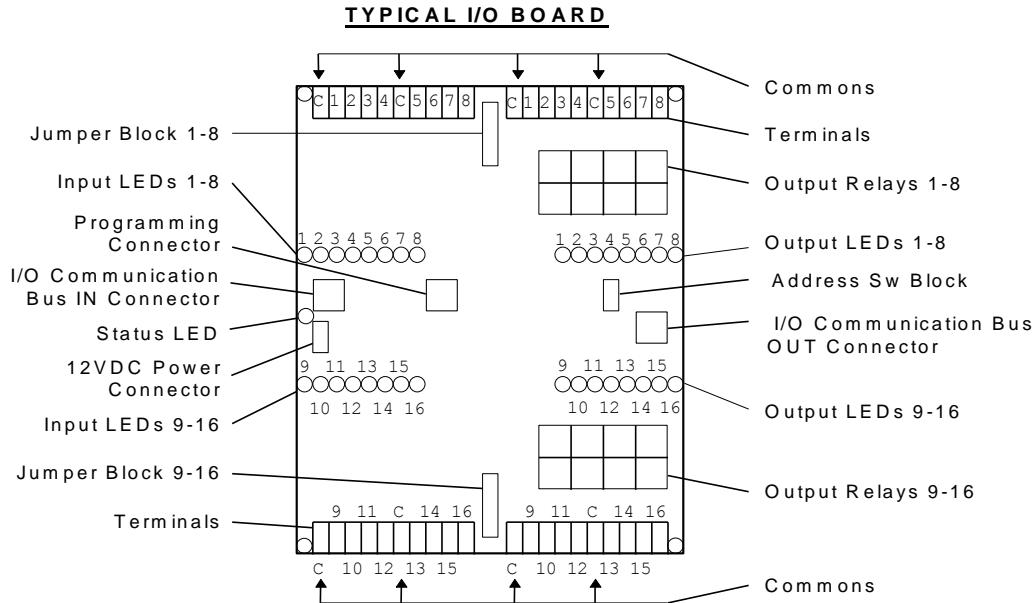

Input/Output boards are used to connect the CPU with the field devices. All inputs (unless otherwise stated) are 115VAC, and outputs (unless otherwise stated) are dry relay contacts.

The boards are available as 16-Input and 16-Output boards, or 16-Input and no outputs.

All inputs and outputs have individual LED indicators.

Wiring is done to the removable terminal blocks at the top and bottom of the I/O boards.

Fuses are provided externally, not on the I/O boards.

6.5.2.1 Addressing

Each Input/Output board is given a unique address by means of the Address Switch Block on the right of the board, next to the I/O COMM OUT Connector. The first board connected to the CPU is address 1, the next is address 2, and so on. The numbering is consecutive, and no numbers are skipped. To set the address, refer to the chart below. ON indicates the switch is set to the right, OFF indicates the switch is set to the left, as indicated on the switch itself.

Picture at right shows DIP Sw. 1 to the right, and all the others to the left, which is the address for Board 1, as shown in the table below.

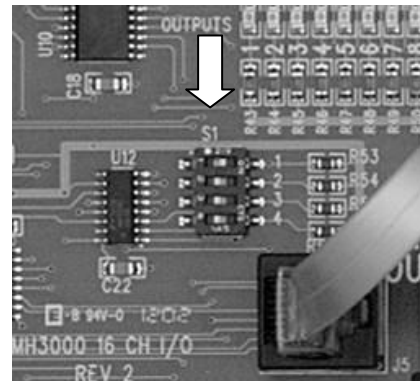

Board #	Sw. 1	Sw. 2	Sw. 3	Sw. 4
1	ON	OFF	OFF	OFF
2	OFF	ON	OFF	OFF
3	ON	ON	OFF	OFF
4	OFF	OFF	ON	OFF

Board #	Sw. 1	Sw. 2	Sw. 3	Sw. 4
5	ON	OFF	ON	OFF
6	OFF	ON	ON	OFF
7	ON	ON	ON	OFF
8	OFF	OFF	OFF	ON

NOTE: If a board is replaced, the board must be set up with the SAME ADDRESS as the board it was replacing. The address of each I/O point is determined by the Board Number (1 through 8), then the Point Number (1 through 16). The board number is used in the "Show I/O" screen to indicate which board is being monitored.

6.5.2.2 Terminal Wiring

Wiring to Inputs 1-8 is at the TOP LEFT of the I/O board, wiring to the Outputs 1-8 is at the TOP RIGHT of the I/O board. Wiring to Inputs 9-16 is at the BOTTOM LEFT of the I/O board, wiring to the Outputs 9-16 is at the BOTTOM RIGHT of the I/O board.

The terminal blocks are removable, so BEFORE power is applied, remove the terminal blocks and check for grounds at the terminal blocks.

Note also the location of the COMMONS, as shown on the schematic. The far left terminal is the common for the four I/O points to its immediate right, and the sixth terminal from the left is the common for the four I/O points to its immediate right.

WARNING: Be very careful not to jump to a common when you intended to jump to an input or output, as this could damage the controller or other equipment.

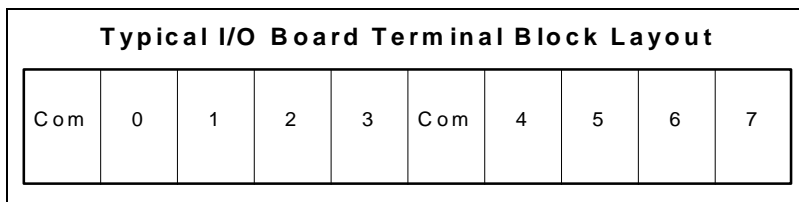

6.5.2.3 Input/Output LEDs

Each Input and Output point has its own LED indicator. These are located towards the center of the board, and are on the low voltage/CPU side of the optical isolator in the I/O circuitry.

6.5.2.3.1 Input/Output Naming Conventions

Each Input or Output is mapped to a specific address in the CPU. The address of each Input/Output point is based both on the address of the board and on the location of the point on the board.

The address of each I/O point is determined by the Board Address (1 through 8) and the Point Number (1 through 16). This address is used in the Monitor I/O Menu to show the I/O status.

The Board Address is set by the Address Switch Block S1, as described above. The point number is 1 to 8 starting from the left, for the top group, and 9-16 starting from the left, for the bottom group. The point numbers are silk-screened on the board adjacent to the actual LEDs for each point. The LEDs have a "D"

number silk-screened next to the LED. This is a component identifier, and does not correspond to their address. The address number is the slightly larger number between the LED and its resistor. Each LED point number corresponds to the point number by the terminal blocks.

6.5.2.4 Board Status LED

The Status LED located next to the I/O COMM IN connector shows the status of the board. It will flash regularly, and the number of flashes indicates its mode of operation.

Flashes	Mode of Operation
One	Normal operation
Two	Communication Failure. The board is not communicating with the CPU. This could be because the CPU is in Setup Mode, or a cable is defective or disconnected.
Three	Bad Address. Check the Address Switches.
Four	Bad Data. Check the cables. Noise is probably being induced in the wiring.

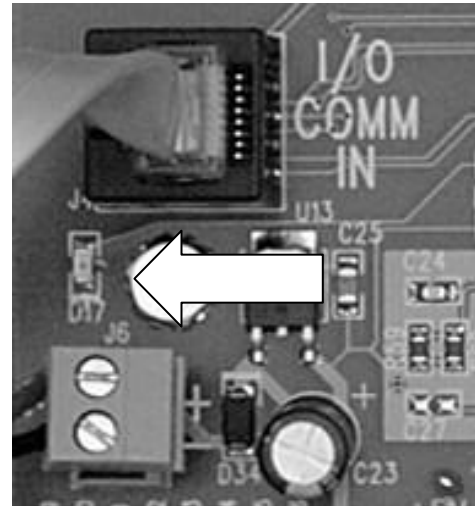

6.5.3 I/O Board Connectors

6.5.3.1 I/O Bus Communication Connectors

The connector on the left of the I/O board is for the I/O bus from the CPU board.

It is connected in a daisy chain from the CPU to the I/O boards. The I/O COMM OUT on the CPU is cabled to the I/O COMM IN of the first I/O board. The I/O COMM OUT of that board connects to the I/O COMM IN of the next board, and so on.

The addresses of the boards must correspond to their position in the daisy chain.

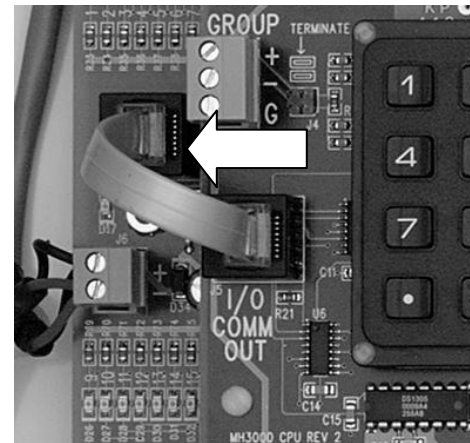

6.5.3.2 Programming Connector

This connector is used to program the microprocessor on the I/O board. It is not used once the I/O board is programmed.

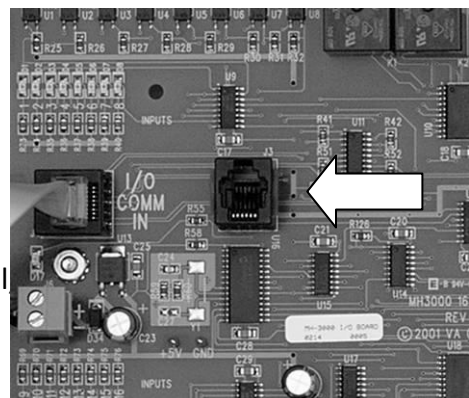

6.5.3.3 Power Connector

This connector supplies 12VDC to the I/O board.

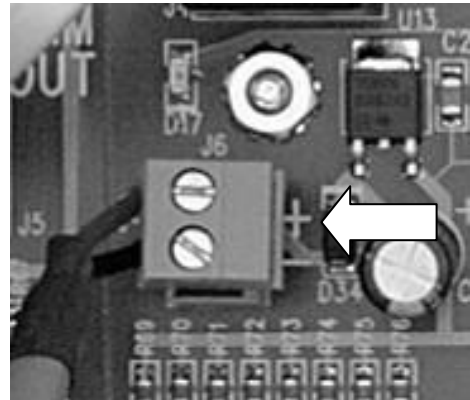

6.5.3.4 Jumper Blocks

Two sets of jumper blocks are provided in the upper middle, and lower middle of the board. They allow the inputs and outputs to be jumped together.

The silk-screening by the jumpers indicates which points are connected to which pins.

Putting a jumper block on two horizontally adjacent pins is the same as putting a jumper from the output point to the same numbered input point.

For example, a jumper placed on the pins labeled “3” would jump input point 3 to output point 3.

WARNING: When an input and output are jumped together, always connect the field wiring to the OUTPUT terminal. Do NOT connect the field wiring to the Input terminal, as this could overload the wiring on the board.

Inputs and outputs are normally connected together on the car and hall call buttons and lights.



NOTE: If a board is replaced, the board must be set up with the SAME JUMPERS as the board it was replacing.

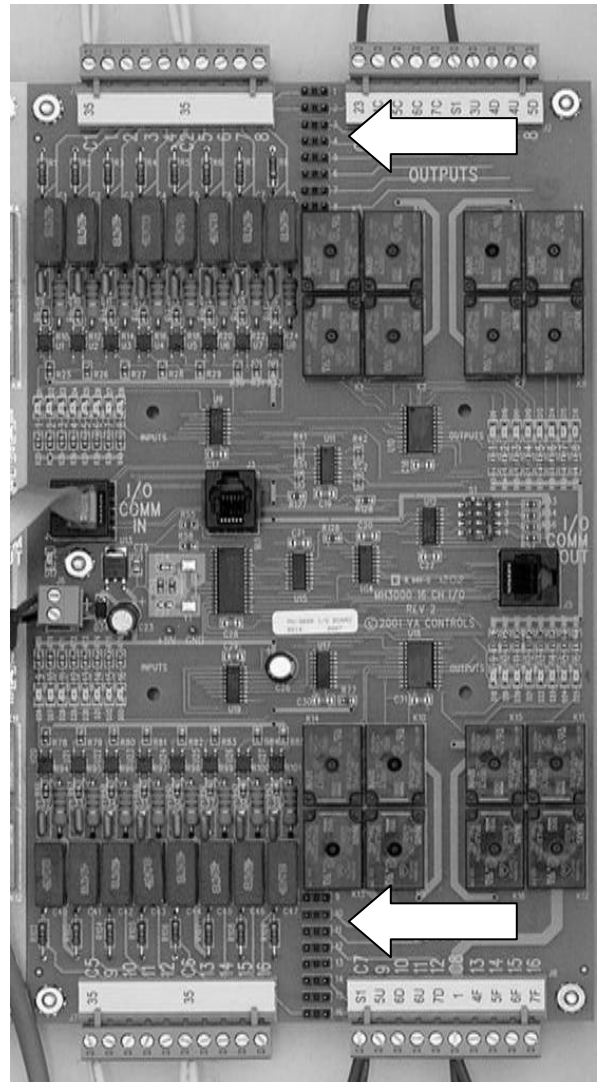

6.6 ETSD Monitoring System

The ETSD board by Virginia Controls is a hardware system for traction elevator controllers that provides a level of redundancy for a specific set of control functions required by the A17.1 Safety Code for Elevators and Escalators.

These functions are accomplished by three control sub-systems that are combined into a single ETSD Board. The three individual ETSD Board sub-systems are known as:

1. Unintended Car Movement (UCM) System
2. Over-Speed (O-S) System
3. Emergency Terminal Stopping Device (ETSD) System

The elevator controller micro-processor verifies the operational integrity of each of these three sub-systems.

The ETSD Monitoring System includes:

1. ETSD Printed Circuit Board
2. Speed (Photo) Sensor &
3. Sensor Mounting Bracket
4. Sensor Cable (30Ft/10m)
5. Striped ETSD Adhesive Tape

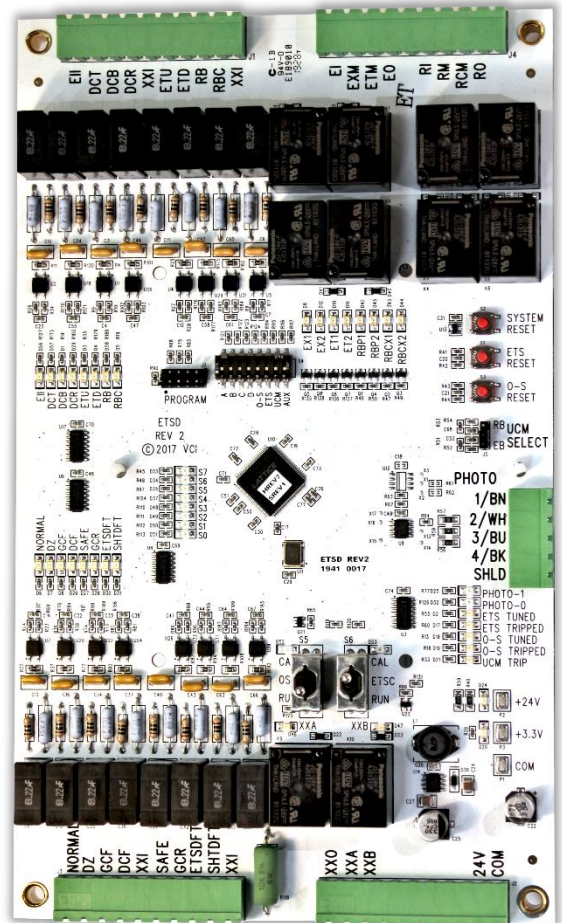

Figure 22 - ETSD Monitoring System

6.6.1 Unintended Car Movement (UCM) System

6.6.1.1 Requirements for UCM System

The ASME A17.1 Safety Code for Elevators, under section *Unintended Car Movement Protection*, requires a traction elevator controller be equipped to detect uncontrolled movement by the elevator away from a landing for any reason while the elevator doors are open. Upon detection, the required braking device is activated. It may act directly on the elevator ropes or on the drive sheave. This system must meet the following requirements:

- It activates if the elevator leaves the door zone of a landing, and both car and hoistway doors are open, whether on Normal operation or on Inspection.
- If the UCM System requires power for operation, then the loss of power results in the application of the UCM braking device.
- When activated, the elevator shall not be restored to operation until the UCM system is manually reset.

NOTE: Cycling power is not considered a valid reset.

- If activated, the UCM System may remove power from machine motor & brake.
- The braking device may be applied (not activated) to a stopped elevator, and may be applied (not activated) when an Electrical Protective Device (EPD) is opened.
- The UCM System is classified by code as an Electrical Protective Device (EPD).

6.6.1.2 Description of UCM System

1. The UCM System mimics in hardware what the controller micro-processor performs in software using a small number of control signals shared between them.
2. When operating, Relays ETSD Board RBP1 & RBP2 energize +1.0 second after power-up. ETSD Board Relays RBCX1 & RBCX2 remain de-energized until integrity checking is initiated.
3. If the car should move out of the door zone with its gate and hall door open, the UCM system will release Relays RBP1 & RBP2 causing a UCM System fault and setting the braking device.

4. A UCM System fault occurs in one of two specific situations, one occurring while on Normal operation and the other occurring while on Inspection.

- a. When the elevator is on Normal operation and in the Door Zone, if the Gate and Hall Door Contacts have opened and remain open and Door Zone Input is lost, the UCM System faults.
 - b. When on Inspection, if the Gate and Hall Door Contacts have opened and remain open, the Safe Input is high ("P" Contactor is released), and elevator speed exceeds 2.5FPM for 1.0 second, the UCM System faults.
5. When faulted, the UCM System lights the "UCM TRIP" LED. A UCM System fault is latched through a power loss until reset.

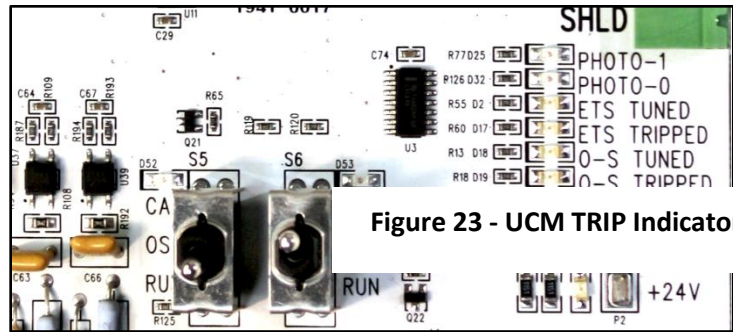

Figure 23 - UCM TRIP Indicator

6. The UCM System resets when ETSD Board Input SHTDFT goes high with power on.

NOTE: ETSD Input SHTDFT defeats the UCM System if jumped at power-up, then left in place. It does not reset a UCM System fault at power-up. Use only during construction.

7. The operational integrity of the UCM System is checked prior to leaving a landing when on Normal operation, and is performed differently for Rope Brake operation versus Emergency Brake operation.
8. When equipped for Rope Brake operation, the controller is provided with Relays: RB, RBX & RBC, from which UCM System Inputs RB & RBC synchronize the integrity checking of UCM System Relays: RBP1, RBP2 & RBCX1, RBCX2.
- a. To start, the micro-processor energizes controller Relay RBC causing UCM System Input RBC to go high, which prompts the UCM System to energize Relays RBCX1 & RBCX2 causing TB-RCM, as monitored by the processor to go high.
 - b. Next, the micro-processor releases controller Relays RB & RBX causing UCM System Input RB to go low. This prompts the release of UCM System Relays RBP1 & RBP2 causing UCM System TB-RM, as monitored by the processor to go low indicating proper operation of these UCM System relays.
 - c. This done, the micro-processor re-energizes controller Relays RP & RPX causing UCM Input RB to go high, prompting the UCM System to re-energize Relays RBP1 & RBP2.
 - d. Lastly, the micro-processor releases controller Relay RBC causing UCM Input RBC to go low, prompting the UCM System to release Relays RBCX1 & RBCX2 causing UCM System TB-RCM, as monitored by the processor to go low indicating proper operation of these UCM System relays.

9. When equipped for Emergency Brake operation, there are situations where the controller is permitted to release the Emergency Brake due to lack of demand or due to the machine manufacturer's specifications for the Emergency Brake itself. In this case, the controller is not provided with Relays RB, RBX & RBC, therefore integrity checking of the UCM System is initiated by controller micro-processor Output RBC.
 - a. To start, UCM System Input RBC, which is connected to micro-processor Output RBC, goes high when integrity checking is initiated, prompting the UCM System to energize Relays RBCX1 & RBCX2 causing TB-RCM, as monitored by the processor, to go high.
 - b. After a brief timed interval, the UCM System releases Relays RBP1 & RBP2 causing TB-RM, as monitored by the processor, to go low indicating proper operation of these UCM System relays.
 - c. After another brief interval, the UCM System re-energizes Relays RBP1 & RBP2.
 - d. After a final brief interval, the UCM System releases Relays RBCX1 & RBCX2 causing TB-RCM, as monitored by the processor to go low indicating proper operation of these UCM System relays.
10. Deviation from these integrity checking sequences will result in a UCM System Redundancy fault.
11. If the micro-processor detects both its inputs at terminal blocks: RM & RCM of the ETSD Board are low, then it logs a fault of the UCM System.

6.6.2 Over-Speed System (O-S) System

6.6.2.1 Requirements for O-S System

The ASME A17.1 Safety Code for Elevators, under section *Control and Operating Circuits*, states that a failure of a software system designed without a SIL rating in circuits that control car speed while Leveling with doors open, or while operating on Inspection or Hoistway Access, shall not permit elevator speed to exceed 150fpm. A system, known as the Over Speed or O-S System, satisfies the safety code by meeting the following requirements:

- This system is not defined in the code as an Electrical Protective Device (EPD), but is described in virtually identical terms.
- A hardware-based system is then used to monitor and limit car speed.

6.6.2.2 Description of O-S System

1. The O-S System provides the electronic hardware and a speed (photo) sensor, which is aimed at a striped adhesive tape affixed to the machine drive sheave, to monitor elevator speed without the need to determine elevator direction.
2. This speed monitoring hardware is also used by the ETSD System (required above 200fpm), which is calibrated at a higher percentage of contract speed.
3. The O-S System is calibrated at and operates with a 150fpm threshold.
4. When provided, the High Speed Counter of the controller processor is retained as a software-based backup to the O-S System. It is calibrated at a lower speed so that it will act first.

NOTE: The High Speed Counter of the controller processor is calibrated at a 125FPM threshold for Inspection and at a 50FPM threshold while Leveling with doors open.

5. When tuned and operating and if Input EII is high, the O-S System energizes Relays EX1 & EX2 at +1.0 seconds after power-up. The O-S System also energizes Relays ET1 & ET2 when the controller is on Normal operation and out of Door Zone, or when on Normal operation and in the Door Zone with doors closed.
6. The O-S System releases Relays ET1 & ET2 when on Normal operation (Input NORMAL is high) and the elevator has been sitting in the Door Zone, and Gate and Door Contacts are open, and remain open, with the Safe Input low (Drive is enabled) for 1.0 second. Relays ET1 & ET2 are de-energized while on Inspection.
7. During either of these two conditions, if 150FPM is exceeded, ETSD Board Relays EX1 & EX2 de-energize, opening the safety string and causing the O-S System to fault.
8. When faulted, the "O-S TRIP" LED lights and latches UCM System Relay XXA, Low Speed Monitor.

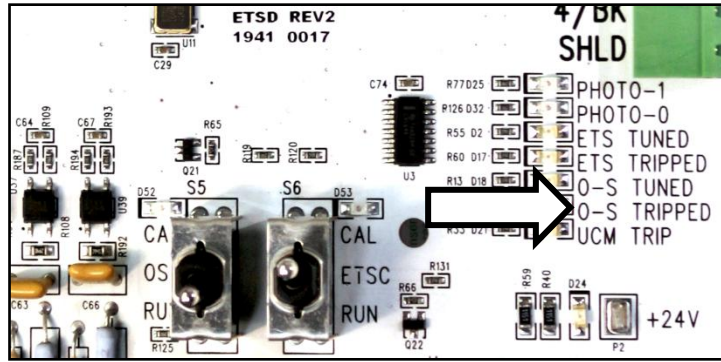

Figure 24 - O-S TRIP Indicator

NOTE: O-S System faults are latched through a loss of power.

- An O-S System fault resets via the “O-S RESET” Push Button or by re-tuning.

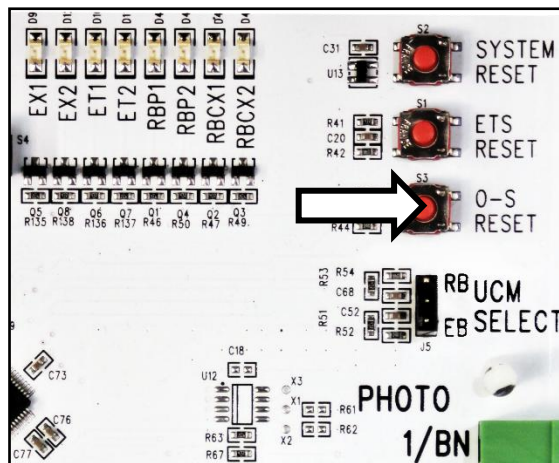

Figure 25 - O-S RESET Push Button

NOTE: If the O-S System is re-tuned, the ETSD System must be re-tuned also.

- For troubleshooting, a tuned O-S System can be defeated by putting the “OSC” Calibration Switch into the “CAL” position while power is applied.

NOTE: Do not cycle power with “OSC” Switch in “CAL” position, or O-S System calibration will be lost!

- A tuned, but defeated O-S System maintains ETSD Board Relays EX1 & EX2 regardless of car speed. ETSD Relays ET1 & ET2 function normally per the previous description.
- A tuned O-S System energizes its Relay XXA when car speed exceeds 150FPM. This output serves as “Low Speed Monitor” or LSM Input for the controller processor.
- The operational integrity of the speed monitoring system is checked as the controller processor verifies that Input LSM (O-S System Relay XXA) energizes when car speed exceeds 150FPM and de-energizes when car speed drops below 50FPM.

14. The operational integrity of ETSD Board Relays ET1 & ET2 is checked as the controller processor verifies ETSD TB-ETM goes low (i.e.: Relays ET1 and ET2 drop) when on Inspection or on Normal operation while Leveling with doors open.
15. When the controller processor Input ETSD is energized, then the operational integrity of the O-S System (ETSD Board Relays: ET1, ET2 & Output XXA) is not checked.
16. If the controller processor detects both its inputs at ETSD terminal blocks: EXM & ETM are low, and its Input LSM is high, then it logs a fault of the O-S System.

6.6.3 Emergency Terminal Slowdown Device (ETSD) System

6.6.3.1 Requirements for ETSD System

The ASME A17.1 Safety Code for Elevators, under section *Emergency Terminal Stopping Device*, requires a traction elevator with static control and a contract speed over 200FPM to have a speed and position monitoring system that stops the car when excessive speed is detected as the elevator approaches a terminal landing. This system, known as the Emergency Terminal Stopping Device or ETSD System, has the following code requirements:

- It is activated in response to a failure of both the normal stopping means and the normal terminal stopping device to slowdown and stop the elevator at or near a terminal landing.
- The ETSD System must function independently of the normal terminal stopping device and the normal speed control system.
- When activated, the ETSD System shall remove power from the driving machine motor and brake without regard for where the elevator comes to a stop.
- The general intent of this system is to prevent the car or counterweight from running onto their buffers at or above contract speed.
- The ETSD System is classified by code as an Electrical Protective Device (EPD).

6.6.3.2 Description of ETSD System:

1. The ETSD System requires a speed monitoring system with inputs for a set of hoistway switches that signal when the elevator approaches a terminal landing.
2. The speed monitoring hardware is provided for and shared with the O-S System where it is calibrated at the lower speed of 150FPM.
3. In the case of the ETSD System, the calibration speed is 90% of contract speed whenever contract speed is greater than 200FPM.
4. The ETSD System verifies that the elevator has slowed down to 90% of its contract speed with 50% or half of its slowdown distance remaining per the placement of Up & Down ETS Switches at terminal blocks: 31X & 32X.

Table 2 - Recommended ETS Switch Placement (one N.C. switch per terminal & direction)

Car Speed (FPM)	Switch Placement
225	2'-3"
250	2'-6"
300	3'-6"
350	4'-3"
400	5'-3"
450	6'-6"
500	7'-6"

5. Minimum ETS Switch Cam lengths are 6ft for 200-500FPM to provide approximately 0.5 seconds of dwell time. ETS Switches may also be maintained to the Final Limit Switch as most cam lengths are the height of the car.

6. When tuned and operating and if Input EII is high, the ETSD System energizes Relays EX1 & EX2 at +1.0 seconds after power-up. The ETSD System also energizes Relays ET1 & ET2 when the elevator is on Normal operation (Input NORMAL is high) and Inputs ETU & ETD are high – elevator is both off ETS Switches in hoistway near the terminal landings.
7. ETSD Board Relays EX1 & EX2 remain energized until car speed exceeds 90% of contract speed at which time they are released causing the safety string to be subject to Relays ET1 & ET2. Relays EX1 & EX2 re-energize just below 90% of contract speed.
8. ETSD Board Relays ET1 & ET2 remain energized until the elevator rides onto one of the ETS Switches near a terminal landing causing either Input ETU or Input ETD to go low.
9. On a “typical” full speed run into a terminal landing, the elevator decelerates below 90% of contract speed before it encounters an ETS Switch. This allows Relays EX1 & EX2 to re-energize before Relays ET1 & ET2 release. (Refer to Sht.”VNE” of Drawings.)
10. On an “over-speed” run into a terminal landing (+90% of contract speed with just 50% of slowdown distance remaining), Relays EX1 & EX2 stay released while over 90% of car speed. Then, as an ETU or ETD Switch is encountered, Relays ET1 & ET2 are released, opening the safety string and causing an ETSD System fault.
11. When faulted, the “ETS TRIP” LED lights.

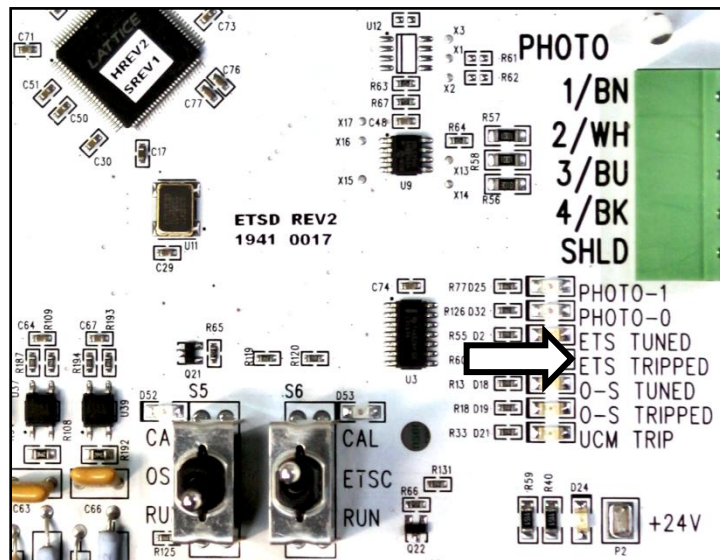

Figure 26 - ETS TRIP Indicator

NOTE: ETSD System faults are latched through a loss of power.

12. An ETSD System fault resets via the “ETS RESET” Push Button while on Normal operation or by re-tuning.

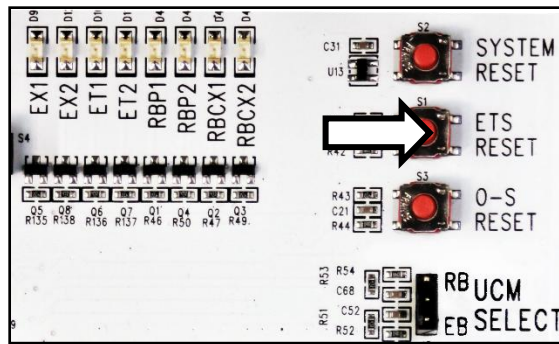

Figure 27 - ETS RESET Push Button

NOTE: The ETSD System must be re-tuned, if the O-S System is re-tuned.

13. For troubleshooting, a tuned ETSD System can be defeated by putting the “ETSC” Calibration Switch into the “CAL” position, or by putting the controller on Inspection operation.
14. A tuned, but defeated ETSD System maintains Relays ET1 & ET2, regardless of Inputs ETU & ETD. Relays EX1 & EX2 remain subject to car speed to aid in trouble-shooting.
15. The operational integrity of the ETSD System is continuously checked by the controller processor per the following.
16. The operational integrity of ETSD System Relays EX1 and EX2 is checked as the controller processor verifies ETSD TB-EXM goes low (i.e. Relays EX1 & EX2 drop) when car speed is over 90% of contract speed on Normal operation.
17. The operational integrity of ETSD System Relays ET1 and ET2 is checked as the controller processor verifies that ETSD TB-ETM goes low (i.e., Relays ET1 and ET2 drop) when the elevator encounters an ETS Switch (i.e. Input ETU or Input ETD goes low) in the hoistway while approaching a terminal landing on Normal operation.
18. Likewise, the controller processor verifies that ETSD TB-ETM is high (i.e., Relays ET1 & ET2 energized) when off both ETS Switches (i.e. Inputs ETU & ETD are high).
19. When provided, the High Speed Counter of the controller processor provides a redundant software-based ETSD System using the same ETS Switch Inputs, and using the motor mounted encoder to determine car speed.
20. ETS Switches, at TB-31X & TB-32X, are checked by the controller processor at known landing positions. If these switches fail to open when the car slows down and stops at a terminal landing, an ETSD Hardware Fault occurs.
21. When controller processor Input ETSD is energized, then the operational integrity of Relays EX1, EX2 & ET1, ET2 of the ETSD System is not being checked along with that of ETS Switch Inputs ETU/TB-31X and ETD/TB-32X.
22. If the controller processor detects both its inputs at ETSD terminal blocks: EXM & ETM are low, and its Input LSM is low, then it logs a fault of the ETSD System.

6.6.4 ETSD Monitoring System Routine Maintenance

1. Check the ETSD Tape for dirt, oil or grease. If present, wipe gently with a clean soft cloth until removed. Replace the tape if it becomes damaged.
2. Check the lens of the Speed Sensor for dust & dirt. If present, wipe gently with a clean soft cloth until removed.
3. Check the alignment and focus of the Speed Sensor light beam. It should appear in the center of the ETSD tape as a bright red dot approx. 1/16" in diameter. If otherwise, see the "Setup of the O-S System" Section 5.11.2 for mounting, aligning and adjusting the Speed Sensor.
4. Check the "+24V" & "+3.3V" LED's on the ETSD Board. If not lit, check the "+24V" & "COM" and "+3.3V" & "COM" Test Points, and then the 24V & COM terminals on the ETSD Board (See Figure 30 below).



Figure 28 - ETSD Tape



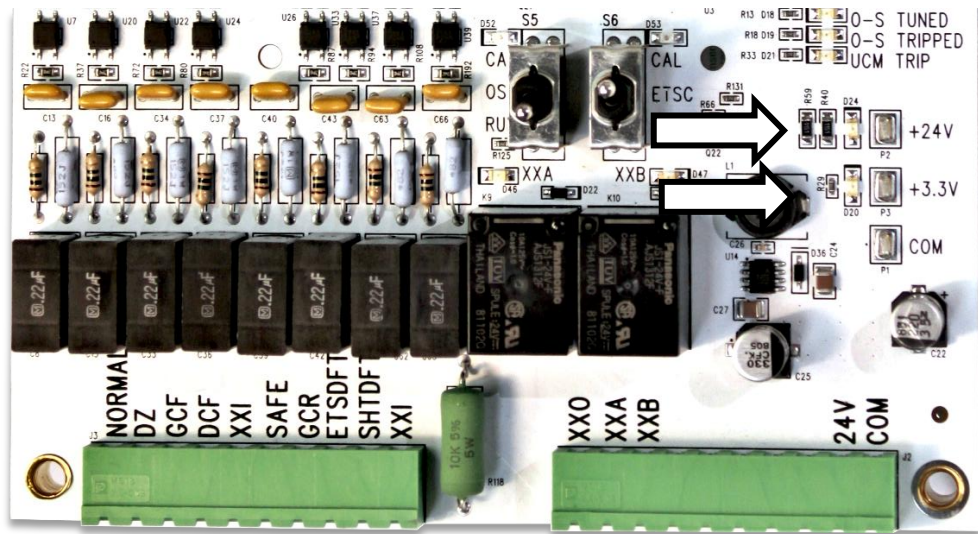

Figure 30 - +24V & +3.3V LED Indicator Test Points and Supply Terminals

Figure 29 - Speed Sensor

5. Check for the green "POWER" LED on the Speed Sensor. If not lit, check "PHOTO" Connector terminal blocks 1/BN (+24V) & 3/BU (COM) for 24VDC.

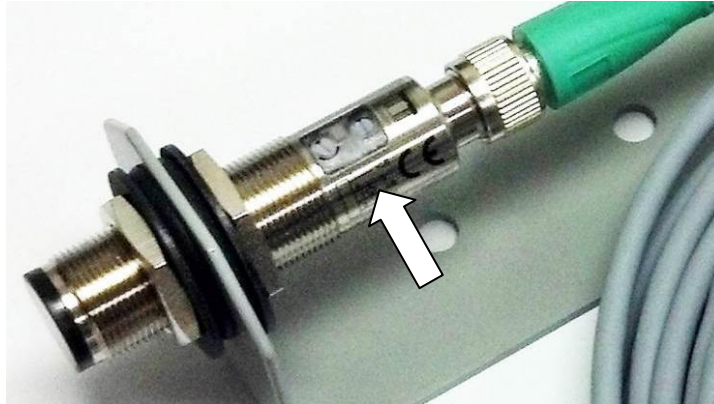

Figure 31 - Sensor POWER LED Indicator

6. Check that the yellow "SENS." LED of the Speed Sensor and "PHOTO- 1" LED on ETSD Board operate in unison, and that both are lit on a "White" segment of the ETSD Tape. If otherwise, see "Setup of the O-S System" Section 5.11.2 for Speed Sensor adjustment.

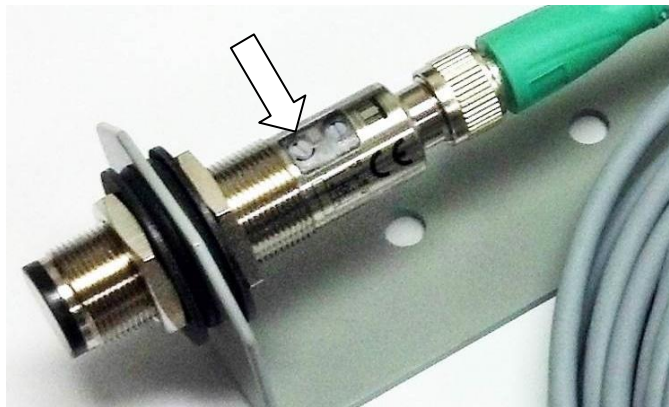

Figure 32 - Sensor SENS. LED Indicator

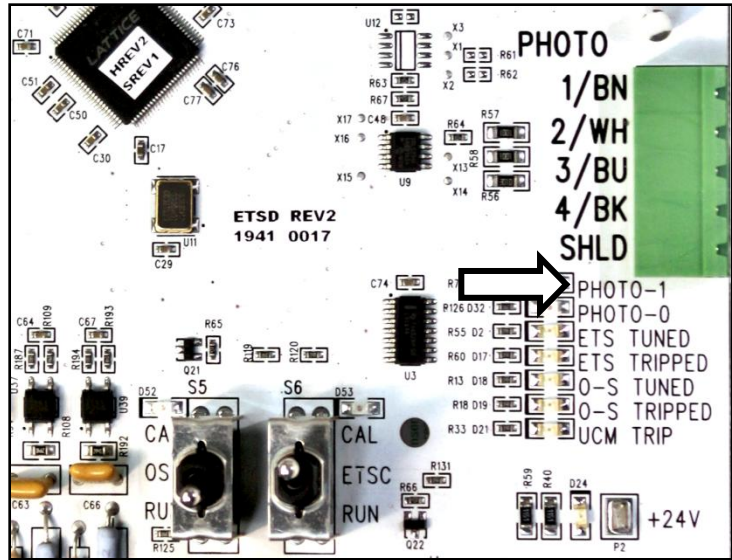
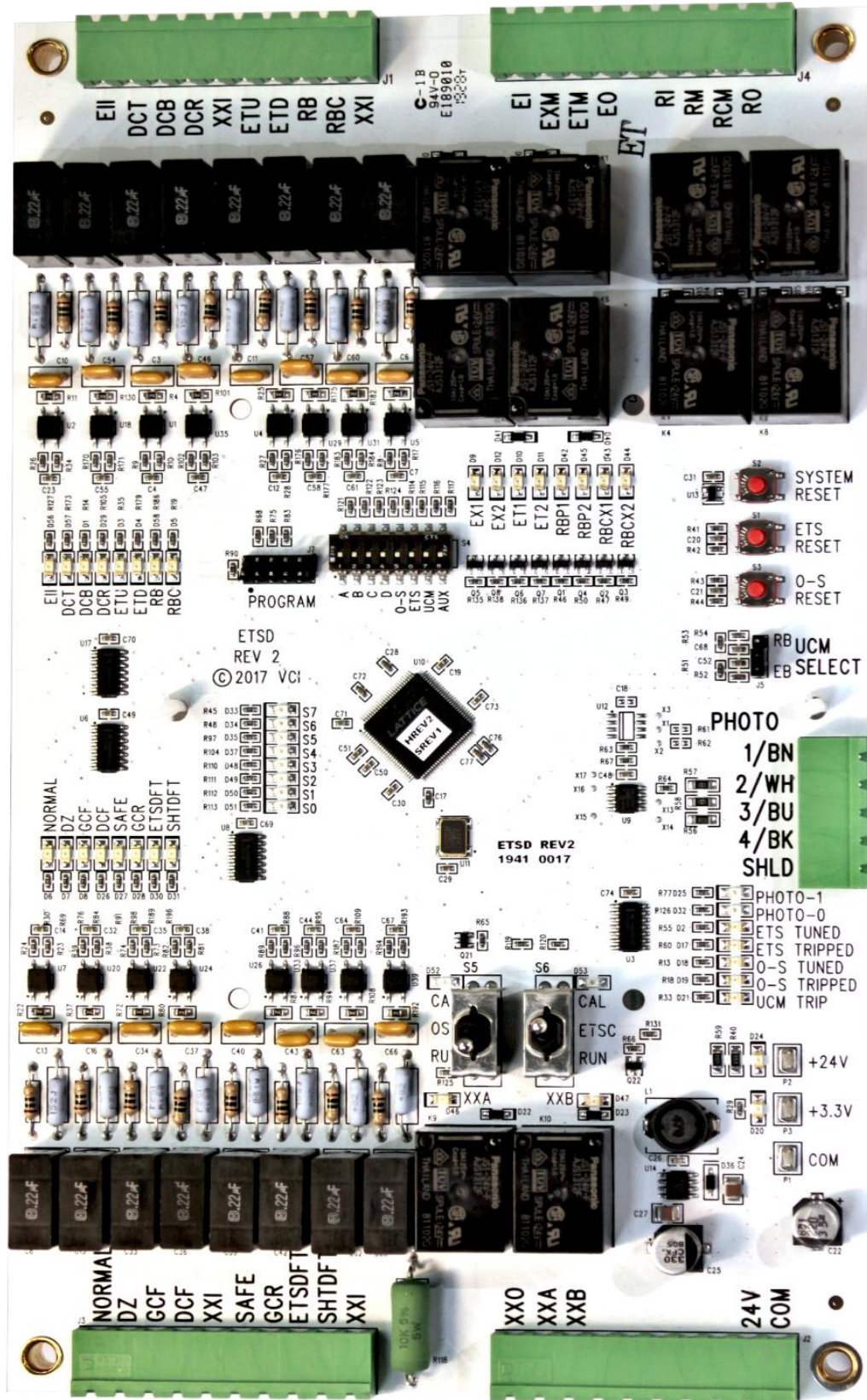

Figure 33 - PHOTO-1 Indicator

6.6.5 ETSD Board Specifications

Input Power	24VDC @ ½ amp (external)
On-board Power	3.3VDC
I/O	16 – 120VAC Inputs / 10 – Relay Outputs
LED Indicators (Green)	+24V (voltage present) +3.3V (voltage present) 16 – 120VAC Inputs (energized) 10 – Relay Outputs (energized) ETS TUNED (ETSD sub-system operational) O-S TUNED (O-S sub-system operational)
LED Indicators (Yellow)	PHOTO-1 (indicating white segment of ETSD tape) PHOTO-0 (indicating black segment of ETSD tape) S0 – S7 (Monitors states of 3 control sub-systems, and indicates car speed when “AUX” DIP Switch is selected.)
LED Indicators (Red)	ETS TRIP (ETSD Sub-System fault) O-S TRIP (O-S Sub-System fault) UCM TRIP (UCM Sub-System fault)
Push Buttons	SYSTEM RESET (Returns the 3 sub-systems to initial state.) ETS RESET (Resets an ETSD System Fault.) O-S RESET (Resets an Over-Speed Fault.)
Toggle Switches	OSC Calibrate (Selects between calibration and operation.) ETS Calibrate (Selects between calibration and operation.)
DIP Switches	A-D; O-S; ETS; UCM; AUX (One selection to be made at a time.) Selects among the sub-systems to be monitored, or car speed.
Jumpers	UCM SELECT (selects Rope Brake or Emergency Brake operation)
Test Points	+24V; +3.3V & COM
Connectors PHOTO; 4-pole	1/BN – Brown wire; +24VDC supply to Speed Sensor 2/WH – White wire; no function 3/BU – Blue wire; Common of supply to Speed Sensor 4/BK – Black wire; output signal from Speed Sensor SHLD – braided Drain wire of Speed Sensor Cable
Dimensions	10”H x 6”W on ⅝” stand-offs
Environment	
Ambient Temp.	32° - 104°F (0° - 40°C)
Operating Temp.	32° - 122°F (0° - 50°C)
Storage	14° - 140°F (-10° - 60°C)
Humidity	5% - 95% non-condensing



6.6.6 Speed (Photo) Sensor & Cable Specifications

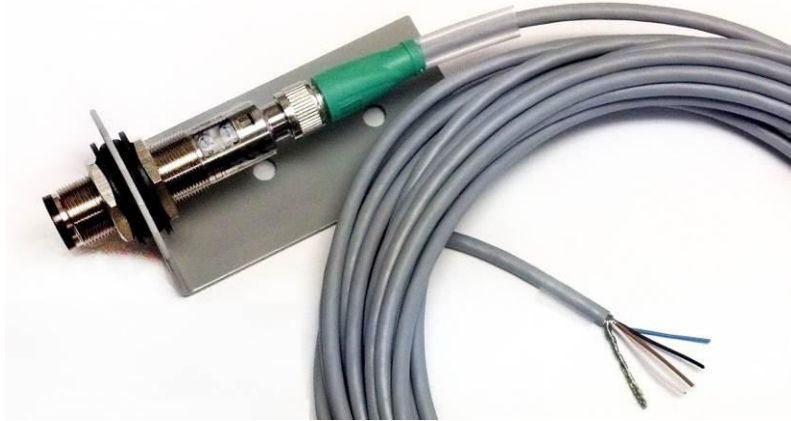

Figure 35 - Speed (Photo) Sensor & Cable

WARNING: The Speed Sensor is Class 1 Laser Product. Avoid eye contact with Red light source.

Manufacturer	Pepperl+Fuchs
Model: (Photo Sensor) (Shielded Cables)	VT18-8-400-M-LAS/40a/118/128 – P/N: 801135 Note: Class 1 Laser Product V1-G-10M-PUR-ABG – P/N: 221508 (10 meter length) Or, V1-W-10M-PUR-ABG – P/N: 219640 (10 meter length w/90° Connector)
ETSD Speed Tape	5/8" W x 10Ft (36" max. Sheave Dia.); 1/4" alternating Black & White segments
Mounting (Bracket) (Position)	Steel Angle Bracket (use 1/4-20 bolts) w/Rubber Grommet & Fiber Washers Position photo sensor slightly off perpendicular from tape by 5° - 15° to inhibit reflection (an ON state) while on a "Black" segment of ETSD Tape.
Distance (Sensor to Tape)	5" (±1/4") between Sensor face (Red) & Tape on Sheave
Output	5VDC @ 9mA (ON state) square wave
Frequency (Max.)	500Hz from Sensor Output
Speed: (Max.) (Operating)	1250FPM (500Hz) w/1:1 Roping 1000FPM (400Hz; 20% safety margin)
Adjustment: (Rotary Sw.) (Potentiometer)	L/D (Light / Dark – 2-Pos.) Default = "L" – Light Examine carefully! SENS. (2-turn with clutch) Default = centered at one turn.
Indicators: (Green) (Yellow)	POWER (Lit solid or flashes if sensor output is shorted.) SENS. (Lights when beam is reflected by WHITE segment of tape.)

NOTE: Be certain to retain all Pepperl+Fuchs product information for troubleshooting.

7. MVFAC-3000 Screens and Diagnostics

7.1 Run Mode

When the controller is powered up, or the Reset Button is pushed, the microprocessor will be in the Run Mode. In this mode the microprocessor will allow the Inputs and Outputs to operate properly, and the elevator to run. (The only other mode is the Setup Mode, as described below. In the Setup Mode the elevator is shutdown, and all outputs are turned off.)

Several diagnostic screens are available in the Run Mode, and each is accessed by scrolling through the selections until the desired item is located, and **Ent** is pressed.

The display will show either the "Car Status" screen or a blank screen, depending on the setting of S2 switch 1 on the CPU. If S2 switch 1 is ON then the "Car Status" screen will be displayed, and if S2 switch 1 is OFF then the screen will be blank until a key is pressed. It will then show the "Car Status" screen.

Press **Esc** to return to the Run Mode menu screens.

Pressing **Nxt** or **Prv** will scroll through the available screens in the Run Mode. To select a display, press **Nxt** or **Prv** to show the desired item, then press **Ent** to show the desired screen.

7.1.1 Run Mode Screens

The screens available in the Run Mode are:

1. Show I/O Status
2. Show Fault Log
3. Show Internal Memory
4. Show Car Status
5. Go to Set-Up Mode

RUN MODE SCREENS

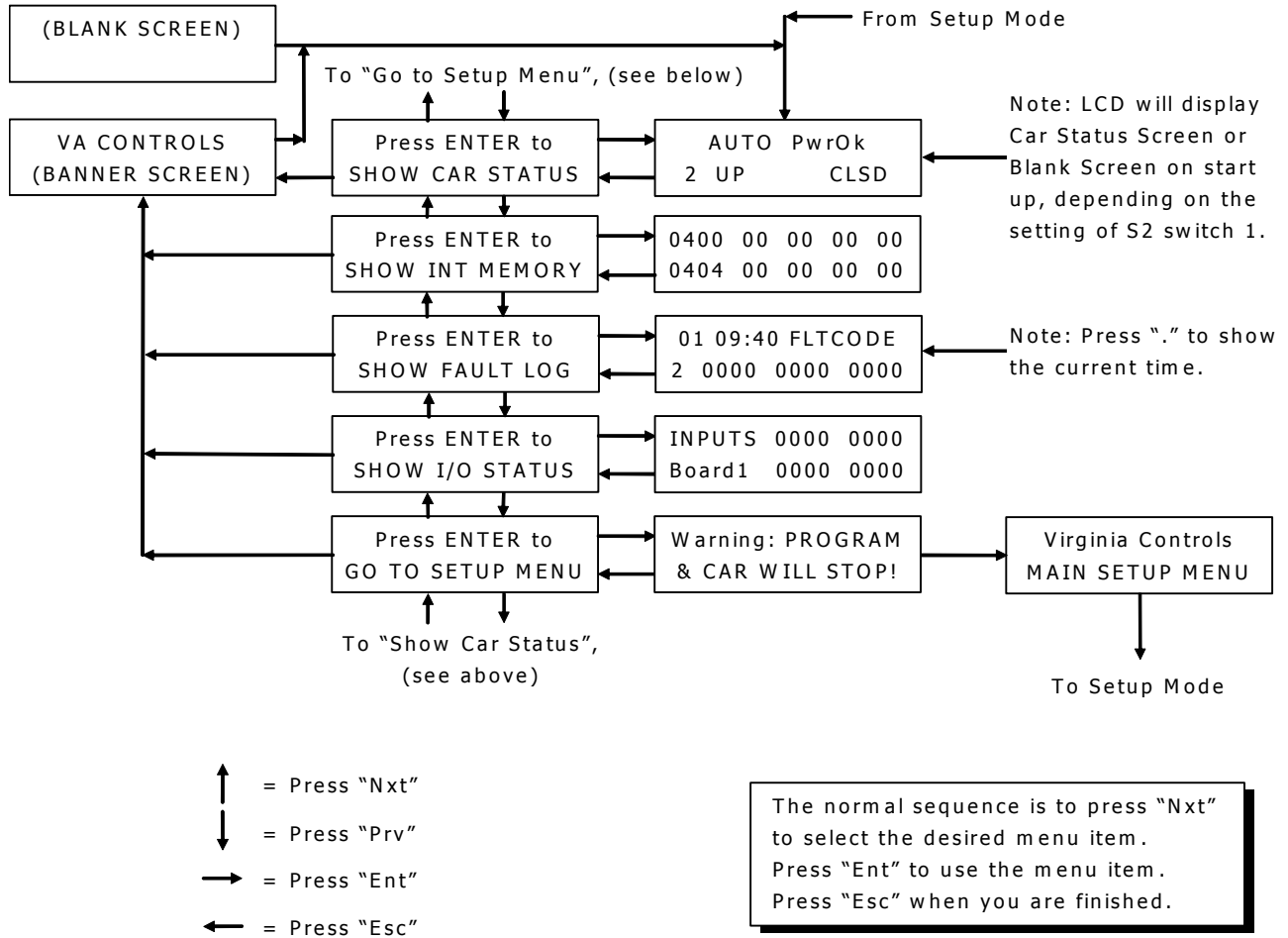

7.1.1.1 Banner Screen

A "Banner" screen showing the program information is available. This is accessed by pressing Esc from the Run Mode. A sample banner screen is shown here.

```

VaControls.DS03A
12345.1.040705..
    
```

The "Banner" screen shows "VaControls" on the top line, followed by a code showing the program family. In the example above this is "DS03A". The code on the bottom line shows the Virginia Controls Job Number (in the example above this is "12345"), the program revision number (in the example above this is "1"), and a date code for the program in the format MMDDYY (in the example above this is "040705" for April 7th, 2005). The controller displays the "Car Status" screen when the "Set-up Mode" is exited.

7.1.2 Show I/O Status

The "Show I/O Status" display allows the screen to display the status of the Inputs or Outputs on one board. This display is useful for checking the integrity of the I/O boards and the communications between the CPU board and the I/O boards. The display should agree with the corresponding LEDs on the I/O boards.

The board number corresponds to the address set by the Address Switches on each I/O board. The top left shows whether inputs or outputs are being monitored, and the bottom left shows the board number being displayed.

```
INPUTS 0011 0010
Board2 0100 0110
```

The right side shows the status of the inputs or outputs. The status will be a "1" if the signal is on, or a "0" if the signal is off. The order of the bits corresponds to the order of the LEDs on the I/O board, that is, the top left bit corresponds to Point 1, top right is point 8, bottom left is point 9 and bottom right is point 16. In the example above, the Inputs on Board # 2 are being monitored, and points 3,4,7 (top line) and points 10,14,15 (bottom line) are all on.

If an I/O Fault is showing on the Status Screen, and the data on the Show I/O Screen matches the I/O boards, then the checksum in the communication is incorrect. This will cause the CPU to ignore the data, and not pass it to the main program. To determine which board is causing the communication failure, refer to the section on troubleshooting suggestions for I/O board faults.

7.1.2.1 Moving Around in I/O Status Screen

Press **Nxt** or **Prv** to scroll through the I/O.

Press **Aux** to toggle between Inputs and Outputs.

Press **Esc** to return to the Run Mode menu screens.

The keys **0** - **9**, **.** and **Ent** are not used in this mode.

7.1.3 Show Fault Log

The "Show Fault Log" screen allows the controller fault log to be viewed. This log shows the fault number, the time stamp of the fault, the fault code, and critical data when the fault occurred, including the floor position of the car and the status of certain key signals.

As shown in the description of the faults below, some of the faults logged are not faults, but events that are useful to know in the maintenance and operation of the elevator.

The controller stores the last 63 faults in battery backed RAM memory.

When a new fault occurs, all the existing faults are moved down to the next fault location, and fault 63 is erased. The most recent fault is stored in fault location 00, and the order of the faults in the fault log is the order in which the faults were logged, with the most recent faults at the top of the fault log table.

If a new fault is logged while viewing the fault log, the screen is not changed, it will continue to show the old fault. This allows the fault data to be viewed if several faults are logged rapidly. To refresh the screen, and show the current fault in that fault location, press **Ent**.



NOTE: All faults will be cleared when a Factory Reset is performed.

Non-shutdown faults can be prevented from being logged, if desired. See the list of Adjustable Features on sheet “MVFAC-3000 Settings”. One of the Bit Features will be labeled “Disable Non-Shutdown Faults in the Fault Log”. Turn this feature on to disable non-shutdown faults. This may be useful if you are trying to track down a specific fault, and you do not want the fault log to contain minor faults. Refer to the section on Changing Features for instructions on settings the proper Bit Feature to disable non-shutdown faults.

7.1.3.1 Typical Fault Screen

This is the “Fault Log” screen layout, showing a typical fault message:

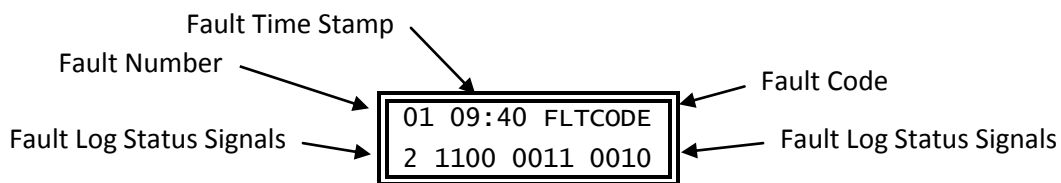

7.1.3.2 Fault Number

“01” is the fault number, shown on the top left of the “Fault Log” screen. It is a hexadecimal number from 00 to 3E (decimal 62), with 00 being the most recent fault. Press **Nxt** to scroll through the fault log, showing the next older fault. Press **Prv** to show the next most recent fault. You can press **0** to jump to the most recent fault (fault 00).

7.1.3.3 Fault Time Stamp

“09:40” is the time stamp for the fault, shown in the middle of the top line of the “Fault Log” screen. The time is displayed in 24hour format. The time stamp is accurate to within 10 minutes, so if the fault time is 09:40, as shown above, then the fault occurred between 9:40 and 9:49.

NOTE: Faults that happen within 10 minutes of each other may log the same time. The fault # will indicate the order of occurrence.

If the real time clock is set correctly, then this will be the time of the fault.

NOTE: To set the clock, refer to the section on setting the time under MVFAC-3000 Screens and Diagnostics/Set-Up Mode/Set the Time.

To verify that the real time clock is set, press **.** to display the current time and date as shown here. Press **Ent** to return to the fault log.

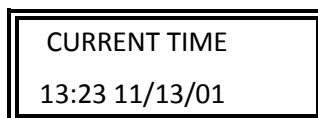

7.1.3.4 Fault Code

“FLTCODE” is the code for the fault, shown on the top right of the “Fault Log” screen. It is an alphanumeric designation up to 7 characters that indicates what the fault was. The following fault codes are standard.

NOTE: If a code is shown that is not in this list, check the paperwork for your specific job to determine the meaning of the code, and the cause of the fault.

Non-shutdown faults can be prevented from being logged, if desired. See the list of Adjustable Features on sheet “MVFAC-3000 Settings”. One of the Bit Features will be labeled “Disable Non-Shutdown Faults in the Fault Log”. Turn this feature on to disable non-shutdown faults. This may be useful if you are trying to track down a specific fault, and you do not want the fault log to contain minor faults.

Refer to the section on Changing Features for instructions on settings the proper Bit Feature to disable non-shutdown faults. The following faults will be disabled: This will prevent faults TDOPEN, TDCLOSE, TDOPN-R, TDCLO-R, CARSTUK, DRCONTS, OUT-DZ, COMMFLT, FIRE, MRSMOKE, SHUNT, FLOOD from being logged.

Fault Resets. Refer to the descriptions below for any special requirements to reset a particular fault. Faults are normally reset by cycling the Inspection Sw or cycling the power. For 2010 code and later, shutdown faults must be reset manually by momentarily jumping the Fault Reset Input.

CODE	DESCRIPTION
ROLLOVR	<p>This code is logged every 24 hours, to indicate the faults after this point are from the previous day. The data displayed on the bottom line is not the car status. The month and date for the following faults are shown on the left, and the number of days without faults is shown on the lower right. For example, the screen below indicates that fault 23 is a rollover, so that fault 24 and older faults occurred on 11/13 and fault 22 and earlier faults occurred on 11/14.</p> <div data-bbox="740 474 1058 573" style="border: 1px solid black; padding: 5px; margin: 10px auto; width: fit-content;"> 23 00:00 ROLLOVR 11/13 0 </div> <p>Several consecutive rollover faults will be combined into one rollover fault, and the number on the lower right will indicate how many additional rollovers were combined, indicating there were no faults for that many additional days.</p> <div data-bbox="740 716 1058 814" style="border: 1px solid black; padding: 5px; margin: 10px auto; width: fit-content;"> 23 00:00 ROLLOVR 11/13 2 </div> <div data-bbox="740 846 1058 945" style="border: 1px solid black; padding: 5px; margin: 10px auto; width: fit-content;"> 24 09:30 LOW OIL 3 0110 1001 0000 </div> <div data-bbox="740 976 1058 1075" style="border: 1px solid black; padding: 5px; margin: 10px auto; width: fit-content;"> 25 00:00 ROLLOVR 11/07 5 </div> <p>For example, if faults 23, 24 and 25 were as shown above, this indicates a rollover code 25 was combined with five more (on 11/08 to 11/12) so that no faults occurred between 11/08 and 11/12, and fault 24 occurred on 11/13, since that is the date of the next earliest rollover.</p> <div data-bbox="448 1213 1395 1360" style="border: 1px solid black; padding: 5px; margin: 10px auto; width: fit-content; background-color: #e0e0e0;"> <p>NOTE: If the power is off when a rollover would have occurred (at midnight) then no rollover code will be logged. If power is left on, then the date of any fault is the date shown on the most recent (lower fault number) rollover code.</p> </div>
RUN Tmr	<p>Running Shutdown Timer. The car ran for the time specified by the "Shutdown Time" setting without passing a floor. The car will stop and shut down immediately. The doors may be opened if the car is in the Door Zone. Check that the setting of the shutdown timer is long enough for the car to run between floors. The normal shutdown timer setting is 25 seconds.</p> <p>NOTE: If 2010 ANSI Code is enabled, then shutdown faults must be reset by momentarily jumping the Fault Reset Input.</p>
TDOPEN	<p>Door Open Fault. The Door Open Limit Switch failed to open after the doors had been opening for the time specified by the "Door Fault" setting. The probable causes are: (1) The Door Open Limit failure. (2) door operator failure. (3) door control circuitry failure. This fault can be disabled on Manual Door systems. The fault will stop the door open sequence. It does not latch, and does not need to be reset.</p>
TDCLOSE	<p>Door Close Fault. The doors failed to close properly when they were parking, or when the car was ready to run for the next call. This fault will not be caused by keeping the doors open</p>

CODE	DESCRIPTION
	through the normal means (Door Open Button, Safety Edge, Infra-red Unit, etc.), but only if the doors should be closing but were not able to close. The probable causes are: (1) Door Close Limit failure. (2) Door Contacts failure. (3) door operator failure. (4) door control circuit failure. The fault will stop the door close sequence. In automatic, it will reopen the doors, and allow them to try to close again. The fault does not latch and does not need to be reset.
TDOPN-R	Rear Door Open Fault. This is the same as fault TDOPEN, except it is for the rear door. This fault is only used on elevators with selective open doors (with a front and rear door at the same landing). This fault can be disabled on Manual Door systems.
TDCLO-R	Rear Door Close Fault. This is the same as fault TDCLOSE, except it is for the rear door. This fault is only used on elevators with selective open doors (with a front and rear door at the same landing).
CARSTUK	Car Stuck Fault. The car was held at a floor for the time set by the "Car Stuck Time" setting, without running. This may be caused by a stuck button, or just by a passenger holding the car. The fault is not latched and will clear when the car runs.
EmPower	Emergency Power. The elevator went on Emergency Power. Normal operation (Automatic Return) is for the car to return to the Main Ldg, then shut down until the Emergency Power Run Input is turned on. The controller can be set up to provide Manual Return, so that the Emergency Power Run Input must be on to allow the car to return. The car will not return automatically if it is on Inspection, Fire Service, Independent Service, or is prevented from running for some other reason. The fault is not latched, and will clear when power inputs are normal.
DRCONTS	Door Contact Fault. The Door Contact Input turned off while the car was running. This fault could be caused by the car tipping a door contact, or another of the devices in the safety string. It could also be caused by a failure of the "DC" Door Contact relay. The fault is not latched. The car is able to run again if all safety devices are in the normal condition.
OUT-DZ	Door Zone Fault. The car stopped between floors. This is normal when the car is being taken off Inspection Service. This fault will usually be seen with fault 08, since the car will usually stop outside the door zone if the safety string is broken. This fault is not latched. It will reset when the car runs or stops at a floor.
COMMFLT	Communication Failure on Duplex. This will occur when the power on the other car is turned off, or the other car fails to communicate properly for 5 seconds. Check the communication cable, and the termination jumpers, which are located by the communication cable terminal strip. The fault is not latched. It clears when communication is restored.
DRCHECK	Door Check Fault. The Car or Hall Door Contacts Input was on (indicating the doors are closed) while the Door Close Limit was on (indicating the doors are open). This check is performed when the doors are fully open (Door Open Limit is off) and the car is not on a Leveling Switch. The car will be held with the doors open until the Door Contacts inputs are both off. The Car Door and Hall Door Contacts are both checked independently. If this fault is not caused by a jumper on the Door Contacts, then check the Car and Hall Door Contacts very carefully, and check the wiring to the Door Contact Inputs and Door Close Limit Input. The fault is held while the fault condition exists, then self resets.

CODE	DESCRIPTION
LEV SWS	Leveling Switch Fault. Both Leveling Switch Inputs are on. This will shut the car down. Check the Leveling Switches to make sure one of them has not stuck. The switches must be adjusted so that only one leveling switch is energized at a time. Then check the wiring for shorts. In some short floor situations, there may be an overlap of the leveling switches between the floors. In this case special programming will allow an overlap without causing a fault. The fault clears when both Leveling Sws are no longer both on.
FIRE	<p>Fire Service Phase 1 or Phase 2 was initiated. This does not indicate a fault in the controller operation. Fire Service is reset according to applicable codes. Normally that involves turning the Hall Fire Sw to “Reset” then “Off”.</p> <div data-bbox="446 600 1395 716" style="border: 1px solid black; padding: 5px; background-color: #f0f0f0;"> <p>NOTE: If Fire Service is not provided, or it is desired to bypass Fire Service during initial installation, then disable Fire Service in the Setup Menu by changing the Adjustable Bit Features.</p> </div>
MRSMOKE	The Machine Room or Shaftway Fire Sensors were initiated. This signal is required by the 1998 ANSI and later codes, and will start the Fire Light flashing. Later codes only flash the Fire Light if this smoke detector initiated Fire Service. The exact operation depends on the applicable codes. It is normally reset by turning the Hall Fire Switch to “Reset” then back to “Off”.
SHUNT	The Shunt Trip Input was initiated. The car will stop at the next floor, and open its doors. An output will then come on that can be used to initiate the Shunt Trip Breaker, and turn power off to the controller. The fault is reset when the Shunt input goes off and the car is not on Fire Service.
DZFAULT	<p>The Door Zone Switch was energized when it should not have been, such as when the car was running between floors. The car will shut down at the next stop.</p> <p>There are several situations that can give this fault that may not seem to be a problem with the Door Zone Switch, but which ultimately the MVFAC-3000 sees as the Door Zone Input being on when it should not be. In most cases the FS relay did not energize properly on a floor-to-floor run. These situations include:</p> <ul style="list-style-type: none"> – The Level Lockout Timer is too short. It must be long enough for the FS relays to energize and cut out the Door Zone Input. – The UL or DL inputs are failing. – There is a failure in the Up or Down Normal Limit Sw, preventing FS from energizing to cut out the Door Zone Input. – There is a loose wire or bad connection on terminal 6, 14, 14X, 16, 16X, 21 or 22 which is preventing FS from energizing properly. <p>The fault is reset by Fire Service, Inspection or cycling the power. It is disabled if Redundancy is disabled.</p>
RED1ROP	Redundancy Fault in the ESB Emergency Stop Sw Bypass circuit or the Rope Brake Monitoring circuit. The input that monitors the Emergency Stop Switch Bypass function indicated the Emergency Stop Switch was bypassed when it should not have been, OR the Rope Brake monitoring inputs (RB6, RBC6) were on when the corresponding Rope Brake outputs (RB, RBX, RBC) were off. Check the ESB relay, or ESB monitoring input, and its associated wiring.

CODE	DESCRIPTION
	<p>Check the Rope Brake relays and circuits. Cycle the power to reset the fault.</p> <p>NOTE: If 2010 ANSI Code is enabled, and the setting to require manual resets on Redundancy Fault is enabled, then shutdown faults must be reset by momentarily jumping the Fault Reset Input.</p>
RED2RUN	<p>Redundancy Fault in the running or leveling circuits. The Door Contact Bypass circuit monitoring point (LV) was energized when it should not have been, OR one of the run inputs (UD1, UD2) was still on after the car stopped. Check the external circuits for stuck relays (UL, DL, DZ, LV1, LV2, U1, U2, D1, D2) or a stuck input. Cycle the power to reset the fault.</p> <p>NOTE: If 2010 ANSI Code is enabled, and the setting to require manual resets on Redundancy Fault is enabled, then shutdown faults must be reset by momentarily jumping the Fault Reset Input.</p>
FSRELAY	<p>FS Relay Fault. The car attempted to run floor to floor 20 times, but did not make a floor change. This is normally caused by the FS relay failing to cut out the leveling switches, so that the car cannot leave the floor. When this fault is detected, the fault will be logged, and the car will shut down.</p>
RED3SAF	<p>Redundancy Fault in the Safety Circuit. The condition of the Door Fault Monitor input (DF6) was not correct, OR the Car Gate Input (4X) or Door Contacts Input (5X) was not correct, OR the Stop Sw input (3X) was not correct. This may be caused by temporary jumpers added during initial installation, or a short in the Safety Circuit. Cycle the power to reset the fault.</p> <p>NOTE: If 2010 ANSI Code is enabled, and the setting to require manual resets on Redundancy Fault is enabled, then shutdown faults must be reset by momentarily jumping the Fault Reset Input.</p>
RED4INS	<p>Redundancy Fault in the Inspection Door Bypass circuits. One of the inputs that monitors the circuits that bypass the Door Contacts on Inspection or Access operation was closed when the car was not on Inspection or Access, or terminal 3 or 4 was not hot. Check the Door Contact circuit for jumpers or shorts. Cycle the power to reset the fault.</p> <p>NOTE: If 2010 ANSI Code is enabled, and the setting to require manual resets on Redundancy Fault is enabled, then shutdown faults must be reset by momentarily jumping the Fault Reset Input.</p>
SafeFlt	<p>The Safe Input failed to operate properly. The Safe Input should be ON when the car is stopped, and turn OFF when the car starts to run. If the Safe Input does not change state properly, then this fault will be logged. The fault is reset by cycling the power or momentarily jumping the Fault Reset / Shutdown Defeat Input.</p>
BrakeSw	<p>The Brake Micro Switch did not operate properly. The Brake Micro Switch Input should go off when the car starts to run. The fault is reset by cycling the power or momentarily jumping the Fault Reset / Shutdown Defeat Input.</p>
Drv.Run	<p>The Drive Run Input did not operate properly. The Drive Run input should be on when the Drive is running, and go off when the car stops. The fault is reset by cycling the power or momentarily jumping the Fault Reset / Shutdown Defeat Input.</p>
Drv.Rdy	<p>The Drive Ready to Run Signal went off. The controller will attempt to reset the drive. Check</p>

CODE	DESCRIPTION
	the Drive for any fault indications. The fault is reset by cycling the power or momentarily jumping the Fault Reset / Shutdown Defeat Input.
OverSpd	An Over Speed was detected. If the Over Speed Input goes high when the car is running with the doors open, the car will shut down. The Over Speed Input should be set to turn on when the car speed exceeds 150fpm. It may be adjusted for a lower speed if desired, to provide additional protection.
ROPE-DZ	The Rope Brake set because the car moved out of the Door Zone with the Doors open and without a run signal. To reset this fault, momentarily turn on the Shutdown Defeat input. To test this feature, with the car floor level and the doors open, unplug the DZ relay to simulate the car moving out of the Door Zone.
ROPE-BS	The Rope Brake set because the car stopped and the Brake Micro Sw did not drop. To reset this fault, momentarily turn on the Shutdown Defeat input. To test this feature, with the car stopped, disconnect the Brake Micro Sw input (29).
ROPE-CK	The Rope Brake relay monitor detected a fault in the Rope Brake pilot relays. When the car is ready to start, the Rope Brake relays are cycled to confirm they are operating correctly. If this test is not passed, this fault is generated, and the car is shut down. The fault is reset by cycling the power or momentarily jumping the Fault Reset / Shutdown Defeat Input.
ROPEBRK	Rope Brake Fault. This is caused by either the Rope Brake relay monitor detected a fault in the Rope Brake pilot relays. When the car is ready to start, the Rope Brake relays are cycled to confirm they are operating correctly. If this test is not passed, this fault is generated, and the car is shut down. The fault can also be generated if the High Speed Counter in the Allen-Bradley Micro830 PLC detects that the car is running when it should be stopped. This will cause the Rope Brake to drop. The fault is reset by momentarily jumping the Fault Reset / Shutdown Defeat Input.
RED-UCM	Redundancy Fault detected in the ETSD/UCM Board circuits. Check the Status data and the table shown later in this section to determine the specific fault and its cause.
HSC-ETS	High Speed Counter or Emergency Terminal Speed Fault. The High Speed Counter Fault is generated if the car exceeds 110% of contract speed, 150fpm on Inspection, 150fpm with the doors open, speed (or tach) loss or running the wrong direction. The Emergency Terminal Speed Fault is generated if the car exceeds the set speed after hitting the ETS Switched at the terminal Landings; or if the ETS Sw does not open as the car stops at the terminal landing. Check the Status data and the table shown later in this section to determine the specific fault and its cause. The fault is reset by momentarily jumping the Fault Reset / Shutdown Defeat Input.
FAULT1E	This is a custom fault reserved for future use. If it used on a specific job, it will be described on the "MVFAC-3000 Settings" sheet in the schematic.
FAULT1F	This is a custom fault reserved for future use. If it used on a specific job, it will be described on the "MVFAC-3000 Settings" sheet in the schematic.
IOFLT??	IO Board Fault. The I/O boards did not communicate properly with the CPU. The two numbers after "IOFLT" indicate which boards failed. The code consists of 80Hex ANDED with the bit pattern for the board(s) that failed to communicate. That is "81" indicates the first

CODE	DESCRIPTION
	<p>board failed; "83" = the 1st and 2nd boards; "8A" = 2nd and 4th boards; etc. Check the Address Switches for all boards. Check the setting in the CPU for the number of IO Boards. Check the cables between boards.</p> <div style="border: 1px solid black; padding: 5px; margin: 10px 0;"> <p>NOTE: If the boards NEVER communicate, a fault will not be logged, since the fault is ignored during power up. The fault is only logged if the boards were communicating properly and then stopped.</p> </div>
(OTHER)	Other Fault Codes may occasionally be provided on specific jobs. If this is the case, then refer to the additional documentation for that job to see what the codes and descriptions are for those faults.

I/O BOARD FAULT TABLE

Right Number	x0	x1	x2	x3	x4	x5	x6	x7
Board1	OK	Fault	OK	Fault	OK	Fault	OK	Fault
Board2	OK	OK	Fault	Fault	OK	OK	Fault	Fault
Board3	OK	OK	OK	OK	Fault	Fault	Fault	Fault
Board4	OK	OK	OK	OK	OK	OK	OK	OK
Right Number	x8	x9	xA	xB	xC	xD	xE	xF
Board1	OK	Fault	OK	Fault	OK	Fault	OK	Fault
Board2	OK	OK	Fault	Fault	OK	OK	Fault	Fault
Board3	OK	OK	OK	OK	Fault	Fault	Fault	Fault
Board4	Fault	Fault	Fault	Fault	Fault	Fault	Fault	Fault
Left Number	0x	1x	2x	3x	4x	5x	6x	7x
Board5	OK	Fault	OK	Fault	OK	Fault	OK	Fault
Board6	OK	OK	Fault	Fault	OK	OK	Fault	Fault
Board7	OK	OK	OK	OK	Fault	Fault	Fault	Fault
Left Number	8x	9x	Ax	Bx	Cx	Dx	Ex	Fx
Board5	OK	Fault	OK	Fault	OK	Fault	OK	Fault
Board6	OK	OK	Fault	Fault	OK	OK	Fault	Fault
Board7	OK	OK	OK	OK	Fault	Fault	Fault	Fault

7.1.3.5 Fault Log Status Signals

The bottom row of the "Fault Log" screen shows the car position and the status of key signals that help determine what the car was doing when the fault occurred. The car position is a number between 1 and 9, and every other value is either 1 (the signal was on) or 0 (the signal was off).

To match the description with the location of each signal, the values in the screen below have been replaced with letters, but in the actual log they would be 1's and 0's, as shown in the sample screen at the top of this section. Match the letter shown in the sample screen below with the table below, to determine the description of that signal.

NOTE: The Fault Status Signals are the same for all faults EXCEPT for the Redundancy Faults RED-RUN, RED-SAF, and RED-INS. Refer to the tables below for the description of the signals for those faults.

01 09:40 FLTCODE
P ABCD EFGH IJKL

Refer to the correct table below, depending on the fault.

SIGNAL	DESCRIPTION for STANDARD FAULTS
P	The car floor position when the fault occurred. The number will be between 1 and 9, with 1 indicating the bottom floor, 2 the second floor, etc. If the value is 9, then the car did not have a floor position.
A	The last direction the car ran. 1 = Up, 0 = Down.
B	The last direction selected (as shown by the direction indicators). 1 = Up, 0 = Down.
C	The car was running. 1 = Yes, 0 = No.
D	The car was running fast speed. 1 = Yes, 0 = No.
E	The car was running between floors (not re-leveling). 1 = Yes, 0 = No.
F	The Door Contacts Input was On. 1 = Yes, 0 = No.
G	The Door Close Limit Input was On. (With selective doors, this indicates either Door Close Limit was On, that is, one or both of the doors was open). 1 = Yes (door open), 0 = No (door closed).
H	The Door Open Limit Input was On. (With selective doors, this indicates both Door Open Limits were On, that is, neither door was full open). 1 = Yes (door not fully open), 0 = No (fully open).
I	Up Level Input was On. 1 = Yes, 0 = No.
J	Down Level Input was On. 1 = Yes, 0 = No.
K	Car was in the Door Zone. 1 = Yes, 0 = No.
L	"LV" Input (monitors the contacts in parallel with the Door Contacts, in the Safety String) was On. 1 = Yes, 0 = No.

SIGNAL	DESCRIPTION for RED1ROP FAULT
P	The car floor position when the fault occurred. The number will be between 1 and 9, with 1 indicating the bottom floor, 2 the second floor, etc. If the value is 9, then the car did not have a floor position.
NOTE	The status bits should all be off for normal operation. The bit that is ON indicates the fault

	condition that caused this fault.
A	Output "ROPEX" and Output "ROPE" were Off. Input "ROPE" was On.
B	Output "ROPEC" and Output "ROPE" were Off. Input "ROPE" was On.
C	Output "ROPEC" was Off. Input "ROPEC" was On.
D	Output "ESB" was Off and Input "SB" was On.
E – L	Not Used

SIGNAL	DESCRIPTION for RED2RUN FAULT
P	The car floor position when the fault occurred. The number will be between 1 and 9, with 1 indicating the bottom floor, 2 the second floor, etc. If the value is 9, then the car did not have a floor position.
NOTE	The status bits should all be off for normal operation. The bit that is ON indicates the fault condition that caused this fault.
A	Up and Down Level Inputs were OFF but LV Input was ON.
B	Up and Down Level Inputs and LV Input were all ON.
C	Door Zone Input was OFF and LV Input was ON.
D	Input "3" (Pit Sw) was OFF and LV Input was ON.
E	Input "3" (Pit Sw) was OFF and Input "UD1" was ON.
F	The car had stopped running and Input "UD1" was ON.
G	Input "3" (Pit Sw) was OFF and Input "UD2" was ON.
H	The car had stopped running and Input "UD2" was ON.
I	Special Redundancy feature was ON.
J – L	Not Used

SIGNAL	DESCRIPTION for RED3SAF FAULT
P	The car floor position when the fault occurred. The number will be between 1 and 9, with 1 indicating the bottom floor, 2 the second floor, etc. If the value is 9, then the car did not have a floor position.
NOTE	The status bits should all be off for normal operation. The bit that is ON indicates the fault condition that caused this fault.
A	Input "DFM" (Door Check Monitor) was OFF. Input "4" and Output "DF" were ON.
B	Input "DFM" (Door Check Monitor) was ON. Output "DF" was OFF.

C	Input "DFM" (Door Check Monitor) was ON. Input "5" was OFF.
D	Input "3" (Pit Sw) was OFF. The Door Contacts Input was On.
E	Input "4" was OFF. The Door Contacts Input was On.
F	Input "3" (Pit Sw) was OFF. The Car Gate Contacts Input was On.
G	Input "4" was OFF. The Car Gate Contacts Input was On.
H	Input "3" (Pit Sw) was OFF. Input "3X" (Stop Sw) was On.
I – L	Not Used

SIGNAL	DESCRIPTION for RED4INS FAULT
P	The car floor position when the fault occurred. The number will be between 1 and 9, with 1 indicating the bottom floor, 2 the second floor, etc. If the value is 9, then the car did not have a floor position.
NOTE	The status bits should all be off for normal operation. The bit that is ON indicates the fault condition that caused this fault.
A	Input "3" (Pit Sw) or Input "4" was OFF, and Input "IN1" was On.
B	Input "23" (Inspection Sw) was ON, and Input "IN1" was On.
C	Input "3" (Pit Sw) or Input "4" was OFF, and Input "IN2" was On.
D	Input "23" (Inspection Sw) was ON, and Input "IN2" was On.
E	Input "3" (Pit Sw) or Input "4" was OFF, and Input "IA1" was On.
F	Input "23" (Inspection Sw) was ON, and Input "IA1" was On.
G	Input "3" (Pit Sw) or Input "4" was OFF, and Input "IA2" was On.
H	Input "23" (Inspection Sw) was ON, and Input "IA2" was On.
I	Input "3" (Pit Sw) or Input "4" was OFF, and Input "IA3" was On.
J	Input "23" (Inspection Sw) was ON, and Input "IA3" was On.
K – L	Not Used

SIGNAL	DESCRIPTION for RED-UCM FAULT (without AB Micro830 PLC, Program V*3C8H)
P	The car floor position when the fault occurred.
A	I_RM And I_RCM Inputs were both Off. This indicates the ETSD/UCM Board has detected a fault that should drop the Rope Brake.
B	I_LSM Input was On after the car stopped. The I_LSM input should be on when the car is at contract speed, and off when the car is stopped. Check the operation of the LSM output on the ETSD/UCM Board.

C	I_LSM Input was Off when running Fast Speed. The I_LSM input should be on when the car is at contract speed, and off when the car is stopped. Check the calibration of the LSM output on the ETSD/UCM Board.
D	I_ETM Input was On and the car was running with the Doors open. Check the operation of the ETM output on the ETSD/UCM Board.
E	I_ETM Input was On when the car was on Inspection. Check the operation of the ETM output on the ETSD/UCM Board.
F	I_ETM and I_EXM Inputs were both off, and I_LSM Input was on. The ETSD/UCM Board detected an overspeed or ETSD fault. Check the ETSD/UCM Board for status lights.
G	I_ETM and I_EXM Inputs were both off, and I_LSM Input was off. The ETSD/UCM Board detected an overspeed or ETSD fault. Check the ETSD/UCM Board for status lights.
H	Not Used
I	Not Used
J	Not Used
K	Car was in the Door Zone
L	LV Input was on

SIGNAL	DESCRIPTION for RED-UCM FAULT (with AB Micro830 PLC, Program V*3C8I)
P	The car floor position when the fault occurred.
A	I_LSM Input was Off when running Fast Speed. The I_LSM input should be on when the car is at contract speed, and off when the car is stopped.
B	I_LSM Input was On after the car stopped. The I_LSM input should be on when the car is at contract speed, and off when the car is stopped. Check the operation of the LSM output on the UCM Board.
C	I_ETM and I_EXM Inputs were both off, and I_LSM Input was on. The UCM Board detected an overspeed or ETSD fault. Check the UCM Board lights.
D	I_ETM and I_EXM Inputs were both off, and I_LSM Input was off. The UCM Board detected an overspeed or ETSD fault. Check the UCM Board lights.
E	I_EXM Input was On and the car was running over 95% of contract speed.
F	I_ETM Input did not match the ETS Sw inputs, and I_ETM was OFF.
G	I_ETM Input did not match the ETS Sw inputs, and I_ETM was ON.
H	I_ETM Input was On and the car was running with the Doors open.
I	I_ETM Input was On when the car was on Inspection.
J	I_RM And I_RCM Inputs were Off. The UCM Board dropped the Rope Brake.
K	Car was in the Door Zone
L	LV Input was on

SIGNAL	DESCRIPTION for HSC-ETS FAULT (Used with A-BMicro830 PLC)
P	The car floor position when the fault occurred.

A	The car was running up. (Off=car was running down)
B	The car speed exceeded 110% of contract speed.
C	The car speed exceeded 150fpm on Inspection.
D	The car speed exceeded 50fpm with the doors open.
E	The car speed was below 10fpm on a fast speed run.
F	The car speed showed the car was running the wrong direction.
G	The car did not slow below 90% of contract speed after hitting an ETS Switch.
H	An ETS Switch did not open when the car reached a terminal landing.
I	Car Speed Code Input 1 was ON
J	Car Speed Code Input 2 was ON
K	Car Speed Code Input 3 was ON
L	HSC Up Input was ON.

7.1.3.6 Moving Around in the Fault Log

Press **Nxt** or **Prv** to scroll through the Fault Log.

Press **Aux** to jump to the "Show Internal Memory" screen.

Press **Ent** to refresh the display.

Press **Esc** to return to the Run Mode menu screens.

Press **.** to show the current time.

Press **0** to jump to the first fault.

The keys **1** - **9** are not used in this mode.

7.1.3.7 LED Description in "Show Fault Log" Mode



The LEDs D1, D2, D3, D4 change operation in the Show Fault Log Mode. They now show the status of the fault being viewed, in the same manner as the LEDs work in the Shown Internal Memory mode. (Specifically, D1 shows the status of the 1st bit of the time stamp; D2 shows the status of the 2nd bit of the fault code; D3 shows the status of the 3rd bit of the fault status; and D4 shows the status of the 4th bit of the second fault status word).

7.1.3.8 Historical Log

The Historical Log contains the number of faults, floor to floor runs, and door operations over a specific time period. They are counted and stored in memory addresses \$0520 to \$052F, along with the starting date of the log, according to the following list.

Address	Description
\$0520	Month of start of current historical log
\$0521	Date of start of current historical log
\$0522	Number of Faults, Characters 1 and 2
\$0523	Number of Faults, Characters 3 and 4
\$0524	Number of Floor to Floor Runs, Characters 1 and 2
\$0525	Number of Floor to Floor Runs, Characters 3 and 4
\$0526	Number of Door Cycles, Characters 1 and 2
\$0527	Number of Door Cycles, Characters 3 and 4
\$0528	Month of start of previous historical log
\$0529	Date of start of previous historical log
\$052A	Number of Faults in previous log, Characters 1 and 2
\$052B	Number of Faults in previous log, Characters 3 and 4
\$052C	Number of Floor to Floor Runs in previous log, Characters 1 and 2
\$052D	Number of Floor to Floor Runs in previous log, Characters 3 and 4
\$052E	Number of Door Cycles in previous log, Characters 1 and 2
\$052F	Number of Door Cycles in previous log, Characters 3 and 4

The number of faults, runs and door cycles are shown in two registers each, to allow the maximum number recorded to be over 65000.

To view the data, use the "Show Internal Memory" function to show address \$0520. A sample screen is shown below.

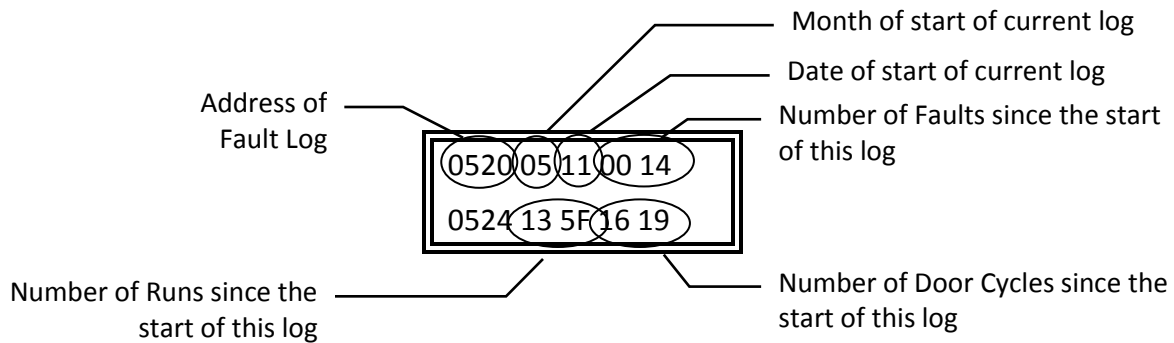

The number of faults, runs and door cycles are in hexadecimal. You can use the table below to convert the value to decimal.

Match the first hex character in the value to the decimal equivalent in the first two columns in the table; match the second character to the value in the next two columns; etc. Then add up the decimal equivalents for all the values to get the decimal value.

In the example shown above, the number of faults is "0014"(hex). Using the table, this is 0 (1st char hex) = 0 (decimal equivalent from 1st two columns)
 0 (2nd char hex) = 0 (decimal equivalent from 2nd two columns)
 1 (3rd char hex) = 16 (decimal equivalent from 3rd two columns)
 4 (4th char hex) = 4 (decimal equivalent from 4th two columns)
 0014(hex) = 0+0+16+4 = 20(decimal).

The number of runs is "135F"(hex), which is 4096+768+80+15=4959(dec)

The number of door cycles is "1619"(hex), which is 4096+1536+16+9=5657(dec)

After the number of days set in address \$0401 (default is 60) the values from the current Historical Log (addresses \$0520-0527) are moved to the Previous Log (addresses \$0528-052F) and the current log is cleared out. The current date is loaded into the start addresses for the new current historical log.

Table to determine the Decimal Value of a 4-digit Hexadecimal number.

1st Character		2nd Character		3rd Character		4th Character	
Hex	Decimal	Hex	Decimal	Hex	Decimal	Hex	Decimal
0	0	0	0	0	0	0	0
1	4096	1	256	1	16	1	1
2	8192	2	512	2	32	2	2
3	12288	3	768	3	48	3	3
4	16384	4	1024	4	64	4	4
5	20480	5	1280	5	80	5	5
6	24576	6	1536	6	96	6	6
7	28672	7	1792	7	112	7	7
8	32768	8	2048	8	128	8	8
9	36864	9	2304	9	144	9	9
A	40960	A	2560	A	160	A	10
B	45056	B	2816	B	176	B	11
C	49152	C	3072	C	192	C	12
D	53248	D	3328	D	208	D	13
E	57344	E	3584	E	224	E	14
F	61440	F	3840	F	240	F	15

7.1.4 Show Internal Memory

The "Show Internal Memory" screen (abbreviated to "Show Int. Memory" on the LCD display) shows the contents of the internal memory. This can be used to check the status of internal registers, to show the operation of the system.

When this display is selected, the display will show five numbers on each row. The left number in each row is a 4-digit hexadecimal number showing the memory address of the number immediately to its right. The memory is 8-bit, so the 4 pairs of numbers on the right show the contents of each of four consecutive memory addresses in hexadecimal format. A "\$" before a number indicates the number is in hexadecimal not decimal. All memory addresses are hexadecimal, and the contents will be shown in hexadecimal.

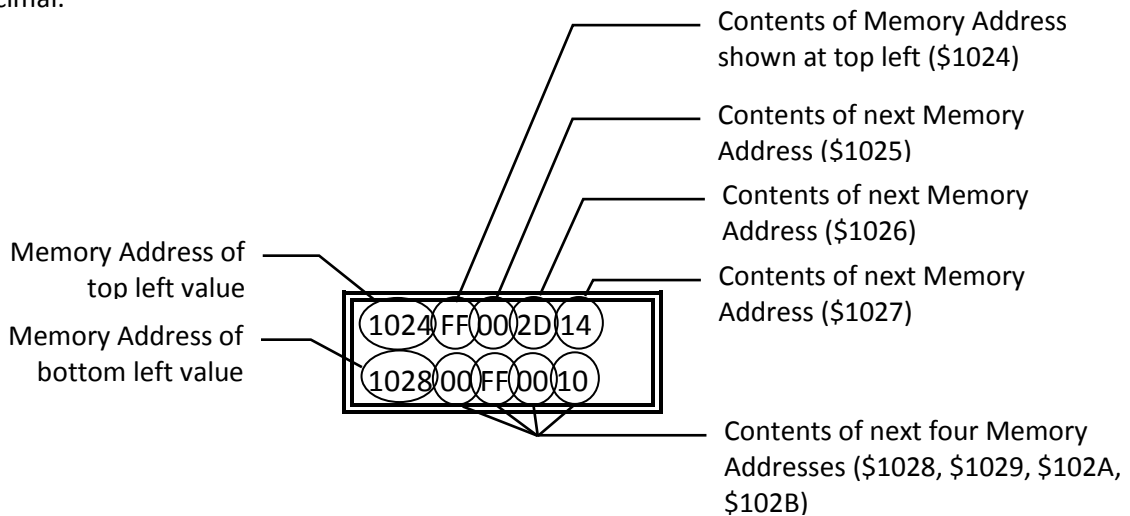

For example, if the display reads "1024 FF 00 2D 14", as shown above, then the top left number "1024" shows the address of the first value; the contents of address "1024" is "FF"; the contents of address "1025" is "00"; the contents of address "1026" is "2D"; and the contents of address "1027" is "14" (with each value being shown in hexadecimal).

NOTE: For addresses that show an ON or OFF condition, "00" is OFF, and "FF" is ON.

7.1.4.1 Moving Around in the Internal Memory

Press **Nxt** to increase the addresses being displayed by 4.

Press **Prv** to decrease the addresses being displayed by 4.

Press **3** to increase the addresses being displayed by 10(Hex).

Press **6** to decrease the addresses being displayed by 10(Hex).

Press **2** to increase the addresses being displayed by 100(Hex).

Press **5** to decrease the addresses being displayed by 100(Hex).

Press **1** to increase the addresses being displayed by 1000(Hex).

Press **4** to decrease the addresses being displayed by 1000(Hex).

Press **Aux** to increase the addresses being shown by 1.

Press **Esc** to return to the menu screens.



7.1.4.2 LED Description in "Show Internal Memory" Mode

The LEDs D1, D2, D3, D4 change operation in the Show Internal Memory Mode. They now show the status of the top 4 words being displayed.

Specifically, D1 shows the status of the 1st bit of the top left word being displayed; D2 shows the status of the 2nd bit of the 2nd left word being displayed; D3 shows the status of the 3rd bit of the 3rd top left word being displayed; and D4 shows the status of the 4th bit of the 4th top left word being displayed.

This allows the LEDs to show rapid changes in the status of internal memory that the LCD display would not be quick enough to respond to.

7.1.4.3 Changing values in the “Show Internal Memory” Mode

If the password has been entered, it is possible to change data in the Show Internal Memory mode.

WARNING: Changing data could cause unexpected and dangerous results. Do not do this unless you are fully aware of the value that needs to be changed, and how to change it. Take all necessary precautions to prevent an unsafe condition, such as disconnecting the terminal blocks from the outputs, removing the appropriate fuses, or opening the appropriate safety circuits.

Use the normal keys to navigate to the memory location that is to be changed, as shown in “Moving Around” above. You can only change the value that is in the top left of the display. For example, if the top line of the display shows “2012 04 37 82 34” then memory location 2012 can be changed from its current value of 04.

To change a value, press **[.]** (the top left character will flash briefly) then press one of the following keys:

Press **[Nxt]** to increase the addresses being displayed by 1.

Press **[Prv]** to decrease the addresses being displayed by 1.

Press **[3]** to increase the addresses being displayed by 4.

Press **[6]** to decrease the addresses being displayed by 4.

Press **[2]** to increase the addresses being displayed by 10(Hex).

Press **[5]** to decrease the addresses being displayed by 10(Hex).

Press **[1]** to increase the addresses being displayed by 40(Hex).

Press **[4]** to decrease the addresses being displayed by 40(Hex).

Press **[8]** to enter a value of (“FF”(Hex) minus the old value).

Press **[9]** to enter a value of “FF”(Hex).

Press **[0]** to enter a value of “0”.

Press **[7]** or **[Aux]** or **[.]** or **[Ent]** to leave the value unchanged

Press **[Esc]** to return to the menu screens.

7.1.5 Show Car Status

The “Show Car Status” screen displays the car status. Each area of the screen will display one of several messages that allow the user to see what the elevator is doing. The only key that is active in this screen is the **[Esc]** key, which returns to the menu selection screens. Leaving the “Car Status” screen on the LCD will slow the scan time down very slightly, since writing to the LCD is a fairly slow process. The writing is done while the I/O boards are being polled, so there is little overall impact on scan time. Consequently it is acceptable to leave the “Car Status” screen on the LCD, thus allowing a technician to quickly see a fault without having to scroll to that screen.

7.1.5.1 Messages Displayed on the “Car Status” Screen

Each area of the screen will display one of several messages. The numbers in the sample screen below indicate the message areas. Each group of numbers will be replaced by the appropriate message, depending on the status of the car.

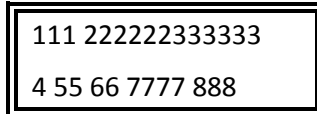

Message # 1 will be replaced with one of the following messages:

1. “BAT” – the CPU Battery is low.
2. “INS” – the car is on Inspection Operation.
3. “MEC” – the car is on Medical Emergency in the car, or EMT (Emergency Medical Technician Service) in the car.
4. “IDS” – the car is on Independent Service.
5. “MEH” – the car is responding to a Medical Emergency Call from the Hall, or an EMT call from the Hall.
6. “ATT” – the car is on Attendant Service.
7. “(no message)” – the car is not on one of the special operations shown above.

Message # 2 will be replaced with one of the following messages:

1. “RopeBk” – the Rope Brake tripped. Check the Fault Log to see what caused this. To reset this fault, the Shutdown Defeat Input must be turned on momentarily. If it is already on, turn it off then back on.
2. “DrvFlt” – the Drive Ready Input is not on. Check the Drive.
3. “RunFlt” – the running timer fault has tripped. The car ran too long between floors.
4. “SeqFlt” – the run relays did not sequence properly when the car started or stopped.
5. “RedROP” – a Redundancy Fault in the ESB Emergency Stop Sw Bypass circuit or the Rope Brake monitoring circuits has been detected. The input that monitors the Emergency Stop Switch Bypass function indicated the Emergency Stop Switch was bypassed when it should not have been, OR one of the Rope Brake monitoring inputs (RB6, RBC6) did not match the corresponding Rope Brake outputs (RB, RBX, RBC). The car will shut down at the next stop. Check the ESB relay, or ESB monitoring input, and its associated wiring, and the Rope Brake relays and monitoring inputs. Cycle the power to reset the fault.
6. “RedRUN” – a Redundancy Fault in the running or leveling circuits has been detected. The car will shut down at the next stop. Cycle the power to reset the fault.
Controllers using the MH5 printed circuit board – The Door Contact Bypass circuit monitoring point (LV) was energized when it should not have been, OR the run input (UD1 or UD2) was still on after the car stopped. Check the external circuits for stuck relays (UL, DL, DZ, LV, LVX, U, D, etc) or a stuck input.

7. "RedSAF" – a Redundancy Fault in the Safety Circuit has been detected. The car will shut down at the next stop. The condition of the Door Fault Monitor input (DFM) was not correct, OR the Car Gate Input (5) or Door Contacts Input (5X) was not correct. This may be caused by temporary jumpers added during initial installation, or a short in the Safety Circuit. Cycle the power to reset the fault.
8. "RedINS" – a Redundancy Fault in the Inspection Door Bypass circuits has been detected. The car will shut down at the next stop. One of the inputs that monitors the circuits that bypass the Door Contacts on Inspection or Access operation was closed when the car was not on Inspection or Access, or terminal 4 was not hot. Check the Door Contact circuit for jumpers or shorts. Cycle the power to reset the fault.
9. "DZFit" – a Door Zone Fault was detected. The Door Zone input was on while the car was running fast speed, OR the Door Zone Input came on before an Up or Down Level Sw came on. Check the Door Zone Switch.
10. "LevSws" – both of the Leveling "LevStk" – both of the Leveling Switches are on at the same time.
11. "OvrSpd" – the car was running too fast with the doors open.
12. "SHUNT" – the Shunt Trip input is enabled. The car will stop at the next landing, open its doors, and shutdown.
13. "SMOKE" – the Machine Room/Shaftway Fire detectors Input is energized.
14. "FIRE2" – the car is on Fire Service Phase 2 (car).
15. "FIRE1" – the car is on Fire Service Phase 1 (hall).
16. "OutDZ" – the car has stopped outside the Door Zone
17. "Auto" – the car is in automatic operation. It will respond to car and hall calls.
18. "NoHC" – the car is not answering Hall Calls. This may be caused by Inspection, Independent Service, Fire Service, Medical Emergency Service, Shutdown, Door Check Fault. The cause is usually shown in one of the other status messages.

Message # 3 will be replaced with one of the following messages:

1. "Em.Pwr" – the Reverse Phase Input or the Emergency Power Input is off.
2. "SHTDN" – the car is in shutdown.
3. "PwrOK" – none of the other faults exist. The car is on normal power, and not on shutdown.

Message # 4 will be replaced with one of the following messages:

1. The car position will be shown as a number between 1 and 8, with 1 as the bottom landing.
2. If the floor position is not known (such as on initial installation) then message #4 will show "?".

Message # 5 will be replaced with one of the following messages:

1. "UP" – the car is running up.
2. "DN" – the car is running down.

3. "DC" – the doors closed input is on.
4. "DO" – the doors closed input is off. The car cannot run.

Message # 6 will be replaced with one of the following messages:

1. "UL" – the car is leveling up.
2. "DL" – the car is leveling down.
3. "DZ" – the car is in the Door Zone.
4. "FS" – the car is running fast speed.
5. "SS" – the car is running slow speed.
6. "(no message)" – the car is not running, and it is not in the door zone.

If the appropriate fault exists, **Message # 7 and #8** will be replaced with one of the following messages:

1. "IO-FAULT" – the communication with one or more of the I/O boards has failed.
2. "DrChkFLT" – the Door Closed Input is on, and the Door Closed Limit is on, indicating the Door Contacts have been jumped.
3. "DrLmtFLT" – the Door Open Limit and the Door Close Limit are both off.
4. If none of these three faults are present, then messages # 7 and # 8 will show the door status as shown below.

Message # 7 will be replaced with one of the following messages:

1. "OPNG" – the doors are opening.
2. "CLSG" – the doors are closing. This is also displayed when the car is running, and the Door Close output is on.
3. "OPEN" – the doors are fully open.
4. "CLSD" – the doors are fully closed.
5. "STOP" – the doors have stopped and are not fully open or fully closed.

Message # 8 will be replaced with one of the following messages:

1. "NUD" – Nudging Operation has been initiated.
2. "TDO" – the Door Open Timer has tripped. The doors failed to open fully in the preset time.
3. "TDC" – the Door Close Timer has tripped. The doors failed to close fully in the preset time.
4. "TEE" – the Electric Eye Cutout Timer has tripped. The Electric Eye Input will be cut out.
5. "(no message)" – none of the four conditions above are present.

7.1.6 Go To Set-Up Mode

This selection allows the controller to be taken out of normal operation, and put in the Set-up Mode, so that features and settings may be changed.



When **Ent** is pressed at this selection, a warning screen will be displayed, indicating that the controller will stop.

If **Ent** is pressed again, then the controller will turn off all outputs and the controller will go into the Set-up Mode. A banner will be displayed for 1 second indicating the Set-up Mode has been entered. The first selection of the Set-up Menu will then be displayed.

If any other key is pressed from the warning screen, the controller will return to the Run Mode, and the controller will continue operating as normal.

LED D5 will flash every 10 seconds in the Set-up Mode, indicating that the CPU is still running normally.

7.1.7 Effect of Diagnostic Modes on Scan Time

The micro-processor scan time is very fast, with each scan taking about 7 milliseconds. Servicing the LCD display is one of the more time consuming tasks that the micro-processor does, so when the LCD display needs to be updated regularly, the micro-processor must slow down to allow it to accept the data. Consequently, the scan time is slower when in the "Show I/O Status" and "Show Internal Memory" Modes, than when displaying other screens. The car will still operate normally, but it is recommended that the display not be left in those modes when those screens are not specifically being used. The LCD can be left showing the "Show Car Status" screen, since this updates the screen while the I/O is being polled, consequently the impact on the scan time is minimal.

With program version 3A, dated March 2005, the scan time has been optimized for IO communication, so the impact on scan time is minimal no matter what screen is being viewed.

7.2 Set-Up Mode

7.2.1 How to Enter Set-Up Mode

In the Run Mode, press **Nxt** until the selection "Go To Setup Menu" is shown, then press **Ent**. Press **Ent** when the "Warning" message is displayed.

WARNING: The elevator will stop immediately and be completely shut down, as all outputs will be turned off when the Set-up Mode is entered.

The LEDs D1-D4 are not updated in the Setup Mode, so they will remain in their last state. LED D5 will flash once every 10 seconds, to indicate the CPU is not locked up.

7.2.2 How to Exit Set-Up Mode

Press **Esc** from the Set-up Menu to return to the Run Mode. The controller will start running again, and will be in the Show Car Status Mode. LED D5 will start flashing about once a second, indicating the CPU is scanning. LEDs D1-D4 will revert to their normal operation.

NOTE: It may be necessary to press Esc to exit a sub-menu and return to the Set-up Menu, before going back to the Run Mode.

7.2.3 Set-Up Mode Screens

The following Menu items are available in the Set-up Mode:

1. Reset Settings.
2. Change Settings.
3. Change Features.
4. Show Fault Log.
5. Show Internal Memory.
6. Set The Time.
7. Enter Password.
8. Test I/O Boards.

SETUP MODE SCREENS

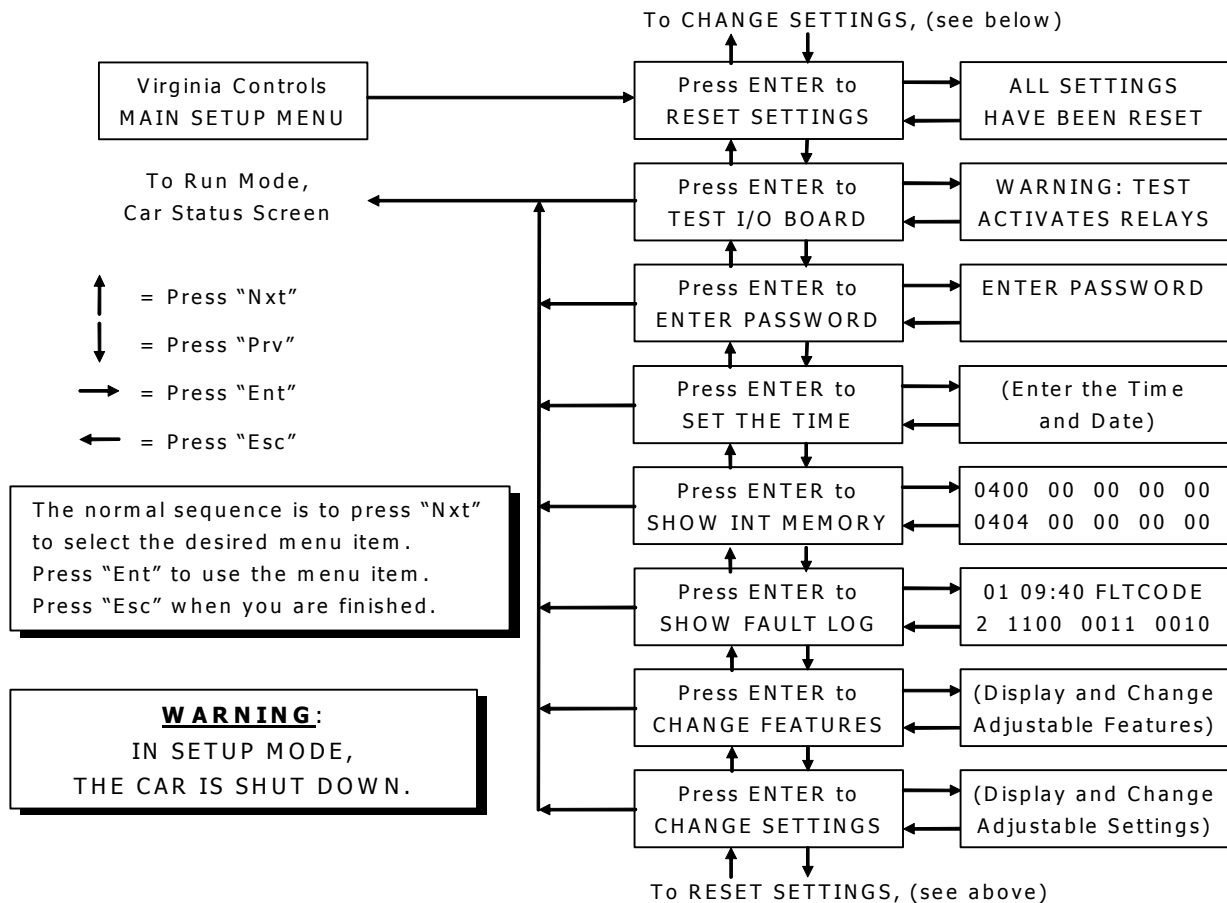

Press the **Nxt** or **Prv** keys to move through the Set-up Menu to the desired item, then press **Ent** to select the menu item.

7.2.4 Reset Settings

This selection allows all settings and features to be reset to the factory values that are stored in the EPROM. This should be done on initial installation, and is recommended if the operation of the car seems strange. (See the warning below.)

Press **Ent** to reset all settings and features to the values programmed from the factory. After pressing **Ent** the password entry screen will be shown. This prevents accidentally resetting the default values. The password must be entered each time the Reset Settings is attempted. Enter the password "911" then press **Ent** to reset all settings and features to the factory default. Press **Esc** to exit without resetting the settings and features. If the job is a standard job, then the specific settings and features for your job must be entered after doing a factory reset. (See the warning note below)

Press **Nxt** or **Prv** to move to another item in the Set-up Menu.

Press **Esc** to return to the Run Mode.

NOTE: An internal memory check is done on each power up. So if a corrupted memory is detected, a factory reset will be done automatically.

WARNING: On standard jobs, the factory reset will return the settings and features to a generic default. The actual settings and values for the specific job must now be entered to customize the job for the particular application. To determine if a particular controller has a standard program, go to the banner screen. If the value in the lower left of the screen is the Virginia Controls Job Number, then the chip is specific for that job, and a factory reset will load the values for that job. If the value is not the job number, (it will start with "DSS", "DDS", "DAS", or something similar) then the program is a standard, and the actual values for the job need to be entered. These values are provided with the controller in the schematic, and are based on the requirements of the job, as conveyed to Virginia Controls.

A factory reset can also be done without the keypad as follows:

1. Turn off the power
2. Turn the Inspection Switch to "Inspection" (or remove the field wire from terminal 23)
3. Jump terminals 1 to 21 and 22 (Up and Down Level Switch Inputs)
4. Turn the power back on for 10 seconds. Inputs 1 and 2 on Board 1 should both be ON, and Input 3 on Board 1 should be OFF.
5. Turn off the power
6. Remove all jumpers and put the car back on normal operation.

7.2.5 Change Settings

Use this selection to change the settings described below. Each setting contains a value from 0 to 255. As you scroll through the settings, the current value will be displayed. A new value may be entered over the old value, as desired.

NOTE: The Password "911" is required to gain access to this menu selection, unless the password has already been entered in another sequence.

Press **Nxt** to go to the next setting, without changing the current setting.

Press **Prv** to go to the previous setting, without changing the current setting.

Press a numeric key (**0** - **9**) to enter a new value. (The decimal point key **.** is not used)

Press **Ent** after entering a new value to load the new value into memory. (The message "VALUE SAVED!" is displayed for 1 second, indicating the new entry has been accepted, then the display will show the setting and the new value) If **Nxt**, **Prv** or **Esc** is pressed after entering a new value, the new value will NOT be stored in memory.

Press **Esc** to go back to the Setup Menu.

If an incorrect value is entered, press **Esc** to clear the value before it is accepted, then enter the correct value; or press **Nxt** or **Prv** to move to the next setting. If the value was already entered, by pressing **Ent**, then press **Nxt** or **Prv** to return to the incorrect setting, enter the proper value, and press **Ent**.

7.2.5.1 Description of Settings

Refer to the sheet MVFAC-3000 Settings in the schematic to see the settings and features provided for each particular job. The following Settings are standard:

NOTE: A value of 0 to 255 can be entered unless otherwise stated.

- **Number of I/O Boards** - (Display shows "NUM.OF IO BOARDS") This is the number of Input and Output Boards that the CPU will address, and is a value between 1 and 8. If a value out of this range is entered, then a default value of 2 will be entered when the car is put back into the Run Mode.
- **Number of Landings** - (Display shows "NUMBER OF LDGS") This is the number of landings that the controller can serve, and is a value between 2 and 8. If the controller is set up to serve future landings, then this value can be used to temporarily cut off future upper landings. This value also determines which floor the controller will reset to when a top landing reset is initiated with a pulsing selector.
- **Main Fire Landing** - (Display shows "MAIN FIRE LDG") This is the number corresponding to the Main Fire Landing, and is a number between 1 and 8. The value set is based on the bottom floor being "1", the 2nd floor is "2" etc., even if this does not match the building designations.

CAUTION: If it is set to a value greater than the number of landings served, the car will go to the top landing, but it will not open its doors.

- **Alternate Fire Landing** - (Display shows "ALT. FIRE LDG") This is the number corresponding to the Alternate Fire Landing, and is a number between 1 and 8. The value set is based on the bottom floor being "1", the 2nd floor is "2" etc., even if this does not match the building designations.

CAUTION: If it is set to a value greater than the number of landings served, the car will go to the top landing, but it will not open its doors.

- **Home Landing (SIMPLEX ONLY)** - (Display shows "HOME LANDING") This is the home landing for a simplex car. The car can be selected to home to this landing, if desired. This value can be set to any valid landing, as determined by the number of landings setting.
- **Dispatch Landing (DUPLEX ONLY)** - (Display shows "DISPATCH LDG") This is the dispatch landing for duplex systems. One car will always home here. This value can be set to any valid landing, as determined by the number of landings setting.
- **Upper Home Landing (DUPLEX ONLY)** - (Display shows "UPPER HOME LDG") This is the home landing for the free car in a duplex system. The free car can be selected to home to this landing, if desired. This value should be set to be inside the upper zone, as determined by the Low Zone assignments shown later in the features settings.
- **Front Door Code** - (Display shows "FRONT DOOR CODE") This is a binary coded value used to select which front openings are enabled. Each bit corresponds to a landing. If the bit for a landing is on, then the front doors at that landing will be enabled. Use the chart shown in the schematic to determine the proper value. Add up the value for each floor to determine the total value for this setting. A value of "255" will enable the front doors at all floors.

- **Rear Door Code** - (Display shows "REAR DOOR CODE ") This is a binary coded value used to select which rear openings are enabled. Each bit corresponds to a landing. If the bit for a landing is on, then the rear doors at that landing will be enabled. Use the chart in the schematic to determine the proper value. Add up the value for each floor to determine the total value for this setting. A value of "0" will disable the rear doors at all floors.
- **Low Zone Code (DUPLEX ONLY)** – (Display shows "LOW ZONE CODE") This value determines which floors are in the Low Zone. The floors will normally be served by the Lobby car, other floors will normally be served by the Free car. Each bit corresponds to a landing. If the bit for a landing is on, then that floor is in the Low Zone. Use the chart shown in the schematic to determine the proper value. Add up the value for each floor to determine the total value for this setting. A value of "3" will set the Low Zone as the bottom two floors.

The Bit Features are multiple features combined into several settings. Each setting consists of 8 features that can be turned on or off individually. Refer to the sheet MVFAC-3000 Settings in the schematic for a breakdown of each setting. A description of the standard features that may be part of the Bit Features are listed in a following section, after the standard settings.

- **Bit Features # 1** - (Display shows "BIT FEATURES # 1") This is a binary coded value used to select various features as shown in the chart in the schematic on the MVFAC-3000 SETTINGS sheet. Each bit corresponds to a different feature. If the bit for a feature is on, then that feature is enabled. Use the chart to determine the proper value. Add up the value for all the features that should be enabled to determine the total value for this setting.
- **Bit Features # 2** - (Display shows "BIT FEATURES # 2") Similar to Bit Features #1.
- **Bit Features # 3** - (Display shows "BIT FEATURES # 3") Similar to Bit Features #1.
- **Bit Features # 4** - (Display shows "BIT FEATURES # 4") Similar to Bit Features #1.
- **Bit Features # 5** - (Display shows "BIT FEATURES # 5") Similar to Bit Features #1.
- **Bit Features # 6** - (Display shows "BIT FEATURES # 6") Similar to Bit Features #1.
- **Bit Features # 7** - (Display shows "BIT FEATURES # 7") Similar to Bit Features #1.
- **Bit Features # 8** - (Display shows "BIT FEATURES # 8") Similar to Bit Features #1.
- **Bit Features # 9** - (Display shows "BIT FEATURES # 9") Similar to Bit Features #1.
- **Bit Features # 10** - (Display shows "BIT FEATURES # 10") Similar to Bit Features #1.
- **Custom Time #0.1** – (Display shows "CUSTOM TIME #0.1") This is a reserved value that is not assigned, but may be assigned a function for a specific job. The time base for this timer is not preset, and may change depending on its use. Refer to the Settings sheet in the schematic to see if and how this setting is used.
- **Custom Time #0.2** – (Display shows "CUSTOM TIME #0.2") Similar to Custom Time #0.1.
- **Custom Time #0.3** – (Display shows "CUSTOM TIME #0.3") Similar to Custom Time #0.1.
- **Custom Time #0.4** – (Display shows "CUSTOM TIME #0.4") Similar to Custom Time #0.1.
- **# of Fault Resets** – (Display shows "# Fault Resets.") This is the number of automatic fault resets allowed. The controller can be set up to automatically reset the Running Timer Fault and the Start/Stop Sequence Fault. This can be done for the number of times set by this setting. The count

of automatic resets is reset if the car is put on Inspection, or the power is cycled, or the car runs without a fault for 40 minutes.

- **RopeBrake Check Time** (in hundredths of a second) – (Display shows “ROPE CHECK TIME”) Sets the delay between each check, during the Rope Brake Check sequence before a run.
- **Door Time, Hall** (in tenths of a second) - (Display shows "DOOR TIME, HALL") This is the time in tenths of a second, that the doors will remain open, after they have opened fully, when the car has stopped in response to a hall call. After this time, the doors will start to close.

NOTE: If a car call is entered while the doors are open, the door time will be reduced to the "Door Time, Car" setting. If the Door Close Button is pressed while the doors are open, the door time will be reduced to the "Door Time, Short" setting. This setting is normally 50, for a time of 5 seconds.

- **Door Time, Car** (in tenths of a second) - (Display shows "DOOR TIME, CAR") This is the time in tenths of a second, that the doors will remain open, after they have opened fully, when the car has stopped in response to a car call only. After this time, the doors will start to close.

NOTE: If a car call is entered, or the Door Close Button is pressed, while the doors are open, the door time will be reduced to the "Door Time, Short" setting. This normal setting is 20, for a time of 2 seconds.

- **Door Time, Short** (in tenths of a second) - (Display shows "DOOR TIME, SHORT") This is the time in tenths of a second, that the doors will remain open, after they have opened fully, when the doors have reopened in response to a Door Open Button/Safety edge/Electric Eye/Infra-red Curtain, and no hall call is entered. After this time, the doors will start to close. The normal setting is 10, for a time of 1 second.
- **Leveling Cutout Time** (in tenths of a second) - (Display shows "LEVELING LOCKOUT") This is the time in tenths of a second that the leveling switches are cut out after the start of a floor to floor run. It allows the external relays to energize and lock out the leveling switches externally. The normal setting is 20, for a time of 2 seconds.
- **O-P Delay Drop After Stop** (in tenths of a second) – (Display shows “DELAY DROP O_P.”) Sets the delay before dropping the P output.
- **O-PX Delay Drop After Stop** (in tenths of a second) – (Display shows “DELAY DROP O_PX”) Sets the delay before dropping the PX output.
- **Stop Sw Delay** (in tenths of a second) – (Display shows “STOP SW. DELAY.”) Sets the delay before stopping the car after the Stop Sw is opened. This allows the car to slow down before generating a fault.
- **Back Call Delay (DUPLEX ONLY)** (in tenths of a second) - (Display shows "BACK CALL DELAY") This is the time in tenths of a second that the back call signal will be delayed before letting the other car respond to calls behind this car. The normal setting is 10, for a time of 1 second.
- **Custom Time #1.1** (in tenths of a second) - (Display shows "CUSTOM TIME #1.1") This is a reserved value that is not assigned, but may be assigned a function for a specific job.
- **Custom Time #1.2** (in tenths of a second) - (Display shows "CUSTOM TIME #1.2") See Custom Time # 1.1

- **Custom Time #1.3** (in tenths of a second) - (Display shows "CUSTOM TIME #1.3") See Custom Time # 1.1
- **Shutdown Time** (in seconds) - (Display shows "SHUTDOWN TIME") If the car runs up without passing a floor for this time, then shutdown will be initiated. The car will stop, and shut down. The car can be returned to service by cycling the Inspection Switch, or the Main Line Disconnect Sw. The normal setting is 25 seconds.
- **Door Nudging Time** (in seconds) - (Display shows "NUDGING TIME") This is the time delay before initiating door close nudging, if that feature is provided. A call must be registered, and the car must be in automatic operation. The timer is reset when the doors get fully closed, or when the car starts a floor to floor run. The normal setting is 25 seconds.
- **Electric Eye Cutout Time** (in seconds) - (Display shows "EYE CUTOFF TIME") This is the time delay before cutting out the Electric Eye Input, after it has been continuously energized. It is reset when the car runs to the next floor. The normal setting is 20 seconds.
- **Homing Delay Time** (in seconds) - (Display shows "HOMING DELAY") This is the delay before homing a car to the home landing, after it has answered all calls, and is sitting with its doors closed. The normal setting is 10 seconds.
- **Car Stuck Time** (in seconds) - (Display shows "CAR STUCK TIME") This is the time delay before calls at the same landing as the car are disabled, so that the car can answer other registered calls. This operates as a stuck button timer. The normal setting is 15 seconds.
- **Door Stuck Time** (in seconds) - (Display shows "DOOR STUCK TIME") This is the time delay before stopping a door open or close cycle. The normal setting is 20 seconds
- **Door Stuck Reset Time** (in seconds) - (Display shows "DOOR RESET TIME") This is the time that the doors are held open after failing to close properly, before retrying to close. The normal setting is 10 seconds.
- **Delay Before Canceling Independent Service on Fire Service** - (Display shows "KILL IDS ON EFS1") This is the time delay before Independent Service is cut out, when Fire Service Phase 1 is initiated. This feature can be modified by the Bit Features described above that determine if and when Independent Service is cut out on Fire Service. The normal setting is 30 seconds.
- **Door Close Delay Time on Fire Service** (in seconds) - (Display shows "DR CLOSE ON FIRE") This is the delay before closing the doors after the car has returned on Fire Service Phase 1 to the Main Ldg. It may be required, depending on the Fire Code used. The normal setting is 30 seconds.
- **Call Help Time (DUPLEX ONLY)** (in seconds) - (Display shows "CALL HELP TIME") This is the amount of time a hall call can be registered before the other car not assigned this call will respond to the call. The normal setting is 30 seconds.
- **Non Interference Time (SAPB ONLY)** (in seconds) - (Display shows "NON INTERFERENCE") This is the time that the In Use Light will remain on after the car has answered a call and cycled its doors. Hall Call Buttons will be disabled during this time. The normal setting is 6 seconds.
- **Custom Time #2.1** (in seconds) - (Display shows "CUSTOM TIME #2.1") This is a reserved value that is not assigned, but may be assigned a function for a specific job.
- **Custom Time #2.2** (in seconds) - (Display shows "CUSTOM TIME #2.2") See Custom Time # 2.1
- **Custom Time #2.3** (in seconds) - (Display shows "CUSTOM TIME #2.3") See Custom Time # 2.1

- **Position Indicator Cutout Time** (in tens of seconds) - (Display shows "PI CUT OUT TIME ") This is the time delay before turning off the Position Indicators, after the car has become idle. If the doors are opened, or the car starts in response to a call, then the Position Indicators will turn on again. The normal setting is 30, for a time of 5 minutes. To keep the PI's on at all times, enter a value of "0" for the Cutout Time.
- **Custom Time #3.1** (in tens of seconds) - (Display shows "CUSTOM TIME #3.1") This is a reserved value that is not assigned, but may be assigned a function for a specific job.
- **Custom Time #3.2** (in tens of seconds) - (Display shows "CUSTOM TIME #3.2") See Custom Time # 3.1
- **Custom Time #3.3** (in tens of seconds) - (Display shows "CUSTOM TIME #3.3") See Custom Time # 3.1

Some installations require specific settings or features that are not included in the standard program. In this case, a separate sheet (or sheets) will be provided that describe the operation of these settings or features, and what the factory default settings are.

7.2.5.2 Description of Bit Feature Settings

The following features are combined into the Bit Features 1 through 10. Refer to the sheet MVFAC-3000 Settings in the schematic to see the settings and features provided for each particular job. The following Settings are standard.

- **Disable Fire Service** – Turn this feature on to disable Fire Service. This feature should be turned on if Fire Service is not provided. It may also be turned on during initial installation, if the Smoke Sensors or Fire Switches have not yet been installed.
- **Enable 2000 ANSI Fire Code** – Turn this feature on to enable 2000 or 2004 National Fire Code. The default code is 1998 Fire Code.
- **Enable 2005+ ANSI Fire Code** – Turn this feature on to enable 2005 or later National Fire Code. You must also turn on the 2000+ Fire Code feature.
- **Flash Fire Light per 2005 Code** – Turn this feature on to make the Fire Light flash based on the requirements of 2005 and later ANSI codes. With this enabled, the Fire Light will only flash if Fire Service was initiated by the Smoke Sensors connected to terminal 82F (Machine Room and Hoistway Smoke Sensors). If those sensors trip after Fire Service is already initiated, then the Fire Light will not flash.
- **Enable New York Fire Code** – Turn this feature on to enable New York Fire Code.
- **Enable 2001 Chicago Fire Code** – Turn this feature on to enable 2001 Chicago Fire Code
- **Enable 1998 Chicago Fire Code** – Turn this feature on to enable 1998 Chicago Fire Code
- **Use 2 Inputs for 1998 Chicago Fire Code** – Turn this feature on to use 2 inputs for the Fire Inputs for Chicago 1998 Fire Code.
- **Enable Canadian Fire Code** – Turn this feature on to enable 1998 Canadian B44 Fire Code
- **Enable Bldg Fire Sw for 2000 Fire Code** – Turn this feature on to enable the Remote Fire Sw on 2000 Fire Code. The input for this feature must have been assigned for this feature to work properly.

- **Allow Full Door Operation on Fire2 and StopSw** – Turn this feature on to allow the doors to be opened and closed on Fire Service Phase 2 with the In Car Stop Sw in the off position. With this feature off, the doors will not close if the Stop Sw is in the open position. Check the applicable codes to see if this is required.
- **Kill Independent immediately on Fire Service** – Turn this feature on to allow Fire Service to override Independent Service immediately.
- **No Timed Kill of Independent on Fire Service** – Turn this feature on to prevent Fire Service from overriding Independent Service. Independent Service must be turned off or the doors closed by the operator to allow the car to run on Fire Service.
- **Never kill Indep. on Fire Service** – Turn this feature on to prevent Fire Service from overriding Independent Service. Independent Service must be turned off to allow the car to run on Fire Service.
- **Main Fire Landing at Rear Opening** – Turn this feature on to use the rear opening at the designated fire opening, instead of the front opening. If there is only one opening at the designated fire landing, then this feature will have no effect.
- **Alternate Fire Landing at Rear Opening** – Turn this feature on to use the rear opening at the alternate fire opening, instead of the front opening. If there is only one opening at the alternate fire landing, then this feature will have no effect.
- **Disable Shunt Trip on Fire Service Phase 2** – Turn this feature on to disable Shunt Trip operation when the car is on Fire Service Phase 2.
- **Enable Shunt Trip on Inspection** – Turn this feature on to enable Shunt Trip operation when the car is on Inspection.
- **Disable ECReturn Latch on 2000 Fire Code** – Turn this feature on to disable the holding circuit on Fire Service Phase 2 Return on 2000 (or later) Code. This allows the Return mode to be cancelled by turning the Fire Switch to the “On” position. Check the appropriate code to see if this is required or allowed.
- **Enable Pulsing Selector (off=Floor Sws)** – Turn this feature on to enable a pulsing floor selector, rather than individual Floor Switches. With a pulsing arrangement, there is an up or a down pulse to change floors. Additionally at the terminal landings, enabling the up pulse input and the door zone input will reset to the top landing, while energizing the down pulse and door zone will reset the floor position to the bottom landing.
- **Enable Separate Call I/O (4 Wire Calls)** – Turn this feature on to enable separate wiring for the inputs and outputs for the car and hall calls. If this feature is disabled then the car and hall call inputs are connected to the corresponding outputs.
- **Enable Door Check Feature** – Turn this feature on to enable the Door Check feature. This allows the status of the Car Door and the Hall Doors to be checked according to the appropriate codes.
- **Enable Redundancy Fault Checking** – Turn this feature on to enable 2000 (or later) code redundancy fault checking. This enables the redundancy fault timers, and checks the leveling inputs and running inputs for stuck relays or contacts, according to the 2000 (or later) code.
- **Use Car Lantern outputs for Hall Lanterns** – Turn this feature on to use the Car Lantern outputs as Hall Lanterns. If there are only two landings, then the Hall Lanterns can be connected directly to the

Car Lantern outputs. If there are more than two landings, then additional external relays are needed to enable the appropriate lantern at each floor.

- **Do Not Run On Fire Service and BORIS** – Turn this feature on to prevent the car from running if Fire Service is enabled while on battery backup operation.
- **Do Not Run on Fire Service and Shutdown** – Turn this feature on to prevent the car from running if Fire Service is enabled while on shutdown. If this feature is not enabled the car will be allowed to run down on Fire Service and shutdown.
- **Allow Door Zone Fault on Fast Speed** – Turn this feature on to allow the Door Zone Fault to be initiated if the car is running fast speed and the input is on. False trips are prevented by the Leveling Cutout Timer, which prevents a fault as the car starts, and before the FSU/FSD relays energize.
- **Allow Stop at Upper Floor on Shutdown** – Turn this feature on to allow the car to stop at an upper floor on shutdown if it is the main floor. Check with the appropriate codes to see if this is allowed or required.
- **Enable CKO on Independent** – Turn this feature on to energize the CKO Car Call Cutout Override output on Independent Service. This will allow car calls to be registered without the use of access keys.
- **Fire Sensors are Normally Open Inputs** – Turn this feature on if the Smoke Sensor inputs are normally open on normal operation, and close when a fire is detected. The default is to use Smoke Sensors that are closed on normal operation and open when a fire is detected.
- **Dir Indicators show actual direction on Attend.** – Turn this feature on to make the Attendant Direction Indicators show the direction that the car will run next. If this feature is not enabled then they will show whether there are calls registered in either direction. For example, with this feature off, and the car at an intermediate floor with calls above and below the car, then both Attendant Direction Indicators would be on, since there are calls above and below the car. If the feature was enabled, then the indicators would be the same as the normal Direction Indicators, and only one indicator would be on, depending on which direction had actually been selected.
- **Med Emerg Buzzer on Independent only** – Turn this feature on to change the operation of the Medical Emergency Buzzer output. With the feature disabled (factory default) the buzzer will come on while the car is returning to the Medical Emergency floor in response to the hall Medical Emergency Switch. If the feature is enabled, the buzzer will come on if the car is on Independent Service and a hall Medical Emergency Switch is turned on. This alerts the operator to release the car.
- **Always Enable DOB at Front Openings** – Turn this feature on to allow the Front Door Open Button to always open the doors at selective openings (where there is a front and rear opening at the same landing). With this feature disabled, the doors must have been opened, or still be open, for the Door Open Button to operate. This allows a measure of security at these landings.
- **Always Enable DOB at Rear Openings** – Turn this feature on to allow the Rear Door Open Button to always open the doors at selective openings (where there is a front and rear opening at the same landing). With this feature disabled, the doors must have been opened, or still be open, for the Door Open Button to operate. This allows a measure of security at these landings.
- **Disable Non-Shutdown Faults in Fault Log** – Turn this feature on to disable faults from being logged into the Fault Log that are not shutdown faults. This keeps the fault log clear of non-essential faults.

The following faults will not be logged if this feature is enabled: TDOPEN, TDCLOSE, TDOPN-R, TDCLO-R, CARSTUK, DRCONTS, OUT-DZ, COMMFLT, FIRE, MRSMOKE, SHUNT, FLOOD

- **Flood Return Ldg is 3 (not 2)** – Turn this feature on to make the car return to the third landing from the bottom if Flood Service is initiated. The default floor is the second floor from the bottom.
- **Flood Return Ldg is Top Ldg (not 2)** – Turn this feature on to make the car return to the top landing if Flood Service is initiated. The default floor is the second floor from the bottom.
- **Flood overrides Independent, Attendant, Med Emerg** – Turn this feature on to allow Flood Service to override Independent Service, Attendant Operation and Medical Emergency Operation. If this feature is not enabled, then the car will remain under the control of the operator if the Flood Service input is energized.
- **Flood overrides Shutdown (Low Oil, Rev. Phase, etc.)** – Turn this feature on to allow Flood Service to override shutdown functions that would normally return the car to the bottom landing. The car will still not be able to run up, but Flood Service will remain in effect even though a shutdown feature is in effect.
- **Fire Service Overrides Flood Operation** – Turn this feature on to allow Fire Service to override Flood Service. The car will return to the Main Fire Floor, even if that is the bottom landing.
- **Flood Operation Overrides Hall Fire Service** – Turn this feature on to allow Flood Service to override Fire Service, and cause the car to leave the bottom landing, even if that is the designated Fire landing. If this feature is not set, then whichever feature (Fire Service or Flood Service) is initiated first will take precedence.
- **Disable Non-Shutdown Faults in the Fault Log** – Turn on to prevent non-shutdown faults from being logged in the fault log. This will prevent faults TDOPEN, TDCLOSE, TDOPN-R, TDCLO-R, CARSTUK, DRCONTS, OUT-DZ, COMMFLT, FIRE, MRSMOKE, SHUNT, FLOOD from being logged.
- **Enable Shunt Trip Feature** – Turn on to enable the Shunt Trip feature. The input and output for this feature must have been assigned for this feature to work properly. This feature can be turned off to disable the Shunt Trip if it was supplied, but is not required. Shunt Trip operation can be accomplished externally to the controller, if desired.
- **Enable Rear Door Open Output** – Turn on to enable the Rear Door Open output at point 8 on the first output board.
- **Enable RD (RearDoor) Output** – Turn on to enable the RD output at point 8 on the first output board. This is used with front and rear doors only.
- **Enable 1UL - 4DL Hall Lantern Outputs** – Turn on to enable specific Hall Lantern outputs. The outputs for this feature must have been assigned for this feature to work properly.
- **Enable Nudging Output** – Turn on to enable the Nudging Output. This is not required for Nudging Operation, as the Nudging Buzzer output is the only output specifically required. The output for this feature must have been assigned for this feature to work properly.
- **Enable CKO Output** – Turn on to enable the CKO, Car Call Cutout Override, output. The output for this feature must have been assigned for this feature to work properly.
- **Enable PI Blanking Fire Output** – Turn on to use the Fire Light output as a Position Indicator Blanking output.

- **Enable Car To Lobby Input** – Turn on to enable the Car To Lobby Shutdown inputs. The input for this feature must have been assigned for this feature to work properly.
- **Enable Park With Doors Open** – Turn on to make the car park with the doors open at the Main Landing.
- **Enable Park With Doors Open at All Ldgs** – Turn on to make the car park with the doors open at all landings.
- **Manual Reset on Redundancy and Door Zone Faults** - Enable this bit feature to require Redundancy and Door Zone faults to be reset manually. Cycling power will not reset those faults. This feature is used in conjunction with the Latched Fault feature described above.
- **Disable Reset at Intermediate Floors** - Enable this bit feature to disable position resets at intermediate floors. The car will still reset at terminal landings, based on the Door Zone input and the Up or Down Slowdown inputs.
- **Disable Fault Latch Feature** – Turn this feature on to disable the feature that latches faults. Faults are latched for compliance with the 2010 and later codes. If this feature is NOT turned on, then faults must be reset by jumping the Fault Reset Input or by turning on Sw4 on the CPU Dip Sw block. With this feature on, faults can be reset by cycling power or by cycling the Inspection Sw.

7.2.5.3 Features used on Duplex controllers only

- **Elev A Select (A=ON, B=OFF)** – Turn this feature on to enable
- **Only this car serves Front Calls at Ldg 1** – Turn this feature on if the other car in the duplex does not serve this opening, but this car does.
- **Only this car serves Front Calls at Ldg 2** – Turn this feature on if the other car in the duplex does not serve this opening, but this car does.
- **Only this car serves Front Calls at Ldg 3** – Turn this feature on if the other car in the duplex does not serve this opening, but this car does.
- **Only this car serves Front Calls at Ldg 4** – Turn this feature on if the other car in the duplex does not serve this opening, but this car does.
- **Only this car serves Front Calls at Ldg 5** – Turn this feature on if the other car in the duplex does not serve this opening, but this car does.
- **Only this car serves Front Calls at Ldg 6** – Turn this feature on if the other car in the duplex does not serve this opening, but this car does.
- **Only this car serves Front Calls at Ldg 7** – Turn this feature on if the other car in the duplex does not serve this opening, but this car does.
- **Only this car serves Front Calls at Ldg 8** – Turn this feature on if the other car in the duplex does not serve this opening, but this car does.
- **Only this car serves Rear Calls at Ldg 1** – Turn this feature on if the other car in the duplex does not serve this opening, but this car does.
- **Only this car serves Rear Calls at Ldg 2** – Turn this feature on if the other car in the duplex does not serve this opening, but this car does.

- **Only this car serves Rear Calls at Ldg 3** – Turn this feature on if the other car in the duplex does not serve this opening, but this car does.
- **Only this car serves Rear Calls at Ldg 4** – Turn this feature on if the other car in the duplex does not serve this opening, but this car does.
- **Only this car serves Rear Calls at Ldg 5** – Turn this feature on if the other car in the duplex does not serve this opening, but this car does.
- **Only this car serves Rear Calls at Ldg 6** – Turn this feature on if the other car in the duplex does not serve this opening, but this car does.
- **Only this car serves Rear Calls at Ldg 7** – Turn this feature on if the other car in the duplex does not serve this opening, but this car does.
- **Only this car serves Rear Calls at Ldg 8** – Turn this feature on if the other car in the duplex does not serve this opening, but this car does.

7.2.5.4 Features used with Single Automatic Pushbutton controllers only

- **Enable Single Button Collective Operation** – Turn this feature on to enable Single Button Collective operation instead of Single Automatic Pushbutton operation. Single Button Collective allows multiple calls to be entered, with calls being answered in sequence as the car reaches them. Single Automatic Pushbutton operation only allows one calls at a time.
- **Enable Door Auto Close** – Turn this feature on to enable the Automatic Door Close outputs. The Door Close outputs and the appropriate external interface circuits for the Door Operator must be provided for this feature to work. Unless additional features affecting the Door Close output are energized, the Automatic Door Close output will be energized on Fire Service Phase 1 (Hall) to close the doors and allow the car to return to the designated landing.
- **Enable Door Auto Close from Car Buttons** – Turn this feature on to allow the automatic Door Close output to be energized when a Car Call Button is pressed.
- **Enable Door Auto Close from Hall Buttons** – Turn this feature on to allow the automatic Door Close output to be energized when a Hall Call Button is pressed.
- **Drop ESB with Door Open Limit** – Turn this feature on to de-energize the ESB Stop Switch Bypass output when the car has returned to the designated landing and opened the doors.
- **Drop MF Output on Fire 2000 Code** – Turn this feature on to allow the MF output to de-energize if the car has returned to the designated fire landing, and is on shutdown. With 2000 Fire Code, the doors should close under these circumstances.
- **Enable Shunt with Door Open Limit** – Turn this feature on to enable the Shunt Trip output when the Door Open Limit indicates the doors are open. If this feature is disabled, the Shunt Trip output will come on shortly after the car stops, even if the doors have not opened. This feature should only be enabled if there are power operated doors that also have a Door Open Limit signal connected to the controller.
- **Enable Timed Door Open Fault in Fault Log** – Turn this feature on to enable the TDOPEN fault in the Fault Log. This feature should only be enabled with power operated doors. If it is enabled with manual doors, then a fault will be logged every time the car stops and the doors are not opened.

- **Enable Door Reopen for Courion Doors** – Turn this feature on to enable the ECH signal to the power operated doors when the car is on Fire Service and the Car Fire Sw is turned from the Off position back to Hold or On. This is used with Courion door operators to reopen the doors.
- **Enable 2007+ Fire Code for Manual Doors** – Turn this feature on to allow Fire Service Phase 2 (Car) to be initiated if the doors have been opened at the Main Ldg, even though they may now be closed. This is allowable in the 2007 and later Fire Code.
- **Enable Door Close After Shutdown Return** – Turn this feature on to make the doors park closed after the car has returned on shutdown. Check the applicable codes to see if this feature is required.

7.2.5.5 Features used with Triplex controllers only

- **DISPATCH FAILURE CALLS**
- **Run to 1st Ldg on Dispatch Failure** – Turn this feature on to make the car run to this landing if it loses communication with the dispatcher. Set the desired calls to allow the cars to provide service to the building if the dispatcher fails. The car will park with its doors open if it has no registered calls, and the communication has failed.
- **Run to 2nd Ldg on Dispatch Failure** – Turn this feature on to make the car run to this landing if it loses communication with the dispatcher.
- **Run to 3rd Ldg on Dispatch Failure** – Turn this feature on to make the car run to this landing if it loses communication with the dispatcher.
- **Run to 4th Ldg on Dispatch Failure** – Turn this feature on to make the car run to this landing if it loses communication with the dispatcher.
- **Run to 5th Ldg on Dispatch Failure** – Turn this feature on to make the car run to this landing if it loses communication with the dispatcher.
- **Run to 6th Ldg on Dispatch Failure** – Turn this feature on to make the car run to this landing if it loses communication with the dispatcher.
- **Run to 7th Ldg on Dispatch Failure** – Turn this feature on to make the car run to this landing if it loses communication with the dispatcher.
- **Run to 8th Ldg on Dispatch Failure** – Turn this feature on to make the car run to this landing if it loses communication with the dispatcher.
- **Enable Emergency Power** – Turn this feature on to enable Emergency Power operation.
- **Disable Fire Light on Fire Service Phase 2** – Turn this feature on to prevent a car on Fire Service Phase 2 from keeping the Dispatcher Fire Light on.
- **Zone1 (not Zone3) answers empty Zone2** – Turn this feature on to allow a car in Zone 1 to answer a hall call in Zone 2 if there is no car in Zone 2. If this feature is off, then a car from Zone 3 will be given the call.
- **Enable Car A** – Turn this feature on to enable Car A.
- **Enable Car B** – Turn this feature on to enable Car B.
- **Enable Car C** – Turn this feature on to enable Car C.

- **Enable Car D** – Turn this feature on to enable Car D.

7.2.5.6 SPECIAL ADJUSTMENTS with ETSD/UCM BOARD, HSC

This section shows the standard definitions of any Custom Times and Features used for ETSD/UCM Board and the High Speed Counter.

- **HSC FAULT DELAY.** (Value is in tenths of a second) This sets the delay before a High Speed Counter fault is initiated. The car will shut down, and the cause of the fault will be logged.
- **HSC START DELAY.** (Value is in tenths of a second) This sets the delay after the start of a run before the speed is checked for movement, and for proper direction.
- **ETS FAULT DELAY.** (Value is in tenths of a second) This sets the delay before an Emergency Terminal Speed fault is initiated. The car will shut down, and the cause of the fault will be logged.
- **UCM FAULT DELAY.** (Value is in tenths of a second) This sets the delay before an ETSD/UCM Monitoring Fault is logged. It should be set long enough to prevent nuisance faults.
- **1FR HOLD DELAY.** (Value is in tenths of a second) This sets the delay to hold the 1FR output when the car is running full speed and slows down. It allows the car to pass the leveling zone of the previous floor, so that it stops at the correct floor.
- **ENABLE ETSD/UCM BOARD.** Enable this bit feature when the ETSD/UCM Board is used. It enables the Rope Brake check and Redundancy Faults used with the ETSD/UCM Board.
- **DISABLE UCM BOARD REDUNDANCY FAULTS.** Enable this bit feature to disable Redundancy Faults from the UCM Board.
- **ENABLE HIGH SPEED COUNTER.** Enable this bit feature when using an external PLC with a High Speed Counter. This can be turned off temporarily during setup to disable HSC faults.
- **ENABLE EMERGENCY TERMINAL SLOWDOWNS (ETS).** Enable this bit feature when using an ETS system with the ETSD/UCM Board.
- **ENABLE ONE AND TWO FLOOR RUN SPEEDS.** Enable this bit feature when a separate speed is provided for One Floor Runs.
- **ENABLE LONG FLOOR FROM ? to ?.** Enable one of these bit features when there is a long floor at the specified floors. The car will then run full speed between those two floors.

7.2.6 Change Features

Use this selection to change the features described below. Each feature is either on (value of 255) or off (value of 0). As you scroll through the features, the feature will be shown as enabled (ON) or disabled (OFF). The feature may be changed by pressing **Aux** to select the desired operation (on/enabled or off/disabled), then press **Ent** to store the value.

NOTE: The Password “911” is required to gain access to this menu selection, unless the password has already been entered during another sequence.

Press **Nxt** to go to the next feature, without changing the current feature.

Press **Prv** to go to the previous feature, without changing the current feature.

Press **Aux** to toggle the feature between on/enabled or off/disabled.

(The keys **0** - **9** and **.** are not used)

Press **Ent** after selecting a new value to load the new value into memory. (The message "VALUE SAVED!" is displayed for 1 second, to indicate the new value has been accepted.) If **Nxt**, **Prv** or **Esc** is pressed after entering a new value, the new value will NOT be stored in memory.

Press **Esc** to go back to the Setup Menu.

7.2.6.1 Description of Features

Refer to the sheet MVFAC-3000 Settings in the schematic to see the settings and features provided for each particular job. The following features are standard (All features are normally off/disabled, unless otherwise specified):

- **No Shortened Door Time** - (Display shows "NO SHORTDOORTIME") Normally the door time will be shortened by the Door Open Button/Safety Edge/Electric Eye/Infra-red Curtain. Enable this feature to prevent these devices from shortening the door time. This is normally required in nursing homes, where the passengers need more time to enter the car. The Door Close Button will still shorten the door time.
- **Timed Electric Eye Cutout** - (Display shows "TIMED EYE CUTOFF") Enable this feature to allow the Electric Eye input to be disabled after the preset time (see the setting above for the delay before cutting out the Electric Eye). This feature is often provided in the Electric Eye unit itself.
- **Door Nudging** - (Display shows "DOOR NUDGING") Enable this feature to activate door close nudging. Nudging will be initiated if a call is registered and the doors have been prevented from closing for the preset Door Nudging time. The Electric Eye will be disabled, the Nudging Buzzer will come on, and the Nudging Output will come on if the Electric Eye input is energized. This means the door will only close at slow speed if the Electric Eye is blocked.

NOTE: Door Nudging operation requires an optional Nudging Buzzer output and Reduced Speed Door Closing output.

- **One Stroke Down Lanterns** - (Display shows "1 STROKE DN LANT") The lanterns are normally provided with two strokes for the down direction. Enable this feature to provide only one stroke for the down direction.
- **Slow Speed on Inspection** - (Display shows "SLOW ON INSPECT") Enable this feature to run slow speed on Inspection. This is normally required if the car speed is 125fpm or above.
- **Proximity Detector** - (Display shows "PROXIMITY DETECT") Enable this feature if a Proximity Detector (such as an infra-red curtain) is used. Enabling this feature will cause the Safety Edge input to be disabled on Fire Service, and the Door Nudging feature to be initiated while the doors are closing on Fire Service. The Proximity Detector may be connected to the Safety Edge Input or the Electric Eye Input, as desired. (The Electric Eye Input is subject to the Timed Electric Eye Cutout and Nudging, whereas the Safety Edge Input is not.)

NOTE: Door Nudging operation requires an optional Nudging Buzzer output and Reduced Speed Door Closing output.

- **Short Floor** - (Display shows "SHORT FLOORS") The Short Floor selection applies to installations with Floor Switches or Pulsing Switches where the floor height is less than twice the slowdown distance, but more than the slowdown distance plus the leveling zone. If Floor Switches are used, then the Short Floor Setting should be enabled if the Floor Switches overlap at any floor. If Pulsing Switches are used, then the Short Floor Setting should be enabled if the top of any Up target is BELOW the bottom of the Down target for the floor below. With Floor Switches or a Pulsing Selector, if the slowdown overlaps the leveling zone of the adjacent floor, then special short floor circuitry is required, and this setting will not normally apply. (Check for specific instructions for the job.)
- **Enable Homing** - (Display shows "ENABLE HOMING" on Simplex, or "HOME #2 TO MAIN" on Duplex) Enable this feature to enable the homing feature on a Simplex. This will cause the car to home to the Home Landing, when it has been idle for the adjustable Homing delay time.

NOTE: On a Duplex, one car will always home to the Dispatch Main Landing, and, if this feature is set, then the FREE car will also home to the Dispatch Main Landing.

- **Enable Free Car Homing** (Duplex Only) - (Display shows "HOME TO HI ZONE") Enable this feature to home the free car to the Upper Home Landing. If this is not set, then the car will remain where it last stopped.

Some installations require specific settings or features that are not included in the standard program. In this case, a separate sheet (or sheets) will be provided that describe the operation of these settings or features, and what the factory default settings are.

7.2.7 Show Fault Log

This selection is the same as the Show Fault Log in the Run Mode section. The screen shows the fault log, which consists of the last 63 faults and events recorded by the controller. The controller will not log faults in the Setup Mode, but existing faults can be viewed.

Refer to the descriptions in the Show Fault Log section in the Run Mode for a full description of the operation of this screen, and for a description of the fault codes displayed.

7.2.8 Show Internal Memory

This selection is the same as the Show Internal Memory in the Run Mode section. The screen shows the contents of the internal memory. This can be used to check the status of internal registers, to show the operation of the system. Keep in mind that in the Setup Mode, the car is stopped, and all Inputs and Outputs are off.

If the password has not been entered in another screen, then when this screen is selected, the "Password Entry" screen will be displayed. If the password ("911") is entered correctly, then the internal memory can be changed. If it is not entered correctly, then the memory can still be viewed, but cannot be changed.

Refer to the descriptions in the Show Internal Memory section in the Run Mode for a full description of the operation when viewing this screen.

7.2.9 Set the Time

This screen allows the real time clock to be set up. When this selection is made, the current time is displayed, showing the time in 24hour format, and the month, date, and year.

CURRENT TIME
12:22 11/13/01

If these are correct, then press **Esc** to return to the Setup Menu.

If you want to change the time and/or date, then press any other key to continue with the next menu item.

You will be prompted to enter the year (00-99), month (1-12), date (1-31), hour (0-23), and minute (0-59).

ENTER YEAR 00-99
01

In each case, press **Ent** to accept the current value, or enter the correct value then press **Ent**.

If an incorrect value is entered, just enter the correct value again, and press **Ent**. If you press **Esc** during this sequence, then the time and date will not be updated, and the display will return to the setup menu.

After all the data has been entered, the screen will display the new time and date, with the prompt "Enter to accept".

ENTER TO ACCEPT
12:23 11/13/01

Press **Ent** to accept the values. At this point the new time and date will be accepted, and the seconds value will be set to zero. If you press **Esc**, then you will return to the setup menu without entering the new time and date.

The battery is required to keep the real time clock running when power is turned off. Consequently, the real time clock will need to be reset when the battery is changed.

7.2.10 Enter Password

A common password is provided for all controllers. This common password is "911". The password is required when changing a setting (such as Door Time, Fire Return Landing, etc.) or a feature (such as Fire Service Code, Front and Rear Door selections, etc.).

The password can be entered from the Setup Menu, as described below. Each time the Setup Menu is entered, the password access is cleared, so the password must be entered again. If the password is required for a menu item, a "Password Entry" screen will be displayed. Just press "911" then **Ent** to access the menu item.

From the "Enter Password" menu item, press **Ent** to show the "Password Entry" screen.

Enter the password, "911", then press **Ent**.

A message will briefly be displayed indicating whether the password was correct or not.

The display will then move back to the Setup Menu.

If the password has been successfully entered, and it is desired to restore password protection, so that the password must be re-entered to gain access to the protected menu items, select the "Enter Password" menu item and enter an incorrect password. Password protection is also restored whenever the controller goes from the Run Mode to the Setup Mode.

The password can be entered by pressing the **7** key when the display is activated from the blank screen (after a power cycle), or when the "VA.CONTROLS" banner is displayed (after pressings **Esc** from the Run Mode menus). This allows the password to be entered without stopping the controller.

The password can be given to all authorized personnel, which is those who would need to change settings or features on the controller.

WARNING: It is recommended that the password NOT be written on the prints, or controller itself, as this would allow anyone to access settings and features that could cause damage to personnel or equipment.

WARNING: Use great care in changing settings and features, as this may cause unexpected operation. Make sure you understand the consequences of any changes before making them.

7.2.11 Test I/O Boards

This selection allows specific outputs to be turned on as desired, so that they can be tested for proper operation.

This selection is password protected. The password must be entered each time this menu item is selected, even if the password has been correctly entered before. The generic password "911" may be used. This prevents unauthorized personnel from activating this feature, and also prevents accidentally entering this feature.

After pressing **Ent** to select this item, enter the password "911" and then press **Ent**.

The LCD screen will display "'Ent' = START TEST, OTHER KEY = QUIT". Press the **Ent** key to start the test feature, or press any other key to return to the setup menu.

WARNING: When the test feature is activated, outputs may be turned on that may cause the car to move, the doors to operate and other signals to come on. It is the operator's responsibility to make sure an unsafe condition does not exist. Take any and all the necessary precautions to prevent a dangerous situation.

This could include:

- unplugging the terminal blocks on the output boards (this is strongly recommended),
- removing the fuses in the output circuits,
- opening the appropriate safety devices.

While the test feature is activated, each input that is on will turn on the corresponding output on the same board (Input Point 1 will turn on Output Point 1; Input Point 2 will turn on Output Point 2 etc.). This allows the inputs and outputs to be tested by jumping the desired input on, and verifying that the proper output comes on. Note: The outputs are updated once every tenth of a second, so there may be a slight delay in turning on the output after the input has been energized.

WARNING: Be very careful when jumping the inputs on. Make sure you do not jump to the common on the input terminal strips. This will blow a fuse, and could damage the input board components. The input commons are the first and sixth terminals from the left on the input terminal strip (see the schematic).

While the outputs are being tested, a meter can be used to verify that each output is actually coming on. The test will be stopped, and the outputs turned off, when any key is pressed.

8. Controller Nomenclature

The symbols listed below are typical symbols. Refer to the schematic for all relays and contactors actually used on a particular job. The function of the relay or contactor will be shown on the schematic by its coil.

<u>SYMBOL</u>	<u>DESCRIPTION</u>
AF, BF, CF, etc.	BINARY CODED FLOOR POSITION RELAYS
BK1, BK2	BRAKE CONTACTORS
C	DOOR CLOSE RELAY
D / D1-2, DX	DOWN RUN REVERSING CONTACTOR / RELAYS
DC	DOOR CLOSED RELAY
DL	DOWN LEVEL RELAY
DOLX	DOOR CHECK RELAY
DZ	DOOR ZONE RELAY
ES, EST	EMERGENCY STOP SWITCH RELAY
ESB	EMERGENCY STOP SWITCH BY-PASS RELAY
FL, FLR	FIELD LOSS RELAYS
FS, FSX	FAST SPEED RUN CONTACTOR OR RELAYS
IAS, IAX	INSPECTION ACCESS RELAY
INS	INSPECTION RELAY
LC	LEVELING CUTOFF RELAY
LV	LEVELING RELAY
MG, MG1-2	MOTOR GENERATOR CONTACTOR, RELAYS
N	DOOR CLOSE NUDGING RELAY
O	DOOR OPEN RELAY (IN MODSS ON TOP OF THE CAR, IF USED)
OSF	OVERSPEED FAULT RELAY
P, PP, PX	POTENTIAL CONTACTOR, RELAY
RDY	DRIVE READY TO RUN RELAY
RU	MOTOR RUN CONTACTOR (WYE-DELTA START)
RUX / RUXP	M.G. SET RUNNING CONTACTOR / TIMER
SAF1-2	SAFETY CIRCUIT RELAYS
STR	MOTOR START CONTACTOR (WYE-DELTA START)
SU	SUICIDE CONTACTOR
TRU	WYE-DELTA MOTOR RUN RELAY (WYE-DELTA START)
TRUP	WYE-DELTA MOTOR RUN TIMER (WYE-DELTA START)
U / U1-2, UX	UP RUN REVERSING CONTACTOR / RELAYS
UD	CAR RUNNING RELAY
UDT, UDTX	CAR RUNNING DELAY DROP OUT RELAYS
UL	UP LEVEL RELAY
VR	VOLTAGE RELAY (OPTIONAL)

9. Parts List

<u>ITEM</u>	<u>DESCRIPTION</u>	<u>MANUFACTURER</u>	<u>PART NO</u>
<u>RELAYS</u>			
A1	4PDT, 120VAC, PLUG-IN RELAY	Idec or equivalent	RU4S-A110
A2	4PDT, 110VDC, PLUG-IN RELAY	Idec or equivalent	RU4S-D110
A3	SURFACE MOUNT RELAY SOCKET	P&B	27E894
A4	TIMER, 0-102.3 SECONDS	AIRTRONICS	THCU102S3E
A5	3PDT, 120VAC, PLUG-IN RELAY	P&B or equivalent	KUP-14A35
<u>CONTACTORS, STARTERS, OVERLOAD</u>			
B1	Y-D REVERSING CONTACTOR (NEMA)	SQD	S_0_V02
B2	3 POLE THERMAL OVERLOAD (NEMA)	SQD	SE0___
B3	ACROSS-THE-LINE STARTER (NEMA)	SQD	S_0_V02
B4	HEATERS FOR 3 POLE OVERLOAD (NEMA)	SQD	(Types: B, CC, DD)
B5	Y-D REVERSING CONTACTOR (IEC)	SQD/Telemecanique	LC2-___G6
B6	ACROSS-THE-LINE STARTER (IEC)	SQD/Telemecanique	LC1-___G6
B7	3 POLE OVERLOAD (IEC)	SQD/Telemecanique	LR___
<u>TRANSFORMERS, FUSES, TERMINALS</u>			
C1	460-230-208/230-115, (600VA & 300VA)	SQD	9070K___D48
C2	250V INSTANTANEOUS FUSE	BUSSMAN	TYPE BAF
C3	250V FUSEHOLDER	CURTIS	PW1F
C4	TRACK FOR 250V FUSEHOLDERS	CURTIS	SW192
C5	3 POLE TERMINAL, 600V, 50AMP	CURTIS	3PSWT
C6	MOUNTING TRACK FOR TERMINALS	CURTIS	SW192
<u>MICRO-PROCESSOR</u>			
D1	MICROPROCESSOR CPU BOARD	V.C.	MH3000-CPU
D2	16-IN/16-OUTPUT MODULE	V.C.	MH3000-16IO
D3	KEYPAD	V.C.	MH3000-KEYPAD
D4	LCD SCREEN	V.C.	MH3000-LCD
D5	CPU BATTERY	PANASONIC	CR2032
<u>MISCELLANEOUS COMPONENTS & HARDWARE</u>			
E1	PRINTED CIRCUIT BOARD	V.C.	MH-4
E2	PHASE MONITOR (208V / 230V / 460V)	SSAC	TVM___A100.5S3S
E3	1"W X 2"H DUCT	TAYLOR	91020
E4	1"W X 3"H DUCT	TAYLOR	91030
E5	1"W DUCT COVER	TAYLOR	99010
E6	1"W DUCT MOUNTING CLIPS	TAYLOR	08010
E7	CONTROLLER ENCLOSURE	V.C.	(SIZE)
E8	STARTER ENCLOSURE	V.C.	(SIZE)

<u>RESISTORS - PART # IS RESISTANCE & WATTAGE - SEE THE SCHEMATIC</u>			
F1	POWER PANEL RESISTOR VALUES 375WATT= 4, 8, 10, 25 OHMS 200WATT= 50, 100, 250, 500, 1000, 1500, 2500 OHMS	RESISTORS, INC.	
F2	RELAY PANEL RESISTOR VALUES 25 WATT = 1.5K OHMS 10 WATT = 12K, 350 OHMS 2 WATT = 1.5K OHMS	RESISTORS, INC.	
F3	DYNAMIC BRAKING RESISTOR ASSEMBLY		SEE SCHEMATIC
<u>MISCELLANEOUS</u>			
G1	NEONS, ON RELAY PANEL	I.D.I.	1030
G2	VARISTORS (SEE SCHEMATIC)	G.E.	V150LA2
G3	PUSHBUTTON, ON RELAY PANEL	ARROW-HART	80511E
G4	TOGGLE SWITCH, ON RELAY PANEL	ARROW-HART	82601
G5	10 POSITION SELECTOR SWITCH	CENTRALAB	PA1001

All parts are commercially available from the manufacturer, or from Virginia Controls LLC (ask for the Parts Department or send an email to parts@vacontrols.com). Parts are subject to change without notice. Consult Virginia Controls, LLC, for current pricing information. Non-standard material is identified on the schematic.

10. Troubleshooting Suggestions

Troubleshooting is similar to any other controller, and has several features to speed up determining the cause of any problem. No special knowledge of the operation of the microprocessor is required to be able to troubleshoot it.

A safety relay interface is provided to prevent dangerous operation due to a failure of the microprocessor. It is possible that the microprocessor may turn on an output point, yet the field safety switches may prevent the associated device from energizing.

For example, if the up run output energizes, but the up normal switch is open, then the up run relays will not energize.

10.1 Locating Faults

Once the system has been installed, and is running properly, the most common problem will be the failure of an external device. The first step in locating the cause is to determine whether the fault is in the microprocessor or whether it is in the external wiring.

For example, if a position indicator light is not lit, check the output module for the appropriate output point to determine if the microprocessor is trying to turn the light on or not. If the output light is on, then confirm that there is voltage at the module terminal. If there is voltage at the module terminal, then the problem is external to the microprocessor. It could be in the wiring to the position indicator, or perhaps the position indicator light has burned out. Similarly with input points, check that the input module light is on, that there is power at the terminal, and if not then the problem is external.

If it is determined that the problem is with the microprocessor, then the next step is to determine if the problem is in the hardware or the software. Using the keypad, press **Nxt** to display the "Show I/O Status" menu item. Press **Ent**. The screen will show the address on the top line and the I/O status on the bottom line. Press **Nxt** or **Prv** to show the desired I/O address, and see if the CPU is responding by showing the correct status of the I/O points. If it is not, then the fault is probably with the I/O hardware; if it is on, then the fault is probably with the software.

If an input or output board fails, it may be possible to temporarily replace that defective board with another board that is used for non-essential functions (such as call register lights), thus providing elevator service while a replacement board is being obtained. See the section on I/O Board Replacement for further information.

If this does not correct the problem, the power supply or the CPU module could be faulty. If the CPU fails, it will probably stop flashing LED D5. The CPU and I/O modules can be affected by high transient surges in the power supply, such as the building being hit by lightning. This may damage the CPU, or alter the contents of the program. Proper grounding will protect the controller from most of these problems.

10.1.1 Resetting Faults

The means to reset faults depends on the code used for the controller. Refer to the listing of faults in the Fault Log section for comments on resetting specific faults.

With ANSI codes before 2010, cycling Inspection or cycling power will reset most faults.

NOTE: With 2010 ANSI code or later, shutdown faults are required to be reset manually. In this case, faults are reset by momentarily jumping the Fault Reset / Shutdown Defeat Input. If the Latched Fault output is on, then the fault must be reset manually as described above.

NOTE: A factory reset by means of the Setup Menu on the CPU will clear all faults, and clear the Fault Log. This should be viewed as a last resort.

10.1.2 Troubleshooting I/O Board Communication Problems

If the IOFAULT error message is shown on the Status Screen, there are several ways to determine which board is causing the fault.

The communication light on the I/O board will usually indicate the problem. The normal status is for that light to blink once. If it blinks 2 or more times then the board is detecting an error in the communication it is receiving, as described in the section on I/O Boards, Board Status LED.

Additionally the CPU can be monitored to check its communication with the I/O boards.

Address 0051 and 0052 should both be 00, but will show a code corresponding to the board that is not communicating with the CPU. Using the SHOW INT MEMORY screen, navigate to address 0050, then check the value in 0051 (refer to the example shown below with address 0051 in **bold**).

0050 04 **03** 03 04
0054 00 00 00 00

In the example shown here, a fault code “03” is seen in 0051. This indicates there is a communication problem with boards 1 and 2. Refer to the chart below for the codes for the board faults. The top section shows the boards for the right code number, and the bottom section shows the codes for the left code number.

Right Number	x0	x1	x2	x3	x4	x5	x6	x7	x8	x9	xA	xB	xC	xD	xE	xF
Board1	OK	Fault	OK	Fault	OK	Fault	OK	Fault	OK	Fault	OK	Fault	OK	Fault	OK	Fault
Board2	OK	OK	Fault	Fault	OK	OK	Fault	Fault	OK	OK	Fault	Fault	OK	OK	Fault	Fault
Board3	OK	OK	OK	OK	Fault	Fault	Fault	Fault	OK	OK	OK	OK	Fault	Fault	Fault	Fault
Board4	OK	OK	OK	OK	OK	OK	OK	OK	Fault	Fault	Fault	Fault	Fault	Fault	Fault	Fault
Left Number	0x	1x	2x	3x	4x	5x	6x	7x	8x	9x	Ax	Bx	Cx	Dx	Ex	Fx
Board5	OK	Fault	OK	Fault	OK	Fault	OK	Fault	OK	Fault	OK	Fault	OK	Fault	OK	Fault
Board6	OK	OK	Fault	Fault	OK	OK	Fault	Fault	OK	OK	Fault	Fault	OK	OK	Fault	Fault
Board7	OK	OK	OK	OK	Fault	Fault	Fault	Fault	OK	OK	OK	OK	Fault	Fault	Fault	Fault
Board8	OK	OK	OK	OK	OK	OK	OK	OK	Fault	Fault	Fault	Fault	Fault	Fault	Fault	Fault

Also addresses 0048 to 004F show the communication attempts to each of the boards. Refer to the sample shown below.

0048 F* F* 0* 00
004C 00 00 00 00

If a board is not communicating properly, the left number corresponding to the board will be “F” or “E”. The right number will change very quickly. If the board is communicating properly, the left number will be “0” or “1”, and the right number will be changing quickly. If the CPU is not attempting to communicate to a board, the value will stay at “00”. In the example above, the CPU is attempting to communicate with boards 1, 2, and 3. Board 3 is communicating properly, but boards 1 and 2 are not. The “*” in the example above indicate numbers that are changing quickly.

Address 051E counts the number of failed IO board communication attempts. This should be 0, as shown in the sample below.

051C 2E E0 00 00
0520 00 00 00 00

If there are intermittent problems, such as noise causing communication errors, then this value will gradually increase. Check the addressing of the boards, and that all cables are fitted properly. Also check the grounding of the controller. See the section Show Internal Memory for instructions on viewing internal memory addresses.

10.2 I/O Board Replacement

WARNING: When replacing a board, the Address Switch setting on the new board must be set to match the old board.

To replace an I/O board, TURN THE POWER OFF. Unplug all the terminal blocks at the top and bottom of the board. Unplug the Power Connector and the I/O Bus Connectors. Remove the screws holding the board in place. Install the new module by reversing the above steps.

10.3 Factory Assistance

IMPORTANT: IF TROUBLESHOOTING ASSISTANCE IS REQUIRED FROM VIRGINIA CONTROLS, GET THE FOLLOWING INFORMATION BEFORE CALLING (ADDITIONAL TROUBLESHOOTING INSTRUCTIONS MAY BE GIVEN, DEPENDING ON THE NATURE OF THE PROBLEM):

- **THE VIRGINIA CONTROLS DRAWING NUMBER** (located at the bottom right of the schematic).
- **AN EXACT DESCRIPTION OF THE PROBLEM.**
- **THE STATUS OF ALL THE INPUT AND OUTPUT POINTS.**
- **THE STATUS OF THE LIGHTS ON THE CPU.**

10.4 Changes for Program Revisions

The following section lists the changes that are included in program revision.

10.4.1 Program Revision 3B

Approximate Date of implementation – 05/1/2005

The following changes were incorporated:

- Redundancy Faults were given specific Fault Codes and Status Screen Messages.
- The Fault Status Codes in the Fault Log were customized for Redundancy Faults.
- The Rollover Fault code was modified so that consecutive Rollovers would be combined into one fault, with the number of fault free days shown on the lower right.

10.4.2 Program Revision 3C

Approximate Date of implementation – 05/1/2008

The following changes were incorporated:

- Redundancy Fault Codes were added for latest Redundancy Faults, as used on Program Versions VA3C and VS3C. Additional tables were added for these new Fault Codes

11. Controller Maintenance

WARNING: MAKE SURE THE POWER IS OFF BEFORE CONNECTING OR DISCONNECTING ANY CONNECTORS, ADDRESS JUMPERS OR CABLES ON THE CPU OR I/O BOARDS.

11.1 Periodic Maintenance

WARNING: Turn off the power before touching the terminals or wiring.

Check that all wires are tight, and properly located in the terminals. Make sure no stray strands of wire are sticking out of the terminal strips.

Check the Motor Starter contacts and Door Operator contacts (if provided) for wear.

Make sure all relays are fully seated in their sockets.

If any varistors are provided in parallel with inductive loads (such as the Valve Solenoids or Motor Starter) check that they are physically sound. Look for signs of burn marks. Replace it if it looks damaged.

Check the CPU battery. This can be done by cycling the power, then checking to make sure the onboard clock is still correct. To check the time, press **Nxt** until the display shows "Press ENTER to SHOW FAULT LOG". Then press **Ent**, then press **.** to show the current time. If the date had been set, and it now shows the date as 01/01/00 then the battery is dead. Change the battery and set the time.

Keep the controller clean and dry. Power supplies and processor chips in particular should be kept clean of dust and other debris. Keeping the machine room itself clean will help keep the controller clean.

11.2 Parts Replacement

11.2.1 CPU Exchange

To swap out the CPU board:

1. Turn off the power to the controller.
2. Note the location of all cables and wires. It is recommended that all cables and wires be marked so that they can be returned to the correct terminal or connector, and be oriented properly.
3. Unplug the incoming power wiring connector from the bottom left terminal block.
4. Unplug the duplex communication connector from the duplex connector (if used).
5. Unplug the I/O Bus Connector.
6. Remove the four screws holding the CPU board in place.
7. Remove the CPU board.
8. Install the new CPU board in the reverse order.

11.2.2 EPROM Memory Chip Exchange

WARNING: IF YOU NEED TO CHANGE THE EPROM PROGRAM CHIP ON THE CPU BOARD, MAKE SURE YOU READ THE INSTRUCTIONS AND KNOW EXACTLY HOW TO INSTALL THE NEW CHIP. PLUGGING THE EPROM IN UPSIDE-DOWN MAY DAMAGE YOUR CHIP. STATIC ELECTRICITY CAN DAMAGE THE EPROM, SO AVOID TOUCHING THE PINS ON THE CHIP, AND GROUND YOURSELF (BY TOUCHING THE CONTROLLER CABINET) BEFORE TOUCHING THE CHIP OR THE CONTROLLER. DO NOT EXPOSE THE EPROM PROGRAM CHIP TO BRIGHT LIGHT, AND DO NOT REMOVE THE LABEL OVER THE EPROM PROGRAM CHIP WINDOW.

To exchange the EPROM memory chip on the CPU board:

1. Turn off power to the controller.
2. Using a small screwdriver, or other appropriate tool, pry out the old EPROM chip by inserting the screwdriver between the chip and its socket from the right side. Gradually work the chip out, trying to avoid swinging it out, which would bend the pins at one end, but rather prying it straight out by working the screwdriver under the chip.
3. Insert the new EPROM chip by orienting it properly, so that the notch is at the left, to match the socket, and all the pins line up with the socket. LEAVE TWO EMPTY HOLES AT THE LEFT END OF THE CHIP (the end next to the notch). It should not be necessary to use force to insert the EPROM chip, but apply slight sideways pressure to line up the rows of pins with the holes in the socket, if

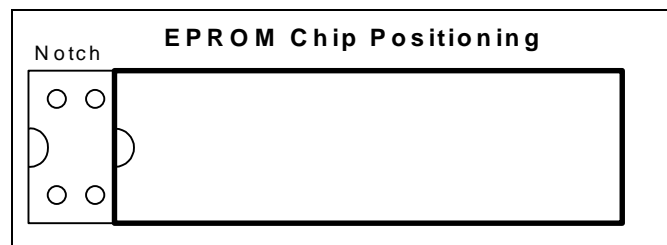

necessary, then evenly press the EPROM chip into place.

4. Do not apply power until the orientation of the chip has been checked. Also verify that ALL pins are properly in the socket, and that none of them have been bent out of place.

11.2.3 Input/Output Board Exchange

To exchange on I/O board:

1. Change the Address Switches on the new I/O board to match the board it will replace.
2. Turn off the power to the controller.
3. Unplug all the removable I/O terminal strips from the top and bottom of the I/O board. It is not usually necessary to mark the terminal blocks, since the wiring will normally hold them in the proper place so that it is obvious which block goes where. If there is any doubt about their location, then mark the terminal blocks to show where they should be re-installed.
4. Unplug the I/O Bus Connectors and power connector.
5. Remove the screws holding the I/O board in place.
6. Install the new I/O board by reversing the previous steps.

12. Frequently Asked Questions

Suggestions for other Frequently Asked Questions are welcomed. Please submit them via email to eng@vacontrols.com.

12.1 Questions on Field Devices

12.2 Questions on Field Devices

Q. Are the Reset Targets necessary when using a pulsing selector?

Yes.

The reset targets are required at the terminal landings, as shown on the car top selector installation sheet, to establish or reset the floor position at the terminal landings.

Q. Why are Two Position Indicators energized at the same time?

With Floor Switches, if there is an overlap of the slowdown targets, or a Floor Switch sticks on, then when the car hits a new Floor Switch, all floors that have a Floor Switch input energized will be turned on.

If the problem happens intermittently, it is probably caused by a sticking Floor Switch. If it happens regularly at a particular floor, there is probably an overlap between Floor Switches. In this case, either separate the Floor Switches (or targets) so there is no overlap, or turn on the "Short Floor" feature, described above in the features section.

Q. The doors do not operate properly on Fire Service

Check the Door Open and Door Close Limit Switches for proper operation. Most problems with Fire Service are a result of one or both of these switches not operating properly. Also check to make sure the correct Fire Code has been selected in the Adjustable Settings and Features. Refer to the schematic adjustment sheet.

12.3 Questions on the Controller

Q. How Do I Reset All Settings and Features Back to the Original Values?

1. With the controller running normally, press **Nxt** repeatedly until the menu item shows "GO TO SETUP MENU".
2. Press **Ent**. The display will show a warning message. Make sure the car is stopped before continuing.
3. Press **Ent**. The display will show you have entered the Setup Mode, then display the "RESET SETTINGS" menu item.
4. Press **Ent** to reset all settings to the factory defaults.
5. Press **Esc** to return the controller to normal operation.

NOTE: If the program is a standard program, then the settings for the specific job must be re-entered.

Q. How do I determine if I have a standard program?

1. Go to the Banner screen, by pressing **Esc** until the top line of the display shows "VA.CONTROLS" at the left.
2. If the text on the lower left is the job number, then the program is NOT standard. It has been set up for the particular job.
3. If the text on the lower left starts with letters (such as "E" or "Q") then the program is standard. If a factory reset is performed, the standard default values will be loaded. Check the schematic for the particular values for your installation, and change the values as required.

Q. How do I check the current values of the settings and features?

4. Go to the Setup Menu.
5. Select the menu item "Change Settings", and press **Ent**, then enter the password, "911".
6. Scroll through the settings by pressing **Nxt**. The settings will not be changed unless a new value is entered and then **Ent** is pressed.
7. Press **Esc** then **Nxt** to go to the "Change Features" menu item.
8. Press **Ent**, then enter the password, and press **Ent**.
9. Press **Nxt** to scroll through the features. The features will not be changed unless you press **Aux** then **Ent**.
10. Press **Esc** twice to return to normal operation (Run Mode).

Q. Why is the LCD Display blank?

The LCD Display goes blank after the CPU resets if S2 switch 1 is in the OFF position. This will happen when the power to the CPU is cycled, or when the Reset Button on the CPU board is pressed.

Press any key to activate the screen.

If the screen does not activate, the problem could be with the Keypad (momentarily touch pins 1 and 8 on the keypad connector to simulate pushing a key) or the CPU (check that LED D5 is flashing), or the LCD Display.

Q. Why is the Fire Audible Visible output On but the car is not on Fire Service?

Switch 3 on the CPU Slide Switch S2 is in the ON position.

This switch defeats the Redundancy Faults. This may be useful during initial installation, and the Fire Audible Visible is turned on to remind you to turn off this defeat after installation. Slide the switch down to turn it off.

13. Drive Special Instructions

Refer to the job schematic for connection information.

The drive has been set up and tested, so only minor adjustments should be necessary.

If the motor data is different from that supplied to Virginia Controls (motor horsepower, currents, voltages, etc.) then consult with Virginia Controls before powering up the system.

Refer to the Parameter sheet in the schematic for the actual settings for each particular job.

For additional explanations of drive parameters, see the Magnetek Technical Manual.

Customer should record any parameter changes and keep this information in a safe place for future reference.

13.1 Over Speed Test

It is recommended that the over speed test be done with the car on "Inspection". This allows complete control of the car at all times. When the test is complete, restore all parameters back to their original values.

Refer to the Parameter sheet in the schematic for additional details.

14. ETSD Monitoring System Testing

NOTE: When performing these tests, especially while the elevator is on Normal operation, first verify that the car is empty and that Hall Calls are cut out.

14.1 UCM System Testing

14.1.1 Equipped for Rope Brake Operation (Static Test)

1. Run the elevator on Automatic to top landing, or to the bottom if basement traction.

NOTE: Be sure to take the necessary steps to prevent anyone from boarding the elevator during the test.

2. Power down the system with doors closed.
3. Remove the controller wire at Input DZ, "Door Zone", on the ETSD Board. Clip this controller wire to a short wire temporarily installed in its place.
4. Power up the system, then use the Door Open Push Button in the controller to open car doors.
5. As the elevator opens its doors, remove the controller wire clipped to the temporary wire at Input DZ on the ETSD Board.
6. The UCM System will cause the Rope Brake to set, and the "UCM TRIP" LED to light.
7. Power down the system.
8. Restore the controller wiring at Input DZ.
9. Power up the system, and briefly touch a wire from controller TB-1 (120VAC) to ETSD Input SHTDFT to reset the UCM System.
10. The controller processor may need to be reset as well, in much the same way, before the Rope Brake will reset and lift. Jump 1-RST, or toggle the pre-installed reset keyswitch in the machine room controller.

14.1.2 Equipped for Em. Brake Operation (Dynamic Test)

1. Run the elevator on Automatic to top landing, or to the bottom if basement traction.

NOTE: Be sure to take the necessary steps to prevent anyone from boarding the elevator during the test.

2. Enable the "UCM TEST" parameter in the Settings Menu and select a test direction that levels the car away from the Normal Terminal Limit, whether the elevator is parked at top or bottom landing.
3. Use the Door Open Button in the controller to open car doors.
4. Initiate the software UCM Test once the doors have opened, and observe the elevator run at leveling speed in the selected direction.
5. Once the elevator has leveled beyond the Door Zone boundary, the UCM System will cause the Emergency Brake to set, and the "UCM TRIP" LED to light.

6. Briefly touch a wire from controller TB-1 (120VAC) to ETSD Input SHTDFT to reset the UCM System.
7. The controller processor may need to be reset as well, in much the same way, before the Emergency Brake will reset, allowing the elevator to close its doors and relevel. Jump 1-RST, or toggle the pre-installed reset keyswitch in the machine room controller.

14.2 O-S System Testing

1. With elevator at mid-hatch (approx.), place on Inspection from controller.
2. Power down the system.
3. Install a jumper from controller TB-1 to controller processor Input or TB: "SHTDFT". See the controller drawings for the location of this input or controller terminal.
4. Power up the system.
5. Set the drive for an Inspection Speed of 175FPM and run car in either direction.
6. The O-S System will fault, causing an elevator brake stop and the "O-S TRIP" LED to light.
7. Power down the system.
8. Remove the jumper from controller TB-1 to Input or TB: "SHTDFT".
9. Power up the system.
10. Restore the drive to its original Inspection Speed.
11. Use the "O-S RESET" Push Button on the ETSD Board to reset the O-S System.
12. Test for desired Inspection speed, then return elevator to Normal Operation.

14.3 ETSD System Testing

1. With elevator at mid-hatch, on Normal Operation and at floor level, power down the system.
2. Install a jumper from controller TB-1 to controller processor Input or TB: "SHTDFT". See the controller drawings for the location of this input or controller terminal.
3. Remove the field wire from controller TB-31X, Up ETS Switch, and clip this field wire to a short piece of wire temporarily installed in its place.
4. Power up the system.
5. Set a Car Call in the Up direction that causes the car to run multiple floors at contract speed.
6. Monitor car speed by observing ETSD Board Relay Output LED's: "EX1 & EX2".
7. When these Relay Output LED's go out, remove the field wire clipped to TB-31X.
8. The ETSD System will fault, causing an elevator brake stop and the "ETSD TRIP" LED to light.
9. Power down the system.
10. Remove the jumper from controller TB-1 to controller processor Input or TB: "SHTDFT".

11. Restore the field wire at controller TB-31X, Up ETS Switch.
12. Power up the system.
13. Use the “ETS RESET” Push Button on the ETSD Board to reset ETSD System.
14. The elevator will level to a landing on Normal Operation.
15. If desired, repeat steps in Down Direction using TB-32X, the Down ETS Switch.

INDEX

A

Access · 13
Addressing · 57
Adjustable Features · 23

B

Banner Screen · 80
Battery · 49, 131
Bit Features · 82, 83, 108, 111

C

Calls · 19, 23, 24, 50, 101
Car Start · 24
 · 8, 107
Code · 83, 107, 108, 110, 121, 134
Communication · 25, 52, 59, 85, 128
CPU · 11, 14, 18, 25, 44, 48, 49, 50, 51, 52, 59,
 88, 103, 125, 127, 129, 131, 136

D

Diagnostic · 103
Display · 52, 55, 107, 108, 109, 119, 120, 136
Door Operation · 19
Drive · 14, 16, 20, 87, 100
Duplex · 23, 25, 51, 52, 85, 120

E

Emergency Terminal Stopping Device · 37, 62,
 69
EPROM · 8, 18, 44, 50, 105, 132
ETSD · 26, 27, 29, 30, 31, 33, 34, 36, 37, 38, 62,
 65, 66, 67, 68, 69, 70, 71, 72, 74, 76, 78, 138,
 139
ETSD Monitoring System · 26, 62

F

Factory Reset · 17

Failure Timers · 20
Fault Code · 83
Fault Log · 81, 82, 83, 89, 94, 104, 120
Fault Reset · 83
Features · 17, 23, 104, 108, 110, 118, 119, 134,
 135
Fire Service · 13, 16, 20, 23, 24, 50, 85, 86, 101,
 110, 113, 119, 121, 134
Flood · 114

G

Grounding · 9, 11, 14, 15

H

Hexadecimal Conversion Table · 97
Historical Log · 94
Homing · 24, 110, 120
Humidity · 10

I

I/O Status · 81
Independent · 18, 24, 50, 85, 100, 101, 110
Inspection · 16, 17, 20, 24, 50, 85, 100, 101, 106,
 109, 110, 119, 137
Internal Memory · 51, 94, 97, 98, 99, 103, 104,
 120
IO Fault · 102, 128

J

Jumper · 61

K

Keypad · 44, 53, 136

L

LED · 19, 20, 25, 50, 51, 52, 57, 58, 59, 94, 98,
 103, 104, 127, 128, 136

M

Maintenance · 131

N

Next Car · 23

Noise · 129

NOTE · 8, 11, 13, 15, 18, 19, 20, 45, 51, 52, 82, 84, 90, 98, 104, 106, 107, 109, 118, 135

O

O-S · 27, 29, 30, 35, 36, 38, 62, 67, 76

Over Speed · 30, 66

Over-Speed · 62, 66

P

Parts List · 125

Parts Replacement · 131

Password · 104, 106, 118, 120, 121, 122

Position Indicators · 18

R

Redundancy · 90, 100, 101, 112, 130

Reset Button · 51, 52, 79, 136

Revision · 130

Run Mode · 79, 80, 81, 94, 103, 104, 105, 107, 120, 122, 135

Running Timers · 20, 21

S

S2 · 136

S2 Slide Sw · 53, 54, 79

Selector · 12, 120

Settings · 17, 23, 104, 105, 106, 107, 108, 111, 119, 134, 135

Set-Up Mode · 103, 104

Start-Up · 15

Status · 51, 55, 59, 79, 80, 81, 89, 99, 100, 103, 104, 127, 128

Stuck Button · 20

Switches · 12, 13, 59, 81, 86, 88, 101, 133, 134

Leveling · 12, 13, 21, 86, 88, 101, 109, 133

Limit · 12, 13, 18, 22, 84, 88, 90, 101, 102, 133, 134

Slowdown · 12, 13, 18, 88, 101, 133

Zone · 12, 13, 21, 22, 86, 88, 90, 101, 102, 107, 133

T

Temperature · 10

Temporary · 16

Terminal Wiring · 58

Test · 122

Time · 49, 82, 84, 104, 121

Troubleshooting · 127, 128

U

UCM · 27, 36, 38, 62, 63, 64, 65, 66, 67, 76

Unintended Car Movement · 27, 62, 63

W

WARNING · 8, 14, 15, 16, 23, 49, 50, 52, 58, 61, 99, 104, 106, 122, 123, 131, 132

Watchdog · 51