

## TAKE A RIDE. BE AMAZED.

You can read through sea trial reports and watch footage of the Seakeeper in action, but the only way to truly understand how this revolutionary technology will transform your operation is to experience it for yourself.

Visit [www.seakeeper.com/takearide](http://www.seakeeper.com/takearide) to schedule your demo today!



### SEAKEEPER INC.

+1-410-326-1590 Corporate Headquarters

+1-240-718-6440 24/7 Technical Support Hotline

[seakeeper.com](http://seakeeper.com)

©2019 Seakeeper Inc.  
HD Brochure - 90527

# ELIMINATE BOAT ROLL.





**PROCEED WITH  
CONFIDENCE**

**SEAKEEPER HD**

**WHEN OTHERS STAY IN, YOU GO OUT.**

Designed to handle the extreme conditions faced in extended offshore operations of more than 1,000 hours per year, the Seakeeper HD line provides added safety to crews and extends the amount of time you can be out on the water.



## REDUCE RISK. KEEP THEM SAFE.

Boat roll jeopardizes the safety of everyone on board, whether by way of insecure footing, early fatigue, or moving loose equipment. With the push of a button, you can give your crew a land-like experience, greatly reducing the possibility of injury from slips and falling gear.

## SPEED & EFFICIENCY

Furthermore, Seakeeper offers increased safety for your vessel. The completely internal system means there is no added drag or increased risk of snags.



## ELIMINATE BOAT ROLL. YOUR CREW DESERVES IT.

BOAT ROLL

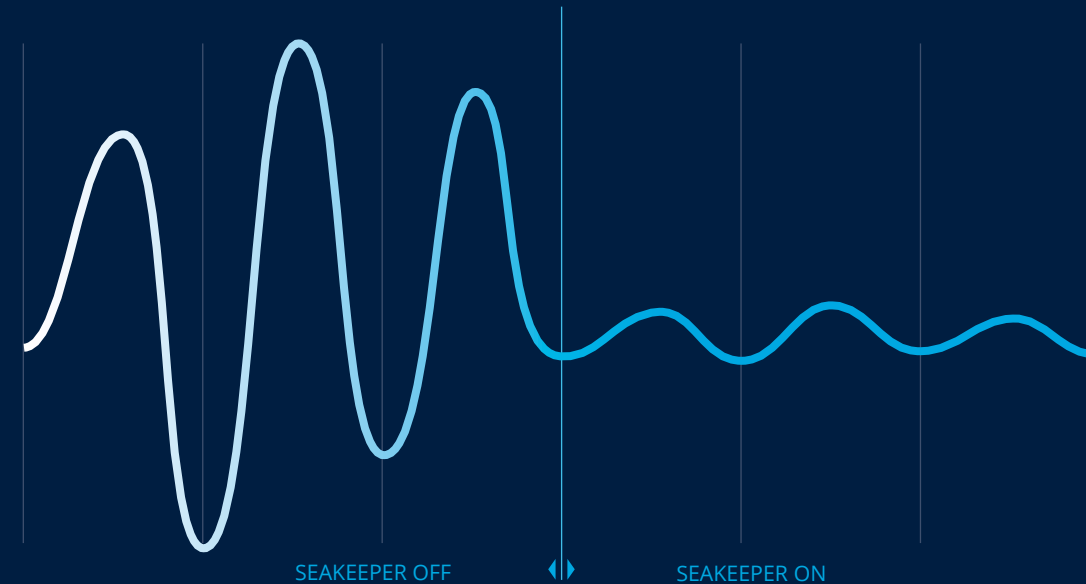

## STABILIZATION FOR ALL APPLICATIONS

One product, so many possibilities! Whether you're a patrol or crew transfer ship, a survey or research vessel, Seakeeper can smooth the seas and stabilize your platform. Whatever size your vessel may be, we've got a model that will do the trick without added drag.



Visit [Seakeeper.com](http://Seakeeper.com) for installation photos and sea trial results on the wide range of Seakeeper stabilized boats.



## WE AIM TO ELIMINATE UP TO 95% OF BOAT ROLL ON EVERY INSTALLATION

Making sure you have the highest level of stabilization while out on the water is important to us. That's why we look at every Seakeeper installation individually. We customize our product recommendation based on the parameters and use of your specific boat. To ensure our high standards have been met, we developed the Seakeeper Mobile App to record sea trials on our installations which has allowed us to create a database displaying the real-life results of hundreds of installations. View all of our sea trials at [seakeeper.com](http://seakeeper.com).



## AND JUST IN CASE YOU'RE WONDERING...



### LIGHTWEIGHT

Seakeeper weighs a small fraction of the vessel displacement.



### LOW POWER CONSUMPTION

Due to its vacuum encapsulation, Seakeeper requires minimal power. Select Seakeeper models even run off 12V DC power.



### SIMPLE INSTALLATION

Completely internal, no external appendages.



### FLEXIBLE

It can be installed virtually anywhere on the boat and any combination of units can be used to reach targeted performance.

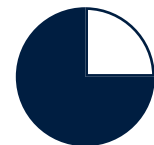

### 25% OF SALES ARE REFITS

Easily refit our existing vessel with a Seakeeper unit.



### OPTIMIZED

Seakeeper reviews every unique installation in-depth to ensure you receive the full Seakeeper experience. Seakeeper doesn't aim to simply reduce roll, we aim to eliminate it!

# BUILT TO PERFORM

The Seakeeper is designed to virtually eliminate boat roll on vessels 27' and up. It requires modest electrical power, has no outside appendages, and can be installed off centerline, if necessary. Its computerized control and vacuum technology make it the first truly practical, and only modern, anti-roll gyro.

## HOW IT WORKS

Inside a vacuum encapsulation, a flywheel spins at speeds of up to 9,700 rpm. When the boat rolls, the sphere tilts fore and aft (precesses), producing a powerful gyroscopic torque to port and starboard that counteracts the boat roll.

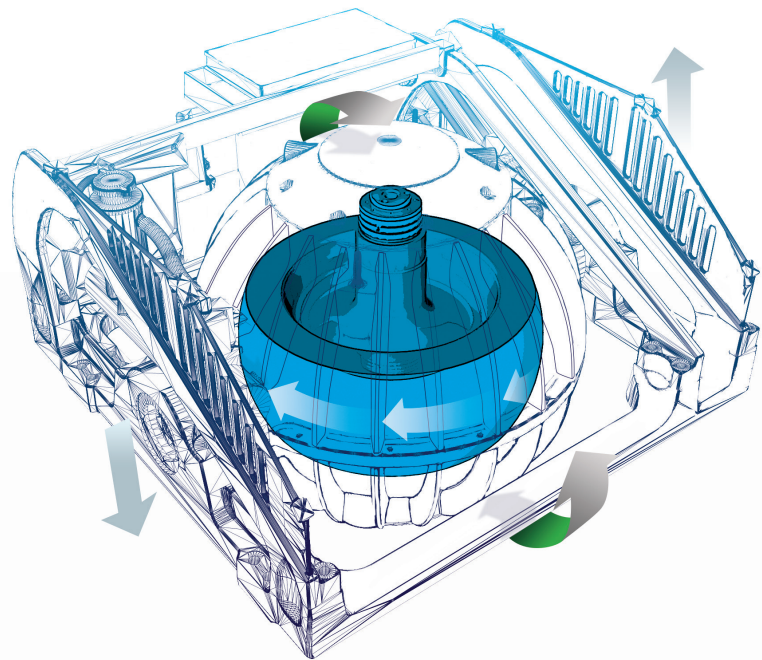

## INNOVATIVE COOLING SYSTEM

Patented cooling system enables the flywheel to spin at high speeds inside of the vacuum containment.

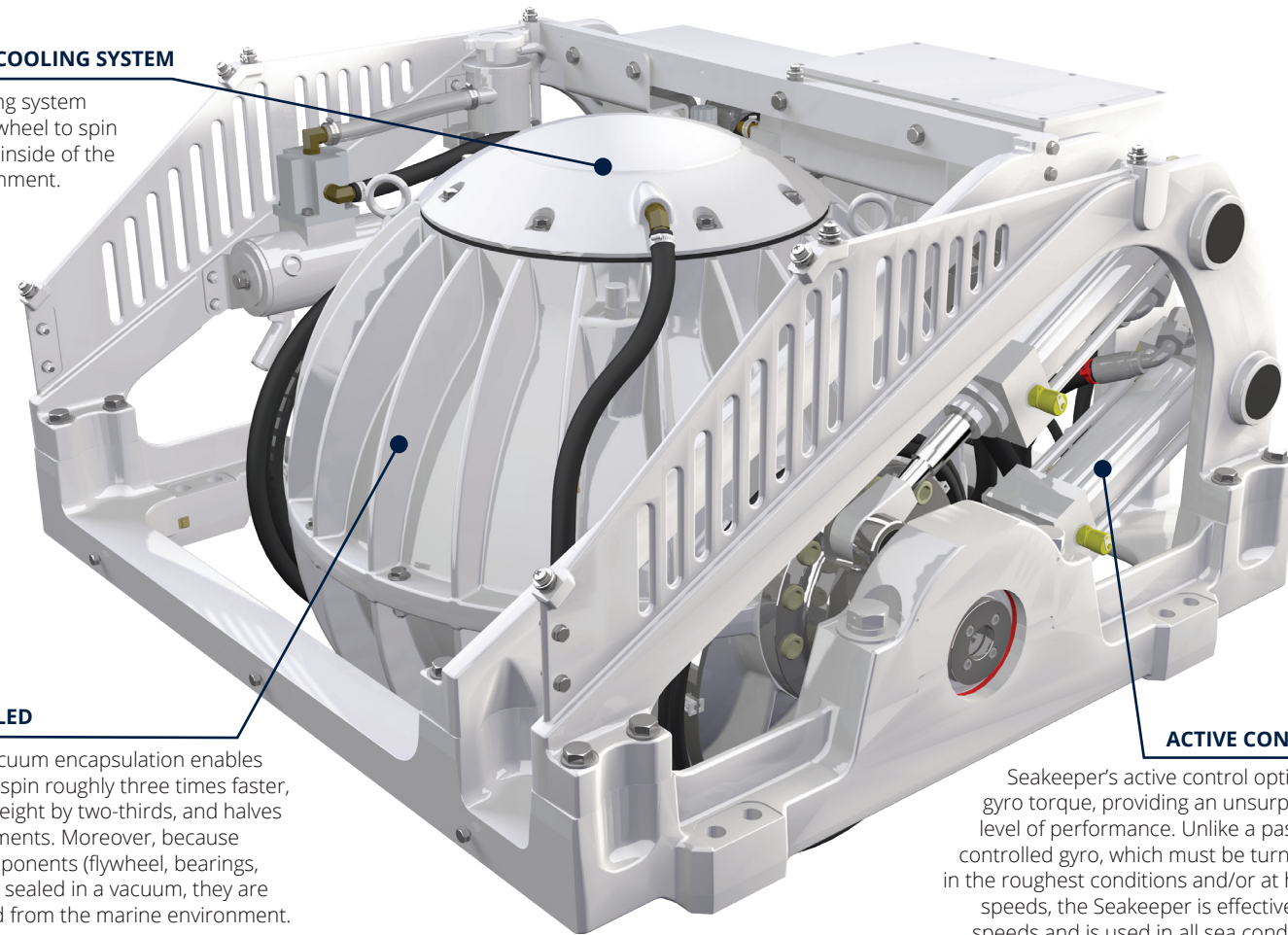

## VACUUM SEALED

Seakeeper's vacuum encapsulation enables the flywheel to spin roughly three times faster, cuts flywheel weight by two-thirds, and halves power requirements. Moreover, because the critical components (flywheel, bearings, and motor) are sealed in a vacuum, they are forever isolated from the marine environment.

## ACTIVE CONTROL

Seakeeper's active control optimizes gyro torque, providing an unsurpassed level of performance. Unlike a passively controlled gyro, which must be turned off in the roughest conditions and/or at higher speeds, the Seakeeper is effective at all speeds and is used in all sea conditions.



## DASHBOARD DISPLAY

Intuitive operator interface allows you to simply turn it on and forget about it. No complex settings or adjustments for the operator, Seakeeper does all of this automatically, you simply enjoy.

# THE HD LINE

Heavy Duty. Engineered for extended use in harsh conditions. Recommended for vessels with more than 1,000 sea hours per year and backed by a 4 year major component warranty.

## DC POWERED UNITS

See our Recreational Line for battery-powered Seakeeper models ideal for boats approximately 27-39' long.

### 5 HD



**FOR BOATS** ~35-44' (up to ~15 tons)

**WEIGHT** 870 lbs (395 kg)

**DIMENSIONS** 29.77 L x 29.71 W x 24.65 H (inches)  
0.756 L x 0.755 W x 0.626 H (meters)

### 7 HD



**FOR BOATS** ~45-54' (up to ~25 tons)

**WEIGHT** 1,210 lbs (550 kg)

**DIMENSIONS** 33.5 L x 35.6 W x 28.3 H (inches)  
0.852 L x 0.903 W x 0.720 H (meters)

### 12 HD



**FOR BOATS** ~55-64' (up to ~35 tons)

**WEIGHT** 2,195 lbs (996 kg)

**DIMENSIONS** 42.6 L x 43.2 W x 32.8 H (inches)  
1.08 L x 1.1 W x 0.83 H (meters)

### 20 HD



**FOR BOATS** ~65-74' (up to ~60 tons)

**WEIGHT** 3,010 lbs (1365 kg)

**DIMENSIONS** 52.7 L x 55.9 W x 40.4 H (inches)  
1.34 L x 1.42 W x 1.03 H (meters)

### 30 HD



**FOR BOATS** >75' (up to ~85 tons)

**WEIGHT** 3,920 lbs (1,778 kg)

**DIMENSIONS** 54.3 L x 55.9 W x 43.5 H (inches)  
1.38 L x 1.42 W x 1.11 H (meters)

# THE STATS

SEAKEEPER **5 HD**

SEAKEEPER **7 HD**

SEAKEEPER **12 HD**

SEAKEEPER **20 HD**

SEAKEEPER **30 HD**

	SEAKEEPER <b>5 HD</b>	SEAKEEPER <b>7 HD</b>	SEAKEEPER <b>12 HD</b>	SEAKEEPER <b>20 HD</b>	SEAKEEPER <b>30 HD</b>
<b>Rated Speed</b>	8,100 RPM	7,000 RPM	4,600 RPM	3,850 RPM	4,400 RPM
<b>Angular Momentum at Rated RPM</b>	5,000 N-M-S	7,000 N-M-S	12,000 N-M-S	20,000 N-M-S	30,000 N-M-S
<b>Anti-Rolling Torque at Rated RPM</b>	13,075 N-M	14,630 N-M	23,040 N-M	43,076 N-M	62,571 N-M
<b>Spool-up Time to Rated RPM</b>	35 minutes (8,100 RPM)	35 minutes (7,000 RPM)	45 minutes (4,600 RPM)	70 minutes (3,850 RPM)	75 minutes (4,400 RPM)
<b>Spool-up Time to Stabilization</b>	22 minutes (6,885 RPM)	25 minutes (5,600 RPM)	35 minutes (3,680 RPM)	50 minutes (3,100 RPM)	50 minutes (3,500 RPM)
<b>Spool-up Power</b>					
AC Motor	2300 Watts Max	3000 Watts Max	3000 Watts Max	3000 Watts Max	3000 Watts Max
DC Control	125 Watts	240 Watts	240 Watts	240 Watts	240 Watts
<b>Operating Power</b>					
AC Motor (sea state dependent):	1050 - 2300 Watts	1000 - 2000 Watts	1000 - 3000 Watts	1000 - 3000 Watts	2000 - 3000 Watts
DC Control:	125 Watts	240 Watts	240 Watts	240 Watts	240 Watts
AC Input Voltage:	110 - 230 VAC (+/- 10%), 50/60 Hz Single Phase	208 - 230 VAC (+/- 10%), 50/60 Hz, Single Phase	208 - 230 VAC (+/- 10%), 50/60 Hz, Single Phase	208 - 230 VAC (+/- 10%), 50/60 Hz, Single Phase	208 - 230 VAC (+/- 10%), 50/60 Hz, Single Phase
DC Input Voltage:	12 VDC @ 15 Amps	24 VDC @ 10 Amps	24 VDC @ 10 Amps	24 VDC @ 10 Amps	24 VDC @ 10 Amps
<b>Weight</b>	870 lbs (395 kg)	1,210 lbs (550 kg)	2,195 lbs (996 kg)	3,010 lbs (1,365 kg)	3,920 lbs (1,778 kg)
<b>Envelope Dimensions</b>	29.77 L x 29.71 W x 24.65 H (inches) 0.756 L x 0.755 W x 0.626 H (meters)	33.5 L x 35.6 W x 28.3 H (inches) 0.852 L x 0.903 W x 0.720 H (meters)	42.6 L x 43.2 W x 32.8 H (inches) 1.08 L x 1.10 W x 0.83 H (meters)	52.7 L x 55.9 W x 40.4 H (inches) 1.34 L x 1.42 W x 1.03 H (meters)	54.3 L x 55.9 W x 43.5 H (inches) 1.38 L x 1.42 W x 1.11 H (meters)
<b>Noise Output</b>	70-72 dBC at 1 meter	68-70 dBC at 1 meter	68-73 dBC at 1 meter	72-74 dBC at 1 meter	72-74 dBC at 1 meter

## SEAKEEPER HD EXTENDED WARRANTY

Our extended warranty program provides you with an added peace of mind and reliable service beyond the duration of your standard factory warranty.

Extended warranty coverage is available for customers currently within their factory warranty period.

HD

5 Years or 6,000 Hours  
Complete Coverage

Extra harsh conditions require extra strong protection. Our HD extended warranty protects your crew and lets you get the job done without worry.

from  
**\$6,330** Price shown is for the Seakeeper 5HD

[View all HD pricing and full policy at seakeeper.com/extended-warranty](https://seakeeper.com/extended-warranty)





# THE RECREATIONAL LINE

Designed for optimal performance in recreational applications.



**FOR BOATS** ~27-32' (up to ~7 tons)  
**WEIGHT** 414 lbs (188 kg)  
**DIMENSIONS** 24.8 L x 25.5 W x 20.0 H (inches)  
0.630 L x 0.648 W x 0.508 H (meters)

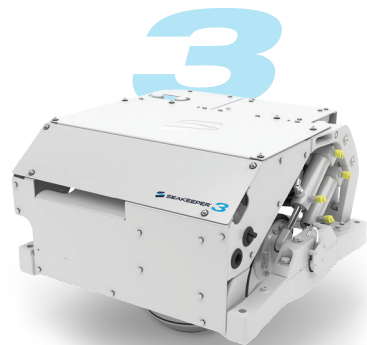

**FOR BOATS** ~33-39' (up to ~10 tons)  
**WEIGHT** 550 lbs (249 kg)  
**DIMENSIONS** 26.8 L x 27.0 W x 22.5 H (inches)  
0.681 L x 0.686 W x 0.572 H (meters)



**FOR BOATS** ~40-49' (up to ~20 tons)  
**WEIGHT** 870 lbs (395 kg)  
**DIMENSIONS** 29.8 L x 29.7 W x 24.7 H (inches)  
0.756 L x 0.755 W x 0.626 H (meters)



**FOR BOATS** ~50-59' (up to ~30 tons)  
**WEIGHT** 1,210 lbs (550 kg)  
**DIMENSIONS** 33.5 L x 35.6 W x 28.3 H (inches)  
0.852 L x 0.903 W x 0.720 H (meters)

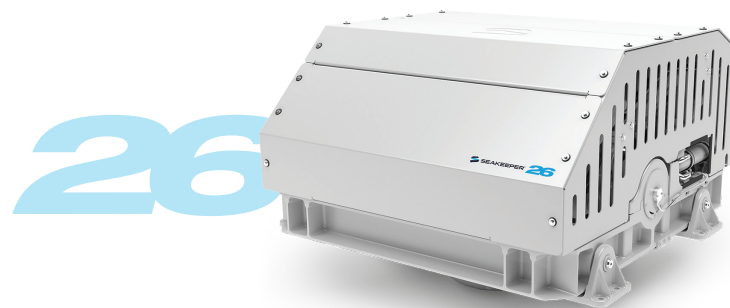

**FOR BOATS** ~70-84' (up to ~75 tons)  
**WEIGHT** 3,010 lbs (1365 kg)  
**DIMENSIONS** 52.7 L x 55.9 W x 40.4 H (inches)  
1.34 L x 1.42 W x 1.03 H (meters)



**FOR BOATS** ~60-69' (up to ~50 tons)  
**WEIGHT** 2,195 lbs (996 kg)  
**DIMENSIONS** 42.6 L x 43.2 W x 32.8 H (inches)  
1.08 L x 1.1 W x 0.83 H (meters)

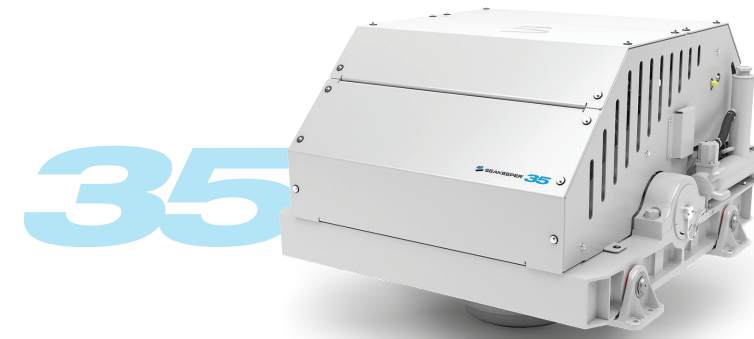

**FOR BOATS** >85' (up to ~100 tons)  
**WEIGHT** 3,920 lbs (1,778 kg)  
**DIMENSIONS** 54.3 L x 55.9 W x 43.5 H (inches)  
1.38 L x 1.42 W x 1.11 H (meters)



## UNRIVALED SUPPORT

Seakeeper sales, service, and retrofit centers around the world.

-  Seakeeper Office Locations
-  Exclusive Distributors
-  Dealers



**4 YEAR MAJOR COMPONENT WARRANTY**  
2 year all-inclusive warranty



**RELIABLE**  
Simple maintenance



**+1-240-718-6440**  
We stand behind our product with a global support network and a 24/7 technical support hotline.



**TRUSTED**  
The world's top boating brands choose Seakeeper with over 8,000 units in operation globally