

015BR

LOCKING COLLAR

Parts Number : 015BR

Manufacture 1 : NACHI

Manufacturer Number 1 : O15B-R

Manufacture 2 :

Manufacture Number 2 :

M.S.R.P 04/2010 :

Description: LOCKING COLLAR
MADE IN BRAZIL

Application 1 :

Application 2 :

Application 3 :

Application 4 :

Application 5 :

Application 6 :

Application 7 :

Application 8 :

Application 9 :

Application 10 :

Application 11 :

Application 12 :

ZOOM+

ZOOM-



PARTS IMAGE

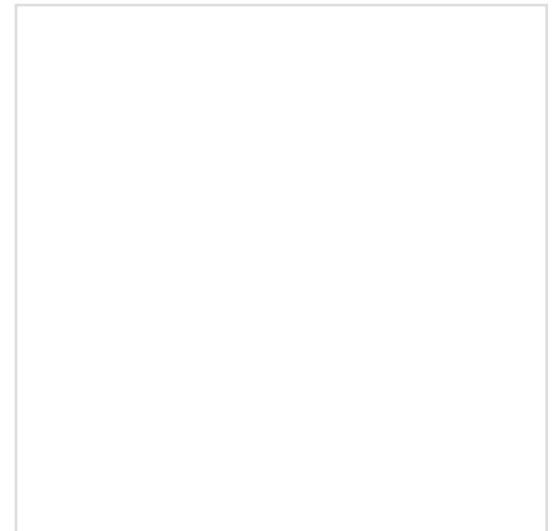

BOX IMAGE

015BR

LOCKING COLLAR

Parts Number : 015BR

Manufacture 1 : FBJ

Manufacturer Number 1 : 015B-R

Manufacture 2 : AUB

Manufacture Number 2 : 015B-R

M.S.R.P 04/2010 :

Description: LOCKING COLLAR

Application 1 :

Application 2 :

Application 3 :

Application 4 :

Application 5 :

Application 6 :

Application 7 :

Application 8 :

Application 9 :

Application 10 :

Application 11 :

Application 12 :

ZOOM+ ZOOM-



PARTS IMAGE



BOX IMAGE

08-R1

WHEEL BEARING

Parts Number : 08-R1

Manufacture 1 : NACHI

Manufacturer Number 1 : 08-R1

Manufacture 2 :

Manufacture Number 2 :

M.S.R.P 04/2010 :

Description: WHEEL BEARING

Application 1 :

Application 2 :

Application 3 :

Application 4 :

Application 5 :

Application 6 :

Application 7 :

Application 8 :

Application 9 :

Application 10 :

Application 11 :

Application 12 :

ZOOM+

ZOOM-



PARTS IMAGE

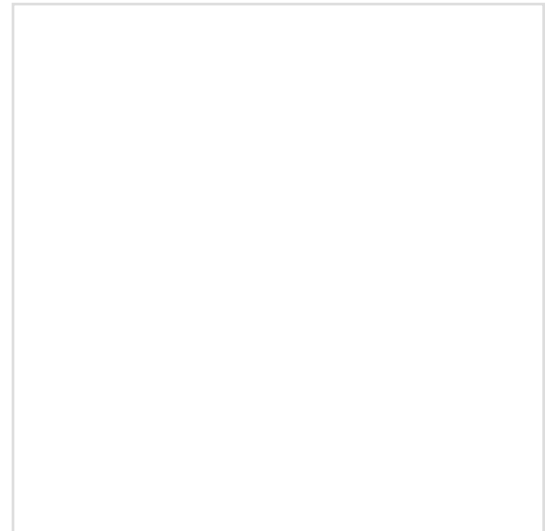

BOX IMAGE

12810-53B01

BELT TENSIONER

Parts Number : 12810-53B01

Manufacture 1 : NTN

Manufacturer Number 1 : JPU42-39

Manufacture 2 :

Manufacturer Number 2 :

M.S.R.P 04/2010 :

Description: BELT TENSIONER

Application 1 :

Application 2 :

Application 3 :

Application 4 :

Application 5 :

Application 6 :

Application 7 :

Application 8 :

Application 9 :

Application 10 :

Application 11 :

Application 12 :

ZOOM+

ZOOM-



PARTS IMAGE

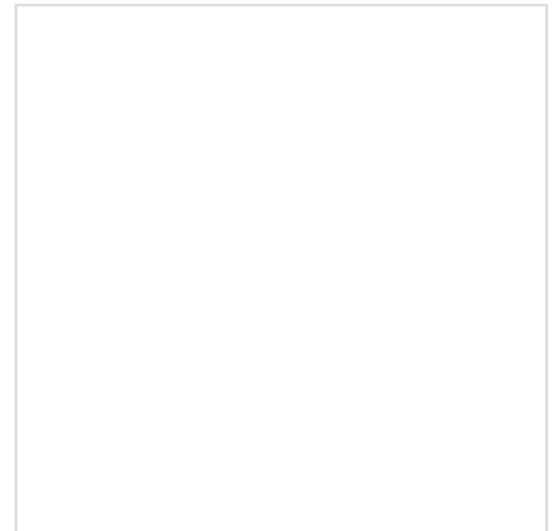

BOX IMAGE

12810-71C02

BELT TENSIONER

Parts Number : 12810-71C02

Manufacture 1 : NTN

Manufacturer Number 1 : JPU51-3/NEP51-002B-6

Manufacture 2 :

Manufacturer Number 2 :

M.S.R.P 04/2010 :

Description: BELT TENSIONER

Application 1 :

Application 2 :

Application 3 :

Application 4 :

Application 5 :

Application 6 :

Application 7 :

Application 8 :

Application 9 :

Application 10 :

Application 11 :

Application 12 :

ZOOM+

ZOOM-

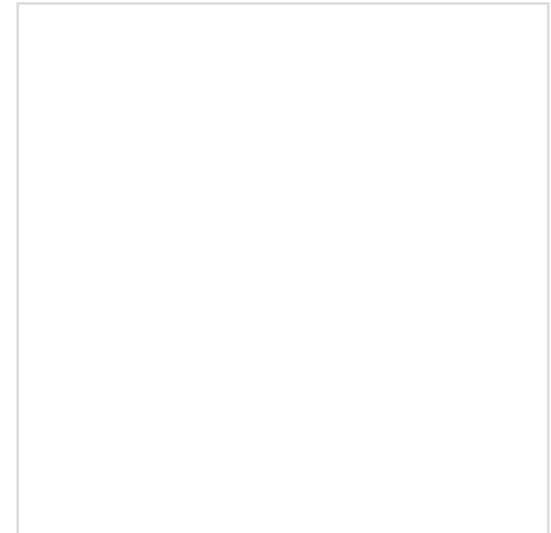

PARTS IMAGE

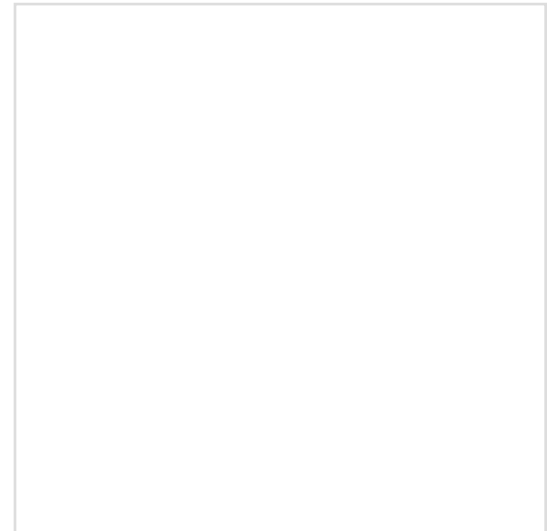

BOX IMAGE

12810-82003

BELT TENSIONER MADE IN

Parts Number : 12810-82003

Manufacture 1 : NTN

Manufacturer Number 1 : JPU58-55 / JPU58-003B-3

Manufacture 2 :

Manufacture Number 2 :

M.S.R.P 04/2010 :

Description: BELT TENSIONER MADE IN JAPAN

Application 1 :

Application 2 :

Application 3 :

Application 4 :

Application 5 :

Application 6 :

Application 7 :

Application 8 :

Application 9 :

Application 10 :

Application 11 :

Application 12 :

ZOOM+ ZOOM-



PARTS IMAGE



BOX IMAGE

12810-86501

BELT TENSIONER MADE IN

Parts Number : 12810-86501

Manufacture 1 : NTN

Manufacturer Number 1 : JPU42-003B-3

Manufacture 2 :

Manufacturer Number 2 :

M.S.R.P 04/2010 :

Description: BELT TENSIONER MADE IN JAPAN

Application 1 :

Application 2 :

Application 3 :

Application 4 :

Application 5 :

Application 6 :

Application 7 :

Application 8 :

Application 9 :

Application 10 :

Application 11 :

Application 12 :

ZOOM+ ZOOM-



PARTS IMAGE



BOX IMAGE

13033-AA040

Parts Number : 13033-AA040

Manufacture 1 : NTN

Manufacturer Number 1 : ATU006J-45

Manufacture 2 :

Manufacture Number 2 :

M.S.R.P 04/2010 :

Description: BELT TENSIONER MADE IN JAPAN

Application 1 :

Application 2 :

Application 3 :

Application 4 :

Application 5 :

Application 6 :

Application 7 :

Application 8 :

Application 9 :

Application 10 :

Application 11 :

Application 12 :

BELT TENSIONER MADE IN

ZOOM+

ZOOM-



PARTS IMAGE



BOX IMAGE

13069-AA034

BELT TENSIONER MADE IN

Parts Number : 13069-AA034

Manufacture 1 : NSK

Manufacturer Number 1 : 70TB0912W-1

Manufacture 2 :

Manufacture Number 2 :

M.S.R.P 04/2010 :

Description: BELT TENSIONER MADE IN JAPAN

Application 1 :

Application 2 :

Application 3 :

Application 4 :

Application 5 :

Application 6 :

Application 7 :

Application 8 :

Application 9 :

Application 10 :

Application 11 :

Application 12 :

ZOOM+ ZOOM-



PARTS IMAGE



BOX IMAGE

13069-AA063

BELT TENSIONER MADE IN

Parts Number :	13069-AA063
Manufacture 1 :	NSK <input type="button" value="v"/>
Manufacturer Number 1 :	70TB0912X-1
Manufacture 2 :	<input type="button" value="v"/>
Manufacturer Number 2 :	
M.S.R.P 04/2010 :	
Description:	BELT TENSIONER MADE IN JAPAN

- Application 1 :
- Application 2 :
- Application 3 :
- Application 4 :
- Application 5 :
- Application 6 :
- Application 7 :
- Application 8 :
- Application 9 :
- Application 10 :
- Application 11 :
- Application 12 :

ZOOM+ ZOOM-



PARTS IMAGE



BOX IMAGE

13069-AA070

BELT TENSIONER

Parts Number : 13069-AA070

Manufacture 1 : NSK

Manufacturer Number 1 : 70TB0924

Manufacture 2 :

Manufacturer Number 2 :

M.S.R.P 04/2010 :

Description: BELT TENSIONER

Application 1 :

Application 2 :

Application 3 :

Application 4 :

Application 5 :

Application 6 :

Application 7 :

Application 8 :

Application 9 :

Application 10 :

Application 11 :

Application 12 :

ZOOM+

ZOOM-

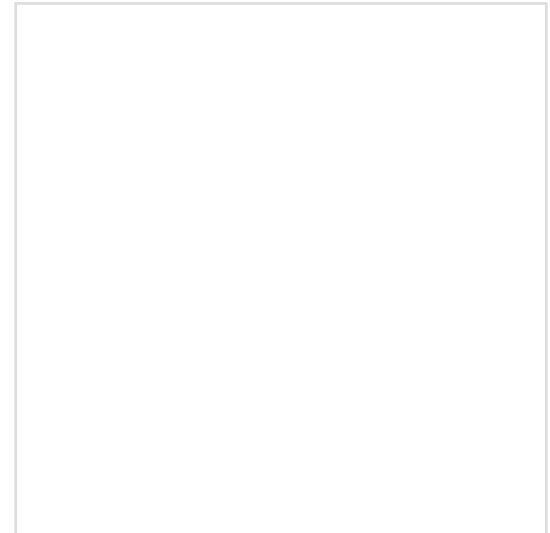

PARTS IMAGE

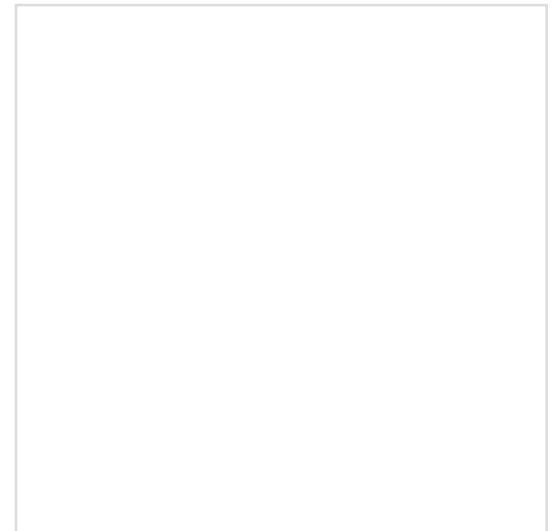

BOX IMAGE

13070-01M00

BELT TENSIONER MADE IN

Parts Number :	13070-01M00
Manufacture 1 :	NSK <input type="button" value="v"/>
Manufacturer Number 1 :	60TB041B02
Manufacture 2 :	<input type="button" value="v"/>
Manufacturer Number 2 :	
M.S.R.P 04/2010 :	
Description:	BELT TENSIONER MADE IN JAPAN

- Application 1 :
- Application 2 :
- Application 3 :
- Application 4 :
- Application 5 :
- Application 6 :
- Application 7 :
- Application 8 :
- Application 9 :
- Application 10 :
- Application 11 :
- Application 12 :

ZOOM+ ZOOM-



PARTS IMAGE



BOX IMAGE

13070-16A03

BELT TENSIONER MADE IN

Parts Number : 13070-16A03

Manufacture 1 : NSK

Manufacturer Number 1 : 65TB081B01

Manufacture 2 :

Manufacturer Number 2 :

M.S.R.P 04/2010 :

Description: BELT TENSIONER MADE IN JAPAN

Application 1 :

Application 2 :

Application 3 :

Application 4 :

Application 5 :

Application 6 :

Application 7 :

Application 8 :

Application 9 :

Application 10 :

Application 11 :

Application 12 :

ZOOM+

ZOOM-

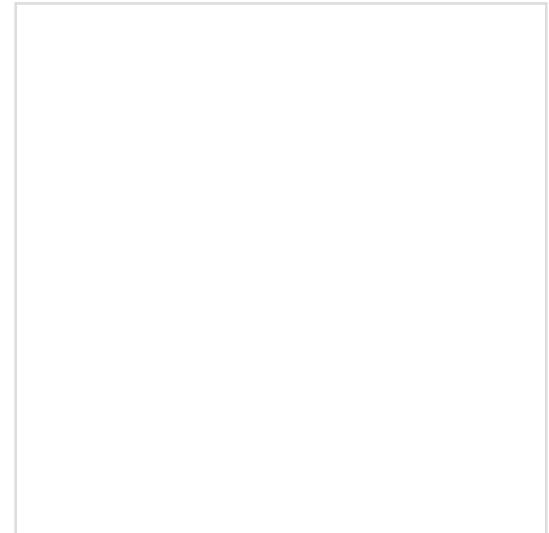

PARTS IMAGE

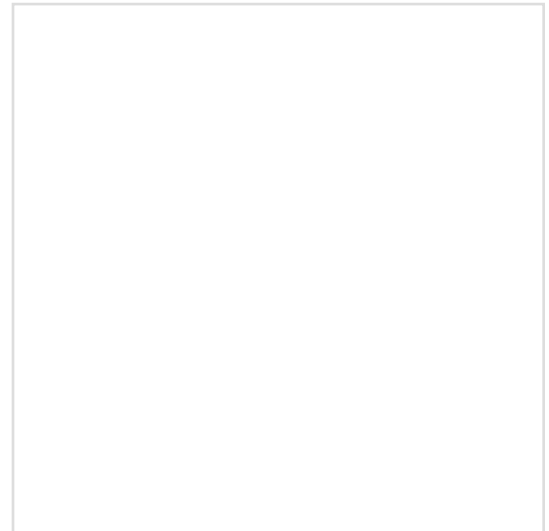

BOX IMAGE

13070-2J200

BELT TENSIONER

Parts Number : 13070-2J200

Manufacture 1 :

Manufacturer Number 1 :

Manufacture 2 :

Manufacturer Number 2 :

M.S.R.P 04/2010 :

Description: BELT TENSIONER

Application 1 :

Application 2 :

Application 3 :

Application 4 :

Application 5 :

Application 6 :

Application 7 :

Application 8 :

Application 9 :

Application 10 :

Application 11 :

Application 12 :

ZOOM+

ZOOM-



PARTS IMAGE

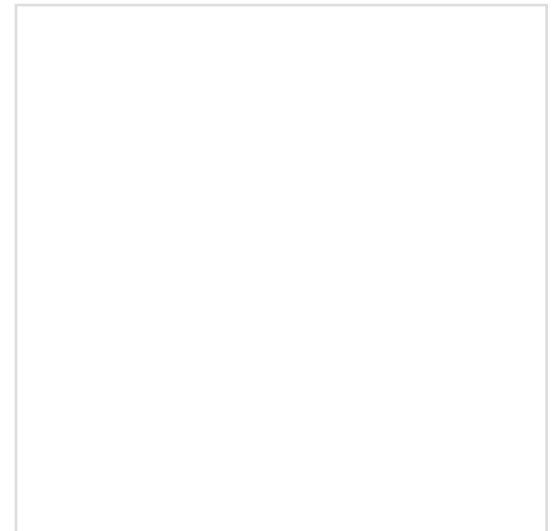

BOX IMAGE

13070-31U02

BELT TENSIONER

Parts Number : 13070-31U02

Manufacture 1 :

Manufacturer Number 1 :

Manufacture 2 :

Manufacturer Number 2 :

M.S.R.P 04/2010 :

Description: BELT TENSIONER

Application 1 :

Application 2 :

Application 3 :

Application 4 :

Application 5 :

Application 6 :

Application 7 :

Application 8 :

Application 9 :

Application 10 :

Application 11 :

Application 12 :

ZOOM+

ZOOM-

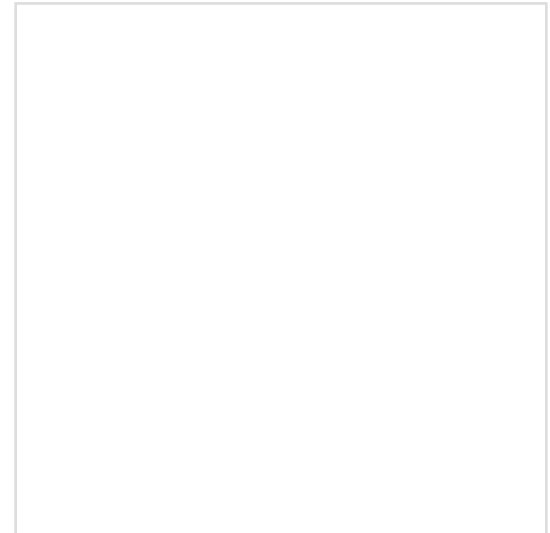

PARTS IMAGE

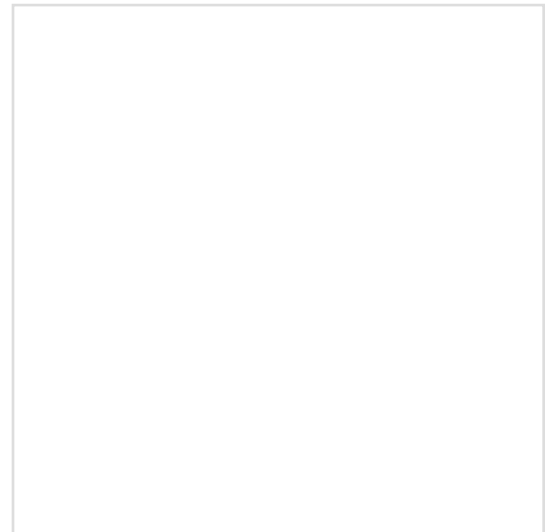

BOX IMAGE

13070-31U10

BELT TENSIONER

Parts Number : 13070-31U10

Manufacture 1 :

Manufacturer Number 1 :

Manufacture 2 :

Manufacturer Number 2 :

M.S.R.P 04/2010 :

Description: BELT TENSIONER

Application 1 :

Application 2 :

Application 3 :

Application 4 :

Application 5 :

Application 6 :

Application 7 :

Application 8 :

Application 9 :

Application 10 :

Application 11 :

Application 12 :

ZOOM+

ZOOM-

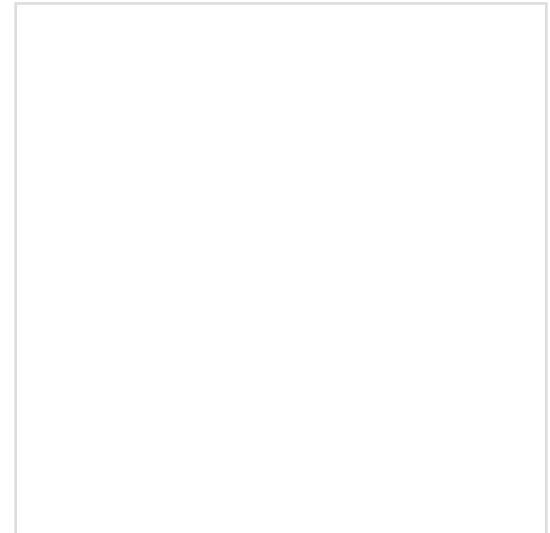

PARTS IMAGE

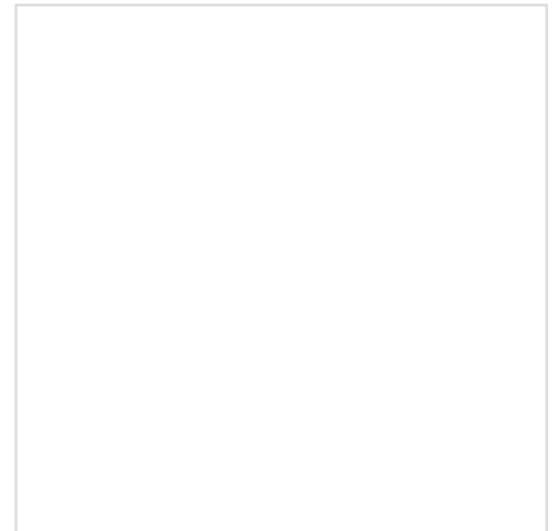

BOX IMAGE

13070-31U15

BELT TENSIONER

Parts Number : 13070-31U15

Manufacture 1 :

Manufacturer Number 1 :

Manufacture 2 :

Manufacturer Number 2 :

M.S.R.P 04/2010 :

Description: BELT TENSIONER

Application 1 :

Application 2 :

Application 3 :

Application 4 :

Application 5 :

Application 6 :

Application 7 :

Application 8 :

Application 9 :

Application 10 :

Application 11 :

Application 12 :

ZOOM+

ZOOM-

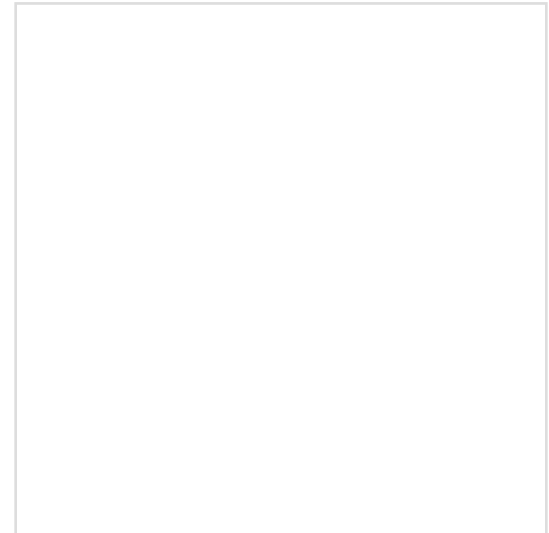

PARTS IMAGE

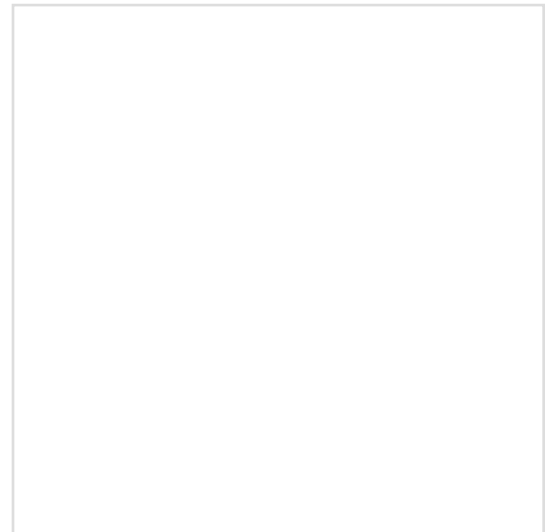

BOX IMAGE

13070-40F06

BELT TENSIONER

Parts Number : 13070-40F06

Manufacture 1 :

Manufacturer Number 1 :

Manufacture 2 :

Manufacturer Number 2 :

M.S.R.P 04/2010 :

Description: BELT TENSIONER

Application 1 :

Application 2 :

Application 3 :

Application 4 :

Application 5 :

Application 6 :

Application 7 :

Application 8 :

Application 9 :

Application 10 :

Application 11 :

Application 12 :

ZOOM+

ZOOM-



PARTS IMAGE

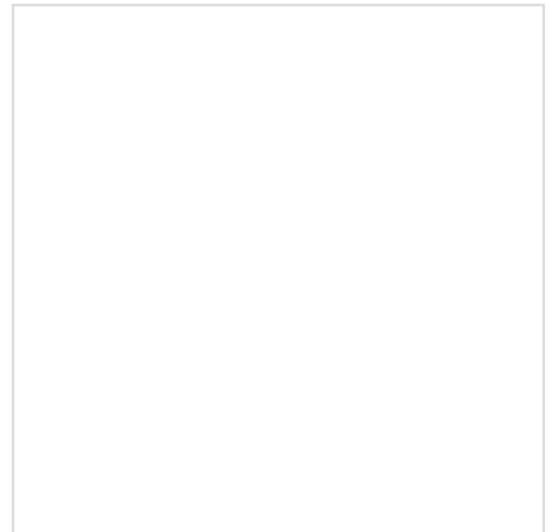

BOX IMAGE

13070-42L00

BELT TENSIONER MADE IN

Parts Number : 13070-42L00

Manufacture 1 : NSK

Manufacturer Number 1 : 60TB0732A

Manufacture 2 :

Manufacturer Number 2 :

M.S.R.P 04/2010 :

Description: BELT TENSIONER MADE IN JAPAN

Application 1 :

Application 2 :

Application 3 :

Application 4 :

Application 5 :

Application 6 :

Application 7 :

Application 8 :

Application 9 :

Application 10 :

Application 11 :

Application 12 :

ZOOM+ ZOOM-



PARTS IMAGE



BOX IMAGE

13070-45V04

BELT TENSIONER MADE IN

Parts Number : 13070-45V04

Manufacture 1 :

Manufacturer Number 1 :

Manufacture 2 :

Manufacturer Number 2 :

M.S.R.P 04/2010 :

Description:

13070-45V04

BELT TENSIONER MADE IN JAPAN

Application 1 :

Application 2 :

Application 3 :

Application 4 :

Application 5 :

Application 6 :

Application 7 :

Application 8 :

Application 9 :

Application 10 :

Application 11 :

Application 12 :

ZOOM+

ZOOM-



PARTS IMAGE



BOX IMAGE

13070-4E101

BELT TENSIONER

Parts Number : 13070-4E101

Manufacture 1 :

Manufacturer Number 1 :

Manufacture 2 :

Manufacturer Number 2 :

M.S.R.P 04/2010 :

Description: BELT TENSIONER

Application 1 :

Application 2 :

Application 3 :

Application 4 :

Application 5 :

Application 6 :

Application 7 :

Application 8 :

Application 9 :

Application 10 :

Application 11 :

Application 12 :

ZOOM+

ZOOM-

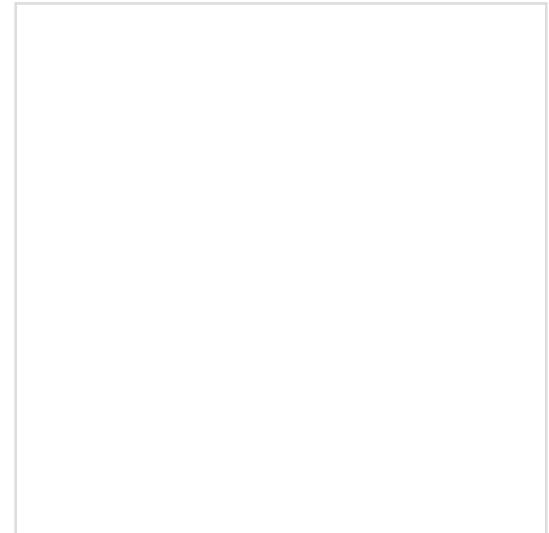

PARTS IMAGE

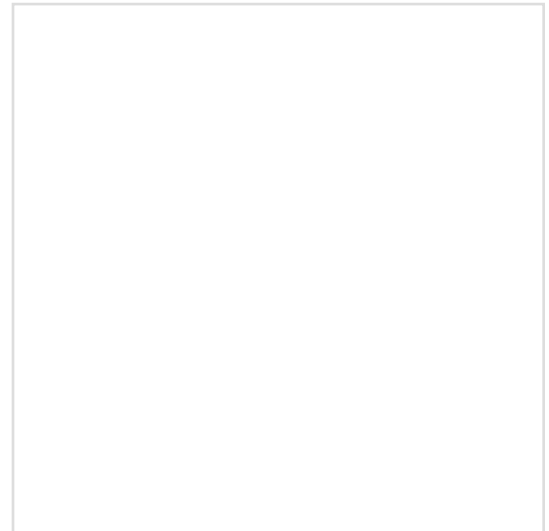

BOX IMAGE

13070-53F00

BELT TENSIONER MADE IN

Parts Number : 13070-53F00

Manufacture 1 :

Manufacturer Number 1 :

Manufacture 2 :

Manufacturer Number 2 :

M.S.R.P 04/2010 :

Description: BELT TENSIONER MADE IN JAPAN

Application 1 :

Application 2 :

Application 3 :

Application 4 :

Application 5 :

Application 6 :

Application 7 :

Application 8 :

Application 9 :

Application 10 :

Application 11 :

Application 12 :

ZOOM+ ZOOM-



PARTS IMAGE



BOX IMAGE

13070-53F12

BELT TENSIONER MADE IN

Parts Number : 13070-53F12

Manufacture 1 :

Manufacturer Number 1 :

Manufacture 2 :

Manufacturer Number 2 :

M.S.R.P 04/2010 :

Description:

13070-53F12

BELT TENSIONER MADE IN JAPAN

Application 1 :

Application 2 :

Application 3 :

Application 4 :

Application 5 :

Application 6 :

Application 7 :

Application 8 :

Application 9 :

Application 10 :

Application 11 :

Application 12 :

ZOOM+

ZOOM-



PARTS IMAGE



BOX IMAGE

13070-53F13

BELT TENSIONER

Parts Number : 13070-53F13

Manufacture 1 :

Manufacturer Number 1 :

Manufacture 2 :

Manufacturer Number 2 :

M.S.R.P 04/2010 :

Description: BELT TENSIONER

Application 1 :

Application 2 :

Application 3 :

Application 4 :

Application 5 :

Application 6 :

Application 7 :

Application 8 :

Application 9 :

Application 10 :

Application 11 :

Application 12 :

ZOOM+

ZOOM-

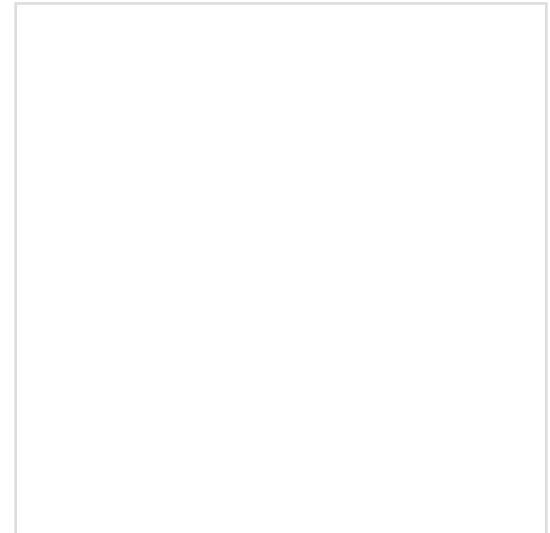

PARTS IMAGE

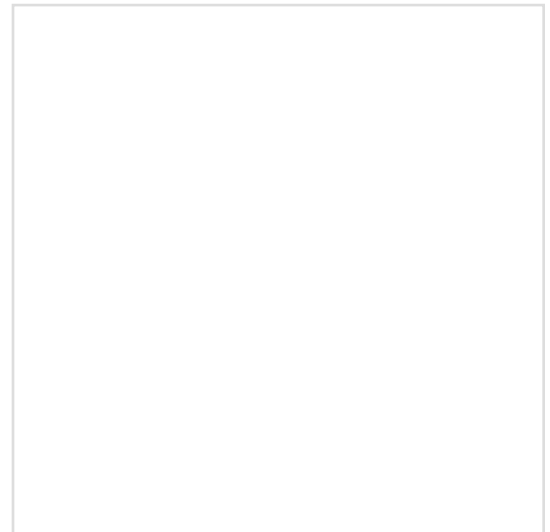

BOX IMAGE

13070-53F14

BELT TENSIONER

Parts Number : 13070-53F14

Manufacture 1 :

Manufacturer Number 1 :

Manufacture 2 :

Manufacturer Number 2 :

M.S.R.P 04/2010 :

Description: BELT TENSIONER

Application 1 :

Application 2 :

Application 3 :

Application 4 :

Application 5 :

Application 6 :

Application 7 :

Application 8 :

Application 9 :

Application 10 :

Application 11 :

Application 12 :

ZOOM+

ZOOM-

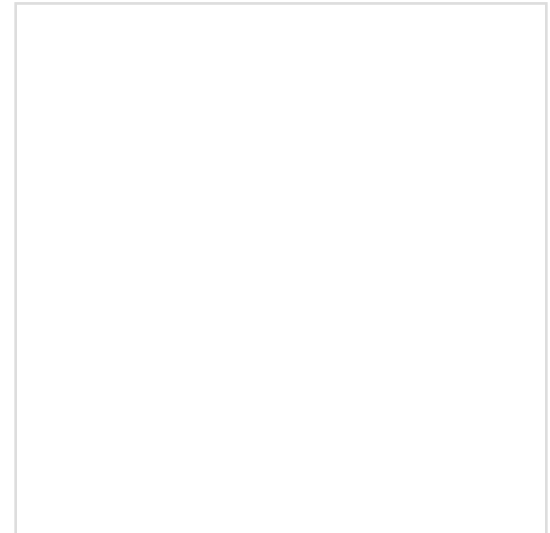

PARTS IMAGE

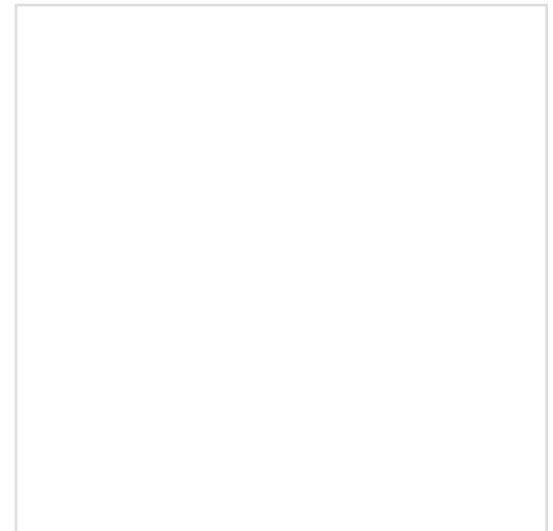

BOX IMAGE

13070-53J03

BELT TENSIONER

Parts Number : 13070-53J03

Manufacture 1 : NSK

Manufacturer Number 1 : 70TB0801A

Manufacture 2 :

Manufacturer Number 2 :

M.S.R.P 04/2010 :

Description: BELT TENSIONER

Application 1 :

Application 2 :

Application 3 :

Application 4 :

Application 5 :

Application 6 :

Application 7 :

Application 8 :

Application 9 :

Application 10 :

Application 11 :

Application 12 :

ZOOM+

ZOOM-

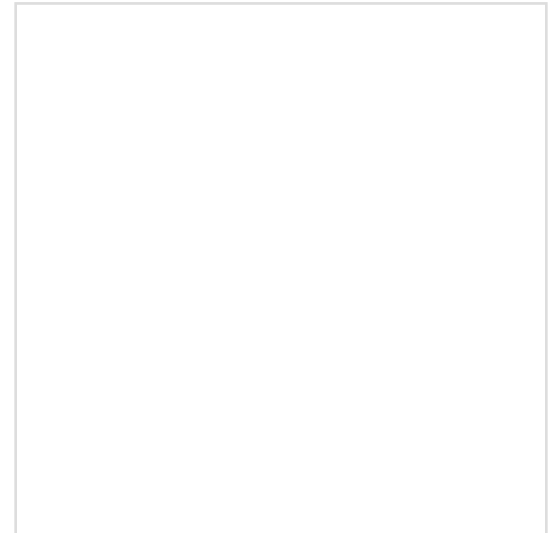

PARTS IMAGE

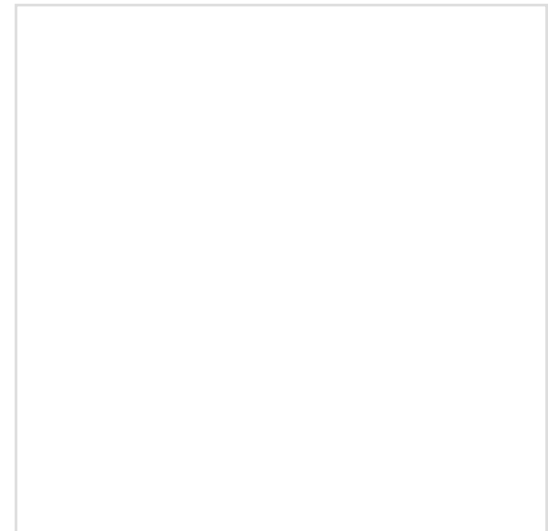

BOX IMAGE

13070-53Y00

BELT TENSIONER

Parts Number : 13070-53Y00

Manufacture 1 :

Manufacturer Number 1 :

Manufacture 2 :

Manufacturer Number 2 :

M.S.R.P 04/2010 :

Description: BELT TENSIONER

Application 1 :

Application 2 :

Application 3 :

Application 4 :

Application 5 :

Application 6 :

Application 7 :

Application 8 :

Application 9 :

Application 10 :

Application 11 :

Application 12 :

ZOOM+

ZOOM-

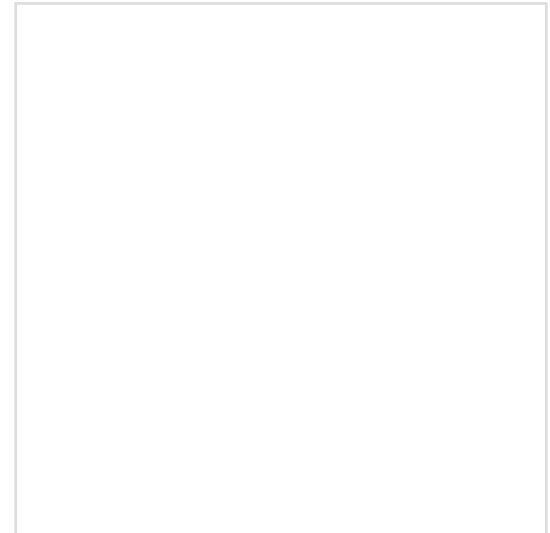

PARTS IMAGE

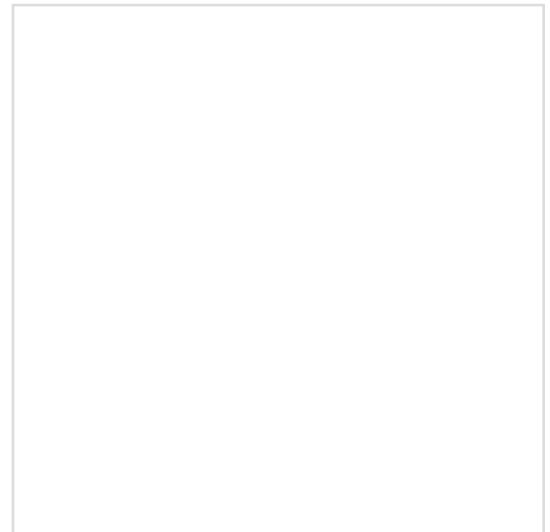

BOX IMAGE

13070-53Y13

BELT TENSIONER

Parts Number : 13070-53Y13

Manufacture 1 :

Manufacturer Number 1 :

Manufacture 2 :

Manufacturer Number 2 :

M.S.R.P 04/2010 :

Description: BELT TENSIONER

Application 1 :

Application 2 :

Application 3 :

Application 4 :

Application 5 :

Application 6 :

Application 7 :

Application 8 :

Application 9 :

Application 10 :

Application 11 :

Application 12 :

ZOOM+

ZOOM-

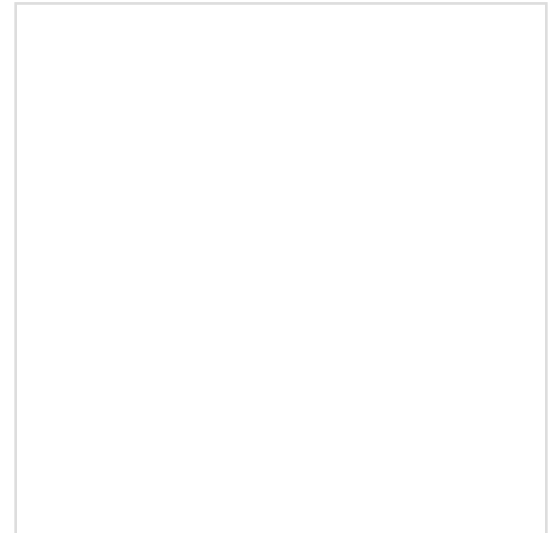

PARTS IMAGE

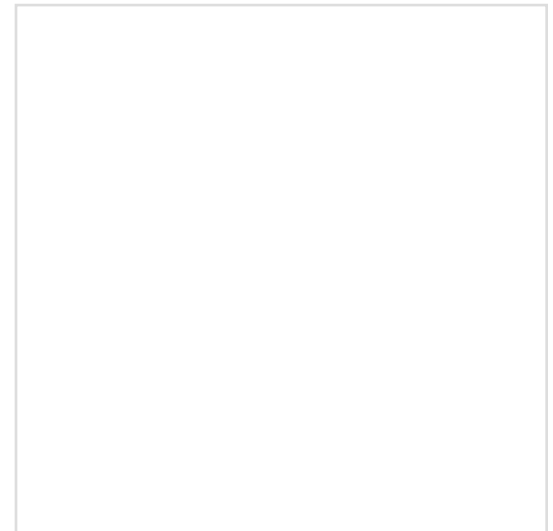

BOX IMAGE

13070-77A12

BELT TENSIONER MADE IN

Parts Number : 13070-77A12

Manufacture 1 :

Manufacturer Number 1 :

Manufacture 2 :

Manufacturer Number 2 :

M.S.R.P 04/2010 :

Description:

BELT TENSIONER MADE IN JAPAN

Application 1 :

Application 2 :

Application 3 :

Application 4 :

Application 5 :

Application 6 :

Application 7 :

Application 8 :

Application 9 :

Application 10 :

Application 11 :

Application 12 :

ZOOM+

ZOOM-



PARTS IMAGE



BOX IMAGE

13070-97E10

BELT TENSIONER

Parts Number : 13070-97E10

Manufacture 1 :

Manufacturer Number 1 :

Manufacture 2 :

Manufacturer Number 2 :

M.S.R.P 04/2010 :

Description: BELT TENSIONER

Application 1 :

Application 2 :

Application 3 :

Application 4 :

Application 5 :

Application 6 :

Application 7 :

Application 8 :

Application 9 :

Application 10 :

Application 11 :

Application 12 :

ZOOM+

ZOOM-



PARTS IMAGE

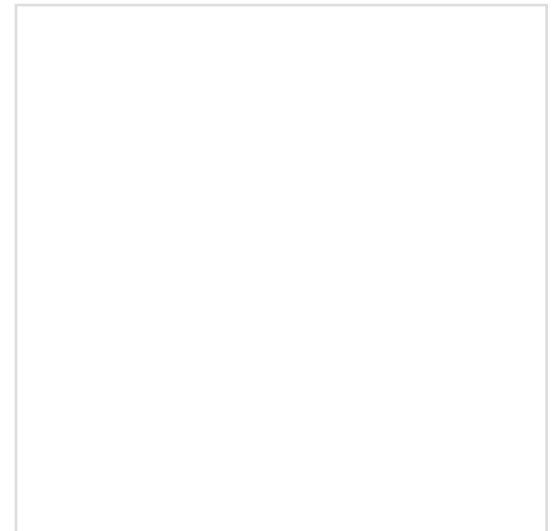

BOX IMAGE

13070-97E16

BELT TENSIONER

Parts Number : 13070-97E16

Manufacture 1 :

Manufacturer Number 1 :

Manufacture 2 :

Manufacturer Number 2 :

M.S.R.P 04/2010 :

Description: BELT TENSIONER

Application 1 :

Application 2 :

Application 3 :

Application 4 :

Application 5 :

Application 6 :

Application 7 :

Application 8 :

Application 9 :

Application 10 :

Application 11 :

Application 12 :

ZOOM+

ZOOM-

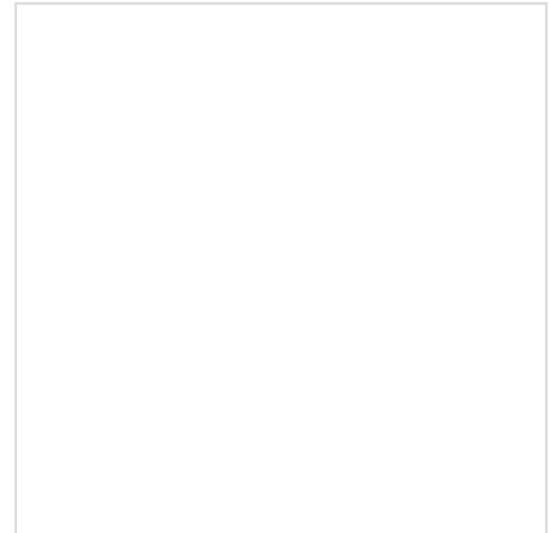

PARTS IMAGE

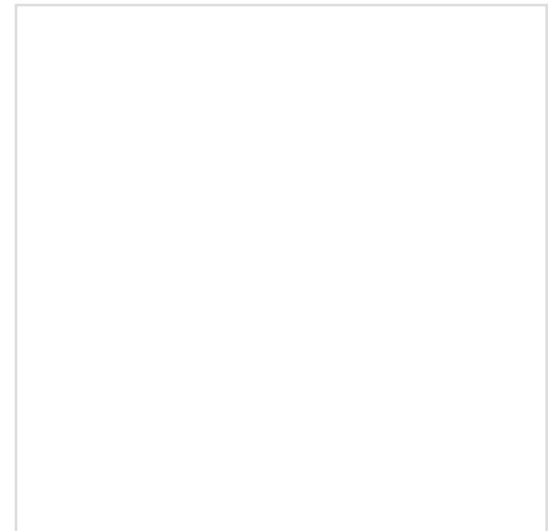

BOX IMAGE

13070-AA001

BELT TENSIONER MADE IN

Parts Number : 13070-AA001

Manufacture 1 : NSK

Manufacturer Number 1 : 52TB011B04A

Manufacture 2 :

Manufacture Number 2 :

M.S.R.P 04/2010 :

Description: BELT TENSIONER MADE IN JAPAN

Application 1 :

Application 2 :

Application 3 :

Application 4 :

Application 5 :

Application 6 :

Application 7 :

Application 8 :

Application 9 :

Application 10 :

Application 11 :

Application 12 :

ZOOM+ ZOOM-



PARTS IMAGE



BOX IMAGE

13070-AA010

BELT TENSIONER

Parts Number : 13070-AA010

Manufacture 1 : NTN

Manufacturer Number 1 : JPU52-52+JF326

Manufacture 2 :

Manufacture Number 2 :

M.S.R.P 04/2010 :

Description: BELT TENSIONER

Application 1 :

Application 2 :

Application 3 :

Application 4 :

Application 5 :

Application 6 :

Application 7 :

Application 8 :

Application 9 :

Application 10 :

Application 11 :

Application 12 :

ZOOM+

ZOOM-

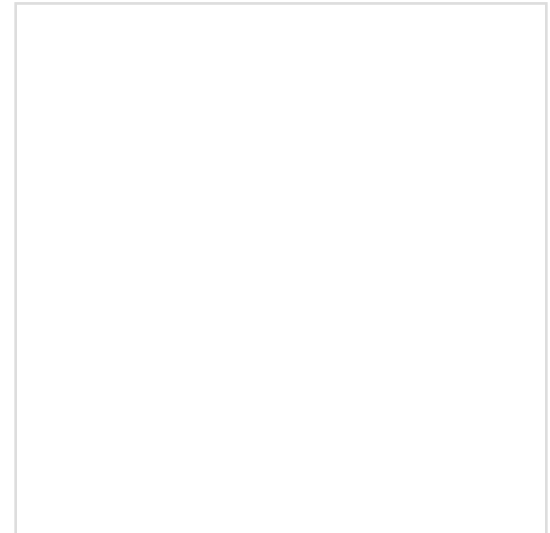

PARTS IMAGE

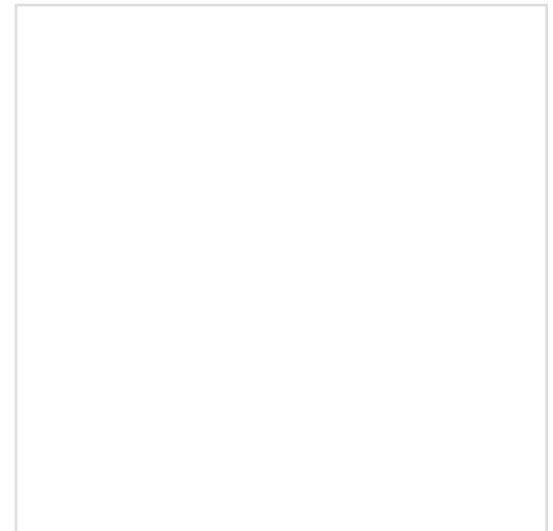

BOX IMAGE

13070-D0100

BELT TENSIONER

Parts Number : 13070-D0100

Manufacture 1 : NTN

Manufacturer Number 1 : JPU60-39+JF206

Manufacture 2 : NSK

Manufacturer Number 2 : 60TB021B05

M.S.R.P 04/2010 :

Description: BELT TENSIONER

Application 1 :

Application 2 :

Application 3 :

Application 4 :

Application 5 :

Application 6 :

Application 7 :

Application 8 :

Application 9 :

Application 10 :

Application 11 :

Application 12 :

ZOOM+

ZOOM-



PARTS IMAGE

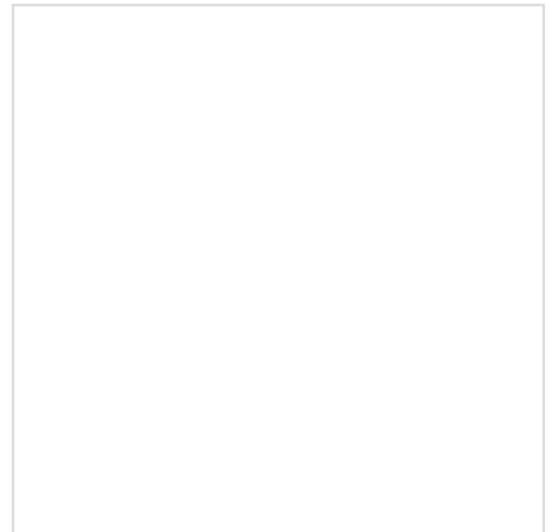

BOX IMAGE

13070-D4200

BELT TNESIONER

Parts Number : 13070-D4200

Manufacture 1 : NSK

Manufacturer Number 1 : 60TB079B01

Manufacture 2 :

Manufacture Number 2 :

M.S.R.P 04/2010 :

Description: BELT TNESIONER

Application 1 :

Application 2 :

Application 3 :

Application 4 :

Application 5 :

Application 6 :

Application 7 :

Application 8 :

Application 9 :

Application 10 :

Application 11 :

Application 12 :

ZOOM+

ZOOM-



PARTS IMAGE

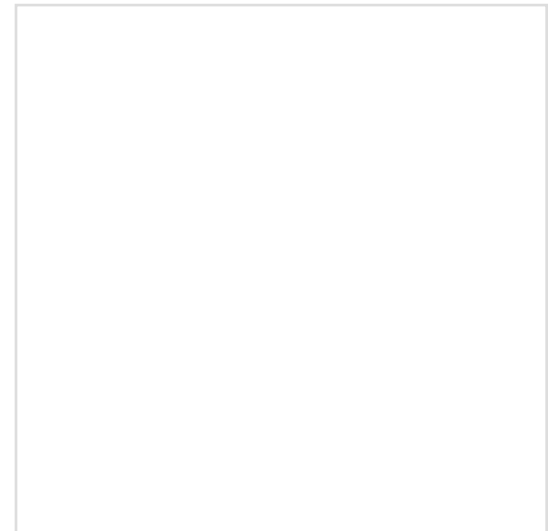

BOX IMAGE

13070-E3000

BELT TENSIONER

Parts Number : 13070-E3000

Manufacture 1 :

Manufacturer Number 1 :

Manufacture 2 :

Manufacturer Number 2 :

M.S.R.P 04/2010 :

Description: BELT TENSIONER

Application 1 :

Application 2 :

Application 3 :

Application 4 :

Application 5 :

Application 6 :

Application 7 :

Application 8 :

Application 9 :

Application 10 :

Application 11 :

Application 12 :

ZOOM+

ZOOM-

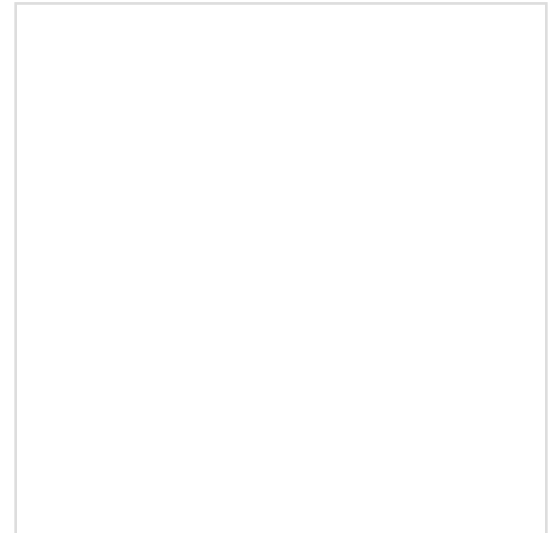

PARTS IMAGE

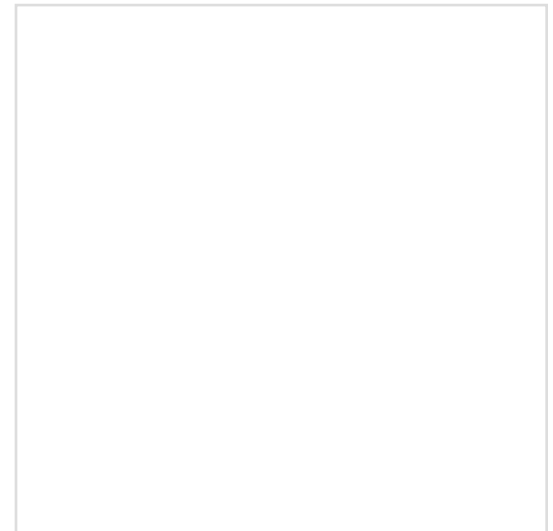

BOX IMAGE

13070-KA020

BELT TENSIONER

Parts Number : 13070-KA020

Manufacture 1 : NTN

Manufacturer Number 1 : JPU52-52+JF349

Manufacture 2 :

Manufacture Number 2 :

M.S.R.P 04/2010 :

Description: BELT TENSIONER

Application 1 :

Application 2 :

Application 3 :

Application 4 :

Application 5 :

Application 6 :

Application 7 :

Application 8 :

Application 9 :

Application 10 :

Application 11 :

Application 12 :

ZOOM+

ZOOM-

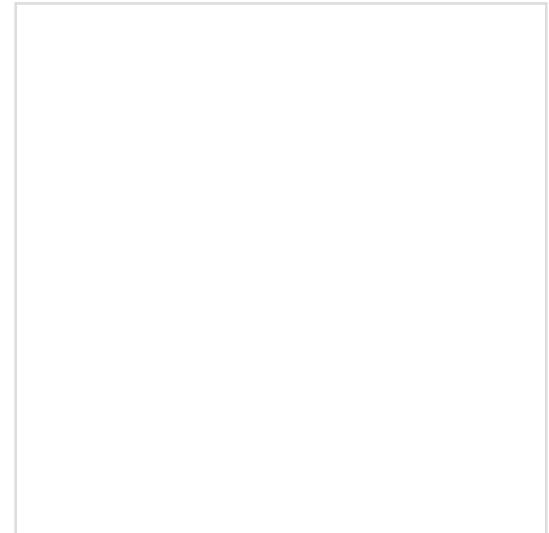

PARTS IMAGE

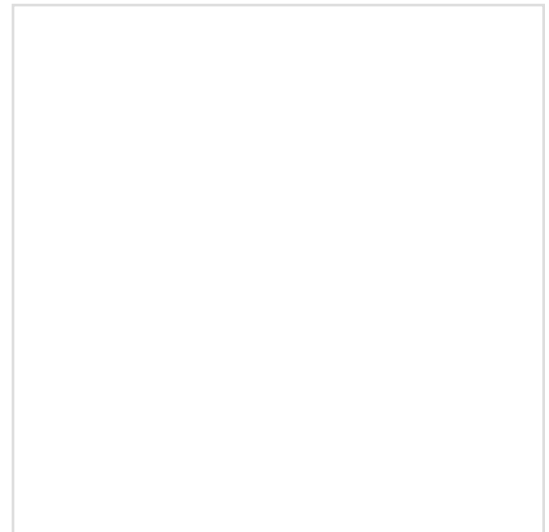

BOX IMAGE

13071-AA002

BELT TENSIONER MADE IN

Parts Number :	13071-AA002
Manufacture 1 :	NSK <input type="button" value="v"/>
Manufacturer Number 1 :	52TB011B06A
Manufacture 2 :	<input type="button" value="v"/>
Manufacturer Number 2 :	
M.S.R.P 04/2010 :	
Description:	BELT TENSIONER MADE IN JAPAN



PARTS IMAGE

- Application 1 :
- Application 2 :
- Application 3 :
- Application 4 :
- Application 5 :
- Application 6 :
- Application 7 :
- Application 8 :
- Application 9 :
- Application 10 :
- Application 11 :
- Application 12 :



BOX IMAGE

13073-AA142

BELT TENSIONER MADE IN

Parts Number : 13073-AA142
Manufacture 1 : KOYO
Manufacturer Number 1 : PU306030FRR9H
Manufacture 2 :
Manufacturer Number 2 :
M.S.R.P 04/2010 :
Description: BELT TENSIONER MADE IN JAPAN

- Application 1 :
- Application 2 :
- Application 3 :
- Application 4 :
- Application 5 :
- Application 6 :
- Application 7 :
- Application 8 :
- Application 9 :
- Application 10 :
- Application 11 :
- Application 12 :

ZOOM+ ZOOM-



PARTS IMAGE



BOX IMAGE

13073-AA150

BELT TENSIONER

Parts Number : 13073-AA150

Manufacture 1 : KOYO

Manufacturer Number 1 : PU106043RR9HX

Manufacture 2 :

Manufacture Number 2 :

M.S.R.P 04/2010 :

Description: BELT TENSIONER

Application 1 :

Application 2 :

Application 3 :

Application 4 :

Application 5 :

Application 6 :

Application 7 :

Application 8 :

Application 9 :

Application 10 :

Application 11 :

Application 12 :

ZOOM+

ZOOM-



PARTS IMAGE

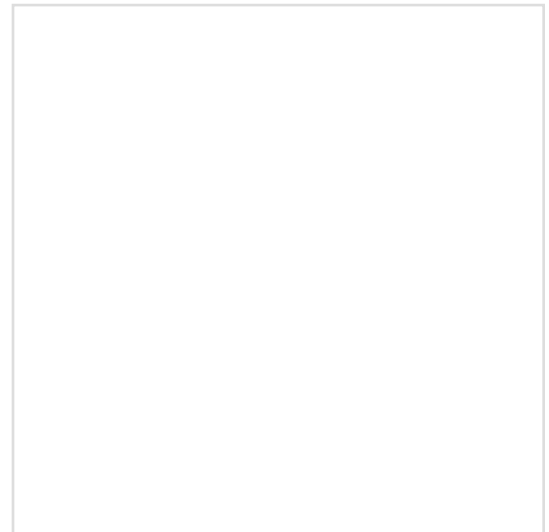

BOX IMAGE

13073-AA180

Parts Number : 13073-AA180

Manufacture 1 : NSK

Manufacturer Number 1 : 60TB0648

Manufacture 2 :

Manufacturer Number 2 :

M.S.R.P 04/2010 :

Description: BELT TENSIONER MADE IN JAPAN

BELT TENSIONER MADE IN



PARTS IMAGE

Application 1 :

Application 2 :

Application 3 :

Application 4 :

Application 5 :

Application 6 :

Application 7 :

Application 8 :

Application 9 :

Application 10 :

Application 11 :

Application 12 :



BOX IMAGE

13073-AA190

Parts Number : 13073-AA190

Manufacture 1 : NSK

Manufacturer Number 1 : 60TB0693

Manufacture 2 :

Manufacturer Number 2 :

M.S.R.P 04/2010 :

Description: BELT TENSIONER MADE IN JAPAN

Application 1 :

Application 2 :

Application 3 :

Application 4 :

Application 5 :

Application 6 :

Application 7 :

Application 8 :

Application 9 :

Application 10 :

Application 11 :

Application 12 :

BELT TENSIONER MADE IN

ZOOM+

ZOOM-



PARTS IMAGE



BOX IMAGE

13077-45V00

BELT TENSIONER MADE IN

Parts Number : 13077-45V00

Manufacture 1 : NSK

Manufacturer Number 1 : 60TB0713

Manufacture 2 :

Manufacturer Number 2 :

M.S.R.P 04/2010 :

Description: BELT TENSIONER MADE IN JAPAN

Application 1 :

Application 2 :

Application 3 :

Application 4 :

Application 5 :

Application 6 :

Application 7 :

Application 8 :

Application 9 :

Application 10 :

Application 11 :

Application 12 :

ZOOM+ ZOOM-



PARTS IMAGE



BOX IMAGE

13077-54A00

BELT TENSIONER

Parts Number : 13077-54A00

Manufacture 1 : NTN

Manufacturer Number 1 : JPU60-150

Manufacture 2 :

Manufacturer Number 2 :

M.S.R.P 04/2010 :

Description: BELT TENSIONER

Application 1 :

Application 2 :

Application 3 :

Application 4 :

Application 5 :

Application 6 :

Application 7 :

Application 8 :

Application 9 :

Application 10 :

Application 11 :

Application 12 :

ZOOM+

ZOOM-



PARTS IMAGE

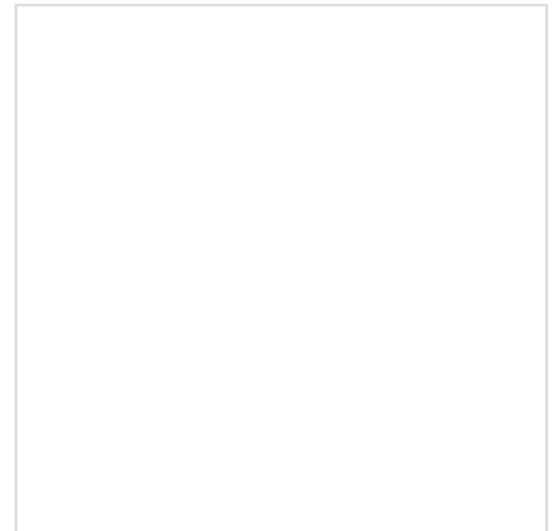

BOX IMAGE

13077-D4200

BELT TENSIONER

Parts Number : 13077-D4200

Manufacture 1 : NSK

Manufacturer Number 1 : 52TB0616B01

Manufacture 2 :

Manufacture Number 2 :

M.S.R.P 04/2010 :

Description: BELT TENSIONER

Application 1 :

Application 2 :

Application 3 :

Application 4 :

Application 5 :

Application 6 :

Application 7 :

Application 8 :

Application 9 :

Application 10 :

Application 11 :

Application 12 :

ZOOM+

ZOOM-

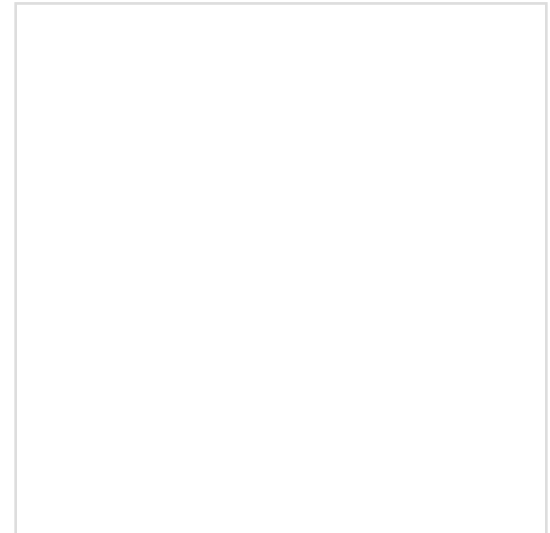

PARTS IMAGE

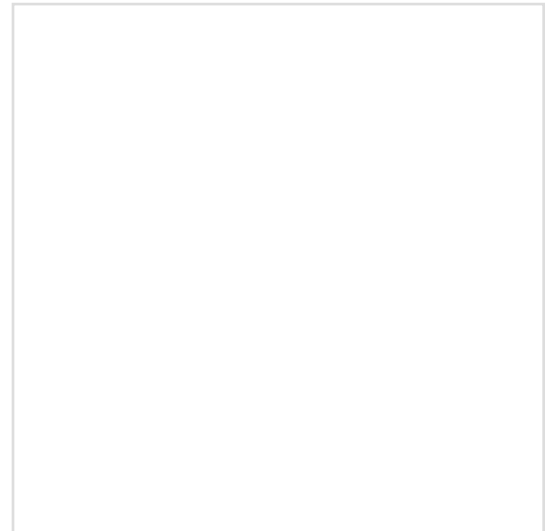

BOX IMAGE

13077-F6510

BELT TENSIONER MADE IN

Parts Number : 13077-F6510

Manufacture 1 : NSK

Manufacturer Number 1 : 60TB0711

Manufacture 2 :

Manufacturer Number 2 :

M.S.R.P 04/2010 :

Description: BELT TENSIONER MADE IN JAPAN

Application 1 :

Application 2 :

Application 3 :

Application 4 :

Application 5 :

Application 6 :

Application 7 :

Application 8 :

Application 9 :

Application 10 :

Application 11 :

Application 12 :

ZOOM+ ZOOM-



PARTS IMAGE



BOX IMAGE

13077-F6511

BELT TENSIONER MADE IN

Parts Number : 13077-F6511

Manufacture 1 : NSK

Manufacturer Number 1 : 60TB715B

Manufacture 2 :

Manufacturer Number 2 :

M.S.R.P 04/2010 :

Description: BELT TENSIONER MADE IN JAPAN

Application 1 :

Application 2 :

Application 3 :

Application 4 :

Application 5 :

Application 6 :

Application 7 :

Application 8 :

Application 9 :

Application 10 :

Application 11 :

Application 12 :

ZOOM+ ZOOM-



PARTS IMAGE



BOX IMAGE

13085-AA010

Parts Number :	13085-AA010
Manufacture 1 :	NSK <input type="button" value="v"/>
Manufacturer Number 1 :	59TB0515
Manufacture 2 :	<input type="button" value="v"/>
Manufacture Number 2 :	13085-AA080
M.S.R.P 04/2010 :	
Description:	BELT TENSIONER MADE IN JAPAN

BELT TENSIONER MADE IN

ZOOM+ ZOOM-



PARTS IMAGE

- Application 1 : 13085-AA080
- Application 2 :
- Application 3 :
- Application 4 :
- Application 5 :
- Application 6 :
- Application 7 :
- Application 8 :
- Application 9 :
- Application 10 :
- Application 11 :
- Application 12 :



BOX IMAGE

13085-AA020

BELT TENSIONER

Parts Number : 13085-AA020

Manufacture 1 : KOYO

Manufacturer Number 1 : PU106125BRR9HY

Manufacture 2 :

Manufacture Number 2 :

M.S.R.P 04/2010 :

Description: BELT TENSIONER

Application 1 :

Application 2 :

Application 3 :

Application 4 :

Application 5 :

Application 6 :

Application 7 :

Application 8 :

Application 9 :

Application 10 :

Application 11 :

Application 12 :

ZOOM+

ZOOM-

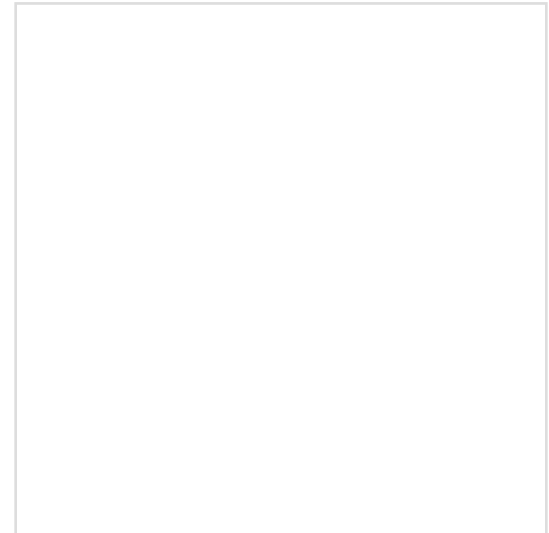

PARTS IMAGE

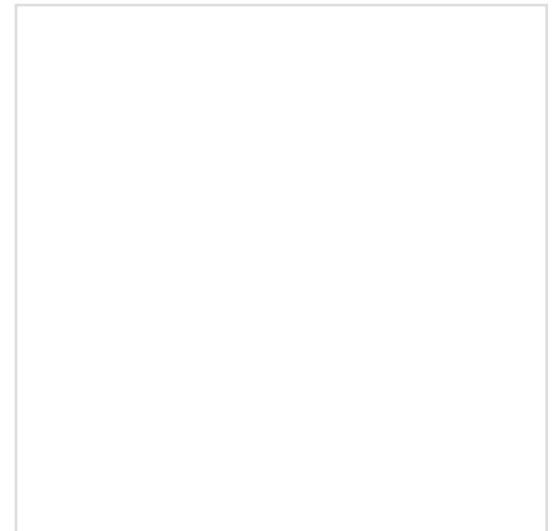

BOX IMAGE

13404-P13-003

BELT TENSIONER

Parts Number : 13404-P13-003

Manufacture 1 : KOYO

Manufacturer Number 1 : PU267020RR1FS1

Manufacture 2 :

Manufacturer Number 2 :

M.S.R.P 04/2010 :

Description: BELT TENSIONER

Application 1 :

Application 2 :

Application 3 :

Application 4 :

Application 5 :

Application 6 :

Application 7 :

Application 8 :

Application 9 :

Application 10 :

Application 11 :

Application 12 :

ZOOM+

ZOOM-



PARTS IMAGE

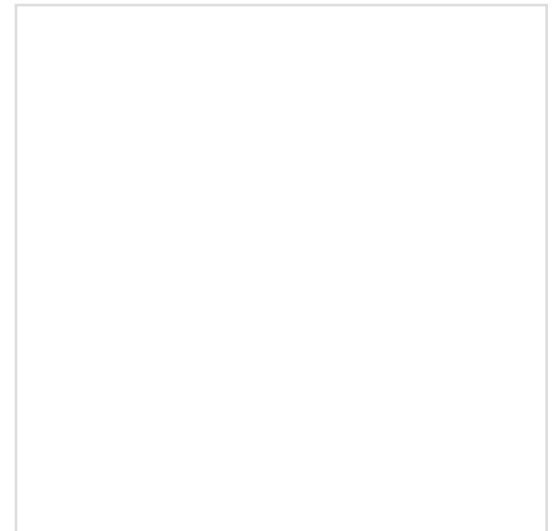

BOX IMAGE

13404-PT0-004

BELT TENSIONER MADE IN

Parts Number : 13404-PT0-004

Manufacture 1 : KOYO

Manufacturer Number 1 : PU27702HRR1FS1

Manufacture 2 : NSK

Manufacturer Number 2 : 70TB0603

M.S.R.P 04/2010 :

Description: BELT TENSIONER MADE IN JAPAN

Application 1 :

Application 2 :

Application 3 :

Application 4 :

Application 5 :

Application 6 :

Application 7 :

Application 8 :

Application 9 :

Application 10 :

Application 11 :

Application 12 :

ZOOM+

ZOOM-



PARTS IMAGE



BOX IMAGE

13503-11010

BELT TENSIONER MADE IN

Parts Number : 13503-11010

Manufacture 1 : KOYO

Manufacturer Number 1 : DG2550B-32RR1D

Manufacture 2 :

Manufacturer Number 2 :

M.S.R.P 04/2010 :

Description: BELT TENSIONER MADE IN JAPAN

Application 1 :

Application 2 :

Application 3 :

Application 4 :

Application 5 :

Application 6 :

Application 7 :

Application 8 :

Application 9 :

Application 10 :

Application 11 :

Application 12 :

ZOOM+

ZOOM-



PARTS IMAGE



BOX IMAGE

13503-11030

BELT TENSIONER MADE IN

Parts Number : 13503-11030

Manufacture 1 : NSK

Manufacturer Number 1 : 54ST55T1XDDWAA18CGI-01

Manufacture 2 :

Manufacture Number 2 :

M.S.R.P 04/2010 :

Description: BELT TENSIONER MADE IN JAPAN

Application 1 :

Application 2 :

Application 3 :

Application 4 :

Application 5 :

Application 6 :

Application 7 :

Application 8 :

Application 9 :

Application 10 :

Application 11 :

Application 12 :

ZOOM+ ZOOM-



PARTS IMAGE



BOX IMAGE

13503-11040

BELT TENSIONER

Parts Number : 13503-11040

Manufacture 1 : NSK

Manufacturer Number 1 : 54ST55T1XDDWAA18CGI-01

Manufacture 2 :

Manufacture Number 2 :

M.S.R.P 04/2010 :

Description: BELT TENSIONER

Application 1 :

Application 2 :

Application 3 :

Application 4 :

Application 5 :

Application 6 :

Application 7 :

Application 8 :

Application 9 :

Application 10 :

Application 11 :

Application 12 :

ZOOM+

ZOOM-



PARTS IMAGE

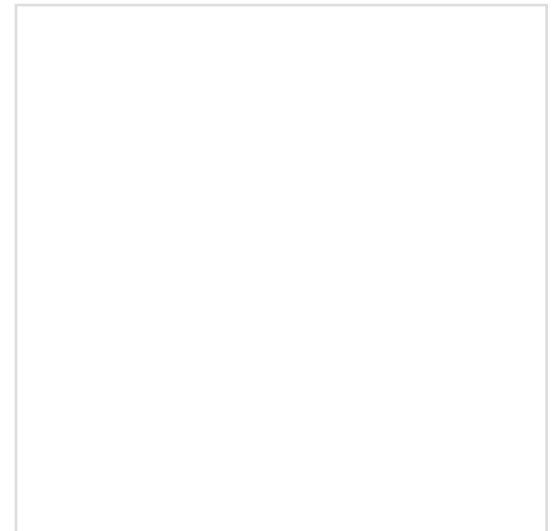

BOX IMAGE

13503-50011

WHEEL BEARING MADE IN

Parts Number : 13503-50011

Manufacture 1 : KOYO

Manufacturer Number 1 : PU3066308RR9D

Manufacture 2 :

Manufacturer Number 2 :

M.S.R.P 04/2010 :

Description: WHEEL BEARING MADE IN JAPAN

Application 1 :

Application 2 :

Application 3 :

Application 4 :

Application 5 :

Application 6 :

Application 7 :

Application 8 :

Application 9 :

Application 10 :

Application 11 :

Application 12 :

ZOOM+

ZOOM-



PARTS IMAGE



BOX IMAGE

13503-62030

BELT TENSIONER MADE IN

Parts Number : 13503-62030

Manufacture 1 : KOYO

Manufacturer Number 1 : PU126231ARR9D

Manufacture 2 :

Manufacture Number 2 :

M.S.R.P 04/2010 :

Description: BELT TENSIONER MADE IN JAPAN

Application 1 :

Application 2 :

Application 3 :

Application 4 :

Application 5 :

Application 6 :

Application 7 :

Application 8 :

Application 9 :

Application 10 :

Application 11 :

Application 12 :

ZOOM+

ZOOM-



PARTS IMAGE



BOX IMAGE

13503-62040

BELT TENSIONER MADE IN

Parts Number : 13503-62040

Manufacture 1 : NSK

Manufacturer Number 1 : 62STD67T12DDWA18CG01 EA7L 006

Manufacture 2 :

Manufacture Number 2 :

M.S.R.P 04/2010 :

Description: BELT TENSIONER MADE IN JAPAN

Application 1 :

Application 2 :

Application 3 :

Application 4 :

Application 5 :

Application 6 :

Application 7 :

Application 8 :

Application 9 :

Application 10 :

Application 11 :

Application 12 :

ZOOM+

ZOOM-

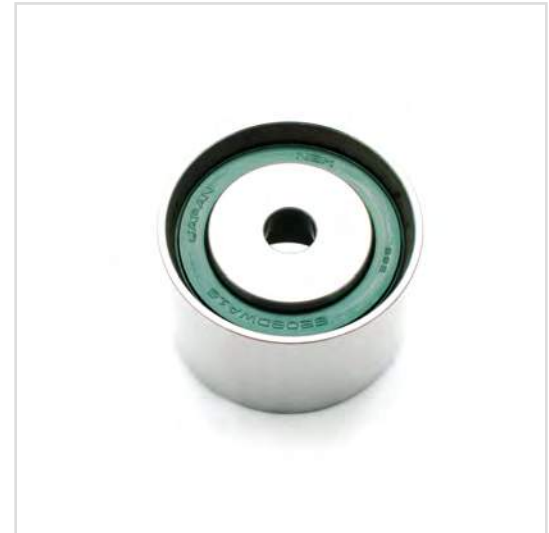

PARTS IMAGE



BOX IMAGE

13503-63011

BELT TENSIONER MADE IN

Parts Number : 13503-63011

Manufacture 1 : KOYO

Manufacturer Number 1 : PU355816RR9D

Manufacture 2 :

Manufacturer Number 2 :

M.S.R.P 04/2010 :

Description: BELT TENSIONER MADE IN JAPAN

Application 1 :

Application 2 :

Application 3 :

Application 4 :

Application 5 :

Application 6 :

Application 7 :

Application 8 :

Application 9 :

Application 10 :

Application 11 :

Application 12 :

ZOOM+

ZOOM-



PARTS IMAGE



BOX IMAGE

13503-63021

BELT TENSIONER

Parts Number : 13503-63021

Manufacture 1 : NSK

Manufacturer Number 1 : 57TB3705

Manufacture 2 :

Manufacturer Number 2 :

M.S.R.P 04/2010 :

Description: BELT TENSIONER

Application 1 :

Application 2 :

Application 3 :

Application 4 :

Application 5 :

Application 6 :

Application 7 :

Application 8 :

Application 9 :

Application 10 :

Application 11 :

Application 12 :

ZOOM+

ZOOM-

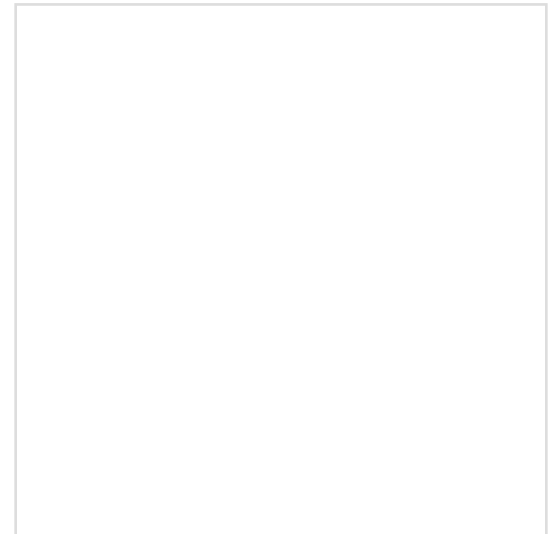

PARTS IMAGE

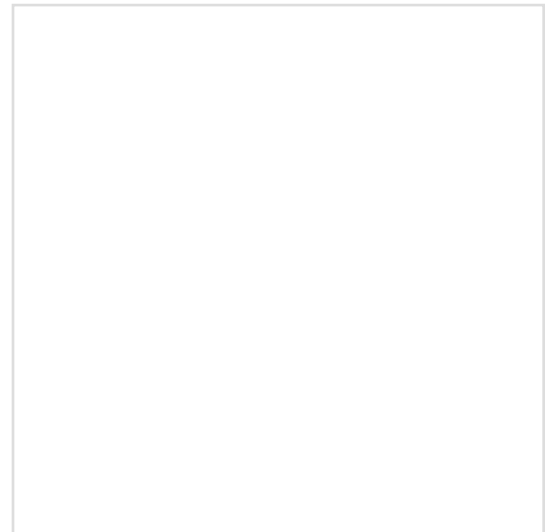

BOX IMAGE

13503-65010

BELT TENSIONER MADE IN

Parts Number : 13503-65010

Manufacture 1 : KOYO

Manufacturer Number 1 : DG60932RD1HCS64+SV2

Manufacture 2 :

Manufacturer Number 2 :

M.S.R.P 04/2010 :

Description: BELT TENSIONER MADE IN JAPAN

Application 1 :

Application 2 :

Application 3 :

Application 4 :

Application 5 :

Application 6 :

Application 7 :

Application 8 :

Application 9 :

Application 10 :

Application 11 :

Application 12 :

ZOOM+

ZOOM-



PARTS IMAGE



BOX IMAGE

13505-11010

Parts Number : 13505-11010

Manufacture 1 : NSK

Manufacturer Number 1 : 50TB0526B02

Manufacture 2 :

Manufacture Number 2 :

M.S.R.P 04/2010 :

Description: WHEEL BEARING MADE IN JAPAN

WHEEL BEARING MADE IN



PARTS IMAGE

Application 1 :

Application 2 :

Application 3 :

Application 4 :

Application 5 :

Application 6 :

Application 7 :

Application 8 :

Application 9 :

Application 10 :

Application 11 :

Application 12 :



BOX IMAGE

13505-11040

Parts Number : 13505-11040

Manufacture 1 : KOYO

Manufacturer Number 1 : PU345637RR1D

Manufacture 2 : NSK

Manufacture Number 2 : 56TB0503BO1

M.S.R.P 04/2010 :

Description: WHEEL BEARING MADE IN JAPAN

WHEEL BEARING MADE IN

ZOOM+

ZOOM-



PARTS IMAGE

Application 1 :

Application 2 :

Application 3 :

Application 4 :

Application 5 :

Application 6 :

Application 7 :

Application 8 :

Application 9 :

Application 10 :

Application 11 :

Application 12 :



BOX IMAGE

13505-15041

BELT TENSIONER MADE IN

Parts Number : 13505-15041

Manufacture 1 : NSK

Manufacturer Number 1 : 52TB0529B01

Manufacture 2 :

Manufacturer Number 2 :

M.S.R.P 04/2010 :

Description: BELT TENSIONER MADE IN JAPAN

Application 1 :

Application 2 :

Application 3 :

Application 4 :

Application 5 :

Application 6 :

Application 7 :

Application 8 :

Application 9 :

Application 10 :

Application 11 :

Application 12 :

ZOOM+ ZOOM-



PARTS IMAGE



BOX IMAGE

13505-15050

BELT TENSIONER MADE IN

Parts Number : 13505-15050

Manufacture 1 : NSK

Manufacturer Number 1 : 57TB0505B01

Manufacture 2 :

Manufacture Number 2 :

M.S.R.P 04/2010 :

Description: BELT TENSIONER MADE IN JAPAN

Application 1 :

Application 2 :

Application 3 :

Application 4 :

Application 5 :

Application 6 :

Application 7 :

Application 8 :

Application 9 :

Application 10 :

Application 11 :

Application 12 :

ZOOM+

ZOOM-



PARTS IMAGE



BOX IMAGE

13505-16020

BELT TENSIONER MADE IN

Parts Number :	13505-16020
Manufacture 1 :	KOYO <input type="button" value="v"/>
Manufacturer Number 1 :	PU265527RR1HV
Manufacture 2 :	<input type="button" value="v"/>
Manufacturer Number 2 :	
M.S.R.P 04/2010 :	
Description:	BELT TENSIONER MADE IN JAPAN

ZOOM+ ZOOM-



PARTS IMAGE

- Application 1 :
- Application 2 :
- Application 3 :
- Application 4 :
- Application 5 :
- Application 6 :
- Application 7 :
- Application 8 :
- Application 9 :
- Application 10 :
- Application 11 :
- Application 12 :



BOX IMAGE

13505-20030

BELT TENSIONER MADE IN

Parts Number : 13505-20030

Manufacture 1 : KOYO

Manufacturer Number 1 : LAT1031

Manufacture 2 :

Manufacturer Number 2 :

M.S.R.P 04/2010 :

Description: BELT TENSIONER MADE IN JAPAN

Application 1 :

Application 2 :

Application 3 :

Application 4 :

Application 5 :

Application 6 :

Application 7 :

Application 8 :

Application 9 :

Application 10 :

Application 11 :

Application 12 :

ZOOM+

ZOOM-



PARTS IMAGE



BOX IMAGE

13505-42020

BELT TENSIONER MADE IN

Parts Number : 13505-42020

Manufacture 1 : NSK

Manufacturer Number 1 : 64TB051B01

Manufacture 2 :

Manufacturer Number 2 :

M.S.R.P 04/2010 :

Description: BELT TENSIONER MADE IN JAPAN

Application 1 :

Application 2 :

Application 3 :

Application 4 :

Application 5 :

Application 6 :

Application 7 :

Application 8 :

Application 9 :

Application 10 :

Application 11 :

Application 12 :

ZOOM+ ZOOM-



PARTS IMAGE



BOX IMAGE

13505-43010

BELT TENSIONER MADE IN

Parts Number : 13505-43010

Manufacture 1 : NSK

Manufacturer Number 1 : 62TB063B12

Manufacture 2 :

Manufacturer Number 2 :

M.S.R.P 04/2010 :

Description: BELT TENSIONER MADE IN JAPAN

Application 1 :

Application 2 :

Application 3 :

Application 4 :

Application 5 :

Application 6 :

Application 7 :

Application 8 :

Application 9 :

Application 10 :

Application 11 :

Application 12 :

ZOOM+ ZOOM-



PARTS IMAGE



BOX IMAGE

13505-46041

BELT TENSIONER MADE IN

Parts Number : 13505-46041

Manufacture 1 : KOYO

Manufacturer Number 1 : LAT1008A

Manufacture 2 :

Manufacturer Number 2 :

M.S.R.P 04/2010 :

Description: BELT TENSIONER MADE IN JAPAN

Application 1 :

Application 2 :

Application 3 :

Application 4 :

Application 5 :

Application 6 :

Application 7 :

Application 8 :

Application 9 :

Application 10 :

Application 11 :

Application 12 :

ZOOM+

ZOOM-



PARTS IMAGE



BOX IMAGE

13505-50021

BELT TENSIONER MADE IN

Parts Number : 13505-50021

Manufacture 1 : NSK

Manufacturer Number 1 : 62TB0630B01

Manufacture 2 :

Manufacturer Number 2 :

M.S.R.P 04/2010 :

Description: BELT TENSIONER MADE IN JAPAN

Application 1 :

Application 2 :

Application 3 :

Application 4 :

Application 5 :

Application 6 :

Application 7 :

Application 8 :

Application 9 :

Application 10 :

Application 11 :

Application 12 :

ZOOM+

ZOOM-



PARTS IMAGE



BOX IMAGE

13505-50030

BELT TENSIONER MADE IN

Parts Number : 13505-50030

Manufacture 1 : NSK

Manufacturer Number 1 : 62TB0630B07

Manufacture 2 :

Manufacture Number 2 :

M.S.R.P 04/2010 :

Description: BELT TENSIONER MADE IN JAPAN

Application 1 :

Application 2 :

Application 3 :

Application 4 :

Application 5 :

Application 6 :

Application 7 :

Application 8 :

Application 9 :

Application 10 :

Application 11 :

Application 12 :

ZOOM+ ZOOM-



PARTS IMAGE



BOX IMAGE

13505-54010

BELT TENSIONER

Parts Number : 13505-54010

Manufacture 1 : NSK

Manufacturer Number 1 : 60TB026B02

Manufacture 2 :

Manufacturer Number 2 :

M.S.R.P 04/2010 :

Description: BELT TENSIONER

Application 1 :

Application 2 :

Application 3 :

Application 4 :

Application 5 :

Application 6 :

Application 7 :

Application 8 :

Application 9 :

Application 10 :

Application 11 :

Application 12 :

ZOOM+

ZOOM-



PARTS IMAGE

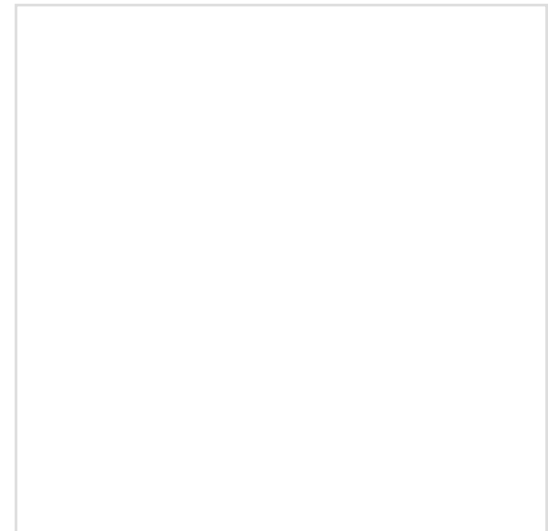

BOX IMAGE

13505-62060

BELT TENSIONER MADE IN

Parts Number : 13505-62060

Manufacture 1 : NSK

Manufacturer Number 1 : 62TB0631B01

Manufacture 2 : KOYO

Manufacture Number 2 : LAT1018C

M.S.R.P 04/2010 :

Description: BELT TENSIONER MADE IN JAPAN

Application 1 :

Application 2 :

Application 3 :

Application 4 :

Application 5 :

Application 6 :

Application 7 :

Application 8 :

Application 9 :

Application 10 :

Application 11 :

Application 12 :

ZOOM+

ZOOM-



PARTS IMAGE



BOX IMAGE

13505-62070

BELT TENSIONER MADE IN

Parts Number : 13505-62070

Manufacture 1 : KOYO

Manufacturer Number 1 : LAT1002B

Manufacture 2 :

Manufacturer Number 2 :

M.S.R.P 04/2010 :

Description: BELT TENSIONER MADE IN JAPAN

Application 1 :

Application 2 :

Application 3 :

Application 4 :

Application 5 :

Application 6 :

Application 7 :

Application 8 :

Application 9 :

Application 10 :

Application 11 :

Application 12 :

ZOOM+

ZOOM-



PARTS IMAGE



BOX IMAGE

13505-63011

BELT TENSIONER MADE IN

Parts Number :	13505-63011
Manufacture 1 :	NSK <input type="button" value="v"/>
Manufacturer Number 1 :	57TB0609B01
Manufacture 2 :	<input type="button" value="v"/>
Manufacture Number 2 :	
M.S.R.P 04/2010 :	
Description:	BELT TENSIONER MADE IN JAPAN

- Application 1 :
- Application 2 :
- Application 3 :
- Application 4 :
- Application 5 :
- Application 6 :
- Application 7 :
- Application 8 :
- Application 9 :
- Application 10 :
- Application 11 :
- Application 12 :

ZOOM+ ZOOM-



PARTS IMAGE



BOX IMAGE

13505-64011

BELT TENSIONER

Parts Number : 13505-64011

Manufacture 1 : NSK

Manufacturer Number 1 : 62TB0520B01

Manufacture 2 :

Manufacturer Number 2 :

M.S.R.P 04/2010 :

Description: BELT TENSIONER

Application 1 :

Application 2 :

Application 3 :

Application 4 :

Application 5 :

Application 6 :

Application 7 :

Application 8 :

Application 9 :

Application 10 :

Application 11 :

Application 12 :

ZOOM+

ZOOM-

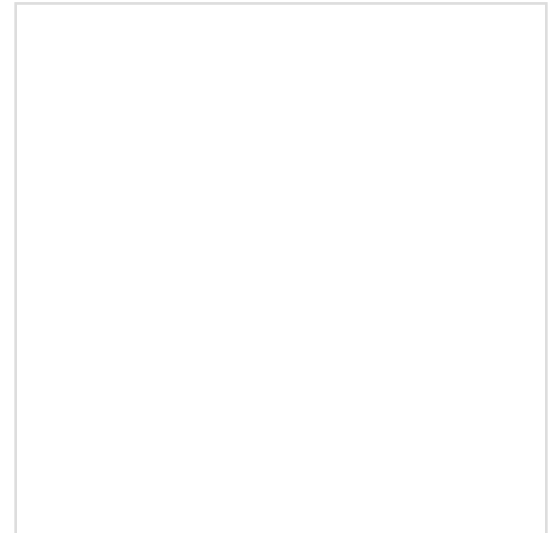

PARTS IMAGE

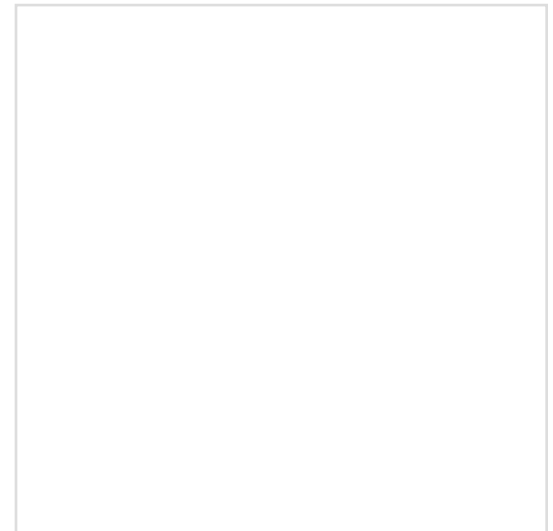

BOX IMAGE

13505-65020

BELT TENSIONER MADE IN

Parts Number : 13505-65020

Manufacture 1 : NSK

Manufacturer Number 1 : 62TB0612B04

Manufacture 2 :

Manufacturer Number 2 :

M.S.R.P 04/2010 :

Description: BELT TENSIONER MADE IN JAPAN

Application 1 :

Application 2 :

Application 3 :

Application 4 :

Application 5 :

Application 6 :

Application 7 :

Application 8 :

Application 9 :

Application 10 :

Application 11 :

Application 12 :

ZOOM+ ZOOM-



PARTS IMAGE



BOX IMAGE

13505-65040

BELT TENSIONER MADE IN

Parts Number : 13505-65040

Manufacture 1 : NSK

Manufacturer Number 1 : 62TB0811B01

Manufacture 2 :

Manufacture Number 2 :

M.S.R.P 04/2010 :

Description: BELT TENSIONER MADE IN JAPAN

Application 1 :

Application 2 :

Application 3 :

Application 4 :

Application 5 :

Application 6 :

Application 7 :

Application 8 :

Application 9 :

Application 10 :

Application 11 :

Application 12 :

ZOOM+ ZOOM-



PARTS IMAGE



BOX IMAGE

13505-74011

BELT TENSIONER MADE IN

Parts Number : 13505-74011

Manufacture 1 : NSK

Manufacturer Number 1 : 57TB3705B01

Manufacture 2 :

Manufacture Number 2 :

M.S.R.P 04/2010 :

Description: BELT TENSIONER MADE IN JAPAN

Application 1 :

Application 2 :

Application 3 :

Application 4 :

Application 5 :

Application 6 :

Application 7 :

Application 8 :

Application 9 :

Application 10 :

Application 11 :

Application 12 :

ZOOM+ ZOOM-



PARTS IMAGE



BOX IMAGE

13505-74030

BELT TENSIONER MADE IN

Parts Number : 13505-74030

Manufacture 1 : KOYO

Manufacturer Number 1 : PU245835RR9HY

Manufacture 2 :

Manufacture Number 2 :

M.S.R.P 04/2010 :

Description: BELT TENSIONER MADE IN JAPAN

Application 1 :

Application 2 :

Application 3 :

Application 4 :

Application 5 :

Application 6 :

Application 7 :

Application 8 :

Application 9 :

Application 10 :

Application 11 :

Application 12 :

ZOOM+

ZOOM-



PARTS IMAGE



BOX IMAGE

13505-87102

BELT TENSIONER

Parts Number : 13505-87102

Manufacture 1 : NTN

Manufacturer Number 1 : JPU50-80+JF513

Manufacture 2 :

Manufacturer Number 2 :

M.S.R.P 04/2010 :

Description: BELT TENSIONER

Application 1 :

Application 2 :

Application 3 :

Application 4 :

Application 5 :

Application 6 :

Application 7 :

Application 8 :

Application 9 :

Application 10 :

Application 11 :

Application 12 :

ZOOM+

ZOOM-

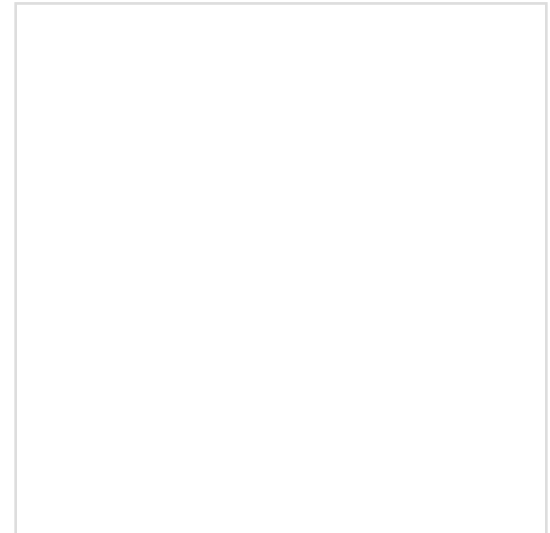

PARTS IMAGE

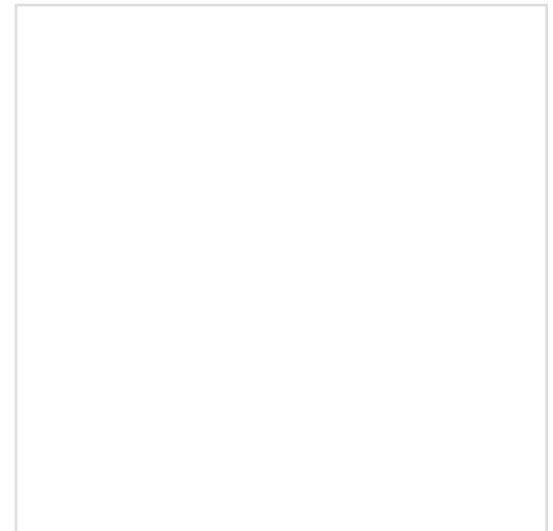

BOX IMAGE

13505-87702

BELT TENSIONER

Parts Number : 13505-87702

Manufacture 1 : NTN

Manufacturer Number 1 : JPU50-6+JF265

Manufacture 2 :

Manufacture Number 2 :

M.S.R.P 04/2010 :

Description: BELT TENSIONER

Application 1 :

Application 2 :

Application 3 :

Application 4 :

Application 5 :

Application 6 :

Application 7 :

Application 8 :

Application 9 :

Application 10 :

Application 11 :

Application 12 :

ZOOM+

ZOOM-



PARTS IMAGE

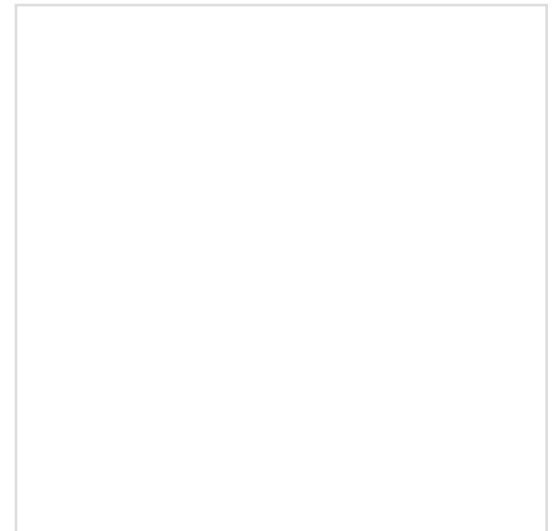

BOX IMAGE

13505-88383

BELT TENSIONER

Parts Number : 13505-88383

Manufacture 1 : KOYO

Manufacturer Number 1 : U00392B

Manufacture 2 :

Manufacture Number 2 :

M.S.R.P 04/2010 :

Description: BELT TENSIONER

Application 1 :

Application 2 :

Application 3 :

Application 4 :

Application 5 :

Application 6 :

Application 7 :

Application 8 :

Application 9 :

Application 10 :

Application 11 :

Application 12 :

ZOOM+

ZOOM-



PARTS IMAGE

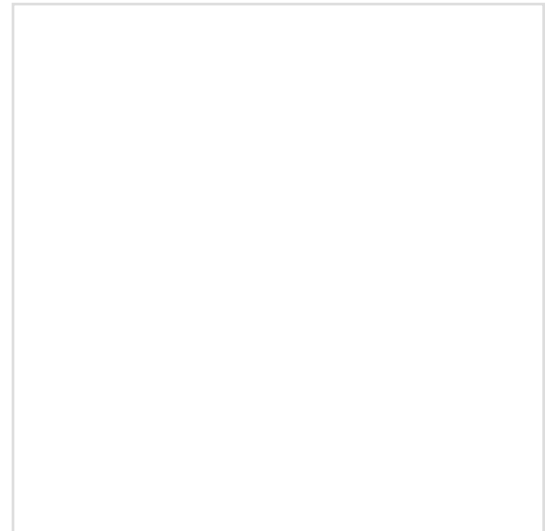

BOX IMAGE

13540-20021

BELT TENSIONER MADE IN

Parts Number : 13540-20021

Manufacture 1 : NTN

Manufacturer Number 1 : HAT006-11

Manufacture 2 :

Manufacturer Number 2 :

M.S.R.P 04/2010 :

Description: BELT TENSIONER MADE IN JAPAN

Application 1 :

Application 2 :

Application 3 :

Application 4 :

Application 5 :

Application 6 :

Application 7 :

Application 8 :

Application 9 :

Application 10 :

Application 11 :

Application 12 :

ZOOM+ ZOOM-



PARTS IMAGE



BOX IMAGE

13540-20030

BELT TENSIONER MADE IN

Parts Number : 13540-20030

Manufacture 1 : NTN

Manufacturer Number 1 : HATO090S-4

Manufacture 2 :

Manufacture Number 2 :

M.S.R.P 04/2010 :

Description: BELT TENSIONER MADE IN JAPAN
NOK

Application 1 :

Application 2 :

Application 3 :

Application 4 :

Application 5 :

Application 6 :

Application 7 :

Application 8 :

Application 9 :

Application 10 :

Application 11 :

Application 12 :

ZOOM+ ZOOM-



PARTS IMAGE



BOX IMAGE

13540-46030

BELT TENSIONER MADE IN

Parts Number : 13540-46030

Manufacture 1 : NTN

Manufacturer Number 1 : HAT008-11

Manufacture 2 :

Manufacturer Number 2 :

M.S.R.P 04/2010 :

Description: BELT TENSIONER MADE IN JAPAN

Application 1 :

Application 2 :

Application 3 :

Application 4 :

Application 5 :

Application 6 :

Application 7 :

Application 8 :

Application 9 :

Application 10 :

Application 11 :

Application 12 :

ZOOM+ ZOOM-



PARTS IMAGE



BOX IMAGE

13540-50030

BELT TENSIONER MADE IN

Parts Number : 13540-50030

Manufacture 1 : NTN

Manufacturer Number 1 : HAT009-3

Manufacture 2 :

Manufacturer Number 2 :

M.S.R.P 04/2010 :

Description: BELT TENSIONER MADE IN JAPAN

Application 1 :

Application 2 :

Application 3 :

Application 4 :

Application 5 :

Application 6 :

Application 7 :

Application 8 :

Application 9 :

Application 10 :

Application 11 :

Application 12 :

ZOOM+

ZOOM-



PARTS IMAGE



BOX IMAGE

145-11D06-00

CLUTCH FRICTION PLATE QTY

Parts Number : 145-11D06-00

Manufacture 1 : F.C.C

Manufacturer Number 1 : 22544-P24-N00

Manufacture 2 :

Manufacture Number 2 :

M.S.R.P 04/2010 :

Description: CLUTCH FRICTION PLATE QTY 10
MADE IN JAPAN

Application 1 : ACURA INTEGRA 3D 94 -01

Application 2 : ACURA INTEGRA 4D 94-01

Application 3 : ACURA TL 95-98

Application 4 :

Application 5 :

Application 6 :

Application 7 :

Application 8 :

Application 9 :

Application 10 :

Application 11 :

Application 12 :

ZOOM+ ZOOM-



PARTS IMAGE



BOX IMAGE

145-11D13-00

CLUTCH FRICTION PLATE QTY

Parts Number : 145-11D13-00

Manufacture 1 : F.C.C

Manufacturer Number 1 : 22544-P6H-003

Manufacture 2 :

Manufacture Number 2 :

M.S.R.P 04/2010 :

Description: CLUTCH FRICTION PLATE QTY 10
MADE IN JAPAN

Application 1 : HONDA ACCORD 4D 02

Application 2 : HONDA ACCORD 4D 98-01

Application 3 : HONDA ODYSSEY 95-98

Application 4 : HONA PRELUDE 97-01

Application 5 :

Application 6 :

Application 7 :

Application 8 :

Application 9 :

Application 10 :

Application 11 :

Application 12 :

ZOOM+

ZOOM-

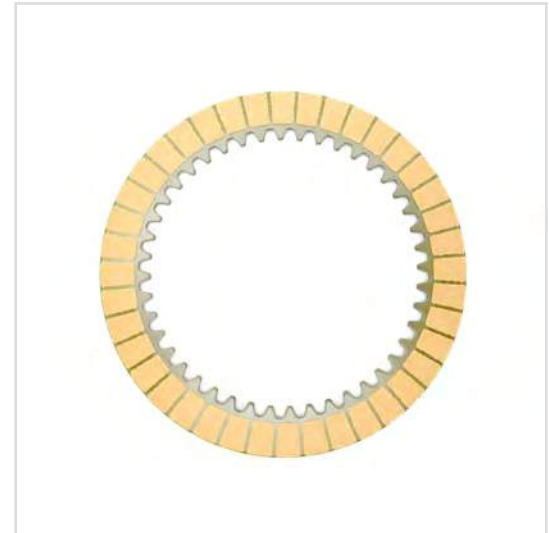

PARTS IMAGE



BOX IMAGE

145-11D14-00

CLUTCH FRICTION PLATE QTY

Parts Number : 145-11D14-00

Manufacture 1 : F.C.C

Manufacturer Number 1 : 22545-P1V-003

Manufacture 2 :

Manufacturer Number 2 :

M.S.R.P 04/2010 :

Description: CLUTCH FRICTION PLATE QTY 10
MADE IN JAPAN

Application 1 : ACURA TL 95-98

Application 2 : ACURA VIGOR 92-94

Application 3 :

Application 4 :

Application 5 :

Application 6 :

Application 7 :

Application 8 :

Application 9 :

Application 10 :

Application 11 :

Application 12 :

ZOOM+

ZOOM-

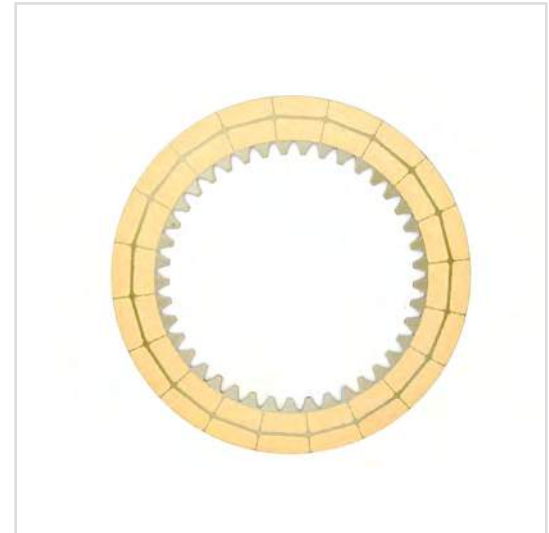

PARTS IMAGE



BOX IMAGE

145-11D18-00

CLUTCH FRICTION PLATE QTY

Parts Number : 145-11D18-00

Manufacture 1 : F.C.C

Manufacturer Number 1 : 22545-P6H-003

Manufacture 2 :

Manufacturer Number 2 :

M.S.R.P 04/2010 :

Description: CLUTCH FRICTION PLATE QTY 10
MADE IN JAPAN

Application 1 : HONDA ACCORD 4D 98-01

Application 2 : HONDA ODYSSEY 95-98

Application 3 : HONDA PRELUDE 97-01

Application 4 :

Application 5 :

Application 6 :

Application 7 :

Application 8 :

Application 9 :

Application 10 :

Application 11 :

Application 12 :

ZOOM+

ZOOM-

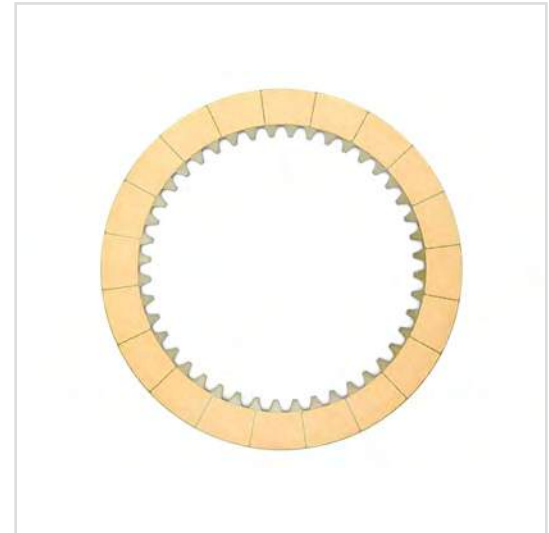

PARTS IMAGE



BOX IMAGE

145-11D21-00

CLUTCH FRICTION PLATE QTY

Parts Number : 145-11D21-00

Manufacture 1 : F.C.C

Manufacturer Number 1 : 22544-PLX-003

Manufacture 2 :

Manufacture Number 2 :

M.S.R.P 04/2010 :

Description: CLUTCH FRICTION PLATE QTY 10
MADE IN JAPAN

Application 1 : HONDA MOTOR CYCLE

Application 2 :

Application 3 :

Application 4 :

Application 5 :

Application 6 :

Application 7 :

Application 8 :

Application 9 :

Application 10 :

Application 11 :

Application 12 :

ZOOM+ ZOOM-



PARTS IMAGE



BOX IMAGE

145-11D22-00

CLUTCH FRICTION PLATE QTY

Parts Number : 145-11D22-00

Manufacture 1 : F.C.C

Manufacturer Number 1 : 22545-RDK-023

Manufacture 2 :

Manufacture Number 2 :

M.S.R.P 04/2010 :

Description: CLUTCH FRICTION PLATE QTY 10
MADE IN JAPAN

Application 1 : ACURA MDX 01-06

Application 2 : HONDA ACCORD HYBRID 05-07

Application 3 :

Application 4 :

Application 5 :

Application 6 :

Application 7 :

Application 8 :

Application 9 :

Application 10 :

Application 11 :

Application 12 :

ZOOM+

ZOOM-

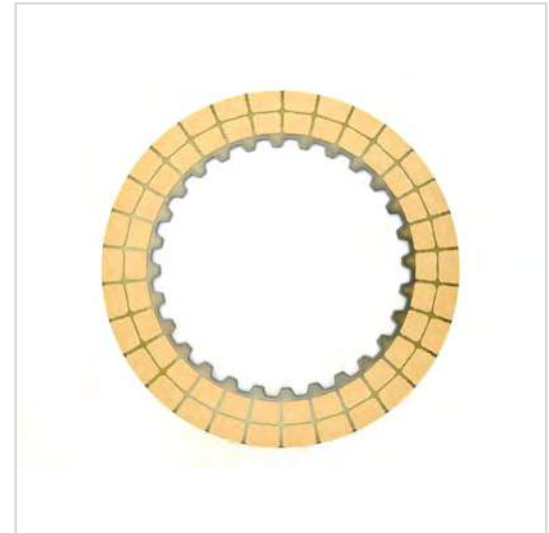

PARTS IMAGE



BOX IMAGE

145-11F14-00

CLUTCH FRICTION PLATE QTY

Parts Number : 145-11F14-00

Manufacture 1 : F.C.C

Manufacturer Number 1 : 22544-P5D-003

Manufacture 2 :

Manufacture Number 2 :

M.S.R.P 04/2010 :

Description: CLUTCH FRICTION PLATE QTY 10
MADE IN JAPAN

Application 1 : ACURA RL 04

Application 2 : ACURA RL 96-03

Application 3 : ACURA TL 95-98

Application 4 :

Application 5 :

Application 6 :

Application 7 :

Application 8 :

Application 9 :

Application 10 :

Application 11 :

Application 12 :

ZOOM+

ZOOM-



PARTS IMAGE



BOX IMAGE

145-11F21-00

CLUTCH FRICTION PLATE QTY

Parts Number : 145-11F21-00

Manufacture 1 : F.C.C

Manufacturer Number 1 : 22674-P0Z-003

Manufacture 2 :

Manufacturer Number 2 :

M.S.R.P 04/2010 :

Description: CLUTCH FRICTION PLATE QTY 10
MADE IN JAPAN

Application 1 : HONDA ACCORD 4D 94-97 E2 / V-6 E2

Application 2 :

Application 3 :

Application 4 :

Application 5 :

Application 6 :

Application 7 :

Application 8 :

Application 9 :

Application 10 :

Application 11 :

Application 12 :

ZOOM+

ZOOM-



PARTS IMAGE



BOX IMAGE

145-11F22-00

CLUTCH FRICTION PLATE QTY

Parts Number : 145-11F22-00

Manufacture 1 : F.C.C

Manufacturer Number 1 : 22344-P5D-003

Manufacture 2 :

Manufacturer Number 2 :

M.S.R.P 04/2010 :

Description: CLUTCH FRICTION PLATE QTY 10
MADE IN JAPAN

Application 1 : ACURA RL 96-03

Application 2 : ACURA TL 95-98

Application 3 :

Application 4 :

Application 5 :

Application 6 :

Application 7 :

Application 8 :

Application 9 :

Application 10 :

Application 11 :

Application 12 :

ZOOM+

ZOOM-

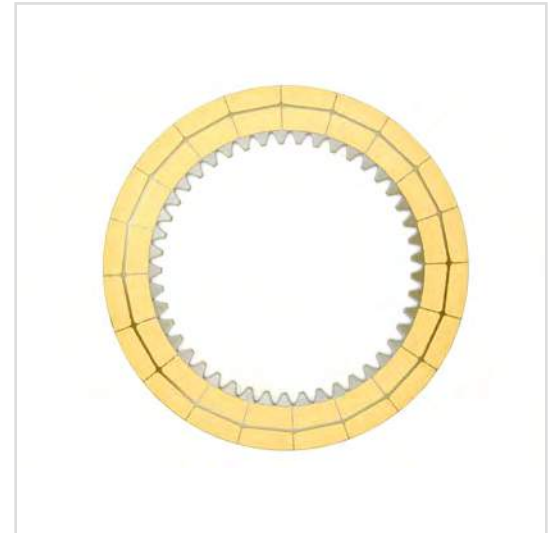

PARTS IMAGE



BOX IMAGE

145-11F23-00

CLUTCH FRICTION PLATE QTY

Parts Number : 145-11F23-00

Manufacture 1 : F.C.C

Manufacturer Number 1 : 22544-PDM-003

Manufacture 2 :

Manufacturer Number 2 :

M.S.R.P 04/2010 :

Description: CLUTCH FRICTION PLATE QTY 10
MADE IN JAPAN

Application 1 : ACURA INTEGRA 3D 94-01

Application 2 : ACURA INTEGRA 4D 94-01

Application 3 :

Application 4 :

Application 5 :

Application 6 :

Application 7 :

Application 8 :

Application 9 :

Application 10 :

Application 11 :

Application 12 :

ZOOM+

ZOOM-

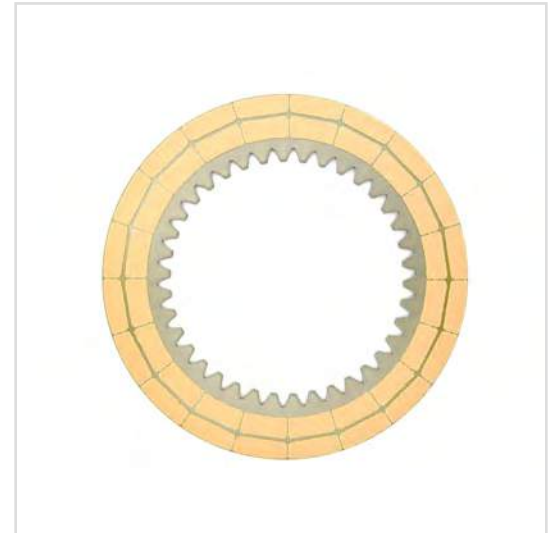

PARTS IMAGE



BOX IMAGE

145-11F24-00

CLUTCH FRICTION PLATE QTY

Parts Number : 145-11F24-00

Manufacture 1 : F.C.C

Manufacturer Number 1 : 22545-P7T-003

Manufacture 2 :

Manufacture Number 2 :

M.S.R.P 04/2010 :

Description: CLUTCH FRICTION PLATE QTY 10
MADE IN JAPAN

Application 1 : ACURA TL 99-03

Application 2 :

Application 3 :

Application 4 :

Application 5 :

Application 6 :

Application 7 :

Application 8 :

Application 9 :

Application 10 :

Application 11 :

Application 12 :

ZOOM+

ZOOM-

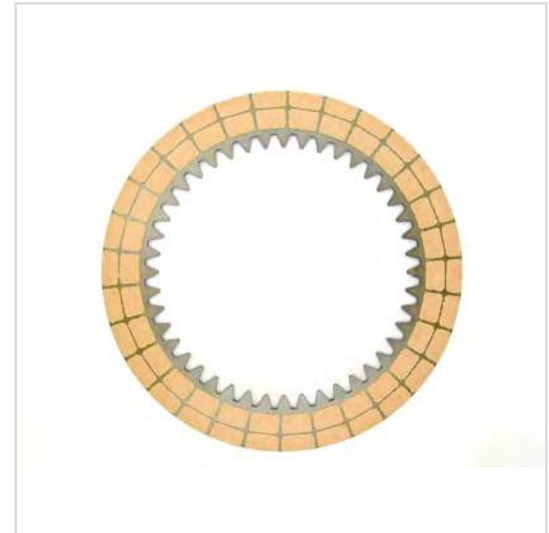

PARTS IMAGE



BOX IMAGE

145-11F25-00

CLUTCH FRICTION PLATE QTY

Parts Number : 145-11F25-00

Manufacture 1 : F.C.C

Manufacturer Number 1 : 22644-P7T-003

Manufacture 2 :

Manufacture Number 2 :

M.S.R.P 04/2010 :

Description: CLUTCH FRICTION PLATE QTY 10
MADE IN JAPAN

Application 1 : ACURA RL 04

Application 2 : ACURA RL 96-03

Application 3 : ACURA TL 95-98

Application 4 :

Application 5 :

Application 6 :

Application 7 :

Application 8 :

Application 9 :

Application 10 :

Application 11 :

Application 12 :

ZOOM+

ZOOM-

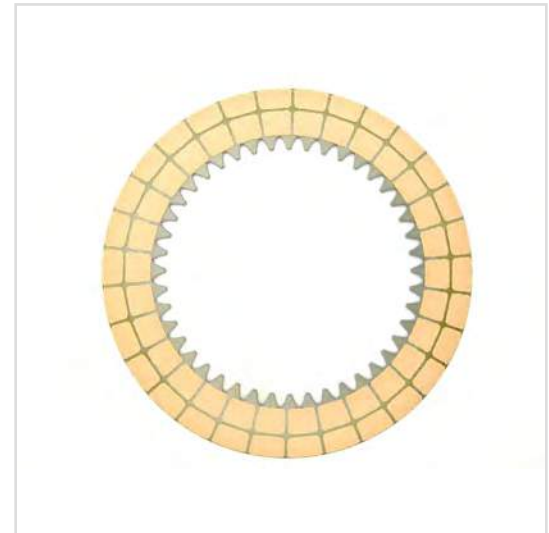

PARTS IMAGE



BOX IMAGE

145-11F29-00

CLUTCH FRICTION PLATE QTY

Parts Number : 145-11F29-00

Manufacture 1 : F.C.C

Manufacturer Number 1 : 22545-PRP-013

Manufacture 2 :

Manufacture Number 2 :

M.S.R.P 04/2010 :

Description: CLUTCH FRICTION PLATE QTY 10
MADE IN JAPAN

Application 1 : ACURA RSX 02-05

Application 2 : ACURA RSX 06

Application 3 : ACURA TSX 04-07

Application 4 : HONDA ACCORD 4D 03-06

Application 5 : HONDA ACCORD COUPE 03-06

Application 6 : HONDA CR-V 02-05

Application 7 : HONDA CR-V 06

Application 8 : HONDA ELEMENT 03-06

Application 9 :

Application 10 :

Application 11 :

Application 12 :

ZOOM+

ZOOM-

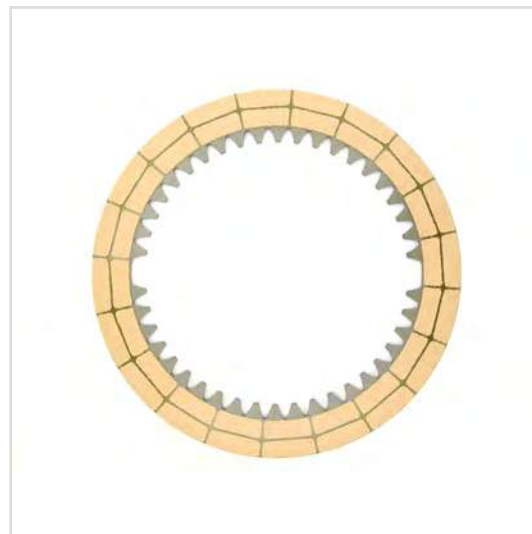

PARTS IMAGE



BOX IMAGE

145-11F33-01

CLUTCH FRICTION PLATE QTY

Parts Number : 145-11F33-01

Manufacture 1 : F.C.C

Manufacturer Number 1 : 22644-P7W-013

Manufacture 2 :

Manufacturer Number 2 :

M.S.R.P 04/2010 :

Description: CLUTCH FRICTION PLATE QTY 10
MADE IN JAPAN

Application 1 : HONDA ACCORD 4D 03-06

Application 2 : HONDA ACCORD COUPE 03-06

Application 3 : ACURA CL 01-03

Application 4 : ACURA TL 99-03

Application 5 :

Application 6 :

Application 7 :

Application 8 :

Application 9 :

Application 10 :

Application 11 :

Application 12 :

ZOOM+

ZOOM-

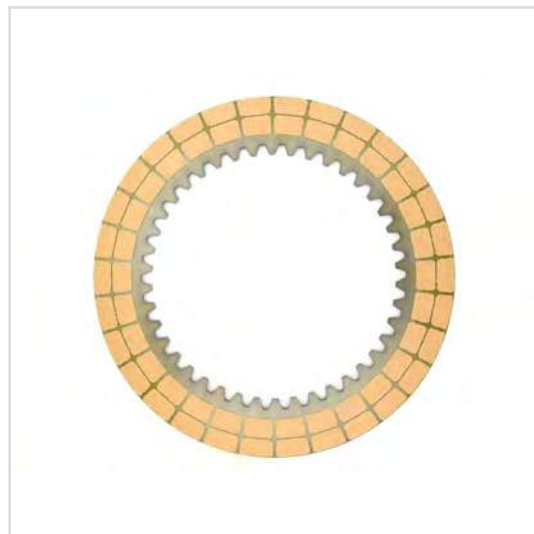

PARTS IMAGE



BOX IMAGE

145-11F34-00

CLUTCH FRICTION PLATE QTY

Parts Number : 145-11F34-00

Manufacture 1 : F.C.C

Manufacturer Number 1 : 22644-PGH-003

Manufacture 2 :

Manufacturer Number 2 :

M.S.R.P 04/2010 :

Description: CLUTCH FRICTION PLATE QTY 10
MADE IN JAPAN

Application 1 : HONDA PILOT 03-04 BGVA

Application 2 : ACURA

Application 3 :

Application 4 :

Application 5 :

Application 6 :

Application 7 :

Application 8 :

Application 9 :

Application 10 :

Application 11 :

Application 12 :

ZOOM+

ZOOM-

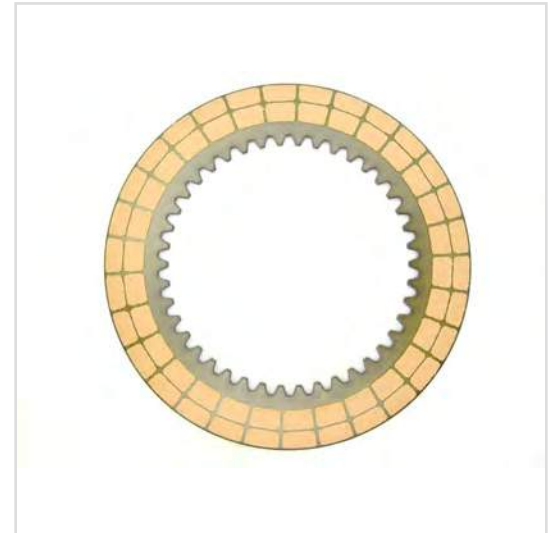

PARTS IMAGE



BOX IMAGE

145-11F44-00

CLUTCH FRICTION PLATE QTY

Parts Number : 145-11F44-00

Manufacture 1 : F.C.C

Manufacturer Number 1 : 22644-RDK-003

Manufacture 2 :

Manufacture Number 2 :

M.S.R.P 04/2010 :

Description: CLUTCH FRICTION PLATE QTY 10
MADE IN JAPAN

Application 1 : ACURA MDX 01-06

Application 2 :

Application 3 :

Application 4 :

Application 5 :

Application 6 :

Application 7 :

Application 8 :

Application 9 :

Application 10 :

Application 11 :

Application 12 :

ZOOM+

ZOOM-

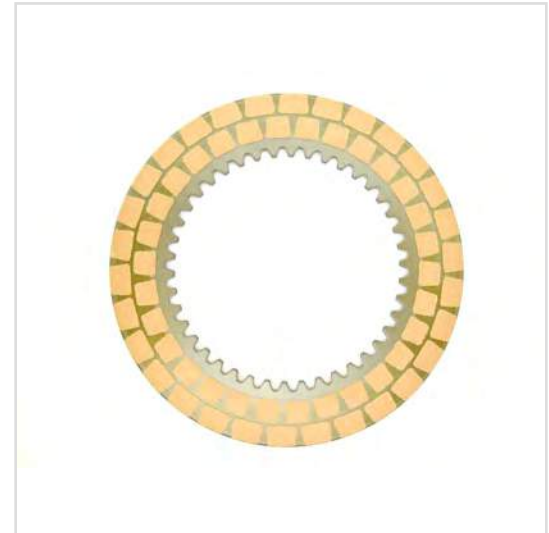

PARTS IMAGE



BOX IMAGE

145-11H01-00

CLUTCH FRICTION PLATE QTY

Parts Number : 145-11H01-00

Manufacture 1 : F.C.C

Manufacturer Number 1 : 22645-RDK-003

Manufacture 2 :

Manufacture Number 2 :

M.S.R.P 04/2010 :

Description: CLUTCH FRICTION PLATE QTY 10
MADE IN JAPAN

Application 1 : ACURA MDX 01-06

Application 2 :

Application 3 :

Application 4 :

Application 5 :

Application 6 :

Application 7 :

Application 8 :

Application 9 :

Application 10 :

Application 11 :

Application 12 :

ZOOM+

ZOOM-

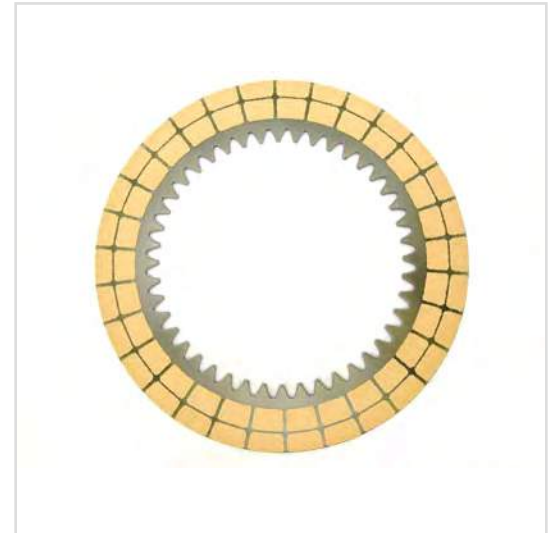

PARTS IMAGE



BOX IMAGE

145-11H31-00

CLUTCH FRICTION PLATE QTY

Parts Number : 145-11H31-00

Manufacture 1 : F.C.C

Manufacturer Number 1 : 22544-P7W-003

Manufacture 2 :

Manufacture Number 2 :

M.S.R.P 04/2010 :

Description: CLUTCH FRICTION PLATE QTY 10
MADE IN JAPAN

Application 1 : ACURA CL 01-03

Application 2 : ACURA MDX 01-06

Application 3 : ACURA TL 04-07

Application 4 : ACURA TL 99-03

Application 5 :

Application 6 :

Application 7 :

Application 8 :

Application 9 :

Application 10 :

Application 11 :

Application 12 :

ZOOM+

ZOOM-

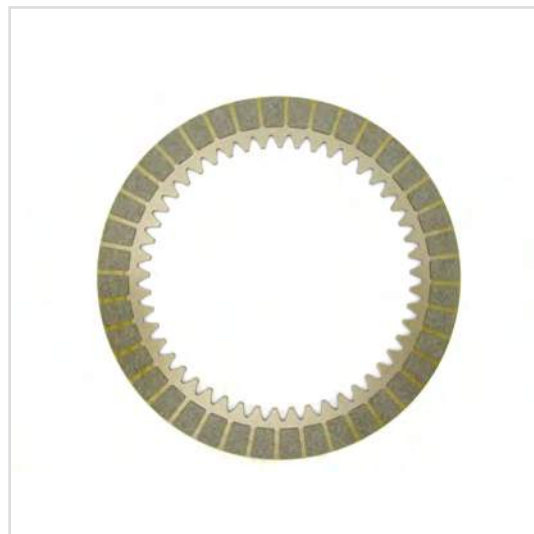

PARTS IMAGE



BOX IMAGE

14510-657-013

BELT TENSIONER

Parts Number : 14510-657-013

Manufacture 1 : NTN

Manufacturer Number 1 : X-JPU60-2+JF34

Manufacture 2 :

Manufacturer Number 2 :

M.S.R.P 04/2010 :

Description: BELT TENSIONER

Application 1 :

Application 2 :

Application 3 :

Application 4 :

Application 5 :

Application 6 :

Application 7 :

Application 8 :

Application 9 :

Application 10 :

Application 11 :

Application 12 :

ZOOM+

ZOOM-



PARTS IMAGE

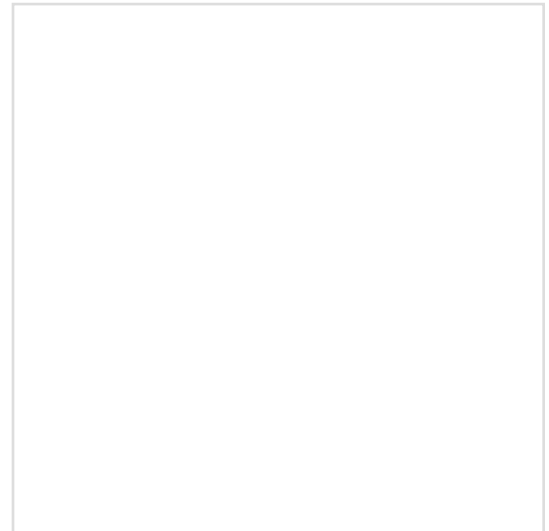

BOX IMAGE

14510-P08-004

Parts Number : 14510-P08-004

Manufacture 1 : NSK

Manufacturer Number 1 : 52TB0539B01

Manufacture 2 :

Manufacturer Number 2 :

M.S.R.P 04/2010 :

Description: BELT TENSIONER MADE IN JAPAN

Application 1 :

Application 2 :

Application 3 :

Application 4 :

Application 5 :

Application 6 :

Application 7 :

Application 8 :

Application 9 :

Application 10 :

Application 11 :

Application 12 :

BELT TENSIONER MADE IN

ZOOM+

ZOOM-



PARTS IMAGE



BOX IMAGE

14510-P0G-A01

Parts Number : 14510-P0G-A01

Manufacture 1 : KOYO

Manufacturer Number 1 : PU246529ARR9DYS02

Manufacture 2 :

Manufacturer Number 2 :

M.S.R.P 04/2010 :

Description: BELT TENSIONER MADE IN JAPAN

Application 1 :

Application 2 :

Application 3 :

Application 4 :

Application 5 :

Application 6 :

Application 7 :

Application 8 :

Application 9 :

Application 10 :

Application 11 :

Application 12 :

BELT TENSIONER MADE IN

ZOOM+

ZOOM-



PARTS IMAGE



BOX IMAGE

14510-P13-003

BELT TENSIONER MADE IN

Parts Number : 14510-P13-003

Manufacture 1 : KOYO

Manufacturer Number 1 : 6LAT1001C / LAT1001F

Manufacture 2 :

Manufacturer Number 2 :

M.S.R.P 04/2010 :

Description: BELT TENSIONER MADE IN JAPAN

Application 1 :

Application 2 :

Application 3 :

Application 4 :

Application 5 :

Application 6 :

Application 7 :

Application 8 :

Application 9 :

Application 10 :

Application 11 :

Application 12 :

ZOOM+

ZOOM-



PARTS IMAGE



BOX IMAGE

14510-P30-003

BELT TENSIONER MADE IN

Parts Number : 14510-P30-003

Manufacture 1 : KOYO

Manufacturer Number 1 : PU285530RR1DV1

Manufacture 2 :

Manufacturer Number 2 :

M.S.R.P 04/2010 :

Description: BELT TENSIONER MADE IN JAPAN

Application 1 :

Application 2 :

Application 3 :

Application 4 :

Application 5 :

Application 6 :

Application 7 :

Application 8 :

Application 9 :

Application 10 :

Application 11 :

Application 12 :

ZOOM+ ZOOM-



PARTS IMAGE



BOX IMAGE

14510-P5A-003

Parts Number : 14510-P5A-003

Manufacture 1 : KOYO

Manufacturer Number 1 : PU275531ERR1F

Manufacture 2 :

Manufacture Number 2 :

M.S.R.P 04/2010 :

Description: BELT TENSIONER MADE IN JAPAN

Application 1 :

Application 2 :

Application 3 :

Application 4 :

Application 5 :

Application 6 :

Application 7 :

Application 8 :

Application 9 :

Application 10 :

Application 11 :

Application 12 :

BELT TENSIONER MADE IN

ZOOM+ ZOOM-



PARTS IMAGE



BOX IMAGE

14510-P70-004

BELT TENSIONER MADE IN

Parts Number : 14510-P70-004

Manufacture 1 : KOYO

Manufacturer Number 1 : PU326231GRR1DV

Manufacture 2 :

Manufacture Number 2 :

M.S.R.P 04/2010 :

Description: BELT TENSIONER MADE IN JAPAN

Application 1 :

Application 2 :

Application 3 :

Application 4 :

Application 5 :

Application 6 :

Application 7 :

Application 8 :

Application 9 :

Application 10 :

Application 11 :

Application 12 :

ZOOM+

ZOOM-



PARTS IMAGE



BOX IMAGE

14510-P8A-A01

Parts Number : 14510-P8A-A01

Manufacture 1 : KOYO

Manufacturer Number 1 : LAT1027L

Manufacture 2 :

Manufacture Number 2 : 14510-PGE-A01

M.S.R.P 04/2010 :

Description: BLET TENSIONER MADE IN JAPAN

Application 1 : 14510-PGE-A01

Application 2 :

Application 3 :

Application 4 :

Application 5 :

Application 6 :

Application 7 :

Application 8 :

Application 9 :

Application 10 :

Application 11 :

Application 12 :

BLET TENSIONER MADE IN

ZOOM+

ZOOM-



PARTS IMAGE



BOX IMAGE

14510-PC1-003

Parts Number : 14510-PC1-003
Manufacture 1 : NTN
Manufacturer Number 1 : X-JPU60-20 + JF190
Manufacture 2 :
Manufacturer Number 2 :
M.S.R.P 04/2010 :
Description: BELT TENSIONER MADE IN JAPAN

BELT TENSIONER MADE IN

ZOOM+ ZOOM-



PARTS IMAGE

- Application 1 :
- Application 2 :
- Application 3 :
- Application 4 :
- Application 5 :
- Application 6 :
- Application 7 :
- Application 8 :
- Application 9 :
- Application 10 :
- Application 11 :
- Application 12 :



BOX IMAGE

14510-PC6-013

BELT TENSIONER

Parts Number : 14510-PC6-013

Manufacture 1 : KOYO

Manufacturer Number 1 : DG30552RD1DCS28+V2

Manufacture 2 :

Manufacturer Number 2 :

M.S.R.P 04/2010 :

Description: BELT TENSIONER

Application 1 :

Application 2 :

Application 3 :

Application 4 :

Application 5 :

Application 6 :

Application 7 :

Application 8 :

Application 9 :

Application 10 :

Application 11 :

Application 12 :

ZOOM+

ZOOM-



PARTS IMAGE

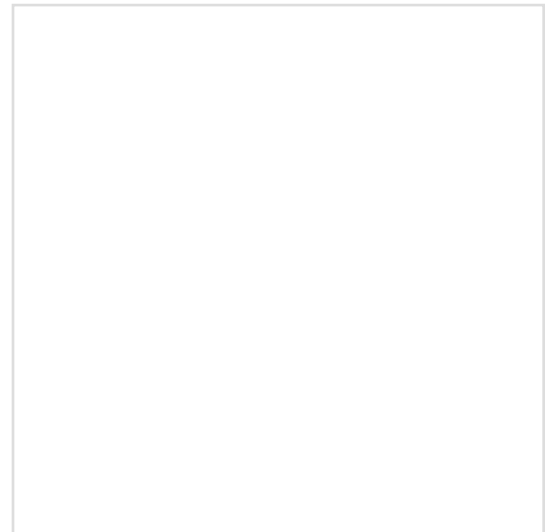

BOX IMAGE

14510-PE0-005

BELT TENSIONER MADE IN

Parts Number : 14510-PE0-005

Manufacture 1 : NSK

Manufacturer Number 1 : 55TB052B01

Manufacture 2 : KOYO

Manufacture Number 2 : DG30552RD1DCS28+V1

M.S.R.P 04/2010 :

Description: BELT TENSIONER MADE IN JAPAN

Application 1 :

Application 2 :

Application 3 :

Application 4 :

Application 5 :

Application 6 :

Application 7 :

Application 8 :

Application 9 :

Application 10 :

Application 11 :

Application 12 :

ZOOM+ ZOOM-



PARTS IMAGE



BOX IMAGE

14510-PG6-013

BELT TENSIONER

Parts Number : 14510-PG6-013

Manufacture 1 : KOYO

Manufacturer Number 1 : DG3060B2RKD1CS28+SV1

Manufacture 2 :

Manufacture Number 2 :

M.S.R.P 04/2010 :

Description: BELT TENSIONER

Application 1 :

Application 2 :

Application 3 :

Application 4 :

Application 5 :

Application 6 :

Application 7 :

Application 8 :

Application 9 :

Application 10 :

Application 11 :

Application 12 :

ZOOM+

ZOOM-

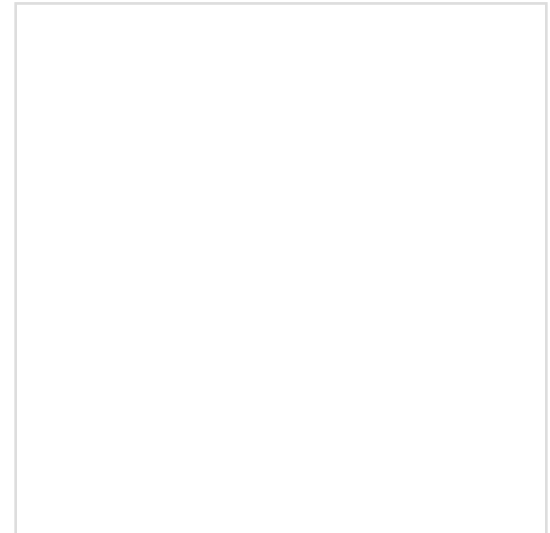

PARTS IMAGE

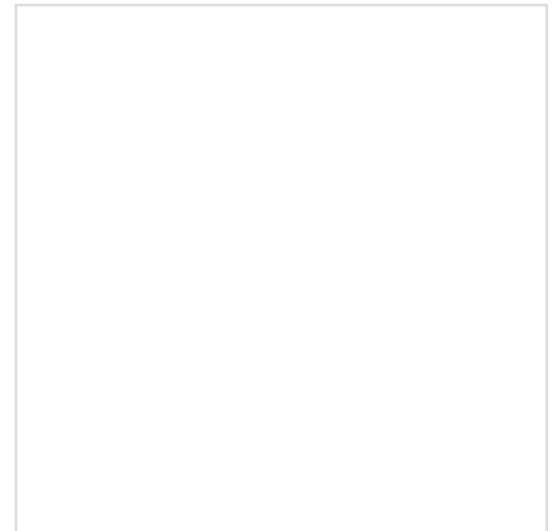

BOX IMAGE

14510-PH1-004

Parts Number : 14510-PH1-004

Manufacture 1 : NSK

Manufacturer Number 1 : 55TB067B02A

Manufacture 2 : KOYO

Manufacture Number 2 : DG30552RD1DCS28+SV

M.S.R.P 04/2010 :

Description: BELT TENSIONER MADE IN JAPAN

Application 1 :

Application 2 :

Application 3 :

Application 4 :

Application 5 :

Application 6 :

Application 7 :

Application 8 :

Application 9 :

Application 10 :

Application 11 :

Application 12 :

BELT TENSIONER MADE IN

ZOOM+

ZOOM-



PARTS IMAGE



BOX IMAGE

14510-PH3-003

BELT TENSIONER

Parts Number : 14510-PH3-003

Manufacture 1 : KOYO

Manufacturer Number 1 : DG30552RD1DCS28+SV1

Manufacture 2 :

Manufacturer Number 2 :

M.S.R.P 04/2010 :

Description: BELT TENSIONER

Application 1 :

Application 2 :

Application 3 :

Application 4 :

Application 5 :

Application 6 :

Application 7 :

Application 8 :

Application 9 :

Application 10 :

Application 11 :

Application 12 :

ZOOM+

ZOOM-

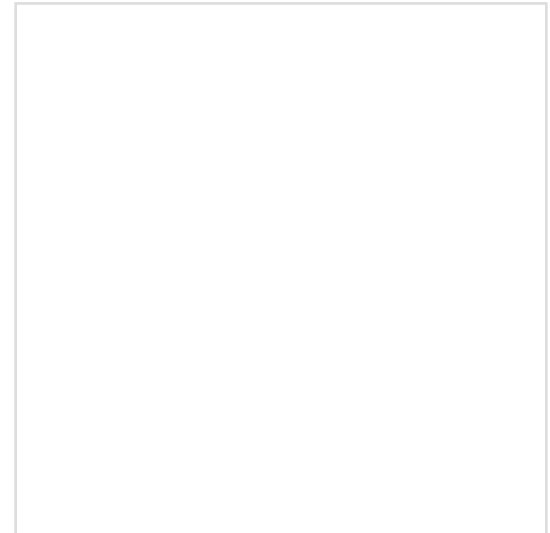

PARTS IMAGE

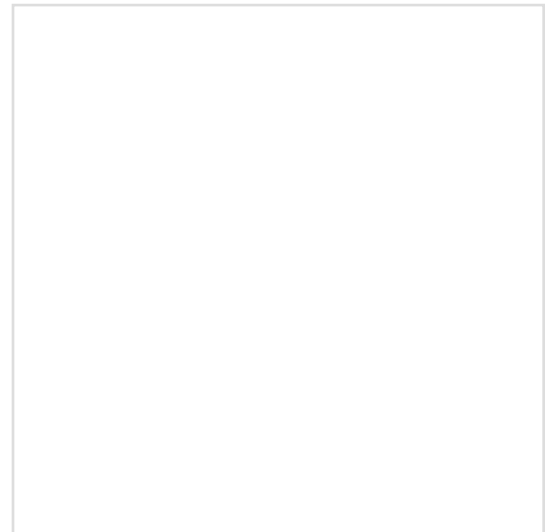

BOX IMAGE

14510-PH7-003

BELT TENSIONER

Parts Number : 14510-PH7-003

Manufacture 1 : KOYO

Manufacturer Number 1 : DG3265A2RD1DCS39

Manufacture 2 :

Manufacturer Number 2 :

M.S.R.P 04/2010 :

Description: BELT TENSIONER

Application 1 :

Application 2 :

Application 3 :

Application 4 :

Application 5 :

Application 6 :

Application 7 :

Application 8 :

Application 9 :

Application 10 :

Application 11 :

Application 12 :

ZOOM+

ZOOM-



PARTS IMAGE

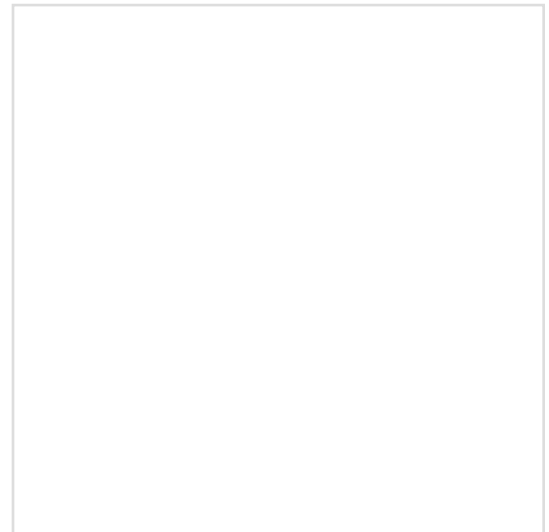

BOX IMAGE

14510-PLC-335

Parts Number : 14510-PLC-335

Manufacture 1 : NSK

Manufacturer Number 1 : 55ATB0723A02B03

Manufacture 2 :

Manufacture Number 2 :

M.S.R.P 04/2010 :

Description: BELT TENSIONER MADE IN JAPAN

Application 1 :

Application 2 :

Application 3 :

Application 4 :

Application 5 :

Application 6 :

Application 7 :

Application 8 :

Application 9 :

Application 10 :

Application 11 :

Application 12 :

BELT TENSIONER MADE IN

ZOOM+

ZOOM-



PARTS IMAGE



BOX IMAGE

14510-PM7-004

Parts Number : 14510-PM7-004

Manufacture 1 : NSK

Manufacturer Number 1 : 56TB0602B02

Manufacture 2 :

Manufacturer Number 2 :

M.S.R.P 04/2010 :

Description: BELT TENSIONER MADE IN JAPAN

Application 1 :

Application 2 :

Application 3 :

Application 4 :

Application 5 :

Application 6 :

Application 7 :

Application 8 :

Application 9 :

Application 10 :

Application 11 :

Application 12 :

BELT TENSIONER MADE IN

ZOOM+

ZOOM-



PARTS IMAGE



BOX IMAGE

14510-PR7-A01

Parts Number : 14510-PR7-A01

Manufacture 1 : KOYO

Manufacturer Number 1 : PU246529RR9FYS02

Manufacture 2 :

Manufacturer Number 2 :

M.S.R.P 04/2010 :

Description: BELT TENSIONER MADE IN JAPAN

BELT TENSIONER MADE IN

ZOOM+

ZOOM-



PARTS IMAGE

Application 1 :

Application 2 :

Application 3 :

Application 4 :

Application 5 :

Application 6 :

Application 7 :

Application 8 :

Application 9 :

Application 10 :

Application 11 :

Application 12 :

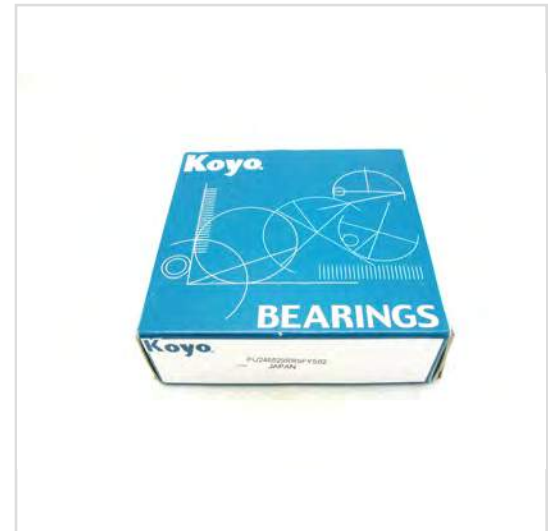

BOX IMAGE

14510-PT0-004

Parts Number : 14510-PT0-004

Manufacture 1 : KOYO

Manufacturer Number 1 : PU32623IGRRID

Manufacture 2 :

Manufacturer Number 2 :

M.S.R.P 04/2010 : \$76.68

Description: BELT TENSIONER ADJ T/B
MADE IN JAPAN #G

BELT TENSIONER ADJ T/B

ZOOM+

ZOOM-



PARTS IMAGE

- Application 1 :** HONDA ACCORD 2D 90-93
- Application 2 :** HONDA ACCORD 2D 94-97
- Application 3 :** HONDA ACCORD 2D 98-02
- Application 4 :** HONDA ACCORD 4D 90-93
- Application 5 :** HONDA ACCORD 4D 94-97 E2/V-6E2
- Application 6 :** HONDA ACCORD 4D 98-01
- Application 7 :** HONDA ACCORD WAGON 91-97
- Application 8 :** HONDA ACCORD ODYSSEY 95-98
- Application 9 :** HONDA PRELUDE 92-96
- Application 10 :** ACURA CL 2.2L & 2.3L 97-99
- Application 11 :**
- Application 12 :**



BOX IMAGE

14510-PT0-004

Parts Number : 14510-PT0-004

Manufacture 1 : NSK

Manufacturer Number 1 : 62TB0710B01

Manufacture 2 : KOYO

Manufacturer Number 2 : PU326231GRR1DV

M.S.R.P 04/2010 :

Description: BELT TENSIONER MADE IN JAPAN

BELT TENSIONER MADE IN

ZOOM+

ZOOM-



PARTS IMAGE

Application 1 :

Application 2 :

Application 3 :

Application 4 :

Application 5 :

Application 6 :

Application 7 :

Application 8 :

Application 9 :

Application 10 :

Application 11 :

Application 12 :



BOX IMAGE

14510-PV0-003

BELT TENSIONER

Parts Number : 14510-PV0-003

Manufacture 1 : KOYO

Manufacturer Number 1 : PU285529RR1DV1

Manufacture 2 :

Manufacture Number 2 :

M.S.R.P 04/2010 :

Description: BELT TENSIONER

Application 1 :

Application 2 :

Application 3 :

Application 4 :

Application 5 :

Application 6 :

Application 7 :

Application 8 :

Application 9 :

Application 10 :

Application 11 :

Application 12 :

ZOOM+

ZOOM-



PARTS IMAGE

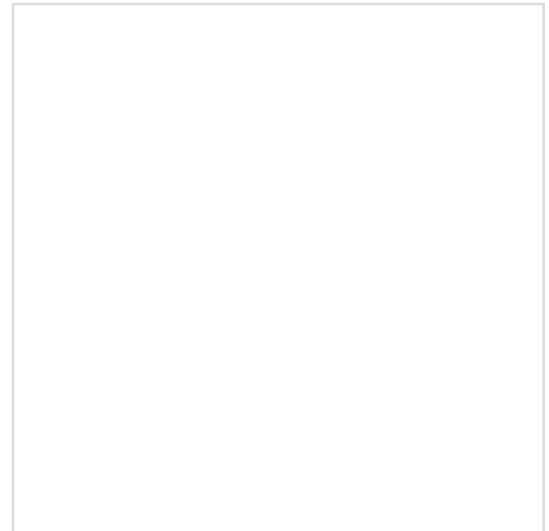

BOX IMAGE

14510-PY3-003

BELT TENSIONER

Parts Number : 14510-PY3-003

Manufacture 1 : KOYO

Manufacturer Number 1 : PU275531CRR1FVS12

Manufacture 2 :

Manufacture Number 2 :

M.S.R.P 04/2010 :

Description: BELT TENSIONER

Application 1 :

Application 2 :

Application 3 :

Application 4 :

Application 5 :

Application 6 :

Application 7 :

Application 8 :

Application 9 :

Application 10 :

Application 11 :

Application 12 :

ZOOM+

ZOOM-

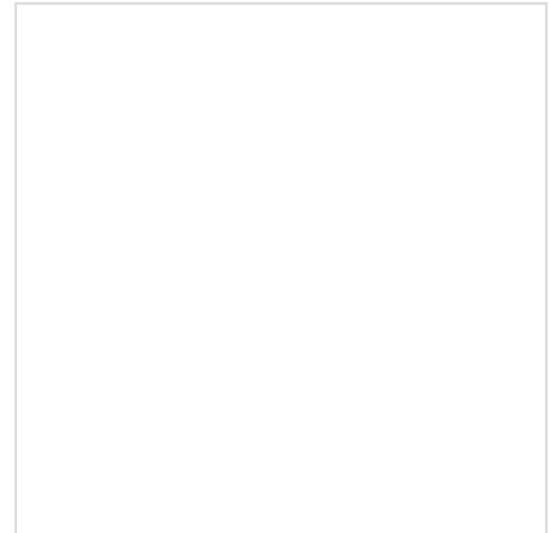

PARTS IMAGE

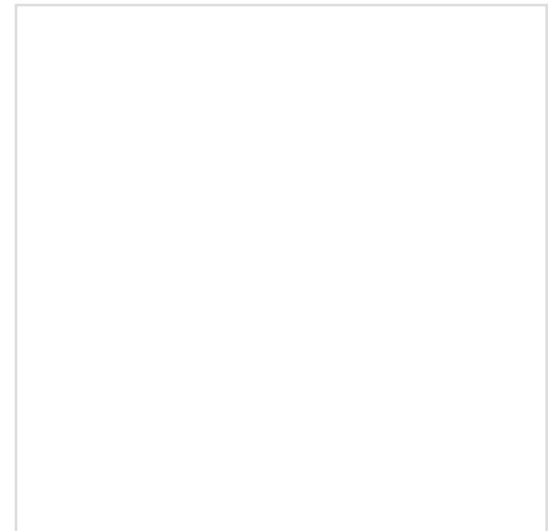

BOX IMAGE

14510-RCA-A01

Parts Number : 14510-RCA-A01

Manufacture 1 : KOYO

Manufacturer Number 1 : LAT1033A

Manufacture 2 :

Manufacturer Number 2 :

M.S.R.P 04/2010 :

Description: BELT TENSIONER MADE IN JAPAN

Application 1 :

Application 2 :

Application 3 :

Application 4 :

Application 5 :

Application 6 :

Application 7 :

Application 8 :

Application 9 :

Application 10 :

Application 11 :

Application 12 :

BELT TENSIONER MADE IN

ZOOM+

ZOOM-



PARTS IMAGE



BOX IMAGE

14516-PLC-000

BELT TENSIONER SPRING

Parts Number : 14516-PLC-000

Manufacture 1 :

Manufacturer Number 1 :

Manufacture 2 :

Manufacturer Number 2 :

M.S.R.P 04/2010 :

Description: BELT TENSIONER SPRING MADE IN JAPAN

Application 1 :

Application 2 :

Application 3 :

Application 4 :

Application 5 :

Application 6 :

Application 7 :

Application 8 :

Application 9 :

Application 10 :

Application 11 :

Application 12 :

ZOOM+

ZOOM-



PARTS IMAGE

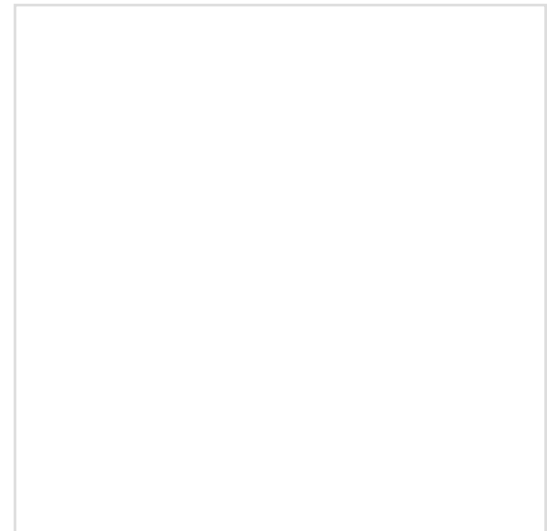

BOX IMAGE

14520-PLC-335

Parts Number : 14520-PLC-335

Manufacture 1 : KOYO

Manufacturer Number 1 : 55ATB0723A02B03

Manufacture 2 : HONDA

Manufacture Number 2 : 14516-PLC-000

M.S.R.P 04/2010 :

Description: BELT TENSIONER WITH SPRING
MADE IN JAPAN

Application 1 :

Application 2 :

Application 3 :

Application 4 :

Application 5 :

Application 6 :

Application 7 :

Application 8 :

Application 9 :

Application 10 :

Application 11 :

Application 12 :

BELT TENSIONER WITH

ZOOM+

ZOOM-



PARTS IMAGE



BOX IMAGE

14550-PGE-A01

Parts Number : 14550-PGE-A01

Manufacture 1 : KOYO

Manufacturer Number 1 : PU285524ARR1D

Manufacture 2 :

Manufacture Number 2 :

M.S.R.P 04/2010 :

Description: BELT TENSIONER MADE IN JAPAN

Application 1 :

Application 2 :

Application 3 :

Application 4 :

Application 5 :

Application 6 :

Application 7 :

Application 8 :

Application 9 :

Application 10 :

Application 11 :

Application 12 :

BELT TENSIONER MADE IN

ZOOM+

ZOOM-



PARTS IMAGE



BOX IMAGE

14550-RCA-A01

Parts Number : 14550-RCA-A01

Manufacture 1 : KOYO

Manufacturer Number 1 : PU315521RR1D

Manufacture 2 :

Manufacturer Number 2 :

M.S.R.P 04/2010 :

Description: BELT TENSIONER MADE IN JAPAN

Application 1 :

Application 2 :

Application 3 :

Application 4 :

Application 5 :

Application 6 :

Application 7 :

Application 8 :

Application 9 :

Application 10 :

Application 11 :

Application 12 :

BELT TENSIONER MADE IN

ZOOM+

ZOOM-



PARTS IMAGE



BOX IMAGE

150-11V19-01

CLUTCH COVER FCC MADE IN

Parts Number : 150-11V19-01

Manufacture 1 : F.C.C

Manufacturer Number 1 : 22300-PCX-015

Manufacture 2 :

Manufacturer Number 2 :

M.S.R.P 04/2010 :

Description: CLUTCH COVER FCC MADE IN JAPAN

Application 1 :

Application 2 :

Application 3 :

Application 4 :

Application 5 :

Application 6 :

Application 7 :

Application 8 :

Application 9 :

Application 10 :

Application 11 :

Application 12 :

ZOOM+

ZOOM-



PARTS IMAGE



BOX IMAGE

16022-P2A-J01

IDELE SPEED CONTROL

Parts Number : 16022-P2A-J01

Manufacture 1 : DENSO

Manufacturer Number 1 : 136800-0521

Manufacture 2 :

Manufacture Number 2 :

M.S.R.P 04/2010 : \$254.70

Description: IDELE SPEED CONTROL
MADE IN JAPAN #G

Application 1 : HONDA CIVIC 2D 96-00

Application 2 : HONDA CIVIC 3D 96-00

Application 3 : HONDA CIVIC 4D 96-07(US) 96-00 EXP

Application 4 : HONDA CIVIC 4D 98-00

Application 5 : HONDA CIVIC DEL SOL 93-97

Application 6 :

Application 7 :

Application 8 :

Application 9 :

Application 10 :

Application 11 :

Application 12 :

ZOOM+

ZOOM-



PARTS IMAGE

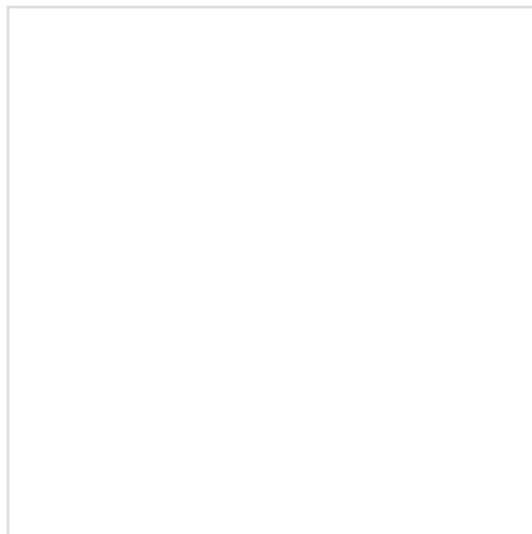

BOX IMAGE

16022-P2E-A51

Parts Number : 16022-P2E-A51

Manufacture 1 : DENSO

Manufacturer Number 1 : 136800-0541

Manufacture 2 :

Manufacture Number 2 :

M.S.R.P 04/2010 : \$332.68

Description: IDLE SPEED CONTROL
MADE IN JAPAN #G

Application 1 : HONDA CIVIC 2D 96-00

Application 2 : HONDA CIVIC 3D 96-00

Application 3 : HONDA CIVIC 4D 96-97(US) 96-00(EXP)

Application 4 : HONDA CIVIC 4D 98-00

Application 5 : HONDA CIVIC DEL SOL 93-97

Application 6 :

Application 7 :

Application 8 :

Application 9 :

Application 10 :

Application 11 :

Application 12 :

IDLE SPEED CONTROL

ZOOM+

ZOOM-



PARTS IMAGE

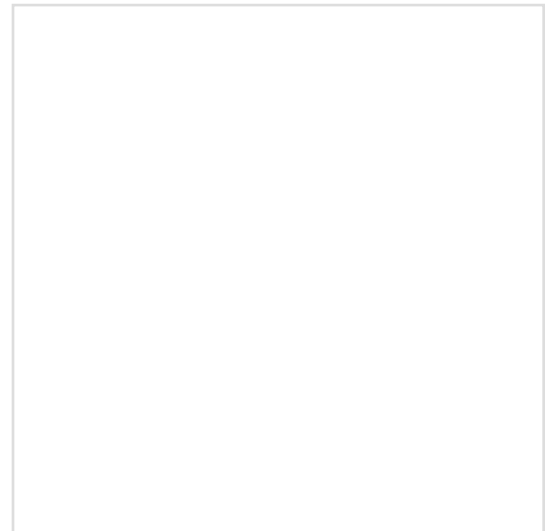

BOX IMAGE

16022-P8A-A03

Parts Number : 16022-P8A-A03

Manufacture 1 : DENSO

Manufacturer Number 1 : 136800-1013

Manufacture 2 :

Manufacturer Number 2 :

M.S.R.P 04/2010 : \$184.20

Description: IDLE SPEED CONTROL
MADE IN JAPAN #G

Application 1 : HONDA ACCORD 2D 98-02

Application 2 : HONDA ACCORD 4D O2

Application 3 : HONDA ACCORD 4D 98-01

Application 4 : HONDA ODYSSEY 99-04

Application 5 : HONDA PILOT 03-07

Application 6 : ACURA TL 3.2L 99-03

Application 7 : ACURA CL 3.0L 97-99

Application 8 : ACURA MDX 01-02

Application 9 :

Application 10 :

Application 11 :

Application 12 :

IDLE SPEED CONTROL

ZOOM+

ZOOM-



PARTS IMAGE

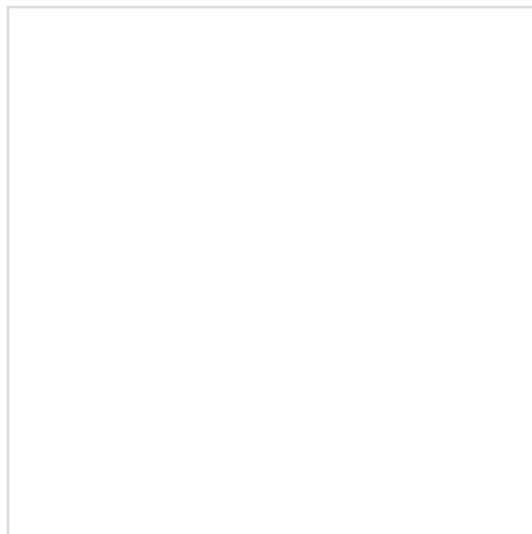

BOX IMAGE

16022-PRB-A02

EGR VALVE

Parts Number : 16022-PRB-A02

Manufacture 1 : DENSO

Manufacturer Number 1 : 136800-1782

Manufacture 2 :

Manufacture Number 2 :

M.S.R.P 04/2010 : \$241.60

Description: EGR VALVE
MADE IN JAPAN #G

Application 1 : HONDA CIVIC 3D 02-05

Application 2 : ACURA RSX TYP S 02-06

Application 3 :

Application 4 :

Application 5 :

Application 6 :

Application 7 :

Application 8 :

Application 9 :

Application 10 :

Application 11 :

Application 12 :

ZOOM+

ZOOM-



PARTS IMAGE

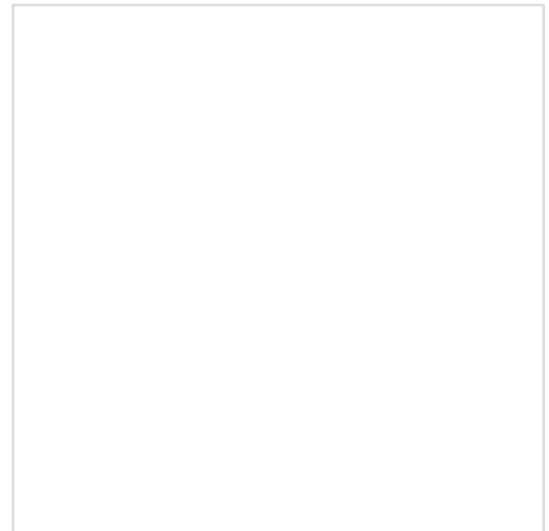

BOX IMAGE

16500-P0A-A51

SOLENOID FAST IDLE

Parts Number : 16500-P0A-A51

Manufacture 1 :

Manufacturer Number 1 : AF42D90909

Manufacture 2 :

Manufacturer Number 2 :

M.S.R.P 04/2010 : \$148.25

Description: SOLENOID FAST IDLE
MADE IN JAPAN #G

- Application 1 :** HONDA ACCORD 2D 94-97
- Application 2 :** HONDA ACCORD 4D 94-97 E2/V6 E2
- Application 3 :** HONDA ACCORD WAGON 94-97
- Application 4 :** ODYSSEY 95-98
- Application 5 :** PRELUDE 97-01
- Application 6 :** ACURA CL 2.2L AT 1997
- Application 7 :** ACURA INTEGRA AT 1994
- Application 8 :**
- Application 9 :**
- Application 10 :**
- Application 11 :**
- Application 12 :**

ZOOM+ ZOOM-



PARTS IMAGE

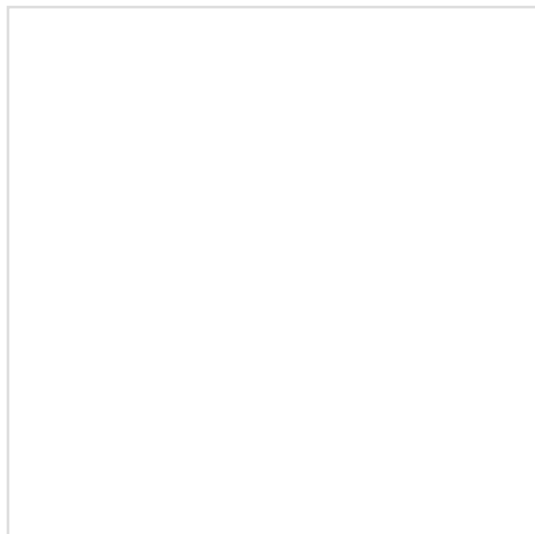

BOX IMAGE

16500-PT2-900

SOLENOID FAST IDLE

Parts Number : 16500-PT2-900

Manufacture 1 :

Manufacturer Number 1 : AF15A90518

Manufacture 2 :

Manufacture Number 2 :

M.S.R.P 04/2010 : \$85.50

Description: SOLENOID FAST IDLE
MADE IN JAPAN #G

Application 1 : HONDA ACCORD 2D 90-93

Application 2 : HONDA ACCORD 4D 90-93

Application 3 : HONDA ACCORD WAGON 91-93

Application 4 : HONDA PRELUDE 92-96

Application 5 :

Application 6 :

Application 7 :

Application 8 :

Application 9 :

Application 10 :

Application 11 :

Application 12 :

ZOOM+ ZOOM-



PARTS IMAGE

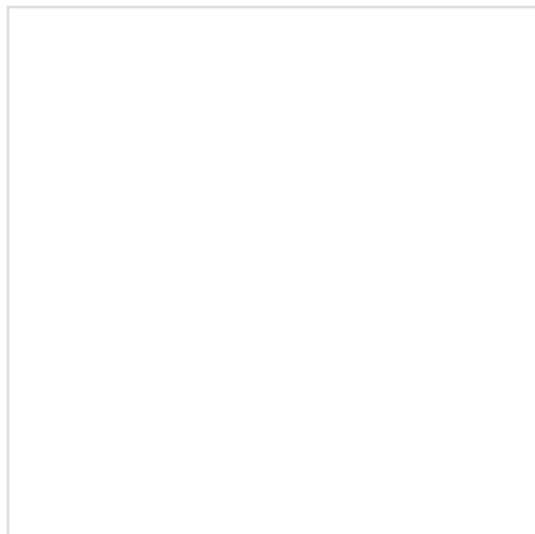

BOX IMAGE

18011-P0A-A00

EGR VALVE

Parts Number : 18011-P0A-A00

Manufacture 1 : KEIHIN

Manufacturer Number 1 :

Manufacture 2 :

Manufacturer Number 2 :

M.S.R.P 04/2010 : \$225.32

Description: EGR VALVE
MADE IN JAPAN #G

Application 1 : HONDA ACCORD 2D 94-97

Application 2 : HONDA ACCORD 4D 94-97 EZ/ V-6 E2

Application 3 : HONDA ACCORD WAGON 94-97

Application 4 : ACURA CL 2,2L 1997

Application 5 :

Application 6 :

Application 7 :

Application 8 :

Application 9 :

Application 10 :

Application 11 :

Application 12 :

ZOOM+

ZOOM-



PARTS IMAGE

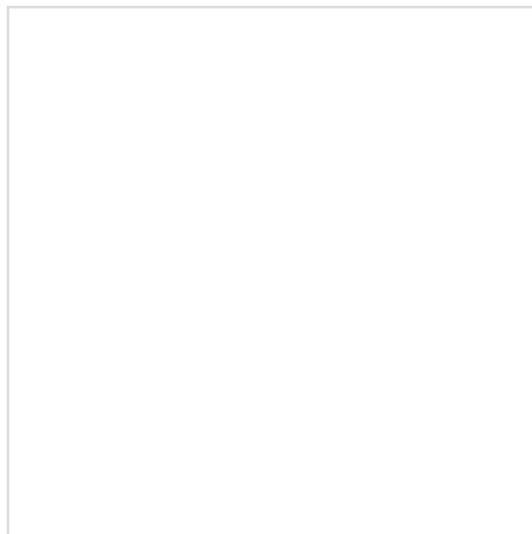

BOX IMAGE

18011-POB-A00

Parts Number : 18011-POB-A00

Manufacture 1 : KEIHIN

Manufacturer Number 1 :

Manufacture 2 :

Manufacturer Number 2 :

M.S.R.P 04/2010 : \$220.57

Description: EGR VALVE (18710-POB-A01)
MADE IN JAPAN #G

Application 1 : HONDA ACCORD 2D 94-97

Application 2 : HONDA ACCORD 4D 94-97 E2/ V6 E2

Application 3 : HONDA ACCORD WAGON 94-97

Application 4 :

Application 5 :

Application 6 :

Application 7 :

Application 8 :

Application 9 :

Application 10 :

Application 11 :

Application 12 :

EGR VALVE (18710-POB-A01)



PARTS IMAGE

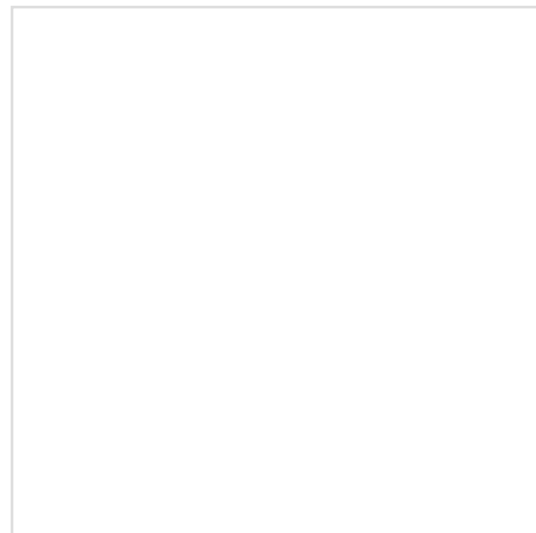

BOX IMAGE

18011-P13-000

EGR VALVE

Parts Number : 18011-P13-000

Manufacture 1 : KEIHIN

Manufacturer Number 1 :

Manufacture 2 :

Manufacturer Number 2 :

M.S.R.P 04/2010 : \$274.40

Description: EGR VALVE
MADE IN JAPAN #G

Application 1 : HONDA PRELUDE 92-96

Application 2 : HONDA PELUEDE 97-01

Application 3 :

Application 4 :

Application 5 :

Application 6 :

Application 7 :

Application 8 :

Application 9 :

Application 10 :

Application 11 :

Application 12 :

ZOOM+

ZOOM-



PARTS IMAGE

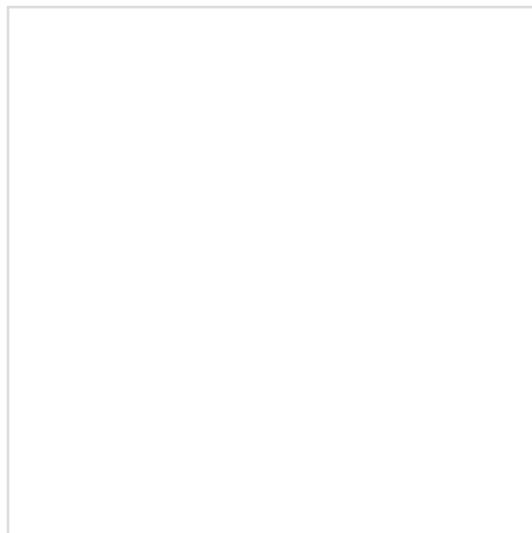

BOX IMAGE

18011-P2J-000

EGR VALVE (18011-P2J-031)

Parts Number : 18011-P2J-000

Manufacture 1 : KEIHIN

Manufacturer Number 1 :

Manufacture 2 :

Manufacture Number 2 :

M.S.R.P 04/2010 : \$233.93

Description: EGR VALVE (18011-P2J-031)
MADE IN JAPAN #G

Application 1 : HONDA CIVIC 2D 96-00

Application 2 :

Application 3 :

Application 4 :

Application 5 :

Application 6 :

Application 7 :

Application 8 :

Application 9 :

Application 10 :

Application 11 :

Application 12 :

ZOOM+ ZOOM-



PARTS IMAGE

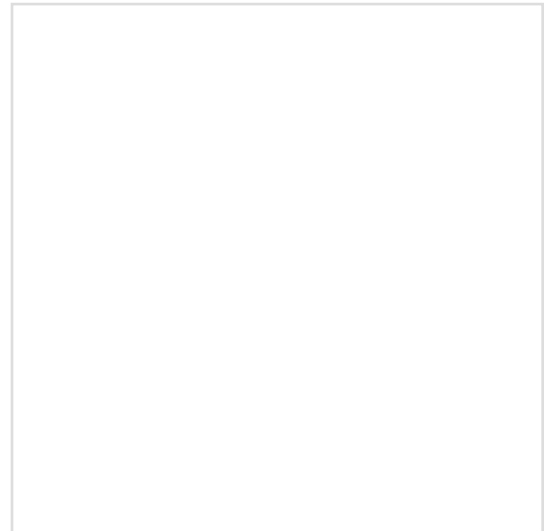

BOX IMAGE

18011-P5G-A00

EGR VALVE (18710-P5G-A00)

Parts Number :	18011-P5G-A00
Manufacture 1 :	KEIHIN <input type="button" value="v"/>
Manufacturer Number 1 :	<input type="text"/>
Manufacture 2 :	<input type="button" value="v"/>
Manufacture Number 2 :	<input type="text"/>
M.S.R.P 04/2010 :	\$296.38
Description:	EGR VALVE (18710-P5G-A00) MADE IN JAPAN #G

- Application 1 :** ACURA TL 3.2 96-98
- Application 2 :**
- Application 3 :**
- Application 4 :**
- Application 5 :**
- Application 6 :**
- Application 7 :**
- Application 8 :**
- Application 9 :**
- Application 10 :**
- Application 11 :**
- Application 12 :**

ZOOM+ ZOOM-



PARTS IMAGE

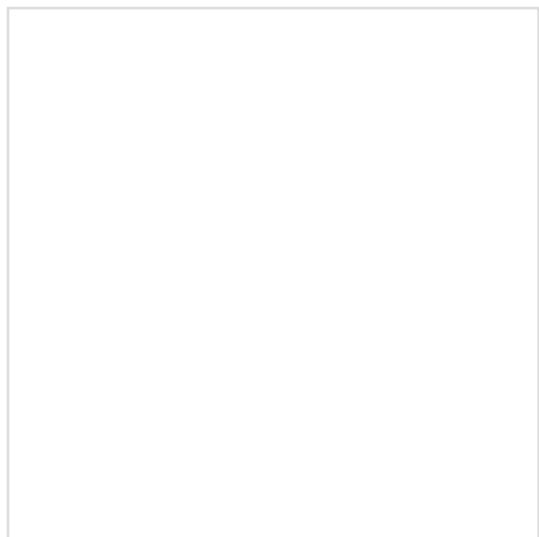

BOX IMAGE

18011-PAA-A00

EGR VALVE

Parts Number : 18011-PAA-A00

Manufacture 1 : SIEMENS

Manufacturer Number 1 : FE01 1177F

Manufacture 2 :

Manufacture Number 2 :

M.S.R.P 04/2010 : \$167.28

Description: EGR VALVE
MADE IN USA (ASSEMBLED IN MEXICO) #G

Application 1 : HONDA ACCORD 2D 98-02

Application 2 : HONDA ACCORD 4D 2002

Application 3 : HONDA ACCORD 4D 98-01

Application 4 : HONDA ODYSSEY 95-98

Application 5 : ACURA CL 2.3L 98-99

Application 6 :

Application 7 :

Application 8 :

Application 9 :

Application 10 :

Application 11 :

Application 12 :

ZOOM+

ZOOM-



PARTS IMAGE

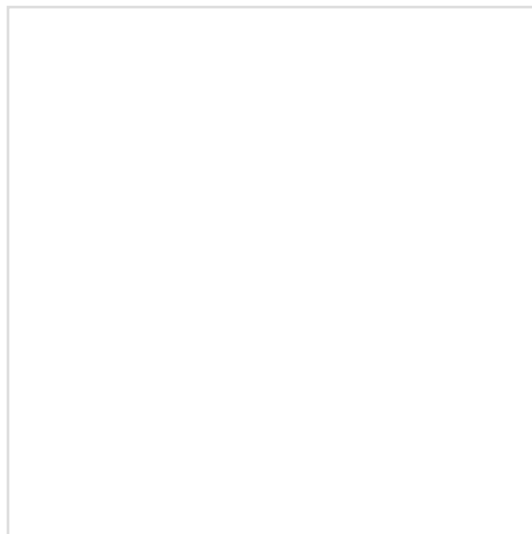

BOX IMAGE

18011-PT6-A00

Parts Number : 18011-PT6-A00

Manufacture 1 : KEIHIN

Manufacturer Number 1 :

Manufacture 2 :

Manufacturer Number 2 :

M.S.R.P 04/2010 : \$213.08

Description: EGR VALVE (18710-PT6-A00)
MADE IN JAPAN #G

Application 1 : HONDA ACCORD 2D 90-93

Application 2 : HONDA ACCORD 4D 90-93

Application 3 : HONDA ACCORD WAGON 91-93

Application 4 :

Application 5 :

Application 6 :

Application 7 :

Application 8 :

Application 9 :

Application 10 :

Application 11 :

Application 12 :

EGR VALVE (18710-PT6-A00)

ZOOM+

ZOOM-



PARTS IMAGE

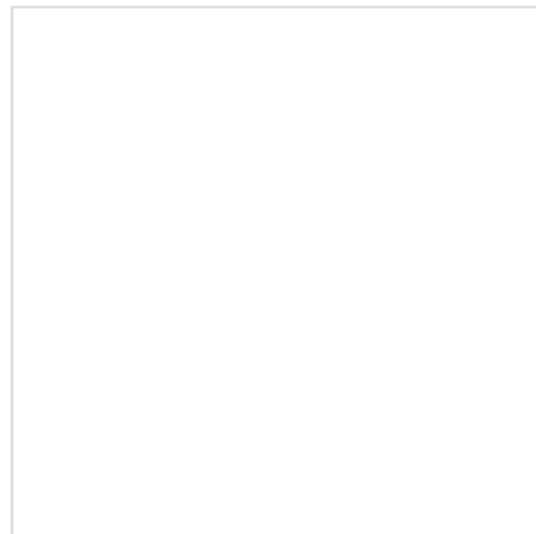

BOX IMAGE

18011-PY3-000

EGR VALVE

Parts Number : 18011-PY3-000

Manufacture 1 : KEIHIN

Manufacturer Number 1 :

Manufacture 2 :

Manufacturer Number 2 :

M.S.R.P 04/2010 : \$201.28

Description: EGR VALVE
MADE IN JAPAN #G

Application 1 : ACURA RL 3.5L 96-04

Application 2 :

Application 3 :

Application 4 :

Application 5 :

Application 6 :

Application 7 :

Application 8 :

Application 9 :

Application 10 :

Application 11 :

Application 12 :

ZOOM+

ZOOM-



PARTS IMAGE

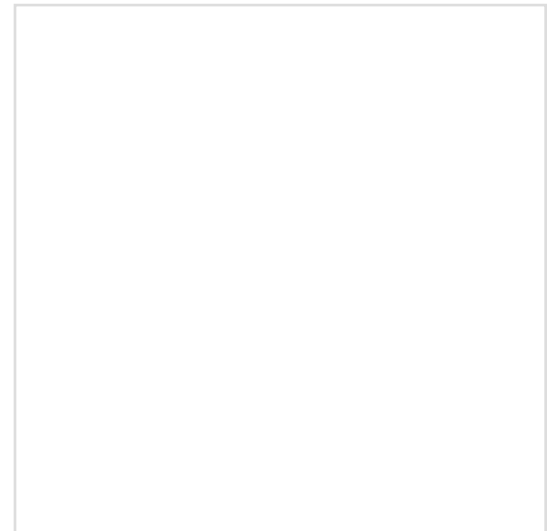

BOX IMAGE

18715-PB2-000

EGR VALVE GASKET

Parts Number : 18715-PB2-000

Manufacture 1 :

Manufacturer Number 1 :

Manufacture 2 :

Manufacturer Number 2 :

M.S.R.P 04/2010 : \$6.23

Description: EGR VALVE GASKET
MADE IN JAPAN #G

Application 1 : HODNA ACCORD 2D 3D 4D HYBRID 79-09

Application 2 : HONDA CIVIC 2D 3D 4D HYBRID 80-09

Application 3 : HONDA CR-V 07-09

Application 4 : HONDA CRX 84-91

Application 5 : HONDA ELEMENT 03-09

Application 6 : HONDA FIT 07-09

Application 7 : HONDA INSIGHT 00-06

Application 8 : HONDA PILOT 03-09

Application 9 : HONDA PRELUDE 79-01

Application 10 : HONDA RIDGELINE 06-09

Application 11 :

Application 12 :

ZOOM+

ZOOM-



PARTS IMAGE

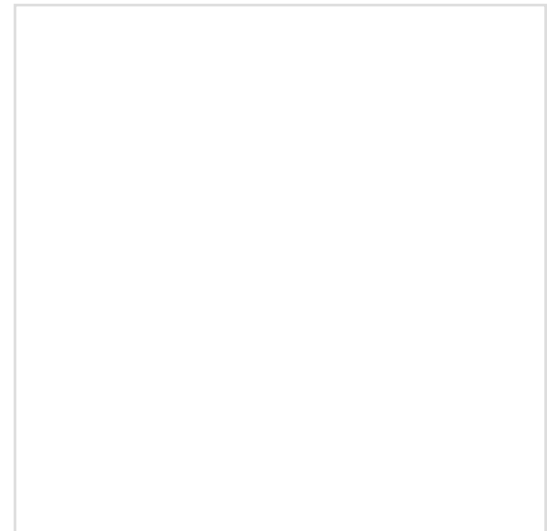

BOX IMAGE

23220-RGR-010

COUNTER SHAFT

Parts Number : 23220-RGR-010

Manufacture 1 :

Manufacturer Number 1 :

Manufacture 2 :

Manufacturer Number 2 :

M.S.R.P 04/2010 : \$314.47

Description: COUNTER SHAFT
MADE IN JAPAN #G

Application 1 : HONDA ACCORD 4D 03-06

Application 2 : HONDA ACCORD 4D 2007

Application 3 : HONDA ACCORD COUPE 03-06

Application 4 : HONDA ACCORD COUPE 2007

Application 5 : HONDA ODYSSEY 05-09

Application 6 : HONDA PILOT 03-07

Application 7 :

Application 8 :

Application 9 :

Application 10 :

Application 11 :

Application 12 :

ZOOM+

ZOOM-



PARTS IMAGE

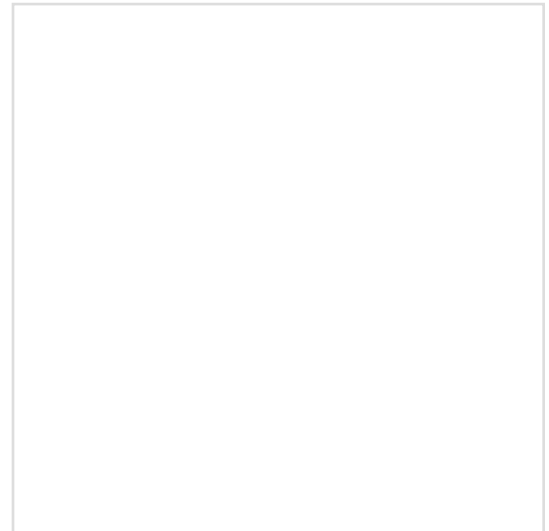

BOX IMAGE

23221-P7Z-000

COUNTER SHAFT

Parts Number : 23221-P7Z-000

Manufacture 1 :

Manufacturer Number 1 :

Manufacture 2 :

Manufacturer Number 2 :

M.S.R.P 04/2010 : \$352.57

Description: COUNTER SHAFT
MADE IN JAPAN #G

Application 1 : HONDA ACCORD 2D 98-02

Application 2 : HONDA ACCORD 4D 2002

Application 3 : HONDA ACCORD 4D 98-01

Application 4 :

Application 5 :

Application 6 :

Application 7 :

Application 8 :

Application 9 :

Application 10 :

Application 11 :

Application 12 :

ZOOM+

ZOOM-



PARTS IMAGE

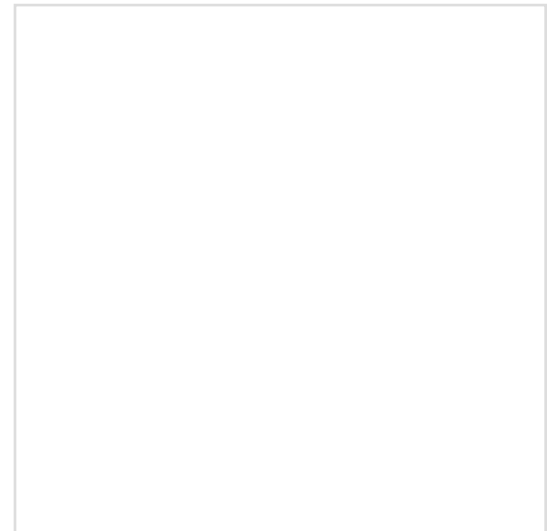

BOX IMAGE

23411-P7W-000

GEAR 2ND

Parts Number : 23411-P7W-000

Manufacture 1 :

Manufacturer Number 1 :

Manufacture 2 :

Manufacturer Number 2 :

M.S.R.P 04/2010 : \$96.52

Description: GEAR 2ND
MADE IN USA #G

Application 1 : HONDA ACCORD 4D 03-06

Application 2 : HONDA ACCORD COUPE 03-06

Application 3 : HONDA ODYSSEY 99-04

Application 4 : HONDA PILOT 03-07

Application 5 :

Application 6 :

Application 7 :

Application 8 :

Application 9 :

Application 10 :

Application 11 :

Application 12 :

ZOOM+ ZOOM-



PARTS IMAGE

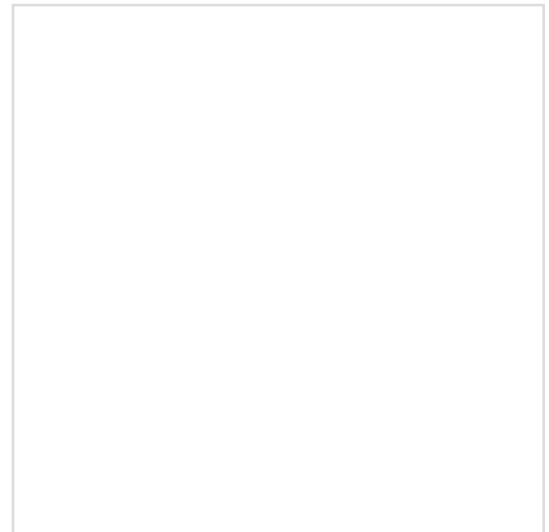

BOX IMAGE

23420-RAY-005

HUB CLUTCH S-LOW

Parts Number : 23420-RAY-005

Manufacture 1 :

Manufacturer Number 1 : CX53266NIK-5

Manufacture 2 :

Manufacturer Number 2 :

M.S.R.P 04/2010 : \$142.92

Description: HUB CLUTCH S-LOW
MADE IN JAPAN #OEM

Application 1 : HONDA ACCORD 4D 03-06

Application 2 : HONDA ACCORD COUPE 03-06

Application 3 : HONDA ODYSSEY 99-04

Application 4 : HONDA PILOT 03-07

Application 5 :

Application 6 :

Application 7 :

Application 8 :

Application 9 :

Application 10 :

Application 11 :

Application 12 :

ZOOM+

ZOOM-



PARTS IMAGE

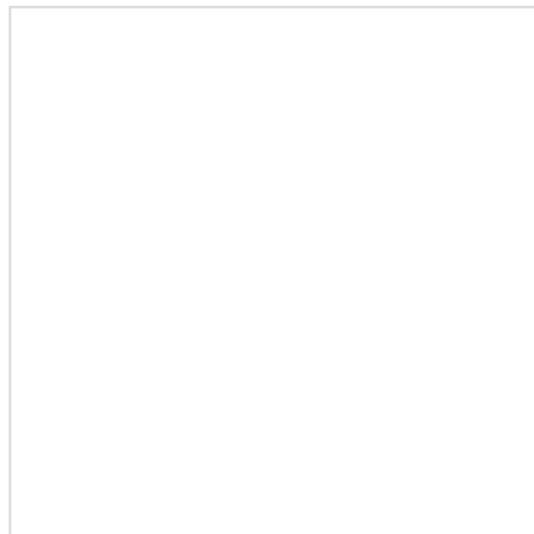

BOX IMAGE

23623-PNS-315

SYNCHRO 3-4

Parts Number : 23623-PNS-315

Manufacture 1 :

Manufacturer Number 1 :

Manufacture 2 :

Manufacture Number 2 :

M.S.R.P 04/2010 :

Description: SYNCHRO 3-4
MADE IN JAPAN #G

Application 1 :

Application 2 :

Application 3 :

Application 4 :

Application 5 :

Application 6 :

Application 7 :

Application 8 :

Application 9 :

Application 10 :

Application 11 :

Application 12 :

ZOOM+ ZOOM-



PARTS IMAGE

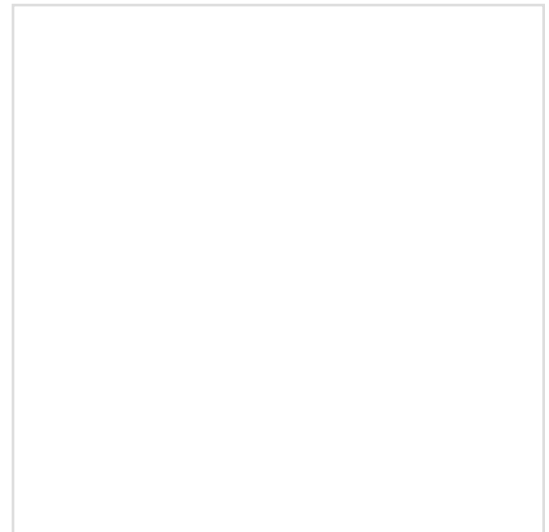

BOX IMAGE

23830-65D00

CLUTCH SLAVE CYLINDER

ZOOM+ ZOOM-

Parts Number : 23830-65D00

Manufacture 1 : ADLER

Manufacturer Number 1 :

Manufacture 2 :

Manufacture Number 2 :

M.S.R.P 04/2010 :

Description: CLUTCH SLAVE CYLINDER MADE IN JAPAN



PARTS IMAGE

Application 1 : SUZUKI GRAND VITARA

Application 2 :

Application 3 :

Application 4 :

Application 5 :

Application 6 :

Application 7 :

Application 8 :

Application 9 :

Application 10 :

Application 11 :

Application 12 :



BOX IMAGE

25230-C9962

MAIN RELAY

Parts Number :	25230-C9962
Manufacture 1 :	MITSUBA <input type="button" value="v"/>
Manufacturer Number 1 :	2709600-A
Manufacture 2 :	<input type="button" value="v"/>
Manufacture Number 2 :	
M.S.R.P 04/2010 :	
Description:	MAIN RELAY

- Application 1 :
- Application 2 :
- Application 3 :
- Application 4 :
- Application 5 :
- Application 6 :
- Application 7 :
- Application 8 :
- Application 9 :
- Application 10 :
- Application 11 :
- Application 12 :

ZOOM+ ZOOM-



PARTS IMAGE



BOX IMAGE

27200-P0X-900

REGULATOR

Parts Number : 27200-P0X-900

Manufacture 1 :

Manufacturer Number 1 :

Manufacture 2 :

Manufacturer Number 2 :

M.S.R.P 04/2010 : \$243.55

Description: REGULATOR
MADE IN JAPAN #G

Application 1 : HONDA ACCORD 2D 94-97

Application 2 : HONDA ACCORD 4D 94-97 E2/V6 EZ

Application 3 : HONDA ACCORD WAGON 94-97

Application 4 : HONDA ODYSSEY 95-98

Application 5 :

Application 6 :

Application 7 :

Application 8 :

Application 9 :

Application 10 :

Application 11 :

Application 12 :

ZOOM+ ZOOM-



PARTS IMAGE

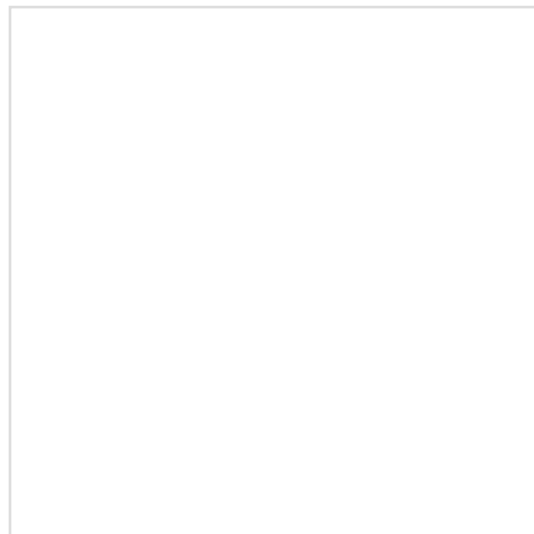

BOX IMAGE

28015-PPV-305G

SOLENOID SET, SHIFT

Parts Number : 28015-PPV-305G

Manufacture 1 :

Manufacturer Number 1 :

Manufacture 2 :

Manufacturer Number 2 :

M.S.R.P 04/2010 : \$723.87

Description: SOLENOID SET, SHIFT

Application 1 :

Application 2 :

Application 3 :

Application 4 :

Application 5 :

Application 6 :

Application 7 :

Application 8 :

Application 9 :

Application 10 :

Application 11 :

Application 12 :

ZOOM+

ZOOM-

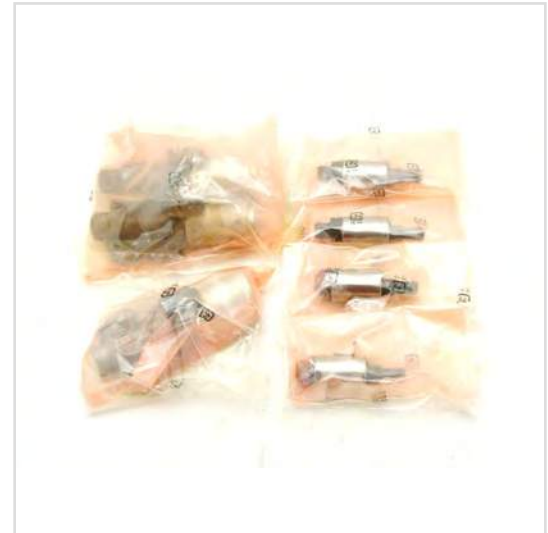

PARTS IMAGE

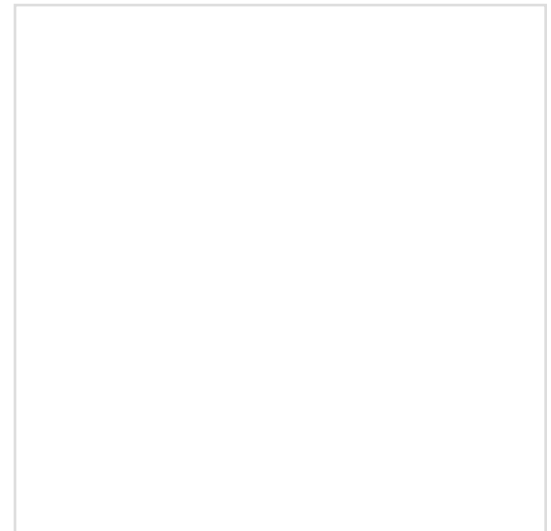

BOX IMAGE

28015-RCL-305G

SOLENOID SET, SHIFT

Parts Number : 28015-RCL-305G

Manufacture 1 :

Manufacturer Number 1 :

Manufacture 2 :

Manufacturer Number 2 :

M.S.R.P 04/2010 : \$241.02

Description: SOLENOID SET, SHIFT

Application 1 :

Application 2 :

Application 3 :

Application 4 :

Application 5 :

Application 6 :

Application 7 :

Application 8 :

Application 9 :

Application 10 :

Application 11 :

Application 12 :

ZOOM+

ZOOM-

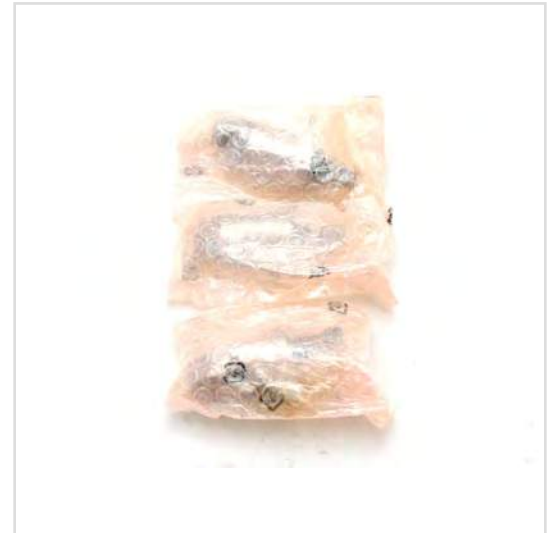

PARTS IMAGE

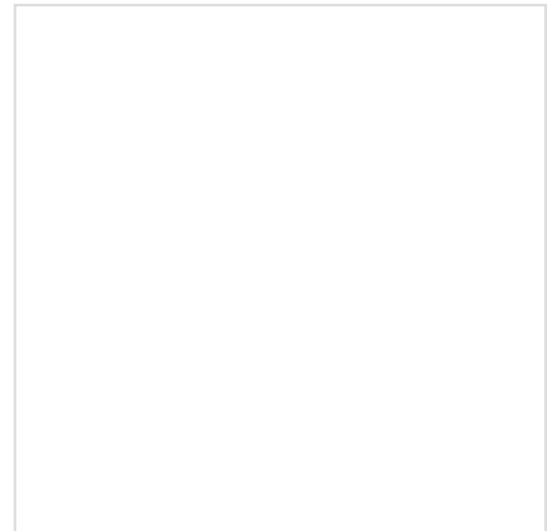

BOX IMAGE

28200-P0Z-003

SOLENOID TRANSMISSION

Parts Number : 28200-P0Z-003

Manufacture 1 : KEIHIN

Manufacturer Number 1 :

Manufacture 2 :

Manufacturer Number 2 :

M.S.R.P 04/2010 : \$225.12

Description: SOLENOID TRANSMISSION
MADE IN JAPAN #OEM

- Application 1 :** HONDA ACCORD 2D 98-02
- Application 2 :** HONDA ACCORD 4D 2002
- Application 3 :** HONDA ACCORD 4D 94-97 E2 V6 E2
- Application 4 :** HONDA ACCORD 4D 98-01
- Application 5 :** HONDA ODYSSEY 99-04
- Application 6 :**
- Application 7 :**
- Application 8 :**
- Application 9 :**
- Application 10 :**
- Application 11 :**
- Application 12 :**

ZOOM+ ZOOM-



PARTS IMAGE



BOX IMAGE

28200-P0Z-003G

SOLENOID TRANSMISSION

Parts Number : 28200-P0Z-003G

Manufacture 1 : KEIHIN

Manufacturer Number 1 :

Manufacture 2 :

Manufacture Number 2 :

M.S.R.P 04/2010 : \$225.12

Description: SOLENOID TRANSMISSION
MADE IN JAPAN #GNTP

- Application 1 :** HONDA ACCORD 2D 98-02
- Application 2 :** HONDA ACCORD 4D 2002
- Application 3 :** HONDA ACCORD 4D 94-97 E2 V6 E2
- Application 4 :** HONDA ACCORD 4D 98-01
- Application 5 :** HONDA ODYSSEY 99-04
- Application 6 :**
- Application 7 :**
- Application 8 :**
- Application 9 :**
- Application 10 :**
- Application 11 :**
- Application 12 :**

ZOOM+ ZOOM-



PARTS IMAGE

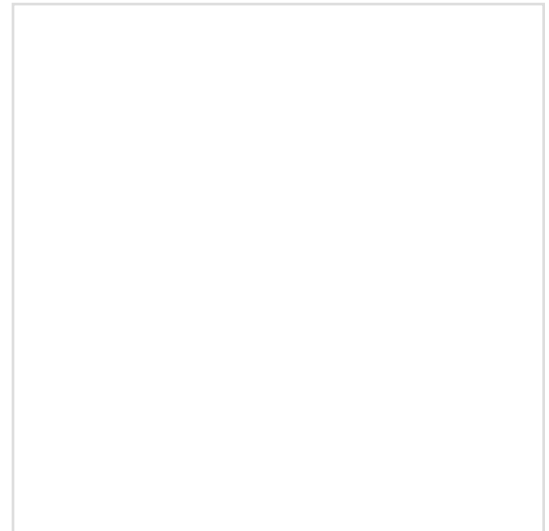

BOX IMAGE

28200-P4R-003G

SOLENOID TRANSMISSION

Parts Number : 28200-P4R-003G

Manufacture 1 : KEIHIN

Manufacturer Number 1 :

Manufacture 2 :

Manufacture Number 2 :

M.S.R.P 04/2010 : \$168.85

Description: SOLENOID TRANSMISSION
MADE IN JAPAN #GNTP

Application 1 : HONDA CIVIC 2D 96-00

Application 2 : HONDA CIVIC 3D 96-00

Application 3 : HONDA CIVIC 4D 96-97 US 96-00 EXP

Application 4 : HONDA CR-V 97-01

Application 5 :

Application 6 :

Application 7 :

Application 8 :

Application 9 :

Application 10 :

Application 11 :

Application 12 :

ZOOM+ ZOOM-



PARTS IMAGE

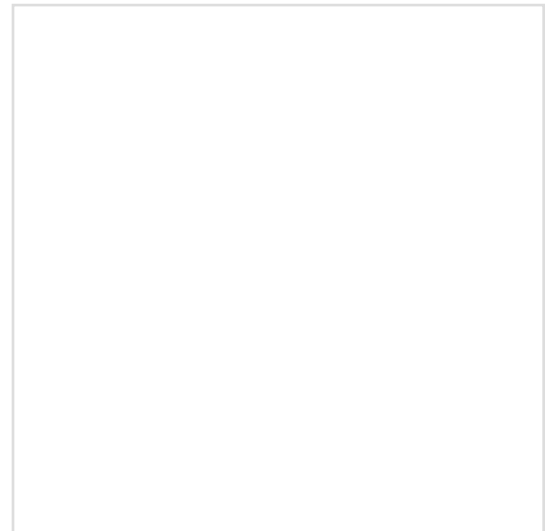

BOX IMAGE

28200-P56-003G

SOLENOID TRANSMISSION

Parts Number : 28200-P56-003G

Manufacture 1 : KEIHIN

Manufacturer Number 1 :

Manufacture 2 :

Manufacturer Number 2 :

M.S.R.P 04/2010 : \$243.55

Description: SOLENOID TRANSMISSION
MADE IN JAPAN #OEMNTP

Application 1 : ACURA INTEGRA 3D 94-01

Application 2 : ACURA INTEGRA 4D 94-01

Application 3 :

Application 4 :

Application 5 :

Application 6 :

Application 7 :

Application 8 :

Application 9 :

Application 10 :

Application 11 :

Application 12 :

ZOOM+ ZOOM-



PARTS IMAGE

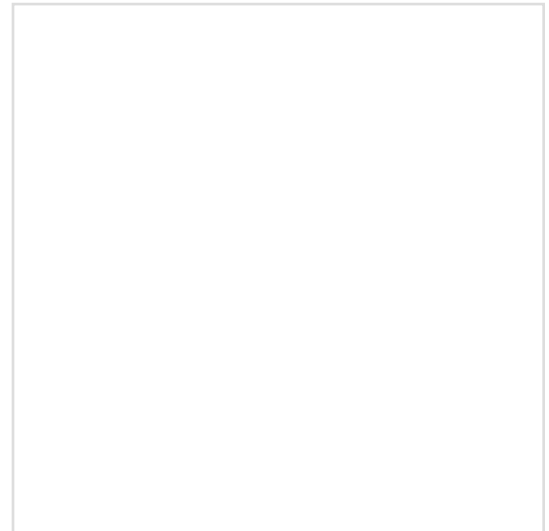

BOX IMAGE

28200-PL4-681

SOLENOID TRANSMISSION

Parts Number : 28200-PL4-681

Manufacture 1 :

Manufacturer Number 1 : 155

Manufacture 2 :

Manufacture Number 2 :

M.S.R.P 04/2010 : \$225.83

Description: SOLENOID TRANSMISSION
MADE IN JAPAN #OEMNTP

Application 1 : HONDA CIVIC 3D 89-91

Application 2 : HONDA CIVIC 4D 88-91

Application 3 : HONDA CRX 88-91

Application 4 :

Application 5 :

Application 6 :

Application 7 :

Application 8 :

Application 9 :

Application 10 :

Application 11 :

Application 12 :



PARTS IMAGE

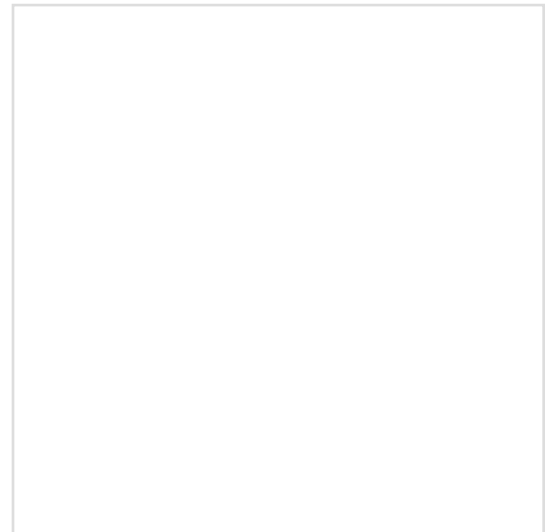

BOX IMAGE

28200-PL5-033

SOLENOID TRANSMISSION

Parts Number : 28200-PL5-033

Manufacture 1 : KEIHIN

Manufacturer Number 1 :

Manufacture 2 :

Manufacturer Number 2 :

M.S.R.P 04/2010 : \$225.12

Description: SOLENOID TRANSMISSION
MADE IN JAPAN #OEM

Application 1 : ACURA LEGEND 2D 87-90

Application 2 : ACURA LEGEND 4d 86-90

Application 3 :

Application 4 :

Application 5 :

Application 6 :

Application 7 :

Application 8 :

Application 9 :

Application 10 :

Application 11 :

Application 12 :

ZOOM+ ZOOM-



PARTS IMAGE



BOX IMAGE

28200-PL5-033G

SOLENOID TRANSMISSION

Parts Number : 28200-PL5-033G

Manufacture 1 :

Manufacturer Number 1 :

Manufacture 2 :

Manufacturer Number 2 :

M.S.R.P 04/2010 : \$225.12

Description: SOLENOID TRANSMISSION

Application 1 : ACURA LEGEND 2D 87-90

Application 2 : ACURA LEGEND 4d 86-90

Application 3 :

Application 4 :

Application 5 :

Application 6 :

Application 7 :

Application 8 :

Application 9 :

Application 10 :

Application 11 :

Application 12 :

ZOOM+

ZOOM-



PARTS IMAGE

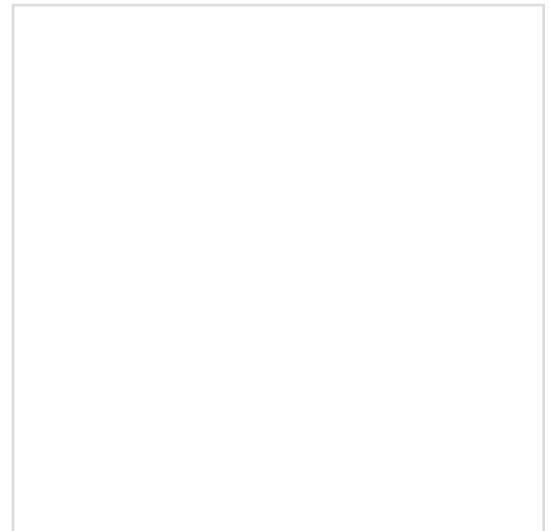

BOX IMAGE

28200-PLX-003G

SOLENOID TRANSMISSION

Parts Number :	28200-PLX-003G
Manufacture 1 :	KEIHIN <input type="button" value="v"/>
Manufacturer Number 1 :	
Manufacture 2 :	<input type="button" value="v"/>
Manufacture Number 2 :	
M.S.R.P 04/2010 :	\$168.85
Description:	SOLENOID TRANSMISSION MADE IN JAPAN #OEMNTP

ZOOM+ ZOOM-



PARTS IMAGE

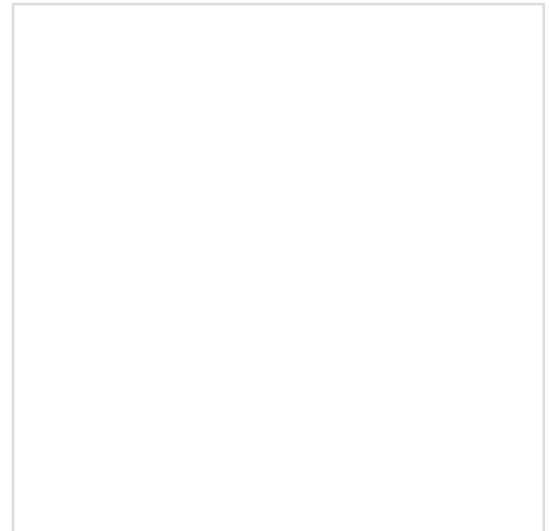

BOX IMAGE

- Application 1 :** HONDA CIVIC 2D 01-05
- Application 2 :** HONDA CIVIC 4D 01-05
- Application 3 :**
- Application 4 :**
- Application 5 :**
- Application 6 :**
- Application 7 :**
- Application 8 :**
- Application 9 :**
- Application 10 :**
- Application 11 :**
- Application 12 :**

28200-PR0-010

SOLENOID TRANSMISSION

Parts Number : 28200-PR0-010

Manufacture 1 :

Manufacturer Number 1 : 157

Manufacture 2 :

Manufacturer Number 2 :

M.S.R.P 04/2010 :

Description: SOLENOID TRANSMISSION
MADE IN JAPAN #OEMNTP

Application 1 : ACURA INTEGRA 93-94

Application 2 :

Application 3 :

Application 4 :

Application 5 :

Application 6 :

Application 7 :

Application 8 :

Application 9 :

Application 10 :

Application 11 :

Application 12 :

ZOOM+

ZOOM-

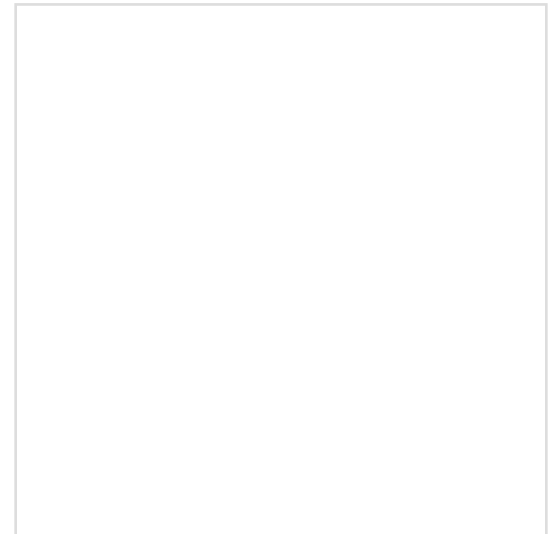

PARTS IMAGE

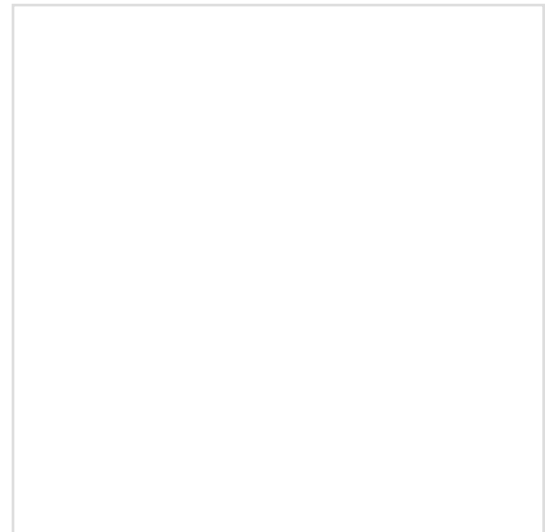

BOX IMAGE

28200-PW4-043

SOLENOID TRANSMISSION

Parts Number : 28200-PW4-043

Manufacture 1 :

Manufacturer Number 1 : 158

Manufacture 2 :

Manufacture Number 2 :

M.S.R.P 04/2010 :

Description: SOLENOID TRANSMISSION
MADE IN JAPAN #OEMNTP

Application 1 :

Application 2 :

Application 3 :

Application 4 :

Application 5 :

Application 6 :

Application 7 :

Application 8 :

Application 9 :

Application 10 :

Application 11 :

Application 12 :

ZOOM+

ZOOM-



PARTS IMAGE

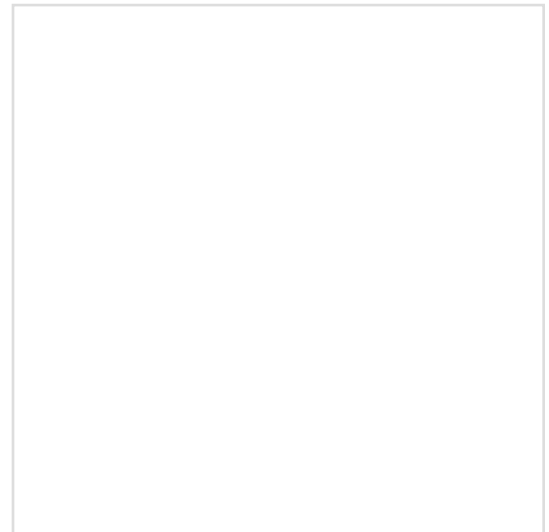

BOX IMAGE

28200-PX4-003

SOLENOID TRANSMISSION

Parts Number : 28200-PX4-003

Manufacture 1 : KEIHIN

Manufacturer Number 1 :

Manufacture 2 :

Manufacture Number 2 :

M.S.R.P 04/2010 :

Description: SOLENOID TRANSMISSION
MADE IN JAPAN #GNTP

Application 1 :

Application 2 :

Application 3 :

Application 4 :

Application 5 :

Application 6 :

Application 7 :

Application 8 :

Application 9 :

Application 10 :

Application 11 :

Application 12 :

ZOOM+ ZOOM-



PARTS IMAGE



BOX IMAGE

28200-PX4-004

SOLENOID TRANSMISSION

Parts Number : 28200-PX4-004

Manufacture 1 :

Manufacturer Number 1 : 160

Manufacture 2 :

Manufacturer Number 2 :

M.S.R.P 04/2010 :

Description: SOLENOID TRANSMISSION
MADE IN JAPAN #OEMNTP

Application 1 :

Application 2 :

Application 3 :

Application 4 :

Application 5 :

Application 6 :

Application 7 :

Application 8 :

Application 9 :

Application 10 :

Application 11 :

Application 12 :

ZOOM+

ZOOM-



PARTS IMAGE

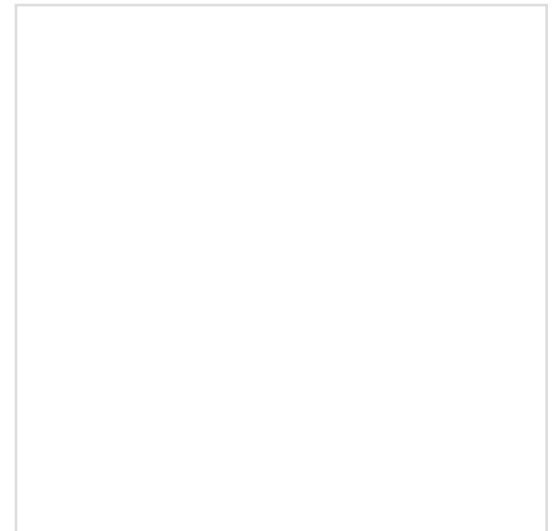

BOX IMAGE

28200-PX4-014

SOLENOID TRANSMISSION

Parts Number : 28200-PX4-014

Manufacture 1 : SHINDENGEN

Manufacturer Number 1 :

Manufacture 2 :

Manufacture Number 2 :

M.S.R.P 04/2010 : \$225.12

Description: SOLENOID TRANSMISSION
28200-PX4-003 MADE IN JAPAN
#OEM

- Application 1 :** HONDA ACCORD 2D 90-93
- Application 2 :** HONDA ACCORD 2D 94-97
- Application 3 :** HONDA ACCORD 4D 90-93
- Application 4 :** HONDA ACCORD 4D 94-97 E2 V6 E2
- Application 5 :** HONDA ACCORD WAGON 91-93
- Application 6 :** HONDA ACCORD WAGON 94-97
- Application 7 :** HONDA ODYSSEY 95-98
- Application 8 :** HONDA PRELUDE 92-96
- Application 9 :**
- Application 10 :**
- Application 11 :**
- Application 12 :**

ZOOM+ ZOOM-



PARTS IMAGE



BOX IMAGE

28200-PY4-004

SOLENOID TRANSMISSION

Parts Number : 28200-PY4-004

Manufacture 1 :

Manufacturer Number 1 : 161

Manufacture 2 :

Manufacturer Number 2 :

M.S.R.P 04/2010 :

Description: SOLENOID TRANSMISSION
MADE IN JAPAN #OEMNTP

Application 1 :

Application 2 :

Application 3 :

Application 4 :

Application 5 :

Application 6 :

Application 7 :

Application 8 :

Application 9 :

Application 10 :

Application 11 :

Application 12 :

ZOOM+

ZOOM-



PARTS IMAGE

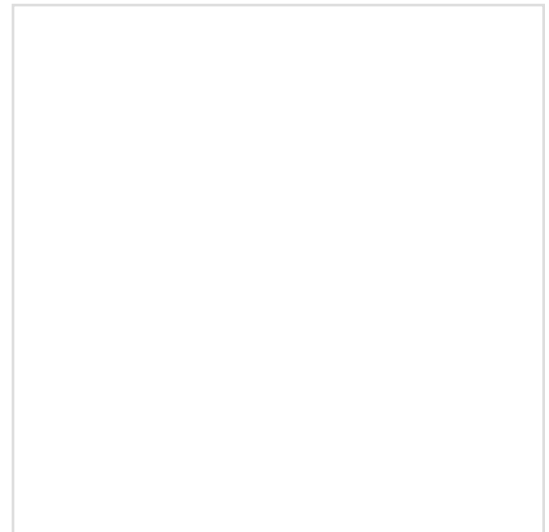

BOX IMAGE

28250-P4R-315

SOLENOID TRANSMISSION

Parts Number : 28250-P4R-315

Manufacture 1 : DENSO

Manufacturer Number 1 :

Manufacture 2 :

Manufacture Number 2 :

M.S.R.P 04/2010 : \$174.82

Description: SOLENOID TRANSMISSION
MADE IN JAPAN #OEM

Application 1 : HONDA CIVIC 2D 96-00

Application 2 : HONDA CIVIC 3D 96-00

Application 3 : HONDA CIVIC 96-97 US 96-00 EXP

Application 4 : HONDA CIVIC 4D 98-00

Application 5 : HONDA CR-V 97-01

Application 6 :

Application 7 :

Application 8 :

Application 9 :

Application 10 :

Application 11 :

Application 12 :

ZOOM+

ZOOM-



PARTS IMAGE



BOX IMAGE

28250-P4R-315G

SOLENOID TRANSMISSION

Parts Number : 28250-P4R-315G

Manufacture 1 :

Manufacturer Number 1 :

Manufacture 2 :

Manufacture Number 2 :

M.S.R.P 04/2010 : \$174.82

Description: SOLENOID TRANSMISSION

- Application 1 :** HONDA CIVIC 2D 96-00
- Application 2 :** HONDA CIVIC 3D 96-00
- Application 3 :** HONDA CIVIC 96-97 US 96-00 EXP
- Application 4 :** HONDA CIVIC 4D 98-00
- Application 5 :** HONDA CR-V 97-01
- Application 6 :**
- Application 7 :**
- Application 8 :**
- Application 9 :**
- Application 10 :**
- Application 11 :**
- Application 12 :**

ZOOM+ ZOOM-



PARTS IMAGE

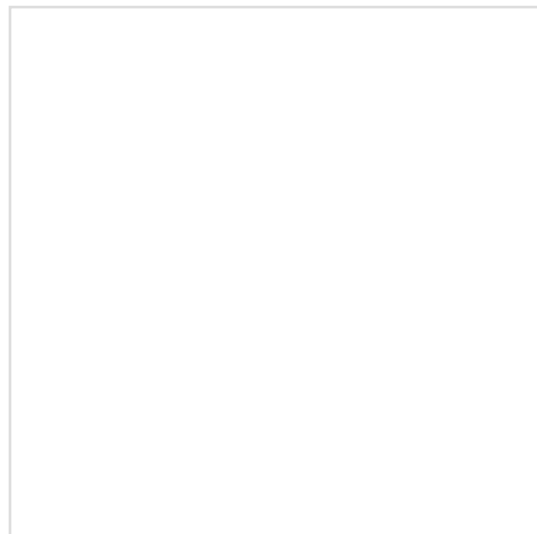

BOX IMAGE

28250-P6H-024

SOLENOID TRANSMISSION

Parts Number : 28250-P6H-024

Manufacture 1 : DENSO

Manufacturer Number 1 :

Manufacture 2 :

Manufacture Number 2 :

M.S.R.P 04/2010 : \$260.22

Description: SOLENOID TRANSMISSION
MADE IN JAPAN #OEM

- Application 1 :** HONDA ACCORD 2D 98-02
- Application 2 :** HONDA ACCORD 4D 2002
- Application 3 :** HONDA ACCORD 4D2007
- Application 4 :** HONDA ACCORD 4D 98-01
- Application 5 :** HONDA ACCORD COUPE 03-06
- Application 6 :** HONDA ACCORD 2007
- Application 7 :** HONDA ODYSSEY 05-09
- Application 8 :** HONDA ODYSSEY 95-98
- Application 9 :** HONDA ODYSSEY 99-04
- Application 10 :** HONDA PILOT 03-07
- Application 11 :**
- Application 12 :**

ZOOM+ ZOOM-



PARTS IMAGE



BOX IMAGE

28250-P7W-003

SOLENOID TRANSMISSION

Parts Number : 28250-P7W-003

Manufacture 1 : KEIHIN

Manufacturer Number 1 :

Manufacture 2 :

Manufacture Number 2 :

M.S.R.P 04/2010 : \$229.50

Description: SOLENOID TRANSMISSION
MADE IN JAPAN #OEM

- Application 1 :** HONDA ACCORD 4D 03-06
- Application 2 :** HONDA ACCORD 4D 2007
- Application 3 :** HONDA ACCORD COUPE 03-06
- Application 4 :** HONDA ACCORD COUPE 2007
- Application 5 :** HONDA ODYSSEY 05-09
- Application 6 :** HONDA ODYSSEY 99-04
- Application 7 :** HONDA PILOT 03-07
- Application 8 :**
- Application 9 :**
- Application 10 :**
- Application 11 :**
- Application 12 :**

ZOOM+ ZOOM-



PARTS IMAGE



BOX IMAGE

28250-P7W-003G

SOLENOID TRANSMISSION

Parts Number : 28250-P7W-003G

Manufacture 1 : KEIHIN

Manufacturer Number 1 :

Manufacture 2 :

Manufacture Number 2 :

M.S.R.P 04/2010 : \$229.50

Description: SOLENOID TRANSMISSION
MADE IN JAPAN #GNTP

- Application 1 :** HONDA ACCORD 4D 03-06
- Application 2 :** HONDA ACCORD 4D 2007
- Application 3 :** HONDA ACCORD COUPE 03-06
- Application 4 :** HONDA ACCORD COUPE 2007
- Application 5 :** HONDA ODYSSEY 05-09
- Application 6 :** HONDA ODYSSEY 99-04
- Application 7 :** HONDA PILOT 03-07
- Application 8 :**
- Application 9 :**
- Application 10 :**
- Application 11 :**
- Application 12 :**

ZOOM+

ZOOM-



PARTS IMAGE

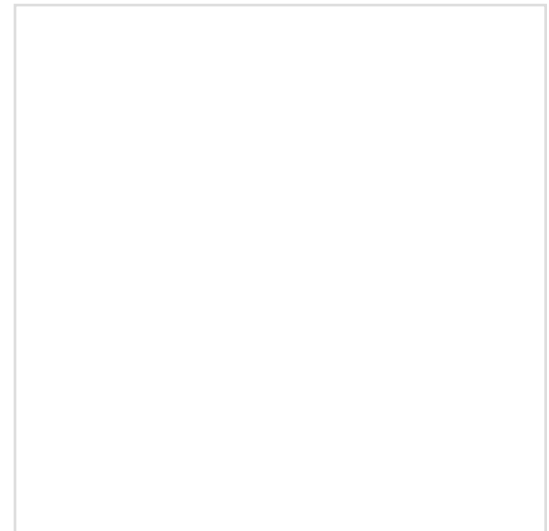

BOX IMAGE

28250-PLX-305

SOLENOID TRANSMISSION

Parts Number : 28250-PLX-305

Manufacture 1 : DENSO

Manufacturer Number 1 :

Manufacture 2 :

Manufacture Number 2 :

M.S.R.P 04/2010 : \$239.35

Description: SOLENOID TRANSMISSION
MADE IN JAPAN #OEM

Application 1 : HONDA CIVIC 2D 01-04

Application 2 : HONDA CIVIC 2D 2005

Application 3 : HONDA CIVIC 4D 01-03

Application 4 : HONDA CIVIC 4 D 2004

Application 5 : HONDA CIVIC 4D 2005

Application 6 :

Application 7 :

Application 8 :

Application 9 :

Application 10 :

Application 11 :

Application 12 :

ZOOM+

ZOOM-



PARTS IMAGE



BOX IMAGE

28250-PLX-305G

SOLENOID TRANSMISSION

Parts Number : 28250-PLX-305G

Manufacture 1 : DENSO

Manufacturer Number 1 :

Manufacture 2 :

Manufacture Number 2 :

M.S.R.P 04/2010 : \$239.35

Description: SOLENOID TRANSMISSION
MADE IN JAPAN #GNTP

Application 1 : HONDA CIVIC 2D 01-04

Application 2 : HONDA CIVIC 2D 2005

Application 3 : HONDA CIVIC 4D 01-03

Application 4 : HONDA CIVIC 4 D 2004

Application 5 : HONDA CIVIC 4D 2005

Application 6 :

Application 7 :

Application 8 :

Application 9 :

Application 10 :

Application 11 :

Application 12 :

ZOOM+

ZOOM-



PARTS IMAGE

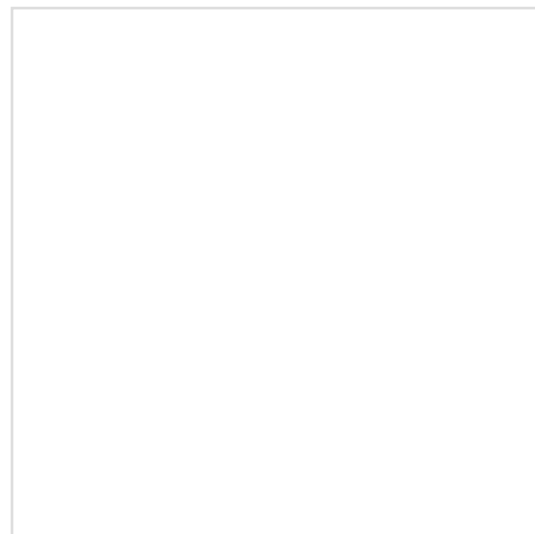

BOX IMAGE

28250-PRP-013

SOLENOID TRANSMISSION

Parts Number : 28250-PRP-013

Manufacture 1 : KEIHIN

Manufacturer Number 1 :

Manufacture 2 :

Manufacture Number 2 :

M.S.R.P 04/2010 :

Description: SOLENOID TRANSMISSION
MADE IN JAPAN #GMNTP

Application 1 :

Application 2 :

Application 3 :

Application 4 :

Application 5 :

Application 6 :

Application 7 :

Application 8 :

Application 9 :

Application 10 :

Application 11 :

Application 12 :

ZOOM+ ZOOM-



PARTS IMAGE



BOX IMAGE

28250-PW4-003

SOLENOID TRANSMISSION

Parts Number : 28250-PW4-003

Manufacture 1 :

Manufacturer Number 1 : 165

Manufacture 2 :

Manufacturer Number 2 :

M.S.R.P 04/2010 :

Description: SOLENOID TRANSMISSION
MADE IN JAPAN #OEMNTP

Application 1 :

Application 2 :

Application 3 :

Application 4 :

Application 5 :

Application 6 :

Application 7 :

Application 8 :

Application 9 :

Application 10 :

Application 11 :

Application 12 :

ZOOM+

ZOOM-

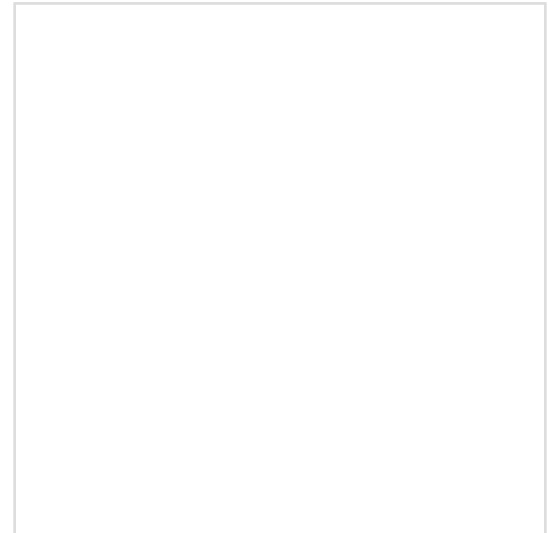

PARTS IMAGE

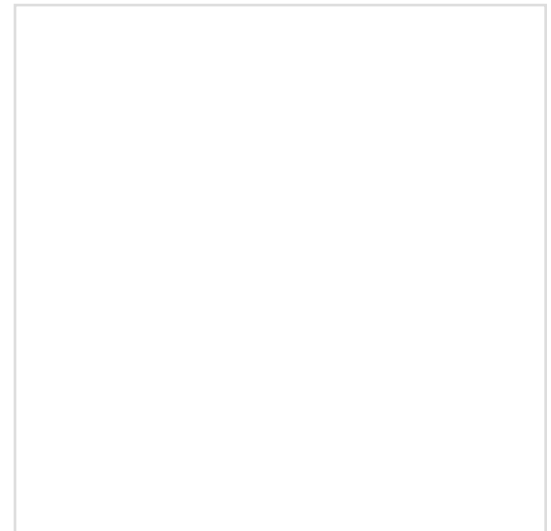

BOX IMAGE

28250-RDK-004

SOLENOID TRANSMISSION

Parts Number : 28250-RDK-004

Manufacture 1 :

Manufacturer Number 1 : 166

Manufacture 2 :

Manufacturer Number 2 :

M.S.R.P 04/2010 :

Description: SOLENOID TRANSMISSION
MADE IN JAPAN #OEMNTP

Application 1 :

Application 2 :

Application 3 :

Application 4 :

Application 5 :

Application 6 :

Application 7 :

Application 8 :

Application 9 :

Application 10 :

Application 11 :

Application 12 :

ZOOM+

ZOOM-



PARTS IMAGE

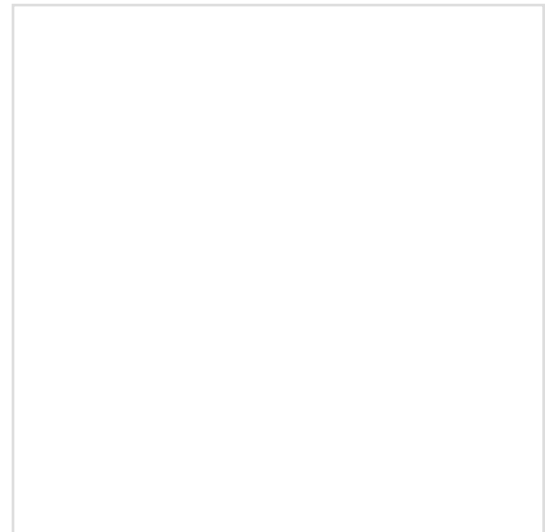

BOX IMAGE

28250-RDK-014

SOLENOID TRANSMISSION

Parts Number : 28250-RDK-014

Manufacture 1 : DENSO

Manufacturer Number 1 :

Manufacture 2 :

Manufacture Number 2 :

M.S.R.P 04/2010 : \$203.48

Description: SOLENOID TRANSMISSION
MADE IN JAPAN #GNTP

Application 1 : HONDA ACCORD HYBRID 05-07

Application 2 : HONDA ODYSSEY 05-09

Application 3 : HONDA PILOT 03-07

Application 4 : HONDA PILOT 08

Application 5 : HONDA RIDGELINE 06-09

Application 6 : ACURA MDX 01-06

Application 7 : ACURA MDX 07-09

Application 8 : ACURA RDX 07-09

Application 9 : ACURA RL 05-09

Application 10 : ACURA TL 04-07

Application 11 : ACURA TL 08

Application 12 :

ZOOM+

ZOOM-



PARTS IMAGE



BOX IMAGE

28250-RPC-003

SOLENOID TRANSMISSION

Parts Number : 28250-RPC-003

Manufacture 1 : KEIHIN

Manufacturer Number 1 :

Manufacture 2 :

Manufacture Number 2 :

M.S.R.P 04/2010 : \$203.48

Description: SOLENOID TRANSMISSION
MADE IN JAPAN #GNTP

- Application 1 :** HONDA ACCORD 4D 03-06
- Application 2 :** HONDA ACCORD 4D 2007
- Application 3 :** HONDA ACCORD COUPE 03-06
- Application 4 :** HONDA ACCORD COUPE 2007
- Application 5 :** HONDA CIVIC 2D 06-09
- Application 6 :** HONDA CIVIC 4D 06-09
- Application 7 :** HONDA CIVIC 06-09
- Application 8 :** HONDA CR-V 02-09
- Application 9 :** HONDA ELEMENT 03-09
- Application 10 :** HONDA FIT 07-08
- Application 11 :**
- Application 12 :**

ZOOM+

ZOOM-



PARTS IMAGE



BOX IMAGE

28250-RPC-003

SOLENOID TRANSMISSION

Parts Number : 28250-RPC-003

Manufacture 1 : KEIHIN

Manufacturer Number 1 :

Manufacture 2 :

Manufacture Number 2 :

M.S.R.P 04/2010 : \$203.48

Description: SOLENOID TRANSMISSION
MADE IN JAPAN #OEM

- Application 1 :** HONDA ACCORD 4D 03-06
- Application 2 :** HONDA ACCORD 4D 2007
- Application 3 :** HONDA ACCORD COUPE 03-06
- Application 4 :** HONDA ACCORD COUPE 2007
- Application 5 :** HONDA CIVIC 2D 06-09
- Application 6 :** HONDA CIVIC 4D 06-09
- Application 7 :** HONDA CIVIC 06-09
- Application 8 :** HONDA CR-V 02-09
- Application 9 :** HONDA ELEMENT 03-09
- Application 10 :** HONDA FIT 07-08
- Application 11 :**
- Application 12 :**

ZOOM+

ZOOM-



PARTS IMAGE



BOX IMAGE

28260-PRP-014

SOLENOID TRANSMISSION

Parts Number : 28260-PRP-014

Manufacture 1 : DENSO

Manufacturer Number 1 :

Manufacture 2 :

Manufacture Number 2 :

M.S.R.P 04/2010 : \$257.83

Description: SOLENOID TRANSMISSION
MADE IN JAPAN #OEM

Application 1 : HONDA ACCORD 4D 03-07

Application 2 : HONDA ACCORD COUPE 03-07

Application 3 : HONDA CR-V 02-09

Application 4 : HONDA ELEMENT 07-09

Application 5 :

Application 6 :

Application 7 :

Application 8 :

Application 9 :

Application 10 :

Application 11 :

Application 12 :

ZOOM+

ZOOM-



PARTS IMAGE



BOX IMAGE

28260-RDK-023

SOLENOID TRANSMISSION

Parts Number : 28260-RDK-023

Manufacture 1 : KEIHIN

Manufacturer Number 1 :

Manufacture 2 :

Manufacture Number 2 :

M.S.R.P 04/2010 : \$189.43

Description: SOLENOID TRANSMISSION
MADE IN JAPAN #GNTP

Application 1 : ACURA MDX 01-06

Application 2 : ACURA MDX 07-09

Application 3 : ACURA RL 05-09

Application 4 : ACURA TL 04-07

Application 5 : ACURA TL 08

Application 6 : HONDA ACCORD HYBRID 05-07

Application 7 : HONDA ODYSSEY 05-09

Application 8 : HONDA PILOT 03-07

Application 9 : HONDA PILOT 08

Application 10 : HONDA RIDGELINE 06-09

Application 11 :

Application 12 :

ZOOM+

ZOOM-



PARTS IMAGE



BOX IMAGE

28260-RDK-023G

SOLENOID TRANSMISSION

Parts Number : 28260-RDK-023G

Manufacture 1 :

Manufacturer Number 1 :

Manufacture 2 :

Manufacturer Number 2 :

M.S.R.P 04/2010 : \$189.43

Description: SOLENOID TRANSMISSION

- Application 1 :** ACURA MDX 01-06
- Application 2 :** ACURA MDX 07-09
- Application 3 :** ACURA RL 05-09
- Application 4 :** ACURA TL 04-07
- Application 5 :** ACURA TL 08
- Application 6 :** HONDA ACCORD HYBRID 05-07
- Application 7 :** HONDA ODYSSEY 05-09
- Application 8 :** HONDA PILOT 03-07
- Application 9 :** HONDA PILOT 08
- Application 10 :** HONDA RIDGELINE 06-09
- Application 11 :**
- Application 12 :**

ZOOM+ ZOOM-



PARTS IMAGE

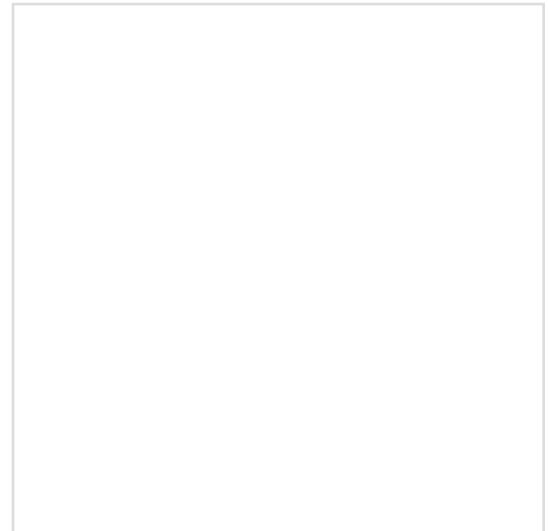

BOX IMAGE

28300-P24-J01G

SOLENOID TRANSMISSION

Parts Number : 28300-P24-J01G

Manufacture 1 : KEIHIN

Manufacturer Number 1 :

Manufacture 2 :

Manufacture Number 2 :

M.S.R.P 04/2010 :

Description: SOLENOID TRANSMISSION
MADE IN JAPAN #OEMNTP

Application 1 :

Application 2 :

Application 3 :

Application 4 :

Application 5 :

Application 6 :

Application 7 :

Application 8 :

Application 9 :

Application 10 :

Application 11 :

Application 12 :

ZOOM+ ZOOM-



PARTS IMAGE

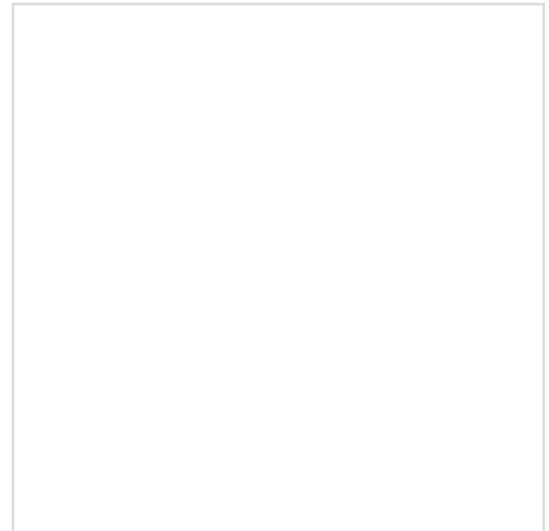

BOX IMAGE

28300-PK4-013

SOLENOID TRANSMISSION

Parts Number : 28300-PK4-013

Manufacture 1 :

Manufacturer Number 1 : 169

Manufacture 2 :

Manufacturer Number 2 :

M.S.R.P 04/2010 :

Description: SOLENOID TRANSMISSION
MADE IN JAPAN #OEMNTP

Application 1 :

Application 2 :

Application 3 :

Application 4 :

Application 5 :

Application 6 :

Application 7 :

Application 8 :

Application 9 :

Application 10 :

Application 11 :

Application 12 :

ZOOM+

ZOOM-



PARTS IMAGE

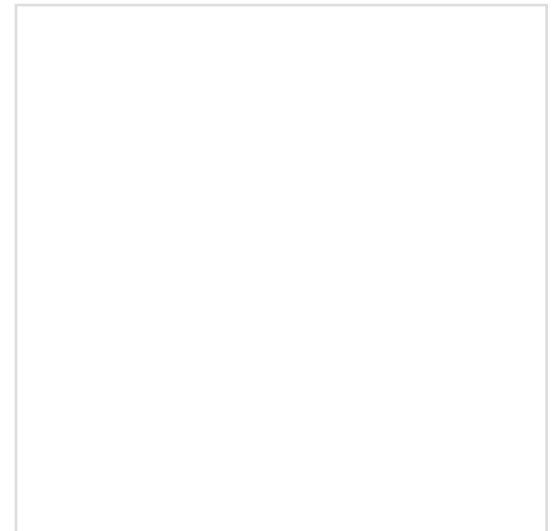

BOX IMAGE

28300-PK4-901

SOLENOID TRANSMISSION

Parts Number : 28300-PK4-901

Manufacture 1 :

Manufacturer Number 1 : 170

Manufacture 2 :

Manufacturer Number 2 :

M.S.R.P 04/2010 :

Description: SOLENOID TRANSMISSION
MADE IN JAPAN #OEMNTP

Application 1 :

Application 2 :

Application 3 :

Application 4 :

Application 5 :

Application 6 :

Application 7 :

Application 8 :

Application 9 :

Application 10 :

Application 11 :

Application 12 :

ZOOM+

ZOOM-

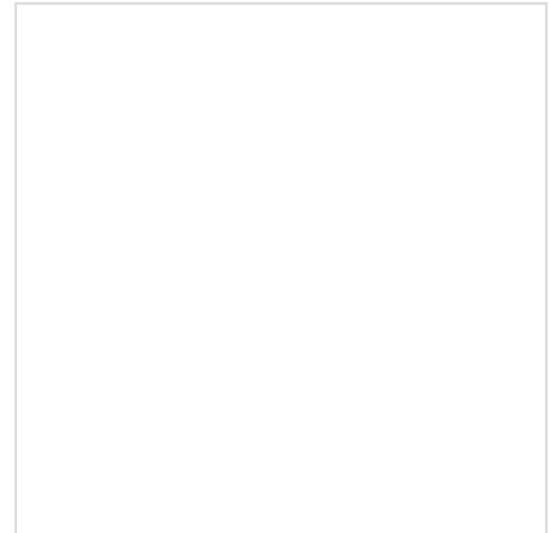

PARTS IMAGE

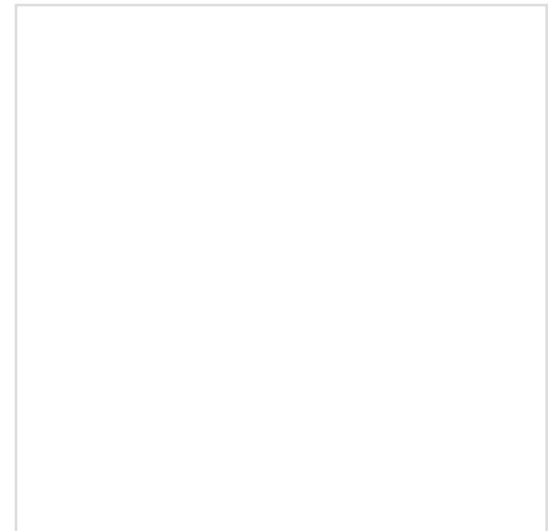

BOX IMAGE

28300-PL5-033

SOLENOID TRANSMISSION

Parts Number : 28300-PL5-033

Manufacture 1 :

Manufacturer Number 1 : 171

Manufacture 2 :

Manufacturer Number 2 :

M.S.R.P 04/2010 :

Description: SOLENOID TRANSMISSION
MADE IN JAPAN #OEMNTP

Application 1 :

Application 2 :

Application 3 :

Application 4 :

Application 5 :

Application 6 :

Application 7 :

Application 8 :

Application 9 :

Application 10 :

Application 11 :

Application 12 :

ZOOM+

ZOOM-



PARTS IMAGE

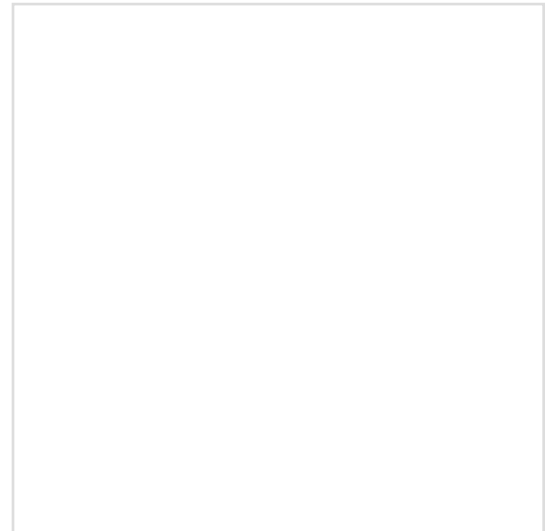

BOX IMAGE

28300-PR0-010

SOLENOID TRANSMISSION

Parts Number : 28300-PR0-010

Manufacture 1 :

Manufacturer Number 1 :

897

Manufacture 2 :

Manufacture Number 2 :

M.S.R.P 04/2010 :

Description:

SOLENOID TRANSMISSION

Application 1 :

Application 2 :

Application 3 :

Application 4 :

Application 5 :

Application 6 :

Application 7 :

Application 8 :

Application 9 :

Application 10 :

Application 11 :

Application 12 :

ZOOM+

ZOOM-

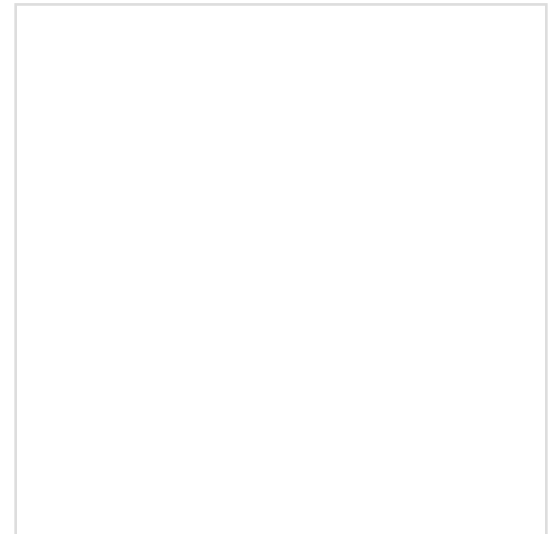

PARTS IMAGE

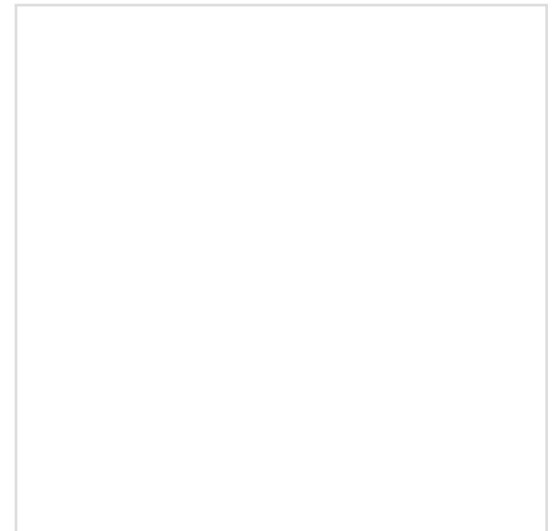

BOX IMAGE

28300-PX4-003G

SOLENOID TRANSMISSION

Parts Number : 28300-PX4-003G

Manufacture 1 : KEIHIN

Manufacturer Number 1 :

Manufacture 2 :

Manufacture Number 2 :

M.S.R.P 04/2010 : \$223.24

Description: SOLENOID TRANSMISSION
MADE IN JAPAN #GNTP

Application 1 : HONDA ACORD 2D 4D 90-93

Application 2 : HONDA ACCORD 2D 98-02

Application 3 : HONDA ACCORD 4D 02

Application 4 : HONDA ACCORD 4D 94-97 E2/V-6 E2

Application 5 : HONDA ACCORD 4D 98-01

Application 6 : HONDA ODYSSEY 95-98

Application 7 : HONDA PRELUDE 92-96

Application 8 : HONDA PRELUDE 97-01

Application 9 : ACURA CL 97-99

Application 10 :

Application 11 :

Application 12 :

ZOOM+

ZOOM-



PARTS IMAGE

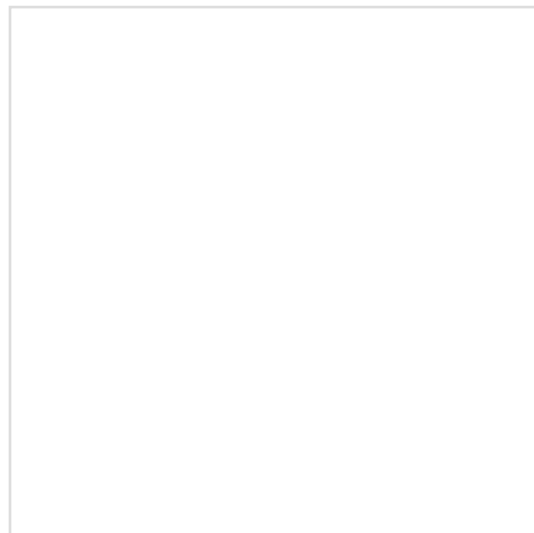

BOX IMAGE

28300-PX4-014

SOLENOID TRANSMISSION

Parts Number : 28300-PX4-014

Manufacture 1 : SHINDENGEN

Manufacturer Number 1 :

Manufacture 2 :

Manufacture Number 2 :

M.S.R.P 04/2010 : \$223.24

Description: SOLENOID TRANSMISSION
MADE IN JAPAN #OEM

- Application 1 :** HONDA ACCORD 2D 90-93
- Application 2 :** HONDA ACCORD 2D 94-97
- Application 3 :** HONDA ACCORD 4D 90-93
- Application 4 :** HONDA ACCORD 4D 94-97 E2/V-6 E2
- Application 5 :** HONDA ACCORD WAGON 91-93
- Application 6 :** HONDA ACCORD WAGON 94-97
- Application 7 :** HONDA PRELUDE 92-96
- Application 8 :**
- Application 9 :**
- Application 10 :**
- Application 11 :**
- Application 12 :**

ZOOM+ ZOOM-



PARTS IMAGE



BOX IMAGE

28300-PY4-013

SOLENOID TRANSMISSION

Parts Number : 28300-PY4-013

Manufacture 1 :

Manufacturer Number 1 : 173

Manufacture 2 :

Manufacture Number 2 :

M.S.R.P 04/2010 :

Description: SOLENOID TRANSMISSION
MADE IN JAPAN #OEMNTP

Application 1 :

Application 2 :

Application 3 :

Application 4 :

Application 5 :

Application 6 :

Application 7 :

Application 8 :

Application 9 :

Application 10 :

Application 11 :

Application 12 :

ZOOM+

ZOOM-

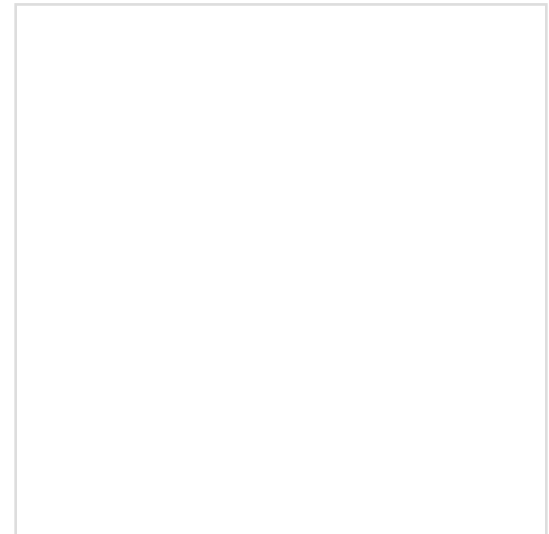

PARTS IMAGE

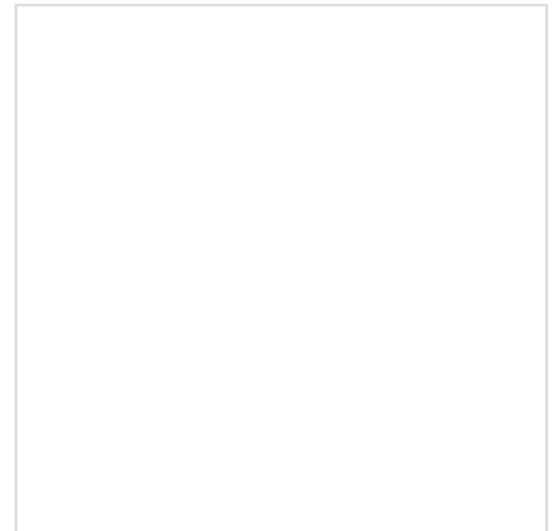

BOX IMAGE

28300-PY4-034

SOLENOID TRANSMISSION

Parts Number : 28300-PY4-034

Manufacture 1 : KEIHIN

Manufacturer Number 1 :

Manufacture 2 :

Manufacture Number 2 :

M.S.R.P 04/2010 :

Description: SOLENOID TRANSMISSION
MADE IN JAPAN #GNTP

Application 1 :

Application 2 :

Application 3 :

Application 4 :

Application 5 :

Application 6 :

Application 7 :

Application 8 :

Application 9 :

Application 10 :

Application 11 :

Application 12 :

ZOOM+ ZOOM-



PARTS IMAGE



BOX IMAGE

28300-PY4-034G

SOLENOID TRANSMISSION

Parts Number : 28300-PY4-034G

Manufacture 1 :

Manufacturer Number 1 :

Manufacture 2 :

Manufacturer Number 2 :

M.S.R.P 04/2010 :

Description: SOLENOID TRANSMISSION

Application 1 :

Application 2 :

Application 3 :

Application 4 :

Application 5 :

Application 6 :

Application 7 :

Application 8 :

Application 9 :

Application 10 :

Application 11 :

Application 12 :

ZOOM+

ZOOM-



PARTS IMAGE

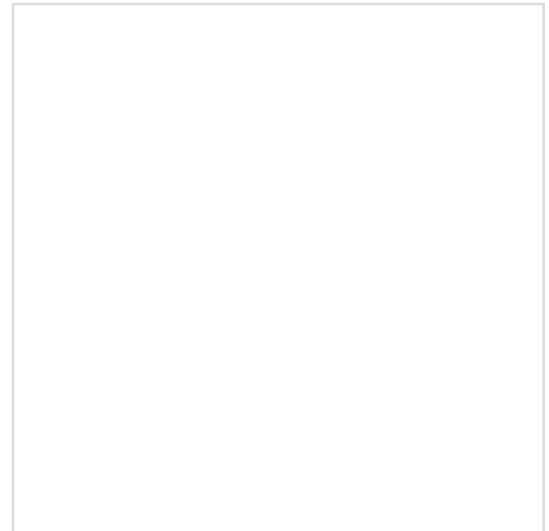

BOX IMAGE

28300-PY8-J10

SOLENOID TRANSMISSION

Parts Number : 28300-PY8-J10

Manufacture 1 :

Manufacturer Number 1 : 175

Manufacture 2 :

Manufacture Number 2 :

M.S.R.P 04/2010 :

Description: SOLENOID TRANSMISSION
MADE IN JAPAN #OEMNTP

Application 1 :

Application 2 :

Application 3 :

Application 4 :

Application 5 :

Application 6 :

Application 7 :

Application 8 :

Application 9 :

Application 10 :

Application 11 :

Application 12 :

ZOOM+

ZOOM-

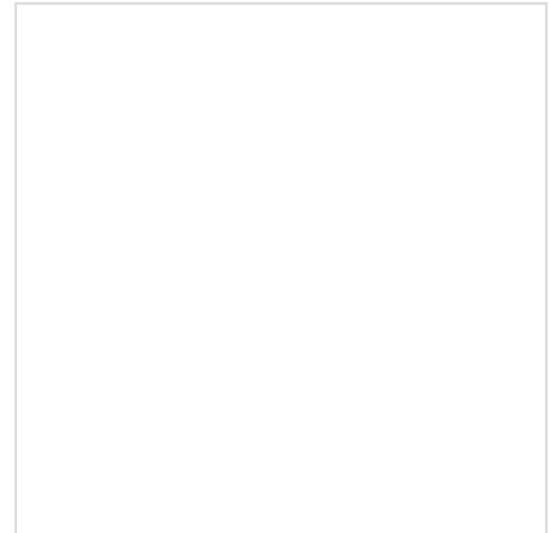

PARTS IMAGE

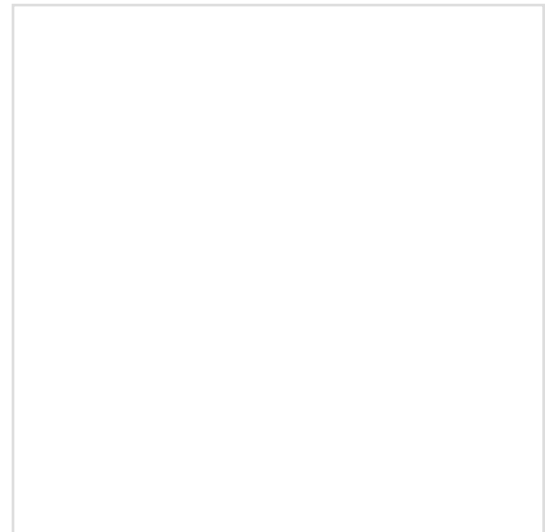

BOX IMAGE

28400-P6H-003 /013

SOLENOID TRANSMISSION

Parts Number : 28400-P6H-003 /013

Manufacture 1 : KEIHIN

Manufacturer Number 1 :

Manufacture 2 :

Manufacture Number 2 :

M.S.R.P 04/2010 : \$31.50

Description: SOLENOID TRANSMISSION
MADE IN JAPAN #OEM

- Application 1 :** HONDA ACCORD 2D 98-02
- Application 2 :** HONDA ACCORD 4D 02-06
- Application 3 :** HONDA ACCORD 98-01
- Application 4 :** HONDA ACCORD COUPE 03-06
- Application 5 :** HONDA CIVIC 2D 01-05
- Application 6 :** HONDA CIVIC 01-05
- Application 7 :** HONDA ODYSSEY 05-09
- Application 8 :** HONDA ODYSSEY 99-04
- Application 9 :** HONDA ODYSSEY 95-98
- Application 10 :** HONDA PILOT 03-07
- Application 11 :** HONDA PRELUDE 97-01
- Application 12 :**

ZOOM+

ZOOM-

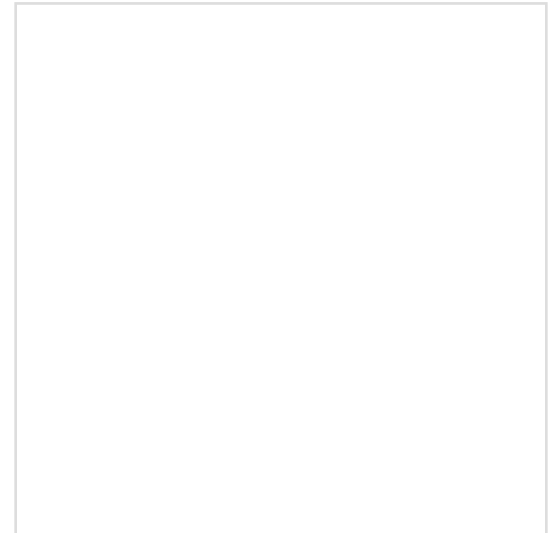

PARTS IMAGE

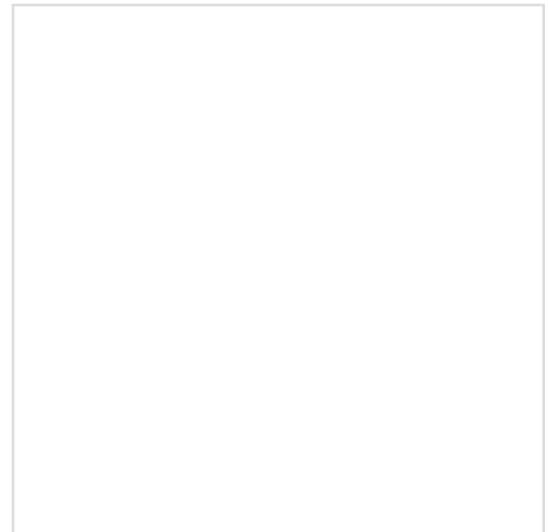

BOX IMAGE

28400-PRP-004

SOLENOID TRANSMISSION

Parts Number : 28400-PRP-004

Manufacture 1 :

Manufacturer Number 1 :

Manufacture 2 :

Manufacturer Number 2 :

M.S.R.P 04/2010 : \$89.30

Description: SOLENOID TRANSMISSION
MADE IN JAPAN #GNTP

Application 1 : HONDA ACCORD 2D 4D 08-09

Application 2 : HONDA ACCORD 4D COUPE 03-06 & 2007

Application 3 : HONDA CR-V 02-05

Application 4 : HONDA CR-V 06

Application 5 : HONDA CR-V 07-09

Application 6 : HONDA ELEMENT 07-09

Application 7 : ACURA RSK 02-05

Application 8 : ACURA RSK 06

Application 9 : ACURA TSX 09-10

Application 10 :

Application 11 :

Application 12 :

ZOOM+

ZOOM-



PARTS IMAGE



BOX IMAGE

28400-PRP-004G

SOLENOID TRANSMISSION

Parts Number : 28400-PRP-004G

Manufacture 1 :

Manufacturer Number 1 :

Manufacture 2 :

Manufacturer Number 2 :

M.S.R.P 04/2010 : \$89.30

Description: SOLENOID TRANSMISSION

Application 1 : HONDA ACCORD 2D 4D 08-09

Application 2 : HONDA ACCORD 4D COUPE 03-06 & 2007

Application 3 : HONDA CR-V 02-05

Application 4 : HONDA CR-V 06

Application 5 : HONDA CR-V 07-09

Application 6 : HONDA ELEMENT 07-09

Application 7 : ACURA RSK 02-05

Application 8 : ACURA RSK 06

Application 9 : ACURA TSX 09-10

Application 10 :

Application 11 :

Application 12 :



PARTS IMAGE

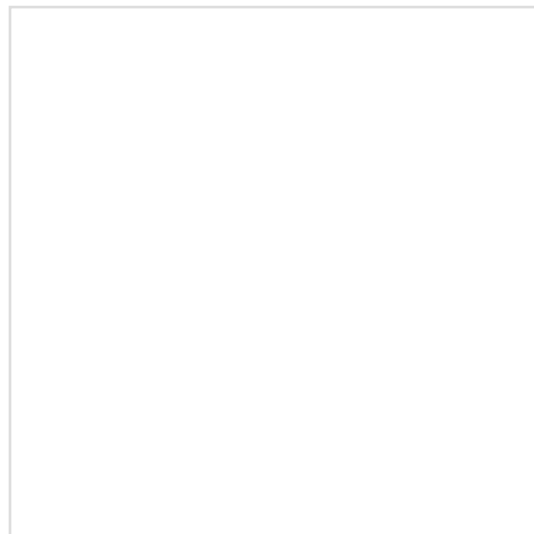

BOX IMAGE

28400-RDK-003

SOLENOID TRANSMISSION

Parts Number : 28400-RDK-003

Manufacture 1 :

Manufacturer Number 1 : 178

Manufacture 2 :

Manufacture Number 2 :

M.S.R.P 04/2010 :

Description: SOLENOID TRANSMISSION
MADE IN JAPAN #OEMNTP

Application 1 :

Application 2 :

Application 3 :

Application 4 :

Application 5 :

Application 6 :

Application 7 :

Application 8 :

Application 9 :

Application 10 :

Application 11 :

Application 12 :

ZOOM+

ZOOM-



PARTS IMAGE

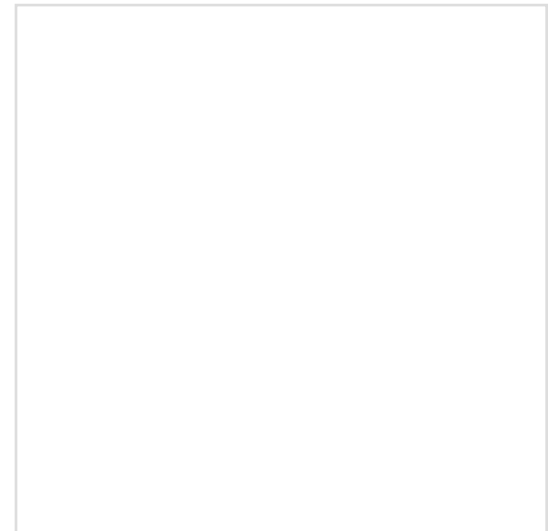

BOX IMAGE

28500-P6H-003/013

SOLENOID TRANSMISSION

Parts Number : 28500-P6H-003/013

Manufacture 1 : KEIHIN

Manufacturer Number 1 :

Manufacture 2 :

Manufacture Number 2 :

M.S.R.P 04/2010 : \$30.62

Description: SOLENOID TRANSMISSION
MADE IN JAPAN #OEMNTP

- Application 1 :** HONDA ACCORD 2D 98-02
- Application 2 :** HONDA ACCORD 4D 02-06
- Application 3 :** HONDA ACCORD 4D 98-01
- Application 4 :** HONDA ACCORD COUPE 03-06
- Application 5 :** HONDA ODYSSEY 05-09
- Application 6 :** HONDA ODYSSEY 99-04
- Application 7 :** HONDA ODYSSEY 95-98
- Application 8 :** HONDA PILOT 03-07
- Application 9 :** HONDA PREDE 97-01
- Application 10 :**
- Application 11 :**
- Application 12 :**

ZOOM+

ZOOM-

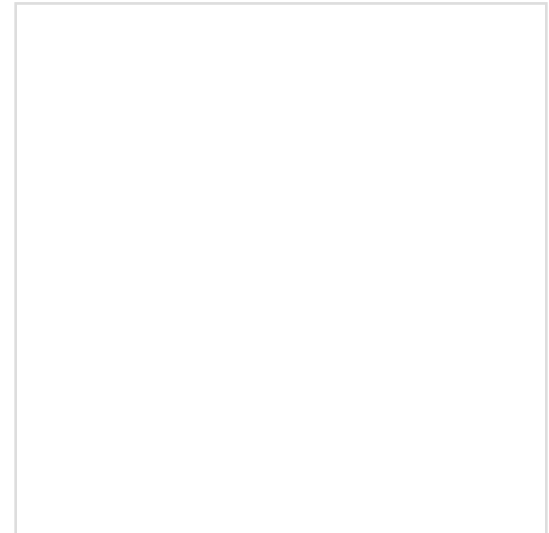

PARTS IMAGE

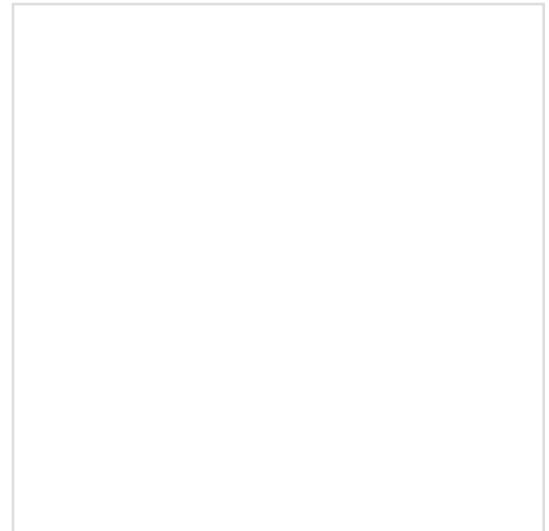

BOX IMAGE

28500-PRP-004

SOLENOID TRANSMISSION

Parts Number : 28500-PRP-004

Manufacture 1 :

Manufacturer Number 1 :

Manufacture 2 :

Manufacturer Number 2 :

M.S.R.P 04/2010 :

Description: SOLENOID TRANSMISSION
MADE IN JAPAN #OEMNTP

Application 1 :

Application 2 :

Application 3 :

Application 4 :

Application 5 :

Application 6 :

Application 7 :

Application 8 :

Application 9 :

Application 10 :

Application 11 :

Application 12 :

ZOOM+ ZOOM-



PARTS IMAGE



BOX IMAGE

28500-PRP-004G

SOLENOID TRANSMISSION

Parts Number : 28500-PRP-004G

Manufacture 1 :

Manufacturer Number 1 :

Manufacture 2 :

Manufacturer Number 2 :

M.S.R.P 04/2010 :

Description: SOLENOID TRANSMISSION
MADE IN JAPAN #GNTP

Application 1 :

Application 2 :

Application 3 :

Application 4 :

Application 5 :

Application 6 :

Application 7 :

Application 8 :

Application 9 :

Application 10 :

Application 11 :

Application 12 :

ZOOM+

ZOOM-



PARTS IMAGE

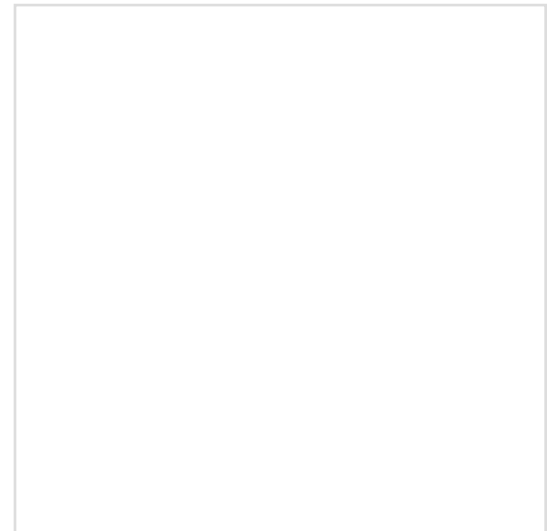

BOX IMAGE

28500-RDK-003

SOLENOID TRANSMISSION

Parts Number : 28500-RDK-003

Manufacture 1 :

Manufacturer Number 1 : 181

Manufacture 2 :

Manufacture Number 2 :

M.S.R.P 04/2010 :

Description: SOLENOID TRANSMISSION
MADE IN JAPAN #OEMNTP

Application 1 :

Application 2 :

Application 3 :

Application 4 :

Application 5 :

Application 6 :

Application 7 :

Application 8 :

Application 9 :

Application 10 :

Application 11 :

Application 12 :

ZOOM+

ZOOM-

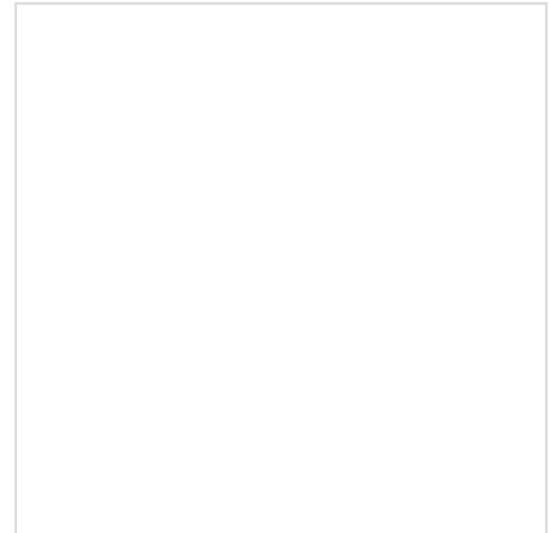

PARTS IMAGE

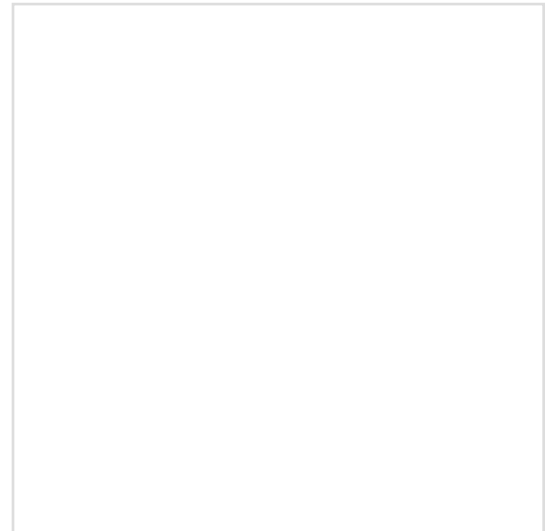

BOX IMAGE

28600-P6H-003

SWITCH OIL PRESSURE

Parts Number : 28600-P6H-003

Manufacture 1 : HITACHI

Manufacturer Number 1 : AX918CZB

Manufacture 2 :

Manufacture Number 2 :

M.S.R.P 04/2010 : \$67.23

Description: SWITCH OIL PRESSURE
MADE IN JAPAN #OEM

Application 1 : HONDA ACCORD 98-02

Application 2 : HONDA ACCORD 4D 2002

Application 3 : HONDA ACCORD 98-01

Application 4 : HONDA PRELUDE 97-01

Application 5 :

Application 6 :

Application 7 :

Application 8 :

Application 9 :

Application 10 :

Application 11 :

Application 12 :

ZOOM+ ZOOM-



PARTS IMAGE



BOX IMAGE

28600-P6H-003G

SWITCH OIL PRESSURE

Parts Number : 28600-P6H-003G

Manufacture 1 :

Manufacturer Number 1 :

Manufacture 2 :

Manufacturer Number 2 :

M.S.R.P 04/2010 : \$67.23

Description: SWITCH OIL PRESSURE
#GCHINA

Application 1 : HONDA ACCORD 98-02

Application 2 : HONDA ACCORD 4D 2002

Application 3 : HONDA ACCORD 98-01

Application 4 : HONDA PRELUDE 97-01

Application 5 :

Application 6 :

Application 7 :

Application 8 :

Application 9 :

Application 10 :

Application 11 :

Application 12 :

ZOOM+

ZOOM-



PARTS IMAGE

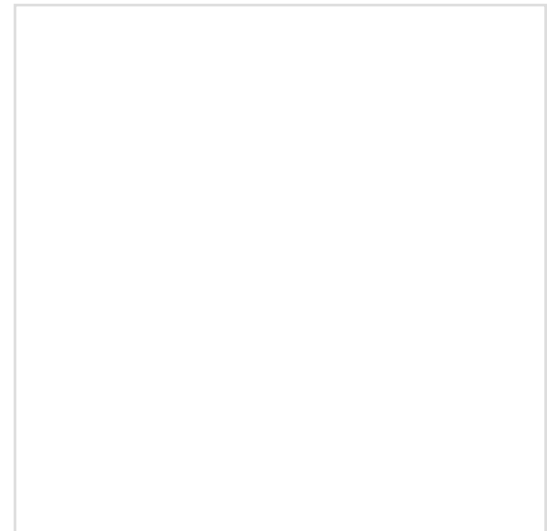

BOX IMAGE

28600-P7W-003

SWITCH OIL PRESSURE

Parts Number :	28600-P7W-003
Manufacture 1 :	HITACHI <input type="button" value="v"/>
Manufacturer Number 1 :	CR909CZB
Manufacture 2 :	<input type="button" value="v"/>
Manufacturer Number 2 :	
M.S.R.P 04/2010 :	\$57.60
Description:	SWITCH OIL PRESSURE MADE IN JAPAN #OEM

- Application 1 :** HONDA ODYSSEY 99-04
- Application 2 :** HONDA PILOT 03-07
- Application 3 :**
- Application 4 :**
- Application 5 :**
- Application 6 :**
- Application 7 :**
- Application 8 :**
- Application 9 :**
- Application 10 :**
- Application 11 :**
- Application 12 :**

ZOOM+ ZOOM-



PARTS IMAGE



BOX IMAGE

28600-P7Z-003

SWITCH OIL PRESSURE

Parts Number : 28600-P7Z-003

Manufacture 1 : HITACHI

Manufacturer Number 1 : BV931CZB

Manufacture 2 :

Manufacture Number 2 :

M.S.R.P 04/2010 : \$62.68

Description: SWITCH OIL PRESSURE
MADE IN JAPAN #OEM

Application 1 : HONDA ACCORD 2D 98-02

Application 2 : HONDA ACCORD 4D 2002

Application 3 : HONDA ODYSSEY 99-04

Application 4 : HONDA PILOT 03-07

Application 5 :

Application 6 :

Application 7 :

Application 8 :

Application 9 :

Application 10 :

Application 11 :

Application 12 :

ZOOM+ ZOOM-



PARTS IMAGE



BOX IMAGE

28600-PRP-004

SWITCH OIL PRESSURE

Parts Number : 28600-PRP-004

Manufacture 1 :

Manufacturer Number 1 : 183

Manufacture 2 :

Manufacture Number 2 :

M.S.R.P 04/2010 : \$42.30

Description: SWITCH OIL PRESSURE
MADE IN JAPAN #OEMNTP

Application 1 : HONDA CR-V 02-05

Application 2 : HONDA ODYSSEY 95-98

Application 3 :

Application 4 :

Application 5 :

Application 6 :

Application 7 :

Application 8 :

Application 9 :

Application 10 :

Application 11 :

Application 12 :

ZOOM+ ZOOM-



PARTS IMAGE



BOX IMAGE

28600-RAY-003

SWITCH OIL PRESSURE

Parts Number :	28600-RAY-003
Manufacture 1 :	TEXAS INSTRUMENTS <input type="button" value="v"/>
Manufacturer Number 1 :	FH014CZB
Manufacture 2 :	<input type="button" value="v"/>
Manufacturer Number 2 :	
M.S.R.P 04/2010 :	\$44.68
Description:	SWITCH OIL PRESSURE MADE IN JAPAN #OEMNTP

- Application 1 :** HONDA ACCORD 4D 03-07
- Application 2 :** HONDA ACCORD COUPE 03-07
- Application 3 :** HONDA ACCORD HYBRID 05-07
- Application 4 :** HONDA PILOT 03-08
- Application 5 :** HONDA RIDGELINE 06-09
- Application 6 :**
- Application 7 :**
- Application 8 :**
- Application 9 :**
- Application 10 :**
- Application 11 :**
- Application 12 :**

ZOOM+ ZOOM-



PARTS IMAGE



BOX IMAGE

28600-RAY-003G

SWITCH OIL PRESSURE

Parts Number : 28600-RAY-003G

Manufacture 1 :

Manufacturer Number 1 :

Manufacture 2 :

Manufacturer Number 2 :

M.S.R.P 04/2010 : \$44.68

Description: SWITCH OIL PRESSURE

Application 1 : HONDA ACCORD 4D 03-07

Application 2 : HONDA ACCORD COUPE 03-07

Application 3 : HONDA ACCORD HYBRID 05-07

Application 4 : HONDA PILOT 03-08

Application 5 : HONDA RIDGELINE 06-09

Application 6 :

Application 7 :

Application 8 :

Application 9 :

Application 10 :

Application 11 :

Application 12 :

ZOOM+

ZOOM-



PARTS IMAGE

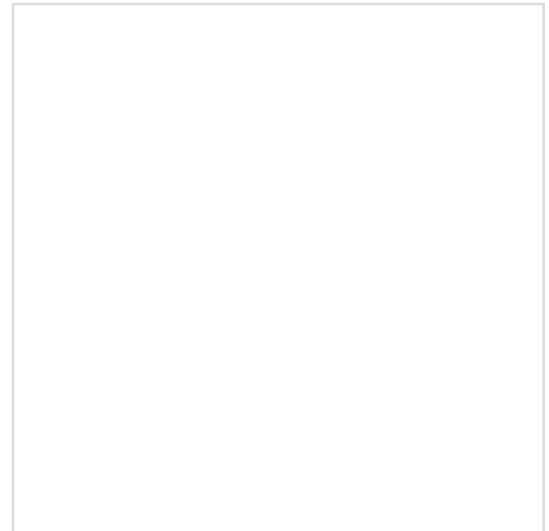

BOX IMAGE

28600-RCL-004

SWITCH OIL PRESSURE

Parts Number : 28600-RCL-004

Manufacture 1 : SAGINOMIYA

Manufacturer Number 1 :

Manufacture 2 :

Manufacture Number 2 :

M.S.R.P 04/2010 : \$44.68

Description: SWITCH OIL PRESSURE
MADE IN JAPAN #GNTP

Application 1 : HONDA ACCORD 4D 03-07

Application 2 : HONDA ACCORD COUPE 03-07

Application 3 : HONDA CR-V 02-06

Application 4 : HONDA ELEMENT 03-06

Application 5 :

Application 6 :

Application 7 :

Application 8 :

Application 9 :

Application 10 :

Application 11 :

Application 12 :

ZOOM+

ZOOM-



PARTS IMAGE



BOX IMAGE

28600-RKE-004

SWITCH OIL PRESSURE

Parts Number : 28600-RKE-004

Manufacture 1 :

Manufacturer Number 1 :

Manufacture 2 :

Manufacturer Number 2 :

M.S.R.P 04/2010 : \$44.97

Description: SWITCH OIL PRESSURE
MADE IN JAPAN #GNTP

Application 1 : HONDA ODYSSEY 05-09

Application 2 :

Application 3 :

Application 4 :

Application 5 :

Application 6 :

Application 7 :

Application 8 :

Application 9 :

Application 10 :

Application 11 :

Application 12 :

ZOOM+ ZOOM-



PARTS IMAGE



BOX IMAGE

28610-PRH-003

SWITCH OIL PRESSURE

Parts Number : 28610-PRH-003

Manufacture 1 : 28610-RAY-003

Manufacturer Number 1 : 187

Manufacture 2 :

Manufacture Number 2 :

M.S.R.P 04/2010 :

Description: SWITCH OIL PRESSURE
MADE IN JAPAN #OEMNTP

Application 1 : HONDA CR-V 02-05

Application 2 :

Application 3 :

Application 4 :

Application 5 :

Application 6 :

Application 7 :

Application 8 :

Application 9 :

Application 10 :

Application 11 :

Application 12 :

ZOOM+

ZOOM-

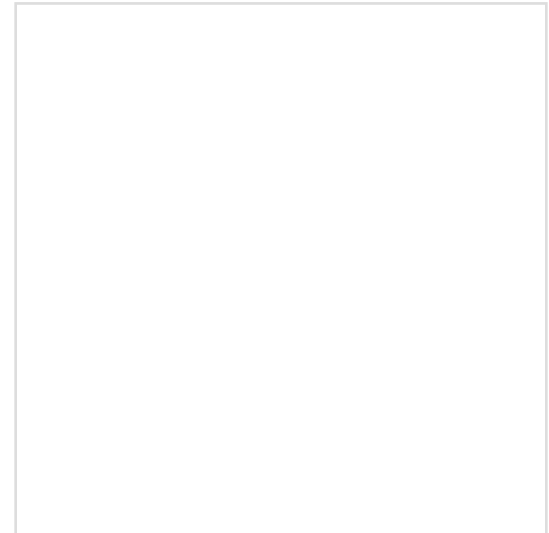

PARTS IMAGE

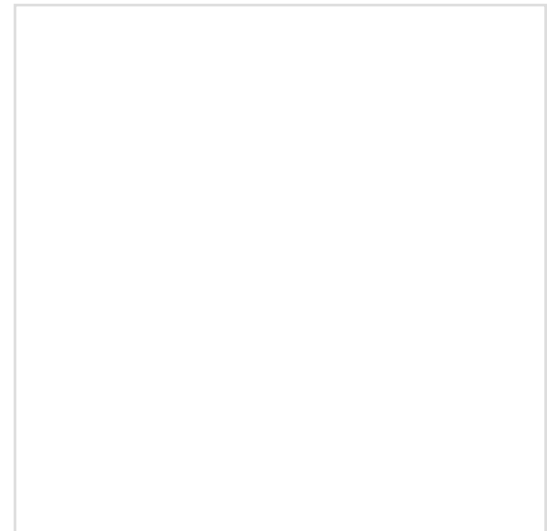

BOX IMAGE

28610-RAY-003

SWITCH OIL PRESSURE

Parts Number : 28610-RAY-003

Manufacture 1 :

Manufacturer Number 1 : 188

Manufacture 2 :

Manufacture Number 2 :

M.S.R.P 04/2010 : \$44.68

Description: SWITCH OIL PRESSURE
#GCHINA

Application 1 : HONDA ACCORD 4D 03-07

Application 2 : HONDA ACCORD COUPE 03-07

Application 3 : HONDA ACCORD HYBRID 05-07

Application 4 : HONDA CR-V 02-05

Application 5 : HONDA ELEMENT 03-06

Application 6 : HONDA PILOT 03-08

Application 7 : HONDA RIDGELINE 06-09

Application 8 :

Application 9 :

Application 10 :

Application 11 :

Application 12 :

ZOOM+

ZOOM-



PARTS IMAGE



BOX IMAGE

28610-RKE-004

SWITCH OIL PRESSURE

Parts Number : 28610-RKE-004

Manufacture 1 : SAGINOMIYA

Manufacturer Number 1 :

Manufacture 2 :

Manufacturer Number 2 :

M.S.R.P 04/2010 :

Description: SWITCH OIL PRESSURE
MADE IN JAPAN #GNTP

Application 1 : HONDA ODYSSEY 05-09

Application 2 :

Application 3 :

Application 4 :

Application 5 :

Application 6 :

Application 7 :

Application 8 :

Application 9 :

Application 10 :

Application 11 :

Application 12 :

ZOOM+

ZOOM-



PARTS IMAGE



BOX IMAGE

28810-P0X-004

PICK UP ASSY MAIN

Parts Number : 28810-P0X-004

Manufacture 1 : TEC TOYO

Manufacturer Number 1 : 40T09852A1

Manufacture 2 :

Manufacturer Number 2 :

M.S.R.P 04/2010 : \$105.92

Description: PICK UP ASSY MAIN
MADE IN JAPAN #OEM

Application 1 : HONDA ACCORD 2D 94-97

Application 2 : HONDA ACCORD 4D 94-97 E2/V-6 E2

Application 3 : HONDA ACCORD WAGON 94-97

Application 4 : HONDA ODYSSEY 95-98

Application 5 :

Application 6 :

Application 7 :

Application 8 :

Application 9 :

Application 10 :

Application 11 :

Application 12 :

ZOOM+

ZOOM-



PARTS IMAGE



BOX IMAGE

28810-P0X-005

PICK UP ASSY MAIN

Parts Number : 28810-P0X-005

Manufacture 1 : SHINDENGEN

Manufacturer Number 1 :

Manufacture 2 :

Manufacture Number 2 :

M.S.R.P 04/2010 : \$107.20

Description: PICK UP ASSY MAIN
MADE IN JAPAN #G

Application 1 : HONDA ACCORD 4D 94-97 E2 V6 E2

Application 2 : HONDA ODYSSEY 95-98

Application 3 :

Application 4 :

Application 5 :

Application 6 :

Application 7 :

Application 8 :

Application 9 :

Application 10 :

Application 11 :

Application 12 :

ZOOM+

ZOOM-



PARTS IMAGE

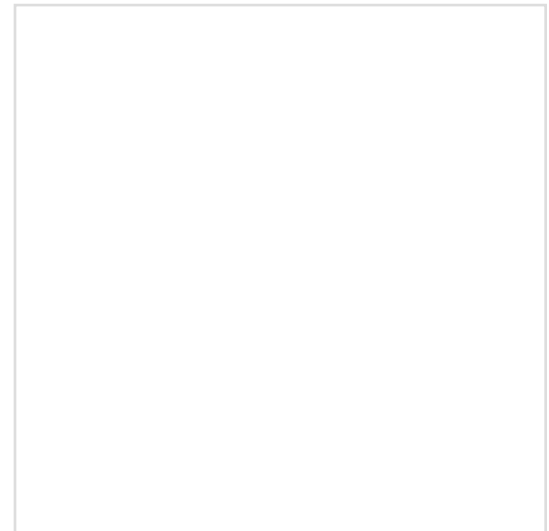

BOX IMAGE

28810-PX4-024

PICK UP ASSY MAIN

Parts Number : 28810-PX4-024

Manufacture 1 : TEC TOYO

Manufacturer Number 1 :

Manufacture 2 :

Manufacture Number 2 :

M.S.R.P 04/2010 : \$107.20

Description: PICK UP ASSY MAIN
MADE IN JAPAN #G

Application 1 : HONDA ACCORD 2D 90-93

Application 2 : HONDA ACCORD 4D 90-93

Application 3 : HONDA ACCORD WAGON 91-93

Application 4 : HONDA PRELUDE 92-96

Application 5 :

Application 6 :

Application 7 :

Application 8 :

Application 9 :

Application 10 :

Application 11 :

Application 12 :

ZOOM+

ZOOM-



PARTS IMAGE

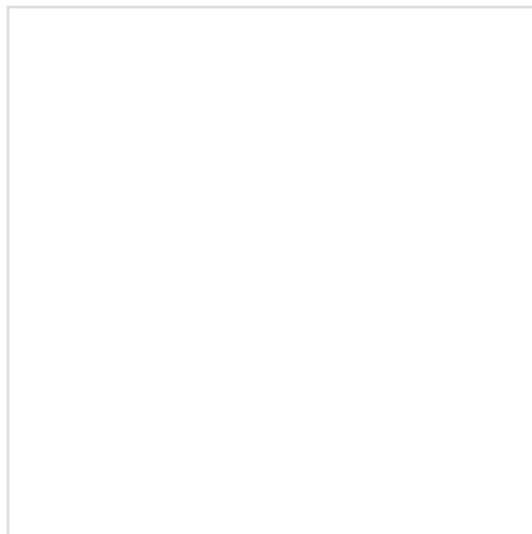

BOX IMAGE

30120-PR7-A01

IGNITER

Parts Number : 30120-PR7-A01

Manufacture 1 : HONDA ELESYS

Manufacturer Number 1 :

Manufacture 2 :

Manufacture Number 2 :

M.S.R.P 04/2010 : \$315.92

Description: IGNITER
MADE IN JAPAN #OEM

Application 1 : ACURA LEGEND 2D 91-94

Application 2 : ACURA LEGEND 4D 91-94

Application 3 : ACURA NSX 91-92

Application 4 : ACURA LEGEND 1995

Application 5 : ACURA TL 3.2L 96-98

Application 6 : ACURA RL 3.5L 96-04

Application 7 :

Application 8 :

Application 9 :

Application 10 :

Application 11 :

Application 12 :

ZOOM+

ZOOM-



PARTS IMAGE

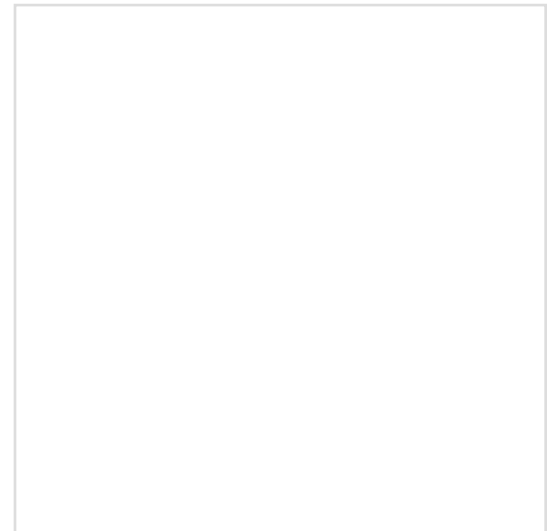

BOX IMAGE

30500-PM5-A03

IGNITION COIL MADE IN

Parts Number : 30500-PM5-A03

Manufacture 1 : TEC TOYO

Manufacturer Number 1 : TC-05A

Manufacture 2 :

Manufacture Number 2 :

M.S.R.P 04/2010 : \$122.23

Description: IGNITION COIL MADE IN JAPAN
#OEMNTP

Application 1 : HONDA CIVIC 3D 88-91

Application 2 : HONDA CIVC 4D 88-91

Application 3 : HONDA CRX 88-91

Application 4 : HONDA CRX 88-91

Application 5 :

Application 6 :

Application 7 :

Application 8 :

Application 9 :

Application 10 :

Application 11 :

Application 12 :

ZOOM+

ZOOM-



PARTS IMAGE



BOX IMAGE

30500-PR4-A02

IGNITION COIL MADE IN

Parts Number : 30500-PR4-A02

Manufacture 1 : TEC TOYO

Manufacturer Number 1 : TC-07A

Manufacture 2 :

Manufacturer Number 2 :

M.S.R.P 04/2010 : \$116.68

Description: IGNITION COIL MADE IN JAPAN
#OEMNTP

Application 1 : HONDA CIVIC 3D 88-91

Application 2 : HONDA CIVIC 4D 88-91

Application 3 : HONDA CIVIC WAGON 88-91

Application 4 :

Application 5 :

Application 6 :

Application 7 :

Application 8 :

Application 9 :

Application 10 :

Application 11 :

Application 12 :

ZOOM+

ZOOM-



PARTS IMAGE



BOX IMAGE

30510-PT2-006

IGNITION COIL MADE IN

Parts Number : 30510-PT2-006

Manufacture 1 : TEC TOYO

Manufacturer Number 1 : TC-08A

Manufacture 2 :

Manufacturer Number 2 :

M.S.R.P 04/2010 : \$119.55

Description: IGNITION COIL MADE IN JAPAN
#OEMNTP

Application 1 : HONDA ACCORD 2D 90-93

Application 2 : HONDA ACCORD 4D 02

Application 3 : HONDA ACCORD 4D 90-93

Application 4 : HONDA ACCORD 4D 98-01

Application 5 : HONDA CIVIC 2D 93-95

Application 6 : HONDA CIVIC 2D 3D 96-00

Application 7 : HONDA CIVIC 3D4 D 92-95

Application 8 : HONDA CIVIC 4D 96-97 US 96-00 EXP

Application 9 : HONDA CIVIC 4D 98-00

Application 10 : HONDA CR-V 97-01

Application 11 : HONDA DEL SOL 93-97

Application 12 :

ZOOM+

ZOOM-



PARTS IMAGE



BOX IMAGE

30520-PH7-016

IGNITION COIL MADE IN

Parts Number : 30520-PH7-016

Manufacture 1 : TEC TOYO

Manufacturer Number 1 : TC-04A

Manufacture 2 :

Manufacture Number 2 :

M.S.R.P 04/2010 : \$94.17

Description: IGNITION COIL MADE IN JAPAN
#OEMNTP

Application 1 : ACURA LEGEND 2D 87-90

Application 2 : ACURA LEGEND 4D 86-90

Application 3 :

Application 4 :

Application 5 :

Application 6 :

Application 7 :

Application 8 :

Application 9 :

Application 10 :

Application 11 :

Application 12 :

ZOOM+

ZOOM-



PARTS IMAGE



BOX IMAGE

30520-PY3-006

IGNITION COIL MADE IN

Parts Number : 30520-PY3-006

Manufacture 1 : TEC TOYO

Manufacturer Number 1 : TC-16A

Manufacture 2 :

Manufacturer Number 2 :

M.S.R.P 04/2010 : \$118.05

Description: IGNITION COIL MADE IN JAPAN
#OEMNTP

Application 1 : ACURA LEGEND 2D 91-95

Application 2 : ACURA LEGEND 4D 91-95

Application 3 :

Application 4 :

Application 5 :

Application 6 :

Application 7 :

Application 8 :

Application 9 :

Application 10 :

Application 11 :

Application 12 :

ZOOM+

ZOOM-



PARTS IMAGE



BOX IMAGE

30520-RCA-A02

IGNITION COIL

Parts Number : 30520-RCA-A02

Manufacture 1 : HITACHI

Manufacturer Number 1 : CM11-207A

Manufacture 2 :

Manufacture Number 2 :

M.S.R.P 04/2010 : \$90.90

Description: IGNITION COIL
MADE IN JAPAN #OEM

Application 1 : HONDA ACCORD 4D 03-06

Application 2 : HONDA ACCORD 4D 07

Application 3 : HONDA ACCORD COUPE 03-06

Application 4 : HONDA ACCORD COUPE 07

Application 5 : HONDA ACCORD HYBRID 05-07

Application 6 : HONDA ODYSSEY 05-09

Application 7 : HONDA ODYSSEY 99-04

Application 8 : AUCRA TL 04-08

Application 9 : ACURA RL 05-08

Application 10 :

Application 11 :

Application 12 :

ZOOM+ ZOOM-



PARTS IMAGE



BOX IMAGE

30530-P2M-A01

SENSOR KNOCK

Parts Number :	30530-P2M-A01
Manufacture 1 :	PANASONIC / MATSUSHITA <input type="button" value="v"/>
Manufacturer Number 1 :	CY-SH5550(M/140 93K)
Manufacture 2 :	<input type="button" value="v"/>
Manufacturer Number 2 :	
M.S.R.P 04/2010 :	\$167.10
Description:	SENSOR KNOCK MADE IN JAPAN #OEM

- Application 1 :** HONDA CIVIC 96-00
- Application 2 :** HONDA 4D 96-97(US) 96-00(EXP)
- Application 3 :** HONDA CIVIC 4D 98-00
- Application 4 :** HONDA DEL SOL 93.97
- Application 5 :** ACURA RL 3.5L LEFT 98-04
- Application 6 :**
- Application 7 :**
- Application 8 :**
- Application 9 :**
- Application 10 :**
- Application 11 :**
- Application 12 :**

ZOOM+ ZOOM-



PARTS IMAGE



BOX IMAGE

30530-P5M-013

KNOCK SENSOR

Parts Number :	30530-P5M-013
Manufacture 1 :	PANASONIC / MATSUCHITA <input type="button" value="v"/>
Manufacturer Number 1 :	CY-SH1750A(M/120 92Z)
Manufacture 2 :	<input type="button" value="v"/>
Manufacturer Number 2 :	
M.S.R.P 04/2010 :	\$167.10
Description:	KNOCK SENSOR MADE IN JAPAN #OEM

- Application 1 :** HONDA ACCORD 2D 98-02
- Application 2 :** HONDA ACCORD 4D 2002
- Application 3 :** HONDA ACCORD 4D 98-01
- Application 4 :** HONDA ODYSSEY 95-98
- Application 5 :** HONDA PRELUDE 97-01
- Application 6 :** ACURA CL 2.3L
- Application 7 :**
- Application 8 :**
- Application 9 :**
- Application 10 :**
- Application 11 :**
- Application 12 :**

ZOOM+ ZOOM-



PARTS IMAGE



BOX IMAGE

30530-PR7-A01

SENSOR KNOCK

Parts Number :	30530-PR7-A01
Manufacture 1 :	PANASONIC / MATSUCHITA <input type="button" value="v"/>
Manufacturer Number 1 :	CY-SH6050A(M/115 96A)
Manufacture 2 :	<input type="button" value="v"/>
Manufacturer Number 2 :	
M.S.R.P 04/2010 :	\$167.10
Description:	SENSOR KNOCK MADE IN JAPAN #OEM

- Application 1 :** ACURA LEGEND 91-94
- Application 2 :** ACURA NSX 91-92
- Application 3 :** ACURA LEGEND
- Application 4 :** ACURA TL 3.2L 96-98
- Application 5 :** ACURA RL 3.5L 96-97
- Application 6 :** ACURA RL 3.5L 98-04
- Application 7 :**
- Application 8 :**
- Application 9 :**
- Application 10 :**
- Application 11 :**
- Application 12 :**

ZOOM+ ZOOM-



PARTS IMAGE



BOX IMAGE

30530-PV1-A01

SENSOR KNOCK

Parts Number :	30530-PV1-A01
Manufacture 1 :	PANASONIC / MATSUSHITA <input type="button" value="v"/>
Manufacturer Number 1 :	CY-SH1050A(M/120 97Z)
Manufacture 2 :	<input type="button" value="v"/>
Manufacturer Number 2 :	
M.S.R.P 04/2010 :	\$167.10
Description:	SENSOR KNOCK MADE IN JAPAN #OEM

- Application 1 :** HONDA CIVIC 2D 96-00
- Application 2 :** HONDA DEL SOL 93-97
- Application 3 :** HONDA PRELUDE 92-96
- Application 4 :** ACURA INTEGRA 1.7L 92-93
- Application 5 :** ACURA VIGOR 92-94
- Application 6 :** ACURA INTEGRA GS-R TYPE R 94-01
- Application 7 :**
- Application 8 :**
- Application 9 :**
- Application 10 :**
- Application 11 :**
- Application 12 :**

ZOOM+ ZOOM-



PARTS IMAGE



BOX IMAGE

31100-PND-004

NPW ALTERNATOR MADE IN

Parts Number :	31100-PND-004
Manufacture 1 :	MITSUBISHI <input type="button" value="v"/>
Manufacturer Number 1 :	A2TB7591
Manufacture 2 :	<input type="button" value="v"/>
Manufacturer Number 2 :	
M.S.R.P 04/2010 :	
Description:	NPW ALTERNATOR MADE IN JAPANMITSUBA

- Application 1 :
- Application 2 :
- Application 3 :
- Application 4 :
- Application 5 :
- Application 6 :
- Application 7 :
- Application 8 :
- Application 9 :
- Application 10 :
- Application 11 :
- Application 12 :

ZOOM+ ZOOM-



PARTS IMAGE



BOX IMAGE

31100-RAA-A05

ALTERNATOR

Parts Number : 31100-RAA-A05

Manufacture 1 : DENSO

Manufacturer Number 1 : 104210-3293

Manufacture 2 :

Manufacturer Number 2 :

M.S.R.P 04/2010 : \$314.02

Description: ALTERNATOR
MADE IN JAPAN #G

Application 1 : HONDA ACCORD 4D 03-06

Application 2 : HONDA ACCORD COUPE 03-06

Application 3 : HONDA ELEMENT 03-06

Application 4 : ACURA TSX 04-05

Application 5 :

Application 6 :

Application 7 :

Application 8 :

Application 9 :

Application 10 :

Application 11 :

Application 12 :

ZOOM+

ZOOM-



PARTS IMAGE

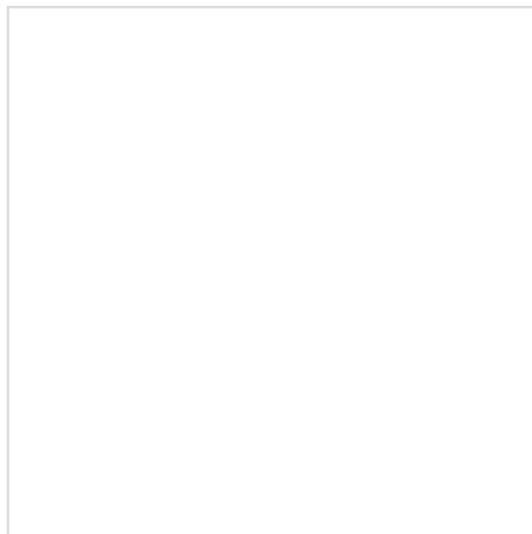

BOX IMAGE

31100-RCB-Y02

ALTERNATOR

Parts Number :	31100-RCB-Y02
Manufacture 1 :	DENSO <input type="button" value="v"/>
Manufacturer Number 1 :	104210-4481
Manufacture 2 :	<input type="button" value="v"/>
Manufacturer Number 2 :	
M.S.R.P 04/2010 :	\$1,095.20
Description:	ALTERNATOR MADE IN JAPAN #G

- Application 1 :** HONDA ACCORD 4D 3.0L 03-06
- Application 2 :** HONDA ACCORD 4D 07
- Application 3 :** HONDA ACCORD COUPE 03-06
- Application 4 :** HONDA ACCORD COUPE 2007
- Application 5 :**
- Application 6 :**
- Application 7 :**
- Application 8 :**
- Application 9 :**
- Application 10 :**
- Application 11 :**
- Application 12 :**

ZOOM+ ZOOM-



PARTS IMAGE

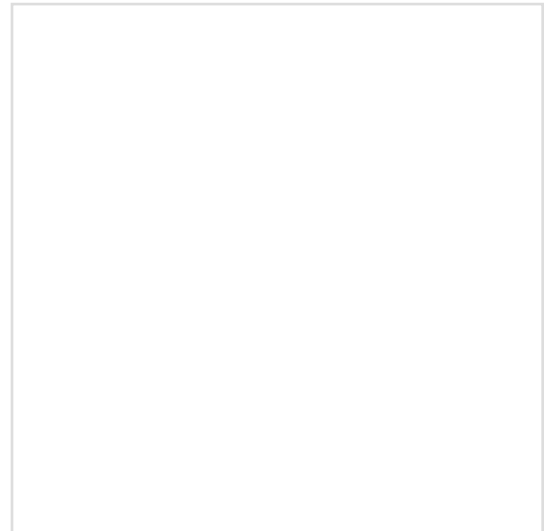

BOX IMAGE

31100-RJJ-004

NPW ALTERNATOR MADE IN

Parts Number : 31100-RJJ-004

Manufacture 1 : MITSUBISHI

Manufacturer Number 1 : A2TC0691

Manufacture 2 :

Manufacture Number 2 :

M.S.R.P 04/2010 :

Description: NPW ALTERNATOR MADE IN JAPAN

Application 1 :

Application 2 :

Application 3 :

Application 4 :

Application 5 :

Application 6 :

Application 7 :

Application 8 :

Application 9 :

Application 10 :

Application 11 :

Application 12 :

ZOOM+ ZOOM-



PARTS IMAGE



BOX IMAGE

31100-RTA-023

ALTERNATOR

Parts Number : 31100-RTA-023

Manufacture 1 : DENSO

Manufacturer Number 1 : 42800-4980

Manufacture 2 :

Manufacturer Number 2 :

M.S.R.P 04/2010 : \$300.47

Description: ALTERNATOR
MADE IN JAPAN #G

- Application 1 :** HONDA ACCORD 4D 03-06
- Application 2 :** HONDA ACCORD 4D 2007
- Application 3 :** HONDA ACCORD COUPE 03-06
- Application 4 :** HONDA ACCORD COUPE 2007
- Application 5 :** HONDA CIVIC 2D 06-09
- Application 6 :** HONDA CIVIC 4D 06-08
- Application 7 :** HONDA CIVIC 4D 2009
- Application 8 :** HONDA CR-V 07-09
- Application 9 :** HONDA ELEMENT 07-09
- Application 10 :** ACURA TSX 06-08
- Application 11 :**
- Application 12 :**

ZOOM+

ZOOM-



PARTS IMAGE

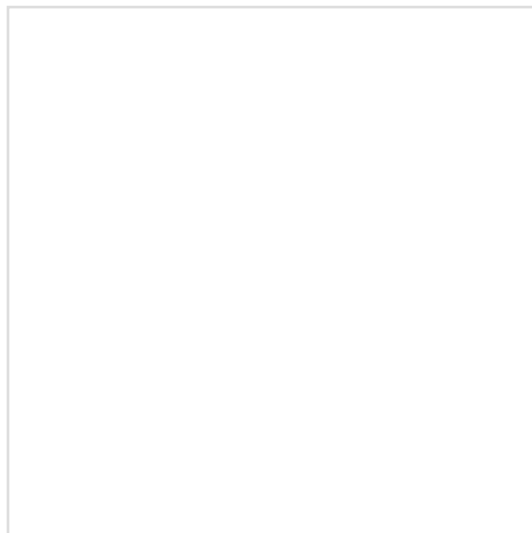

BOX IMAGE

31200-P8A-A01

STARTER MADE IN JAPAN

Parts Number : 31200-P8A-A01

Manufacture 1 : MITSUBA

Manufacturer Number 1 : 53131-002 / SM-44201

Manufacture 2 :

Manufacturer Number 2 :

M.S.R.P 04/2010 :

Description: STARTER MADE IN JAPAN
#OEMNTP

Application 1 :

Application 2 :

Application 3 :

Application 4 :

Application 5 :

Application 6 :

Application 7 :

Application 8 :

Application 9 :

Application 10 :

Application 11 :

Application 12 :

ZOOM+ ZOOM-



PARTS IMAGE



BOX IMAGE

31200-PAA-A02

STARTER MADE IN JAPAN

Parts Number : 31200-PAA-A02

Manufacture 1 : MITSUBA

Manufacturer Number 1 : 53136-002 / SM-44202

Manufacture 2 :

Manufacturer Number 2 :

M.S.R.P 04/2010 :

Description: STARTER MADE IN JAPAN
#OEMNTP

Application 1 :

Application 2 :

Application 3 :

Application 4 :

Application 5 :

Application 6 :

Application 7 :

Application 8 :

Application 9 :

Application 10 :

Application 11 :

Application 12 :

ZOOM+ ZOOM-



PARTS IMAGE



BOX IMAGE

31200-PKB-004

STARTER MADE IN JAPAN

Parts Number : 31200-PKB-004

Manufacture 1 : MITSUBA

Manufacturer Number 1 : 53172-002 / SM44242

Manufacture 2 :

Manufacturer Number 2 :

M.S.R.P 04/2010 :

Description: STARTER MADE IN JAPAN
#OEMNTP

Application 1 :

Application 2 :

Application 3 :

Application 4 :

Application 5 :

Application 6 :

Application 7 :

Application 8 :

Application 9 :

Application 10 :

Application 11 :

Application 12 :

ZOOM+ ZOOM-



PARTS IMAGE



BOX IMAGE

31200-PLM-A51

STARTER MADE IN JAPAN

Parts Number : 31200-PLM-A51

Manufacture 1 : MITSUBA

Manufacturer Number 1 : 53162-002 / SM-44232

Manufacture 2 :

Manufacture Number 2 :

M.S.R.P 04/2010 :

Description: STARTER MADE IN JAPAN
#OEMNTP

Application 1 :

Application 2 :

Application 3 :

Application 4 :

Application 5 :

Application 6 :

Application 7 :

Application 8 :

Application 9 :

Application 10 :

Application 11 :

Application 12 :

ZOOM+ ZOOM-



PARTS IMAGE



BOX IMAGE

31200-PND-A04

STARTER MADE IN JAPAN

Parts Number :	31200-PND-A04
Manufacture 1 :	MITSUBA <input type="button" value="v"/>
Manufacturer Number 1 :	A0860-895/SM71011
Manufacture 2 :	<input type="button" value="v"/>
Manufacturer Number 2 :	
M.S.R.P 04/2010 :	
Description:	STARTER MADE IN JAPAN #OEMNTP

- Application 1 :
- Application 2 :
- Application 3 :
- Application 4 :
- Application 5 :
- Application 6 :
- Application 7 :
- Application 8 :
- Application 9 :
- Application 10 :
- Application 11 :
- Application 12 :

ZOOM+ ZOOM-



PARTS IMAGE



BOX IMAGE

31200-PPA-A04

STARTER MADE IN JAPAN

Parts Number : 31200-PPA-A04

Manufacture 1 : MITSUBA

Manufacturer Number 1 : A5565-146 / SM-71010

Manufacture 2 :

Manufacturer Number 2 :

M.S.R.P 04/2010 :

Description: STARTER MADE IN JAPAN
#OEMNTP

Application 1 :

Application 2 :

Application 3 :

Application 4 :

Application 5 :

Application 6 :

Application 7 :

Application 8 :

Application 9 :

Application 10 :

Application 11 :

Application 12 :

ZOOM+

ZOOM-



PARTS IMAGE



BOX IMAGE

31200-RAA-A52

STARTER MADE IN JAPAN

Parts Number : 31200-RAA-A52

Manufacture 1 : MITSUBA

Manufacturer Number 1 : A0838-595 / SM-71008

Manufacture 2 :

Manufacture Number 2 :

M.S.R.P 04/2010 :

Description: STARTER MADE IN JAPAN
#OEMNTP

Application 1 :

Application 2 :

Application 3 :

Application 4 :

Application 5 :

Application 6 :

Application 7 :

Application 8 :

Application 9 :

Application 10 :

Application 11 :

Application 12 :



PARTS IMAGE



BOX IMAGE

31200-RAA-A61

STARTER MADE IN JAPAN

Parts Number : 31200-RAA-A61

Manufacture 1 : MITSUBA

Manufacturer Number 1 : A9356-529 / SM-71005

Manufacture 2 :

Manufacture Number 2 :

M.S.R.P 04/2010 :

Description: STARTER MADE IN JAPAN
#OEMNTP

Application 1 :

Application 2 :

Application 3 :

Application 4 :

Application 5 :

Application 6 :

Application 7 :

Application 8 :

Application 9 :

Application 10 :

Application 11 :

Application 12 :

ZOOM+ ZOOM-



PARTS IMAGE



BOX IMAGE

31200-RRA-003

STARTER

Parts Number : 31200-RRA-003

Manufacture 1 : DENSO

Manufacturer Number 1 : 104210-4732

Manufacture 2 :

Manufacture Number 2 :

M.S.R.P 04/2010 :

Description: STARTER
MADE IN JAPAN#G

Application 1 :

Application 2 :

Application 3 :

Application 4 :

Application 5 :

Application 6 :

Application 7 :

Application 8 :

Application 9 :

Application 10 :

Application 11 :

Application 12 :

ZOOM+

ZOOM-



PARTS IMAGE

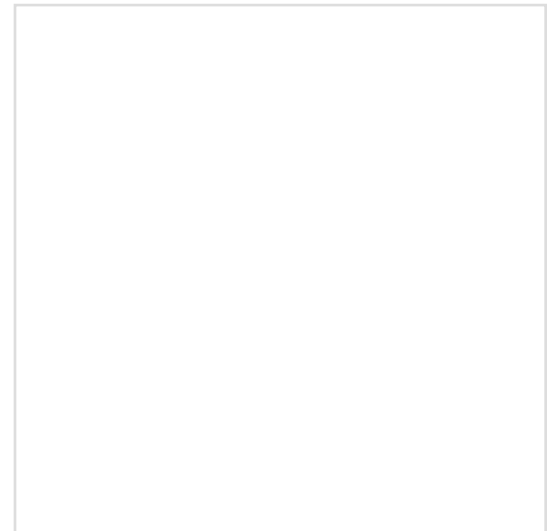

BOX IMAGE

31935-8E006

SPEED SENSOR

Parts Number : 31935-8E006

Manufacture 1 : MITSUBISHI

Manufacturer Number 1 : G4T078481A

Manufacture 2 :

Manufacture Number 2 :

M.S.R.P 04/2010 :

Description: SPEED SENSOR
MADE IN JAPAN

Application 1 :

Application 2 :

Application 3 :

Application 4 :

Application 5 :

Application 6 :

Application 7 :

Application 8 :

Application 9 :

Application 10 :

Application 11 :

Application 12 :

ZOOM+ ZOOM-



PARTS IMAGE



BOX IMAGE

31935-PW000

SENSOR TRANSMISSION

Parts Number : 31935-PW000

Manufacture 1 : HITACHI

Manufacturer Number 1 : RS-324C

Manufacture 2 :

Manufacture Number 2 :

M.S.R.P 04/2010 :

Description: SENSOR TRANSMISSION
REVOLUTION MADE IN
JAPAN#OEMNTP

Application 1 :

Application 2 :

Application 3 :

Application 4 :

Application 5 :

Application 6 :

Application 7 :

Application 8 :

Application 9 :

Application 10 :

Application 11 :

Application 12 :

ZOOM+ ZOOM-



PARTS IMAGE



BOX IMAGE

31939-AA000

SOLENOID TRANSMISSION

Parts Number : 31939-AA000

Manufacture 1 :

Manufacturer Number 1 : 191

Manufacture 2 :

Manufacture Number 2 :

M.S.R.P 04/2010 :

Description: SOLENOID TRANSMISSION
MADE IN JAPAN #OEMNTP

Application 1 : R4AX-EL

Application 2 : 87-UP

Application 3 : 4 Speed Automatic

Application 4 :

Application 5 : STELLAR # 69976 SL

Application 6 : TRANSTAR #31A-180

Application 7 :

Application 8 :

Application 9 :

Application 10 :

Application 11 :

Application 12 :

ZOOM+

ZOOM-



PARTS IMAGE

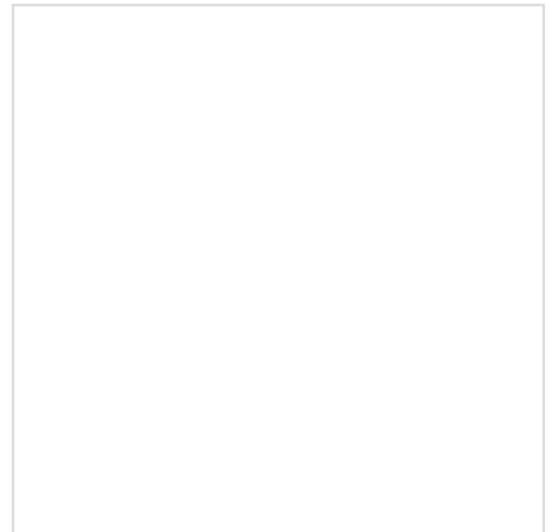

BOX IMAGE

31939-AA020

SOLENOID TRANSMISSION

Parts Number : 31939-AA020

Manufacture 1 : NIDEC

Manufacturer Number 1 :

Manufacture 2 :

Manufacturer Number 2 :

M.S.R.P 04/2010 :

Description: SOLENOID TRANSMISSION
MADE IN JAPAN #OEMNTP

Application 1 : R4AX-EL

Application 2 : 87-UP

Application 3 : 4 Speed Automatic

Application 4 :

Application 5 : STELLAR# 69976 SL

Application 6 : TRANSTAR #31A-180L

Application 7 :

Application 8 :

Application 9 :

Application 10 :

Application 11 :

Application 12 :

ZOOM+

ZOOM-



PARTS IMAGE



BOX IMAGE

31939-AA040

SOLENOID TRANSMISSION

Parts Number :	31939-AA040
Manufacture 1 :	NIDEC <input type="button" value="v"/>
Manufacturer Number 1 :	
Manufacture 2 :	<input type="button" value="v"/>
Manufacture Number 2 :	
M.S.R.P 04/2010 :	
Description:	SOLENOID TRANSMISSION MADE IN JAPAN #OEMNTP

- Application 1 :
- Application 2 :
- Application 3 :
- Application 4 :
- Application 5 :
- Application 6 :
- Application 7 :
- Application 8 :
- Application 9 :
- Application 10 :
- Application 11 :
- Application 12 :

ZOOM+ ZOOM-



PARTS IMAGE



BOX IMAGE

31939-AA080

SOLENOID TRANSMISSION

Parts Number : 31939-AA080

Manufacture 1 : NIDEC

Manufacturer Number 1 :

Manufacture 2 :

Manufacture Number 2 :

M.S.R.P 04/2010 :

Description: SOLENOID TRANSMISSION
MADE IN JAPAN #OEMNTP

Application 1 :

Application 2 :

Application 3 :

Application 4 :

Application 5 :

Application 6 :

Application 7 :

Application 8 :

Application 9 :

Application 10 :

Application 11 :

Application 12 :

ZOOM+ ZOOM-



PARTS IMAGE



BOX IMAGE

31939-AA160

SOLENOID TRANSMISSION

Parts Number : 31939-AA160

Manufacture 1 : NNIDEC

Manufacturer Number 1 :

Manufacture 2 :

Manufacture Number 2 :

M.S.R.P 04/2010 :

Description: SOLENOID TRANSMISSION
MADE IN JAPAN #OEMNTP

Application 1 :

Application 2 :

Application 3 :

Application 4 :

Application 5 :

Application 6 :

Application 7 :

Application 8 :

Application 9 :

Application 10 :

Application 11 :

Application 12 :

ZOOM+ ZOOM-



PARTS IMAGE



BOX IMAGE

31940-27X63

SOLENOID TRANSMISSION

Parts Number :	31940-27X63
Manufacture 1 :	NIDEC <input type="button" value="v"/>
Manufacturer Number 1 :	
Manufacture 2 :	<input type="button" value="v"/>
Manufacture Number 2 :	
M.S.R.P 04/2010 :	\$149.97
Description:	SOLENOID TRANSMISSION LOCK UP MADE IN JAPAN #OEMNTP

- Application 1 :** RE4F02A
- Application 2 :** 1989 - 1994 Nissan Maxima
- Application 3 :** 4 Speed Automatic Transmission, FWD SOHC
- Application 4 :** AXIOM#93425B
- Application 5 :** STELLAR # 93955 SL
- Application 6 :** TRANSTAR #31A-127L
- Application 7 :**
- Application 8 :**
- Application 9 :**
- Application 10 :**
- Application 11 :**
- Application 12 :**

ZOOM+ ZOOM-



PARTS IMAGE



BOX IMAGE

31940-27X66

SOLENOID TRANSMISSION

Parts Number : 31940-27X66

Manufacture 1 : NIDEC

Manufacturer Number 1 :

Manufacture 2 :

Manufacture Number 2 :

M.S.R.P 04/2010 :

Description: SOLENOID TRANSMISSION
MADE IN JAPAN #OEMNTP

Application 1 : RE4F02A

Application 2 : 1989 - 1994 Nissan Maxima

Application 3 : 4 Speed Automatic Transmission, FWD SOHC

Application 4 :

Application 5 : STELLAR # 93954 SL

Application 6 : TRANSTAR #31A-127

Application 7 :

Application 8 :

Application 9 :

Application 10 :

Application 11 :

Application 12 :

ZOOM+

ZOOM-



PARTS IMAGE



BOX IMAGE

31940-31X01

SOLENOID TRANSMISSION

Parts Number : 31940-31X01

Manufacture 1 : NIDEC

Manufacturer Number 1 :

Manufacture 2 :

Manufacturer Number 2 :

M.S.R.P 04/2010 :

Description: SOLENOID TRANSMISSION
MADE IN JAPAN #OEMNTP

Application 1 : RL4F03A / RE4F03A

Application 2 : 91-92 NISSAN/ INFINITI

Application 3 : 4 Speed Automatic

Application 4 : AXIOM#83420AC

Application 5 : STELLAR #K99950 SL

Application 6 : TRANSTAR #5A-139

Application 7 :

Application 8 :

Application 9 :

Application 10 :

Application 11 :

Application 12 :

ZOOM+

ZOOM-



PARTS IMAGE



BOX IMAGE

31940-31X03

SOLENOID TRANSMISSION

Parts Number : 31940-31X03

Manufacture 1 : NIDEC

Manufacturer Number 1 :

Manufacture 2 :

Manufacture Number 2 :

M.S.R.P 04/2010 :

Description: SOLENOID TRANSMISSION
MADE IN JAPAN #OEMNTP

Application 1 :

Application 2 :

Application 3 :

Application 4 :

Application 5 :

Application 6 : TRANSTAR #5A-140

Application 7 :

Application 8 :

Application 9 :

Application 10 :

Application 11 :

Application 12 :

ZOOM+ ZOOM-



PARTS IMAGE



BOX IMAGE

31940-33X02

SOLENOID TRANSMISSION

Parts Number : 31940-33X02

Manufacture 1 : NIDEC

Manufacturer Number 1 :

Manufacture 2 :

Manufacture Number 2 :

M.S.R.P 04/2010 :

Description: SOLENOID TRANSMISSION
MADE IN JAPAN #OEMNTP

Application 1 : RL4F03A / RE4F03A

Application 2 : 93-UP NISSAN/ INFINITY

Application 3 : 4 Speed Automatic

Application 4 : AXIOM#8420AE

Application 5 : STELLAR#K99950A SL

Application 6 : TRANSTAR #31A-131

Application 7 :

Application 8 :

Application 9 :

Application 10 :

Application 11 :

Application 12 :

ZOOM+

ZOOM-



PARTS IMAGE



BOX IMAGE

31940-3AX03

SOLENOID TRANSMISSION

Parts Number :	31940-3AX03
Manufacture 1 :	NIDEC <input type="button" value="v"/>
Manufacturer Number 1 :	
Manufacture 2 :	<input type="button" value="v"/>
Manufacture Number 2 :	
M.S.R.P 04/2010 :	\$310.20
Description:	SOLENOID TRANSMISSION MADE IN JAPAN #OEMNTP

- Application 1 :
- Application 2 :
- Application 3 :
- Application 4 :
- Application 5 :
- Application 6 :
- Application 7 :
- Application 8 :
- Application 9 :
- Application 10 :
- Application 11 :
- Application 12 :

ZOOM+ ZOOM-

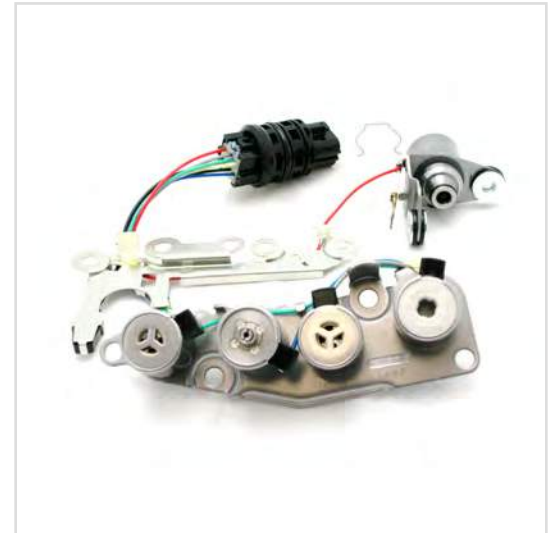

PARTS IMAGE



BOX IMAGE

31940-41X01

SOLENOID TRANSMISSION

Parts Number : 31940-41X01

Manufacture 1 :

Manufacturer Number 1 : 136

Manufacture 2 :

Manufacturer Number 2 :

M.S.R.P 04/2010 :

Description: SOLENOID TRANSMISSION
MADE IN JAPAN #OEMNTP

Application 1 :

Application 2 :

Application 3 :

Application 4 :

Application 5 :

Application 6 :

Application 7 :

Application 8 :

Application 9 :

Application 10 :

Application 11 :

Application 12 :

ZOOM+

ZOOM-

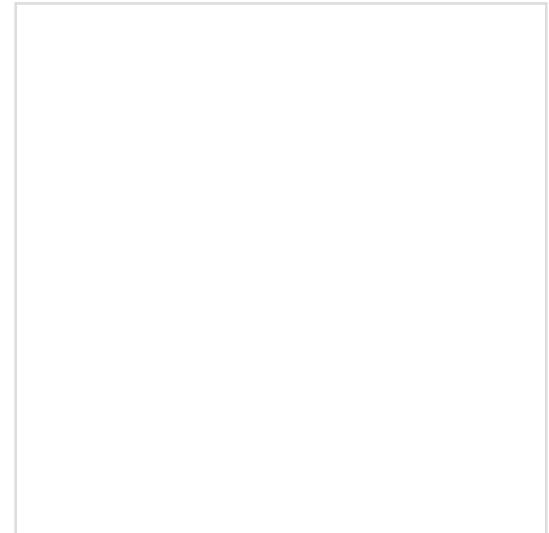

PARTS IMAGE

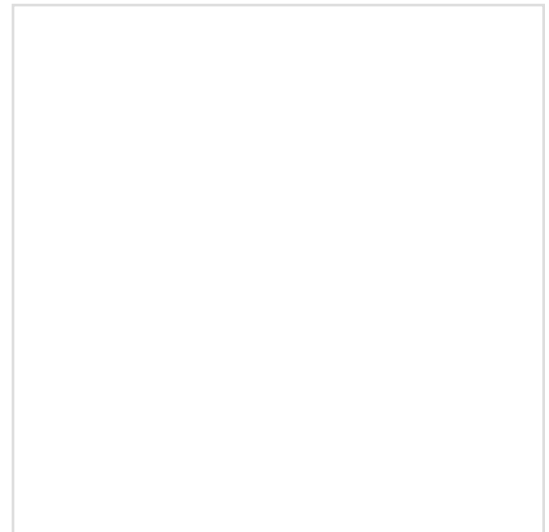

BOX IMAGE

31940-41X03

SOLENOID TRANSMISSION

Parts Number : 31940-41X03

Manufacture 1 :

Manufacturer Number 1 : 137

Manufacture 2 :

Manufacturer Number 2 :

M.S.R.P 04/2010 :

Description: SOLENOID TRANSMISSION
MADE IN JAPAN #OEMNTP

Application 1 :

Application 2 :

Application 3 :

Application 4 :

Application 5 :

Application 6 :

Application 7 :

Application 8 :

Application 9 :

Application 10 :

Application 11 :

Application 12 :

ZOOM+

ZOOM-



PARTS IMAGE

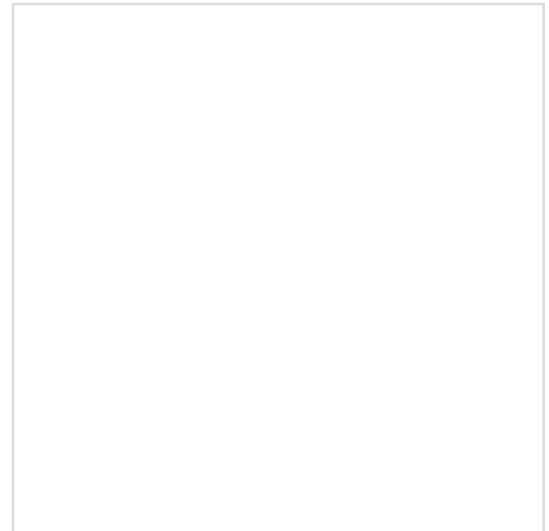

BOX IMAGE

31940-41X10

SOLENOID TRANSMISSION

Parts Number : 31940-41X10

Manufacture 1 : NIDEC

Manufacturer Number 1 :

Manufacture 2 :

Manufacture Number 2 :

M.S.R.P 04/2010 :

Description: SOLENOID TRANSMISSION
MADE IN JAPAN #OEMNTP

Application 1 : E4R01A, RL4R01A, RE5R01A, R4A-E

Application 2 : 88-UP NISSAN/ MAZDA

Application 3 : 4 Speed Automatic

Application 4 :

Application 5 : STELLAR #62997 SL

Application 6 : TRANSTAR #31A-125L

Application 7 : RE4R03A, RG4R01A, JR403E

Application 8 : 88-UP NISSAN / INFINITI / ISUZU / JAUGUAR

Application 9 :

Application 10 :

Application 11 :

Application 12 :

ZOOM+ ZOOM-



PARTS IMAGE



BOX IMAGE

31940-41X13

SOLENOID TRANSMISSION

Parts Number : 31940-41X13

Manufacture 1 : NIDEC

Manufacturer Number 1 :

Manufacture 2 :

Manufacture Number 2 :

M.S.R.P 04/2010 :

Description: SOLENOID TRANSMISSION
MADE IN JAPAN #OEMNTP

Application 1 : E4R01A, RL4R01A, RE5R01A, R4A-E

Application 2 : 88-UP NISSAN/ MAZDA

Application 3 : 4 Speed Automatic

Application 4 : AXIOM #73420A

Application 5 : STELLAR #K69954 SL

Application 6 :

Application 7 : RE4R03A, RG4R01A, JR403E

Application 8 : 88-UP NISSAN / INFINITI / ISUZU / JAUGUAR

Application 9 :

Application 10 :

Application 11 :

Application 12 :

ZOOM+

ZOOM-



PARTS IMAGE



BOX IMAGE

31940-48X02

SOLENOID TRANSMISSION

Parts Number :	31940-48X02
Manufacture 1 :	NIDEC <input type="button" value="v"/>
Manufacturer Number 1 :	
Manufacture 2 :	<input type="button" value="v"/>
Manufacture Number 2 :	
M.S.R.P 04/2010 :	
Description:	SOLENOID TRANSMISSION MADE IN JAPAN #OEMNTP

- Application 1 :** E4R01A, RL4R01A, RE5R01A, R4A-E
- Application 2 :** 87-UP NISSAN / MAZDA
- Application 3 :** 4 Speed Automatic
- Application 4 :** AXIOM #73425A
- Application 5 :** STELLAR #69974 SL
- Application 6 :** TRANSTAR #5A-185
- Application 7 :**
- Application 8 :**
- Application 9 :**
- Application 10 :**
- Application 11 :**
- Application 12 :**

ZOOM+ ZOOM-



PARTS IMAGE



BOX IMAGE

31940-60X00

SOLENOID TRANSMISSION

Parts Number : 31940-60X00

Manufacture 1 :

Manufacturer Number 1 : 141

Manufacture 2 :

Manufacturer Number 2 :

M.S.R.P 04/2010 :

Description: SOLENOID TRANSMISSION
MADE IN JAPAN #OEMNTP

Application 1 :

Application 2 :

Application 3 :

Application 4 :

Application 5 :

Application 6 :

Application 7 :

Application 8 :

Application 9 :

Application 10 :

Application 11 :

Application 12 :

ZOOM+

ZOOM-



PARTS IMAGE

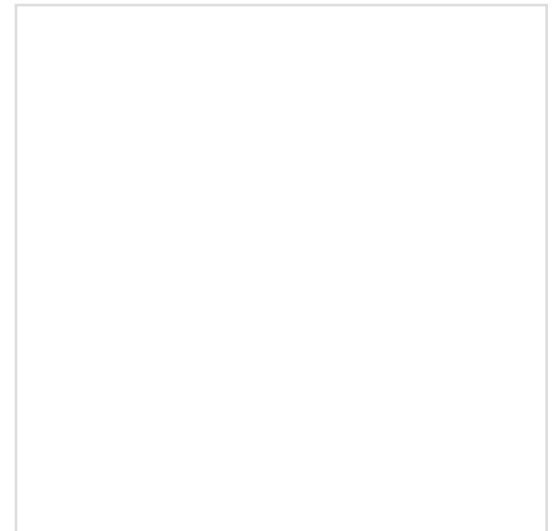

BOX IMAGE

31940-60X01

SOLENOID TRANSMISSION

Parts Number : 31940-60X01

Manufacture 1 :

Manufacturer Number 1 : 142

Manufacture 2 :

Manufacturer Number 2 :

M.S.R.P 04/2010 :

Description: SOLENOID TRANSMISSION
MADE IN JAPAN #OEM

Application 1 :

Application 2 :

Application 3 :

Application 4 :

Application 5 :

Application 6 :

Application 7 :

Application 8 :

Application 9 :

Application 10 :

Application 11 :

Application 12 :

ZOOM+

ZOOM-



PARTS IMAGE

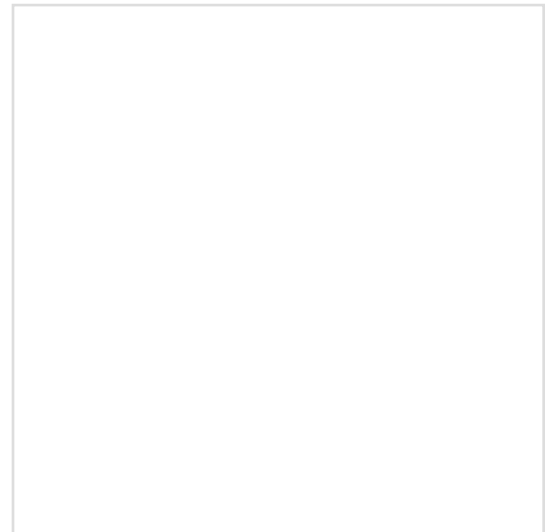

BOX IMAGE

31940-71X03

SOLENOID TRANSMISSION

Parts Number : 31940-71X03

Manufacture 1 :

Manufacturer Number 1 : 143

Manufacture 2 :

Manufacture Number 2 :

M.S.R.P 04/2010 :

Description: SOLENOID TRANSMISSION
MADE IN JAPAN #OEMNTP

Application 1 :

Application 2 :

Application 3 :

Application 4 :

Application 5 :

Application 6 :

Application 7 :

Application 8 :

Application 9 :

Application 10 :

Application 11 :

Application 12 :

ZOOM+

ZOOM-



PARTS IMAGE

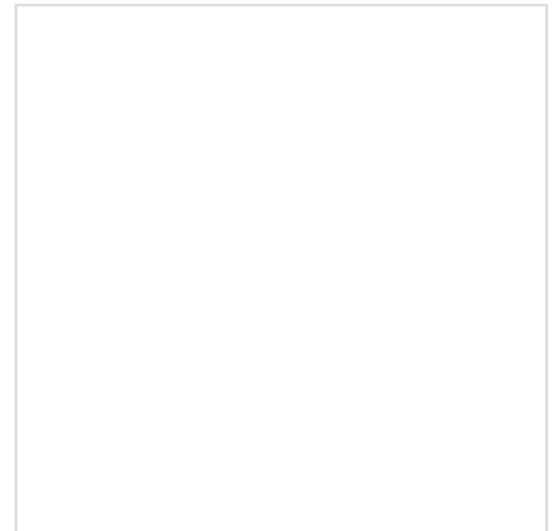

BOX IMAGE

31940-71X04

SOLENOID TRANSMISSION

Parts Number : 31940-71X04

Manufacture 1 :

Manufacturer Number 1 : 144

Manufacture 2 :

Manufacture Number 2 :

M.S.R.P 04/2010 :

Description: SOLENOID TRANSMISSION
MADE IN JAPAN #OEMNTP

Application 1 :

Application 2 :

Application 3 :

Application 4 :

Application 5 :

Application 6 :

Application 7 :

Application 8 :

Application 9 :

Application 10 :

Application 11 :

Application 12 :

ZOOM+

ZOOM-

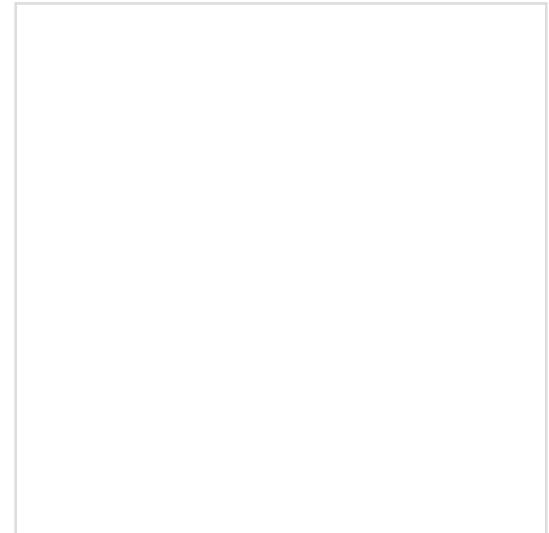

PARTS IMAGE

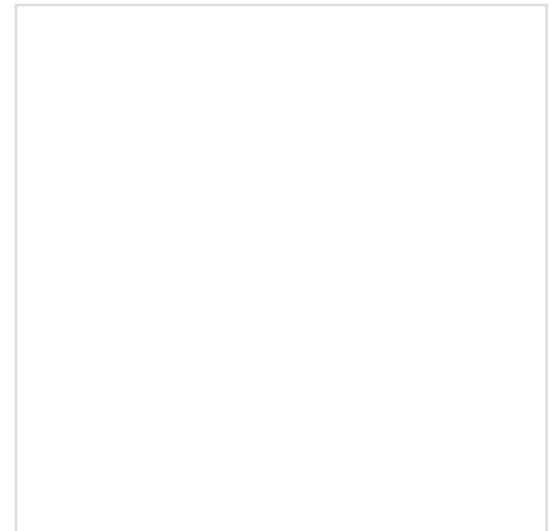

BOX IMAGE

31940-80X05

SOLENOID TRANSMISSION

Parts Number : 31940-80X05

Manufacture 1 : NIDEC

Manufacturer Number 1 :

Manufacture 2 :

Manufacture Number 2 :

M.S.R.P 04/2010 :

Description: SOLENOID TRANSMISSION
MADE IN JAPAN #OEMNTP

Application 1 : RE4F04A/B

Application 2 : 92-UP NISSAN/ FORD

Application 3 :

Application 4 : AXIOM #83420B

Application 5 : STELLAR #63954 SL

Application 6 :

Application 7 :

Application 8 :

Application 9 :

Application 10 :

Application 11 :

Application 12 :

ZOOM+

ZOOM-



PARTS IMAGE



BOX IMAGE

31940-80X25

SOLENOID TRANSMISSION

Parts Number : 31940-80X25

Manufacture 1 :

Manufacturer Number 1 : 146

Manufacture 2 :

Manufacturer Number 2 :

M.S.R.P 04/2010 :

Description: SOLENOID TRANSMISSION
MADE IN JAPAN #OEMNTP

Application 1 : RE4F04A/B

Application 2 : 92-UP NISSAN/ FORD

Application 3 :

Application 4 : AXIOM #83420B

Application 5 : STELLAR #63954 SL

Application 6 : TRANSTAR #31A-129

Application 7 :

Application 8 :

Application 9 :

Application 10 :

Application 11 :

Application 12 :

ZOOM+

ZOOM-

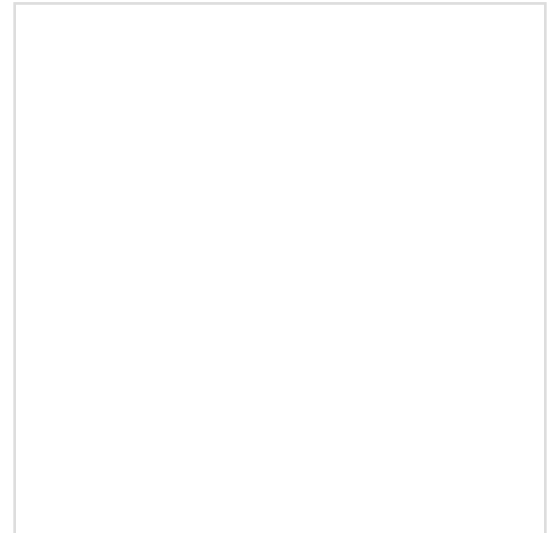

PARTS IMAGE

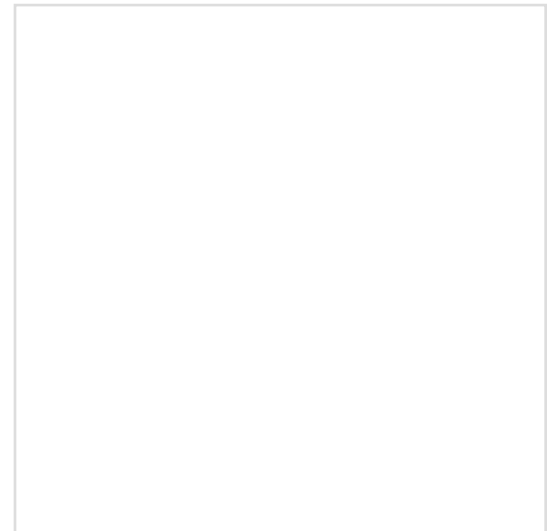

BOX IMAGE

31940-85X01

SOLENOID TRANSMISSION

Parts Number : 31940-85X01

Manufacture 1 : NIDEC

Manufacturer Number 1 :

Manufacture 2 :

Manufacture Number 2 :

M.S.R.P 04/2010 :

Description: SOLENOID TRANSMISSION
MADE IN JAPAN #OEMNTP

Application 1 : RE4F04A/B

Application 2 : 99-UP NISSAN

Application 3 :

Application 4 : AXIOM #83420BA

Application 5 : STELLAR #63954A SL

Application 6 : TRANSTAR #31A-129

Application 7 : 4F20E

Application 8 : 99-UP FORD

Application 9 :

Application 10 :

Application 11 :

Application 12 :

ZOOM+

ZOOM-



PARTS IMAGE



BOX IMAGE

31940-85X05

SOLENOID TRANSMISSION

Parts Number : 31940-85X05

Manufacture 1 :

Manufacturer Number 1 : 148

Manufacture 2 :

Manufacturer Number 2 :

M.S.R.P 04/2010 :

Description: SOLENOID TRANSMISSION
MADE IN JAPAN #OEMNTP

Application 1 : RE4F04A/B

Application 2 : 99-UP NISSAN

Application 3 :

Application 4 : AXIOM #83420BA

Application 5 : STELLAR #63954A SL

Application 6 : TRANSTAR #31A-129

Application 7 : 4F20E

Application 8 :

Application 9 :

Application 10 :

Application 11 :

Application 12 :

ZOOM+

ZOOM-

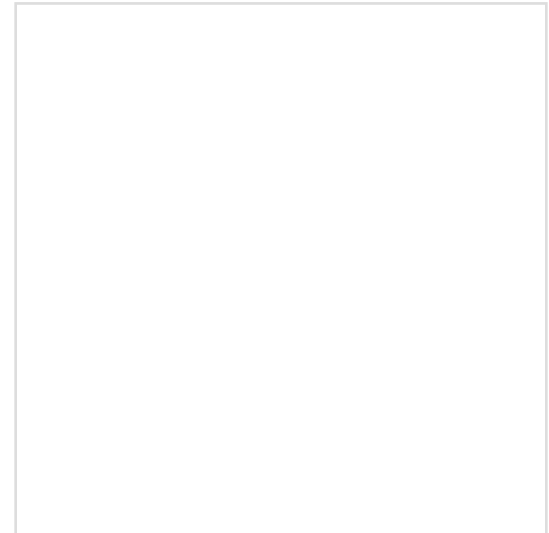

PARTS IMAGE

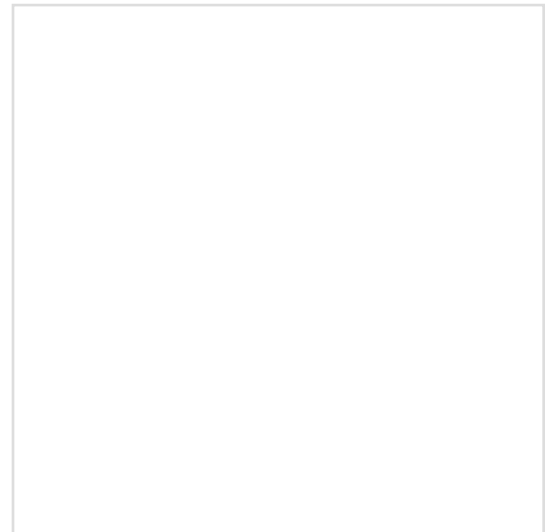

BOX IMAGE

31941-90X00

SOLENOID TRANSMISSION

Parts Number : 31941-90X00

Manufacture 1 : BOSCH

Manufacturer Number 1 :

Manufacture 2 :

Manufacture Number 2 :

M.S.R.P 04/2010 :

Description: SOLENOID TRANSMISSION
MADE IN Germany #OEMNTP

Application 1 :

Application 2 :

Application 3 :

Application 4 :

Application 5 :

Application 6 :

Application 7 :

Application 8 :

Application 9 :

Application 10 :

Application 11 :

Application 12 :

ZOOM+

ZOOM-



PARTS IMAGE



BOX IMAGE

31941-90X01

SOLENOID TRANSMISSION

Parts Number : 31941-90X01

Manufacture 1 : BOSCH

Manufacturer Number 1 : S41-S001

Manufacture 2 :

Manufacture Number 2 :

M.S.R.P 04/2010 :

Description: SOLENOID TRANSMISSION
MADE IN GERMANY #OEMNTP

Application 1 :

Application 2 :

Application 3 :

Application 4 :

Application 5 :

Application 6 :

Application 7 :

Application 8 :

Application 9 :

Application 10 :

Application 11 :

Application 12 :

ZOOM+

ZOOM-



PARTS IMAGE



BOX IMAGE

31941-90X02

SOLENOID TRANSMISSION

Parts Number : 31941-90X02

Manufacture 1 :

Manufacturer Number 1 :

Manufacture 2 :

Manufacturer Number 2 :

M.S.R.P 04/2010 :

Description: SOLENOID TRANSMISSION
MADE IN JAPAN #OEMNTP

Application 1 :

Application 2 :

Application 3 :

Application 4 :

Application 5 :

Application 6 :

Application 7 :

Application 8 :

Application 9 :

Application 10 :

Application 11 :

Application 12 :

ZOOM+

ZOOM-



PARTS IMAGE



BOX IMAGE

31941-PM000

SOLENOID TRANSMISSION

Parts Number : 31941-PM000

Manufacture 1 :

Manufacturer Number 1 :

Manufacture 2 :

Manufacture Number 2 :

M.S.R.P 04/2010 :

Description: SOLENOID TRANSMISSION
MADE IN JAPAN #OEMNTP

Application 1 :

Application 2 :

Application 3 :

Application 4 :

Application 5 :

Application 6 :

Application 7 :

Application 8 :

Application 9 :

Application 10 :

Application 11 :

Application 12 :

ZOOM+ ZOOM-



PARTS IMAGE



BOX IMAGE

31941-PM001

SOLENOID TRANSMISSION

Parts Number :	31941-PM001
Manufacture 1 :	MITSUBISHI <input type="button" value="v"/>
Manufacturer Number 1 :	G6T46176
Manufacture 2 :	<input type="button" value="v"/>
Manufacture Number 2 :	
M.S.R.P 04/2010 :	
Description:	SOLENOID TRANSMISSION MADE IN JAPAN #OEMNTP

ZOOM+ ZOOM-



PARTS IMAGE

- Application 1 :
- Application 2 :
- Application 3 :
- Application 4 :
- Application 5 :
- Application 6 :
- Application 7 :
- Application 8 :
- Application 9 :
- Application 10 :
- Application 11 :
- Application 12 :



BOX IMAGE

31941-PM002

SOLENOID TRANSMISSION

Parts Number :	31941-PM002
Manufacture 1 :	MITSUBISHI <input type="button" value="v"/>
Manufacturer Number 1 :	G6T462777
Manufacture 2 :	<input type="button" value="v"/>
Manufacturer Number 2 :	
M.S.R.P 04/2010 :	
Description:	SOLENOID TRANSMISSION MADE IN JAPAN #OEMNTP

- Application 1 :
- Application 2 :
- Application 3 :
- Application 4 :
- Application 5 :
- Application 6 :
- Application 7 :
- Application 8 :
- Application 9 :
- Application 10 :
- Application 11 :
- Application 12 :

ZOOM+ ZOOM-



PARTS IMAGE



BOX IMAGE

31941-PM003

SOLENOID TRANSMISSION

Parts Number :	31941-PM003
Manufacture 1 :	MITSUBISHI <input type="button" value="v"/>
Manufacturer Number 1 :	G6144276
Manufacture 2 :	<input type="button" value="v"/>
Manufacturer Number 2 :	
M.S.R.P 04/2010 :	
Description:	SOLENOID TRANSMISSION MADE IN JAPAN #OEMNTP

- Application 1 :
- Application 2 :
- Application 3 :
- Application 4 :
- Application 5 :
- Application 6 :
- Application 7 :
- Application 8 :
- Application 9 :
- Application 10 :
- Application 11 :
- Application 12 :

ZOOM+ ZOOM-



PARTS IMAGE



BOX IMAGE

31941-PM004

SOLENOID TRANSMISSION

Parts Number :	31941-PM004
Manufacture 1 :	MITSUBISHI <input type="button" value="v"/>
Manufacturer Number 1 :	G6T44275
Manufacture 2 :	<input type="button" value="v"/>
Manufacturer Number 2 :	
M.S.R.P 04/2010 :	
Description:	SOLENOID TRANSMISSION MADE IN JAPAN #OEMNTP

ZOOM+ ZOOM-



PARTS IMAGE

- Application 1 :
- Application 2 :
- Application 3 :
- Application 4 :
- Application 5 :
- Application 6 :
- Application 7 :
- Application 8 :
- Application 9 :
- Application 10 :
- Application 11 :
- Application 12 :



BOX IMAGE

31941-PM005

SOLENOID TRANSMISSION

Parts Number :	31941-PM005
Manufacture 1 :	MITSUBISHI <input type="button" value="v"/>
Manufacturer Number 1 :	G6T46278
Manufacture 2 :	<input type="button" value="v"/>
Manufacturer Number 2 :	
M.S.R.P 04/2010 :	
Description:	SOLENOID TRANSMISSION MADE IN JAPAN #OEMNTP

- Application 1 :
- Application 2 :
- Application 3 :
- Application 4 :
- Application 5 :
- Application 6 :
- Application 7 :
- Application 8 :
- Application 9 :
- Application 10 :
- Application 11 :
- Application 12 :

ZOOM+ ZOOM-



PARTS IMAGE



BOX IMAGE

31941-PR000

SOLENOID TRANSMISSION

Parts Number :	31941-PR000
Manufacture 1 :	MITSUBISHI <input type="button" value="v"/>
Manufacturer Number 1 :	G6T44273
Manufacture 2 :	<input type="button" value="v"/>
Manufacturer Number 2 :	
M.S.R.P 04/2010 :	
Description:	SOLENOID TRANSMISSION MADE IN JAPAN #OEMNTP

- Application 1 :
- Application 2 :
- Application 3 :
- Application 4 :
- Application 5 :
- Application 6 :
- Application 7 :
- Application 8 :
- Application 9 :
- Application 10 :
- Application 11 :
- Application 12 :

ZOOM+ ZOOM-



PARTS IMAGE



BOX IMAGE

31941-PR005

SOLENOID TRANSMISSION

Parts Number : 31941-PR005

Manufacture 1 : MITSUBISHI

Manufacturer Number 1 : G6T46272

Manufacture 2 :

Manufacture Number 2 :

M.S.R.P 04/2010 :

Description: SOLENOID TRANSMISSION
MADE IN JAPAN #OEMNTP

Application 1 :

Application 2 :

Application 3 :

Application 4 :

Application 5 :

Application 6 :

Application 7 :

Application 8 :

Application 9 :

Application 10 :

Application 11 :

Application 12 :

ZOOM+ ZOOM-



PARTS IMAGE



BOX IMAGE

31941-PR006

SOLENOID TRANSMISSION

Parts Number :	31941-PR006
Manufacture 1 :	MITSUBISHI <input type="button" value="v"/>
Manufacturer Number 1 :	G6T46273
Manufacture 2 :	<input type="button" value="v"/>
Manufacture Number 2 :	
M.S.R.P 04/2010 :	
Description:	SOLENOID TRANSMISSION MADE IN JAPAN #OEMNTP

ZOOM+ ZOOM-



PARTS IMAGE

- Application 1 :
- Application 2 :
- Application 3 :
- Application 4 :
- Application 5 :
- Application 6 :
- Application 7 :
- Application 8 :
- Application 9 :
- Application 10 :
- Application 11 :
- Application 12 :



BOX IMAGE

31941-PR007

SOLENOID TRANSMISSION

Parts Number : 31941-PR007

Manufacture 1 : MITSUBISHI

Manufacturer Number 1 : G6T462374

Manufacture 2 :

Manufacture Number 2 :

M.S.R.P 04/2010 :

Description: SOLENOID TRANSMISSION
MADE IN JAPAN #OEMNTP

Application 1 :

Application 2 :

Application 3 :

Application 4 :

Application 5 :

Application 6 :

Application 7 :

Application 8 :

Application 9 :

Application 10 :

Application 11 :

Application 12 :

ZOOM+

ZOOM-



PARTS IMAGE



BOX IMAGE

31941-PR008

SOLENOID TRANSMISSION

Parts Number : 31941-PR008

Manufacture 1 : MITSUBISHI

Manufacturer Number 1 : G6T46275

Manufacture 2 :

Manufacture Number 2 :

M.S.R.P 04/2010 :

Description: SOLENOID TRANSMISSION
MADE IN JAPAN #OEMNTP

Application 1 :

Application 2 :

Application 3 :

Application 4 :

Application 5 :

Application 6 :

Application 7 :

Application 8 :

Application 9 :

Application 10 :

Application 11 :

Application 12 :

ZOOM+

ZOOM-



PARTS IMAGE



BOX IMAGE

31941-PR010

SOLENOID TRANSMISSION

Parts Number : 31941-PR010

Manufacture 1 :

Manufacturer Number 1 :

Manufacture 2 :

Manufacturer Number 2 :

M.S.R.P 04/2010 :

Description: SOLENOID TRANSMISSION
MADE IN JAPAN #OEMNTP

Application 1 :

Application 2 :

Application 3 :

Application 4 :

Application 5 :

Application 6 :

Application 7 :

Application 8 :

Application 9 :

Application 10 :

Application 11 :

Application 12 :

ZOOM+ ZOOM-



PARTS IMAGE



BOX IMAGE

31941-PR011

SOLENOID TRANSMISSION

Parts Number :	31941-PR011
Manufacture 1 :	MITSUBISHI <input type="button" value="v"/>
Manufacturer Number 1 :	G6T46172
Manufacture 2 :	<input type="button" value="v"/>
Manufacturer Number 2 :	
M.S.R.P 04/2010 :	
Description:	SOLENOID TRANSMISSION MADE IN JAPAN #OEMNTP

- Application 1 :
- Application 2 :
- Application 3 :
- Application 4 :
- Application 5 :
- Application 6 :
- Application 7 :
- Application 8 :
- Application 9 :
- Application 10 :
- Application 11 :
- Application 12 :

ZOOM+ ZOOM-



PARTS IMAGE



BOX IMAGE

31941-PR014

SOLENOID TRANSMISSION

Parts Number : 31941-PR014

Manufacture 1 : MITSUBISHI

Manufacturer Number 1 : G6T46276

Manufacture 2 :

Manufacture Number 2 :

M.S.R.P 04/2010 :

Description: SOLENOID TRANSMISSION
MADE IN JAPAN #OEMNTP

Application 1 :

Application 2 :

Application 3 :

Application 4 :

Application 5 :

Application 6 :

Application 7 :

Application 8 :

Application 9 :

Application 10 :

Application 11 :

Application 12 :

ZOOM+

ZOOM-



PARTS IMAGE



BOX IMAGE

31941-PR015

SOLENOID TRANSMISSION

Parts Number :	31941-PR015
Manufacture 1 :	MITSUBISHI <input type="button" value="v"/>
Manufacturer Number 1 :	G6T46174
Manufacture 2 :	<input type="button" value="v"/>
Manufacture Number 2 :	
M.S.R.P 04/2010 :	
Description:	SOLENOID TRANSMISSION MADE IN JAPAN #OEMNTP

- Application 1 :
- Application 2 :
- Application 3 :
- Application 4 :
- Application 5 :
- Application 6 :
- Application 7 :
- Application 8 :
- Application 9 :
- Application 10 :
- Application 11 :
- Application 12 :

ZOOM+ ZOOM-



PARTS IMAGE



BOX IMAGE

35100-SJA-A01

IGNITION LOCK CYLINDER

Parts Number : 35100-SJA-A01

Manufacture 1 : HONDA LOCK

Manufacturer Number 1 :

Manufacture 2 :

Manufacture Number 2 :

M.S.R.P 04/2010 : \$699.92

Description: IGNITION LOCK CYLINDER
MADE IN JAPAN#OEM / VALEO &
HONDA LOCK

Application 1 : ACURA RL 05-09

Application 2 :

Application 3 :

Application 4 :

Application 5 :

Application 6 :

Application 7 :

Application 8 :

Application 9 :

Application 10 :

Application 11 :

Application 12 :

ZOOM+ ZOOM-



PARTS IMAGE

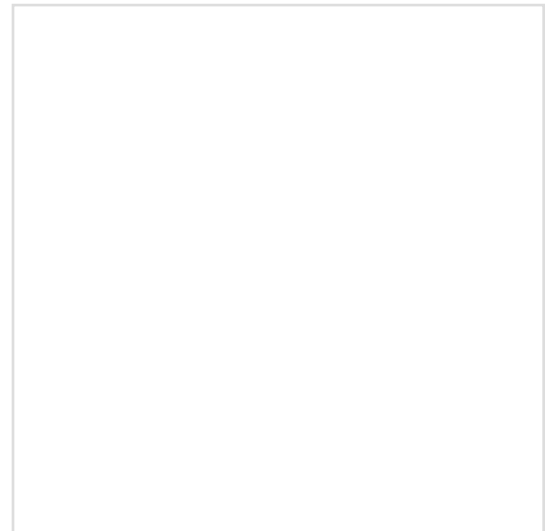

BOX IMAGE

35100-SM5-A02

IGNITION LOCK CYLINDER

Parts Number : 35100-SM5-A02

Manufacture 1 : HONDA LOCK

Manufacturer Number 1 :

Manufacture 2 :

Manufacture Number 2 :

M.S.R.P 04/2010 : \$301.40

Description: IGNITION LOCK CYLINDER
MADE IN JAPAN#G

Application 1 : HONDA ACCORD 2D 90-93

Application 2 : HONDA ACCORD 4D 90-93

Application 3 : HONDA ACCORD WAGON 91-93

Application 4 :

Application 5 :

Application 6 :

Application 7 :

Application 8 :

Application 9 :

Application 10 :

Application 11 :

Application 12 :

ZOOM+

ZOOM-



PARTS IMAGE

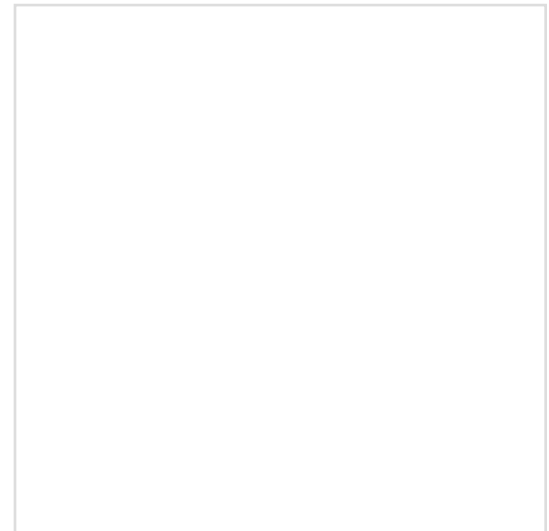

BOX IMAGE

35100-SP0-A12

IGNITION LOCK CYLINDER

Parts Number : 35100-SP0-A12

Manufacture 1 : HONDA LOCK

Manufacturer Number 1 :

Manufacture 2 :

Manufacture Number 2 :

M.S.R.P 04/2010 : \$222.20

Description: IGNITION LOCK CYLINDER
MADE IN JAPAN#OEM

Application 1 : ACURA LEGEND 2D AT 91-95

Application 2 : ACURA LEGEND 4D 91-95

Application 3 :

Application 4 :

Application 5 :

Application 6 :

Application 7 :

Application 8 :

Application 9 :

Application 10 :

Application 11 :

Application 12 :

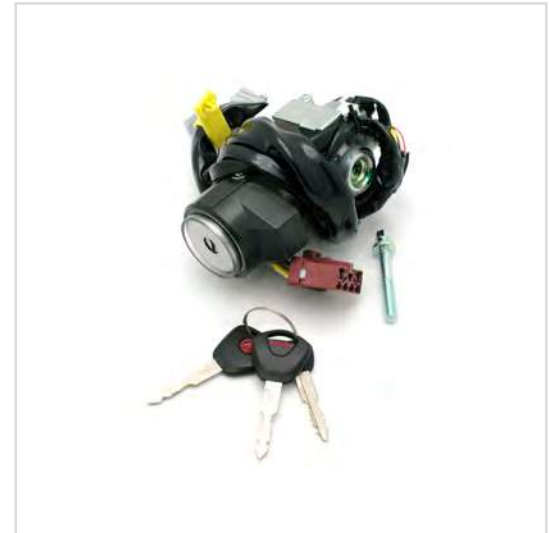

PARTS IMAGE

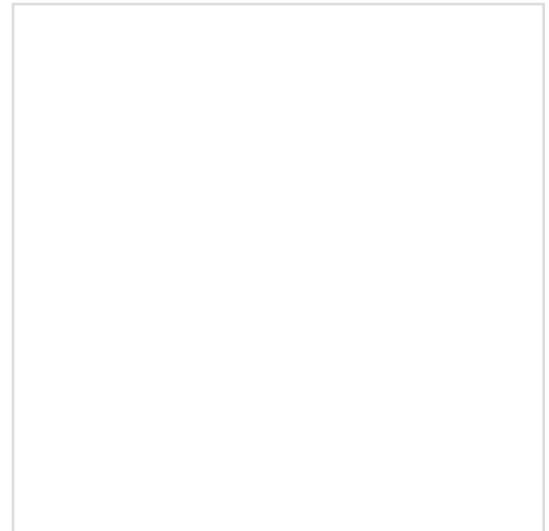

BOX IMAGE

35100-SV4-A02

IGNITION LOCK CYLINDER

Parts Number : 35100-SV4-A02

Manufacture 1 : HONDA LOCK

Manufacturer Number 1 :

Manufacture 2 :

Manufacture Number 2 :

M.S.R.P 04/2010 : \$189.40

Description: IGNITION LOCK CYLINDER
MADE IN JAPAN
#G

Application 1 : HONDA ACCORD 2D 94-97

Application 2 : HONDA ACCORD 4D 94-97 E2/ V6 E2

Application 3 : HONDA ACCORD WAGON 94-97

Application 4 : ACULA CL AT 1997

Application 5 :

Application 6 :

Application 7 :

Application 8 :

Application 9 :

Application 10 :

Application 11 :

Application 12 :

ZOOM+

ZOOM-



PARTS IMAGE

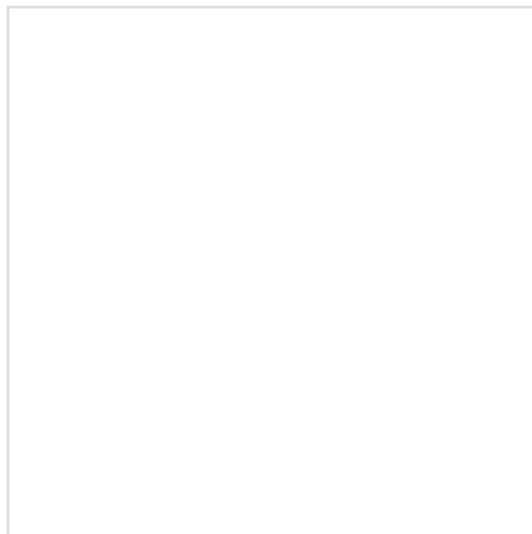

BOX IMAGE

35100-SW5-A02

IGNITION LOCK CYLINDER

Parts Number : 35100-SW5-A02

Manufacture 1 : HONDA LOCK

Manufacturer Number 1 :

Manufacture 2 :

Manufacture Number 2 :

M.S.R.P 04/2010 : \$280.08

Description: IGNITION LOCK CYLINDER
MADE IN JAPAN
#G

Application 1 : ACURA TL 3.2 96-98

Application 2 : ACURA TL 2.5L 95-98

Application 3 :

Application 4 :

Application 5 :

Application 6 :

Application 7 :

Application 8 :

Application 9 :

Application 10 :

Application 11 :

Application 12 :

ZOOM+

ZOOM-



PARTS IMAGE

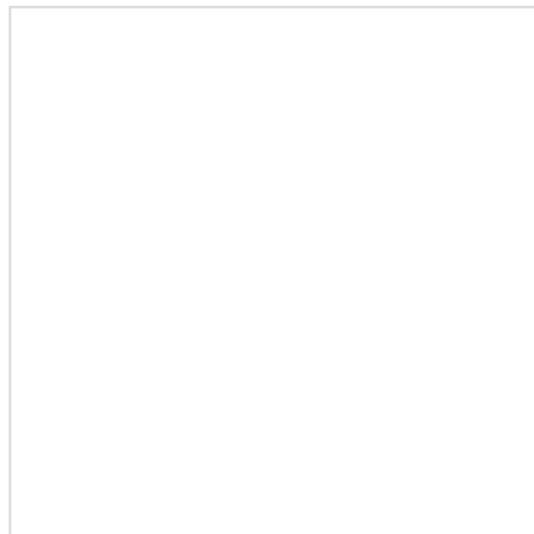

BOX IMAGE

35130-SE0-900

SWITCH IGNITION

Parts Number : 35130-SE0-900

Manufacture 1 : HONDA LOCK

Manufacturer Number 1 :

Manufacture 2 :

Manufacture Number 2 :

M.S.R.P 04/2010 : \$65.62

Description: SWITCH IGNITION
MADE IN JAPAN #OEM

Application 1 : HONDA ACCORD 2D 88-89

Application 2 : HONDA ACCORD 3D/4D 86-89

Application 3 :

Application 4 :

Application 5 :

Application 6 :

Application 7 :

Application 8 :

Application 9 :

Application 10 :

Application 11 :

Application 12 :

ZOOM+

ZOOM-



PARTS IMAGE

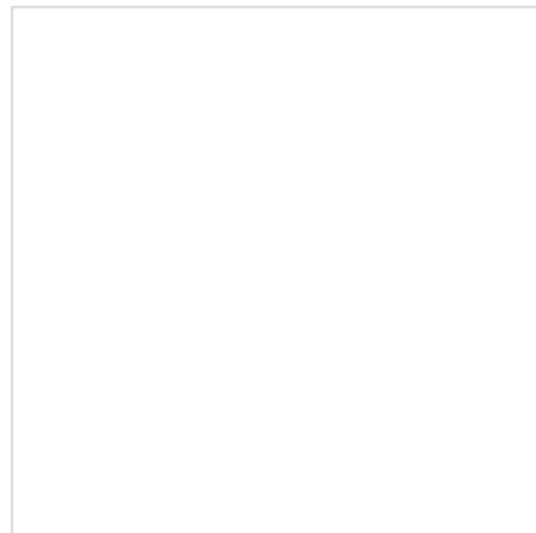

BOX IMAGE

35130-SL5-305

SWITCH STEERING

Parts Number : 35130-SL5-305

Manufacture 1 : HONDA LOCK

Manufacturer Number 1 :

Manufacture 2 :

Manufacture Number 2 :

M.S.R.P 04/2010 : \$63.53

Description: SWITCH STEERING
MADE IN JAPAN #OEM

Application 1 : ACURA VIGOR 92-94

Application 2 :

Application 3 :

Application 4 :

Application 5 :

Application 6 :

Application 7 :

Application 8 :

Application 9 :

Application 10 :

Application 11 :

Application 12 :

ZOOM+ ZOOM-



PARTS IMAGE

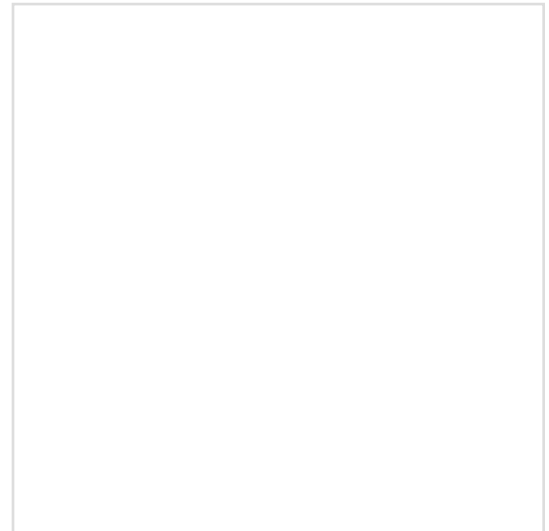

BOX IMAGE

35210-21010

SOLENOID TRANSMISSION

Parts Number : 35210-21010

Manufacture 1 : DENSO

Manufacturer Number 1 :

Manufacture 2 :

Manufacture Number 2 :

M.S.R.P 04/2010 : \$167.99

Description: SOLENOID TRANSMISSION
CLUTCH CONTROL #1 MADE IN
JAPAN #GNTF

Application 1 : TOYOTA CAMRY USA 2AZFE ATM 4FC 2004

Application 2 :

Application 3 :

Application 4 :

Application 5 :

Application 6 :

Application 7 :

Application 8 :

Application 9 :

Application 10 :

Application 11 :

Application 12 :

ZOOM+

ZOOM-



PARTS IMAGE



BOX IMAGE

35210-33010

SOLENOID TRANSMISSION

Parts Number : 35210-33010

Manufacture 1 :

Manufacturer Number 1 :

229

Manufacture 2 :

Manufacturer Number 2 :

M.S.R.P 04/2010 :

Description:

SOLENOID TRANSMISSION
MADE IN JAPAN #GNTP

Application 1 :

Application 2 :

Application 3 :

Application 4 :

Application 5 :

Application 6 :

Application 7 :

Application 8 :

Application 9 :

Application 10 :

Application 11 :

Application 12 :

ZOOM+

ZOOM-

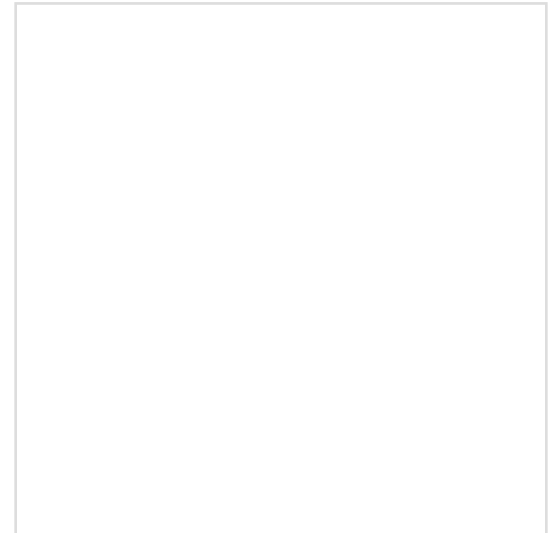

PARTS IMAGE

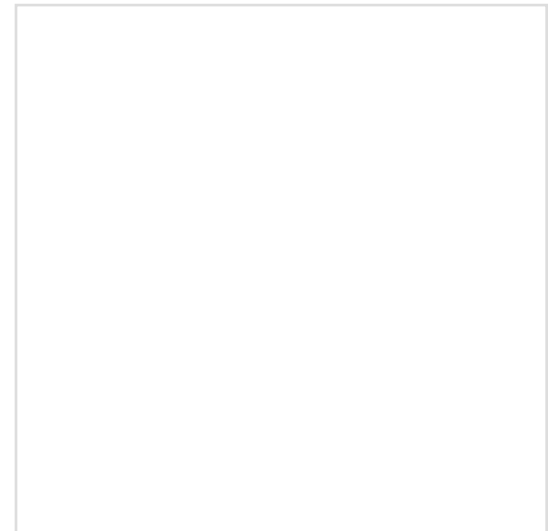

BOX IMAGE

35210-45010

SOLENOID TRANSMISSION

Parts Number : 35210-45010

Manufacture 1 :

Manufacturer Number 1 :

Manufacture 2 :

Manufacture Number 2 :

M.S.R.P 04/2010 : \$167.99

Description: SOLENOID TRANSMISSION
CLUTCH CONTROL #1 MADE IN
JAPAN #GNTP

Application 1 : TOYOTA CAMRY USA USA 2AZFE ATM 5FC 2007

Application 2 :

Application 3 :

Application 4 :

Application 5 :

Application 6 :

Application 7 :

Application 8 :

Application 9 :

Application 10 :

Application 11 :

Application 12 :

ZOOM+

ZOOM-



PARTS IMAGE



BOX IMAGE

35220-21010

SOLENOID TRANSMISSION

Parts Number : 35220-21010

Manufacture 1 :

Manufacturer Number 1 :

Manufacture 2 :

Manufacture Number 2 :

M.S.R.P 04/2010 : \$167.99

Description: SOLENOID TRANSMISSION
CLUTCH CONTROL #2 MADE IN
JAPAN #GMNTP

Application 1 : TOYOTA CAMRY USA 2AZFE ATM 4FC 2004

Application 2 :

Application 3 :

Application 4 :

Application 5 :

Application 6 :

Application 7 :

Application 8 :

Application 9 :

Application 10 :

Application 11 :

Application 12 :

ZOOM+ ZOOM-



PARTS IMAGE



BOX IMAGE

35220-33010

SOLENOID TRANSMISSION

Parts Number : 35220-33010

Manufacture 1 : DENSO

Manufacturer Number 1 : 079600-1210

Manufacture 2 :

Manufacture Number 2 :

M.S.R.P 04/2010 :

Description: SOLENOID TRANSMISSION
MADE IN JAPAN #GNTP

Application 1 :

Application 2 :

Application 3 :

Application 4 :

Application 5 :

Application 6 :

Application 7 :

Application 8 :

Application 9 :

Application 10 :

Application 11 :

Application 12 :

ZOOM+

ZOOM-



PARTS IMAGE



BOX IMAGE

35220-45010

SOLENOID TRANSMISSION

Parts Number : 35220-45010

Manufacture 1 : DENSO

Manufacturer Number 1 :

Manufacture 2 :

Manufacture Number 2 :

M.S.R.P 04/2010 : \$198.17

Description: SOLENOID TRANSMISSION
CLUTCH CONTROL #2 MADE IN
JAPAN #GNTP

Application 1 : TOYOTA CAMRY USA USA 2AZFE ATM 5FC 2007

Application 2 :

Application 3 : 2005 TOYOTA SIENNA 3MZFE ATM 5D 07S

Application 4 :

Application 5 :

Application 6 :

Application 7 :

Application 8 :

Application 9 :

Application 10 :

Application 11 :

Application 12 :

ZOOM+

ZOOM-



PARTS IMAGE



BOX IMAGE

35230-21010

SOLENOID TRANSMISSION

Parts Number :	35230-21010
Manufacture 1 :	NACHI <input type="button" value="v"/>
Manufacturer Number 1 :	LB03B1
Manufacture 2 :	<input type="button" value="v"/>
Manufacture Number 2 :	
M.S.R.P 04/2010 :	\$299.72
Description:	SOLENOID TRANSMISSION 3WAY #2 MADE IN JAPAN #GNTP

- Application 1 :** TOYOTA CAMRY USA 2AZFE ATM 4FC 2004
- Application 2 :**
- Application 3 :**
- Application 4 :**
- Application 5 :**
- Application 6 :**
- Application 7 :**
- Application 8 :**
- Application 9 :**
- Application 10 :**
- Application 11 :**
- Application 12 :**

ZOOM+ ZOOM-



PARTS IMAGE



BOX IMAGE

35230-33010

SOLENOID TRANSMISSION

Parts Number : 35230-33010

Manufacture 1 : NACHI

Manufacturer Number 1 : JE11BJ

Manufacture 2 :

Manufacture Number 2 :

M.S.R.P 04/2010 : \$299.29

Description: SOLENOID TRANSMISSION 3WAY
#2
MADE IN JAPAN #GNTP

Application 1 : TOYOTA CAMRY USA 1MZFE ATM 5FC 2004

Application 2 :

Application 3 : 2005 TOYOTA SIENNA 3MZFE ATM 5D 07S

Application 4 : 2005 LEXUS ES300/330 USA 3MZFE ATM

Application 5 :

Application 6 :

Application 7 :

Application 8 :

Application 9 :

Application 10 :

Application 11 :

Application 12 :

ZOOM+ ZOOM-



PARTS IMAGE



BOX IMAGE

35230-33020

SOLENOID TRANSMISSION

Parts Number :	35230-33020
Manufacture 1 :	NACHI <input type="text"/>
Manufacturer Number 1 :	LE13BJ <input type="text"/>
Manufacture 2 :	<input type="text"/>
Manufacturer Number 2 :	<input type="text"/>
M.S.R.P 04/2010 :	\$299.29
Description:	SOLENOID TRANSMISSION 3WAY #2 MADE IN JAPAN #GNTP

- Application 1 :** TOYOTA CAMRY USA 1MZFE ATM 5FC 2004
- Application 2 :**
- Application 3 :** 2005 TOYOTA SIENNA 3MZFE ATM 5D 07S
- Application 4 :** 2005 LEXUS ES300/330 USA 3MZFE ATM
- Application 5 :**
- Application 6 :**
- Application 7 :**
- Application 8 :**
- Application 9 :**
- Application 10 :**
- Application 11 :**
- Application 12 :**

ZOOM+ ZOOM-



PARTS IMAGE



BOX IMAGE

35230-52010 /11

SOLENOID TRANSMISSION

Parts Number : 35230-52010 /11

Manufacture 1 : NACHI

Manufacturer Number 1 : Y1110790

Manufacture 2 :

Manufacture Number 2 :

M.S.R.P 04/2010 : \$299.29

Description: SOLENOID TRANSMISSION 3WAY
#2
MADE IN JAPAN #GNTP

Application 1 : 2005 TOYOTA CELICA 1ZZFE ATM 4FC

Application 2 :

Application 3 :

Application 4 :

Application 5 :

Application 6 :

Application 7 :

Application 8 :

Application 9 :

Application 10 :

Application 11 :

Application 12 :

ZOOM+ ZOOM-



PARTS IMAGE



BOX IMAGE

35230-52011 /10

SOLENOID TRANSMISSION

Parts Number : 35230-52011 /10

Manufacture 1 : NACHI

Manufacturer Number 1 : YI110790

Manufacture 2 :

Manufacture Number 2 :

M.S.R.P 04/2010 : \$299.29

Description: SOLENOID TRANSMISSION 3WAY
#2
MADE IN JAPAN #GNTP

Application 1 : 2005 TOYOTA CELICA 1ZZFE ATM 4FC

Application 2 :

Application 3 :

Application 4 :

Application 5 :

Application 6 :

Application 7 :

Application 8 :

Application 9 :

Application 10 :

Application 11 :

Application 12 :

ZOOM+ ZOOM-



PARTS IMAGE



BOX IMAGE

35240-32010

SOLENOID TRANSMISSION

Parts Number : 35240-32010

Manufacture 1 :

Manufacturer Number 1 :

238

Manufacture 2 :

Manufacturer Number 2 :

M.S.R.P 04/2010 : \$299.72

Description: SOLENOID TRANSMISSION
MADE IN JAPAN #GNTP

Application 1 : 2005 TOYOTA CELICA 2ZZGE ATM 4FC

Application 2 :

Application 3 :

Application 4 :

Application 5 :

Application 6 :

Application 7 :

Application 8 :

Application 9 :

Application 10 :

Application 11 :

Application 12 :

ZOOM+

ZOOM-

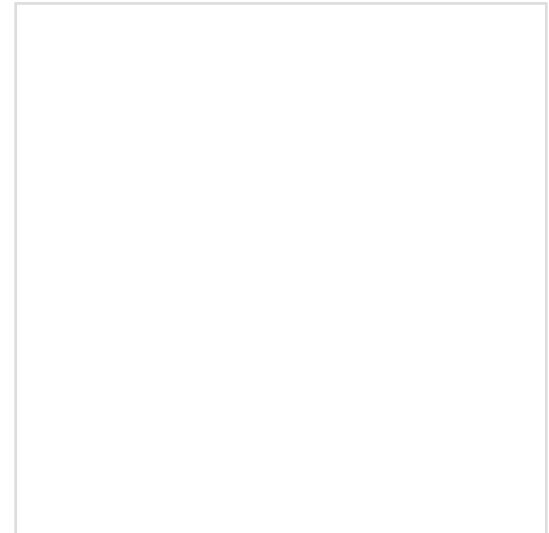

PARTS IMAGE

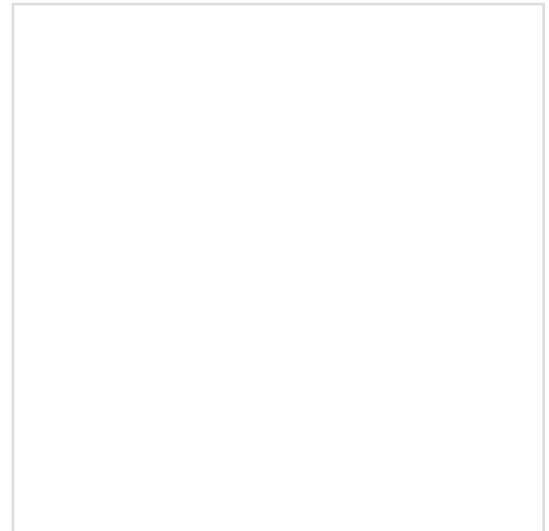

BOX IMAGE

35240-33030

SOLENOID TRANSMISSION

Parts Number : 35240-33030

Manufacture 1 : DENSO

Manufacturer Number 1 :

Manufacture 2 :

Manufacture Number 2 :

M.S.R.P 04/2010 : \$299.29

Description: SOLENOID TRANSMISSION 3WAY
MADE IN JAPAN #GNTP

Application 1 : TOYOTA CAMRY USA 1MZFE ATM 5FC 2004

Application 2 : TOYOTA CAMRY USA USA 2AZFE ATM 5FC 2007

Application 3 : 2005 TOYOTA SIENNA 3MZFE ATM 5D 07S

Application 4 :

Application 5 :

Application 6 :

Application 7 :

Application 8 :

Application 9 :

Application 10 :

Application 11 :

Application 12 :

ZOOM+

ZOOM-



PARTS IMAGE



BOX IMAGE

35240-52010

SOLENOID TRANSMISSION

Parts Number : 35240-52010

Manufacture 1 :

Manufacturer Number 1 : 240

Manufacture 2 :

Manufacture Number 2 :

M.S.R.P 04/2010 : \$299.29

Description: SOLENOID TRANSMISSION 3WAY
MADE IN JAPAN #GNTP

Application 1 : 2005 TOYOTA CELICA 1ZZFE ATM 4FC

Application 2 :

Application 3 :

Application 4 :

Application 5 :

Application 6 :

Application 7 :

Application 8 :

Application 9 :

Application 10 :

Application 11 :

Application 12 :

ZOOM+

ZOOM-

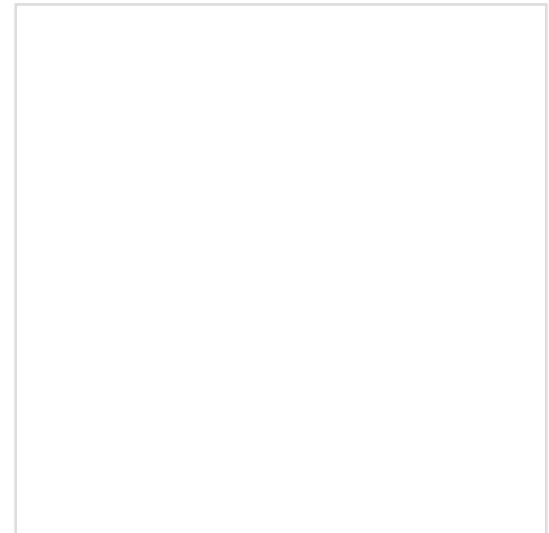

PARTS IMAGE

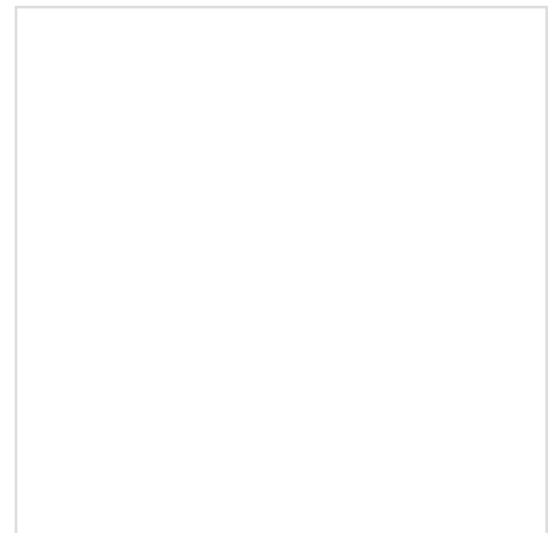

BOX IMAGE

35250-52010

SOLENOID TRANSMISSION #3

Parts Number : 35250-52010

Manufacture 1 : DENSO

Manufacturer Number 1 :

Manufacture 2 :

Manufacture Number 2 :

M.S.R.P 04/2010 : \$299.72

Description: SOLENOID TRANSMISSION #3
MADE IN JAPAN #GNTP

Application 1 : 2005 TOYOTA CELICA 1ZZFE ATM 4FC

Application 2 :

Application 3 :

Application 4 :

Application 5 :

Application 6 :

Application 7 :

Application 8 :

Application 9 :

Application 10 :

Application 11 :

Application 12 :

ZOOM+

ZOOM-



PARTS IMAGE



BOX IMAGE

35250-SA5-684

SWITCH TURN SIGNAL

Parts Number : 35250-SA5-684

Manufacture 1 : TEC TOYO

Manufacturer Number 1 :

Manufacture 2 :

Manufacture Number 2 :

M.S.R.P 04/2010 : \$238.33

Description: SWITCH TURN SIGNAL
MADE IN JAPAN #G

Application 1 : HONDA ACCORD 3D/4D 84-85

Application 2 :

Application 3 :

Application 4 :

Application 5 :

Application 6 :

Application 7 :

Application 8 :

Application 9 :

Application 10 :

Application 11 :

Application 12 :

ZOOM+

ZOOM-



PARTS IMAGE

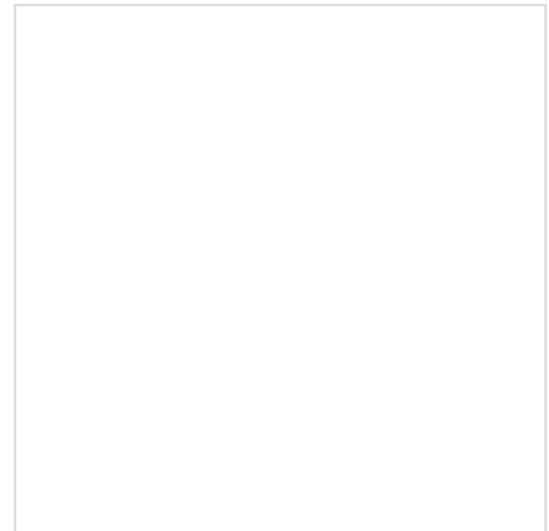

BOX IMAGE

35250-SR3-A22

SWITCH STEERING ASSEMBLY

Parts Number : 35250-SR3-A22

Manufacture 1 : TEC TOYO

Manufacturer Number 1 : 4SW06858

Manufacture 2 :

Manufacturer Number 2 :

M.S.R.P 04/2010 : \$239.28

Description: SWITCH STEERING ASSEMBLY
MADE IN JAPAN #OEM

Application 1 : HONDA CIVIC 2D 93-95

Application 2 : HONDA CIVIC 4D 92-95

Application 3 :

Application 4 :

Application 5 :

Application 6 :

Application 7 :

Application 8 :

Application 9 :

Application 10 :

Application 11 :

Application 12 :

ZOOM+

ZOOM-



PARTS IMAGE

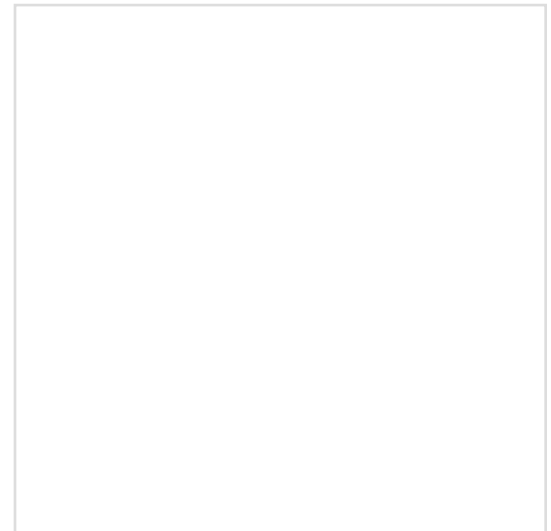

BOX IMAGE

35255-SR3-A02

Parts Number : 35255-SR3-A02

Manufacture 1 : TEC TOYO

Manufacturer Number 1 : 4OT08834

Manufacture 2 :

Manufacturer Number 2 :

M.S.R.P 04/2010 : \$130.05

Description: SWITCH HEADLAMP LIGHT
MADE IN JAPAN #OEM

SWITCH HEADLAMP LIGHT

ZOOM+

ZOOM-



PARTS IMAGE

Application 1 : HONDA CIVIC 2D 93-95

Application 2 : HONDA CVIC 3D 92-95

Application 3 : HONDA CIVIC 4D 92-95

Application 4 : ACURA INTEGRA 94-95

Application 5 :

Application 6 :

Application 7 :

Application 8 :

Application 9 :

Application 10 :

Application 11 :

Application 12 :



BOX IMAGE

35255-SR3-G02

Parts Number : 35255-SR3-G02

Manufacture 1 : TEC TOYO

Manufacturer Number 1 : 4OT08924

Manufacture 2 :

Manufacturer Number 2 :

M.S.R.P 04/2010 : \$131.92

Description: SWITCH HEADLAMP LIGHT
MADE IN JAPAN #OEM

Application 1 : HONDA CIVIC 2D 96-00

Application 2 : HONDA CIVIC 4D 96-97(US) 96-00(EXP)

Application 3 : HONDA CIVIC 4D 98-00

Application 4 : HONDA CR-V 97-01

Application 5 : ACURA INTEGRA 96-01

Application 6 :

Application 7 :

Application 8 :

Application 9 :

Application 10 :

Application 11 :

Application 12 :

SWITCH HEADLAMP LIGHT

ZOOM+

ZOOM-



PARTS IMAGE



BOX IMAGE

35256-SR3-G21

SWITCH WIPER

Parts Number : 35256-SR3-G21

Manufacture 1 : TEC TOYO

Manufacturer Number 1 : 4OT07974

Manufacture 2 :

Manufacture Number 2 :

M.S.R.P 04/2010 : \$90.63

Description: SWITCH WIPER
MADE IN JAPAN #OEM

- Application 1 :** HONDA CIVIC 2D 96-00
- Application 2 :** HONDA CIVIC 3D 96-00
- Application 3 :** HONDA CIVIC 96-97(US) 96-00(EXP)
- Application 4 :** HONDA CIVIC 4D 98-00
- Application 5 :** ACURA INTEGRA 2D TYPE R 97-99
- Application 6 :** ACURA INTEGRA 4D 96-01
- Application 7 :**
- Application 8 :**
- Application 9 :**
- Application 10 :**
- Application 11 :**
- Application 12 :**

ZOOM+ ZOOM-



PARTS IMAGE



BOX IMAGE

35260-SF1-A92

Parts Number : 35260-SF1-A92

Manufacture 1 : TEC TOYO

Manufacturer Number 1 : 4OT06863

Manufacture 2 :

Manufacturer Number 2 :

M.S.R.P 04/2010 : \$152.33

Description: SWITCH HEADLAMP LIGHT
MADE IN JAPAN #OEM

Application 1 : HONDA PRELUDE 88-91

Application 2 :

Application 3 :

Application 4 :

Application 5 :

Application 6 :

Application 7 :

Application 8 :

Application 9 :

Application 10 :

Application 11 :

Application 12 :

SWITCH HEADLAMP LIGHT

ZOOM+

ZOOM-



PARTS IMAGE

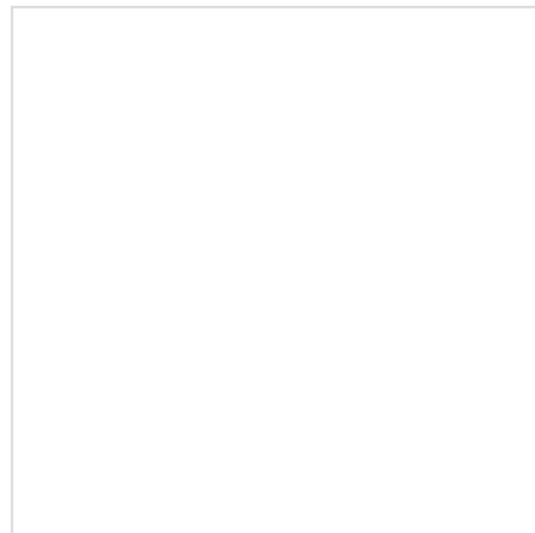

BOX IMAGE

35270-33020

SOLENOID TRANSMISSION

Parts Number : 35270-33020

Manufacture 1 : DENSO

Manufacturer Number 1 : 079600-1220

Manufacture 2 :

Manufacturer Number 2 :

M.S.R.P 04/2010 :

Description: SOLENOID TRANSMISSION
MADE IN JAPAN #OEMNTP

Application 1 :

Application 2 :

Application 3 :

Application 4 :

Application 5 :

Application 6 :

Application 7 :

Application 8 :

Application 9 :

Application 10 :

Application 11 :

Application 12 :

ZOOM+

ZOOM-



PARTS IMAGE



BOX IMAGE

35270-52010

SOLENOID TRANSMISSION

Parts Number : 35270-52010

Manufacture 1 :

Manufacturer Number 1 : 243

Manufacture 2 :

Manufacture Number 2 :

M.S.R.P 04/2010 : \$206.17

Description: SOLENOID TRANSMISSION LOCK
UP CONTROL MADE IN JAPAN
#GNTP

Application 1 : 2005 TOYOTA CELICA 1ZZFE ATM 4FC

Application 2 :

Application 3 :

Application 4 :

Application 5 :

Application 6 :

Application 7 :

Application 8 :

Application 9 :

Application 10 :

Application 11 :

Application 12 :

ZOOM+

ZOOM-

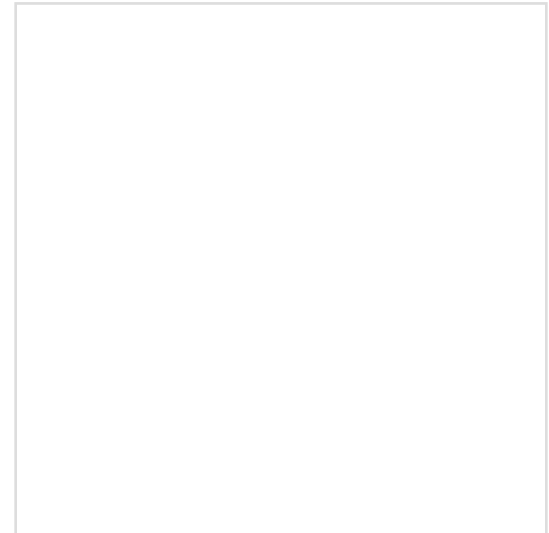

PARTS IMAGE

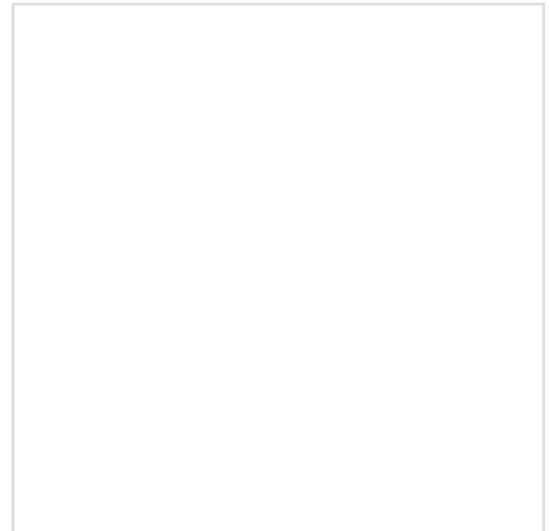

BOX IMAGE

35270-52011

SOLENOID TRANSMISSION

Parts Number : 35270-52011

Manufacture 1 :

Manufacturer Number 1 : 244

Manufacture 2 :

Manufacture Number 2 :

M.S.R.P 04/2010 : \$206.17

Description: SOLENOID TRANSMISSION LOCK
UP CONTROL MADE IN JAPAN
#GNTP

Application 1 : 2005 TOYOTA CELICA 1ZZFE ATM 4FC

Application 2 :

Application 3 :

Application 4 :

Application 5 :

Application 6 :

Application 7 :

Application 8 :

Application 9 :

Application 10 :

Application 11 :

Application 12 :

ZOOM+

ZOOM-



PARTS IMAGE

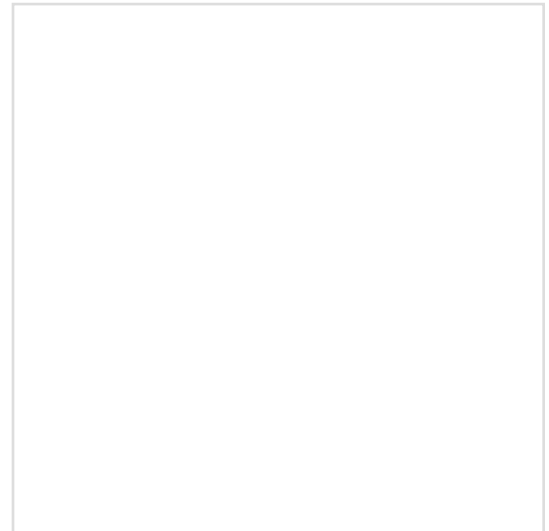

BOX IMAGE

35290-32010

SOLENOID TRANSMISSION

Parts Number : 35290-32010

Manufacture 1 :

Manufacturer Number 1 :

Manufacture 2 :

Manufacture Number 2 :

M.S.R.P 04/2010 : \$198.17

Description: SOLENOID TRANSMISSION
PRESSURE CONTROL MADE IN
JAPAN #GNTF

Application 1 : 2005 TOYOTA CELICA 2ZZGE ATM 4FC

Application 2 :

Application 3 :

Application 4 :

Application 5 :

Application 6 :

Application 7 :

Application 8 :

Application 9 :

Application 10 :

Application 11 :

Application 12 :

ZOOM+ ZOOM-



PARTS IMAGE



BOX IMAGE

35290-45010

SOLENOID TRANSMISSION

Parts Number : 35290-45010

Manufacture 1 :

Manufacturer Number 1 :

Manufacture 2 :

Manufacture Number 2 :

M.S.R.P 04/2010 : \$198.17

Description: SOLENOID TRANSMISSION
PRESSURE CONTROL MADE IN
JAPAN #GNTP

Application 1 : TOYOTA CAMRY USA 1MZFE ATM 5FC 2004

Application 2 : TOYOTA CAMRY USA USA 2AZFE ATM 5FC 2007

Application 3 : 2005 TOYOTA SIENNA 3MZFE ATM 5D 07S

Application 4 :

Application 5 :

Application 6 :

Application 7 :

Application 8 :

Application 9 :

Application 10 :

Application 11 :

Application 12 :

ZOOM+

ZOOM-



PARTS IMAGE



BOX IMAGE

35290-52020

SOLENOID TRANSMISSION

Parts Number :	35290-52020
Manufacture 1 :	<input type="text"/>
Manufacturer Number 1 :	247
Manufacture 2 :	<input type="text"/>
Manufacturer Number 2 :	<input type="text"/>
M.S.R.P 04/2010 :	\$206.17
Description:	SOLENOID TRANSMISSION PRESSURE CONTROL MADE IN JAPAN #GNTF

- Application 1 :** 2005 TOYOTA CELICA 1ZZFE ATM 4FC
- Application 2 :**
- Application 3 :**
- Application 4 :**
- Application 5 :**
- Application 6 :**
- Application 7 :**
- Application 8 :**
- Application 9 :**
- Application 10 :**
- Application 11 :**
- Application 12 :**

ZOOM+ ZOOM-

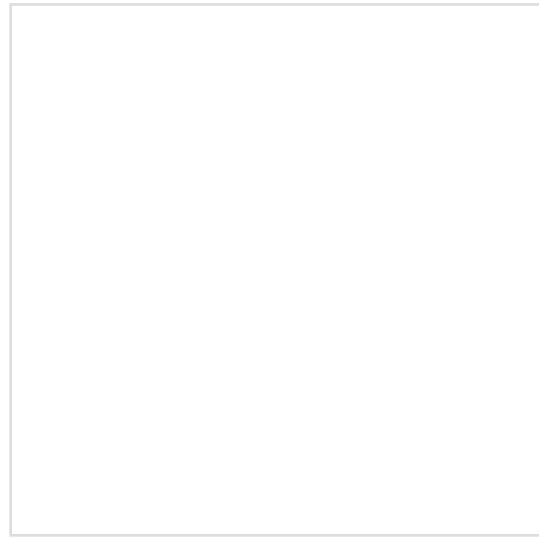

PARTS IMAGE

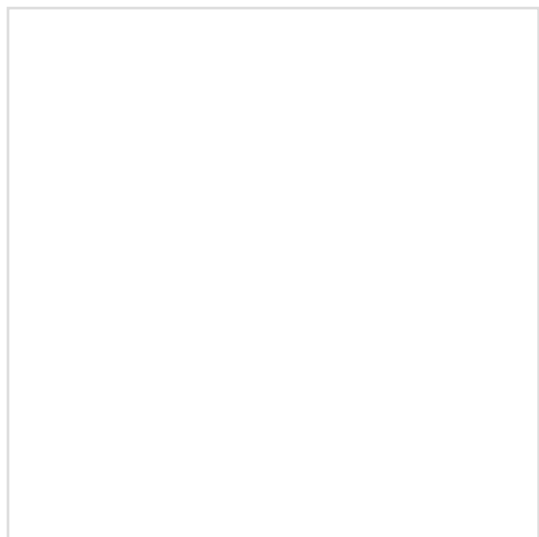

BOX IMAGE

35290-52030

SOLENOID TRANSMISSION

Parts Number : 35290-52030

Manufacture 1 :

Manufacturer Number 1 : 248

Manufacture 2 :

Manufacture Number 2 :

M.S.R.P 04/2010 :

Description: SOLENOID TRANSMISSION
MADE IN JAPAN #GNTP

Application 1 :

Application 2 :

Application 3 :

Application 4 :

Application 5 :

Application 6 :

Application 7 :

Application 8 :

Application 9 :

Application 10 :

Application 11 :

Application 12 :

ZOOM+

ZOOM-



PARTS IMAGE



BOX IMAGE

35700-SK7-A01

SWITCH INHIBITER MADE IN

Parts Number : 35700-SK7-A01

Manufacture 1 : TEC TOYO

Manufacturer Number 1 :

Manufacture 2 :

Manufacture Number 2 :

M.S.R.P 04/2010 : \$57.60

Description: SWITCH INHIBITER MADE IN JAPAN #OEMNTP

Application 1 : ACURA INTEGRA 3D 90-93

Application 2 : ACURA INTEGRA 4D 90-93

Application 3 :

Application 4 :

Application 5 :

Application 6 :

Application 7 :

Application 8 :

Application 9 :

Application 10 :

Application 11 :

Application 12 :

ZOOM+ ZOOM-



PARTS IMAGE

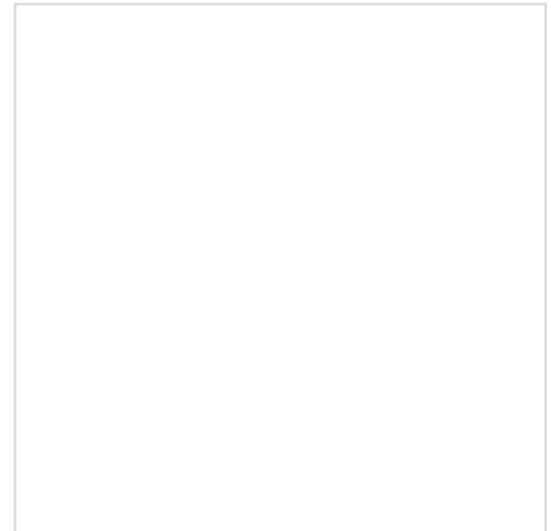

BOX IMAGE

35700-SM4-A92

SWITCH NEUTRAL SAFETY

Parts Number : 35700-SM4-A92

Manufacture 1 : TEC TOYO

Manufacturer Number 1 : 4SW05951

Manufacture 2 :

Manufacture Number 2 :

M.S.R.P 04/2010 : \$57.20

Description: SWITCH NEUTRAL SAFETY
MADE IN JAPAN #OEM

Application 1 : HONDA ACCORD 2D 90-93

Application 2 : HONDA ACCORD 2D 94-97

Application 3 : HONDA ACCORD 4D 90-93

Application 4 : HONDA ACCORD 4D 94-97 E2/V6 E2

Application 5 : HONDA ACCORD WAGON 91-93

Application 6 : HONDA ACCORD WAGON 94-97

Application 7 : ACURA CL AT 97-99

Application 8 :

Application 9 :

Application 10 :

Application 11 :

Application 12 :

ZOOM+

ZOOM-



PARTS IMAGE

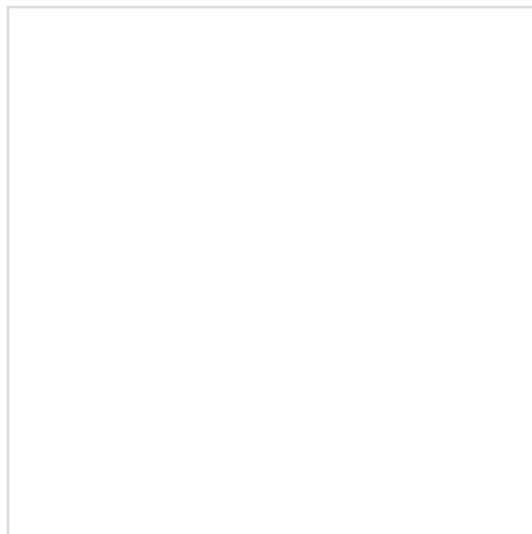

BOX IMAGE

36162-PT3-001

VALVE ASSEMBLY MADE IN

Parts Number : 36162-PT3-001

Manufacture 1 : ▼

Manufacturer Number 1 :

Manufacture 2 : ▼

Manufacture Number 2 :

M.S.R.P 04/2010 :

Description: VALVE ASSEMBLY MADE IN JAPAN
#OEMNTP

Application 1 :

Application 2 :

Application 3 :

Application 4 :

Application 5 :

Application 6 :

Application 7 :

Application 8 :

Application 9 :

Application 10 :

Application 11 :

Application 12 :

ZOOM+ ZOOM-



PARTS IMAGE



BOX IMAGE

36162-PT3-Q01

VALVE ASSEMBLY MADE IN

Parts Number : 36162-PT3-Q01

Manufacture 1 : TEC TOYO

Manufacturer Number 1 :

Manufacture 2 :

Manufacture Number 2 :

M.S.R.P 04/2010 : \$161.04

Description: VALVE ASSEMBLY MADE IN JAPAN
#OEMNTP

Application 1 : HONDA CIVIC 2D 93-95

Application 2 : HONDA CIVIC 3D 92-95

Application 3 : HONDA CIVIC 4D 92-95

Application 4 : HONDA DEL SOL 93-97

Application 5 : ACURA INTEGRA 3D 94-01

Application 6 : ACURA INTEGRA 94-01

Application 7 : ACURA VIOR 92-94

Application 8 :

Application 9 :

Application 10 :

Application 11 :

Application 12 :

ZOOM+

ZOOM-



PARTS IMAGE



BOX IMAGE

36190-P13-003

Parts Number : 36190-P13-003

Manufacture 1 : KEIHIN

Manufacturer Number 1 :

Manufacture 2 :

Manufacture Number 2 :

M.S.R.P 04/2010 : \$125.26

Description: SOLENOID EGR VALVE
MADE IN JAPAN #OEM

Application 1 : HONDA ACCORD 2D 94-97

Application 2 : HONDA ACCORD 4D 94-97 E2/V6 E2

Application 3 : HONDA ACCORD WAGON 94-97

Application 4 : HONDA ODYSSEY 95-98

Application 5 : HONDA PRELUDE 92-96

Application 6 : HONDA PRELUDE 97-01

Application 7 : ACURA 2.2L 1997

Application 8 :

Application 9 :

Application 10 :

Application 11 :

Application 12 :

SOLENOID EGR VALVE

ZOOM+

ZOOM-



PARTS IMAGE



BOX IMAGE

36450-P08-004

Parts Number :	36450-P08-004
Manufacture 1 :	TEC TOYO <input type="button" value="v"/>
Manufacturer Number 1 :	
Manufacture 2 :	<input type="button" value="v"/>
Manufacture Number 2 :	
M.S.R.P 04/2010 :	\$260.07
Description:	IDLE SPEED CONTROL MADE IN JAPAN #OEMSPNTP

- Application 1 :** HONDA CIVIC 2D 93-95
- Application 2 :** HONDA CIVIC 3D 92-95
- Application 3 :** HONDA CIVIC 4D 92-95
- Application 4 :** HONDA DEL SOL 93-97
- Application 5 :**
- Application 6 :**
- Application 7 :**
- Application 8 :**
- Application 9 :**
- Application 10 :**
- Application 11 :**
- Application 12 :**

IDLE SPEED CONTROL

ZOOM+ ZOOM-



PARTS IMAGE



BOX IMAGE

36450-P0A-A01

Parts Number : 36450-P0A-A01

Manufacture 1 : DENSO

Manufacturer Number 1 : 138200-0470

Manufacture 2 :

Manufacturer Number 2 :

M.S.R.P 04/2010 : \$350.48

Description: IDLE SPEED CONTROL
MADE IN JAPAN #OEM

Application 1 : HONDA ACCORD 2D 94-97

Application 2 : HONDA ACCORD 4D 94-97

Application 3 : HONDA ACCORD WAGON 94-97

Application 4 : ACURA CL 2.2L 1997

Application 5 :

Application 6 :

Application 7 :

Application 8 :

Application 9 :

Application 10 :

Application 11 :

Application 12 :

IDLE SPEED CONTROL

ZOOM+

ZOOM-



PARTS IMAGE



BOX IMAGE

36450-P0B-A01

Parts Number : 36450-P0B-A01

Manufacture 1 : DENSO

Manufacturer Number 1 : 138200-0480

Manufacture 2 :

Manufacturer Number 2 :

M.S.R.P 04/2010 : \$350.53

Description: IDLE SPEED CONTROL
MADE IN JAPAN #OEM

Application 1 : HONDA ACCORD 94-97

Application 2 : HONDA ACCORD 4D 94-97 E2 V6 E2

Application 3 : HONDA ACCORD WAGON 94-97

Application 4 : HONDA ODYSSEY 95-98

Application 5 :

Application 6 :

Application 7 :

Application 8 :

Application 9 :

Application 10 :

Application 11 :

Application 12 :

IDLE SPEED CONTROL

ZOOM+

ZOOM-



PARTS IMAGE



BOX IMAGE

36450-P0D-004

IDLE SPEED CONTROL

Parts Number : 36450-P0D-004

Manufacture 1 : TEC TOYO

Manufacturer Number 1 : 138200-0425

Manufacture 2 :

Manufacture Number 2 :

M.S.R.P 04/2010 : \$283.55

Description: IDLE SPEED CONTROL
MADE IN JAPAN #OEMSPNTP

Application 1 : HONDA CR-V 97-01

Application 2 :

Application 3 :

Application 4 :

Application 5 :

Application 6 :

Application 7 :

Application 8 :

Application 9 :

Application 10 :

Application 11 :

Application 12 :

ZOOM+

ZOOM-



PARTS IMAGE



BOX IMAGE

36450-P13-004

IDLE SPEED CONTROL

Parts Number : 36450-P13-004

Manufacture 1 : TEC TOYO

Manufacturer Number 1 :

Manufacture 2 :

Manufacture Number 2 :

M.S.R.P 04/2010 : \$368.45

Description: IDLE SPEED CONTROL
MADE IN JAPAN #OEM

Application 1 : HONDA PRELUDE 92-96

Application 2 : HONDA PRELUDE 97-01

Application 3 :

Application 4 :

Application 5 :

Application 6 :

Application 7 :

Application 8 :

Application 9 :

Application 10 :

Application 11 :

Application 12 :

ZOOM+

ZOOM-



PARTS IMAGE



BOX IMAGE

36450-P28-A01

Parts Number : 36450-P28-A01

Manufacture 1 : DENSO

Manufacturer Number 1 : 138200-0420

Manufacture 2 :

Manufacturer Number 2 :

M.S.R.P 04/2010 : \$234.55

Description: IDLE SPEED CONTROL
MADE IN JAPAN #OEM

Application 1 : HONDA CIVIC 2D 93-95

Application 2 : HONDA CIVIC 3D 92-95

Application 3 : HONDA CIVIC 4D 92-95

Application 4 : HONDA DEL SOL 93-97

Application 5 : ACURA INTEGRA 92-93

Application 6 : ACURA INTEGRA 94-97

Application 7 :

Application 8 :

Application 9 :

Application 10 :

Application 11 :

Application 12 :

IDLE SPEED CONTROL

ZOOM+

ZOOM-



PARTS IMAGE



BOX IMAGE

36450-PK2-023

IDLE SPEED CONTROL

Parts Number : 36450-PK2-023

Manufacture 1 : DENSO

Manufacturer Number 1 : 138200-0340

Manufacture 2 :

Manufacturer Number 2 :

M.S.R.P 04/2010 : \$269.00

Description: IDLE SPEED CONTROL
MADE IN JAPAN #OEM

Application 1 : HONDA ACCORD 2D 88-89

Application 2 : HONDA ACCORD 3D/4D 86-89

Application 3 : HONDA PRELUDE 88-91

Application 4 :

Application 5 :

Application 6 :

Application 7 :

Application 8 :

Application 9 :

Application 10 :

Application 11 :

Application 12 :

ZOOM+

ZOOM-



PARTS IMAGE



BOX IMAGE

36450-PM8-A02

IDLE SPEED CONTROL

Parts Number : 36450-PM8-A02

Manufacture 1 : DENSO

Manufacturer Number 1 : 18200-0330

Manufacture 2 :

Manufacturer Number 2 :

M.S.R.P 04/2010 : \$241.67

Description: IDLE SPEED CONTROL
MADE IN JAPAN #G

Application 1 : HONDA CRX 88-91

Application 2 :

Application 3 :

Application 4 :

Application 5 :

Application 6 :

Application 7 :

Application 8 :

Application 9 :

Application 10 :

Application 11 :

Application 12 :

ZOOM+

ZOOM-



PARTS IMAGE



BOX IMAGE

36450-PR4-A01

IDLE SPEED CONTROL

Parts Number : 36450-PR4-A01

Manufacture 1 : DENSO

Manufacturer Number 1 : 138200-0251

Manufacture 2 :

Manufacture Number 2 :

M.S.R.P 04/2010 : \$276.28

Description: IDLE SPEED CONTROL
MADE IN JAPAN #G

Application 1 : ACURA INTEGRA 1991

Application 2 :

Application 3 :

Application 4 :

Application 5 :

Application 6 :

Application 7 :

Application 8 :

Application 9 :

Application 10 :

Application 11 :

Application 12 :

ZOOM+

ZOOM-



PARTS IMAGE

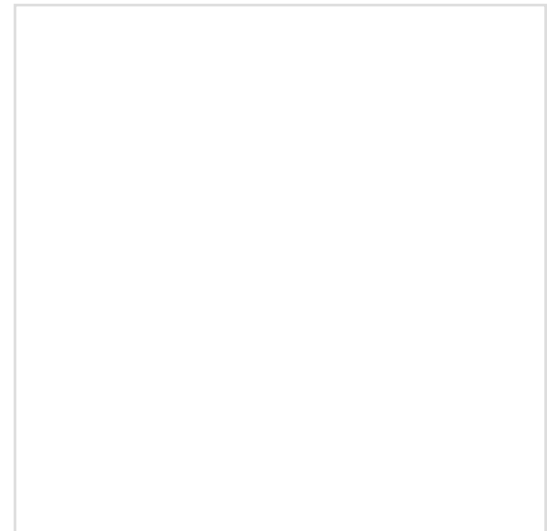

BOX IMAGE

36450-PW1-G01

Parts Number : 36450-PW1-G01

Manufacture 1 : DENSO

Manufacturer Number 1 : 138200-310

Manufacture 2 :

Manufacturer Number 2 :

M.S.R.P 04/2010 : \$315.05

Description: IDLE SPEED CONTROL
MADE IN JAPAN #OEM

Application 1 : HONDA CIVIC 3D 88-91

Application 2 : HONDA CIVIC 4D 88-91

Application 3 : HONDA CIVIC WAGON 88-91

Application 4 : HONDA CRX 88-91

Application 5 :

Application 6 :

Application 7 :

Application 8 :

Application 9 :

Application 10 :

Application 11 :

Application 12 :

IDLE SPEED CONTROL

ZOOM+

ZOOM-



PARTS IMAGE



BOX IMAGE

36460-PAA-A01

IDLE SPEED CONTROL

Parts Number : 36460-PAA-A01

Manufacture 1 : DENSO

Manufacturer Number 1 : 136800-1133

Manufacture 2 :

Manufacture Number 2 :

M.S.R.P 04/2010 : \$204.98

Description: IDLE SPEED CONTROL
MADE IN JAPAN #OEM

Application 1 : HONDA ACCORD 4D 2002

Application 2 : HONDA ACCORD 4D 98-01

Application 3 : HONDA ODYSSEY 95-98

Application 4 : ACURA CL 2.3L 98-99

Application 5 :

Application 6 :

Application 7 :

Application 8 :

Application 9 :

Application 10 :

Application 11 :

Application 12 :

ZOOM+

ZOOM-



PARTS IMAGE

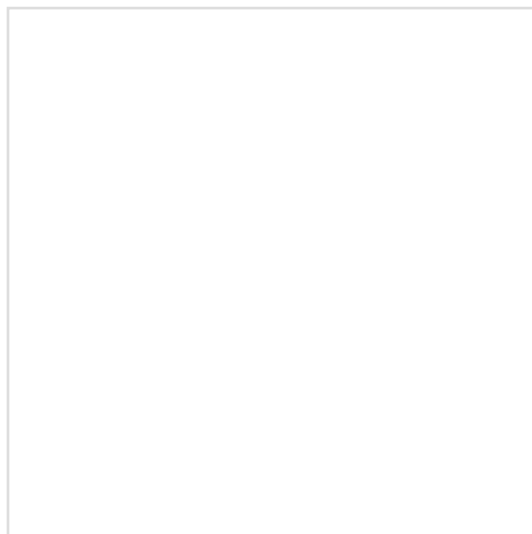

BOX IMAGE

36460-PAA-L21

Parts Number : 36460-PAA-L21

Manufacture 1 : DENSO

Manufacturer Number 1 : 136800-1143

Manufacture 2 :

Manufacturer Number 2 :

M.S.R.P 04/2010 : \$265.78

Description: IDLE SPEED CONTROL
MADE IN JAPAN #OEM

Application 1 : HONDA ACCORD 2D 98-02

Application 2 : HONDA ACCORD 4D 2002

Application 3 : HONDA ACCORD 4D 98-01

Application 4 :

Application 5 :

Application 6 :

Application 7 :

Application 8 :

Application 9 :

Application 10 :

Application 11 :

Application 12 :

IDLE SPEED CONTROL

ZOOM+

ZOOM-



PARTS IMAGE

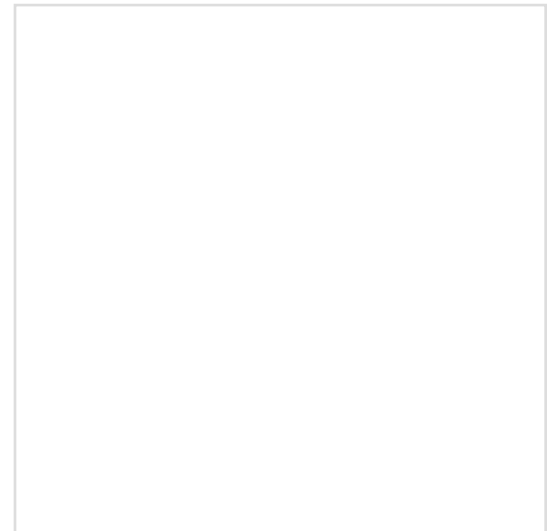

BOX IMAGE

36531-PRB-A11

SENSOR LAF / OXYGEN

Parts Number : 36531-PRB-A11

Manufacture 1 : DENSO

Manufacturer Number 1 : 21200-218

Manufacture 2 :

Manufacturer Number 2 :

M.S.R.P 04/2010 : \$301.87

Description: SENSOR LAF / OXYGEN
MADE IN JAPAN #OEM

Application 1 : ACURA RSX TYPE S 05-06 FRONT

Application 2 :

Application 3 :

Application 4 :

Application 5 :

Application 6 :

Application 7 :

Application 8 :

Application 9 :

Application 10 :

Application 11 :

Application 12 :

ZOOM+

ZOOM-



PARTS IMAGE

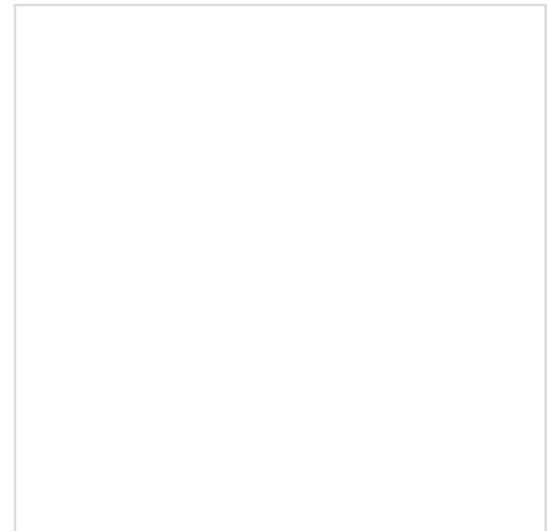

BOX IMAGE

36531-RBB-003

SENSOR OXYGEN SENSOR

Parts Number :	36531-RBB-003
Manufacture 1 :	DENSO <input type="button" value="v"/>
Manufacturer Number 1 :	234-9066 / 211200-2050
Manufacture 2 :	<input type="button" value="v"/>
Manufacturer Number 2 :	
M.S.R.P 04/2010 :	\$286.65
Description:	SENSOR OXYGEN SENSOR FRONT MADE IN JAPAN

- Application 1 :** ACURA TSX 04-08
- Application 2 :**
- Application 3 :**
- Application 4 :**
- Application 5 :**
- Application 6 :**
- Application 7 :**
- Application 8 :**
- Application 9 :**
- Application 10 :**
- Application 11 :**
- Application 12 :**

ZOOM+ ZOOM-



PARTS IMAGE

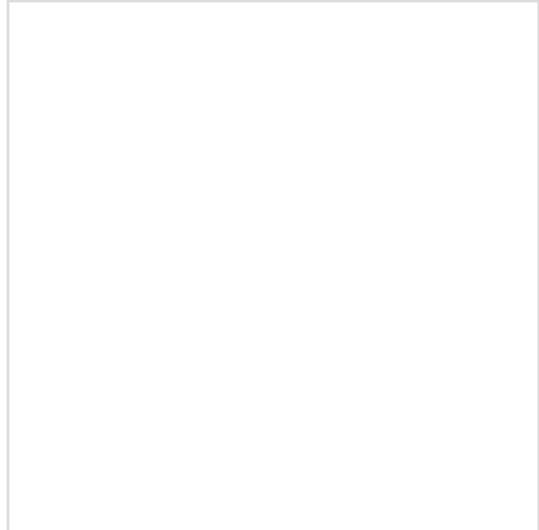

BOX IMAGE

36532-PZA-J01

SENSOR OXYGEN SENSOR RR

Parts Number : 36532-PZA-J01

Manufacture 1 : NTK

Manufacturer Number 1 : 545-H6

Manufacture 2 :

Manufacture Number 2 :

M.S.R.P 04/2010 : \$280.85

Description: SENSOR OXYGEN SENSOR RR
MADE IN JAPAN #OEM

Application 1 : HONDA RR

Application 2 :

Application 3 :

Application 4 :

Application 5 :

Application 6 :

Application 7 :

Application 8 :

Application 9 :

Application 10 :

Application 11 :

Application 12 :

ZOOM+ ZOOM-



PARTS IMAGE

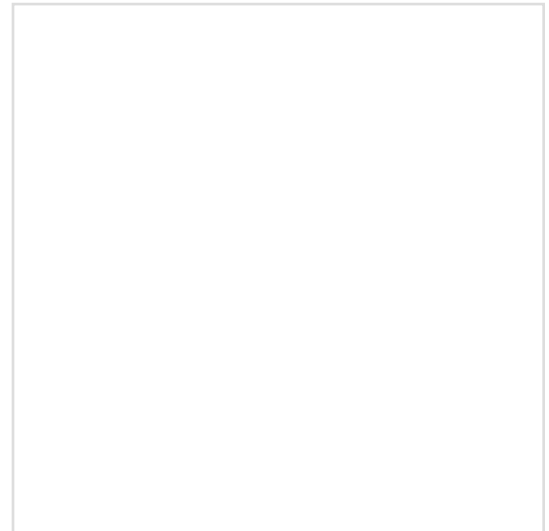

BOX IMAGE

36750-S04-003

SWITCH STOP LAMP

Parts Number : 36750-S04-003

Manufacture 1 : PANASONIC / MATSUSHITA

Manufacturer Number 1 : ESB2497

Manufacture 2 :

Manufacture Number 2 :

M.S.R.P 04/2010 : \$42.73

Description: SWITCH STOP LAMP
MADE IN JAPAN #OEM

Application 1 : HONDA CIVIC 2D 96-00

Application 2 : HONDA CIVIC 96-97(US) 96-00(EXP)

Application 3 : HONDA CIVIC 4D 98-00

Application 4 : HONDA CR-V 97-01

Application 5 : HONDA PRELUDE 97-01

Application 6 : ACURA RL 3.5L 96-04

Application 7 :

Application 8 :

Application 9 :

Application 10 :

Application 11 :

Application 12 :

ZOOM+ ZOOM-



PARTS IMAGE

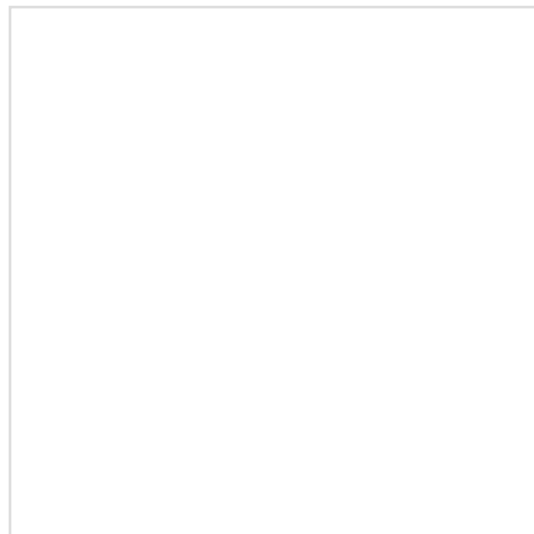

BOX IMAGE

36750-SR3-003

SWITCH STOP LAMP

Parts Number : 36750-SR3-003

Manufacture 1 : TEC TOYO

Manufacturer Number 1 :

Manufacture 2 :

Manufacture Number 2 :

M.S.R.P 04/2010 : \$59.07

Description: SWITCH STOP LAMP
MADE IN JAPAN #OEMSPNTP

Application 1 : HONDA CIVIC 2D 93-95

Application 2 : HONDA CIVIC 3D 92-95

Application 3 : HONDA CIVIC 4D 92-95

Application 4 : HONDA DEL SOL 93-97

Application 5 : HONDA ODYSSEY 95-98

Application 6 : ACURA TL 2.5L 95-98

Application 7 : ACURA TL 3.2L 95-98

Application 8 : ACURA INTEGRA 94-01

Application 9 :

Application 10 :

Application 11 :

Application 12 :

ZOOM+

ZOOM-



PARTS IMAGE

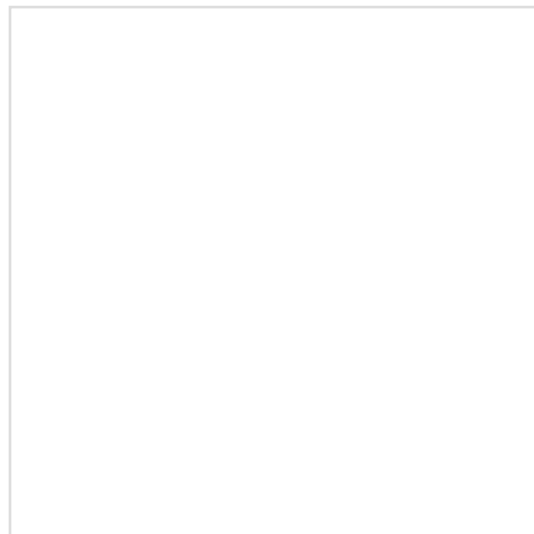

BOX IMAGE

37500-P72-A01

SENSOR TDC / CAMSHAFT

Parts Number : 37500-P72-A01

Manufacture 1 : DENSO

Manufacturer Number 1 : 029600-0550

Manufacture 2 :

Manufacture Number 2 :

M.S.R.P 04/2010 : \$139.15

Description: SENSOR TDC / CAMSHAFT
MADE IN JAPAN #OEM

Application 1 : HONDA CIVIC 96-00

Application 2 : HONDA CR-V 97-01

Application 3 : HONDA DELSOL 93-97

Application 4 : ACURA INTEGRA 96-01

Application 5 : ACURA INTEGRA TYPE R 97-01

Application 6 :

Application 7 :

Application 8 :

Application 9 :

Application 10 :

Application 11 :

Application 12 :

ZOOM+ ZOOM-



PARTS IMAGE

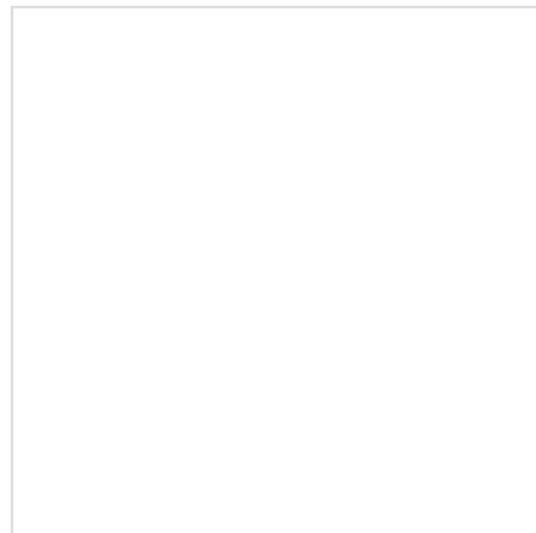

BOX IMAGE

37830-PT0-003

SENSOR MAP

Parts Number : 37830-PT0-003

Manufacture 1 : DENSO

Manufacturer Number 1 : 079800-1771

Manufacture 2 :

Manufacturer Number 2 :

M.S.R.P 04/2010 : \$328.53

Description: SENSOR MAP
MADE IN JAPAN #G

Application 1 : HONDA ACCORD 2D 90-93

Application 2 : HONDA ACCORD 4D 90-93

Application 3 : HONDA ACCORD WAGON 91-93

Application 4 :

Application 5 :

Application 6 :

Application 7 :

Application 8 :

Application 9 :

Application 10 :

Application 11 :

Application 12 :

ZOOM+

ZOOM-



PARTS IMAGE

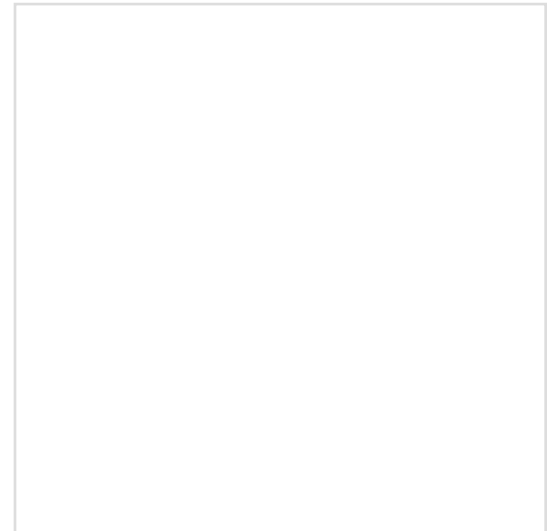

BOX IMAGE

37840-P0A-A01

SENSOR TDC / CRANKSHAFT

Parts Number : 37840-P0A-A01

Manufacture 1 : DENSO

Manufacturer Number 1 : 029600-0500

Manufacture 2 :

Manufacture Number 2 :

M.S.R.P 04/2010 : \$264.17

Description: SENSOR TDC / CRANKSHAFT
POSITION
MADE IN JAPAN #G

- Application 1 :** HONDA ACCORD 2D 94-97
- Application 2 :** HONDA ACCORD 2D 98-02
- Application 3 :** HONDA ACCORD 4D 2002
- Application 4 :** HONDA ACCORD 4D 94-97 E2 V6 E2
- Application 5 :** HONDA ACCORD 4D 98-01
- Application 6 :** HONDA ACCORD WAGON 94-97
- Application 7 :** HONDA ODYSSEY 95-98
- Application 8 :** HONDA PRELUDE 92-96
- Application 9 :** HODNA PRELUDE 97-01
- Application 10 :** ACURA CL 2.2.L &2.3L 97-99
- Application 11 :**
- Application 12 :**

ZOOM+

ZOOM-



PARTS IMAGE

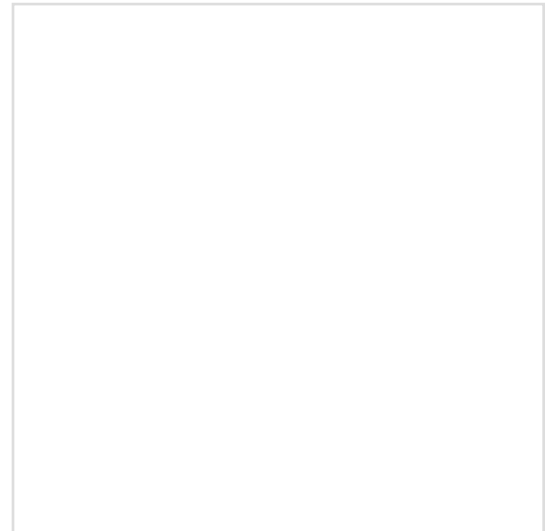

BOX IMAGE

37840-PGE-A11

SENSOR TDC / CAMSHAFT

Parts Number : 37840-PGE-A11

Manufacture 1 : DENSO

Manufacturer Number 1 : 06L08

Manufacture 2 :

Manufacture Number 2 :

M.S.R.P 04/2010 : \$79.72

Description: SENSOR TDC / CAMSHAFT
POSITION
MADE IN JAPAN #G

- Application 1 :** HONDA ACCORD 4D 03-07
- Application 2 :** HONDA ACCORD COUPE 03-07
- Application 3 :** HONDA ACCORD HYBRID 05-07
- Application 4 :** HONDA ODYSSEY 05-09
- Application 5 :** HONDA PILOT 03-08
- Application 6 :** HONDA RIDGELINE 06-09
- Application 7 :** ACURA MDX 03-09
- Application 8 :** ACURA RL 05-09
- Application 9 :**
- Application 10 :**
- Application 11 :**
- Application 12 :**

ZOOM+ ZOOM-



PARTS IMAGE

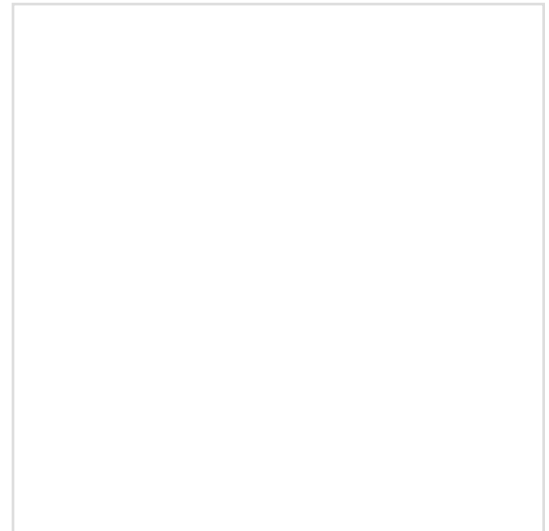

BOX IMAGE

37840-PL2-026

SENSOR TDC / CRANKSHAFT

Parts Number :	37840-PL2-026
Manufacture 1 :	TEC TOYO <input type="button" value="v"/>
Manufacturer Number 1 :	<input type="text"/>
Manufacture 2 :	<input type="button" value="v"/>
Manufacture Number 2 :	<input type="text"/>
M.S.R.P 04/2010 :	\$165.65
Description:	SENSOR TDC / CRANKSHAFT POSITION MADE IN JAPAN #OEMNTP

- Application 1 :** ACURA LEGEND 87-90
- Application 2 :** ACURA LEGEND 4D 86-90
- Application 3 :**
- Application 4 :**
- Application 5 :**
- Application 6 :**
- Application 7 :**
- Application 8 :**
- Application 9 :**
- Application 10 :**
- Application 11 :**
- Application 12 :**

ZOOM+ ZOOM-



PARTS IMAGE

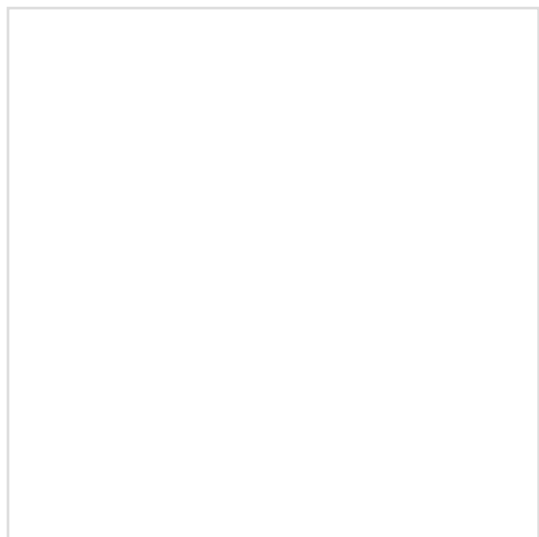

BOX IMAGE

37840-PV1-A03

SENSOR TDC / CRANKSHAFT

Parts Number : 37840-PV1-A03

Manufacture 1 : TEC TOYO

Manufacturer Number 1 :

Manufacture 2 :

Manufacture Number 2 :

M.S.R.P 04/2010 : \$236.97

Description: SENSOR TDC / CRANKSHAFT
POSITION
MADE IN JAPAN #OEMNTP

Application 1 : ACURA VIGOR 92-94

Application 2 :

Application 3 :

Application 4 :

Application 5 :

Application 6 :

Application 7 :

Application 8 :

Application 9 :

Application 10 :

Application 11 :

Application 12 :

ZOOM+

ZOOM-



PARTS IMAGE

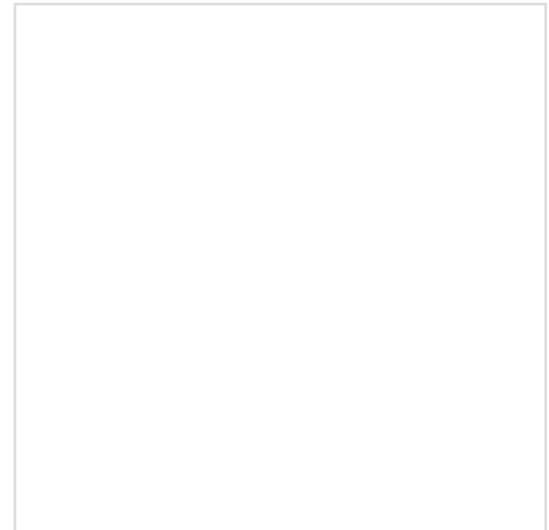

BOX IMAGE

37840-PY3-016

SENSOR CRANK POSITION

Parts Number : 37840-PY3-016

Manufacture 1 : TEC TOYO

Manufacturer Number 1 : TS-02E

Manufacture 2 :

Manufacturer Number 2 :

M.S.R.P 04/2010 : \$222.22

Description: SENSOR CRANK POSITION MADE IN JAPAN #OEM NTP

Application 1 : ACURA LEGEND 2D 91-95

Application 2 : ACURA LEGEND 4D 91-95

Application 3 :

Application 4 :

Application 5 :

Application 6 :

Application 7 :

Application 8 :

Application 9 :

Application 10 :

Application 11 :

Application 12 :

ZOOM+

ZOOM-



PARTS IMAGE

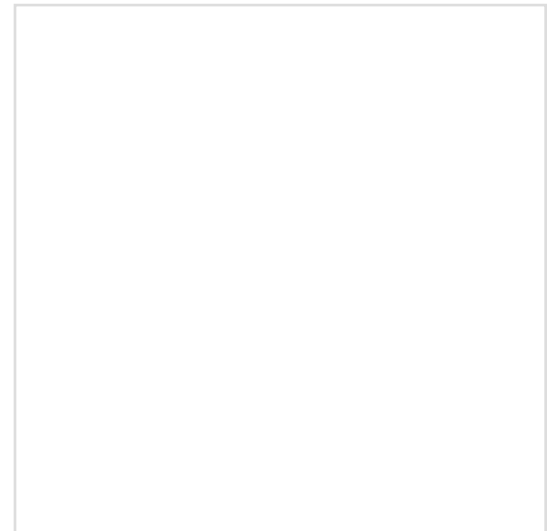

BOX IMAGE

37840-PY3-026

SENSOR TDC / CRANKSHAFT

Parts Number : 37840-PY3-026

Manufacture 1 :

Manufacturer Number 1 :

Manufacture 2 :

Manufacturer Number 2 :

M.S.R.P 04/2010 : \$207.35

Description: SENSOR TDC / CRANKSHAFT
POSITION
MADE IN JAPAN #OEM

Application 1 : ACURA LEGEND 93-95

Application 2 : ACURA TL 3.2L96-98

Application 3 : ACURA RL 96-04

Application 4 :

Application 5 :

Application 6 :

Application 7 :

Application 8 :

Application 9 :

Application 10 :

Application 11 :

Application 12 :

ZOOM+ ZOOM-



PARTS IMAGE

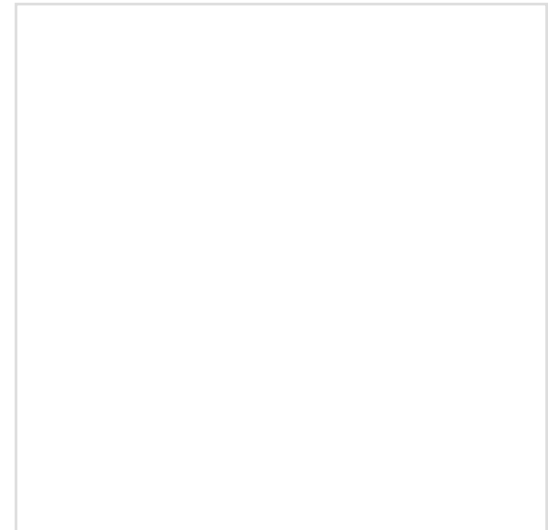

BOX IMAGE

37840-RJH-006

SENSOR TDC / CRANKSHAFT

Parts Number : 37840-RJH-006

Manufacture 1 : MITSUBISHI

Manufacturer Number 1 : J5T23992/7515 RJH

Manufacture 2 :

Manufacture Number 2 :

M.S.R.P 04/2010 : \$55.73

Description: SENSOR TDC / CRANKSHAFT
POSITION
MADE IN JAPAN #G

Application 1 : HONDA CIVIC 2D 01-05

Application 2 : HONDA CIVIC 4D 01-05

Application 3 :

Application 4 :

Application 5 :

Application 6 :

Application 7 :

Application 8 :

Application 9 :

Application 10 :

Application 11 :

Application 12 :

ZOOM+ ZOOM-



PARTS IMAGE

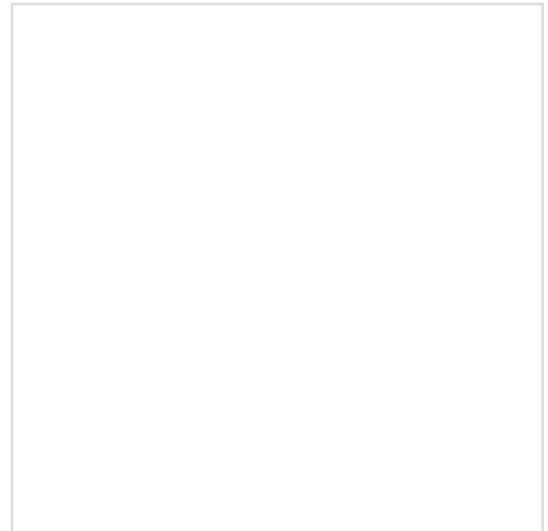

BOX IMAGE

37841-PG7-006

SENSOR TDC

Parts Number : 37841-PG7-006

Manufacture 1 : TEC TOYO

Manufacturer Number 1 :

Manufacture 2 :

Manufacture Number 2 :

M.S.R.P 04/2010 : \$163.42

Description: SENSOR TDC
MADE IN JAPAN #G

Application 1 : ACURA INTEGRA 88-89

Application 2 :

Application 3 :

Application 4 :

Application 5 :

Application 6 :

Application 7 :

Application 8 :

Application 9 :

Application 10 :

Application 11 :

Application 12 :

ZOOM+ ZOOM-



PARTS IMAGE

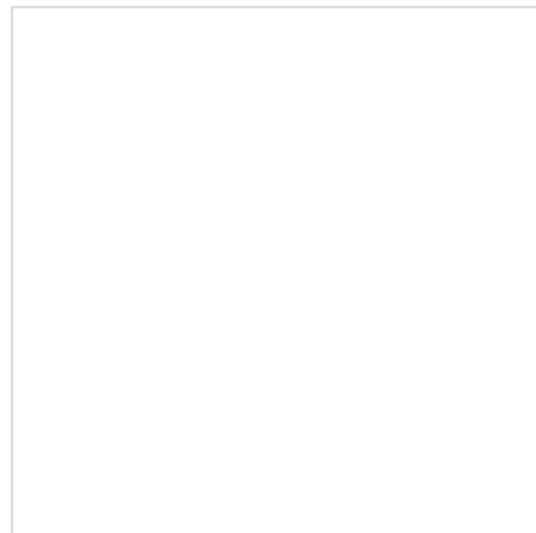

BOX IMAGE

37880-P05-A00

SENSOR AIR TEMP

Parts Number : 37880-P05-A00

Manufacture 1 : KEIHIN

Manufacturer Number 1 : K01A

Manufacture 2 :

Manufacturer Number 2 :

M.S.R.P 04/2010 : \$17.07

Description: SENSOR AIR TEMP
MADE IN JAPAN #G

Application 1 : HONDA ACCORD 2D 88-93

Application 2 : HONDA ACCORD SD/4D 84-89

Application 3 : HONDA ACCORD 4D 90-93

Application 4 : HONDA ACCORD WAGON 91-93

Application 5 : HONDA CIVIC 2D 93-95

Application 6 : HONDA CIVIC 3D 88-91

Application 7 : HONDA DEL SOL 93-97

Application 8 : HONDA PRELUDE 88-01

Application 9 : ACURA INTEGRA 90-93

Application 10 : ACURA VIGOR 92-94

Application 11 :

Application 12 :

ZOOM+

ZOOM-



PARTS IMAGE

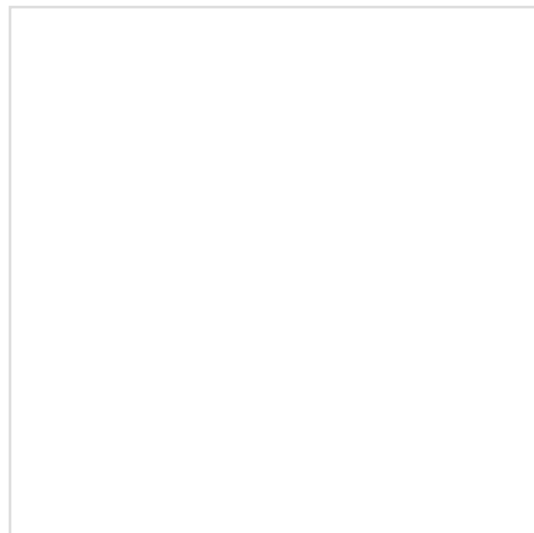

BOX IMAGE

37880-PLC-004

SENSOR AIR INTAKE TEMP

Parts Number : 37880-PLC-004

Manufacture 1 : PANASONIC / MATSUSHITA

Manufacturer Number 1 : TA4

Manufacture 2 :

Manufacture Number 2 :

M.S.R.P 04/2010 : \$34.98

Description: SENSOR AIR INTAKE TEMP
MADE IN JAPAN #OEM

Application 1 : HONDA ACCORD 4D 03-06

Application 2 : HONDA ACCORD COUPE 03-06

Application 3 : HONA CIVIC 2D 4D 01-05

Application 4 : HONDA CIVIC 3D 02-05

Application 5 : HONDA CR-V 02-06

Application 6 : HONDA ELEMENT 03-06

Application 7 : HONDA FIT 07-08

Application 8 : HONDA S2000 00-09

Application 9 : ACURA RSX 02-06

Application 10 : ACURA TSX 04-08

Application 11 :

Application 12 :

ZOOM+

ZOOM-



PARTS IMAGE

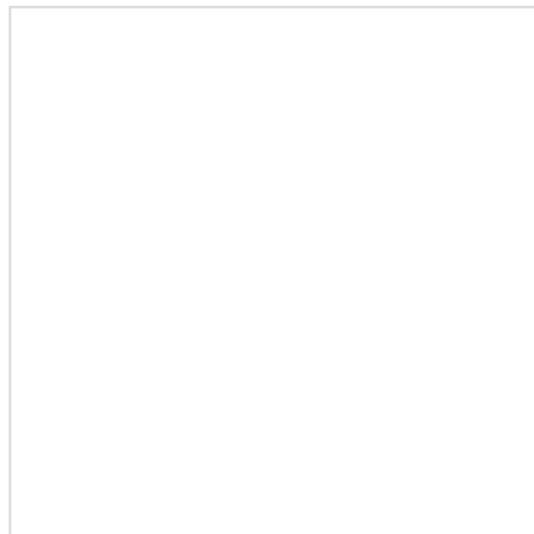

BOX IMAGE

37980-RTA-003

SENSOR AIR FLOW

Parts Number : 37980-RTA-003

Manufacture 1 : DENSO

Manufacturer Number 1 : 197400-5012

Manufacture 2 :

Manufacture Number 2 :

M.S.R.P 04/2010 : \$104.78

Description: SENSOR AIR FLOW
MADE IN JAPAN #G

Application 1 : HONDA CIVIC 2D 06-09

Application 2 : HONDA CIVIC 4D 06-09

Application 3 : HONDA CR-V 07-09

Application 4 : HONDA ELEMENT 07-09

Application 5 :

Application 6 :

Application 7 :

Application 8 :

Application 9 :

Application 10 :

Application 11 :

Application 12 :

ZOOM+

ZOOM-



PARTS IMAGE

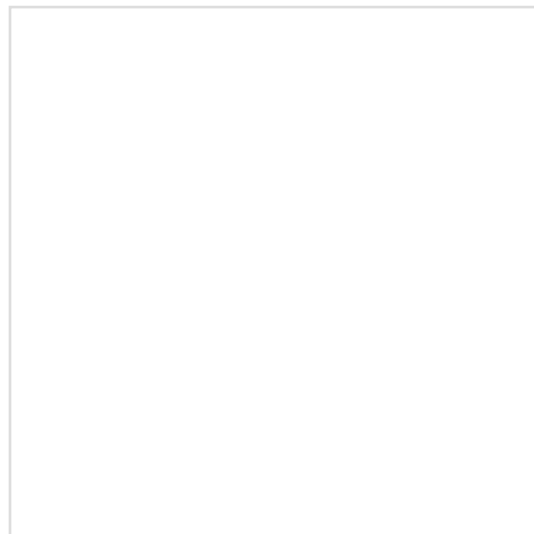

BOX IMAGE

38300-SZ3-003

RELAY FLASHER MADE IN

Parts Number : 38300-SZ3-003

Manufacture 1 : MITSUBA

Manufacturer Number 1 : FR-3503

Manufacture 2 :

Manufacture Number 2 :

M.S.R.P 04/2010 :

Description: RELAY FLASHER MADE IN JAPAN

Application 1 :

Application 2 :

Application 3 :

Application 4 :

Application 5 :

Application 6 :

Application 7 :

Application 8 :

Application 9 :

Application 10 :

Application 11 :

Application 12 :

ZOOM+

ZOOM-



PARTS IMAGE



BOX IMAGE

39400-S01-A01

RELAY MAIN MADE IN JAPAN

Parts Number : 39400-S01-A01

Manufacture 1 : MITSUBA

Manufacturer Number 1 : RZ-0159B

Manufacture 2 :

Manufacture Number 2 :

M.S.R.P 04/2010 :

Description: RELAY MAIN MADE IN JAPAN

Application 1 :

Application 2 :

Application 3 :

Application 4 :

Application 5 :

Application 6 :

Application 7 :

Application 8 :

Application 9 :

Application 10 :

Application 11 :

Application 12 :

ZOOM+ ZOOM-



PARTS IMAGE



BOX IMAGE

39400-S10-003

RELAY MAIN

Parts Number : 39400-S10-003

Manufacture 1 : MITSUBA

Manufacturer Number 1 : RZ-0159B

Manufacture 2 :

Manufacture Number 2 :

M.S.R.P 04/2010 : \$60.55

Description: RELAY MAIN
MADE IN JAPAN #OEMNTP

- Application 1 :** HONDA CIVIC 2D 93-00
- Application 2 :** HONDA CIVIC 3D 92-00
- Application 3 :** HONDA CIVIC 4D 92-95
- Application 4 :** HONDA CIVIC 96-97(US) 96-00(EXP)
- Application 5 :** HONDA CIVIC 4D 98-00
- Application 6 :** HONDA CR-V 97-01
- Application 7 :** HONDA DEL SOL 93-97
- Application 8 :** ACURA INTEGRA 94-01
- Application 9 :**
- Application 10 :**
- Application 11 :**
- Application 12 :**

ZOOM+

ZOOM-



PARTS IMAGE



BOX IMAGE

39400-S84-003

RELAY MAIN

Parts Number : 39400-S84-003

Manufacture 1 : MITSUBA

Manufacturer Number 1 : RZ-0159 W/O

Manufacture 2 :

Manufacture Number 2 :

M.S.R.P 04/2010 : \$59.43

Description: RELAY MAIN
MADE IN JAPAN #OEMNTP

Application 1 : HONDA ACCORD 4D 2002

Application 2 : HONDA ACCORD 4D 98-01

Application 3 : HONDA ODYSSEY 95-98

Application 4 : HONDA ODYSSEY 99-04

Application 5 : HONDA PILOT 03-07

Application 6 : HONDA PRELUDE 97-01

Application 7 : ACURA TL 3.2L 99-03

Application 8 :

Application 9 :

Application 10 :

Application 11 :

Application 12 :

[ZOOM+](#)
[ZOOM-](#)

PARTS IMAGE



BOX IMAGE

39400-SA5-405

RELAY MAIN

Parts Number : 39400-SA5-405

Manufacture 1 : MITSUBA

Manufacturer Number 1 : RC-2232

Manufacture 2 :

Manufacture Number 2 :

M.S.R.P 04/2010 : \$62.67

Description: RELAY MAIN
MADE IN JAPAN #OEMNTP

Application 1 : HONDA ACCORD 3D/4D 82-85

Application 2 : HONDA CIVIC 3D/4D 84-87

Application 3 : HONDA CIVIC 4D 81-83

Application 4 : HONDA CIVIC HTBK WAGON 80-83

Application 5 : HONDA CIVIC WAGON 4WD 85-87

Application 6 : HONDA CIVIC WAGON 84-87

Application 7 : HONDA CRX 84-87

Application 8 : HONDA PRELUDE 79-87

Application 9 :

Application 10 :

Application 11 :

Application 12 :

ZOOM+

ZOOM-



PARTS IMAGE



BOX IMAGE

39400-SA7-931

RELAY MAIN

Parts Number : 39400-SA7-931

Manufacture 1 : MITSUBA

Manufacturer Number 1 : RZ-0017

Manufacture 2 :

Manufacture Number 2 :

M.S.R.P 04/2010 : \$57.92

Description: RELAY MAIN
MADE IN JAPAN #OEMNTP

Application 1 : HONDA CRX 84-87

Application 2 :

Application 3 :

Application 4 :

Application 5 :

Application 6 :

Application 7 :

Application 8 :

Application 9 :

Application 10 :

Application 11 :

Application 12 :

ZOOM+ ZOOM-



PARTS IMAGE



BOX IMAGE

39400-SE3-003

RELAY MAIN

Parts Number : 39400-SE3-003

Manufacture 1 : MITSUBA

Manufacturer Number 1 : RZ-0028

Manufacture 2 :

Manufacture Number 2 :

M.S.R.P 04/2010 : \$70.07

Description: RELAY MAIN
MADE IN JAPAN #OEMNTP

Application 1 : HONDA ACCORD 2D 88-89

Application 2 : HONDA ACCORD 3D/4D 86-89

Application 3 :

Application 4 :

Application 5 :

Application 6 :

Application 7 :

Application 8 :

Application 9 :

Application 10 :

Application 11 :

Application 12 :

ZOOM+

ZOOM-



PARTS IMAGE



BOX IMAGE

39400-SF0-671

RELAY MAIN

Parts Number : 39400-SF0-671

Manufacture 1 : MITSUBA

Manufacturer Number 1 : RZ-0037

Manufacture 2 :

Manufacturer Number 2 :

M.S.R.P 04/2010 : \$73.33

Description: RELAY MAIN
MADE IN JAPAN #OEMNTP

Application 1 : HONDA PRELUDE 83-87

Application 2 :

Application 3 :

Application 4 :

Application 5 :

Application 6 :

Application 7 :

Application 8 :

Application 9 :

Application 10 :

Application 11 :

Application 12 :

ZOOM+ ZOOM-



PARTS IMAGE



BOX IMAGE

39400-SF1-003

RELYA MAIN MADE IN JAPAN

Parts Number : 39400-SF1-003
Manufacture 1 : MITSUBA
Manufacturer Number 1 : RZ-0045
Manufacture 2 :
Manufacturer Number 2 :
M.S.R.P 04/2010 :
Description: RELYA MAIN MADE IN JAPAN

- Application 1 :
- Application 2 :
- Application 3 :
- Application 4 :
- Application 5 :
- Application 6 :
- Application 7 :
- Application 8 :
- Application 9 :
- Application 10 :
- Application 11 :
- Application 12 :

ZOOM+ ZOOM-



PARTS IMAGE



BOX IMAGE

39400-SH3-003

RELAY MAIN

Parts Number : 39400-SH3-003

Manufacture 1 : MITSUBA

Manufacturer Number 1 : RZ-0063

Manufacture 2 :

Manufacture Number 2 :

M.S.R.P 04/2010 : \$65.80

Description: RELAY MAIN
MADE IN JAPAN #OEMNTP

Application 1 : HONDA CIVIC 3D 88-91

Application 2 : HONDA CIVIC 4D 88-91

Application 3 : HONDA WAGON 88-91

Application 4 : HONDA CRX 88-91

Application 5 : ACURA INTEGRA 90-93

Application 6 : ACURA LLEGEND 86-90

Application 7 :

Application 8 :

Application 9 :

Application 10 :

Application 11 :

Application 12 :

ZOOM+

ZOOM-



PARTS IMAGE



BOX IMAGE

39400-SL5-A01

RELAY MAIN

Parts Number :	39400-SL5-A01
Manufacture 1 :	MITSUBA <input type="button" value="v"/>
Manufacturer Number 1 :	RZ-0109
Manufacture 2 :	<input type="button" value="v"/>
Manufacture Number 2 :	
M.S.R.P 04/2010 :	\$79.62
Description:	RELAY MAIN MADE IN JAPAN #OEMNTP

- Application 1 : ACURA VIGOR 92-94
- Application 2 :
- Application 3 :
- Application 4 :
- Application 5 :
- Application 6 :
- Application 7 :
- Application 8 :
- Application 9 :
- Application 10 :
- Application 11 :
- Application 12 :

ZOOM+ ZOOM-



PARTS IMAGE



BOX IMAGE

39400-SM4-003

RELAY MAIN

Parts Number :	39400-SM4-003
Manufacture 1 :	MITSUBA <input type="button" value="v"/>
Manufacturer Number 1 :	RZ-0088
Manufacture 2 :	<input type="button" value="v"/>
Manufacturer Number 2 :	
M.S.R.P 04/2010 :	\$65.80
Description:	RELAY MAIN MADE IN JAPAN /OEMNTP

- Application 1 :** HONDA ACCORD 2D 90-93
- Application 2 :** HONDA ACCORD 4D 90-93
- Application 3 :** HONDA ACCORD WAGON 91-93
- Application 4 :**
- Application 5 :**
- Application 6 :**
- Application 7 :**
- Application 8 :**
- Application 9 :**
- Application 10 :**
- Application 11 :**
- Application 12 :**

ZOOM+ ZOOM-



PARTS IMAGE



BOX IMAGE

39400-SP0-013

RELAY MAIN

Parts Number : 39400-SP0-013

Manufacture 1 : MITSUBA

Manufacturer Number 1 : RZ-0105

Manufacture 2 :

Manufacture Number 2 :

M.S.R.P 04/2010 : \$76.38

Description: RELAY MAIN
MADE IN JAPAN #OEMNTP

Application 1 : ACURA LEGEND 91-95

Application 2 :

Application 3 :

Application 4 :

Application 5 :

Application 6 :

Application 7 :

Application 8 :

Application 9 :

Application 10 :

Application 11 :

Application 12 :

ZOOM+ ZOOM-



PARTS IMAGE



BOX IMAGE

39400-SS0-003

RELAY MAIN

Parts Number : 39400-SS0-003

Manufacture 1 : MITSUBA

Manufacturer Number 1 : RZ-0139

Manufacture 2 :

Manufacture Number 2 :

M.S.R.P 04/2010 : \$67.55

Description: RELAY MAIN
MADE IN JAPAN #OEMNTP

Application 1 : HONDA PRELUDE 92-96

Application 2 :

Application 3 :

Application 4 :

Application 5 :

Application 6 :

Application 7 :

Application 8 :

Application 9 :

Application 10 :

Application 11 :

Application 12 :

ZOOM+

ZOOM-



PARTS IMAGE



BOX IMAGE

39400-SV4-003

RELAY MAIN

Parts Number :	39400-SV4-003
Manufacture 1 :	MITSUBA <input type="button" value="v"/>
Manufacturer Number 1 :	RZ-0088 W/O
Manufacture 2 :	<input type="button" value="v"/>
Manufacturer Number 2 :	
M.S.R.P 04/2010 :	\$76.78
Description:	RELAY MAIN MADE IN JAPAN #OEMNTP

- Application 1 :** HONDA ACCORD 2D 94-97
- Application 2 :** HONDA ACCORD 94-97 E2 V6 E2
- Application 3 :** HONDA ACCORD WAGON 94-97
- Application 4 :** HONDA ODYSSEY 95-98
- Application 5 :** HONDA PRELUDE 97-01
- Application 6 :** ACURA TL 2.5L 95-98
- Application 7 :**
- Application 8 :**
- Application 9 :**
- Application 10 :**
- Application 11 :**
- Application 12 :**

ZOOM+ ZOOM-



PARTS IMAGE



BOX IMAGE

39792-SP0-004

RELAY ACCSSORY

Parts Number :	39792-SP0-004
Manufacture 1 :	MITSUBA <input type="button" value="v"/>
Manufacturer Number 1 :	
Manufacture 2 :	<input type="button" value="v"/>
Manufacture Number 2 :	
M.S.R.P 04/2010 :	\$30.12
Description:	RELAY ACCSSORY MADE IN JAPAN #OEMNTP 39792-SE0-003

- Application 1 : ACURA 96-04
- Application 2 :
- Application 3 :
- Application 4 :
- Application 5 :
- Application 6 :
- Application 7 :
- Application 8 :
- Application 9 :
- Application 10 :
- Application 11 :
- Application 12 :

ZOOM+ ZOOM-



PARTS IMAGE



BOX IMAGE

39794-S04-003

RELAY ACCESSORY

Parts Number : 39794-S04-003

Manufacture 1 : MITSUBA

Manufacturer Number 1 : RC-5001

Manufacture 2 :

Manufacture Number 2 :

M.S.R.P 04/2010 : \$6.30

Description: RELAY ACCESSORY
MADE IN JAPAN #OEMNTP
39794-S0K-A01

- Application 1 :** HONDA ACCORD 2D 4D 98-02
- Application 2 :** HONDA CIVIC 2D 3D 96-05
- Application 3 :** HONDA CIVIC 4D 98-05
- Application 4 :** HONDA CIVIC 96-97(US) 96-00(EXP)
- Application 5 :** HONDA CIVIC HYBRID 03-05
- Application 6 :** HONDA CR-V 97-06
- Application 7 :** HONDA FIT 07-08
- Application 8 :** HONDA INSIGHT 00-06
- Application 9 :** HONDA ODYSSEY 99-04
- Application 10 :** HONDA S2000 00-09
- Application 11 :**
- Application 12 :**

ZOOM+ ZOOM-



PARTS IMAGE



BOX IMAGE

39794-S10-003

RELAY ACCSSORY

Parts Number : 39794-S10-003

Manufacture 1 : MITSUBA

Manufacturer Number 1 : RC-5102

Manufacture 2 :

Manufacture Number 2 :

M.S.R.P 04/2010 :

Description: RELAY ACCSSORY
MADE IN JAPAN #OEMNTP

Application 1 :

Application 2 :

Application 3 :

Application 4 :

Application 5 :

Application 6 :

Application 7 :

Application 8 :

Application 9 :

Application 10 :

Application 11 :

Application 12 :

ZOOM+

ZOOM-



PARTS IMAGE



BOX IMAGE

39794-S5A-003

RELAY ACCSSORY

Parts Number : 39794-S5A-003

Manufacture 1 : MITSUBA

Manufacturer Number 1 : RC-5104

Manufacture 2 :

Manufacture Number 2 :

M.S.R.P 04/2010 :

Description: RELAY ACCSSORY
MADE IN JAPAN #OEMNTP

Application 1 :

Application 2 :

Application 3 :

Application 4 :

Application 5 :

Application 6 :

Application 7 :

Application 8 :

Application 9 :

Application 10 :

Application 11 :

Application 12 :

ZOOM+ ZOOM-



PARTS IMAGE



BOX IMAGE

39795-SB2-003

RELAY A/C

Parts Number :	39795-SB2-003
Manufacture 1 :	MITSUBA <input type="button" value="v"/>
Manufacturer Number 1 :	RC-2201
Manufacture 2 :	<input type="button" value="v"/>
Manufacturer Number 2 :	
M.S.R.P 04/2010 :	\$44.58
Description:	RELAY A/C MADE IN JAPAN #OEMNTP

- Application 1 :** HONDA ACCORD 2D 94-07
- Application 2 :** HONDA ACCORD 4D 94-07
- Application 3 :** HONDA ACCORD HYBRID 05-07
- Application 4 :** HONDA CIVIC 2D 93-95
- Application 5 :** HONDA CIVIC 3D 4D 88-95
- Application 6 :** HONDA CRX 84-91
- Application 7 :** HONDA DEL SOL 93-97
- Application 8 :** HONDA ODYSSEY 98-09
- Application 9 :** HONDA PILOT 03-07
- Application 10 :** HONDA RIDGELINE 06-09
- Application 11 :** ACURA CL 97-99
- Application 12 :** ACURA INTEGRA 94-01

ZOOM+ ZOOM-



PARTS IMAGE



BOX IMAGE

39797-SE0-004

RELAY ACCESSORY

Parts Number : 39797-SE0-004

Manufacture 1 : MITSUBA

Manufacturer Number 1 : RC-2201

Manufacture 2 :

Manufacturer Number 2 :

M.S.R.P 04/2010 : \$40.60

Description: RELAY ACCESSORY
MADE IN JAPAN #OEMNTP

Application 1 : HONDA ACCORD 2D 4D 90-02

Application 2 : HONDA ACCORD 3D/4D 86-89

Application 3 : HONDA CIVIC 2D 93-00

Application 4 : HONDA CIVIC 3D 88-00

Application 5 : HONDA CIVIC 3D/4D 84-87

Application 6 : HONDA CIVIC 4D 88-00

Application 7 : HONDA CR-V 97-01

Application 8 : HONDA CRX 84-91

Application 9 : HONDA INSIGHT 00-06

Application 10 : HONDA ODYSSEY 95-04

Application 11 : HONDA PILOT 03-08

Application 12 : HONDA S2000 00-07

ZOOM+

ZOOM-



PARTS IMAGE



BOX IMAGE

39797-SM4-003

RELAY MADE IN JAPAN

Parts Number : 39797-SM4-003

Manufacture 1 : MITSUBA

Manufacturer Number 1 : RC-2223

Manufacture 2 :

Manufacture Number 2 :

M.S.R.P 04/2010 :

Description: RELAY MADE IN JAPAN #OEMNTP

Application 1 :

Application 2 :

Application 3 :

Application 4 :

Application 5 :

Application 6 :

Application 7 :

Application 8 :

Application 9 :

Application 10 :

Application 11 :

Application 12 :

ZOOM+

ZOOM-

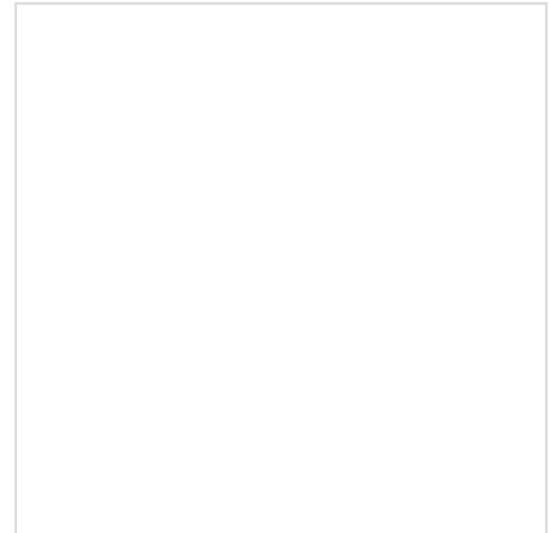

PARTS IMAGE

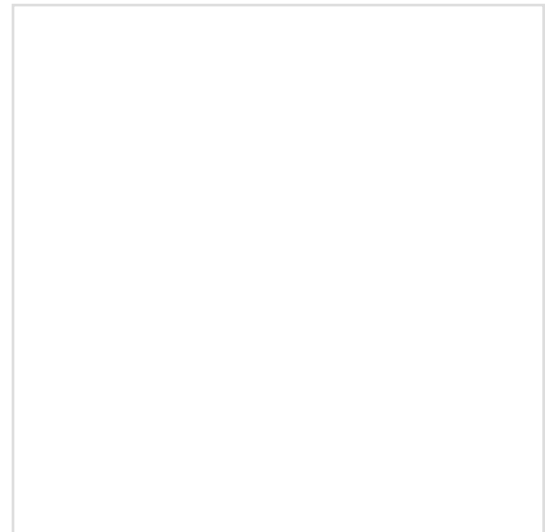

BOX IMAGE

41233-P7W-000

GEAR FINAL

Parts Number : 41233-P7W-000

Manufacture 1 :

Manufacturer Number 1 :

Manufacture 2 :

Manufacture Number 2 :

M.S.R.P 04/2010 : \$222.80

Description: GEAR FINAL
MADE IN JAPAN #G

Application 1 : ACURA

Application 2 :

Application 3 :

Application 4 :

Application 5 :

Application 6 :

Application 7 :

Application 8 :

Application 9 :

Application 10 :

Application 11 :

Application 12 :

ZOOM+ ZOOM-



PARTS IMAGE

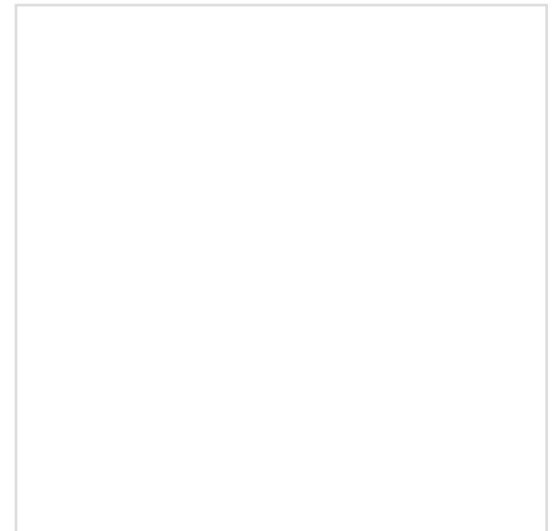

BOX IMAGE

44500-SVB-A00

SHAFT / DRIVE AXLES - AXLE

Parts Number : 44500-SVB-A00

Manufacture 1 :

Manufacturer Number 1 :

Manufacture 2 :

Manufacturer Number 2 :

M.S.R.P 04/2010 : \$242.73

Description: SHAFT / DRIVE AXLES - AXLE
shafts & joints - Intermediate shaft
MADE IN JAPAN #G

Application 1 : HONDA CIVIC 2D 06-09

Application 2 : HONDA CIVIC 4D 06-09

Application 3 :

Application 4 :

Application 5 :

Application 6 :

Application 7 :

Application 8 :

Application 9 :

Application 10 :

Application 11 :

Application 12 :

ZOOM+ ZOOM-



PARTS IMAGE

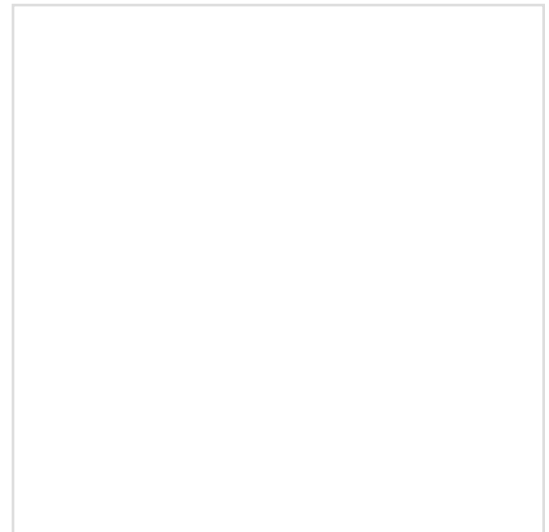

BOX IMAGE

46100-S04-A04

BRAKE MASTER CYLINDER NTP

Parts Number : 46100-S04-A04

Manufacture 1 : NISSIN

Manufacturer Number 1 : 46100-S04-A03

Manufacture 2 :

Manufacturer Number 2 :

M.S.R.P 04/2010 :

Description: BRAKE MASTER CYLINDER NTP
MADE IN JAPAN

Application 1 :

Application 2 :

Application 3 :

Application 4 :

Application 5 :

Application 6 :

Application 7 :

Application 8 :

Application 9 :

Application 10 :

Application 11 :

Application 12 :

ZOOM+

ZOOM-



PARTS IMAGE

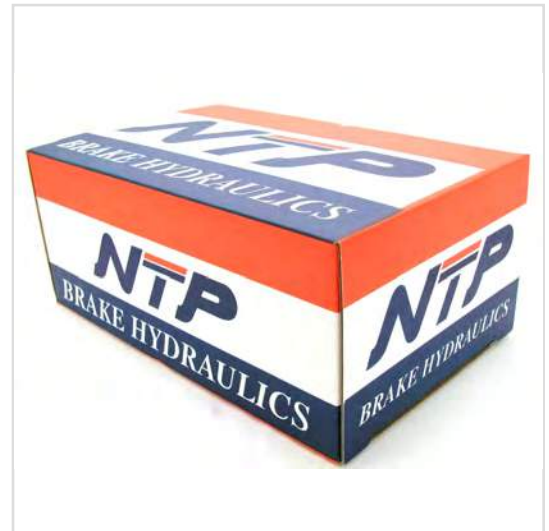

BOX IMAGE

46100-S04-L54

BRAKE MASTER CYLINDER NTP

Parts Number : 46100-S04-L54

Manufacture 1 : NISSIN

Manufacturer Number 1 : 46100-S04-L53

Manufacture 2 :

Manufacturer Number 2 :

M.S.R.P 04/2010 :

Description: BRAKE MASTER CYLINDER NTP
MADE IN JAPAN

Application 1 :

Application 2 :

Application 3 :

Application 4 :

Application 5 :

Application 6 :

Application 7 :

Application 8 :

Application 9 :

Application 10 :

Application 11 :

Application 12 :

ZOOM+ ZOOM-



PARTS IMAGE

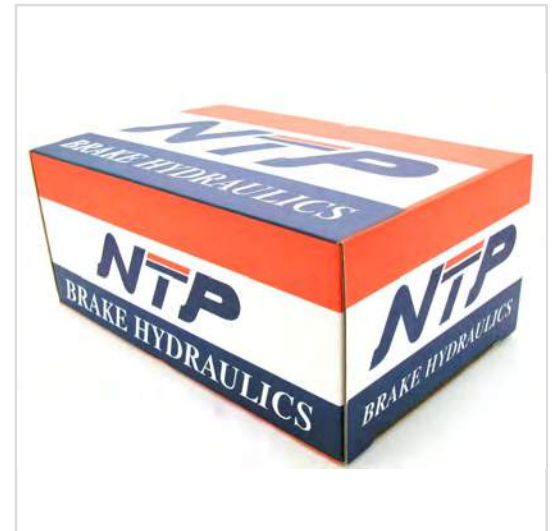

BOX IMAGE

46100-S04-L72

BRAKE MASTER CYLINDER NTP

Parts Number : 46100-S04-L72

Manufacture 1 : NISSIN

Manufacturer Number 1 : 46100-S04-L71

Manufacture 2 :

Manufacturer Number 2 :

M.S.R.P 04/2010 :

Description: BRAKE MASTER CYLINDER NTP
MADE IN JAPAN

Application 1 :

Application 2 :

Application 3 :

Application 4 :

Application 5 :

Application 6 :

Application 7 :

Application 8 :

Application 9 :

Application 10 :

Application 11 :

Application 12 :

ZOOM+

ZOOM-



PARTS IMAGE

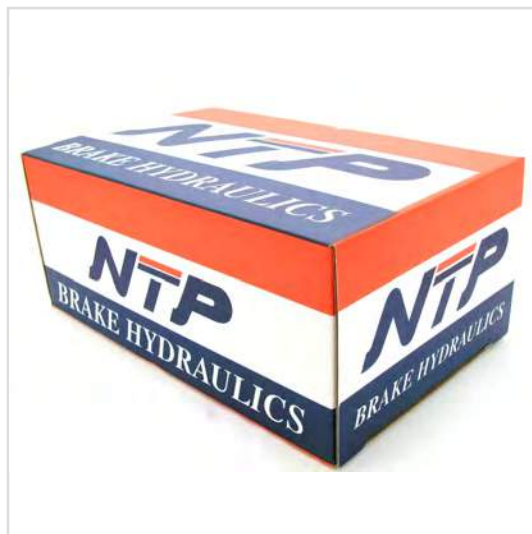

BOX IMAGE

46100-S04-N53

BRAKE MASTER CYLINDER NTP

Parts Number : 46100-S04-N53

Manufacture 1 : NISSIN

Manufacturer Number 1 : 46100-S04-N54

Manufacture 2 :

Manufacturer Number 2 :

M.S.R.P 04/2010 : \$287.68

Description: BRAKE MASTER CYLINDER NTP
MADE IN JAPAN

Application 1 : HONDA CR-V 1997 ABS

Application 2 :

Application 3 :

Application 4 :

Application 5 :

Application 6 :

Application 7 :

Application 8 :

Application 9 :

Application 10 :

Application 11 :

Application 12 :

ZOOM+ ZOOM-



PARTS IMAGE

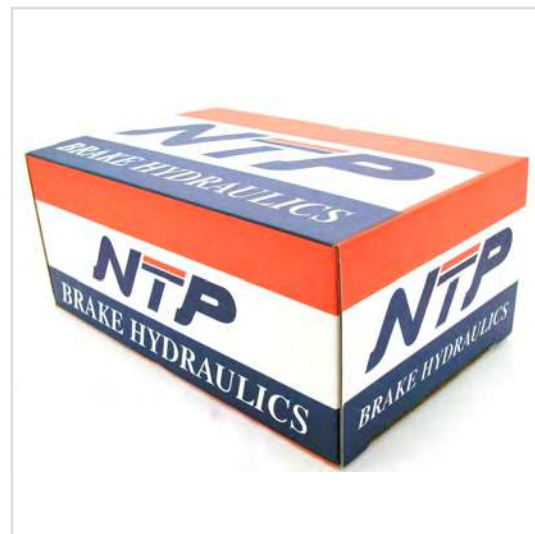

BOX IMAGE

46100-S0K-A03

Parts Number : 46100-S0K-A03

Manufacture 1 : NISSIN

Manufacturer Number 1 :

Manufacture 2 :

Manufacture Number 2 :

M.S.R.P 04/2010 :

Description: BRAKE MASTER CYLINDER NTP
MADE IN JAPAN

Application 1 :

Application 2 :

Application 3 :

Application 4 :

Application 5 :

Application 6 :

Application 7 :

Application 8 :

Application 9 :

Application 10 :

Application 11 :

Application 12 :

BRAKE MASTER CYLINDER NTP

ZOOM+

ZOOM-



PARTS IMAGE

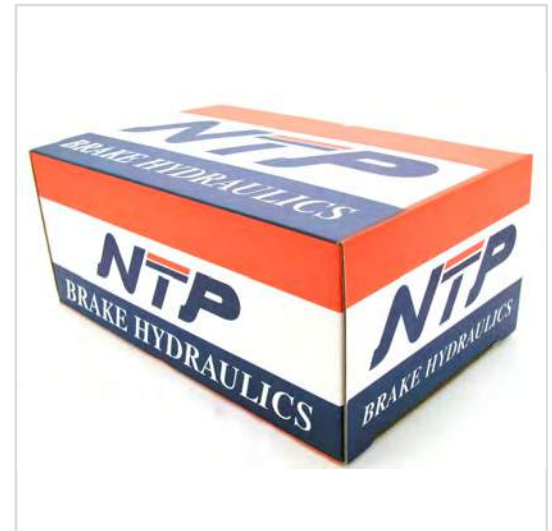

BOX IMAGE

46100-S10-952

BRAKE MASTER CYLINDER NTP

Parts Number : 46100-S10-952

Manufacture 1 : NISSIN

Manufacturer Number 1 : 46100-S10-951

Manufacture 2 :

Manufacturer Number 2 :

M.S.R.P 04/2010 :

Description: BRAKE MASTER CYLINDER NTP
MADE IN JAPAN

Application 1 :

Application 2 :

Application 3 :

Application 4 :

Application 5 :

Application 6 :

Application 7 :

Application 8 :

Application 9 :

Application 10 :

Application 11 :

Application 12 :

ZOOM+ ZOOM-



PARTS IMAGE

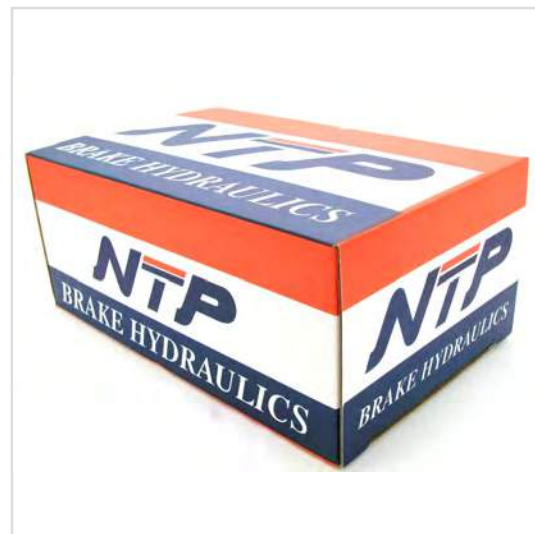

BOX IMAGE

46100-S10-A51

BRAKE MASTER CYLINDER NTP

Parts Number : 46100-S10-A51

Manufacture 1 : NISSIN

Manufacturer Number 1 : 46100-S10-A52

Manufacture 2 :

Manufacturer Number 2 :

M.S.R.P 04/2010 : \$287.68

Description: BRAKE MASTER CYLINDER NTP
MADE IN JAPAN

Application 1 : HONDA CR-V 1998 ABS

Application 2 :

Application 3 :

Application 4 :

Application 5 :

Application 6 :

Application 7 :

Application 8 :

Application 9 :

Application 10 :

Application 11 :

Application 12 :

ZOOM+ ZOOM-



PARTS IMAGE

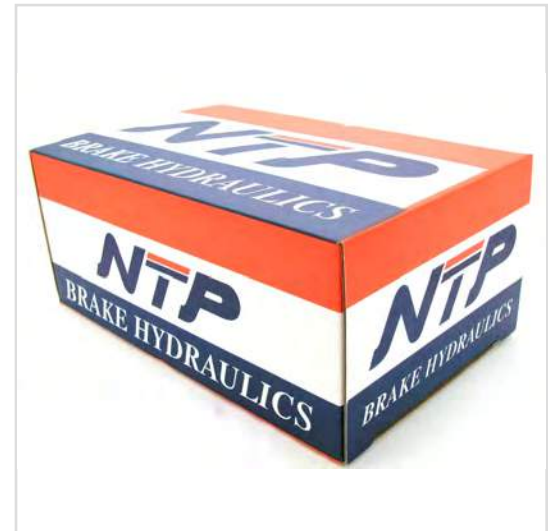

BOX IMAGE

46100-S2A-A02

BRAKE MASTER CYLINDER NTP

Parts Number : 46100-S2A-A02

Manufacture 1 : NISSIN

Manufacturer Number 1 : 46100-S2A-A01

Manufacture 2 :

Manufacturer Number 2 :

M.S.R.P 04/2010 :

Description: BRAKE MASTER CYLINDER NTP
MADE IN JAPAN

Application 1 :

Application 2 :

Application 3 :

Application 4 :

Application 5 :

Application 6 :

Application 7 :

Application 8 :

Application 9 :

Application 10 :

Application 11 :

Application 12 :

ZOOM+

ZOOM-



PARTS IMAGE

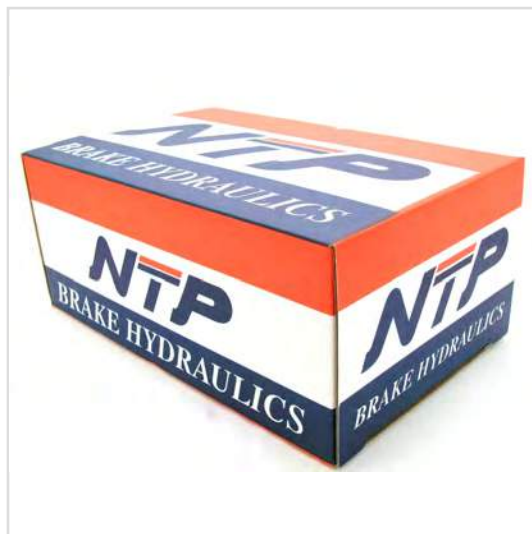

BOX IMAGE

46100-S2A-A51

BRAKE MASTER CYLINDER NTP

Parts Number : 46100-S2A-A51

Manufacture 1 : NISSIN

Manufacturer Number 1 :

Manufacture 2 :

Manufacturer Number 2 :

M.S.R.P 04/2010 :

Description: BRAKE MASTER CYLINDER NTP
MADE IN JAPAN

Application 1 :

Application 2 :

Application 3 :

Application 4 :

Application 5 :

Application 6 :

Application 7 :

Application 8 :

Application 9 :

Application 10 :

Application 11 :

Application 12 :

ZOOM+ ZOOM-



PARTS IMAGE

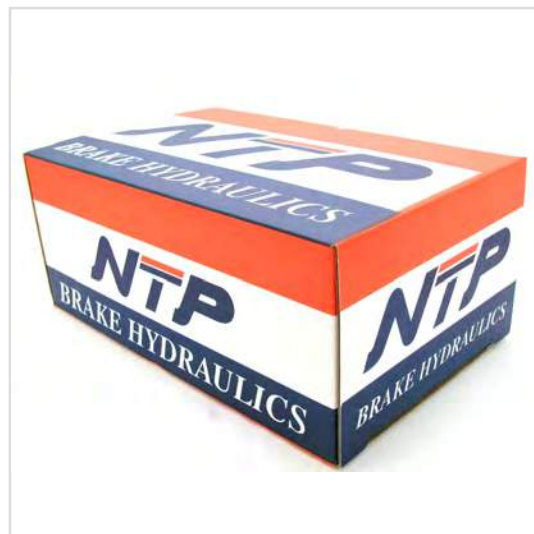

BOX IMAGE

46100-S3Y-A03

BRAKE MASTER CYLINDER NTP

Parts Number : 46100-S3Y-A03

Manufacture 1 : NISSIN

Manufacturer Number 1 : 46100-S3Y-A02

Manufacture 2 :

Manufacture Number 2 :

M.S.R.P 04/2010 :

Description: BRAKE MASTER CYLINDER NTP
MADE IN JAPAN

Application 1 :

Application 2 :

Application 3 :

Application 4 :

Application 5 :

Application 6 :

Application 7 :

Application 8 :

Application 9 :

Application 10 :

Application 11 :

Application 12 :

ZOOM+ ZOOM-



PARTS IMAGE

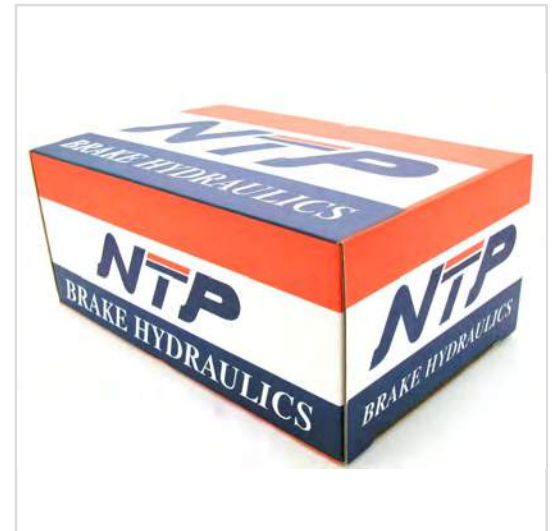

BOX IMAGE

46100-S47-023

BRAKE MASTER CYLINDER NTP

Parts Number : 46100-S47-023

Manufacture 1 : NISSIN

Manufacturer Number 1 : 46100-S47-013

Manufacture 2 :

Manufacturer Number 2 :

M.S.R.P 04/2010 :

Description: BRAKE MASTER CYLINDER NTP
MADE IN JAPAN

Application 1 :

Application 2 :

Application 3 :

Application 4 :

Application 5 :

Application 6 :

Application 7 :

Application 8 :

Application 9 :

Application 10 :

Application 11 :

Application 12 :

ZOOM+ ZOOM-



PARTS IMAGE



BOX IMAGE

46100-S5D-A01

Parts Number : 46100-S5D-A01

Manufacture 1 : NISSIN

Manufacturer Number 1 :

Manufacture 2 :

Manufacture Number 2 :

M.S.R.P 04/2010 :

Description: BRAKE MASTER CYLINDER NTP
MADE IN JAPAN

Application 1 :

Application 2 :

Application 3 :

Application 4 :

Application 5 :

Application 6 :

Application 7 :

Application 8 :

Application 9 :

Application 10 :

Application 11 :

Application 12 :

BRAKE MASTER CYLINDER NTP

ZOOM+

ZOOM-



PARTS IMAGE

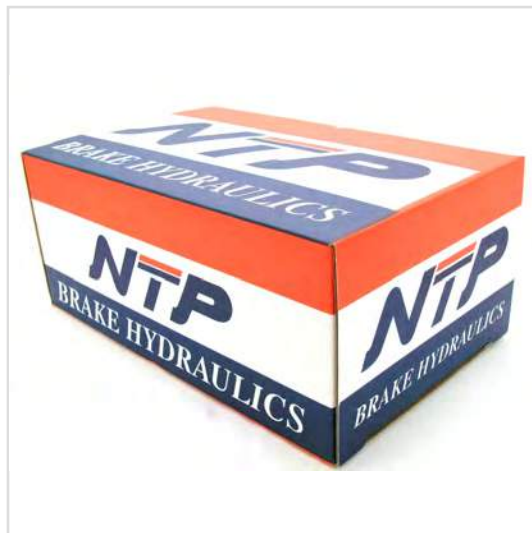

BOX IMAGE

46100-S5D-A51

BRAKE MASTER CYLINDER NTP

Parts Number : 46100-S5D-A51

Manufacture 1 : NISSIN

Manufacturer Number 1 :

Manufacture 2 :

Manufacture Number 2 :

M.S.R.P 04/2010 :

Description: BRAKE MASTER CYLINDER NTP
MADE IN JAPAN

Application 1 :

Application 2 :

Application 3 :

Application 4 :

Application 5 :

Application 6 :

Application 7 :

Application 8 :

Application 9 :

Application 10 :

Application 11 :

Application 12 :

ZOOM+ ZOOM-



PARTS IMAGE

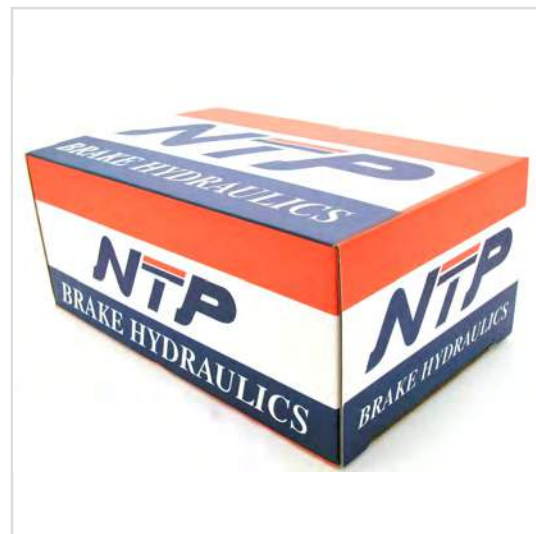

BOX IMAGE

46100-S5D-L01

BRAKE MASTER CYLINDER NTP

Parts Number : 46100-S5D-L01

Manufacture 1 : NISSIN

Manufacturer Number 1 :

Manufacture 2 :

Manufacture Number 2 :

M.S.R.P 04/2010 :

Description: BRAKE MASTER CYLINDER NTP
MADE IN JAPAN

Application 1 :

Application 2 :

Application 3 :

Application 4 :

Application 5 :

Application 6 :

Application 7 :

Application 8 :

Application 9 :

Application 10 :

Application 11 :

Application 12 :

ZOOM+

ZOOM-



PARTS IMAGE

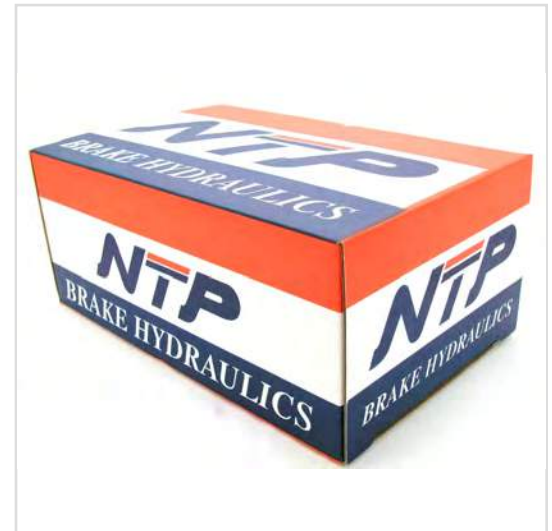

BOX IMAGE

46100-S6M-A52

Parts Number : 46100-S6M-A52

Manufacture 1 : NISSIN

Manufacturer Number 1 :

Manufacture 2 :

Manufacturer Number 2 :

M.S.R.P 04/2010 :

Description: BRAKE MASTER CYLINDER NTP
MADE IN JAPAN

Application 1 :

Application 2 :

Application 3 :

Application 4 :

Application 5 :

Application 6 :

Application 7 :

Application 8 :

Application 9 :

Application 10 :

Application 11 :

Application 12 :

BRAKE MASTER CYLINDER



PARTS IMAGE

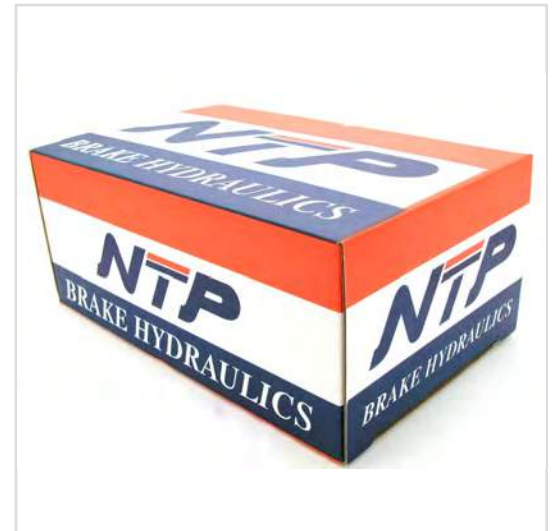

BOX IMAGE

46100-S84-A02

BRAKE MASTER CYLINDER NTP

Parts Number : 46100-S84-A02

Manufacture 1 : NISSIN

Manufacturer Number 1 :

Manufacture 2 :

Manufacture Number 2 :

M.S.R.P 04/2010 :

Description: BRAKE MASTER CYLINDER NTP
MADE IN JAPAN

Application 1 :

Application 2 :

Application 3 :

Application 4 :

Application 5 :

Application 6 :

Application 7 :

Application 8 :

Application 9 :

Application 10 :

Application 11 :

Application 12 :

ZOOM+

ZOOM-



PARTS IMAGE

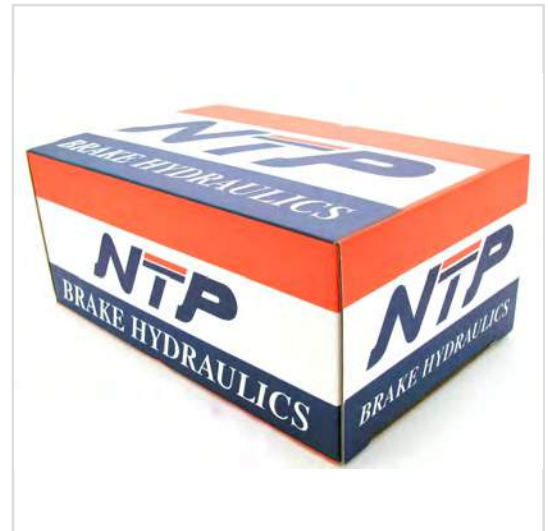

BOX IMAGE

46100-S84-A52

BRAKE MASTER CYLINDER NTP

Parts Number : 46100-S84-A52

Manufacture 1 : NISSIN

Manufacturer Number 1 : 46100-S84-A53/ 46100-SX0-A02

Manufacture 2 :

Manufacturer Number 2 :

M.S.R.P 04/2010 : \$145.00

Description: BRAKE MASTER CYLINDER NTP
MADE IN JAPAN

Application 1 : HONDA ACCORD 4-CYL LX ABS EX 98-02

Application 2 : HONDA ACCORD V6 98-02

Application 3 : HONDA ODYSSEY 1998

Application 4 : ACURA 3.2 CL TYPE S 01-03

Application 5 : ACURA 3.2 TL TYPE S 02-03

Application 6 :

Application 7 :

Application 8 :

Application 9 :

Application 10 :

Application 11 :

Application 12 :

ZOOM+

ZOOM-



PARTS IMAGE

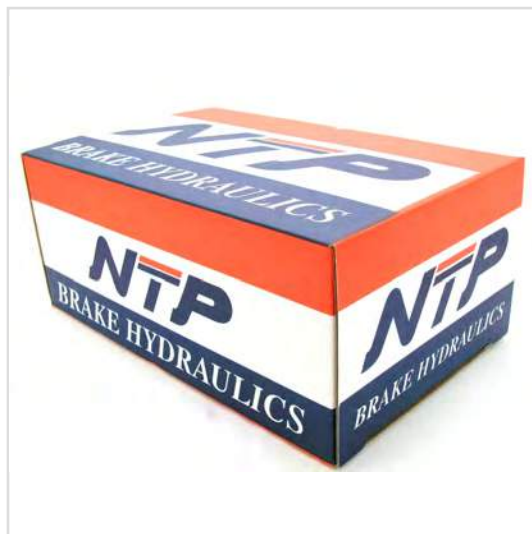

BOX IMAGE

46100-S9A-A62

BRAKE MASTER CYLINDER NTP

Parts Number : 46100-S9A-A62

Manufacture 1 : NISSIN

Manufacturer Number 1 :

Manufacture 2 :

Manufacturer Number 2 :

M.S.R.P 04/2010 :

Description: BRAKE MASTER CYLINDER NTP
MADE IN JAPAN

Application 1 :

Application 2 :

Application 3 :

Application 4 :

Application 5 :

Application 6 :

Application 7 :

Application 8 :

Application 9 :

Application 10 :

Application 11 :

Application 12 :

ZOOM+

ZOOM-



PARTS IMAGE

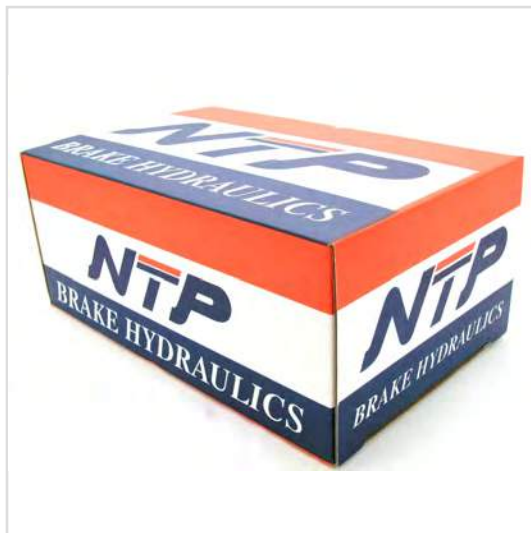

BOX IMAGE

46100-SA5-023

BRAKE MASTER CYLINDER NTP

Parts Number : 46100-SA5-023

Manufacture 1 : NISSIN

Manufacturer Number 1 :

Manufacture 2 :

Manufacture Number 2 :

M.S.R.P 04/2010 :

Description: BRAKE MASTER CYLINDER NTP
MADE IN JAPAN

Application 1 :

Application 2 :

Application 3 :

Application 4 :

Application 5 :

Application 6 :

Application 7 :

Application 8 :

Application 9 :

Application 10 :

Application 11 :

Application 12 :

ZOOM+ ZOOM-



PARTS IMAGE

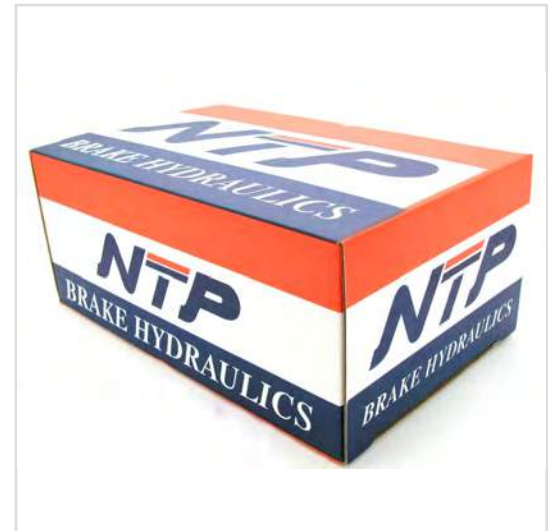

BOX IMAGE

46100-SB2-701

BRAKE MASTER CYLINDER NTP

Parts Number : 46100-SB2-701

Manufacture 1 : NISSIN

Manufacturer Number 1 :

Manufacture 2 :

Manufacturer Number 2 :

M.S.R.P 04/2010 :

Description: BRAKE MASTER CYLINDER NTP
MADE IN JAPAN

Application 1 :

Application 2 :

Application 3 :

Application 4 :

Application 5 :

Application 6 :

Application 7 :

Application 8 :

Application 9 :

Application 10 :

Application 11 :

Application 12 :

ZOOM+

ZOOM-



PARTS IMAGE

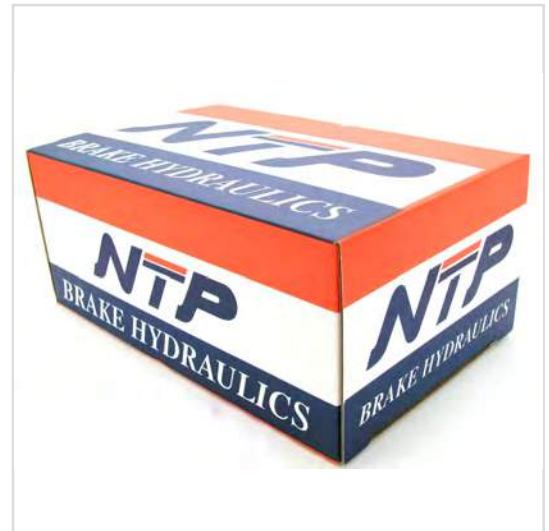

BOX IMAGE

46100-SCV-A71

Parts Number : 46100-SCV-A71

Manufacture 1 : NISSIN

Manufacturer Number 1 :

Manufacture 2 :

Manufacturer Number 2 :

M.S.R.P 04/2010 :

Description: BARKE MASTER CYLINDER NTP
MADE IN JAPAN

Application 1 :

Application 2 :

Application 3 :

Application 4 :

Application 5 :

Application 6 :

Application 7 :

Application 8 :

Application 9 :

Application 10 :

Application 11 :

Application 12 :

BARKE MASTER CYLINDER NTP

ZOOM+

ZOOM-



PARTS IMAGE

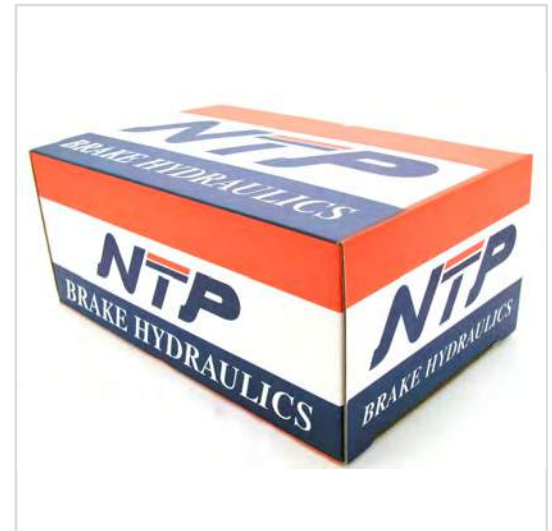

BOX IMAGE

46100-SD4-673

BRAKE MASTER CYLINDER NTP

Parts Number : 46100-SD4-673

Manufacture 1 : NISSIN

Manufacturer Number 1 :

Manufacture 2 :

Manufacture Number 2 :

M.S.R.P 04/2010 :

Description: BRAKE MASTER CYLINDER NTP
MADE IN JAPAN

Application 1 :

Application 2 :

Application 3 :

Application 4 :

Application 5 :

Application 6 :

Application 7 :

Application 8 :

Application 9 :

Application 10 :

Application 11 :

Application 12 :

ZOOM+ ZOOM-



PARTS IMAGE

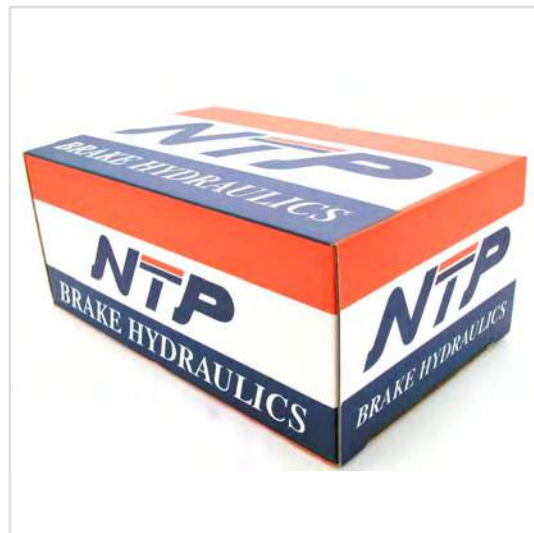

BOX IMAGE

46100-SD4-A34

BRAKE MASTER CYLINDER NTP

Parts Number : 46100-SD4-A34

Manufacture 1 : NISSIN

Manufacturer Number 1 :

Manufacture 2 :

Manufacture Number 2 :

M.S.R.P 04/2010 : \$232.95

Description: BRAKE MASTER CYLINDER NTP
MADE IN JAPAN

Application 1 : ACURA LEGEND W/O ABS 89-90

Application 2 :

Application 3 :

Application 4 :

Application 5 :

Application 6 :

Application 7 :

Application 8 :

Application 9 :

Application 10 :

Application 11 :

Application 12 :

ZOOM+

ZOOM-



PARTS IMAGE

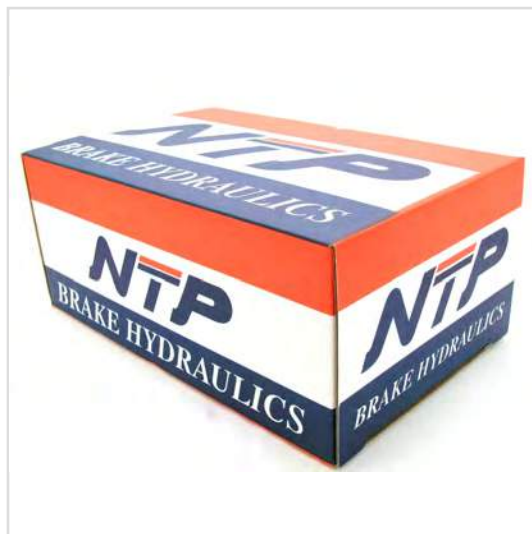

BOX IMAGE

46100-SD4-A53

BRAKE MASTER CYLINDER NTP

Parts Number : 46100-SD4-A53

Manufacture 1 : NISSIN

Manufacturer Number 1 :

Manufacture 2 :

Manufacture Number 2 :

M.S.R.P 04/2010 :

Description: BRAKE MASTER CYLINDER NTP
MADE IN JAPAN

Application 1 :

Application 2 :

Application 3 :

Application 4 :

Application 5 :

Application 6 :

Application 7 :

Application 8 :

Application 9 :

Application 10 :

Application 11 :

Application 12 :

ZOOM+

ZOOM-



PARTS IMAGE

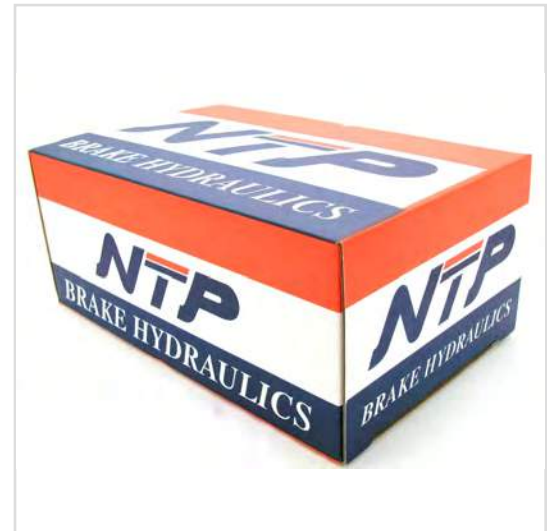

BOX IMAGE

46100-SDA-A01

BRAKE MASTER CYLINDER NTP

Parts Number : 46100-SDA-A01

Manufacture 1 : NISSIN

Manufacturer Number 1 :

Manufacture 2 :

Manufacturer Number 2 :

M.S.R.P 04/2010 :

Description: BRAKE MASTER CYLINDER NTP
MADE IN JAPAN

Application 1 :

Application 2 :

Application 3 :

Application 4 :

Application 5 :

Application 6 :

Application 7 :

Application 8 :

Application 9 :

Application 10 :

Application 11 :

Application 12 :

ZOOM+

ZOOM-



PARTS IMAGE

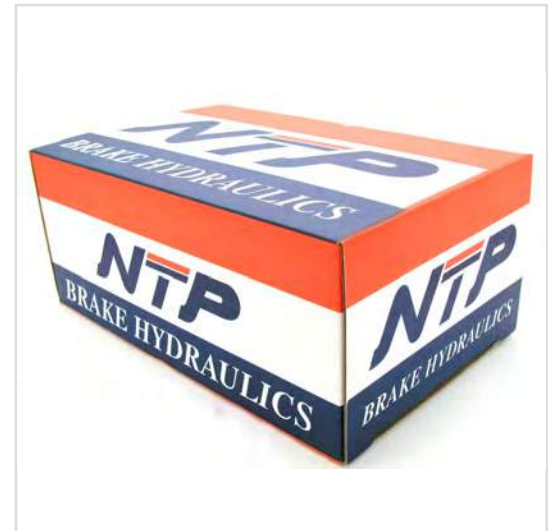

BOX IMAGE

46100-SDB-A11

Parts Number : 46100-SDB-A11

Manufacture 1 : NISSIN

Manufacturer Number 1 :

Manufacture 2 :

Manufacture Number 2 :

M.S.R.P 04/2010 :

Description: BRAKE MASTER CYLINDER NTP
MADE IN JAPAN

Application 1 :

Application 2 :

Application 3 :

Application 4 :

Application 5 :

Application 6 :

Application 7 :

Application 8 :

Application 9 :

Application 10 :

Application 11 :

Application 12 :

BRAKE MASTER CYLINDER NTP

ZOOM+

ZOOM-



PARTS IMAGE

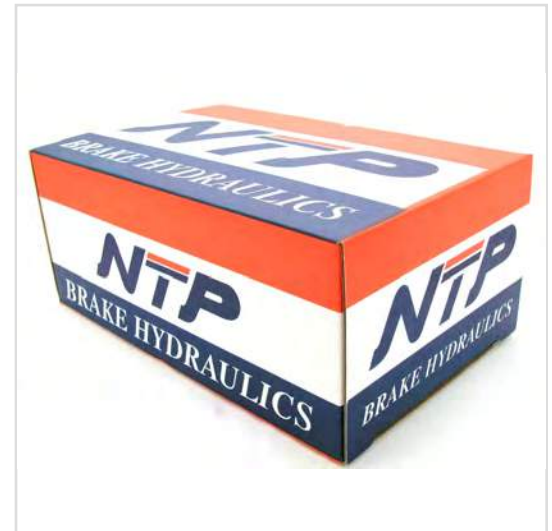

BOX IMAGE

46100-SE0-305

BRAKE MASTER CYLINDER NTP

Parts Number : 46100-SE0-305

Manufacture 1 : NISSIN

Manufacturer Number 1 :

Manufacture 2 :

Manufacturer Number 2 :

M.S.R.P 04/2010 :

Description: BRAKE MASTER CYLINDER NTP
MADE IN JAPAN

Application 1 :

Application 2 :

Application 3 :

Application 4 :

Application 5 :

Application 6 :

Application 7 :

Application 8 :

Application 9 :

Application 10 :

Application 11 :

Application 12 :

ZOOM+

ZOOM-



PARTS IMAGE

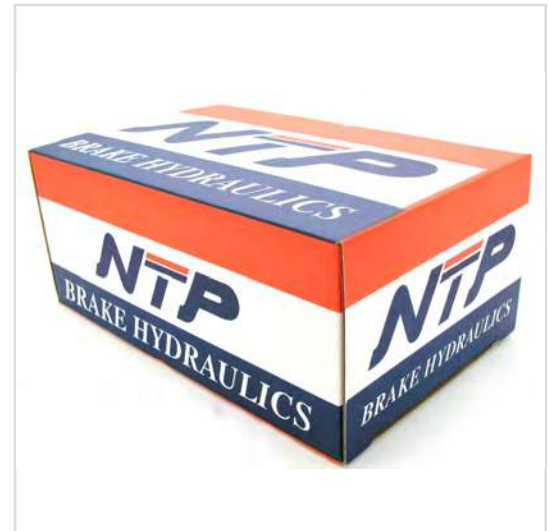

BOX IMAGE

46100-SE0-903

Parts Number : 46100-SE0-903

Manufacture 1 : NISSIN

Manufacturer Number 1 : 46100-SE0-904

Manufacture 2 :

Manufacturer Number 2 :

M.S.R.P 04/2010 : \$209.95

Description: BRAKE MASTER CYLINDER NTP
MADE IN JAPAN

- Application 1 :** ACURA INTEGRA 86-88
- Application 2 :** HONDA ACCORD 86-88
- Application 3 :** HONDA PRELUDE PGM F1 87
- Application 4 :** HONDA ACCORD W/O EFI
- Application 5 :**
- Application 6 :**
- Application 7 :**
- Application 8 :**
- Application 9 :**
- Application 10 :**
- Application 11 :**
- Application 12 :**

BRAKE MASTER CYLINDER NTP



PARTS IMAGE

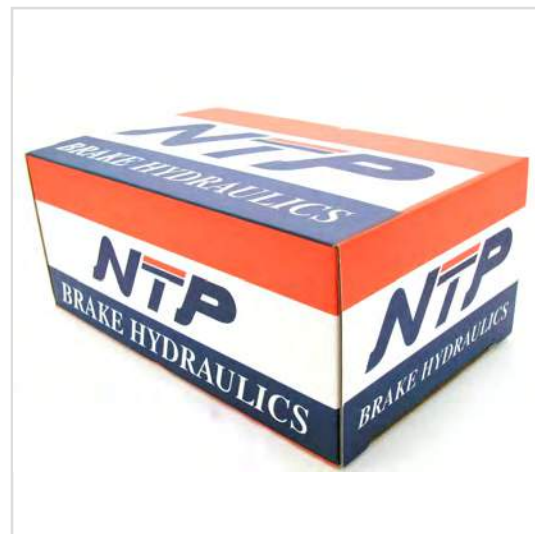

BOX IMAGE

46100-SF9-013

BRAKE MASTER CYLINDER NTP

Parts Number : 46100-SF9-013

Manufacture 1 : NISSIN

Manufacturer Number 1 : 46100-SF9-023

Manufacture 2 :

Manufacturer Number 2 :

M.S.R.P 04/2010 : \$199.07

Description: BRAKE MASTER CYLINDER NTP
MADE IN JAPAN

Application 1 : HONDA ACCORD EFI 88-89

Application 2 : HONDA PRELUDE 88-91

Application 3 :

Application 4 :

Application 5 :

Application 6 :

Application 7 :

Application 8 :

Application 9 :

Application 10 :

Application 11 :

Application 12 :

ZOOM+ ZOOM-



PARTS IMAGE

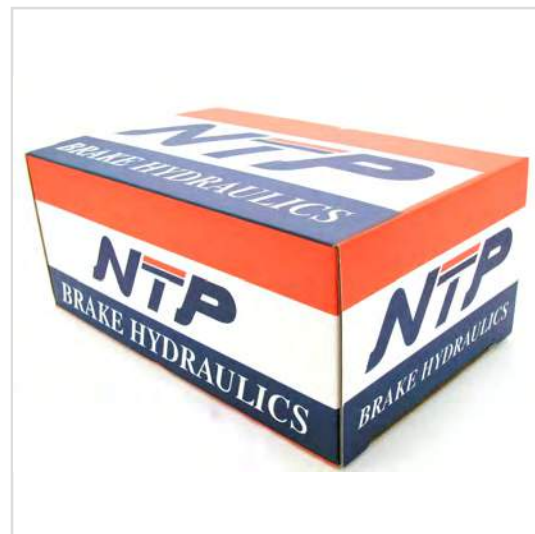

BOX IMAGE

46100-SK7-A53

BRAKE MASTER CYLINDER NTP

Parts Number : 46100-SK7-A53

Manufacture 1 : NISSIN

Manufacturer Number 1 :

Manufacture 2 :

Manufacture Number 2 :

M.S.R.P 04/2010 :

Description: BRAKE MASTER CYLINDER NTP
MADE IN JAPAN

Application 1 :

Application 2 :

Application 3 :

Application 4 :

Application 5 :

Application 6 :

Application 7 :

Application 8 :

Application 9 :

Application 10 :

Application 11 :

Application 12 :

ZOOM+

ZOOM-



PARTS IMAGE

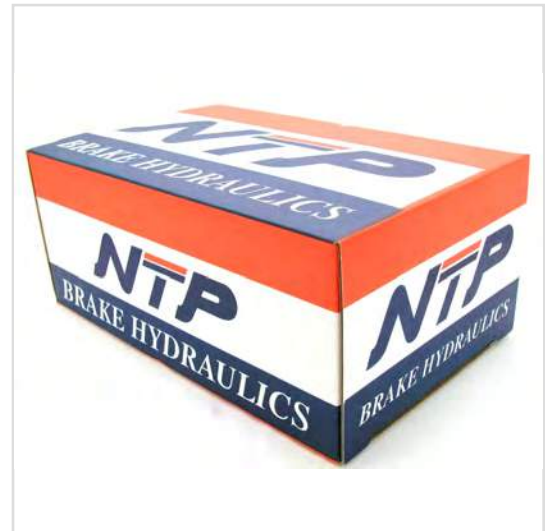

BOX IMAGE

46100-SLN-A01

BRAKE MASTER CYLINDER NTP

Parts Number : 46100-SLN-A01

Manufacture 1 : NISSIN

Manufacturer Number 1 :

Manufacture 2 :

Manufacturer Number 2 :

M.S.R.P 04/2010 :

Description: BRAKE MASTER CYLINDER NTP
MADE IN JAPAN

Application 1 :

Application 2 :

Application 3 :

Application 4 :

Application 5 :

Application 6 :

Application 7 :

Application 8 :

Application 9 :

Application 10 :

Application 11 :

Application 12 :

ZOOM+

ZOOM-



PARTS IMAGE

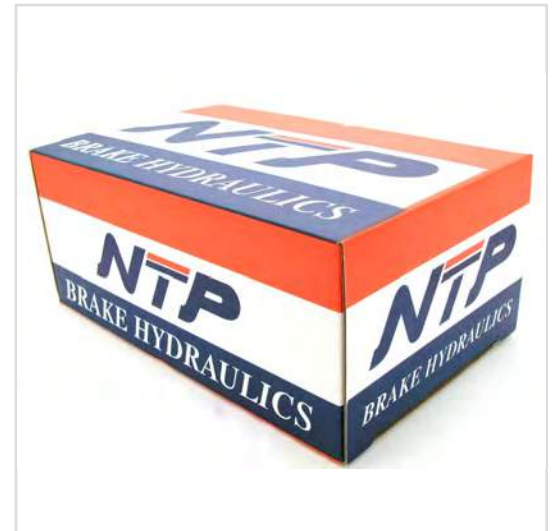

BOX IMAGE

46100-SM4-A03

BRAKE MASTER CYLINDER NTP

Parts Number : 46100-SM4-A03

Manufacture 1 : NISSIN

Manufacturer Number 1 : 46100-SM4-A04

Manufacture 2 :

Manufacture Number 2 :

M.S.R.P 04/2010 : \$151.52

Description: BRAKE MASTER CYLINDER NTP
MADE IN JAPAN

Application 1 : HONDA ACCORD 2D 90-93

Application 2 : HONDA ACCORD 2D 94-97

Application 3 : HONDA ACCORD 4D 90-93

Application 4 : HONDA ACCORD 4D 94-97

Application 5 : HONDA ACCORD WAGON 91-93

Application 6 : HONDA ACCORD WAON 94-97

Application 7 : HONDA PRELUDE 92-96

Application 8 :

Application 9 :

Application 10 :

Application 11 :

Application 12 :

ZOOM+ ZOOM-



PARTS IMAGE

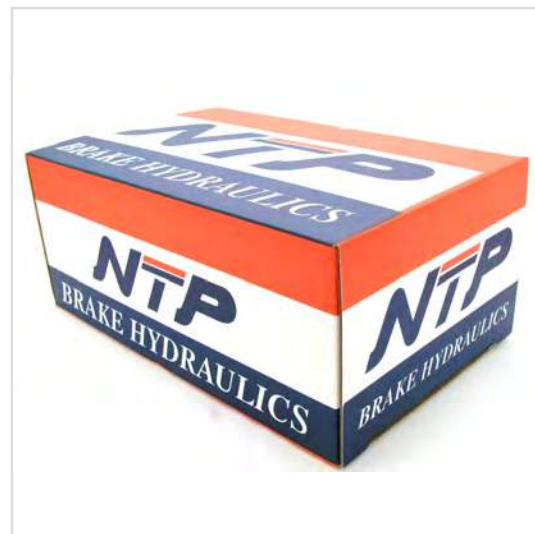

BOX IMAGE

46100-SM4-G54

BRAKE MASTER CYLINDER NTP

Parts Number : 46100-SM4-G54

Manufacture 1 : NISHIN

Manufacturer Number 1 :

Manufacture 2 :

Manufacture Number 2 :

M.S.R.P 04/2010 : \$151.52

Description: BRAKE MASTER CYLINDER NTP
MADE IN JAPAN

- Application 1 :** HONDA ACCORD EX SE 91-94
- Application 2 :** ACURA VIGOR 92-94
- Application 3 :** HONDA PRELUDE SI, SI 4WS, VTEC 92-96
- Application 4 :** HONDA ACCORD DX LX ABS 94
- Application 5 :** HONDA ACCORD 4-CYL EX 95-97
- Application 6 :** HONDA ACCORD V6 95-97
- Application 7 :** HONDA ODYSSEY 95-97
- Application 8 :** ACURA 2.5TL
- Application 9 :** ACURA 2.2 CL
- Application 10 :** ACURA 3.0 CL
- Application 11 :**
- Application 12 :**

ZOOM+ ZOOM-



PARTS IMAGE

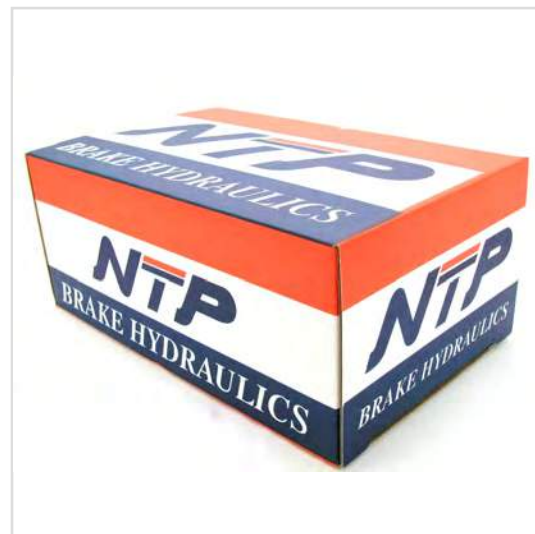

BOX IMAGE

46100-SM4-J04

BRAKE MASTER CYLINDER NTP

Parts Number : 46100-SM4-J04

Manufacture 1 : NISSIN

Manufacturer Number 1 :

Manufacture 2 :

Manufacture Number 2 :

M.S.R.P 04/2010 :

Description: BRAKE MASTER CYLINDER NTP
MADE IN JAPAN

Application 1 :

Application 2 :

Application 3 :

Application 4 :

Application 5 :

Application 6 :

Application 7 :

Application 8 :

Application 9 :

Application 10 :

Application 11 :

Application 12 :

ZOOM+

ZOOM-



PARTS IMAGE

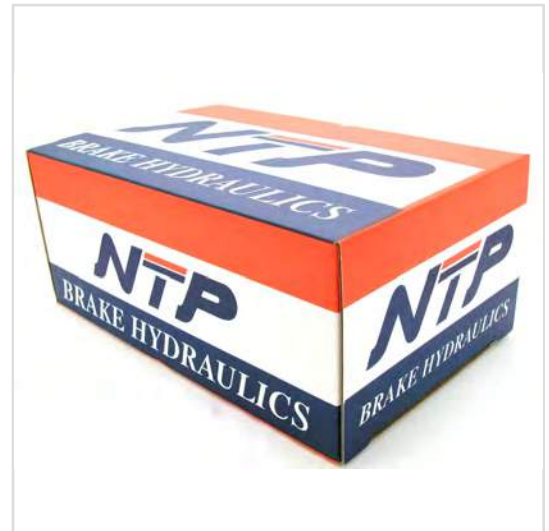

BOX IMAGE

46100-SNA-A01

BRAKE MASTER CYLINDER NTP

Parts Number : 46100-SNA-A01

Manufacture 1 : NISSIN

Manufacturer Number 1 :

Manufacture 2 :

Manufacture Number 2 :

M.S.R.P 04/2010 :

Description: BRAKE MASTER CYLINDER NTP
MADE IN JAPAN

Application 1 :

Application 2 :

Application 3 :

Application 4 :

Application 5 :

Application 6 :

Application 7 :

Application 8 :

Application 9 :

Application 10 :

Application 11 :

Application 12 :

ZOOM+

ZOOM-



PARTS IMAGE

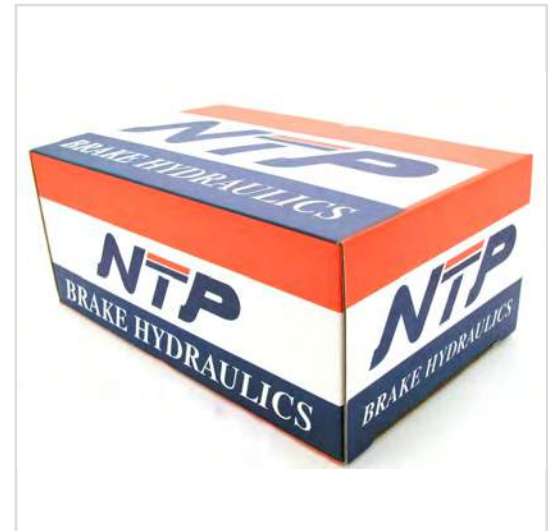

BOX IMAGE

46100-SNB-G51

Parts Number : 46100-SNB-G51

Manufacture 1 : NISSIN

Manufacturer Number 1 :

Manufacture 2 :

Manufacture Number 2 :

M.S.R.P 04/2010 :

Description: BRAKE MASTER CYLINDER NTP
MADE IN JAPAN

Application 1 :

Application 2 :

Application 3 :

Application 4 :

Application 5 :

Application 6 :

Application 7 :

Application 8 :

Application 9 :

Application 10 :

Application 11 :

Application 12 :

BRAKE MASTER CYLINDER NTP



PARTS IMAGE

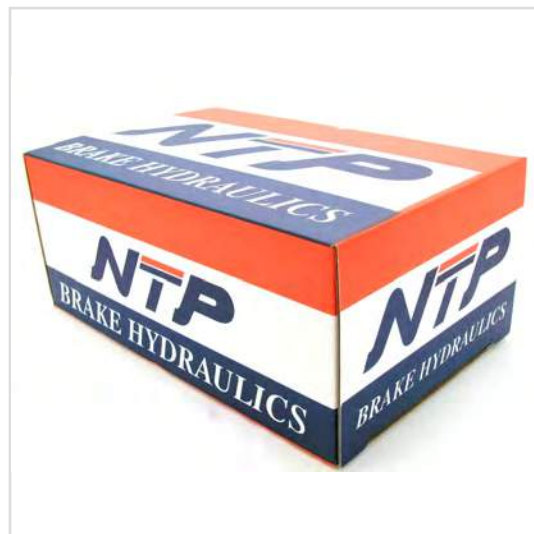

BOX IMAGE

46100-SP0-A53

BRAKE MASTER CYLINDER NTP

Parts Number : 46100-SP0-A53

Manufacture 1 : NISSIN

Manufacturer Number 1 :

Manufacture 2 :

Manufacturer Number 2 :

M.S.R.P 04/2010 :

Description: BRAKE MASTER CYLINDER NTP
MADE IN JAPAN

Application 1 :

Application 2 :

Application 3 :

Application 4 :

Application 5 :

Application 6 :

Application 7 :

Application 8 :

Application 9 :

Application 10 :

Application 11 :

Application 12 :

ZOOM+

ZOOM-



PARTS IMAGE



BOX IMAGE

46100-SP0-J54

Parts Number : 46100-SP0-J54

Manufacture 1 : NISSIN

Manufacturer Number 1 :

Manufacture 2 :

Manufacture Number 2 :

M.S.R.P 04/2010 :

Description: BRAKE MASTER CYLINDER NTP
MADE IN JAPAN

Application 1 :

Application 2 :

Application 3 :

Application 4 :

Application 5 :

Application 6 :

Application 7 :

Application 8 :

Application 9 :

Application 10 :

Application 11 :

Application 12 :

BRAKE MASTER CYLINDER NTP

ZOOM+

ZOOM-



PARTS IMAGE

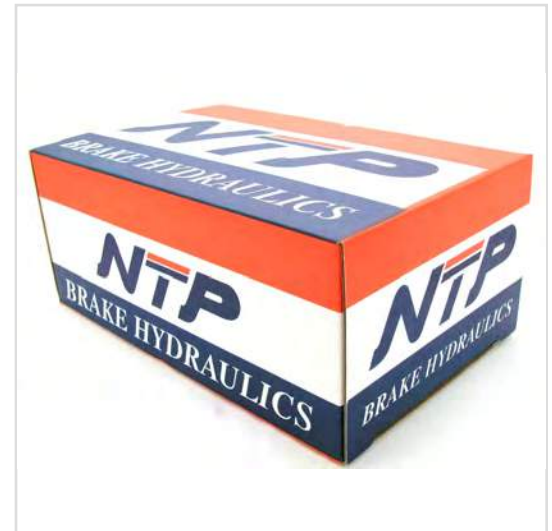

BOX IMAGE

46100-SR3-013

BRAKE MASTER CYLINDER NTP

Parts Number : 46100-SR3-013

Manufacture 1 : NISSIN

Manufacturer Number 1 : 46100-SR3-043

Manufacture 2 :

Manufacturer Number 2 :

M.S.R.P 04/2010 : \$222.72

Description: BRAKE MASTER CYLINDER NTP
MADE IN JAPAN

- Application 1 :** HONDA CIVIC STD LX DX 88-91
- Application 2 :** HONDA CVIC EX 88-91
- Application 3 :** HONDA CIVIC SI 88-91
- Application 4 :** HONDA CRX DX HF SI 88-91
- Application 5 :** HONDA CIVIC CX DX LX A/T 92-95
- Application 6 :** HONDA CIVIC CX DX LX M/T 92-95
- Application 7 :** HONDA CIVIC SI 93
- Application 8 :** HONDA CIVIC DEL SOL S SI 93-96
- Application 9 :** HONDA CIVIC VX AT/ MT 93-94
- Application 10 :** HONDA CIVIC SI W/O ABS 95
- Application 11 :**
- Application 12 :**

ZOOM+ ZOOM-



PARTS IMAGE

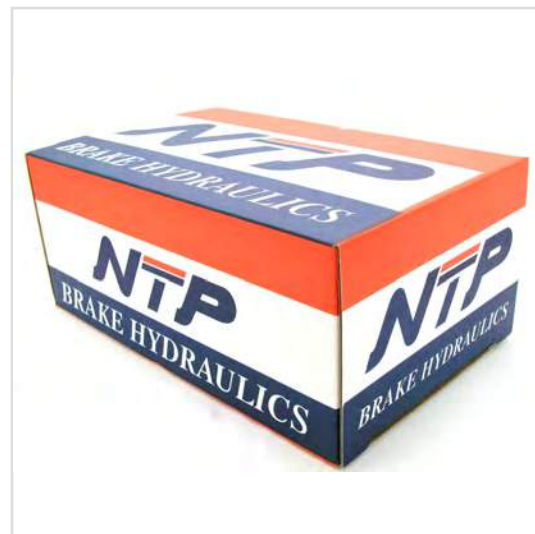

BOX IMAGE

46100-SR3-913

Parts Number : 46100-SR3-913

Manufacture 1 : ADLER

Manufacturer Number 1 : 46100-SR3-G16

Manufacture 2 :

Manufacturer Number 2 :

M.S.R.P 04/2010 :

Description: BRAKE MASTER CYLINDER NTP
MADE IN JAPAN

Application 1 : 46100-SR3-912

Application 2 :

Application 3 :

Application 4 :

Application 5 :

Application 6 :

Application 7 :

Application 8 :

Application 9 :

Application 10 :

Application 11 :

Application 12 :

BRAKE MASTER CYLINDER NTP

ZOOM+

ZOOM-



PARTS IMAGE



BOX IMAGE

46100-SR3-913

BRAKE MASTER CYLINDER NTP

Parts Number : 46100-SR3-913

Manufacture 1 : NISSIN

Manufacturer Number 1 : 46100-SR3-912

Manufacture 2 :

Manufacturer Number 2 :

M.S.R.P 04/2010 :

Description: BRAKE MASTER CYLINDER NTP
MADE IN JAPAN

Application 1 :

Application 2 :

Application 3 :

Application 4 :

Application 5 :

Application 6 :

Application 7 :

Application 8 :

Application 9 :

Application 10 :

Application 11 :

Application 12 :

ZOOM+

ZOOM-



PARTS IMAGE

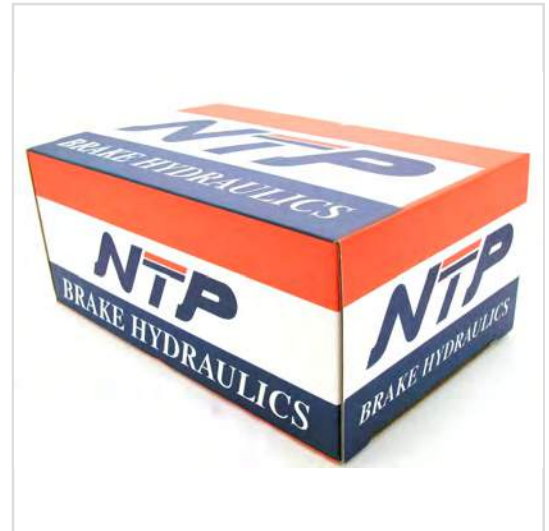

BOX IMAGE

46100-SS0-A53

BRAKE MASTER CYLINDER NTP

Parts Number : 46100-SS0-A53

Manufacture 1 : NISSIN

Manufacturer Number 1 :

Manufacture 2 :

Manufacturer Number 2 :

M.S.R.P 04/2010 :

Description: BRAKE MASTER CYLINDER NTP
MADE IN JAPAN

Application 1 :

Application 2 :

Application 3 :

Application 4 :

Application 5 :

Application 6 :

Application 7 :

Application 8 :

Application 9 :

Application 10 :

Application 11 :

Application 12 :

ZOOM+

ZOOM-



PARTS IMAGE

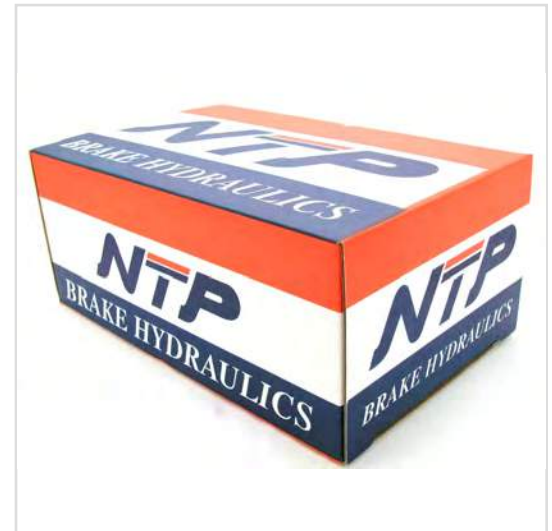

BOX IMAGE

46100-ST7-003

BRAKE MASTER CYLINDER NTP

Parts Number : 46100-ST7-003

Manufacture 1 : NISSIN

Manufacturer Number 1 : 46100-ST7-013

Manufacture 2 :

Manufacturer Number 2 :

M.S.R.P 04/2010 : \$231.28

Description: BRAKE MASTER CYLINDER NTP
MADE IN JAPAN

Application 1 : ACURA INTEGRA LS RS 90-91

Application 2 : ACURA INTEGRA 1.8L RS LS 92-93

Application 3 : ACURA INTEGRA RS 94-97

Application 4 :

Application 5 :

Application 6 :

Application 7 :

Application 8 :

Application 9 :

Application 10 :

Application 11 :

Application 12 :

ZOOM+

ZOOM-



PARTS IMAGE



BOX IMAGE

46100-ST7-A52

Parts Number : 46100-ST7-A52

Manufacture 1 : NISSIN

Manufacturer Number 1 : 46100-ST7-A51

Manufacture 2 :

Manufacture Number 2 :

M.S.R.P 04/2010 :

Description: BRAKE MASTER CYLINDER NTP
MADE IN JAPAN

Application 1 :

Application 2 :

Application 3 :

Application 4 :

Application 5 :

Application 6 :

Application 7 :

Application 8 :

Application 9 :

Application 10 :

Application 11 :

Application 12 :

BRAKE MASTER CYLINDER NTP

ZOOM+

ZOOM-



PARTS IMAGE

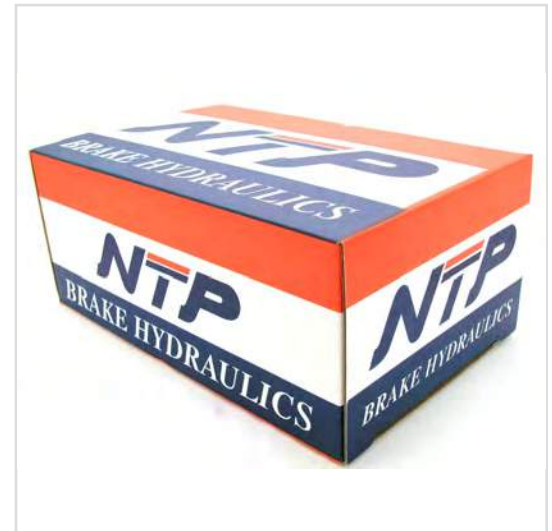

BOX IMAGE

46100-ST7-L52

BRAKE MASTER CYLINDER NTP

Parts Number : 46100-ST7-L52

Manufacture 1 : NISSIN

Manufacturer Number 1 : 46100-ST7-L51

Manufacture 2 :

Manufacturer Number 2 :

M.S.R.P 04/2010 :

Description: BRAKE MASTER CYLINDER NTP
MADE IN JAPAN

Application 1 :

Application 2 :

Application 3 :

Application 4 :

Application 5 :

Application 6 :

Application 7 :

Application 8 :

Application 9 :

Application 10 :

Application 11 :

Application 12 :

ZOOM+ ZOOM-



PARTS IMAGE

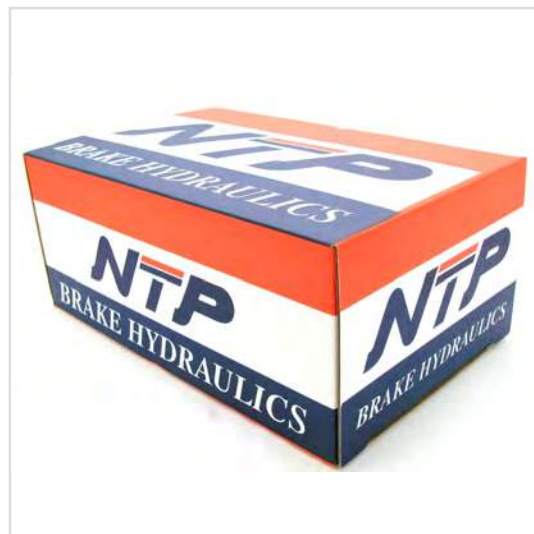

BOX IMAGE

46100-SW5-A12

BRAKE MASTER CYLINDER NTP

Parts Number : 46100-SW5-A12

Manufacture 1 : NISSIN

Manufacturer Number 1 : 46100-SW5-A11

Manufacture 2 :

Manufacturer Number 2 :

M.S.R.P 04/2010 :

Description: BRAKE MASTER CYLINDER NTP
MADE IN JAPAN

Application 1 :

Application 2 :

Application 3 :

Application 4 :

Application 5 :

Application 6 :

Application 7 :

Application 8 :

Application 9 :

Application 10 :

Application 11 :

Application 12 :

ZOOM+

ZOOM-



PARTS IMAGE

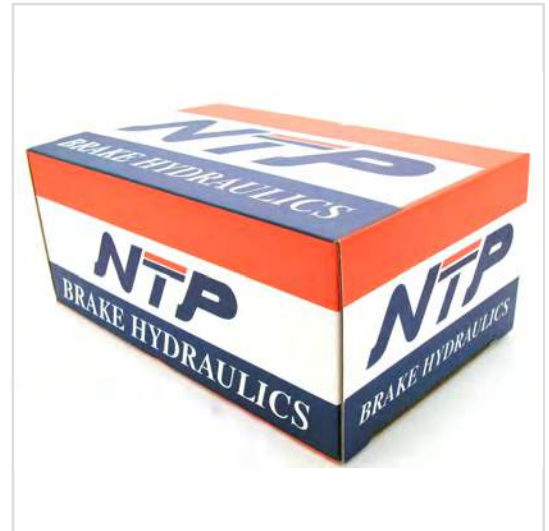

BOX IMAGE

46100-SWA-A01

Parts Number : 46100-SWA-A01

Manufacture 1 : NISSIN

Manufacturer Number 1 :

Manufacture 2 :

Manufacture Number 2 :

M.S.R.P 04/2010 :

Description: BRAKE MASTER CYLINDER NTP
MADE IN JAPAN

Application 1 :

Application 2 :

Application 3 :

Application 4 :

Application 5 :

Application 6 :

Application 7 :

Application 8 :

Application 9 :

Application 10 :

Application 11 :

Application 12 :

BRAKE MASTER CYLINDER NTP

ZOOM+

ZOOM-



PARTS IMAGE

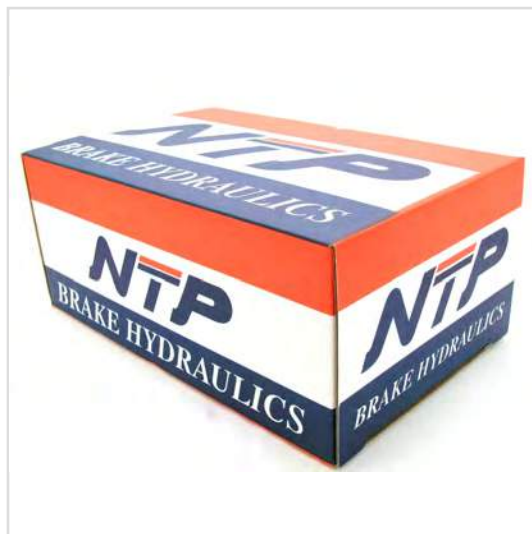

BOX IMAGE

46100-SX0-A02

BRAKE MASTER CYLINDER NTP

Parts Number : 46100-SX0-A02

Manufacture 1 : NISSIN

Manufacturer Number 1 : 46100-SX0-A01

Manufacture 2 :

Manufacturer Number 2 :

M.S.R.P 04/2010 :

Description: BRAKE MASTER CYLINDER NTP
MADE IN JAPAN

Application 1 : HONDA ACCORD 98-02

Application 2 : HONDA ODYSSEY 95-98

Application 3 :

Application 4 :

Application 5 :

Application 6 :

Application 7 :

Application 8 :

Application 9 :

Application 10 :

Application 11 :

Application 12 :

ZOOM+

ZOOM-



PARTS IMAGE

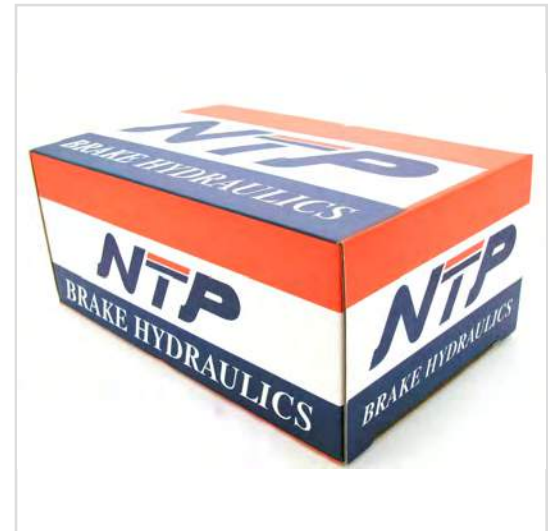

BOX IMAGE

46100-SZ3-A62

BRAKE MASTER CYLINDER NTP

Parts Number : 46100-SZ3-A62

Manufacture 1 : NISSIN

Manufacturer Number 1 : 46100-SZ3-A63

Manufacture 2 :

Manufacturer Number 2 :

M.S.R.P 04/2010 :

Description: BRAKE MASTER CYLINDER NTP
MADE IN JAPAN

Application 1 :

Application 2 :

Application 3 :

Application 4 :

Application 5 :

Application 6 :

Application 7 :

Application 8 :

Application 9 :

Application 10 :

Application 11 :

Application 12 :

ZOOM+

ZOOM-



PARTS IMAGE



BOX IMAGE

46100-SZ5-J11

BRAKE MASTER CYLINDER NTP

Parts Number : 46100-SZ5-J11

Manufacture 1 : NISSIN

Manufacturer Number 1 :

Manufacture 2 :

Manufacturer Number 2 :

M.S.R.P 04/2010 :

Description: BRAKE MASTER CYLINDER NTP
MADE IN JAPAN

Application 1 :

Application 2 :

Application 3 :

Application 4 :

Application 5 :

Application 6 :

Application 7 :

Application 8 :

Application 9 :

Application 10 :

Application 11 :

Application 12 :

ZOOM+

ZOOM-



PARTS IMAGE

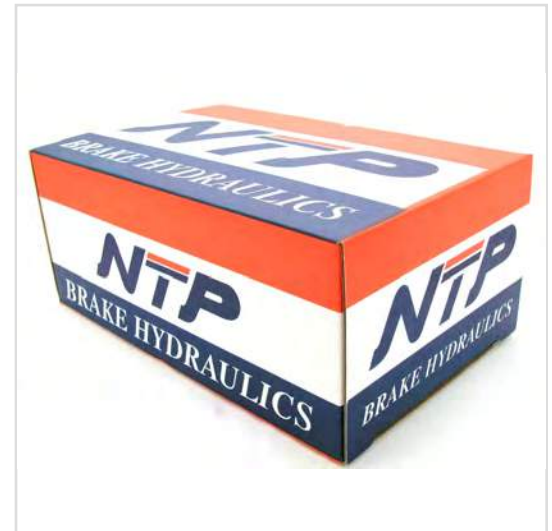

BOX IMAGE

46100-TA1-A01

Parts Number : 46100-TA1-A01

Manufacture 1 : NISSIN

Manufacturer Number 1 :

Manufacture 2 :

Manufacturer Number 2 :

M.S.R.P 04/2010 :

Description: BRAKE MASTER CYLINDER NTP
MADE IN JAPAN

Application 1 :

Application 2 :

Application 3 :

Application 4 :

Application 5 :

Application 6 :

Application 7 :

Application 8 :

Application 9 :

Application 10 :

Application 11 :

Application 12 :

BRAKE MASTER CYLINDER NTP

ZOOM+

ZOOM-



PARTS IMAGE

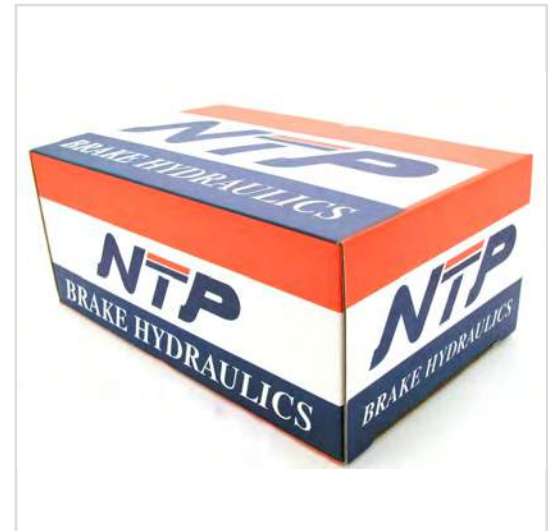

BOX IMAGE

46100-TK4-A01

Parts Number : 46100-TK4-A01

Manufacture 1 : NISSIN

Manufacturer Number 1 :

Manufacture 2 :

Manufacture Number 2 :

M.S.R.P 04/2010 :

Description: BRAKE MASTER CYLINDER NTP
MADE IN JAPAN

Application 1 :

Application 2 :

Application 3 :

Application 4 :

Application 5 :

Application 6 :

Application 7 :

Application 8 :

Application 9 :

Application 10 :

Application 11 :

Application 12 :

BRAKE MASTER CYLINDER NTP



PARTS IMAGE

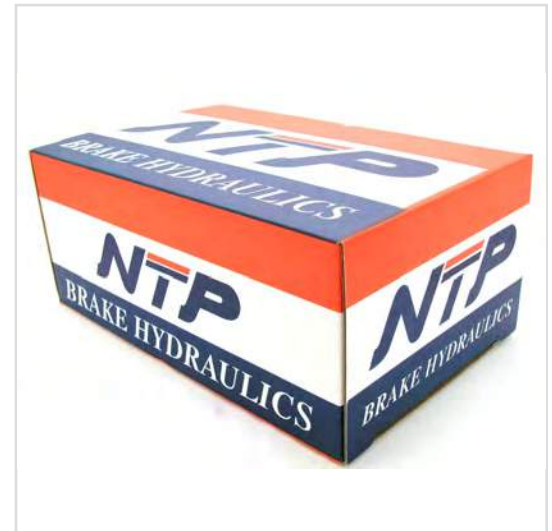

BOX IMAGE

46920-671-023

Parts Number : 46920-671-023

Manufacture 1 : ADLER

Manufacturer Number 1 :

Manufacture 2 :

Manufacturer Number 2 :

M.S.R.P 04/2010 :

Description: CLUTCH MASTER CYLINDER ADLER
MADE IN JAPAN

Application 1 :

Application 2 :

Application 3 :

Application 4 :

Application 5 :

Application 6 :

Application 7 :

Application 8 :

Application 9 :

Application 10 :

Application 11 :

Application 12 :

CLUTCH MASTER CYLINDER

ZOOM+

ZOOM-



PARTS IMAGE



BOX IMAGE

46920-S04-A01

Parts Number : 46920-S04-A01

Manufacture 1 : ADLER

Manufacturer Number 1 :

Manufacture 2 :

Manufacturer Number 2 :

M.S.R.P 04/2010 :

Description: CLUTCH MASTER CYLINDER ADLER
MADE IN JAPAN

Application 1 :

Application 2 :

Application 3 :

Application 4 :

Application 5 :

Application 6 :

Application 7 :

Application 8 :

Application 9 :

Application 10 :

Application 11 :

Application 12 :

CLUTCH MASTER CYLINDER

ZOOM+ ZOOM-



PARTS IMAGE



BOX IMAGE

46920-S10-C01

Parts Number : 46920-S10-C01

Manufacture 1 : ADLER

Manufacturer Number 1 :

Manufacture 2 :

Manufacture Number 2 :

M.S.R.P 04/2010 : \$111.30

Description: CLUTCH MASTER CYLINDER ADLER
MADE IN JAPAN

Application 1 : HONDA CR-V W/O ABS 98-01

Application 2 : HONDA CR-V ABS 98-01

Application 3 :

Application 4 :

Application 5 :

Application 6 :

Application 7 :

Application 8 :

Application 9 :

Application 10 :

Application 11 :

Application 12 :

CLUTCH MASTER CYLINDER

ZOOM+

ZOOM-



PARTS IMAGE



BOX IMAGE

46920-S2A-003

Parts Number : 46920-S2A-003

Manufacture 1 : ADLER

Manufacturer Number 1 :

Manufacture 2 :

Manufacturer Number 2 :

M.S.R.P 04/2010 : \$111.30

Description: CLUTCH MASTER CYLINDER ADLER
MADE IN JAPAN

Application 1 : HONDA S2000 00-09

Application 2 :

Application 3 :

Application 4 :

Application 5 :

Application 6 :

Application 7 :

Application 8 :

Application 9 :

Application 10 :

Application 11 :

Application 12 :

CLUTCH MASTER CYLINDER

ZOOM+

ZOOM-



PARTS IMAGE



BOX IMAGE

46920-SAA-P02

Parts Number : 46920-SAA-P02

Manufacture 1 : ADLER

Manufacturer Number 1 :

Manufacture 2 :

Manufacture Number 2 :

M.S.R.P 04/2010 :

Description: CLUTCH MASTER CYLINDER ADLER
MADE IN JAPAN

Application 1 :

Application 2 :

Application 3 :

Application 4 :

Application 5 :

Application 6 :

Application 7 :

Application 8 :

Application 9 :

Application 10 :

Application 11 :

Application 12 :

CLUTCH MASTER CYLINDER

ZOOM+

ZOOM-



PARTS IMAGE



BOX IMAGE

46920-SF1-A06

Parts Number : 46920-SF1-A06

Manufacture 1 : ADLER

Manufacturer Number 1 :

Manufacture 2 :

Manufacturer Number 2 :

M.S.R.P 04/2010 :

Description: CLUTCH MASTER CYLINDER ADLER
MADE IN JAPAN

Application 1 : 46920-SF1-A05

Application 2 :

Application 3 :

Application 4 :

Application 5 :

Application 6 :

Application 7 :

Application 8 :

Application 9 :

Application 10 :

Application 11 :

Application 12 :

CLUTCH MASTER CYLINDER

ZOOM+

ZOOM-



PARTS IMAGE



BOX IMAGE

46920-SL0-A01

Parts Number : 46920-SL0-A01

Manufacture 1 : ADLER

Manufacturer Number 1 :

Manufacture 2 :

Manufacture Number 2 :

M.S.R.P 04/2010 :

Description: CLUTCH MASTER CYLINDER ADLER
MADE IN JAPAN

Application 1 :

Application 2 :

Application 3 :

Application 4 :

Application 5 :

Application 6 :

Application 7 :

Application 8 :

Application 9 :

Application 10 :

Application 11 :

Application 12 :

CLUTCH MASTER CYLINDER

ZOOM+

ZOOM-



PARTS IMAGE



BOX IMAGE

46920-SM4-A03

Parts Number : 46920-SM4-A03

Manufacture 1 : ADLER

Manufacturer Number 1 :

Manufacture 2 :

Manufacturer Number 2 :

M.S.R.P 04/2010 : \$124.65

Description: CLUTCH MASTER CYLINDER ADLER
MADE IN JAPAN

- Application 1 :** HONDA ACCORD SOHC 90
- Application 2 :** HONDA ACCORD DOHC 90
- Application 3 :** HONDA ACCORD DX LX EX SE 91-93
- Application 4 :** HONDA PRELUDE SI SI 4WS 92
- Application 5 :** HONDA PRELUDE S VTEC 93-00
- Application 6 :** HONDA ACCORD DX LX W/O ABS 94
- Application 7 :** HONDA ACCORD DX LX ABS
- Application 8 :** HONDA ACCORD 4-CYL DX LX EX 95-97
- Application 9 :** HONDA ACCORD V6 95-97
- Application 10 :** HONDA ACURA 2.3L 98-99
- Application 11 :**
- Application 12 :**

CLUTCH MASTER CYLINDER

ZOOM+

ZOOM-



PARTS IMAGE



BOX IMAGE

46920-SR3-A01

Parts Number : 46920-SR3-A01

Manufacture 1 : ADLER

Manufacturer Number 1 :

Manufacture 2 :

Manufacturer Number 2 :

M.S.R.P 04/2010 : \$129.10

Description: CLUTCH MASTER CYLINDER ADLER
MADE IN JAPAN

Application 1 : HONDA CIVIC CX DX LX VX SI M/T 92-95

Application 2 : HONDA CIVIC DELSOL S SI 93-95

Application 3 : HONDA CIVIC EX W/O ABS 94-95

Application 4 : HONDA CIVIC SI W/O ABS 94-95

Application 5 : HONDA CIVIC EX SI LX ABS 94-95

Application 6 : HONDA CIVIC DEL SOL S SI ABS VETC 1995

Application 7 :

Application 8 :

Application 9 :

Application 10 :

Application 11 :

Application 12 :

CLUTCH MASTER CYLINDER

ZOOM+

ZOOM-



PARTS IMAGE



BOX IMAGE

46920-ST7-A01

Parts Number : 46920-ST7-A01

Manufacture 1 : ADLER

Manufacturer Number 1 :

Manufacture 2 :

Manufacture Number 2 :

M.S.R.P 04/2010 : \$129.10

Description: CLUTCH MASTER CYLINDER ADLER
MADE IN JAPAN

Application 1 : ACURA INTEGRA LS RS GS-R 94-98

Application 2 :

Application 3 :

Application 4 :

Application 5 :

Application 6 :

Application 7 :

Application 8 :

Application 9 :

Application 10 :

Application 11 :

Application 12 :

CLUTCH MASTER CYLINDER

ZOOM+

ZOOM-



PARTS IMAGE



BOX IMAGE

46930-S2A-003

Parts Number : 46930-S2A-003

Manufacture 1 : ADLER

Manufacturer Number 1 :

Manufacture 2 :

Manufacturer Number 2 :

M.S.R.P 04/2010 : \$79.22

Description: CLUTCH SLAVE CYLINDER ASSY
MADE IN JAPAN

Application 1 : HONDA S2000 00-09

Application 2 :

Application 3 :

Application 4 :

Application 5 :

Application 6 :

Application 7 :

Application 8 :

Application 9 :

Application 10 :

Application 11 :

Application 12 :

CLUTCH SLAVE CYLINDER

ZOOM+

ZOOM-



PARTS IMAGE



BOX IMAGE

46930-S3Y-003

Parts Number : 46930-S3Y-003

Manufacture 1 : ADLER

Manufacturer Number 1 :

Manufacture 2 :

Manufacturer Number 2 :

M.S.R.P 04/2010 :

Description: CLUTCH SLAVE CYLINDER ASSY
MADE IN JAPAN

Application 1 :

Application 2 :

Application 3 :

Application 4 :

Application 5 :

Application 6 :

Application 7 :

Application 8 :

Application 9 :

Application 10 :

Application 11 :

Application 12 :

CLUTCH SLAVE CYLINDER

ZOOM+

ZOOM-



PARTS IMAGE



BOX IMAGE

46930-S5A-013

Parts Number : 46930-S5A-013

Manufacture 1 : ADLER

Manufacturer Number 1 :

Manufacture 2 :

Manufacturer Number 2 :

M.S.R.P 04/2010 : \$69.75

Description: CLUTCH SLAVE CYLINDER ASSY
MADE IN JAPAN

CLUTCH SLAVE CYLINDER

ZOOM+

ZOOM-



PARTS IMAGE

Application 1 : HONDA CIVIC DX HX LX GX EX 01-02

Application 2 : HONDA CIVIC COUPE / SEDAN 03-05

Application 3 : HONDA CIVIC HYBRID 03-04

Application 4 :

Application 5 :

Application 6 :

Application 7 :

Application 8 :

Application 9 :

Application 10 :

Application 11 :

Application 12 :

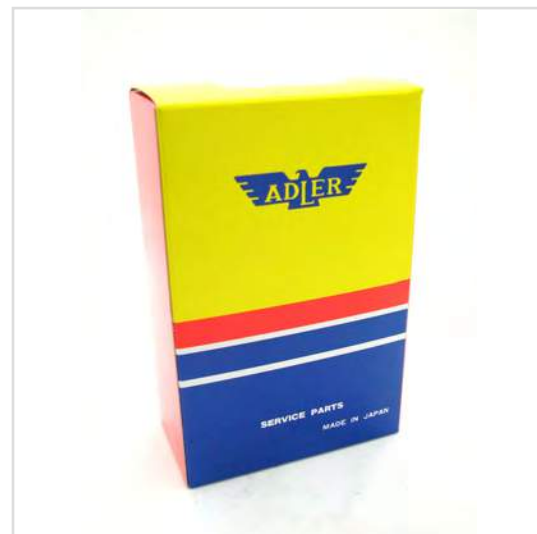

BOX IMAGE

46930-S7C-E01

Parts Number : 46930-S7C-E01

Manufacture 1 : ADLER

Manufacturer Number 1 : 46930-S7C-E02

Manufacture 2 :

Manufacturer Number 2 :

M.S.R.P 04/2010 : \$60.55

Description: CLUTCH SLAVE CYLINDER ASSY
MADE IN JAPAN

CLUTCH SLAVE CYLINDER

ZOOM+

ZOOM-



PARTS IMAGE

Application 1 : HONDA CIVIC HATCHBACK SI 02-05

Application 2 : HONDA CR-V EX LX 02-05

Application 3 : HONDA ACCORD 4-CYL 03-07

Application 4 : HONDA ACCORD V6 03-07

Application 5 : HONDA ELEMENT DX EX 03-05

Application 6 : HONDA ELEMENT EX LX 07-08

Application 7 : HONDA ELEMENT SC 07-08

Application 8 :

Application 9 :

Application 10 :

Application 11 :

Application 12 :



BOX IMAGE

46930-SD4-902

Parts Number : 46930-SD4-902

Manufacture 1 : ADLER

Manufacturer Number 1 :

Manufacture 2 :

Manufacturer Number 2 :

M.S.R.P 04/2010 :

Description: CLUTCH SLAVE CYLINDER ASSY
MADE IN JAPAN

Application 1 :

Application 2 :

Application 3 :

Application 4 :

Application 5 :

Application 6 :

Application 7 :

Application 8 :

Application 9 :

Application 10 :

Application 11 :

Application 12 :

CLUTCH SLAVE CYLINDER

ZOOM+ ZOOM-



PARTS IMAGE



BOX IMAGE

46930-SG0-A02

Parts Number : 46930-SG0-A02

Manufacture 1 : ADLER

Manufacturer Number 1 :

Manufacture 2 :

Manufacturer Number 2 :

M.S.R.P 04/2010 : \$77.52

Description: CLUTCH SLAVE CYLINDER ASSY
MADE IN JAPAN

Application 1 : ACURA LEGEND 2.7L 2D STD 87-88

Application 2 : ACURA LEGEND 2.7L 2D L/LS 87-88

Application 3 :

Application 4 :

Application 5 :

Application 6 :

Application 7 :

Application 8 :

Application 9 :

Application 10 :

Application 11 :

Application 12 :

CLUTCH SLAVE CYLINDER

ZOOM+

ZOOM-



PARTS IMAGE



BOX IMAGE

46930-SL0-003

Parts Number : 46930-SL0-003

Manufacture 1 : ADLER

Manufacturer Number 1 :

Manufacture 2 :

Manufacturer Number 2 :

M.S.R.P 04/2010 :

Description: CLUTCH SLAVE CYLINDER ASSY
MADE IN JAPAN

Application 1 :

Application 2 :

Application 3 :

Application 4 :

Application 5 :

Application 6 :

Application 7 :

Application 8 :

Application 9 :

Application 10 :

Application 11 :

Application 12 :

CLUTCH SLAVE CYLINDER

ZOOM+

ZOOM-



PARTS IMAGE



BOX IMAGE

46930-SM4-003

Parts Number : 46930-SM4-003

Manufacture 1 : ADLER

Manufacturer Number 1 :

Manufacture 2 :

Manufacturer Number 2 :

M.S.R.P 04/2010 : \$75.68

Description: CLUTCH SLAVE CYLINDER ASSY
MADE IN JAPAN

CLUTCH SLAVE CYLINDER

ZOOM+

ZOOM-



PARTS IMAGE

- Application 1 :** HONDA ACCORD SOHC 90
- Application 2 :** HONDA ACCORD DOHC 90
- Application 3 :** HONDA ACCORD DX LX EX SE 91-93
- Application 4 :** HONDA PRELUDE SI SI 4WS 92-94
- Application 5 :** HONDA ACCORD EX LX W/O ABS 94
- Application 6 :** HONDA ACCORD DX LX ABS
- Application 7 :** HONDA ACCORD EX 94
- Application 8 :** HONDA PRELUDE S VETC 94-00
- Application 9 :** HONDA ACCORD 4CYL EX LX EX 95-97
- Application 10 :** HONDA ACCORD V6 95-97
- Application 11 :** ACURA 2.3CL 98-99
- Application 12 :**



BOX IMAGE

46930-SP0-A01

Parts Number : 46930-SP0-A01

Manufacture 1 : ADLER

Manufacturer Number 1 : AS28

Manufacture 2 :

Manufacturer Number 2 :

M.S.R.P 04/2010 : \$85.97

Description: CLUTCH SLAVE CYLINDER ASSY
MADE IN JAPAN

Application 1 : ACURA LEGEND 2D 91-95

Application 2 : ACURA LEGEND 4D 91-95

Application 3 :

Application 4 :

Application 5 :

Application 6 :

Application 7 :

Application 8 :

Application 9 :

Application 10 :

Application 11 :

Application 12 :

CLUTCH SLAVE CYLINDER

ZOOM+

ZOOM-



PARTS IMAGE



BOX IMAGE

46930-SR3-013

Parts Number : 46930-SR3-013

Manufacture 1 : ADLER

Manufacturer Number 1 :

Manufacture 2 :

Manufacturer Number 2 :

M.S.R.P 04/2010 : \$75.68

Description: CLUTCH SLAVE CYLINDER ADLER
MADE IN JAPAN

CLUTCH SLAVE CYLINDER

ZOOM+

ZOOM-



PARTS IMAGE

Application 1 : HONDA CIVIC CX DX LX VX M/T 92-00

Application 2 : HONDA CIVIC EX 92-94

Application 3 : HONDA CIVIC SI 92-93

Application 4 : HONDA CIVIC DEL SOL S SI 93-96

Application 5 : HONDA CIVIC EX W/O ABS 94-95

Application 6 : HONDA CIVIC EX SI LX ABS 94-95

Application 7 : HONDA CIVIC SI W/O ABS 94-95

Application 8 : ACURA INTEGRA LS RS GS-R 95-98

Application 9 : HONDA CIVIC EX X HX W/O ABS 98-00

Application 10 : HONDA CIVIC EX GX ABS 98-00

Application 11 : HONDA CIVIC SI 99-00

Application 12 :



BOX IMAGE

47550-20120

WHEEL CYLINDER ADLER

Parts Number : 47550-20120

Manufacture 1 : ADLER

Manufacturer Number 1 :

Manufacture 2 :

Manufacturer Number 2 :

M.S.R.P 04/2010 : \$57.01

Description: WHEEL CYLINDER ADLER MADE IN JAPAN

- Application 1 :** TOYOTA TERCEL SEDAN 83-90
- Application 2 :** TOYOTA COROLLA 4D SEDAN 86-90
- Application 3 :** TOYOTA COROLLA FX-16 87-88
- Application 4 :** TOYOTA COROLLA SEDAN WAGON 88-91
- Application 5 :** TOYOTA COROLLA COUPE GT-S 88-91
- Application 6 :** TOYOTA TERCEL EFI 90-94
- Application 7 :** TOTOTA COROLLA 92-94
- Application 8 :**
- Application 9 :**
- Application 10 :**
- Application 11 :**
- Application 12 :**

ZOOM+ ZOOM-



PARTS IMAGE



BOX IMAGE

47550-20130

WHEEL CYLINDER ADLER

Parts Number : 47550-20130

Manufacture 1 : ADLER

Manufacturer Number 1 :

Manufacture 2 :

Manufacture Number 2 :

M.S.R.P 04/2010 :

Description: WHEEL CYLINDER ADLER MADE IN JAPAN

Application 1 :

Application 2 :

Application 3 :

Application 4 :

Application 5 :

Application 6 :

Application 7 :

Application 8 :

Application 9 :

Application 10 :

Application 11 :

Application 12 :

ZOOM+

ZOOM-



PARTS IMAGE



BOX IMAGE

47570-20030

WHEEL CYLINDER ADLER

Parts Number : 47570-20030

Manufacture 1 : ADLER

Manufacturer Number 1 :

Manufacture 2 :

Manufacture Number 2 :

M.S.R.P 04/2010 : \$57.01

Description: WHEEL CYLINDER ADLER MADE IN JAPAN

- Application 1 :** TOYOTA TERCEL SEDAN 83-90
- Application 2 :** TOYOTA COROLLA 4D SEDAN 86-90
- Application 3 :** TOYOTA COROLLA FX-16 87-88
- Application 4 :** TOYOTA COROLLA SEDAN WAGON 88-91
- Application 5 :** TOYOTA COROLLA COUPE GT-S 88-91
- Application 6 :** TOYOTA TERCEL EFI 90-94
- Application 7 :** TOTOTA COROLLA 92-94
- Application 8 :**
- Application 9 :**
- Application 10 :**
- Application 11 :**
- Application 12 :**

ZOOM+ ZOOM-



PARTS IMAGE



BOX IMAGE

47570-20040

WHEEL CYLINDER ADLER

Parts Number : 47570-20040

Manufacture 1 : ADLER

Manufacturer Number 1 :

Manufacture 2 :

Manufacture Number 2 :

M.S.R.P 04/2010 :

Description: WHEEL CYLINDER ADLER MADE IN JAPAN

Application 1 :

Application 2 :

Application 3 :

Application 4 :

Application 5 :

Application 6 :

Application 7 :

Application 8 :

Application 9 :

Application 10 :

Application 11 :

Application 12 :

ZOOM+

ZOOM-



PARTS IMAGE



BOX IMAGE

4T-JLM704610

BELT TENSIONER

Parts Number : 4T-JLM704610

Manufacture 1 : NTN

Manufacturer Number 1 :

Manufacture 2 :

Manufacturer Number 2 :

M.S.R.P 04/2010 :

Description: BELT TENSIONER

Application 1 :

Application 2 :

Application 3 :

Application 4 :

Application 5 :

Application 6 :

Application 7 :

Application 8 :

Application 9 :

Application 10 :

Application 11 :

Application 12 :

ZOOM+

ZOOM-



PARTS IMAGE

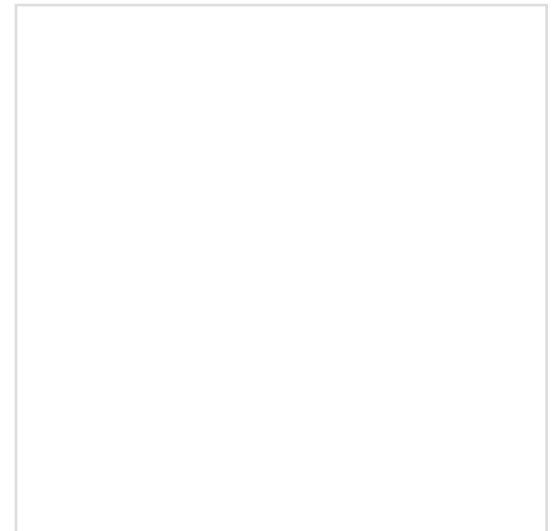

BOX IMAGE

57450-SM4-954

SENSOR ABS (FRONT RIGHT)

Parts Number : 57450-SM4-954

Manufacture 1 : HONDA LOCK

Manufacturer Number 1 : 9B03 (R)

Manufacture 2 :

Manufacture Number 2 :

M.S.R.P 04/2010 : \$144.78

Description: SENSOR ABS (FRONT RIGHT)
MADE IN JAPAN #OEM

Application 1 : HONDA ACCORD 2D 90-93

Application 2 : HONDA ACCORD 4D 90-93

Application 3 : HONDA ACCORD WAGON 91-93

Application 4 :

Application 5 :

Application 6 :

Application 7 :

Application 8 :

Application 9 :

Application 10 :

Application 11 :

Application 12 :

ZOOM+

ZOOM-



PARTS IMAGE

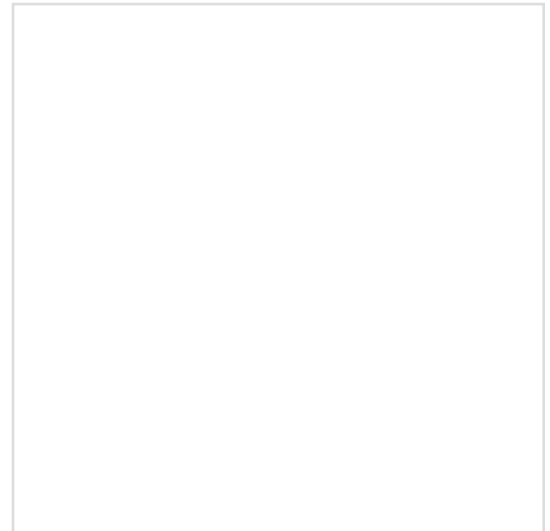

BOX IMAGE

57450-SP0-010

SENSOR ABS (FRONT RIGHT)

Parts Number : 57450-SP0-010

Manufacture 1 : HONDA LOCK

Manufacturer Number 1 : SP0-000 (9E18)(R)

Manufacture 2 :

Manufacture Number 2 :

M.S.R.P 04/2010 : \$152.97

Description: SENSOR ABS (FRONT RIGHT)
MADE IN JAPAN #OEM

Application 1 : ACURA LEGEND 91-95

Application 2 :

Application 3 :

Application 4 :

Application 5 :

Application 6 :

Application 7 :

Application 8 :

Application 9 :

Application 10 :

Application 11 :

Application 12 :

ZOOM+

ZOOM-



PARTS IMAGE

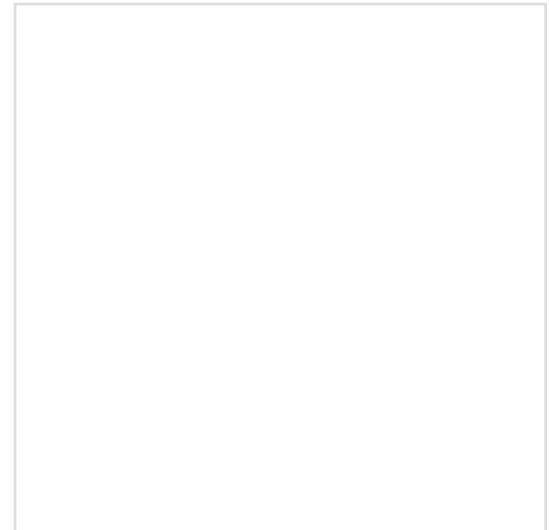

BOX IMAGE

57450-SV4-950

SENSOR ABS (FRONT RIGHT)

Parts Number : 57450-SV4-950

Manufacture 1 : HONDA LOCK

Manufacturer Number 1 : SV4-000 (9L02)(R)

Manufacture 2 :

Manufacture Number 2 :

M.S.R.P 04/2010 : \$166.90

Description: SENSOR ABS (FRONT RIGHT)
MADE IN JAPAN #OEM

Application 1 : HONDA ACCORD 2D 94-97

Application 2 : HONDA ACCORD 4D 94-97 E2 V6 E2

Application 3 : HONDA ACCORD WAGON 94-97

Application 4 : HONDA ODYSSEY 95-98

Application 5 : ACURA CL 2.2L &2.3L 97-99

Application 6 :

Application 7 :

Application 8 :

Application 9 :

Application 10 :

Application 11 :

Application 12 :

ZOOM+

ZOOM-



PARTS IMAGE

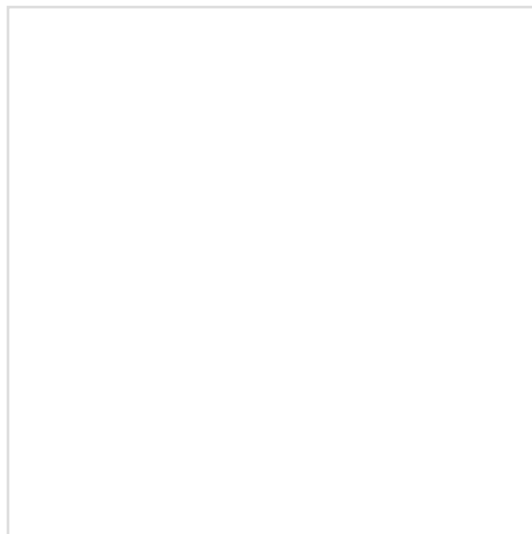

BOX IMAGE

57450-SV7-A50

SENSOR ABS (FRONT RIGHT)

Parts Number : 57450-SV7-A50

Manufacture 1 : HONDA LOCK

Manufacturer Number 1 : SV7-000 (9D02)(R)

Manufacture 2 :

Manufacture Number 2 :

M.S.R.P 04/2010 : \$191.65

Description: SENSOR ABS (FRONT RIGHT)
MADE IN JAPAN #OEM/G

Application 1 : HONDA ACCORD 4D 94-97 E2 V6 E2

Application 2 : ACURA CL 3.0 L 97-99

Application 3 :

Application 4 :

Application 5 :

Application 6 :

Application 7 :

Application 8 :

Application 9 :

Application 10 :

Application 11 :

Application 12 :

ZOOM+

ZOOM-



PARTS IMAGE

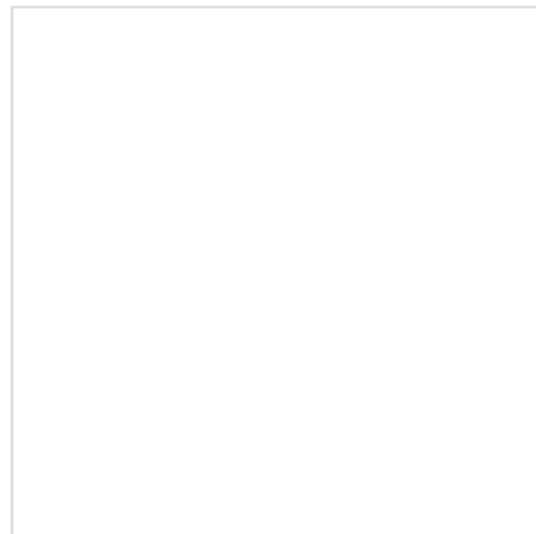

BOX IMAGE

57450-SZ3-000

SENSOR ABS (FRONT RIGHT)

Parts Number : 57450-SZ3-000

Manufacture 1 : HONDA LOCK

Manufacturer Number 1 : SZ3-000 (9D10)(R)

Manufacture 2 :

Manufacture Number 2 :

M.S.R.P 04/2010 : \$148.38

Description: SENSOR ABS (FRONT RIGHT)
MADE IN JAPAN #OE

Application 1 : ACURA RL 3.5L 96-04

Application 2 :

Application 3 :

Application 4 :

Application 5 :

Application 6 :

Application 7 :

Application 8 :

Application 9 :

Application 10 :

Application 11 :

Application 12 :

ZOOM+ ZOOM-



PARTS IMAGE

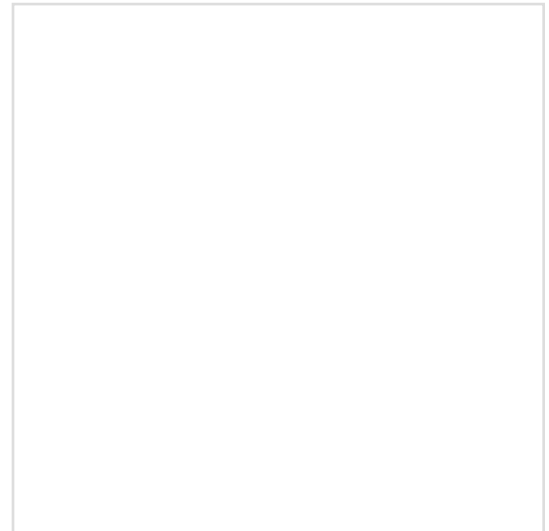

BOX IMAGE

57455-SM4-954

SENSOR ABS (FRONT LEFT)

Parts Number : 57455-SM4-954

Manufacture 1 : HONDA LOCK

Manufacturer Number 1 : SM4-030 (8H06)(L)

Manufacture 2 :

Manufacturer Number 2 :

M.S.R.P 04/2010 : \$144.78

Description: SENSOR ABS (FRONT LEFT)
MADE IN JAPAN #OEM

Application 1 : HONDA ACCORD 2D 90-93

Application 2 : HONDA ACCORD 4D 90-93

Application 3 : HONDA ACCORD WAGON 91-93

Application 4 :

Application 5 :

Application 6 :

Application 7 :

Application 8 :

Application 9 :

Application 10 :

Application 11 :

Application 12 :

ZOOM+

ZOOM-



PARTS IMAGE

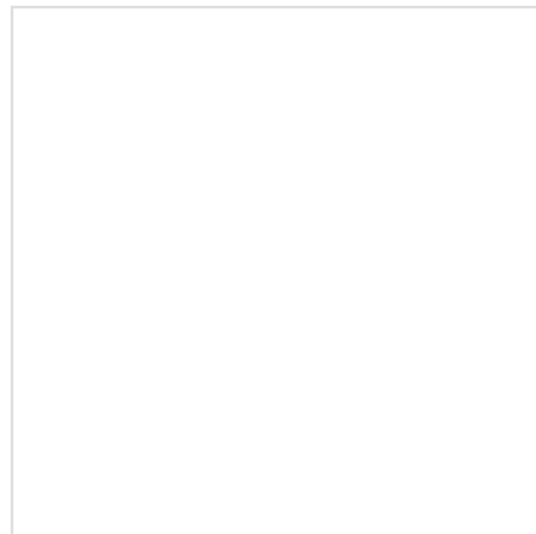

BOX IMAGE

57455-SP0-010

SENSOR ABS (FRONT LEFT)

Parts Number : 57455-SP0-010

Manufacture 1 : HONDA LOCK

Manufacturer Number 1 : SPO-010 (9F25)(L)

Manufacture 2 :

Manufacturer Number 2 :

M.S.R.P 04/2010 : \$152.97

Description: SENSOR ABS (FRONT LEFT)
MADE IN JAPAN #OEM

Application 1 : ACURA LEGEND 91-95

Application 2 :

Application 3 :

Application 4 :

Application 5 :

Application 6 :

Application 7 :

Application 8 :

Application 9 :

Application 10 :

Application 11 :

Application 12 :

ZOOM+

ZOOM-



PARTS IMAGE

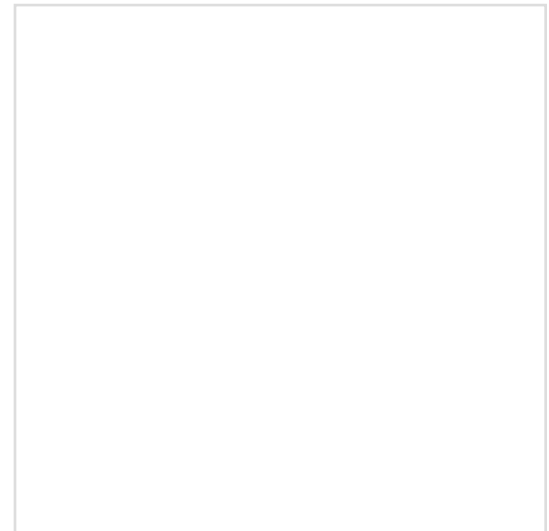

BOX IMAGE

57455-SZ3-000

SENSOR ABS (FRONT LEFT)

Parts Number : 57455-SZ3-000

Manufacture 1 : HONDA LOCK

Manufacturer Number 1 : SZ3-010 (9C04)(R)

Manufacture 2 :

Manufacture Number 2 :

M.S.R.P 04/2010 : \$148.38

Description: SENSOR ABS (FRONT LEFT)
MADE IN JAPAN #OEM

Application 1 : ACURA RL 3.5L 96-04

Application 2 :

Application 3 :

Application 4 :

Application 5 :

Application 6 :

Application 7 :

Application 8 :

Application 9 :

Application 10 :

Application 11 :

Application 12 :

ZOOM+ ZOOM-



PARTS IMAGE

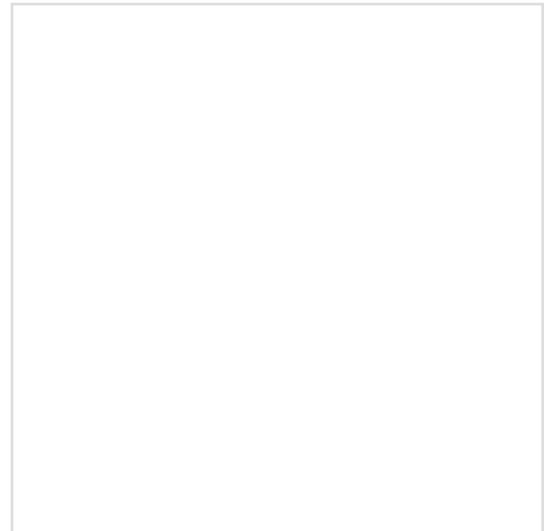

BOX IMAGE

57470-SM4-952

SENSOR ABS (REAR RIGHT)

Parts Number :	57470-SM4-952
Manufacture 1 :	HONDA LOCK <input type="button" value="v"/>
Manufacturer Number 1 :	SM4-100 (9F10)
Manufacture 2 :	<input type="button" value="v"/>
Manufacturer Number 2 :	
M.S.R.P 04/2010 :	\$144.78
Description:	SENSOR ABS (REAR RIGHT) MADE IN JAPAN #OEM

- Application 1 :** HONDA ACCORD 2D 90-93
- Application 2 :** HONDA ACCORD 4D 90-93
- Application 3 :**
- Application 4 :**
- Application 5 :**
- Application 6 :**
- Application 7 :**
- Application 8 :**
- Application 9 :**
- Application 10 :**
- Application 11 :**
- Application 12 :**

ZOOM+ ZOOM-



PARTS IMAGE

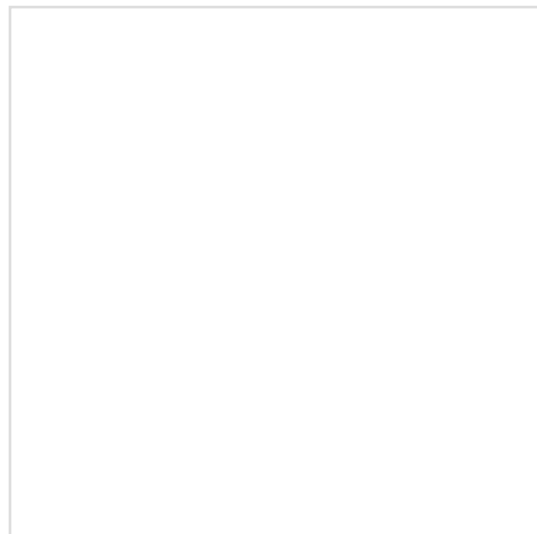

BOX IMAGE

57470-SP0-010

SENSOR ABS (REAR RIGHT)

Parts Number : 57470-SP0-010

Manufacture 1 : HONDA LOCK

Manufacturer Number 1 : SP0-100 (9G09)(R)

Manufacture 2 :

Manufacturer Number 2 :

M.S.R.P 04/2010 : \$152.97

Description: SENSOR ABS (REAR RIGHT)
MADE IN JAPAN #OEM

Application 1 : ACURA LEGEND 91-95

Application 2 :

Application 3 :

Application 4 :

Application 5 :

Application 6 :

Application 7 :

Application 8 :

Application 9 :

Application 10 :

Application 11 :

Application 12 :

ZOOM+ ZOOM-

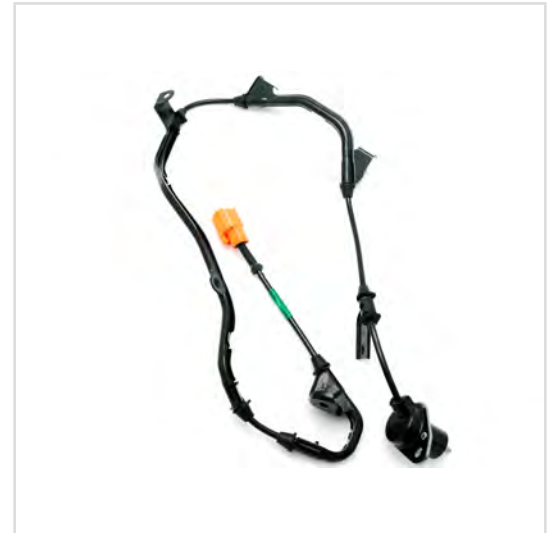

PARTS IMAGE

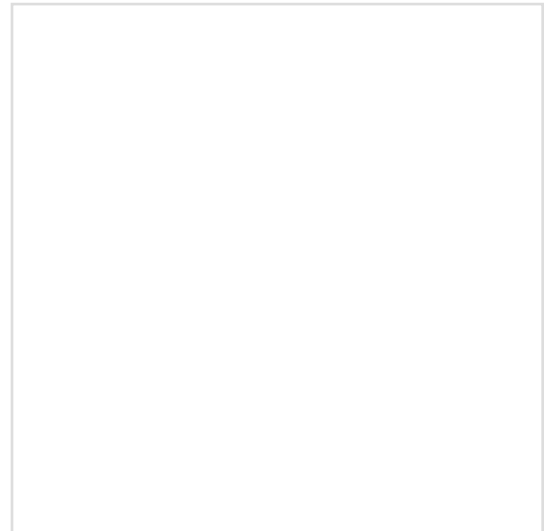

BOX IMAGE

57470-SR3-A02

SENSOR ABS (REAR RIGHT)

Parts Number : 57470-SR3-A02

Manufacture 1 : HONDA LOCK

Manufacturer Number 1 : SR3-320 (9G22)(R)

Manufacture 2 :

Manufacture Number 2 :

M.S.R.P 04/2010 : \$157.55

Description: SENSOR ABS (REAR RIGHT)
MADE IN JAPAN #OEM

Application 1 : HONDA CIVIC 2D 93-95

Application 2 : HONDA CIVIC 3D 92-95

Application 3 : HONDA CIVIC 4D 92-95

Application 4 : ACURA INTEGRA 94-01

Application 5 :

Application 6 :

Application 7 :

Application 8 :

Application 9 :

Application 10 :

Application 11 :

Application 12 :

ZOOM+

ZOOM-

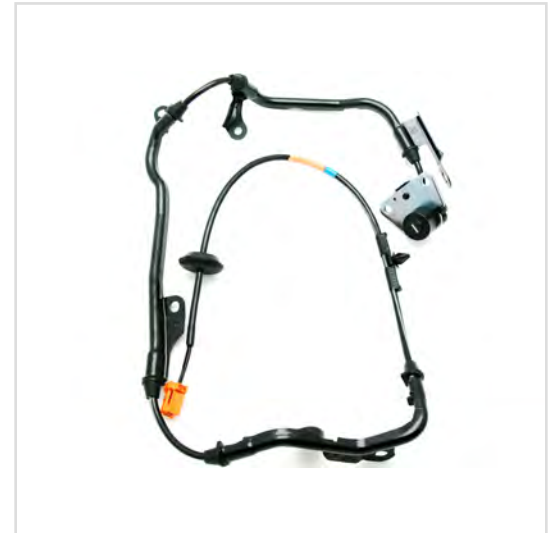

PARTS IMAGE

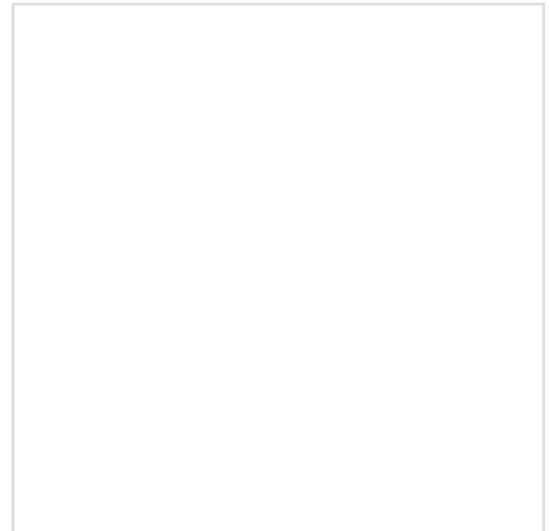

BOX IMAGE

57470-SZ3-010

SENSOR ABS (REAR RIGHT)

Parts Number : 57470-SZ3-010

Manufacture 1 : HONDA LOCK

Manufacturer Number 1 : 9E11 (R)

Manufacture 2 :

Manufacture Number 2 :

M.S.R.P 04/2010 : \$137.30

Description: SENSOR ABS (REAR RIGHT)
MADE IN JAPAN #OEM

Application 1 : ACURA RL 3.5L 96-01

Application 2 :

Application 3 :

Application 4 :

Application 5 :

Application 6 :

Application 7 :

Application 8 :

Application 9 :

Application 10 :

Application 11 :

Application 12 :

ZOOM+ ZOOM-



PARTS IMAGE

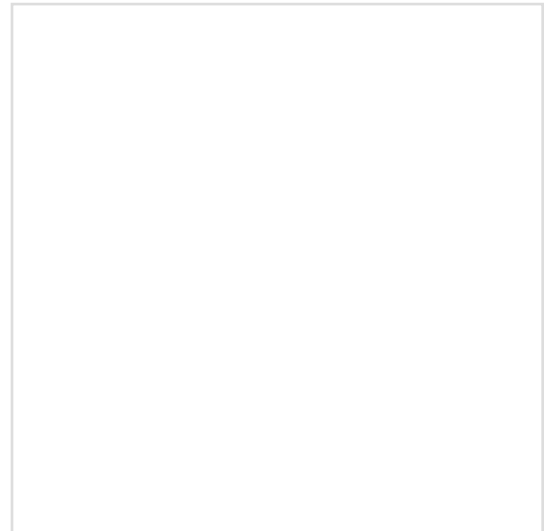

BOX IMAGE

57475-SM4-952

SENSOR ABS (REAR LEFT)

Parts Number : 57475-SM4-952

Manufacture 1 : HONDA LOCK

Manufacturer Number 1 : SM4-110 (9K05) (L)

Manufacture 2 :

Manufacture Number 2 :

M.S.R.P 04/2010 : \$144.78

Description: SENSOR ABS (REAR LEFT)
MADE IN JAPAN #OEM

Application 1 : HONDA ACCORD 2D 90-93

Application 2 : HONDA ACCORD 4D 90-93

Application 3 :

Application 4 :

Application 5 :

Application 6 :

Application 7 :

Application 8 :

Application 9 :

Application 10 :

Application 11 :

Application 12 :

ZOOM+

ZOOM-



PARTS IMAGE

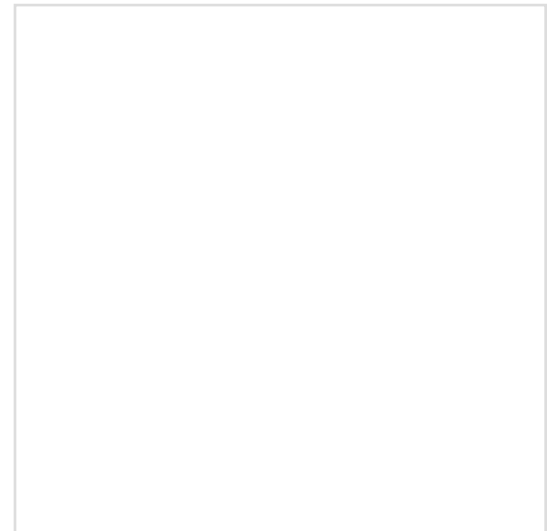

BOX IMAGE

57475-SP0-010

SENSOR ABS (REAR LEFT)

Parts Number : 57475-SP0-010

Manufacture 1 : HONDA LOCK

Manufacturer Number 1 : 9E08 (L)

Manufacture 2 :

Manufacturer Number 2 :

M.S.R.P 04/2010 : \$152.97

Description: SENSOR ABS (REAR LEFT)
MADE IN JAPAN #OEM

Application 1 : ACURA LEGEND 91-95

Application 2 :

Application 3 :

Application 4 :

Application 5 :

Application 6 :

Application 7 :

Application 8 :

Application 9 :

Application 10 :

Application 11 :

Application 12 :

ZOOM+

ZOOM-

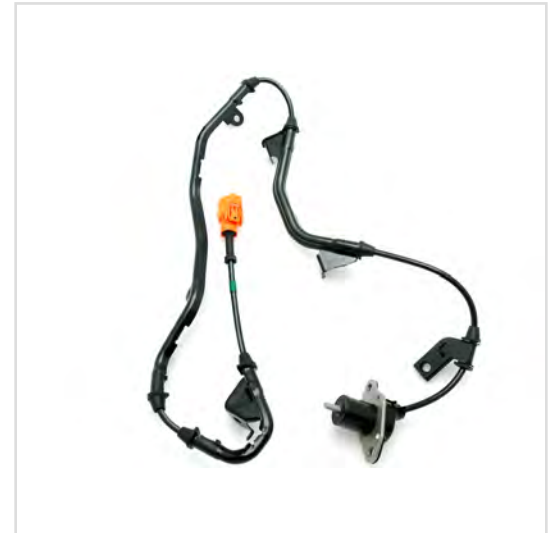

PARTS IMAGE

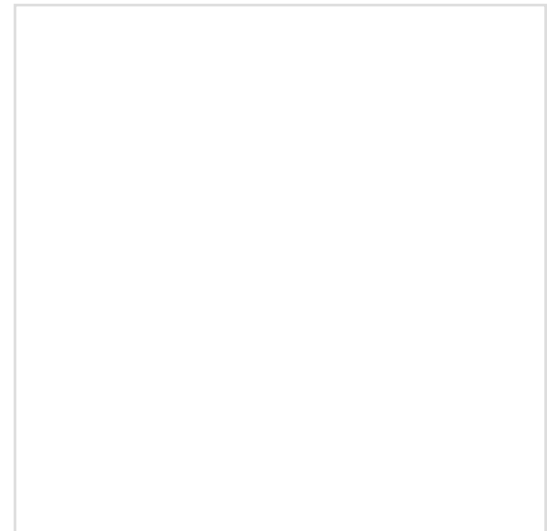

BOX IMAGE

6001/012-2NSL

BELT TENSIONER

Parts Number : 6001/012-2NSL

Manufacture 1 : NACHI

Manufacturer Number 1 : 6001/0122NSE

Manufacture 2 :

Manufacturer Number 2 :

M.S.R.P 04/2010 :

Description: BELT TENSIONER

Application 1 :

Application 2 :

Application 3 :

Application 4 :

Application 5 :

Application 6 :

Application 7 :

Application 8 :

Application 9 :

Application 10 :

Application 11 :

Application 12 :

ZOOM+

ZOOM-

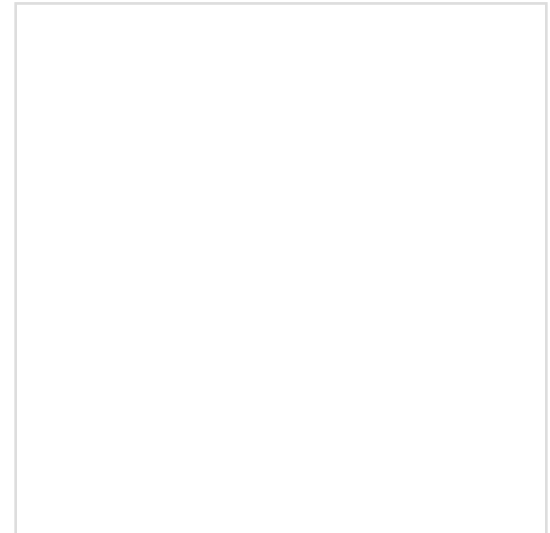

PARTS IMAGE

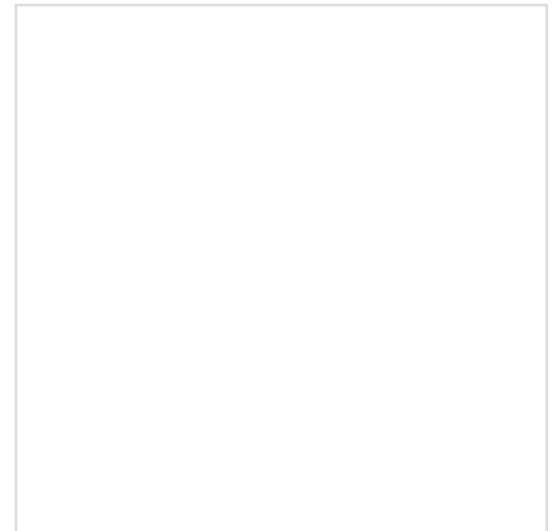

BOX IMAGE

6306

BELT TENSIONER MADE IN

Parts Number : 6306

Manufacture 1 : NACHI

Manufacturer Number 1 : 6306C3

Manufacture 2 :

Manufacturer Number 2 :

M.S.R.P 04/2010 :

Description: BELT TENSIONER MADE IN JAPAN

Application 1 :

Application 2 :

Application 3 :

Application 4 :

Application 5 :

Application 6 :

Application 7 :

Application 8 :

Application 9 :

Application 10 :

Application 11 :

Application 12 :

ZOOM+

ZOOM-



PARTS IMAGE



BOX IMAGE

72155-SV4-A21

DOOR - LOCK ACTUATOR

Parts Number :	72155-SV4-A21
Manufacture 1 :	MITSUI MINING & SMELTING <input type="button" value="v"/>
Manufacturer Number 1 :	H70-32120
Manufacture 2 :	<input type="button" value="v"/>
Manufacturer Number 2 :	
M.S.R.P 04/2010 :	\$122.95
Description:	DOOR - LOCK ACTUATOR MADE IN JAPAN #G

- Application 1 :** HONDA ACCORD 4D 94-97 E2 V6 E2
- Application 2 :** HONDA ACCORD WAGON 94-97
- Application 3 :**
- Application 4 :**
- Application 5 :**
- Application 6 :**
- Application 7 :**
- Application 8 :**
- Application 9 :**
- Application 10 :**
- Application 11 :**
- Application 12 :**

ZOOM+ ZOOM-



PARTS IMAGE

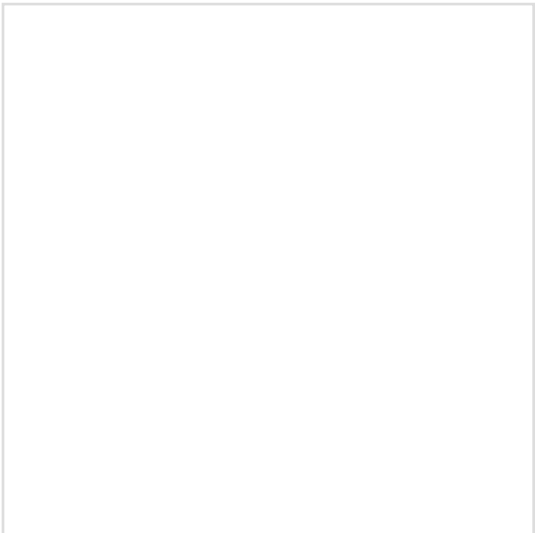

BOX IMAGE

78410-S04-901

SENSOR SPEED

Parts Number : 78410-S04-901

Manufacture 1 : DENSO

Manufacturer Number 1 : 41209L08

Manufacture 2 :

Manufacture Number 2 :

M.S.R.P 04/2010 : \$120.92

Description: SENSOR SPEED
MADE IN JAPAN #OEM

Application 1 : HONDA CIVIC 2D 96-00

Application 2 : HONDA CIVIC 3D 96-00

Application 3 : HONDA CIVIC 96-97(US) 96-00(EXP)

Application 4 : HONDA CIVIC 4D 98-00

Application 5 :

Application 6 :

Application 7 :

Application 8 :

Application 9 :

Application 10 :

Application 11 :

Application 12 :

ZOOM+

ZOOM-



PARTS IMAGE

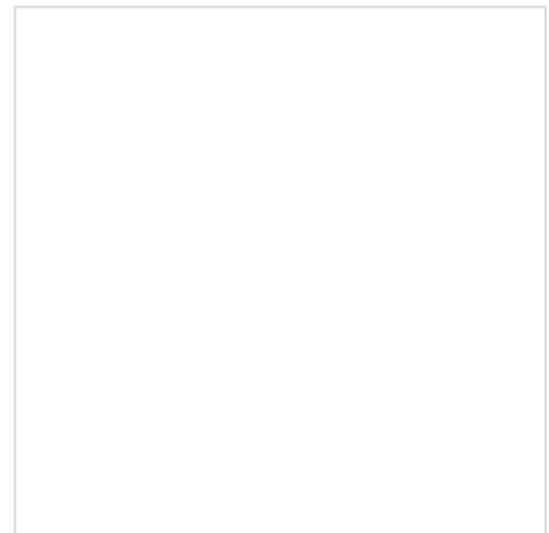

BOX IMAGE

78410-S04-902

SENSOR SPEED

Parts Number : 78410-S04-902

Manufacture 1 : PANASONIC / MATSUSHITA

Manufacturer Number 1 : EWT R5M

Manufacture 2 :

Manufacture Number 2 :

M.S.R.P 04/2010 : \$120.07

Description: SENSOR SPEED
MADE IN JAPAN #OEM

Application 1 : HONDA CIVIC 2D 96-00

Application 2 : HONDA CIVIC 3D 96-00

Application 3 : HONDA CIVIC 4D 96-97(US) 96-00(EXP)

Application 4 : HONDA CIVIC 4D 98-00

Application 5 :

Application 6 :

Application 7 :

Application 8 :

Application 9 :

Application 10 :

Application 11 :

Application 12 :

ZOOM+

ZOOM-



PARTS IMAGE

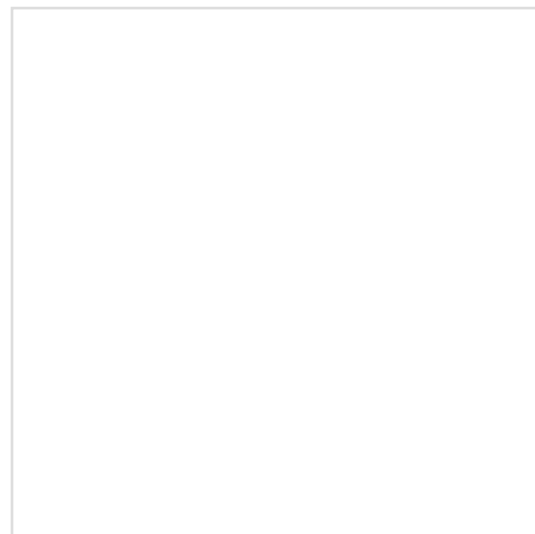

BOX IMAGE

78410-SV4-003

SENSOR SPEED

Parts Number : 78410-SV4-003

Manufacture 1 : PANASONIC (MATSUSHITA)

Manufacturer Number 1 : 78410-SV4 M EWTR4A 6151

Manufacture 2 :

Manufacture Number 2 :

M.S.R.P 04/2010 : \$132.60

Description: SENSOR SPEED
MADE IN JAPAN #OEM

Application 1 : HONDA ACCORD 1992-1997

Application 2 : HONDA CIVIC, DEL SOL, 1992-1997

Application 3 : HONDA PRELUDE 1993-2001

Application 4 : HONDA ODYSSEY 1995-2001

Application 5 :

Application 6 :

Application 7 :

Application 8 :

Application 9 :

Application 10 :

Application 11 :

Application 12 :

ZOOM+

ZOOM-



PARTS IMAGE

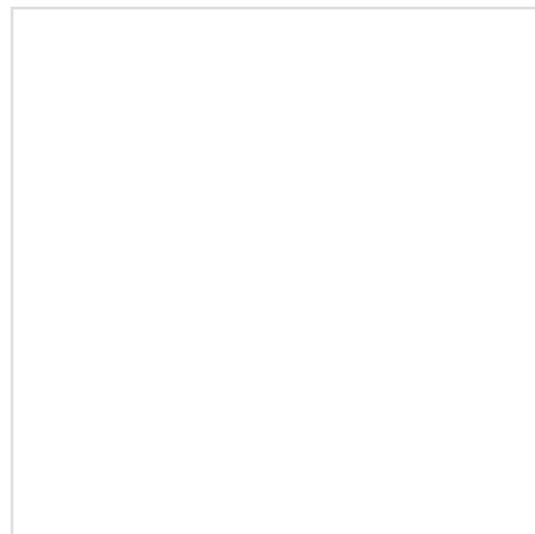

BOX IMAGE

79330-S5A-942

BLOWER MOTOR AND FAN

Parts Number : 79330-S5A-942

Manufacture 1 : DENSO

Manufacturer Number 1 : 077800-0970

Manufacture 2 :

Manufacture Number 2 :

M.S.R.P 04/2010 : \$60.53

Description: BLOWER MOTOR AND FAN
TRANSISTER
MADE IN JAPAN #OEM

Application 1 : HONDA CIVIC 2D 01-05

Application 2 : HONDA CIVIC 4D 01-05

Application 3 : HONDA CIVIC HYBRID 03-05

Application 4 : HONDA CR-V 02-06

Application 5 : HONDA ELEMENT 03-09

Application 6 :

Application 7 :

Application 8 :

Application 9 :

Application 10 :

Application 11 :

Application 12 :

ZOOM+

ZOOM-



PARTS IMAGE

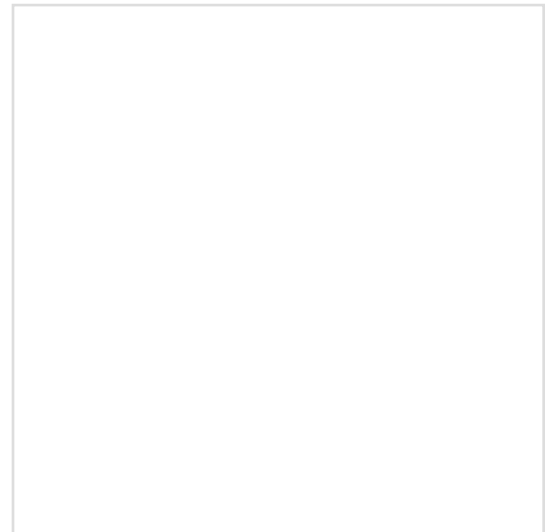

BOX IMAGE

8-94100-223-1

BELT TENSIONER

Parts Number : 8-94100-223-1

Manufacture 1 : NTN

Manufacturer Number 1 : JPU52-38

Manufacture 2 :

Manufacturer Number 2 :

M.S.R.P 04/2010 :

Description: BELT TENSIONER

Application 1 :

Application 2 :

Application 3 :

Application 4 :

Application 5 :

Application 6 :

Application 7 :

Application 8 :

Application 9 :

Application 10 :

Application 11 :

Application 12 :

ZOOM+

ZOOM-



PARTS IMAGE

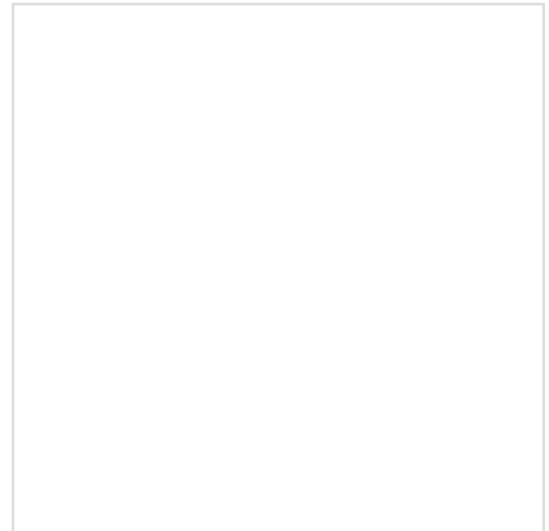

BOX IMAGE

8-94215-197-1

BELT TENSIONER

Parts Number : 8-94215-197-1

Manufacture 1 : NTN

Manufacturer Number 1 : JPU60-124+JF183

Manufacture 2 :

Manufacturer Number 2 :

M.S.R.P 04/2010 :

Description: BELT TENSIONER

Application 1 : ISUZU PICK UP 1987AND LATER

Application 2 : ISUZU PICK UP TROOPER II 86-87

Application 3 :

Application 4 :

Application 5 :

Application 6 :

Application 7 :

Application 8 :

Application 9 :

Application 10 :

Application 11 :

Application 12 :

ZOOM+

ZOOM-

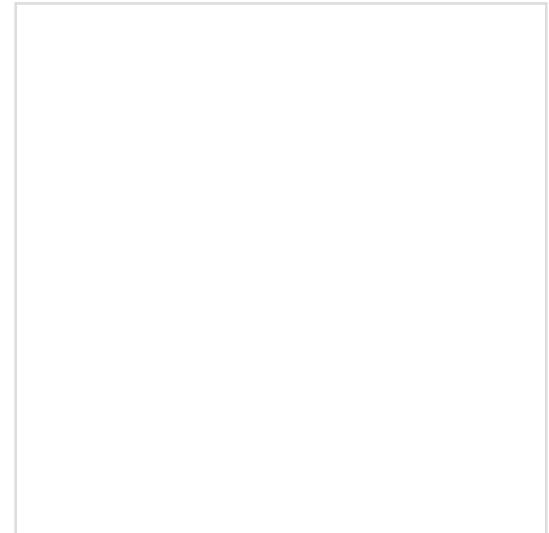

PARTS IMAGE

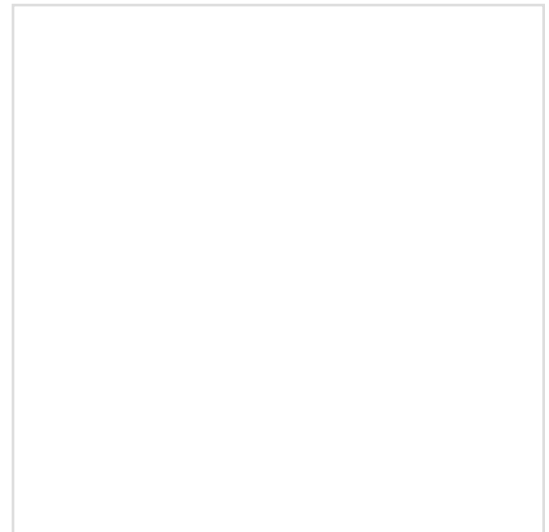

BOX IMAGE

8-94315-559-3

CLUTCH MASTER CYLINDER

Parts Number : 8-94315-559-3

Manufacture 1 : NISSIN

Manufacturer Number 1 :

Manufacture 2 :

Manufacture Number 2 :

M.S.R.P 04/2010 :

Description: CLUTCH MASTER CYLINDER MADE IN JAPAN

Application 1 : ISUZU TROOPER II 1987 AND LATER 4ZE1V6 MT

Application 2 :

Application 3 :

Application 4 :

Application 5 :

Application 6 :

Application 7 :

Application 8 :

Application 9 :

Application 10 :

Application 11 :

Application 12 :

ZOOM+ ZOOM-



PARTS IMAGE



BOX IMAGE

8-94364-817-1

BELT TENSIONER MADE IN

Parts Number : 8-94364-817-1

Manufacture 1 : NTN

Manufacturer Number 1 : HAT002-18

Manufacture 2 :

Manufacturer Number 2 :

M.S.R.P 04/2010 :

Description: BELT TENSIONER MADE IN JAPAN

Application 1 :

Application 2 :

Application 3 :

Application 4 :

Application 5 :

Application 6 :

Application 7 :

Application 8 :

Application 9 :

Application 10 :

Application 11 :

Application 12 :

ZOOM+ ZOOM-



PARTS IMAGE



BOX IMAGE

8-94370-778-0

CLUTCH SLAVE CYLINDER

ZOOM+ ZOOM-

Parts Number : 8-94370-778-0

Manufacture 1 : ADLER

Manufacturer Number 1 :

Manufacture 2 :

Manufacturer Number 2 :

M.S.R.P 04/2010 :

Description: CLUTCH SLAVE CYLINDER MADE IN JAPAN



PARTS IMAGE

Application 1 : ISUZU RODEO 90-92 MT

Application 2 :

Application 3 :

Application 4 :

Application 5 :

Application 6 :

Application 7 :

Application 8 :

Application 9 :

Application 10 :

Application 11 :

Application 12 :



BOX IMAGE

8-94372-202-1

BELT TENSIONER

Parts Number : 8-94372-202-1

Manufacture 1 : NSK

Manufacturer Number 1 : 52ST513-G-3DDWAXCF01

Manufacture 2 :

Manufacturer Number 2 :

M.S.R.P 04/2010 :

Description: BELT TENSIONER

Application 1 :

Application 2 :

Application 3 :

Application 4 :

Application 5 :

Application 6 :

Application 7 :

Application 8 :

Application 9 :

Application 10 :

Application 11 :

Application 12 :

ZOOM+

ZOOM-

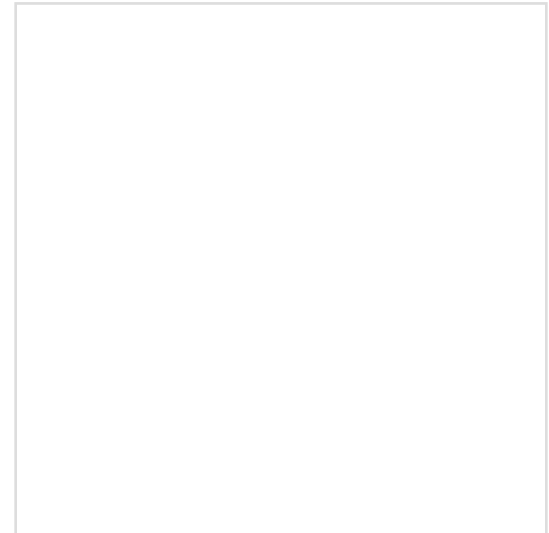

PARTS IMAGE

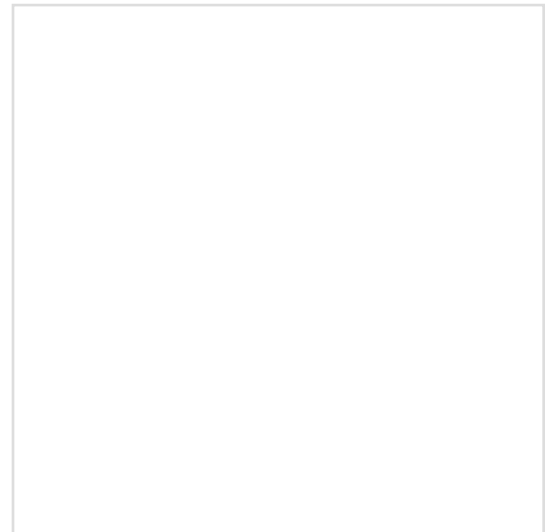

BOX IMAGE

8-94386-488-2

BELT TENSIONER MADE IN

Parts Number : 8-94386-488-2

Manufacture 1 : NSK

Manufacturer Number 1 : 70TB0803

Manufacture 2 :

Manufacture Number 2 :

M.S.R.P 04/2010 :

Description: BELT TENSIONER MADE IN JAPAN

Application 1 :

Application 2 :

Application 3 :

Application 4 :

Application 5 :

Application 6 :

Application 7 :

Application 8 :

Application 9 :

Application 10 :

Application 11 :

Application 12 :

ZOOM+ ZOOM-



PARTS IMAGE



BOX IMAGE

8-94389-194-1

Parts Number : 8-94389-194-1

Manufacture 1 : ADLER

Manufacturer Number 1 :

Manufacture 2 :

Manufacturer Number 2 :

M.S.R.P 04/2010 :

Description: CLUTCH SLAVE CYLINDER MADE IN JAPAN

CLUTCH SLAVE CYLINDER



PARTS IMAGE

Application 1 : ISUZU PICK UP 1989 AND LATER 4ZE1 MT

Application 2 : ISUZU RODEO 90-92 MT 4X2

Application 3 : ISUZU TROOPER 1989 AND LATER 4ZE1 MT

Application 4 :

Application 5 :

Application 6 :

Application 7 :

Application 8 :

Application 9 :

Application 10 :

Application 11 :

Application 12 :



BOX IMAGE

8-94389-196-0

CLUTCH SLAVE CYLINDER

Parts Number : 8-94389-196-0

Manufacture 1 : ADLER

Manufacturer Number 1 :

Manufacture 2 :

Manufacturer Number 2 :

M.S.R.P 04/2010 :

Description: CLUTCH SLAVE CYLINDER MADE IN JAPAN



PARTS IMAGE

- Application 1 :** ISUZU PICK UP 90-94 V6 MT
- Application 2 :** ISUZU RODEO 90-92 4X4 V6 MT
- Application 3 :** TROOPER II 1989 AND LATER V6 MT
- Application 4 :**
- Application 5 :**
- Application 6 :**
- Application 7 :**
- Application 8 :**
- Application 9 :**
- Application 10 :**
- Application 11 :**
- Application 12 :**



BOX IMAGE

8-94423-331-1

BELT TENSIONER

Parts Number : 8-94423-331-1

Manufacture 1 : NSK

Manufacturer Number 1 : 60TB0628A

Manufacture 2 :

Manufacturer Number 2 :

M.S.R.P 04/2010 :

Description: BELT TENSIONER

Application 1 :

Application 2 :

Application 3 :

Application 4 :

Application 5 :

Application 6 :

Application 7 :

Application 8 :

Application 9 :

Application 10 :

Application 11 :

Application 12 :

ZOOM+

ZOOM-

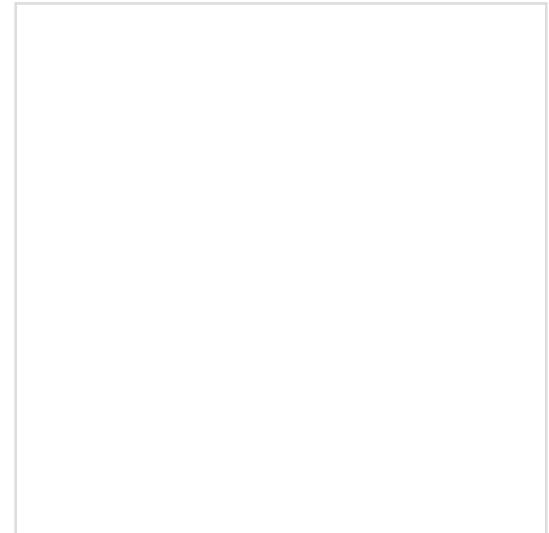

PARTS IMAGE

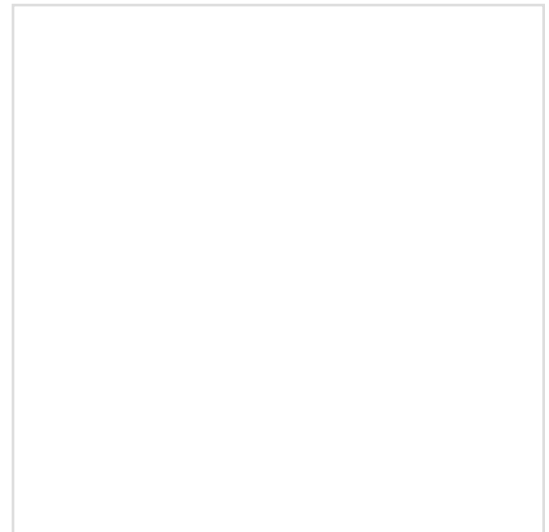

BOX IMAGE

8-94472-349-0

BELT TENSIONER

Parts Number : 8-94472-349-0

Manufacture 1 : NSK

Manufacturer Number 1 : 60TB0424B02

Manufacture 2 :

Manufacturer Number 2 :

M.S.R.P 04/2010 :

Description: BELT TENSIONER

Application 1 :

Application 2 :

Application 3 :

Application 4 :

Application 5 :

Application 6 :

Application 7 :

Application 8 :

Application 9 :

Application 10 :

Application 11 :

Application 12 :

ZOOM+

ZOOM-



PARTS IMAGE

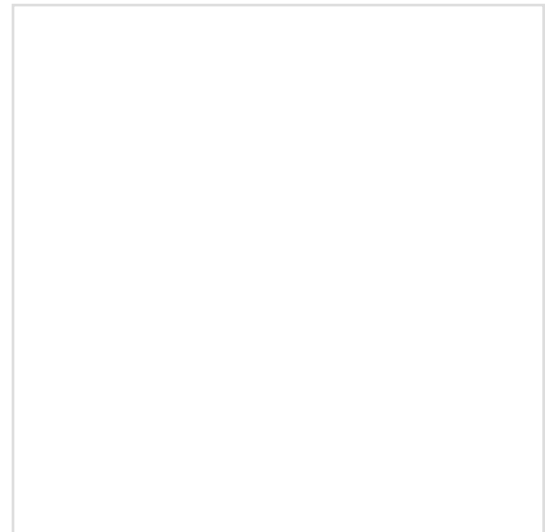

BOX IMAGE

8-96014183-0

SOLENOID CONV CLU MADE IN

Parts Number : 8-96014183-0

Manufacture 1 : GMC

Manufacturer Number 1 :

Manufacture 2 :

Manufacture Number 2 :

M.S.R.P 04/2010 :

Description: SOLENOID CONV CLU MADE IN
USA #GNTF

Application 1 :

Application 2 :

Application 3 :

Application 4 :

Application 5 :

Application 6 :

Application 7 :

Application 8 :

Application 9 :

Application 10 :

Application 11 :

Application 12 :

ZOOM+

ZOOM-



PARTS IMAGE

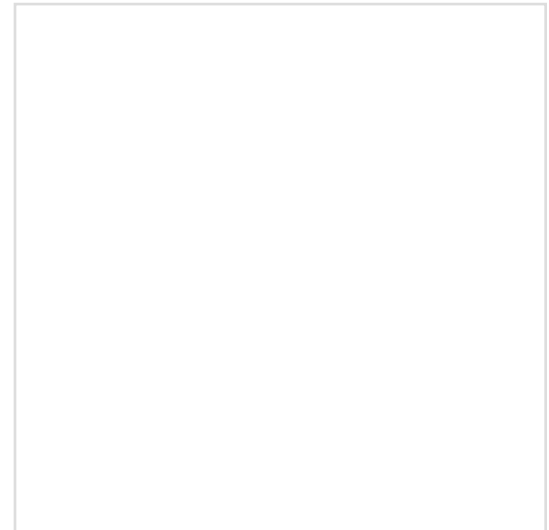

BOX IMAGE

8-97040-866-2

Parts Number : 8-97040-866-2

Manufacture 1 : ADLER

Manufacturer Number 1 :

Manufacture 2 :

Manufacture Number 2 :

M.S.R.P 04/2010 :

Description: CLUTCH SLAVE CYLINDER MADE IN JAPAN

Application 1 : ISUZU AMIGO 98 MT

Application 2 : ISUZU RODEO 97-9 8MT

Application 3 : ISUZU RODEO 1992 MT

Application 4 : ISUZU TROOPER 97-98 MT

Application 5 : ISUZU TROOPER 91-95 MT

Application 6 : ISUZU TROPPER 1995 MT

Application 7 :

Application 8 :

Application 9 :

Application 10 :

Application 11 :

Application 12 :

CLUTCH SLAVE CYLINDER

ZOOM+

ZOOM-



PARTS IMAGE



BOX IMAGE

8-97049-161-1

Parts Number : 8-97049-161-1

Manufacture 1 : ADLER

Manufacturer Number 1 :

Manufacture 2 :

Manufacture Number 2 :

M.S.R.P 04/2010 :

Description: CLUTCH SLAVE CYLINDER MADE IN JAPAN

CLUTCH SLAVE CYLINDER



PARTS IMAGE

Application 1 : 1992 RODEO (BORG WARNER) MT

Application 2 :

Application 3 :

Application 4 :

Application 5 :

Application 6 :

Application 7 :

Application 8 :

Application 9 :

Application 10 :

Application 11 :

Application 12 :



BOX IMAGE

8-97116-001-0

BELT TENSIONER

Parts Number : 8-97116-001-0

Manufacture 1 : NTN

Manufacturer Number 1 : JPU60-384+JF559

Manufacture 2 :

Manufacture Number 2 :

M.S.R.P 04/2010 :

Description: BELT TENSIONER

Application 1 :

Application 2 :

Application 3 :

Application 4 :

Application 5 :

Application 6 :

Application 7 :

Application 8 :

Application 9 :

Application 10 :

Application 11 :

Application 12 :

ZOOM+

ZOOM-



PARTS IMAGE

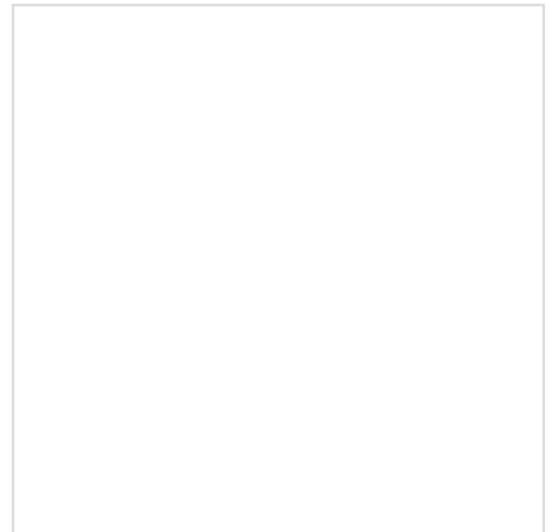

BOX IMAGE

8-97116-002-0

Parts Number : 8-97116-002-0

Manufacture 1 : NTN

Manufacturer Number 1 : JPU60-384+JF558

Manufacture 2 :

Manufacture Number 2 :

M.S.R.P 04/2010 :

Description: BELT TENSIONER MADE IN JAPAN

Application 1 : ISUZU RODEO 1994 AND LATER V6 6VD1 SOHC

Application 2 : ISUZU TROOPER 1994 AND LATER V6 6VD1

Application 3 :

Application 4 :

Application 5 :

Application 6 :

Application 7 :

Application 8 :

Application 9 :

Application 10 :

Application 11 :

Application 12 :

BELT TENSIONER MADE IN



PARTS IMAGE



BOX IMAGE

8-97116-003-1

BELT TENSIONER MADE IN

Parts Number : 8-97116-003-1

Manufacture 1 : NTN

Manufacturer Number 1 : HAT002-18

Manufacture 2 :

Manufacture Number 2 :

M.S.R.P 04/2010 :

Description: BELT TENSIONER MADE IN JAPAN

Application 1 : ISUZU RODEO 1994 AND LATER 6VD1 SOHC

Application 2 : ISUZU TROOPER 1995 AND LATER 6VD1 SOHC

Application 3 :

Application 4 :

Application 5 :

Application 6 :

Application 7 :

Application 8 :

Application 9 :

Application 10 :

Application 11 :

Application 12 :

ZOOM+

ZOOM-



PARTS IMAGE

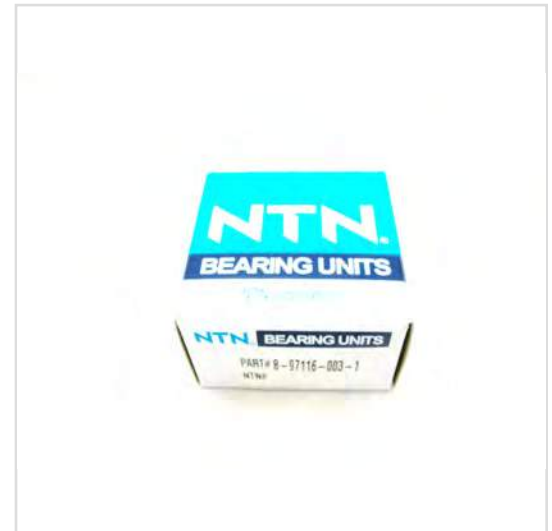

BOX IMAGE

8-97125-025-2

Parts Number : 8-97125-025-2

Manufacture 1 : ADLER

Manufacturer Number 1 : 8-97125-025-0

Manufacture 2 :

Manufacturer Number 2 :

M.S.R.P 04/2010 :

Description: CLUTCH MASTER CYLINDER MADE IN JAPAN

Application 1 :

Application 2 :

Application 3 :

Application 4 :

Application 5 :

Application 6 :

Application 7 :

Application 8 :

Application 9 :

Application 10 :

Application 11 :

Application 12 :

CLUTCH MASTER CYLINDER

ZOOM+

ZOOM-



PARTS IMAGE



BOX IMAGE

8-97136-256-0

BELT TENSIONER MADE IN

Parts Number : 8-97136-256-0

Manufacture 1 : NTN

Manufacturer Number 1 : JPU60-004-A-1 / NEP60-004A-4

Manufacture 2 :

Manufacture Number 2 :

M.S.R.P 04/2010 :

Description: BELT TENSIONER MADE IN JAPAN

Application 1 :

Application 2 :

Application 3 :

Application 4 :

Application 5 :

Application 6 :

Application 7 :

Application 8 :

Application 9 :

Application 10 :

Application 11 :

Application 12 :

ZOOM+ ZOOM-



PARTS IMAGE



BOX IMAGE

8-97138-345-0

CLUTCH SLAVE CYLINDER

ZOOM+ ZOOM-

Parts Number : 8-97138-345-0

Manufacture 1 : ADLER

Manufacturer Number 1 :

Manufacture 2 :

Manufacture Number 2 :

M.S.R.P 04/2010 :

Description: CLUTCH SLAVE CYLINDER MADE IN JAPAN



PARTS IMAGE

Application 1 : ISUZU AMIGO 98-99 MT

Application 2 : ISUZU RODEO X22SE Y22SE DOHC MT

Application 3 :

Application 4 :

Application 5 :

Application 6 :

Application 7 :

Application 8 :

Application 9 :

Application 10 :

Application 11 :

Application 12 :



BOX IMAGE

8-97146-877-0

BELT TENSIONER MADE IN

Parts Number : 8-97146-877-0

Manufacture 1 : NSK

Manufacturer Number 1 : 60TB0684

Manufacture 2 :

Manufacturer Number 2 :

M.S.R.P 04/2010 :

Description: BELT TENSIONER MADE IN JAPAN

Application 1 :

Application 2 :

Application 3 :

Application 4 :

Application 5 :

Application 6 :

Application 7 :

Application 8 :

Application 9 :

Application 10 :

Application 11 :

Application 12 :

ZOOM+ ZOOM-



PARTS IMAGE



BOX IMAGE

8-97162-745-0

CLUTCH CYLINDER SLAVE

ZOOM+ ZOOM-

Parts Number : 8-97162-745-0

Manufacture 1 : ADLER

Manufacturer Number 1 :

Manufacture 2 :

Manufacture Number 2 :

M.S.R.P 04/2010 :

Description: CLUTCH CYLINDER SLAVE MADE IN JAPAN



PARTS IMAGE

Application 1 : ISUZU AMIGO 98-02 X22SE Y22E DOHC MT

Application 2 : ISUZU AMIGO 2002 AND LATER MT

Application 3 : ISUZU RODEO 02-03 X22SE Y22SE DOHC MT

Application 4 : ISUZU RODEO 990-02 X22SE Y22SE DOHC MT

Application 5 :

Application 6 :

Application 7 :

Application 8 :

Application 9 :

Application 10 :

Application 11 :

Application 12 :



BOX IMAGE

8-97185-018-0

Parts Number : 8-97185-018-0

Manufacture 1 : NISSIN

Manufacturer Number 1 :

Manufacture 2 :

Manufacture Number 2 :

M.S.R.P 04/2010 :

Description: BRAKE MASTER CYLINDER MADE IN JAPAN

BRAKE MASTER CYLINDER



PARTS IMAGE

Application 1 :

Application 2 :

Application 3 :

Application 4 :

Application 5 :

Application 6 :

Application 7 :

Application 8 :

Application 9 :

Application 10 :

Application 11 :

Application 12 :



BOX IMAGE

8-97201-472-1

Parts Number : 8-97201-472-1

Manufacture 1 : ADLER

Manufacturer Number 1 :

Manufacture 2 :

Manufacture Number 2 :

M.S.R.P 04/2010 :

Description: CLUTCH CYLINDER SLAVE MADE IN JAPAN

Application 1 : ISUZU AMIGO 98-02 6VD1 DOHC MT

Application 2 : ISUZU RODEO 98-02 6VD1 DOHC MT

Application 3 :

Application 4 :

Application 5 :

Application 6 :

Application 7 :

Application 8 :

Application 9 :

Application 10 :

Application 11 :

Application 12 :

CLUTCH CYLINDER SLAVE

ZOOM+

ZOOM-



PARTS IMAGE



BOX IMAGE

8-97328-512-0

BELT TENSIONER MADE IN

Parts Number : 8-97328-512-0

Manufacture 1 : NTN

Manufacturer Number 1 : HAT125S-5

Manufacture 2 :

Manufacture Number 2 :

M.S.R.P 04/2010 :

Description: BELT TENSIONER MADE IN JAPAN

- Application 1 :** ISUZU AXIOM 2003 V6
- Application 2 :** ISUZU RODEO 03-04 V6
- Application 3 :** ISUZU RODEO 2004 AND LATER V6
- Application 4 :**
- Application 5 :**
- Application 6 :**
- Application 7 :**
- Application 8 :**
- Application 9 :**
- Application 10 :**
- Application 11 :**
- Application 12 :**

ZOOM+ ZOOM-



PARTS IMAGE



BOX IMAGE

881748

TENSIONER BRARING

Parts Number : 881748

Manufacture 1 : CAMELLIA

Manufacturer Number 1 : 935867-935868

Manufacture 2 :

Manufacture Number 2 :

M.S.R.P 04/2010 :

Description: TENSIONER BRARING

Application 1 :

Application 2 :

Application 3 :

Application 4 :

Application 5 :

Application 6 :

Application 7 :

Application 8 :

Application 9 :

Application 10 :

Application 11 :

Application 12 :

ZOOM+

ZOOM-

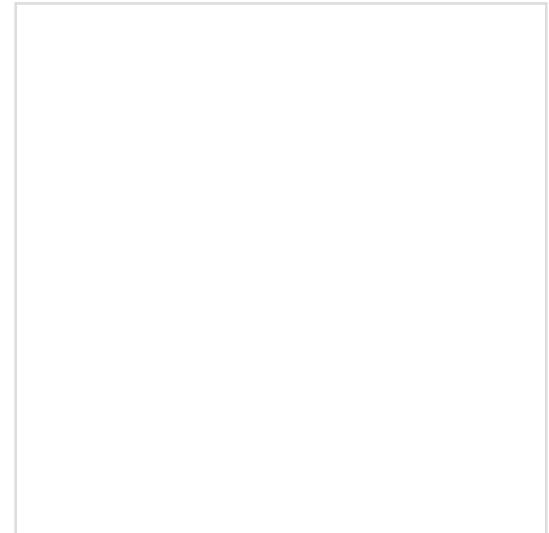

PARTS IMAGE

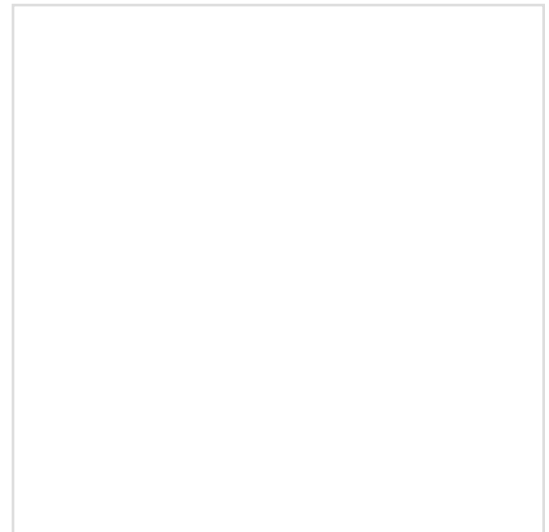

BOX IMAGE

887364

BRAKE MASTER CYLINDER

Parts Number : 887364

Manufacture 1 : NISSIN

Manufacturer Number 1 :

Manufacture 2 :

Manufacture Number 2 :

M.S.R.P 04/2010 :

Description: BRAKE MASTER CYLINDER
MADE IN JAPAN #OEMNTP

Application 1 :

Application 2 :

Application 3 :

Application 4 :

Application 5 :

Application 6 :

Application 7 :

Application 8 :

Application 9 :

Application 10 :

Application 11 :

Application 12 :

ZOOM+ ZOOM-



PARTS IMAGE



BOX IMAGE

90916-03075

THERMOSTAT MADE IN JAPAN

Parts Number : 90916-03075

Manufacture 1 : KUZEH

Manufacturer Number 1 :

Manufacture 2 :

Manufacturer Number 2 :

M.S.R.P 04/2010 :

Description: THERMOSTAT MADE IN JAPAN
#OENTP

Application 1 :

Application 2 :

Application 3 :

Application 4 :

Application 5 :

Application 6 :

Application 7 :

Application 8 :

Application 9 :

Application 10 :

Application 11 :

Application 12 :

ZOOM+

ZOOM-



PARTS IMAGE



BOX IMAGE

90916-03093

THERMOSTAT MADE IN JAPAN

Parts Number : 90916-03093

Manufacture 1 : KUZEH

Manufacturer Number 1 :

Manufacture 2 :

Manufacture Number 2 :

M.S.R.P 04/2010 :

Description: THERMOSTAT MADE IN JAPAN
#OENTP

Application 1 :

Application 2 :

Application 3 :

Application 4 :

Application 5 :

Application 6 :

Application 7 :

Application 8 :

Application 9 :

Application 10 :

Application 11 :

Application 12 :

ZOOM+

ZOOM-



PARTS IMAGE



BOX IMAGE

B630-12-700D

BELT TENSIONER

Parts Number : B630-12-700D

Manufacture 1 : KOYO

Manufacturer Number 1 : PU245228DRR1H

Manufacture 2 :

Manufacture Number 2 :

M.S.R.P 04/2010 :

Description: BELT TENSIONER

Application 1 :

Application 2 :

Application 3 :

Application 4 :

Application 5 :

Application 6 :

Application 7 :

Application 8 :

Application 9 :

Application 10 :

Application 11 :

Application 12 :

ZOOM+

ZOOM-

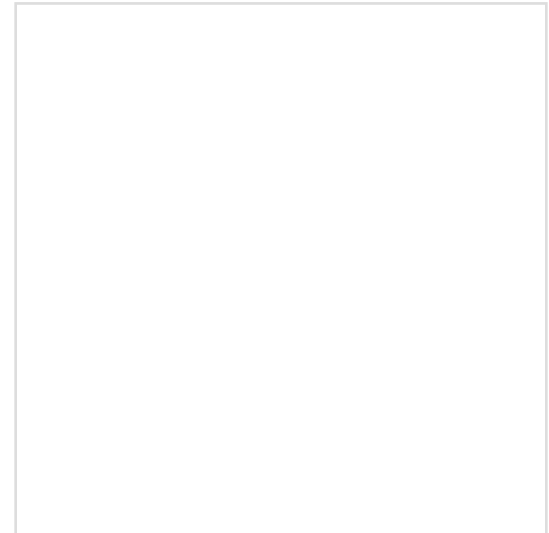

PARTS IMAGE

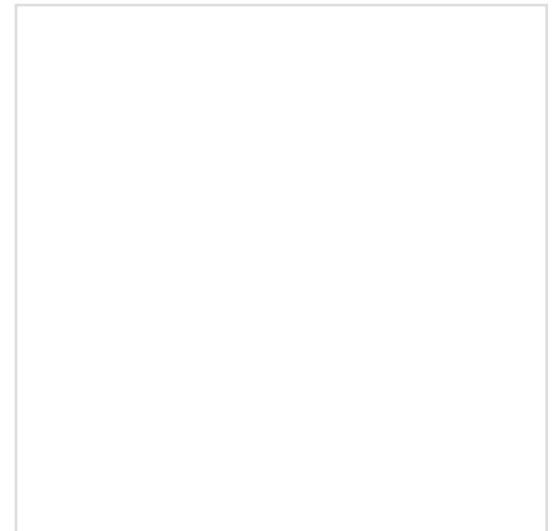

BOX IMAGE

B660-12-700D

BELT TENSIONER

Parts Number : B660-12-700D

Manufacture 1 : KOYO

Manufacturer Number 1 : PU285226ARR1HV

Manufacture 2 :

Manufacture Number 2 :

M.S.R.P 04/2010 :

Description: BELT TENSIONER

Application 1 :

Application 2 :

Application 3 :

Application 4 :

Application 5 :

Application 6 :

Application 7 :

Application 8 :

Application 9 :

Application 10 :

Application 11 :

Application 12 :

ZOOM+

ZOOM-

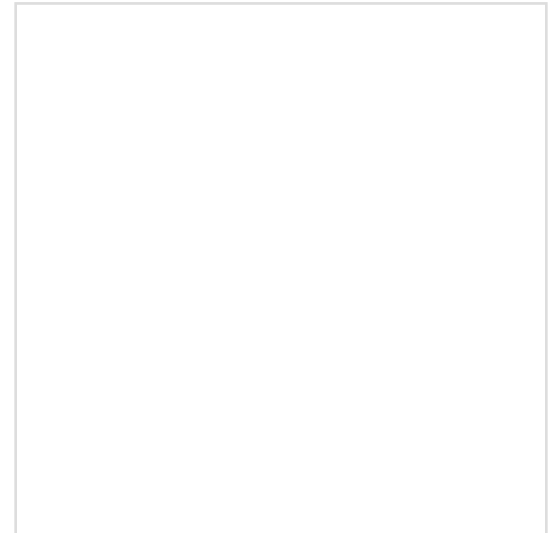

PARTS IMAGE

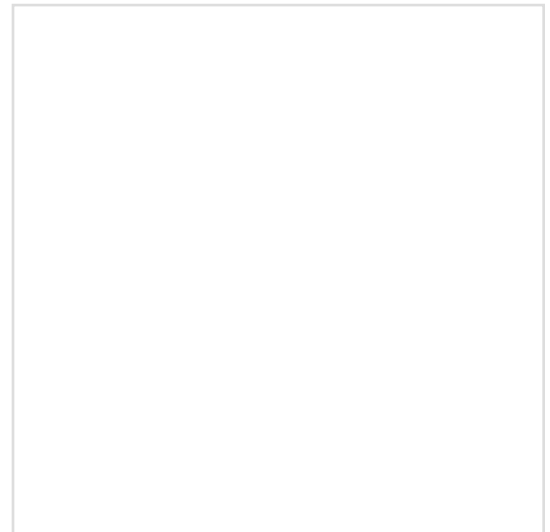

BOX IMAGE

B660-12-730C

BELT TENSIONER

Parts Number : B660-12-730C

Manufacture 1 : NTN

Manufacturer Number 1 : NEP52-015B-2

Manufacture 2 :

Manufacturer Number 2 :

M.S.R.P 04/2010 :

Description: BELT TENSIONER

Application 1 :

Application 2 :

Application 3 :

Application 4 :

Application 5 :

Application 6 :

Application 7 :

Application 8 :

Application 9 :

Application 10 :

Application 11 :

Application 12 :

ZOOM+

ZOOM-



PARTS IMAGE

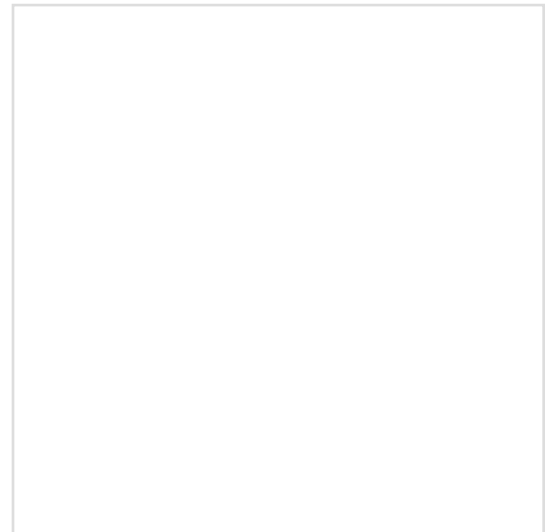

BOX IMAGE

BR-0307

CLUTCH BEARING MADE IN

Parts Number : BR-0307

Manufacture 1 :

Manufacturer Number 1 :

796

Manufacture 2 :

Manufacture Number 2 :

M.S.R.P 04/2010 :

Description:

CLUTCH BEARING MADE IN JAPAN

Application 1 :

Application 2 :

Application 3 :

Application 4 :

Application 5 :

Application 6 :

Application 7 :

Application 8 :

Application 9 :

Application 10 :

Application 11 :

Application 12 :

ZOOM+

ZOOM-

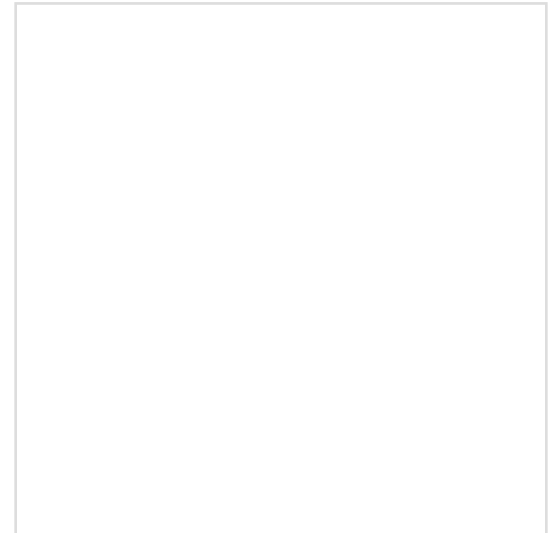

PARTS IMAGE

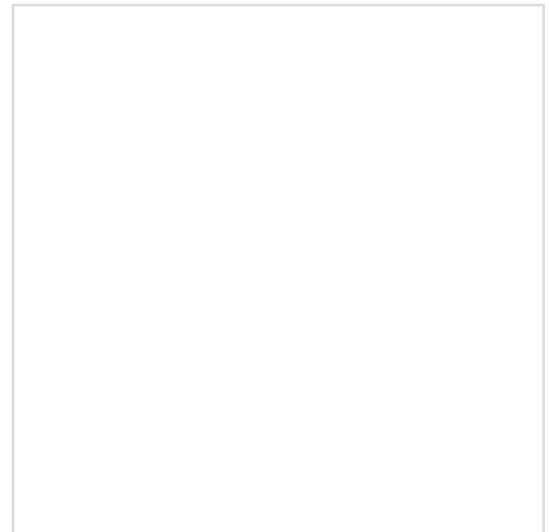

BOX IMAGE

BR-06

LOCKING COLLAR

Parts Number : BR-06

Manufacture 1 : NACHI

Manufacturer Number 1 : BR-06

Manufacture 2 :

Manufacturer Number 2 :

M.S.R.P 04/2010 :

Description: LOCKING COLLAR

Application 1 :

Application 2 :

Application 3 :

Application 4 :

Application 5 :

Application 6 :

Application 7 :

Application 8 :

Application 9 :

Application 10 :

Application 11 :

Application 12 :

ZOOM+

ZOOM-



PARTS IMAGE



BOX IMAGE

BV01-21-280A

SOLENOID TRANSMISSION

Parts Number : BV01-21-280A

Manufacture 1 :

Manufacturer Number 1 : 195

Manufacture 2 :

Manufacture Number 2 :

M.S.R.P 04/2010 :

Description: SOLENOID TRANSMISSION
MADE IN JAPAN #OEMNTP

Application 1 :

Application 2 :

Application 3 :

Application 4 :

Application 5 :

Application 6 :

Application 7 :

Application 8 :

Application 9 :

Application 10 :

Application 11 :

Application 12 :

ZOOM+

ZOOM-

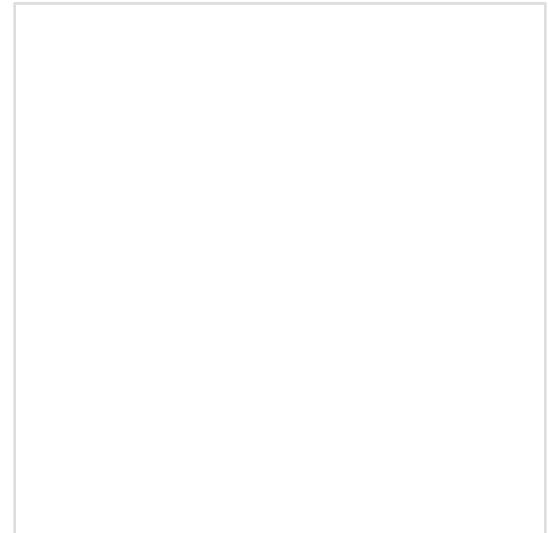

PARTS IMAGE

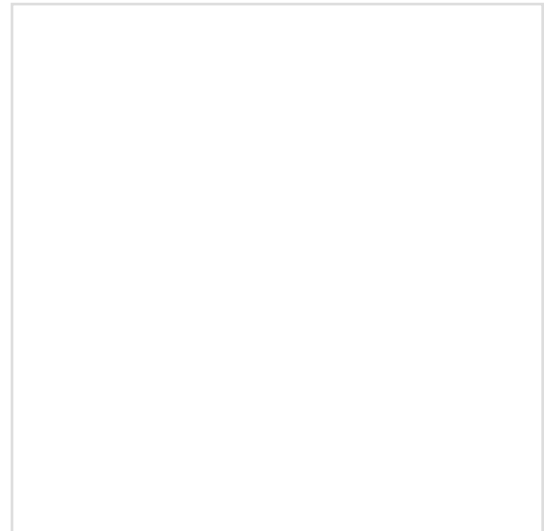

BOX IMAGE

BV11-21-1D2

SOLENOID TRANSMISSION

Parts Number : BV11-21-1D2

Manufacture 1 :

Manufacturer Number 1 : 196

Manufacture 2 :

Manufacturer Number 2 :

M.S.R.P 04/2010 :

Description: SOLENOID TRANSMISSION
MADE IN JAPAN #OEMNTP

Application 1 :

Application 2 :

Application 3 :

Application 4 :

Application 5 :

Application 6 :

Application 7 :

Application 8 :

Application 9 :

Application 10 :

Application 11 :

Application 12 :

ZOOM+

ZOOM-

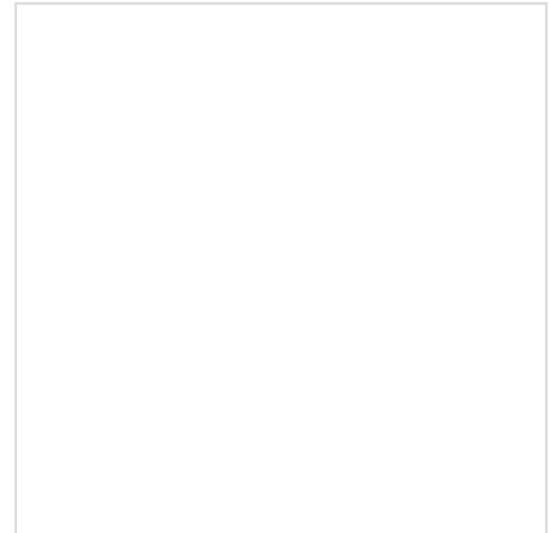

PARTS IMAGE

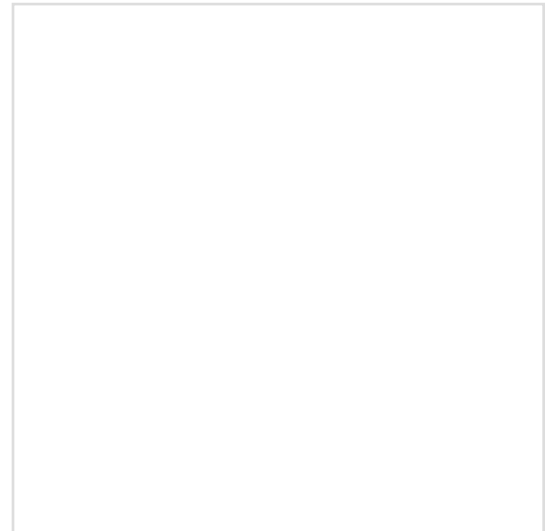

BOX IMAGE

BV65-21-1D1

SOLENOID TRANSMISSION

Parts Number : BV65-21-1D1

Manufacture 1 : NIDEC

Manufacturer Number 1 :

Manufacture 2 :

Manufacture Number 2 :

M.S.R.P 04/2010 :

Description: SOLENOID TRANSMISSION
MADE IN JAPAN #OEMNTP

Application 1 :

Application 2 :

Application 3 :

Application 4 :

Application 5 :

Application 6 :

Application 7 :

Application 8 :

Application 9 :

Application 10 :

Application 11 :

Application 12 :

ZOOM+ ZOOM-



PARTS IMAGE

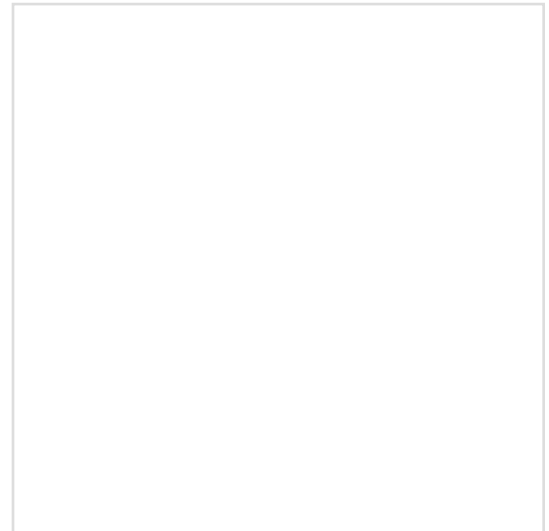

BOX IMAGE

C014

COLLAR

Parts Number : C014

Manufacture 1 :

Manufacturer Number 1 :

Manufacture 2 :

Manufacture Number 2 :

M.S.R.P 04/2010 :

Description: COLLAR

Application 1 :

Application 2 :

Application 3 :

Application 4 :

Application 5 :

Application 6 :

Application 7 :

Application 8 :

Application 9 :

Application 10 :

Application 11 :

Application 12 :

ZOOM+

ZOOM-

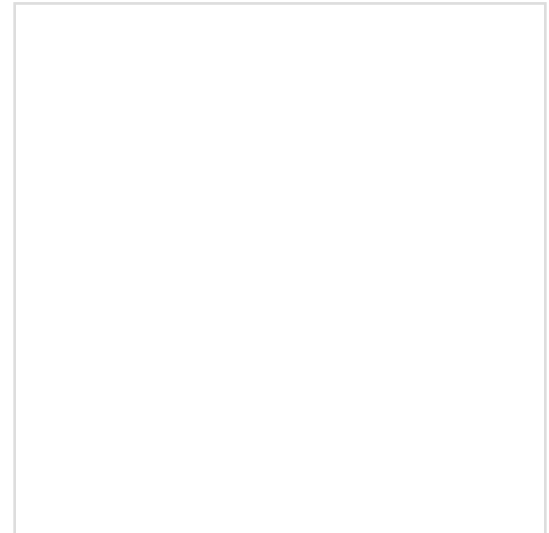

PARTS IMAGE

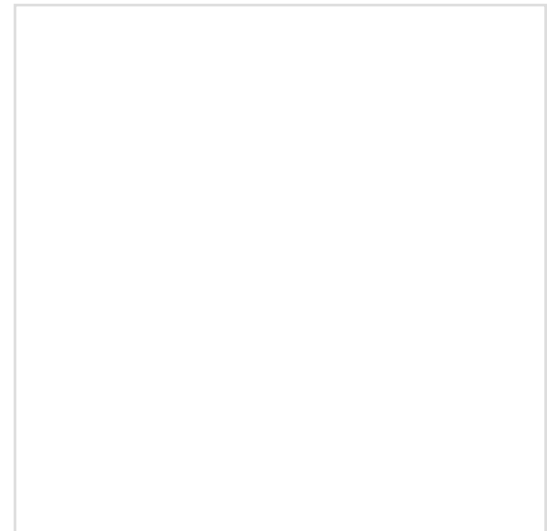

BOX IMAGE

C06

COLLAR

Parts Number : C06

Manufacture 1 :

Manufacturer Number 1 :

Manufacture 2 :

Manufacturer Number 2 :

M.S.R.P 04/2010 :

Description: COLLAR

Application 1 :

Application 2 :

Application 3 :

Application 4 :

Application 5 :

Application 6 :

Application 7 :

Application 8 :

Application 9 :

Application 10 :

Application 11 :

Application 12 :

ZOOM+

ZOOM-

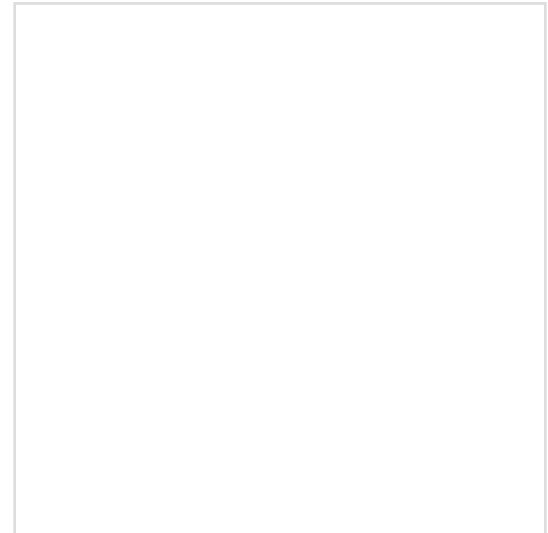

PARTS IMAGE

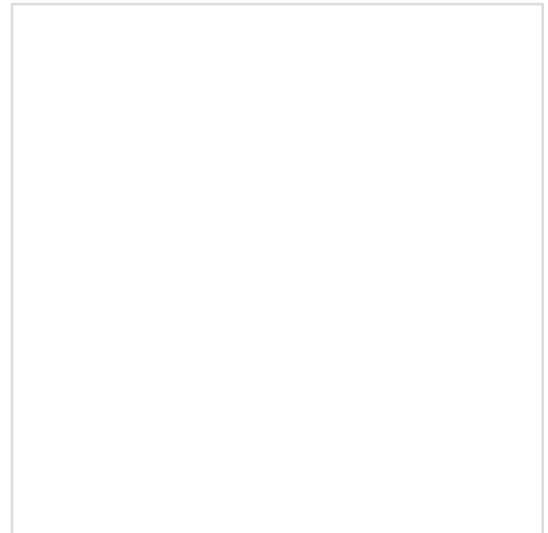

BOX IMAGE

CC-0154B

CLUTCH COVER SECO MADE IN

Parts Number : CC-0154B

Manufacture 1 : SEOJIN

Manufacturer Number 1 : SCNS-267B

Manufacture 2 :

Manufacturer Number 2 :

M.S.R.P 04/2010 :

Description: CLUTCH COVER SECO MADE IN KOREA

Application 1 : 30210-30R11, 30210-30R15, 30210-30R16

Application 2 : 30210-51F00, 30210-51F01, 30210-52F01

Application 3 : 30210-70F00, 30210-J0300, 30210-J0301

Application 4 : 30210-J1700, 30210-J1704, 30210-N3110

Application 5 : 30210-N4210, 30210-P9200, 30210-P9300

Application 6 : 30210-P9301, 30210-R5000, 30210-V2000

Application 7 : 30210-Y0600, 30210-Y0605, 30210-Y0607

Application 8 : 30210-Y0615, 30210-Y0617, 30210-Y0690

Application 9 : 30210-Y0700

Application 10 :

Application 11 :

Application 12 :

ZOOM+

ZOOM-



PARTS IMAGE



BOX IMAGE

CC-0155D

CLUTCH COVER SECO MADE IN

Parts Number : CC-0155D

Manufacture 1 : SEOJIN

Manufacturer Number 1 : SCNS-256

Manufacture 2 :

Manufacture Number 2 :

M.S.R.P 04/2010 :

Description: CLUTCH COVER SECO MADE IN KOREA

Application 1 : 30210-02P00, 30210-04U00, 30210-07S00

Application 2 : 30210-08U10, 30210-20J00, 30210-22J00

Application 3 : 30210-30P00, 30210-45P00, 30210-58S00

Application 4 : 30210-72S00, 30210-7S01, 30210-73L00

Application 5 : 30210-F6300, 30210-P9500, 30210-P9510

Application 6 : 30210-P9600, 30210-R2200, 30210-V5200

Application 7 :

Application 8 :

Application 9 :

Application 10 :

Application 11 :

Application 12 :

ZOOM+

ZOOM-



PARTS IMAGE



BOX IMAGE

CC-0254

CLUTCH COVER SECO MADE IN

Parts Number : CC-0254

Manufacture 1 : SEOJIN

Manufacturer Number 1 : SCTY-164

Manufacture 2 :

Manufacture Number 2 :

M.S.R.P 04/2010 :

Description: CLUTCH COVER SECO MADE IN KOREA

Application 1 : 31210-35200

Application 2 :

Application 3 :

Application 4 :

Application 5 :

Application 6 :

Application 7 :

Application 8 :

Application 9 :

Application 10 :

Application 11 :

Application 12 :

ZOOM+

ZOOM-



PARTS IMAGE



BOX IMAGE

CC-0262

CLUTCH COVER SECO MADE IN

Parts Number : CC-0262

Manufacture 1 : SEOJIN

Manufacturer Number 1 : SCTY-252

Manufacture 2 :

Manufacture Number 2 :

M.S.R.P 04/2010 :

Description: CLUTCH COVER SECO MADE IN KOREA

Application 1 : 31210-12060, 31210-12061, 31210-12062

Application 2 : 31210-12063, 31210-16010, 31210-16020

Application 3 :

Application 4 :

Application 5 :

Application 6 :

Application 7 :

Application 8 :

Application 9 :

Application 10 :

Application 11 :

Application 12 :

ZOOM+

ZOOM-



PARTS IMAGE

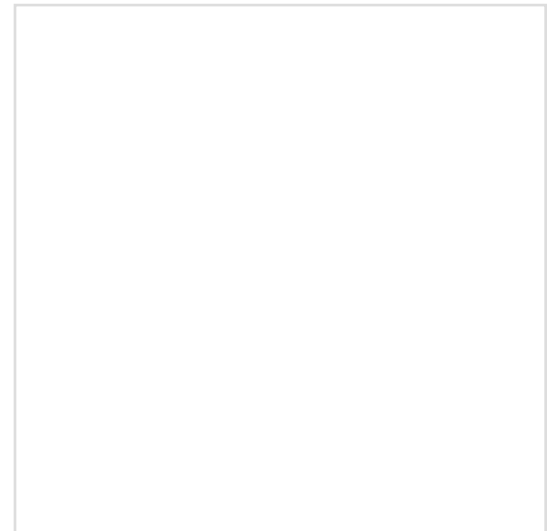

BOX IMAGE

CC-0263

CLUTCH COVER SECO MADE IN

Parts Number : CC-0263

Manufacture 1 : SEOJIN

Manufacturer Number 1 : SCTY-313

Manufacture 2 :

Manufacturer Number 2 :

M.S.R.P 04/2010 :

Description: CLUTCH COVER SECO MADE IN KOREA

Application 1 :

Application 2 :

Application 3 :

Application 4 :

Application 5 :

Application 6 :

Application 7 :

Application 8 :

Application 9 :

Application 10 :

Application 11 :

Application 12 :

ZOOM+

ZOOM-



PARTS IMAGE



BOX IMAGE

CC-0352

CLUTCH COVER SECO MADE IN

Parts Number : CC-0352

Manufacture 1 : SEOJIN

Manufacturer Number 1 : SCHO-090

Manufacture 2 :

Manufacturer Number 2 :

M.S.R.P 04/2010 :

Description: CLUTCH COVER SECO MADE IN KOREA

Application 1 : 22300-PA0-010, 22300-PA5-000,

Application 2 : 22300-PA6-010, 22300-PA6-020,

Application 3 : HONDA CIVIC 80-83

Application 4 :

Application 5 :

Application 6 :

Application 7 :

Application 8 :

Application 9 :

Application 10 :

Application 11 :

Application 12 :

ZOOM+

ZOOM-



PARTS IMAGE



BOX IMAGE

CC-0355

CLUTCH COVER SECO MADE IN

Parts Number : CC-0355

Manufacture 1 : SEOJIN

Manufacturer Number 1 : SCHO-334

Manufacture 2 :

Manufacturer Number 2 :

M.S.R.P 04/2010 :

Description: CLUTCH COVER SECO MADE IN KOREA

Application 1 : 22300-PM7-L00, 22300-P29-010, 22300-P30-030

Application 2 : 22300-PM5-L00, 22300-PEL-015

Application 3 : HONDA CIVIC 3D 4D 88-91

Application 4 : HONDA CRX 88-91

Application 5 : HONDA CIVIC 2D 93-95

Application 6 : HONDA CIVIC 3D 4D 92-95

Application 7 : HONDA DEL SOL 93-97

Application 8 :

Application 9 :

Application 10 :

Application 11 :

Application 12 :

ZOOM+

ZOOM-



PARTS IMAGE



BOX IMAGE

CC-0355D

CLUTCH COVER SECO MADE IN

Parts Number : CC-0355D

Manufacture 1 : SEOJIN

Manufacturer Number 1 : SCHO-334B

Manufacture 2 :

Manufacture Number 2 :

M.S.R.P 04/2010 :

Description: CLUTCH COVER SECO MADE IN KOREA

Application 1 :

Application 2 :

Application 3 :

Application 4 :

Application 5 :

Application 6 :

Application 7 :

Application 8 :

Application 9 :

Application 10 :

Application 11 :

Application 12 :

ZOOM+

ZOOM-



PARTS IMAGE



BOX IMAGE

CC-0356

CLUTCH COVER SECO MADE IN

Parts Number : CC-0356

Manufacture 1 : SEOJIN

Manufacturer Number 1 : SCHO-235

Manufacture 2 :

Manufacture Number 2 :

M.S.R.P 04/2010 :

Description: CLUTCH COVER SECO MADE IN KOREA

Application 1 :

Application 2 :

Application 3 :

Application 4 :

Application 5 :

Application 6 :

Application 7 :

Application 8 :

Application 9 :

Application 10 :

Application 11 :

Application 12 :

ZOOM+

ZOOM-



PARTS IMAGE

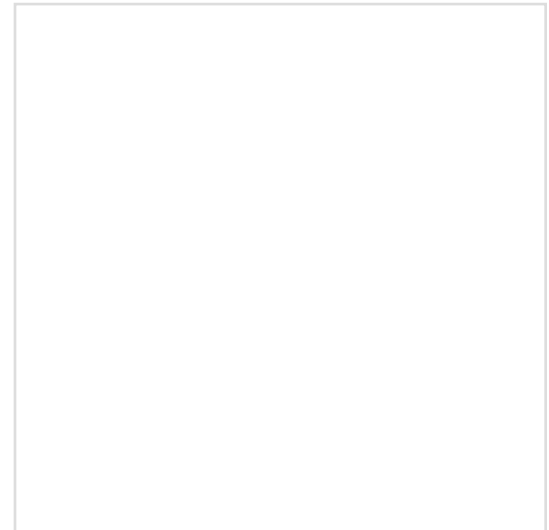

BOX IMAGE

CC-0455

CLUTCH COVER SECO MADE IN

Parts Number : CC-0455

Manufacture 1 : SEOJIN

Manufacturer Number 1 : SCHD-108B

Manufacture 2 :

Manufacturer Number 2 :

M.S.R.P 04/2010 :

Description: CLUTCH COVER SECO MADE IN KOREA

Application 1 :

Application 2 :

Application 3 :

Application 4 :

Application 5 :

Application 6 :

Application 7 :

Application 8 :

Application 9 :

Application 10 :

Application 11 :

Application 12 :

ZOOM+ ZOOM-



PARTS IMAGE



BOX IMAGE

CC-0459

CLUTCH COVER SECO MADE IN

Parts Number : CC-0459

Manufacture 1 : SEOJIN

Manufacturer Number 1 : SCMB-342

Manufacture 2 :

Manufacturer Number 2 :

M.S.R.P 04/2010 :

Description: CLUTCH COVER SECO MADE IN KOREA

Application 1 :

Application 2 :

Application 3 :

Application 4 :

Application 5 :

Application 6 :

Application 7 :

Application 8 :

Application 9 :

Application 10 :

Application 11 :

Application 12 :

ZOOM+

ZOOM-



PARTS IMAGE

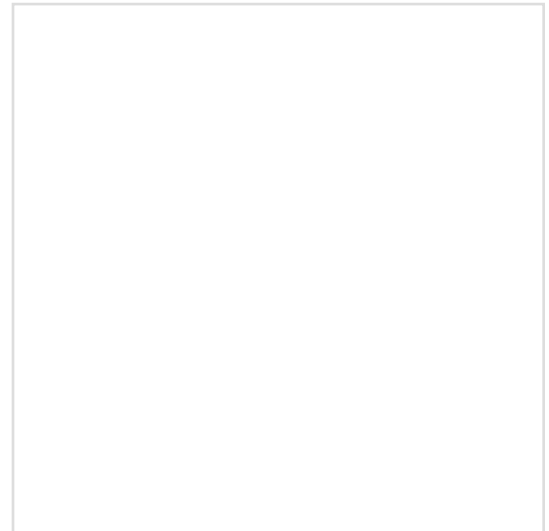

BOX IMAGE

CC-0551

CLUTCH COVER SECO MADE IN

Parts Number : CC-0551

Manufacture 1 : SEOJIN

Manufacturer Number 1 : SCMZ-60

Manufacture 2 :

Manufacturer Number 2 :

M.S.R.P 04/2010 :

Description: CLUTCH COVER SECO MADE IN KOREA

Application 1 :

Application 2 :

Application 3 :

Application 4 :

Application 5 :

Application 6 :

Application 7 :

Application 8 :

Application 9 :

Application 10 :

Application 11 :

Application 12 :

ZOOM+

ZOOM-



PARTS IMAGE



BOX IMAGE

CC-0574

CLUTCH COVER SECO MADE IN

Parts Number : CC-0574

Manufacture 1 : SEOJIN

Manufacturer Number 1 : SCKI-114

Manufacture 2 :

Manufacture Number 2 :

M.S.R.P 04/2010 :

Description: CLUTCH COVER SECO MADE IN KOREA

Application 1 :

Application 2 :

Application 3 :

Application 4 :

Application 5 :

Application 6 :

Application 7 :

Application 8 :

Application 9 :

Application 10 :

Application 11 :

Application 12 :

ZOOM+

ZOOM-



PARTS IMAGE

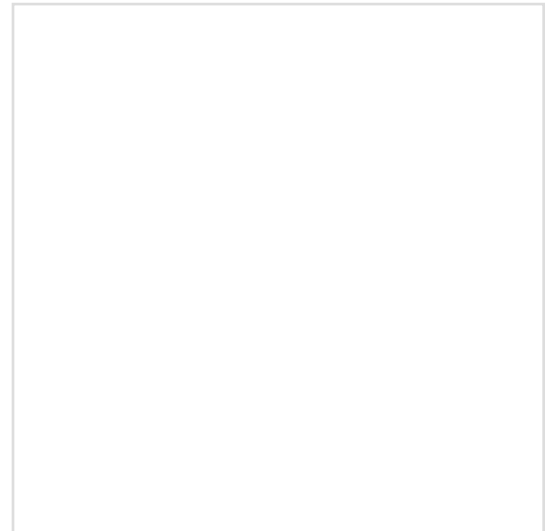

BOX IMAGE

CC-0578D

CLUTCH COVER SECO MADE IN

Parts Number : CC-0578D

Manufacture 1 : SEOJIN

Manufacturer Number 1 : SCMZ-199A/B

Manufacture 2 :

Manufacturer Number 2 :

M.S.R.P 04/2010 :

Description: CLUTCH COVER SECO MADE IN KOREA

Application 1 :

Application 2 :

Application 3 :

Application 4 :

Application 5 :

Application 6 :

Application 7 :

Application 8 :

Application 9 :

Application 10 :

Application 11 :

Application 12 :

ZOOM+

ZOOM-



PARTS IMAGE



BOX IMAGE

CC-1151

CLUTCH COVER SECO MADE IN

Parts Number : CC-1151

Manufacture 1 : SEOJIN

Manufacturer Number 1 : SCFO-150

Manufacture 2 :

Manufacturer Number 2 :

M.S.R.P 04/2010 :

Description: CLUTCH COVER SECO MADE IN KOREA

Application 1 :

Application 2 :

Application 3 :

Application 4 :

Application 5 :

Application 6 :

Application 7 :

Application 8 :

Application 9 :

Application 10 :

Application 11 :

Application 12 :

ZOOM+

ZOOM-



PARTS IMAGE

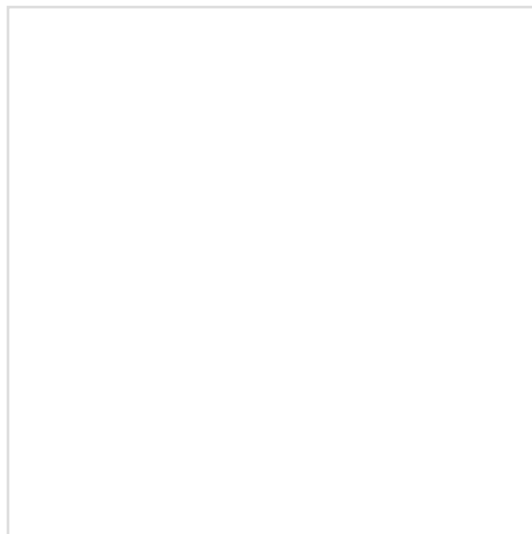

BOX IMAGE

CC-1159

CLUTCH COVER SECO MADE IN

Parts Number : CC-1159

Manufacture 1 : SEOJIN

Manufacturer Number 1 : SCFO-237

Manufacture 2 :

Manufacture Number 2 :

M.S.R.P 04/2010 :

Description: CLUTCH COVER SECO MADE IN KOREA

Application 1 :

Application 2 :

Application 3 :

Application 4 :

Application 5 :

Application 6 :

Application 7 :

Application 8 :

Application 9 :

Application 10 :

Application 11 :

Application 12 :

ZOOM+

ZOOM-



PARTS IMAGE



BOX IMAGE

CC-1161

CLUTCH COVER SECO MADE IN

Parts Number : CC-1161

Manufacture 1 : SEOJIN

Manufacturer Number 1 : SCMU-257

Manufacture 2 :

Manufacture Number 2 :

M.S.R.P 04/2010 :

Description: CLUTCH COVER SECO MADE IN KOREA

Application 1 :

Application 2 :

Application 3 :

Application 4 :

Application 5 :

Application 6 :

Application 7 :

Application 8 :

Application 9 :

Application 10 :

Application 11 :

Application 12 :

ZOOM+

ZOOM-



PARTS IMAGE

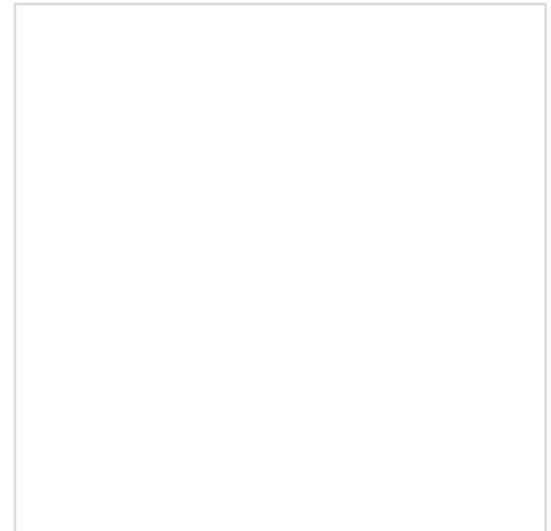

BOX IMAGE

CC-253

CLUTCH COVER SECO MADE IN

Parts Number : CC-253

Manufacture 1 : SEOJIN

Manufacturer Number 1 : SCTY-051

Manufacture 2 :

Manufacture Number 2 :

M.S.R.P 04/2010 :

Description: CLUTCH COVER SECO MADE IN KOREA

Application 1 :

Application 2 :

Application 3 :

Application 4 :

Application 5 :

Application 6 :

Application 7 :

Application 8 :

Application 9 :

Application 10 :

Application 11 :

Application 12 :

ZOOM+

ZOOM-



PARTS IMAGE

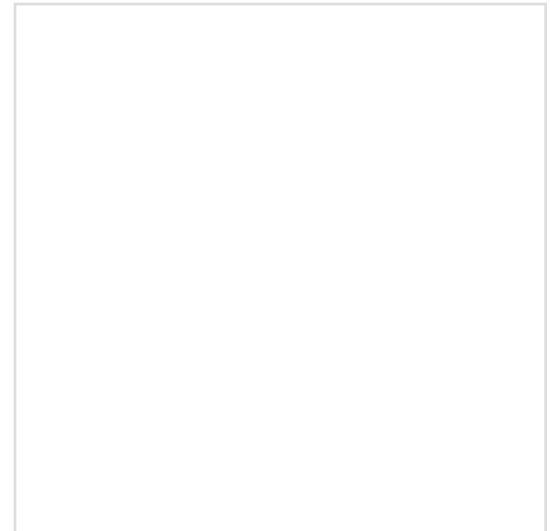

BOX IMAGE

CC-255D

CLUTCH COVER SECO MADE IN

Parts Number :	CC-255D
Manufacture 1 :	SEOJIN <input type="button" value="v"/>
Manufacturer Number 1 :	SCNS-214B
Manufacture 2 :	<input type="button" value="v"/>
Manufacturer Number 2 :	
M.S.R.P 04/2010 :	
Description:	CLUTCH COVER SECO MADE IN KOREA



PARTS IMAGE

- Application 1 :
- Application 2 :
- Application 3 :
- Application 4 :
- Application 5 :
- Application 6 :
- Application 7 :
- Application 8 :
- Application 9 :
- Application 10 :
- Application 11 :
- Application 12 :



BOX IMAGE

CC-355D

CLUTCH COVER SECO MADE IN

Parts Number : CC-355D

Manufacture 1 : SEOJIN

Manufacturer Number 1 : SCHIO-334B

Manufacture 2 :

Manufacture Number 2 :

M.S.R.P 04/2010 :

Description: CLUTCH COVER SECO MADE IN KOREA

Application 1 :

Application 2 :

Application 3 :

Application 4 :

Application 5 :

Application 6 :

Application 7 :

Application 8 :

Application 9 :

Application 10 :

Application 11 :

Application 12 :

ZOOM+

ZOOM-



PARTS IMAGE

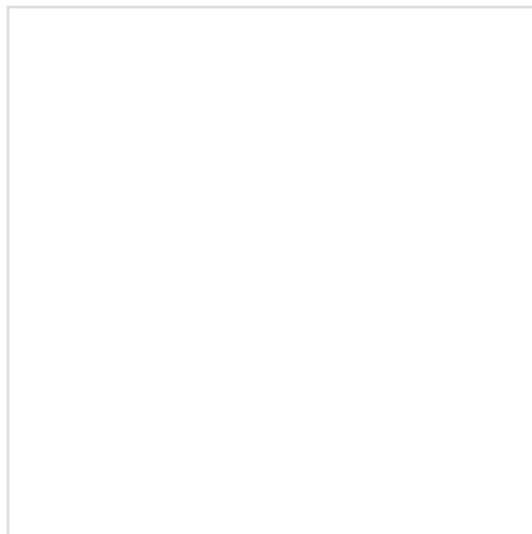

BOX IMAGE

CC-451D

CLUTCH COVER SECO MADE IN

Parts Number :	CC-451D
Manufacture 1 :	SEOJIN <input type="button" value="v"/>
Manufacturer Number 1 :	SCMB-165B
Manufacture 2 :	<input type="button" value="v"/>
Manufacturer Number 2 :	
M.S.R.P 04/2010 :	
Description:	CLUTCH COVER SECO MADE IN KOREA

ZOOM+ ZOOM-



PARTS IMAGE

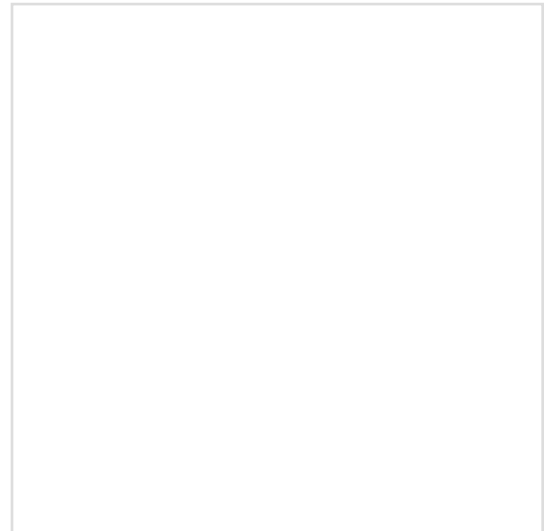

BOX IMAGE

- Application 1 :
- Application 2 :
- Application 3 :
- Application 4 :
- Application 5 :
- Application 6 :
- Application 7 :
- Application 8 :
- Application 9 :
- Application 10 :
- Application 11 :
- Application 12 :

CC-576

CLUTCH COVER SECO MADE IN

Parts Number : CC-576

Manufacture 1 : SEOJIN

Manufacturer Number 1 : SCKI-286 /RIO-1.5

Manufacture 2 :

Manufacture Number 2 :

M.S.R.P 04/2010 :

Description: CLUTCH COVER SECO MADE IN KOREA

Application 1 :

Application 2 :

Application 3 :

Application 4 :

Application 5 :

Application 6 :

Application 7 :

Application 8 :

Application 9 :

Application 10 :

Application 11 :

Application 12 :

ZOOM+

ZOOM-



PARTS IMAGE

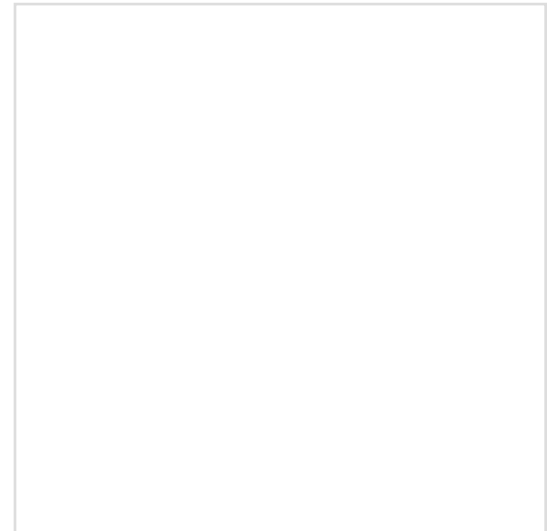

BOX IMAGE

CD-0224

CLUTCH DISC SECO MADE IN

Parts Number :	CD-0224
Manufacture 1 :	SEOJIN <input type="button" value="v"/>
Manufacturer Number 1 :	SDTY-136
Manufacture 2 :	<input type="button" value="v"/>
Manufacturer Number 2 :	
M.S.R.P 04/2010 :	
Description:	CLUTCH DISC SECO MADE IN KOREA

ZOOM+ ZOOM-



PARTS IMAGE

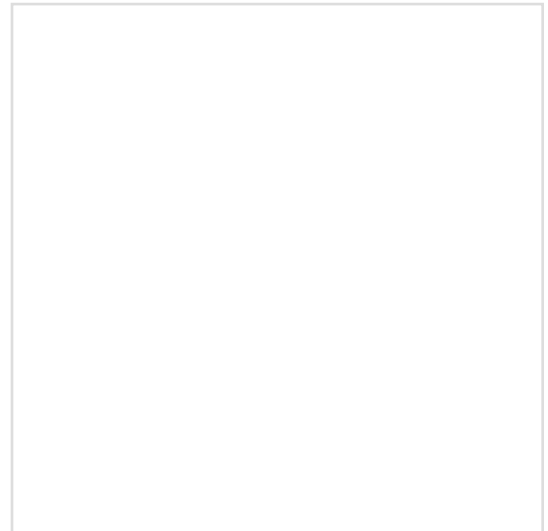

BOX IMAGE

- Application 1 :
- Application 2 :
- Application 3 :
- Application 4 :
- Application 5 :
- Application 6 :
- Application 7 :
- Application 8 :
- Application 9 :
- Application 10 :
- Application 11 :
- Application 12 :

CD-0224

CLUTCH DISC SECO MADE IN

Parts Number : CD-0224

Manufacture 1 : SEOJIN

Manufacturer Number 1 : SDTY-136

Manufacture 2 :

Manufacture Number 2 :

M.S.R.P 04/2010 :

Description: CLUTCH DISC SECO MADE IN KOREA

Application 1 :

Application 2 :

Application 3 :

Application 4 :

Application 5 :

Application 6 :

Application 7 :

Application 8 :

Application 9 :

Application 10 :

Application 11 :

Application 12 :

ZOOM+

ZOOM-



PARTS IMAGE



BOX IMAGE

CD-0328

CLUTCH DISC SECO MADE IN

Parts Number : CD-0328

Manufacture 1 : SEOJIN

Manufacturer Number 1 : SDHO-219

Manufacture 2 :

Manufacture Number 2 :

M.S.R.P 04/2010 :

Description: CLUTCH DISC SECO MADE IN KOREA

Application 1 :

Application 2 :

Application 3 :

Application 4 :

Application 5 :

Application 6 :

Application 7 :

Application 8 :

Application 9 :

Application 10 :

Application 11 :

Application 12 :

ZOOM+

ZOOM-



PARTS IMAGE

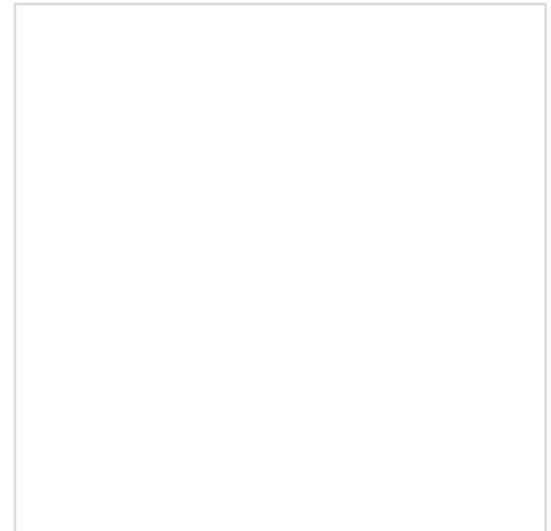

BOX IMAGE

CD-0422

CLUTCH DISC SECO MADE IN

Parts Number : CD-0422

Manufacture 1 : SEOJIN

Manufacturer Number 1 : SDHD-078

Manufacture 2 :

Manufacturer Number 2 :

M.S.R.P 04/2010 :

Description: CLUTCH DISC SECO MADE IN KOREA

Application 1 :

Application 2 :

Application 3 :

Application 4 :

Application 5 :

Application 6 :

Application 7 :

Application 8 :

Application 9 :

Application 10 :

Application 11 :

Application 12 :

ZOOM+

ZOOM-



PARTS IMAGE

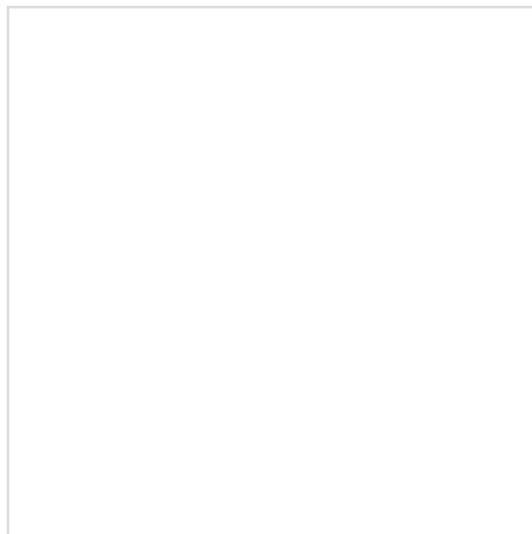

BOX IMAGE

CD-0523

CLUTCH DISC SECO MADE IN

Parts Number : CD-0523

Manufacture 1 : SEOJIN

Manufacturer Number 1 : SDMZ-051

Manufacture 2 :

Manufacturer Number 2 :

M.S.R.P 04/2010 :

Description: CLUTCH DISC SECO MADE IN KOREA

Application 1 :

Application 2 :

Application 3 :

Application 4 :

Application 5 :

Application 6 :

Application 7 :

Application 8 :

Application 9 :

Application 10 :

Application 11 :

Application 12 :

ZOOM+

ZOOM-



PARTS IMAGE



BOX IMAGE

CD-0526

CLUTCH DISC SECO MADE IN

Parts Number : CD-0526

Manufacture 1 : SEOJIN

Manufacturer Number 1 : SDKI-247

Manufacture 2 :

Manufacture Number 2 :

M.S.R.P 04/2010 :

Description: CLUTCH DISC SECO MADE IN KOREA

Application 1 :

Application 2 :

Application 3 :

Application 4 :

Application 5 :

Application 6 :

Application 7 :

Application 8 :

Application 9 :

Application 10 :

Application 11 :

Application 12 :

ZOOM+

ZOOM-



PARTS IMAGE

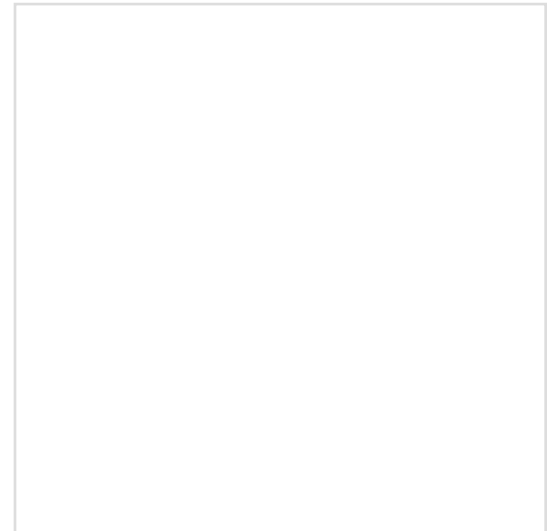

BOX IMAGE

CD-0622

CLUTCH DISC SECO MADE IN

Parts Number : CD-0622

Manufacture 1 : SEOJIN

Manufacturer Number 1 : SDIS-179

Manufacture 2 :

Manufacturer Number 2 :

M.S.R.P 04/2010 :

Description: CLUTCH DISC SECO MADE IN KOREA

Application 1 :

Application 2 :

Application 3 :

Application 4 :

Application 5 :

Application 6 :

Application 7 :

Application 8 :

Application 9 :

Application 10 :

Application 11 :

Application 12 :

ZOOM+

ZOOM-



PARTS IMAGE



BOX IMAGE

CD-1134

Parts Number : CD-1134

Manufacture 1 : SEOJIN

Manufacturer Number 1 : SDFO-024

Manufacture 2 :

Manufacturer Number 2 :

M.S.R.P 04/2010 :

Description: CLUTCH DISC SECO MADE IN KOREA

Application 1 :

Application 2 :

Application 3 :

Application 4 :

Application 5 :

Application 6 :

Application 7 :

Application 8 :

Application 9 :

Application 10 :

Application 11 :

Application 12 :

CLUTCH DISC SECO MADE IN

ZOOM+

ZOOM-



PARTS IMAGE



BOX IMAGE

F1-1814

Parts Number : F1-1814

Manufacture 1 : PARUAT / HITACHI

Manufacturer Number 1 :

Manufacture 2 :

Manufacturer Number 2 :

M.S.R.P 04/2010 :

Description: CLUTCH DISC MADE IN JAPAN
(VALEO)

Application 1 : 30100-KA070

Application 2 : 30100-KA131

Application 3 : 30100-KA290

Application 4 : SUBARU 86-94

Application 5 :

Application 6 :

Application 7 :

Application 8 :

Application 9 :

Application 10 :

Application 11 :

Application 12 :

CLUTCH DISC MADE IN JAPAN

ZOOM+

ZOOM-



PARTS IMAGE



BOX IMAGE

F1-2011

Parts Number :	F1-2011
Manufacture 1 :	PARUAT / HITACHI <input type="button" value="v"/>
Manufacturer Number 1 :	30100-AA400
Manufacture 2 :	<input type="button" value="v"/>
Manufacturer Number 2 :	30100-AA342/ AA84
M.S.R.P 04/2010 :	
Description:	CLUTCH DISC MADE IN JAPAN VALEO

CLUTCH DISC MADE IN JAPAN

ZOOM+ ZOOM-



PARTS IMAGE

- Application 1 :** AF2 AB2 EA71
- Application 2 :** AF5 AB5 4WD EA81
- Application 3 :** SUBARU 80-84
- Application 4 :**
- Application 5 :**
- Application 6 :**
- Application 7 :**
- Application 8 :**
- Application 9 :**
- Application 10 :**
- Application 11 :**
- Application 12 :**



BOX IMAGE

F1-2250

CLUTCH DISC MADE IN JAPAN

Parts Number : F1-2250

Manufacture 1 : PARUAT / HITACHI

Manufacturer Number 1 : 274

Manufacture 2 :

Manufacture Number 2 :

M.S.R.P 04/2010 :

Description: CLUTCH DISC MADE IN JAPAN

Application 1 :

Application 2 :

Application 3 :

Application 4 :

Application 5 :

Application 6 :

Application 7 :

Application 8 :

Application 9 :

Application 10 :

Application 11 :

Application 12 :

ZOOM+

ZOOM-



PARTS IMAGE

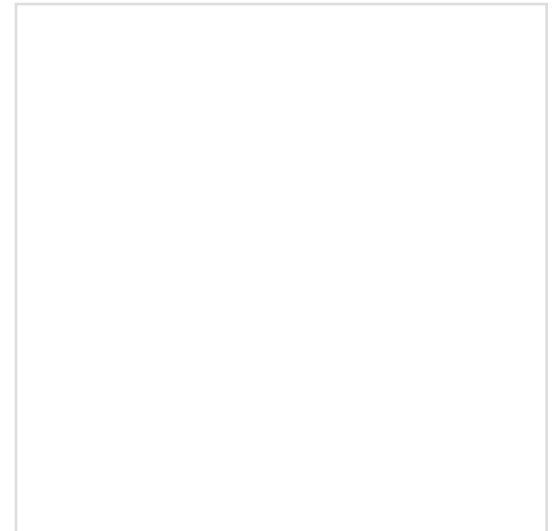

BOX IMAGE

F2-1820

Parts Number : F2-1820

Manufacture 1 : PARUAT / HITACHI

Manufacturer Number 1 : 30210-KA010

Manufacture 2 :

Manufacturer Number 2 :

M.S.R.P 04/2010 :

Description: CLUTCH COVER MADE IN JAPAN
(DAIKIN/EXCEDY)

Application 1 :

Application 2 :

Application 3 : SUBARU GL10 85-94

Application 4 :

Application 5 :

Application 6 :

Application 7 :

Application 8 :

Application 9 :

Application 10 :

Application 11 :

Application 12 :

CLUTCH COVER MADE IN

ZOOM+

ZOOM-



PARTS IMAGE



BOX IMAGE

F2-2257

Parts Number : F2-2257

Manufacture 1 : PARUAT / HITACHI

Manufacturer Number 1 : 30210-AA150

Manufacture 2 :

Manufacturer Number 2 :

M.S.R.P 04/2010 :

Description: CLUTCH COVER MADE IN JAPAN
VALEO (PHC)

Application 1 : SUBARU LEGACY EJ20 89-92

Application 2 :

Application 3 :

Application 4 :

Application 5 :

Application 6 :

Application 7 :

Application 8 :

Application 9 :

Application 10 :

Application 11 :

Application 12 :

CLUTCH COVER MADE IN

ZOOM+

ZOOM-



PARTS IMAGE



BOX IMAGE

F3-018

Parts Number : F3-018

Manufacture 1 : PARUAT / HITACHI

Manufacturer Number 1 : 2111-AA000

Manufacture 2 :

Manufacturer Number 2 :

M.S.R.P 04/2010 :

Description: WATER PUMP PARAUT MADE IN JAPAN

Application 1 : SUBARU IMPREZA GC4 GF3.4 1992

Application 2 : SUBARU LEGACY BG7 BGB 93-96

Application 3 :

Application 4 :

Application 5 :

Application 6 :

Application 7 :

Application 8 :

Application 9 :

Application 10 :

Application 11 :

Application 12 :

WATER PUMP PARAUT MADE

ZOOM+

ZOOM-



PARTS IMAGE



BOX IMAGE

F3-019

Parts Number : F3-019

Manufacture 1 :

Manufacturer Number 1 : 21111-AA020/022

Manufacture 2 :

Manufacturer Number 2 :

M.S.R.P 04/2010 :

Description: WATER PUMP PARAUT MADE IN JAPAN

Application 1 : SUBARU LEGACY BH5 MTM TURBO EJ20 98-03

Application 2 : SUBARU IMPREZA GGB EJ20 00-02

Application 3 :

Application 4 :

Application 5 :

Application 6 :

Application 7 :

Application 8 :

Application 9 :

Application 10 :

Application 11 :

Application 12 :

WATER PUMP PARAUT MADE

ZOOM+

ZOOM-



PARTS IMAGE



BOX IMAGE

F805-12-700A

Parts Number : F805-12-700A

Manufacture 1 : NSK

Manufacturer Number 1 : 52TB0537B01

Manufacture 2 :

Manufacturer Number 2 :

M.S.R.P 04/2010 :

Description: BELT TENSIONER MADE IN JAPAN

- Application 1 :
- Application 2 :
- Application 3 :
- Application 4 :
- Application 5 :
- Application 6 :
- Application 7 :
- Application 8 :
- Application 9 :
- Application 10 :
- Application 11 :
- Application 12 :

BELT TENSIONER MADE IN

ZOOM+ ZOOM-



PARTS IMAGE



BOX IMAGE

FB02-21-1G1C

SOLENOID TRANSMISSION

Parts Number : FB02-21-1G1C

Manufacture 1 : MITSUBISHI

Manufacturer Number 1 : G6T44071

Manufacture 2 :

Manufacture Number 2 :

M.S.R.P 04/2010 :

Description: SOLENOID TRANSMISSION
MADE IN JAPAN #GNTP

Application 1 :

Application 2 :

Application 3 :

Application 4 :

Application 5 :

Application 6 :

Application 7 :

Application 8 :

Application 9 :

Application 10 :

Application 11 :

Application 12 :

ZOOM+ ZOOM-



PARTS IMAGE

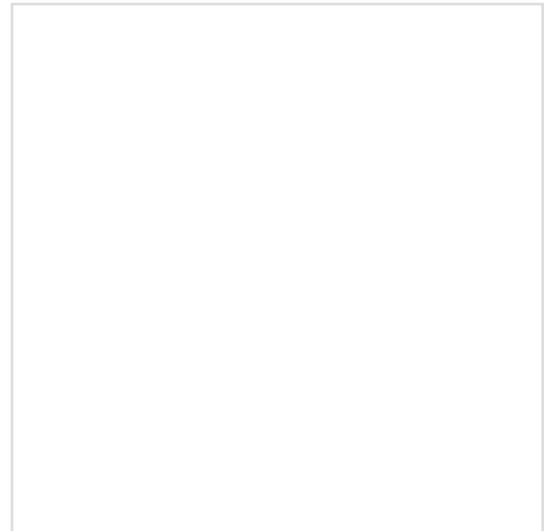

BOX IMAGE

FB02-21-285A

SOLENOID TRANSMISSION

Parts Number : FB02-21-285A

Manufacture 1 :

Manufacturer Number 1 : 198

Manufacture 2 :

Manufacture Number 2 :

M.S.R.P 04/2010 :

Description: SOLENOID TRANSMISSION
MADE IN JAPAN #OEMNTP

Application 1 :

Application 2 :

Application 3 :

Application 4 :

Application 5 :

Application 6 :

Application 7 :

Application 8 :

Application 9 :

Application 10 :

Application 11 :

Application 12 :

ZOOM+

ZOOM-



PARTS IMAGE

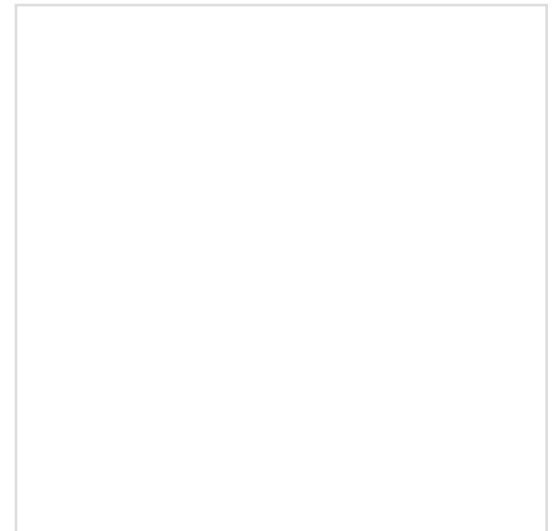

BOX IMAGE

FE1H-12-700A

Parts Number : FE1H-12-700A

Manufacture 1 : NSK

Manufacturer Number 1 : 52TB2803B01

Manufacture 2 :

Manufacturer Number 2 :

M.S.R.P 04/2010 :

Description: BELT TENSIONER MADE IN JAPAN

Application 1 :

Application 2 :

Application 3 :

Application 4 :

Application 5 :

Application 6 :

Application 7 :

Application 8 :

Application 9 :

Application 10 :

Application 11 :

Application 12 :

BELT TENSIONER MADE IN

ZOOM+

ZOOM-



PARTS IMAGE



BOX IMAGE

FE1H-12-730A

BELT TENSIONER

Parts Number : FE1H-12-730A

Manufacture 1 : KOYO

Manufacturer Number 1 : DG3060312RR1HC2

Manufacture 2 :

Manufacture Number 2 :

M.S.R.P 04/2010 :

Description: BELT TENSIONER

Application 1 :

Application 2 :

Application 3 :

Application 4 :

Application 5 :

Application 6 :

Application 7 :

Application 8 :

Application 9 :

Application 10 :

Application 11 :

Application 12 :

ZOOM+

ZOOM-



PARTS IMAGE

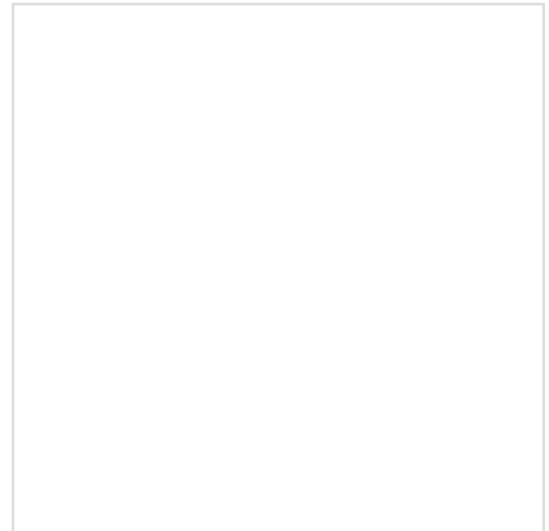

BOX IMAGE

FP05-12-700B

BELT TENSIONER MADE IN

Parts Number : FP05-12-700B

Manufacture 1 : NSK

Manufacturer Number 1 : 62ATB0733A04B01B

Manufacture 2 :

Manufacturer Number 2 :

M.S.R.P 04/2010 :

Description: BELT TENSIONER MADE IN JAPAN

Application 1 :

Application 2 :

Application 3 :

Application 4 :

Application 5 :

Application 6 :

Application 7 :

Application 8 :

Application 9 :

Application 10 :

Application 11 :

Application 12 :

ZOOM+

ZOOM-



PARTS IMAGE



BOX IMAGE

FS01-12-700A

Parts Number : FS01-12-700A

Manufacture 1 : NSK

Manufacturer Number 1 : 62ATB0732804B01

Manufacture 2 :

Manufacturer Number 2 :

M.S.R.P 04/2010 :

Description: BELT TENSIONER MADE IN JAPAN

Application 1 :

Application 2 :

Application 3 :

Application 4 :

Application 5 :

Application 6 :

Application 7 :

Application 8 :

Application 9 :

Application 10 :

Application 11 :

Application 12 :

BELT TENSIONER MADE IN

ZOOM+

ZOOM-



PARTS IMAGE



BOX IMAGE

FS01-12-730A

Parts Number : FS01-12-730A

Manufacture 1 : NTN

Manufacturer Number 1 : NEP52-016B-2

Manufacture 2 :

Manufacturer Number 2 :

M.S.R.P 04/2010 :

Description: BELT TENSIONER MADE IN JAPAN

BELT TENSIONER MADE IN

ZOOM+ ZOOM-



PARTS IMAGE

Application 1 :

Application 2 :

Application 3 :

Application 4 :

Application 5 :

Application 6 :

Application 7 :

Application 8 :

Application 9 :

Application 10 :

Application 11 :

Application 12 :



BOX IMAGE

FU50-21-280B

SOLENOID TRANSMISSION

Parts Number : FU50-21-280B

Manufacture 1 :

Manufacturer Number 1 : 200

Manufacture 2 :

Manufacturer Number 2 :

M.S.R.P 04/2010 :

Description: SOLENOID TRANSMISSION
MADE IN JAPAN #OEMNTP

Application 1 :

Application 2 :

Application 3 :

Application 4 :

Application 5 :

Application 6 :

Application 7 :

Application 8 :

Application 9 :

Application 10 :

Application 11 :

Application 12 :

ZOOM+

ZOOM-



PARTS IMAGE

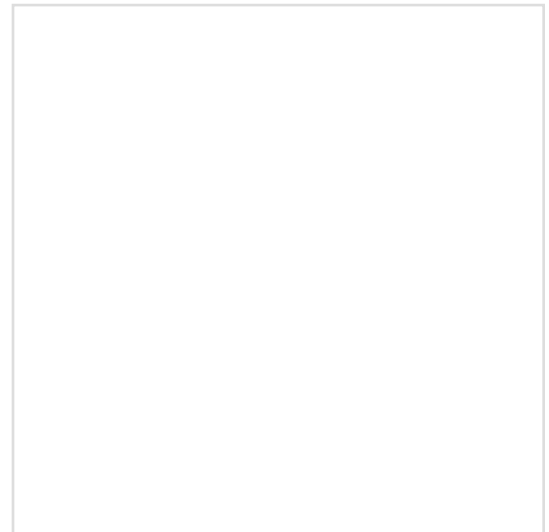

BOX IMAGE

FU61-21-286

SOLENOID TRANSMISSION

Parts Number : FU61-21-286

Manufacture 1 :

Manufacturer Number 1 : 201

Manufacture 2 :

Manufacturer Number 2 :

M.S.R.P 04/2010 :

Description: SOLENOID TRANSMISSION
MADE IN JAPAN #OEMNTP

Application 1 :

Application 2 :

Application 3 :

Application 4 :

Application 5 :

Application 6 :

Application 7 :

Application 8 :

Application 9 :

Application 10 :

Application 11 :

Application 12 :

ZOOM+

ZOOM-

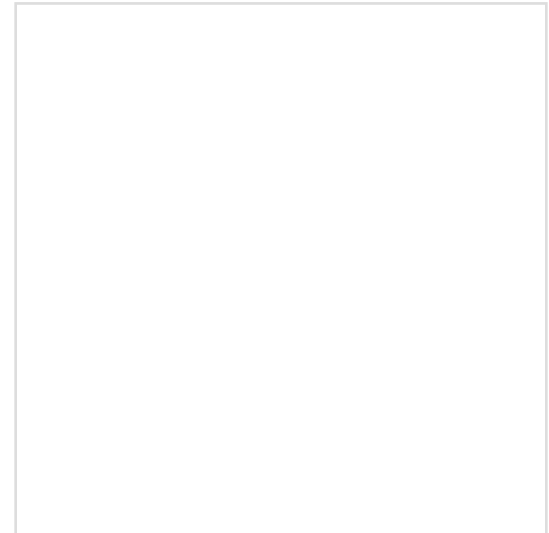

PARTS IMAGE

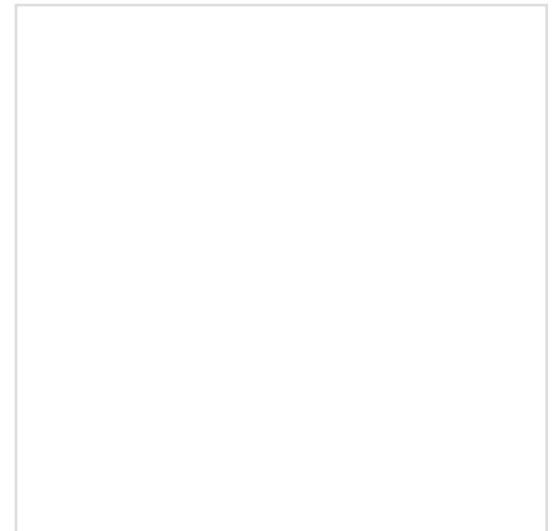

BOX IMAGE

FU9A-21-1F1D

SOLENOID TRANSMISSION

Parts Number : FU9A-21-1F1D

Manufacture 1 : MITSUBISHI

Manufacturer Number 1 : G6T40271

Manufacture 2 :

Manufacture Number 2 :

M.S.R.P 04/2010 :

Description: SOLENOID TRANSMISSION
MADE IN JAPAN #GNTP

Application 1 :

Application 2 :

Application 3 :

Application 4 :

Application 5 :

Application 6 :

Application 7 :

Application 8 :

Application 9 :

Application 10 :

Application 11 :

Application 12 :

ZOOM+

ZOOM-



PARTS IMAGE

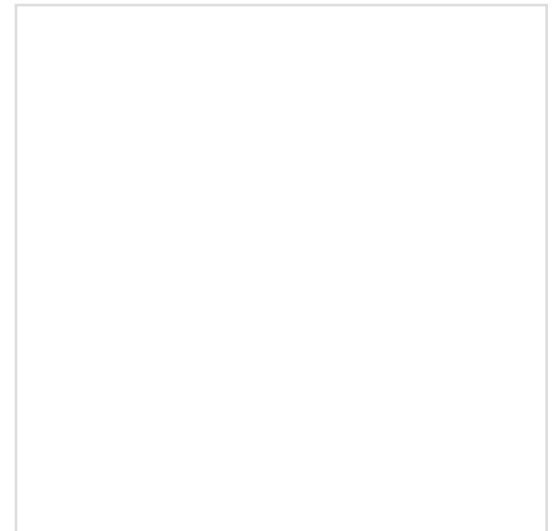

BOX IMAGE

FU9A-21-1F2C

SOLENOID TRANSMISSION

Parts Number : FU9A-21-1F2C

Manufacture 1 : MITSUBISHI

Manufacturer Number 1 : G6T40272

Manufacture 2 :

Manufacture Number 2 :

M.S.R.P 04/2010 :

Description: SOLENOID TRANSMISSION
MADE IN JAPAN #GNTP

Application 1 :

Application 2 :

Application 3 :

Application 4 :

Application 5 :

Application 6 :

Application 7 :

Application 8 :

Application 9 :

Application 10 :

Application 11 :

Application 12 :

ZOOM+ ZOOM-



PARTS IMAGE

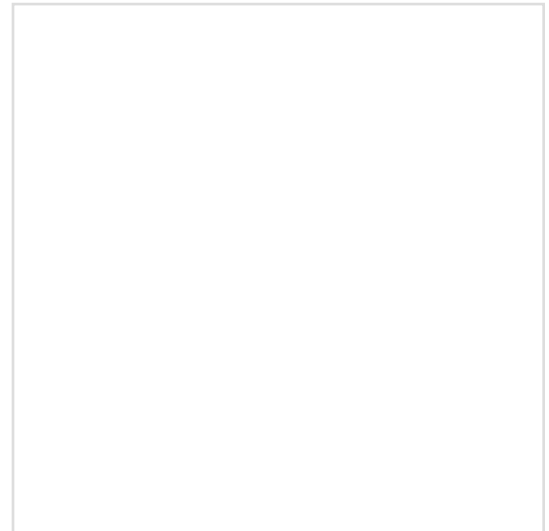

BOX IMAGE

FU9A-21-1F3D

SOLENOID TRANSMISSION

Parts Number : FU9A-21-1F3D

Manufacture 1 : MITSUBISHI

Manufacturer Number 1 : G6T40371

Manufacture 2 :

Manufacture Number 2 :

M.S.R.P 04/2010 :

Description: SOLENOID TRANSMISSION
MADE IN JAPAN #GNTP

Application 1 :

Application 2 :

Application 3 :

Application 4 :

Application 5 :

Application 6 :

Application 7 :

Application 8 :

Application 9 :

Application 10 :

Application 11 :

Application 12 :

ZOOM+

ZOOM-



PARTS IMAGE

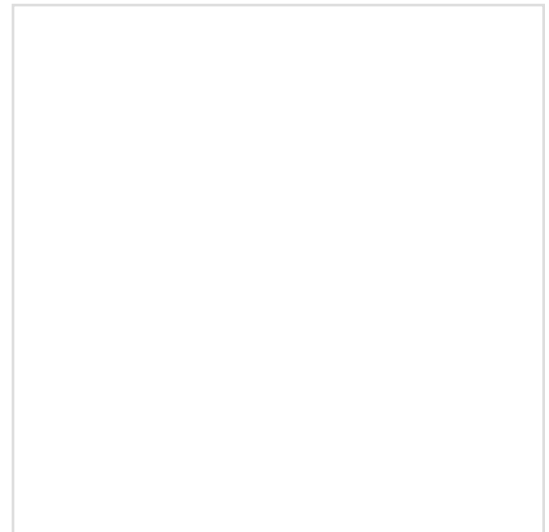

BOX IMAGE

FU9A-21-1F4D

SOLENOID TRANSMISSION

Parts Number : FU9A-21-1F4D

Manufacture 1 : MITSUBISHI

Manufacturer Number 1 : G6T40471

Manufacture 2 :

Manufacture Number 2 :

M.S.R.P 04/2010 :

Description: SOLENOID TRANSMISSION
MADE IN JAPAN #GNTP

Application 1 :

Application 2 :

Application 3 :

Application 4 :

Application 5 :

Application 6 :

Application 7 :

Application 8 :

Application 9 :

Application 10 :

Application 11 :

Application 12 :

ZOOM+ ZOOM-



PARTS IMAGE

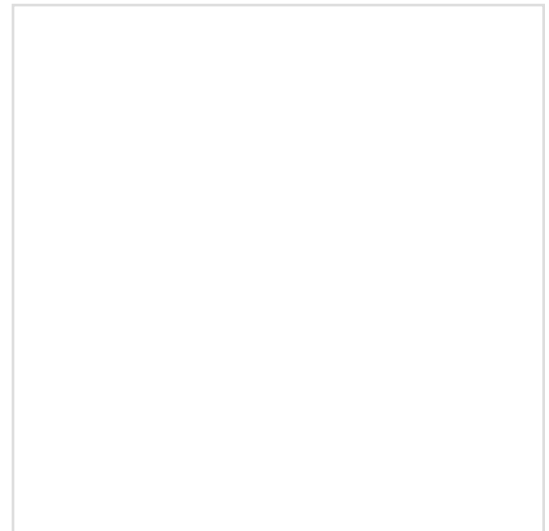

BOX IMAGE

FU9A-21-1F5D

SOLENOID TRANSMISSION

Parts Number : FU9A-21-1F5D

Manufacture 1 : MITSUBISHI

Manufacturer Number 1 : G6T40273

Manufacture 2 :

Manufacture Number 2 :

M.S.R.P 04/2010 :

Description: SOLENOID TRANSMISSION
MADE IN JAPAN #GNTP

Application 1 :

Application 2 :

Application 3 :

Application 4 :

Application 5 :

Application 6 :

Application 7 :

Application 8 :

Application 9 :

Application 10 :

Application 11 :

Application 12 :

ZOOM+ ZOOM-



PARTS IMAGE

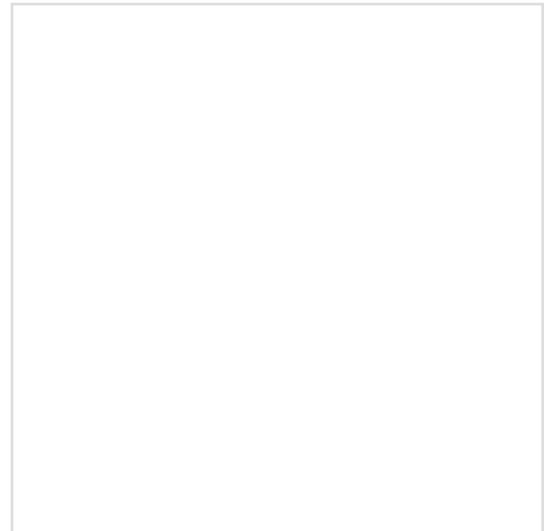

BOX IMAGE

FU9A-21-1G1C

SOLENOID TRANSMISSION

Parts Number : FU9A-21-1G1C

Manufacture 1 : NOK

Manufacturer Number 1 : 0402

Manufacture 2 :

Manufacturer Number 2 :

M.S.R.P 04/2010 :

Description: SOLENOID TRANSMISSION
MADE IN JAPAN #OEMNTP

Application 1 :

Application 2 :

Application 3 :

Application 4 :

Application 5 :

Application 6 :

Application 7 :

Application 8 :

Application 9 :

Application 10 :

Application 11 :

Application 12 :

ZOOM+ ZOOM-



PARTS IMAGE



BOX IMAGE

FX01-21-1D1A

SOLENOID TRANSMISSION

Parts Number : FX01-21-1D1A

Manufacture 1 :

Manufacturer Number 1 : 208

Manufacture 2 :

Manufacturer Number 2 :

M.S.R.P 04/2010 :

Description: SOLENOID TRANSMISSION
MADE IN JAPAN #OEMNTP

Application 1 :

Application 2 :

Application 3 :

Application 4 :

Application 5 :

Application 6 :

Application 7 :

Application 8 :

Application 9 :

Application 10 :

Application 11 :

Application 12 :

ZOOM+

ZOOM-



PARTS IMAGE

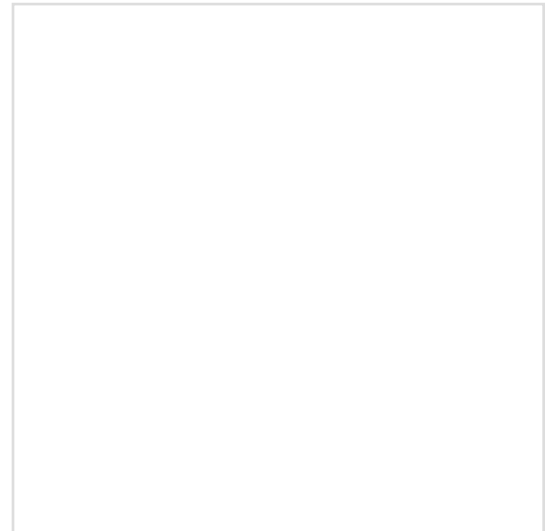

BOX IMAGE

H3-015

WATER PUMP MADE IN JAPAN

Parts Number :	H3-015
Manufacture 1 :	PARUAT / HITACHI <input type="button" value="v"/>
Manufacturer Number 1 :	19200-PH1-000
Manufacture 2 :	<input type="button" value="v"/>
Manufacturer Number 2 :	
M.S.R.P 04/2010 :	
Description:	WATER PUMP MADE IN JAPAN

- Application 1 :** 19210-PH1-305
- Application 2 :** 19200-PH1-505
- Application 3 :** HONDA ACCORD A20A 88-90
- Application 4 :**
- Application 5 :**
- Application 6 :**
- Application 7 :**
- Application 8 :**
- Application 9 :**
- Application 10 :**
- Application 11 :**
- Application 12 :**

ZOOM+ ZOOM-



PARTS IMAGE



BOX IMAGE

H3-018

WATER PUMP MADE IN JAPAN

Parts Number : H3-018

Manufacture 1 : PARUAT / HITACHI

Manufacturer Number 1 : 19200-PR4-013

Manufacture 2 :

Manufacturer Number 2 :

M.S.R.P 04/2010 : \$81.90

Description: WATER PUMP MADE IN JAPAN

Application 1 : 19200-PR4-003

Application 2 : ACURA INTEGRA B18B 93-95

Application 3 :

Application 4 :

Application 5 :

Application 6 :

Application 7 :

Application 8 :

Application 9 :

Application 10 :

Application 11 :

Application 12 :

ZOOM+

ZOOM-



PARTS IMAGE



BOX IMAGE

H3-019

WATER PUMP MADE IN JAPAN

Parts Number : H3-019

Manufacture 1 : PARUAT / HITACHI

Manufacturer Number 1 : 271

Manufacture 2 :

Manufacture Number 2 :

M.S.R.P 04/2010 :

Description: WATER PUMP MADE IN JAPAN

Application 1 :

Application 2 :

Application 3 :

Application 4 :

Application 5 :

Application 6 :

Application 7 :

Application 8 :

Application 9 :

Application 10 :

Application 11 :

Application 12 :

ZOOM+

ZOOM-



PARTS IMAGE

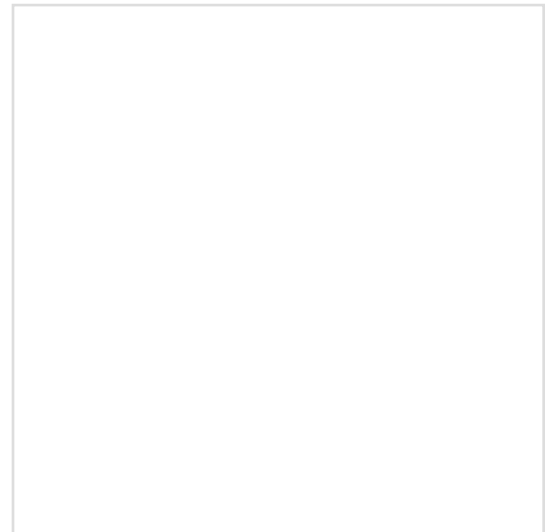

BOX IMAGE

H3-029

WATER PUMP MADE IN JAPAN

Parts Number : H3-029

Manufacture 1 : PARUAT / HITACHI

Manufacturer Number 1 : 19200-P01-004

Manufacture 2 :

Manufacturer Number 2 :

M.S.R.P 04/2010 : \$63.80

Description: WATER PUMP MADE IN JAPAN

Application 1 : 19200-P001-003

Application 2 : 19200-PM3-000/003/014

Application 3 : HONDA CIVIC 2D 93-95

Application 4 : HONDA CIVIC 3D 88-91

Application 5 : HONDA CIVIC 3D 92-95

Application 6 : HONDA CIVIC 88-91

Application 7 : HONDA CIVIC 4D 92-95

Application 8 : HONDA CRX 88-91

Application 9 : HONDA DEL SOL 93-97

Application 10 :

Application 11 :

Application 12 :

ZOOM+

ZOOM-



PARTS IMAGE

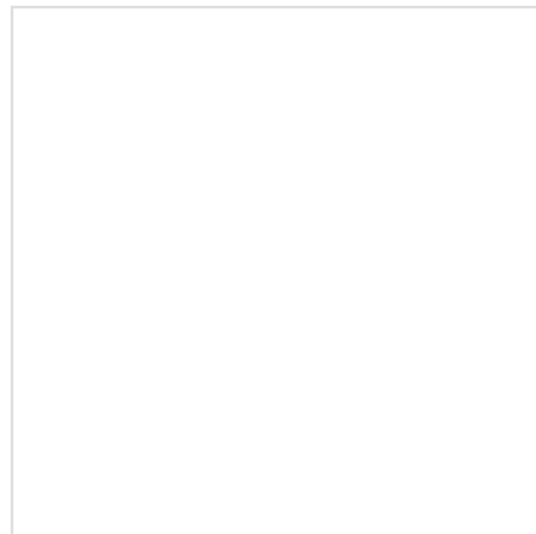

BOX IMAGE

H3-032

WATER PUMP MADE IN JAPAN

Parts Number : H3-032

Manufacture 1 : PARUAT / HITACHI

Manufacturer Number 1 : 19200-PE0515

Manufacture 2 :

Manufacturer Number 2 : 19200-PE0-660

M.S.R.P 04/2010 :

Description: WATER PUMP MADE IN JAPAN

Application 1 :

Application 2 :

Application 3 :

Application 4 :

Application 5 :

Application 6 :

Application 7 :

Application 8 :

Application 9 :

Application 10 :

Application 11 :

Application 12 :

ZOOM+

ZOOM-



PARTS IMAGE



BOX IMAGE

H3-037

WATER PUMP MADE IN JAPAN

Parts Number : H3-037

Manufacture 1 : PARUAT / HITACHI

Manufacturer Number 1 : 19200-PV1-A01

Manufacture 2 :

Manufacturer Number 2 :

M.S.R.P 04/2010 :

Description: WATER PUMP MADE IN JAPAN

Application 1 :

Application 2 :

Application 3 : HONDA ACCORD G20A

Application 4 :

Application 5 :

Application 6 :

Application 7 :

Application 8 :

Application 9 :

Application 10 :

Application 11 :

Application 12 :

ZOOM+

ZOOM-

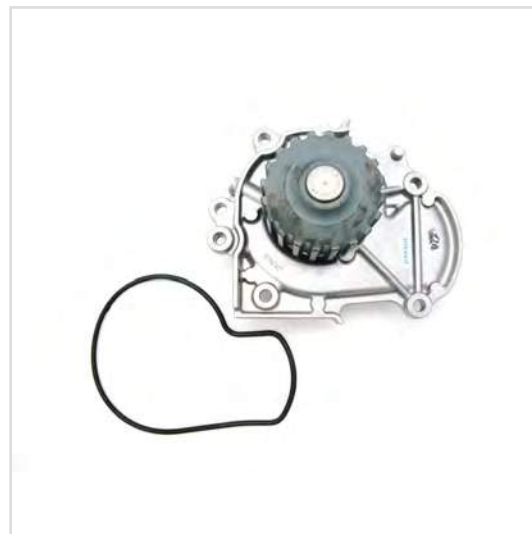

PARTS IMAGE



BOX IMAGE

H3-042

WATER PUMP MADE IN JAPAN

Parts Number :	H3-042
Manufacture 1 :	PARUAT / HITACHI <input type="button" value="v"/>
Manufacturer Number 1 :	19200-P0G-A01
Manufacture 2 :	<input type="button" value="v"/>
Manufacturer Number 2 :	
M.S.R.P 04/2010 :	\$112.60
Description:	WATER PUMP MADE IN JAPAN

- Application 1 :** 19200-PH7-003
- Application 2 :** HONDA ACCORD 4D 94-97
- Application 3 :**
- Application 4 :**
- Application 5 :**
- Application 6 :**
- Application 7 :**
- Application 8 :**
- Application 9 :**
- Application 10 :**
- Application 11 :**
- Application 12 :**

ZOOM+ ZOOM-



PARTS IMAGE



BOX IMAGE

H3-047

WATER PUMP MADE IN JAPAN

Parts Number : H3-047

Manufacture 1 : PARUAT / HITACHI

Manufacturer Number 1 : 284

Manufacture 2 :

Manufacture Number 2 :

M.S.R.P 04/2010 :

Description: WATER PUMP MADE IN JAPAN

Application 1 :

Application 2 :

Application 3 :

Application 4 :

Application 5 :

Application 6 :

Application 7 :

Application 8 :

Application 9 :

Application 10 :

Application 11 :

Application 12 :

ZOOM+

ZOOM-

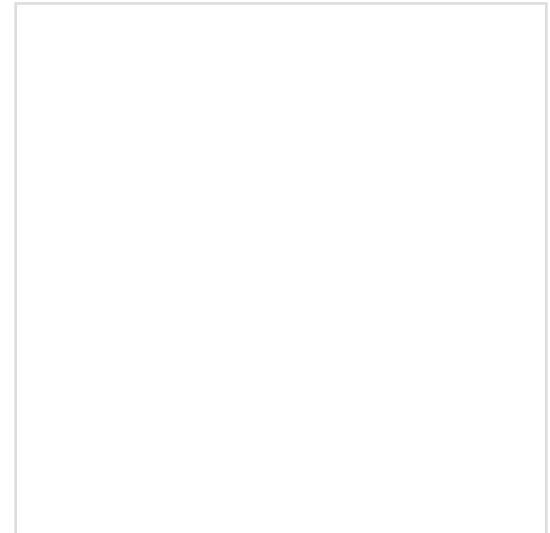

PARTS IMAGE

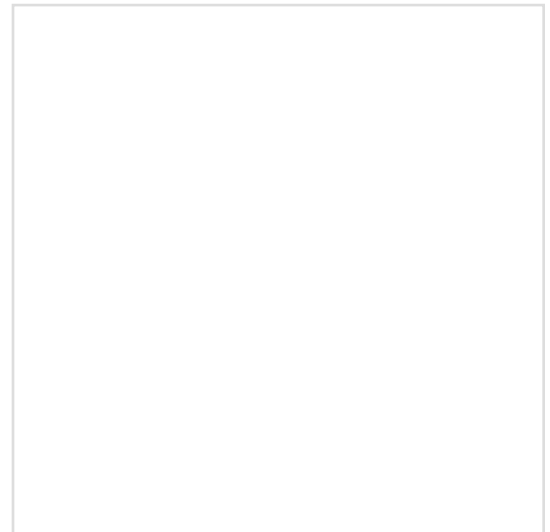

BOX IMAGE

H3-054

WATER PUMP MADE IN JAPAN

Parts Number : H3-054

Manufacture 1 : PARUAT / HITACHI

Manufacturer Number 1 : 288

Manufacture 2 :

Manufacture Number 2 :

M.S.R.P 04/2010 :

Description: WATER PUMP MADE IN JAPAN

Application 1 :

Application 2 :

Application 3 :

Application 4 :

Application 5 :

Application 6 :

Application 7 :

Application 8 :

Application 9 :

Application 10 :

Application 11 :

Application 12 :

ZOOM+

ZOOM-

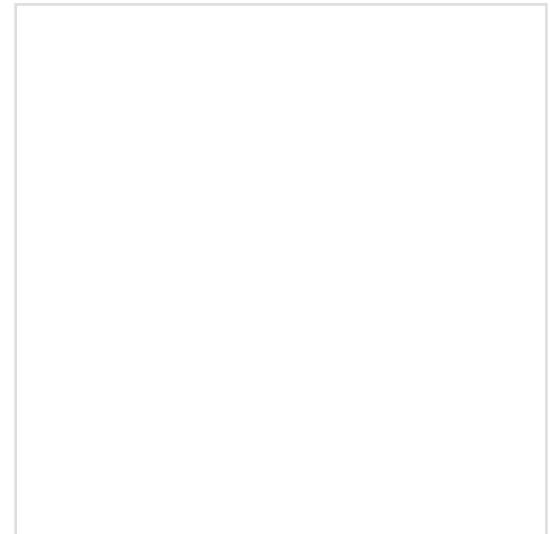

PARTS IMAGE

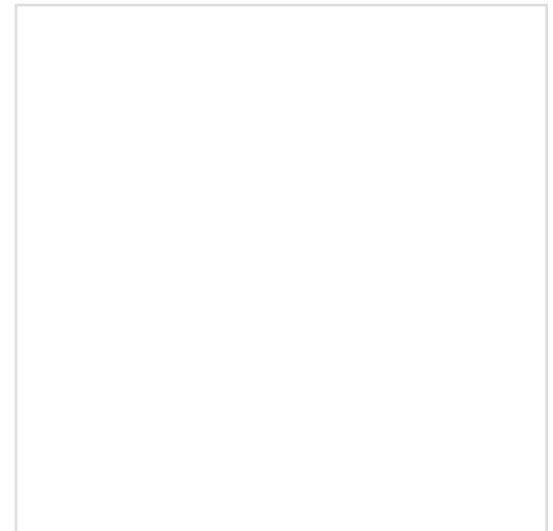

BOX IMAGE

H3-058

WATER PUMP MADE IN JAPAN

Parts Number : H3-058

Manufacture 1 : PARUAT / HITACHI

Manufacturer Number 1 : 287

Manufacture 2 :

Manufacture Number 2 :

M.S.R.P 04/2010 :

Description: WATER PUMP MADE IN JAPAN

Application 1 :

Application 2 :

Application 3 :

Application 4 :

Application 5 :

Application 6 :

Application 7 :

Application 8 :

Application 9 :

Application 10 :

Application 11 :

Application 12 :

ZOOM+

ZOOM-



PARTS IMAGE

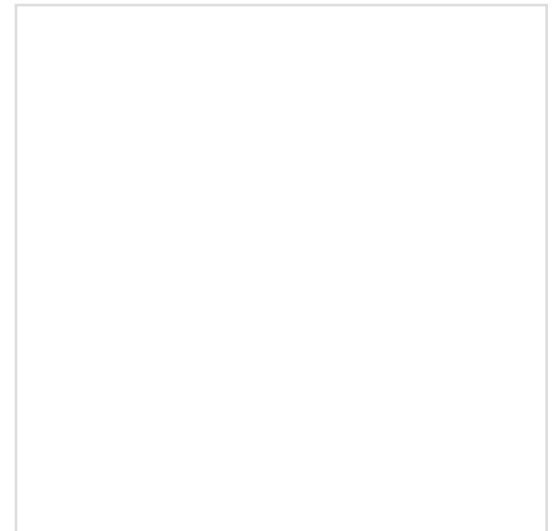

BOX IMAGE

JE15-12-730A

BELT TENSIONER MADE IN

Parts Number : JE15-12-730A

Manufacture 1 : NSK

Manufacturer Number 1 : 52TB0531

Manufacture 2 :

Manufacturer Number 2 :

M.S.R.P 04/2010 :

Description: BELT TENSIONER MADE IN JAPAN

Application 1 :

Application 2 :

Application 3 :

Application 4 :

Application 5 :

Application 6 :

Application 7 :

Application 8 :

Application 9 :

Application 10 :

Application 11 :

Application 12 :

ZOOM+ ZOOM-



PARTS IMAGE



BOX IMAGE

JE26-12-730A

BELT TENSIONER

Parts Number : JE26-12-730A

Manufacture 1 : NSK

Manufacturer Number 1 : 60TB0407

Manufacture 2 :

Manufacturer Number 2 :

M.S.R.P 04/2010 :

Description: BELT TENSIONER

Application 1 :

Application 2 :

Application 3 :

Application 4 :

Application 5 :

Application 6 :

Application 7 :

Application 8 :

Application 9 :

Application 10 :

Application 11 :

Application 12 :

ZOOM+

ZOOM-



PARTS IMAGE

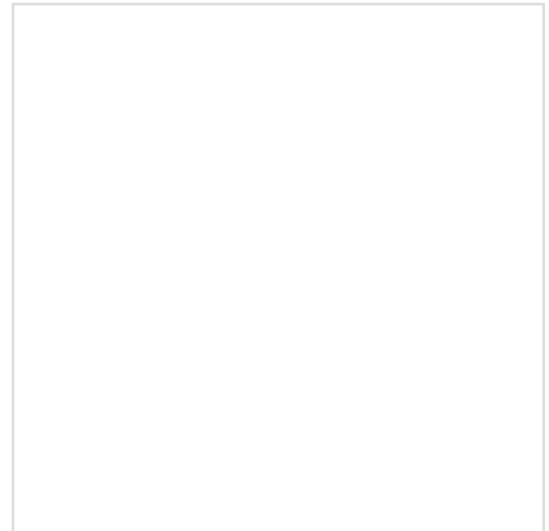

BOX IMAGE

JE26-12-740A

BELT TENSIONER

Parts Number : JE26-12-740A

Manufacture 1 : NSK

Manufacturer Number 1 : 60TB0406

Manufacture 2 :

Manufacturer Number 2 :

M.S.R.P 04/2010 :

Description: BELT TENSIONER

Application 1 :

Application 2 :

Application 3 :

Application 4 :

Application 5 :

Application 6 :

Application 7 :

Application 8 :

Application 9 :

Application 10 :

Application 11 :

Application 12 :

ZOOM+

ZOOM-

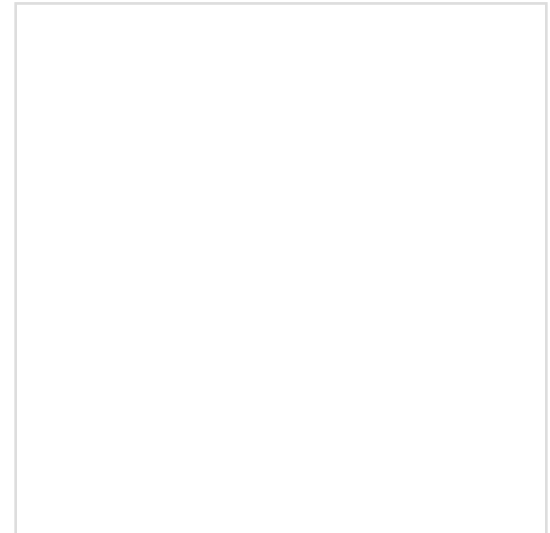

PARTS IMAGE

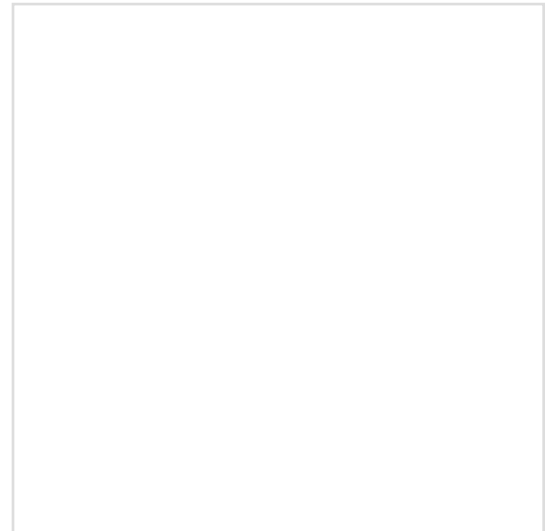

BOX IMAGE

JE48-12-730

BELT TENSIONER

Parts Number : JE48-12-730

Manufacture 1 : NSK

Manufacturer Number 1 : 60TB0667

Manufacture 2 :

Manufacturer Number 2 :

M.S.R.P 04/2010 :

Description: BELT TENSIONER

Application 1 :

Application 2 :

Application 3 :

Application 4 :

Application 5 :

Application 6 :

Application 7 :

Application 8 :

Application 9 :

Application 10 :

Application 11 :

Application 12 :

ZOOM+

ZOOM-

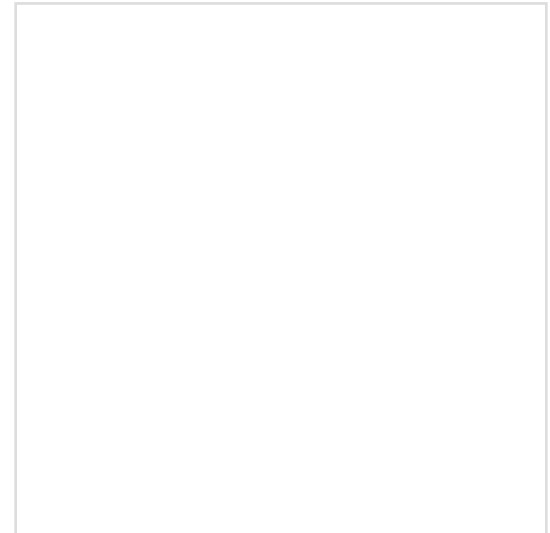

PARTS IMAGE

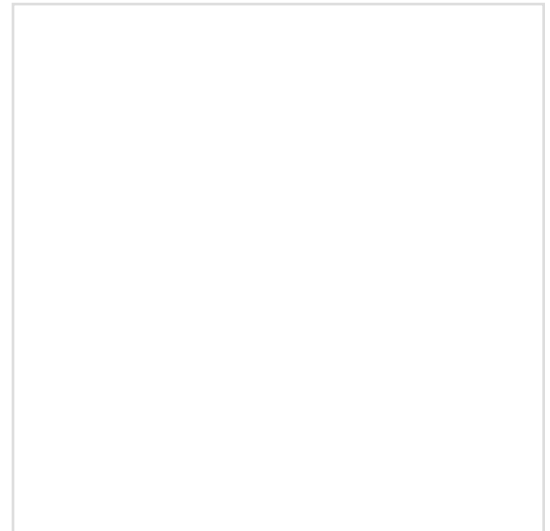

BOX IMAGE

JE48-12-740

BELT TENSIONER

Parts Number : JE48-12-740

Manufacture 1 : NSK

Manufacturer Number 1 : 60TB0666

Manufacture 2 :

Manufacturer Number 2 :

M.S.R.P 04/2010 :

Description: BELT TENSIONER

Application 1 :

Application 2 :

Application 3 :

Application 4 :

Application 5 :

Application 6 :

Application 7 :

Application 8 :

Application 9 :

Application 10 :

Application 11 :

Application 12 :

ZOOM+

ZOOM-

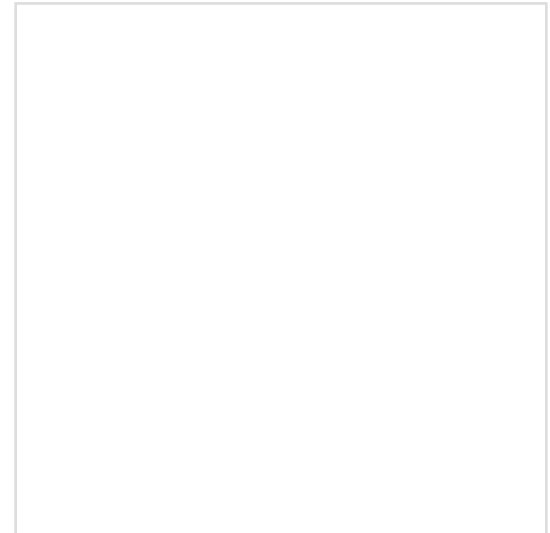

PARTS IMAGE

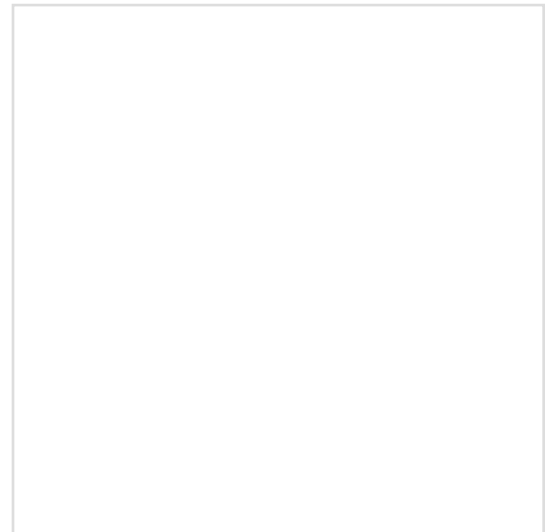

BOX IMAGE

K19-40-RP000

SOLENOID TRANSMISSION

Parts Number : K19-40-RP000

Manufacture 1 : MITSUBISHI

Manufacturer Number 1 :

Manufacture 2 :

Manufacture Number 2 :

M.S.R.P 04/2010 :

Description: SOLENOID TRANSMISSION
COMPLETE KIT MADE IN JAPAN
#OEMNTP

Application 1 :

Application 2 :

Application 3 :

Application 4 :

Application 5 :

Application 6 :

Application 7 :

Application 8 :

Application 9 :

Application 10 :

Application 11 :

Application 12 :

ZOOM+

ZOOM-



PARTS IMAGE

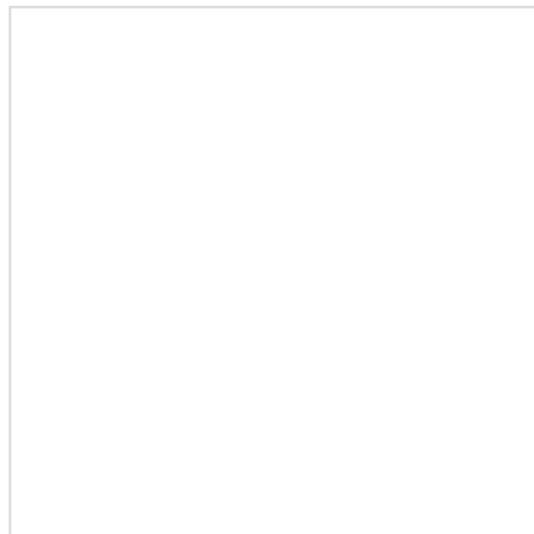

BOX IMAGE

K19-40-RP001

Parts Number : K19-40-RP001

Manufacture 1 : MITSUBISHI

Manufacturer Number 1 : 210

Manufacture 2 :

Manufacture Number 2 :

M.S.R.P 04/2010 :

Description: SOLENOID TRANSMISSION
COMPLETE KIT MADE IN JAPAN
#OEMNTP

Application 1 :

Application 2 :

Application 3 :

Application 4 :

Application 5 :

Application 6 :

Application 7 :

Application 8 :

Application 9 :

Application 10 :

Application 11 :

Application 12 :

SOLENOID TRANSMISSION

ZOOM+

ZOOM-



PARTS IMAGE

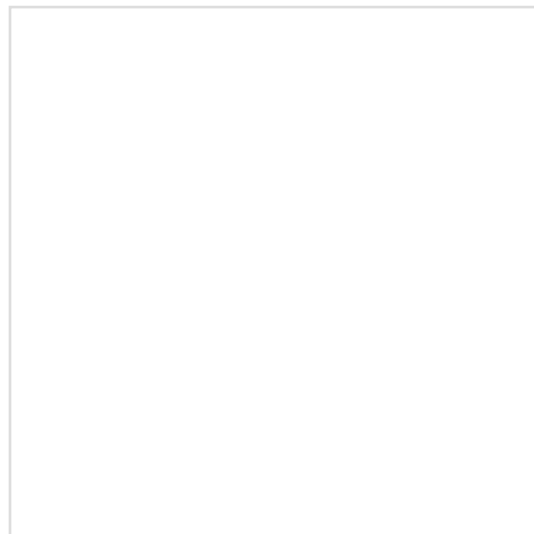

BOX IMAGE

KAF-220101

Parts Number : KAF-220101

Manufacture 1 : K.FM

Manufacturer Number 1 : 16546-0Z000

Manufacture 2 :

Manufacturer Number 2 :

M.S.R.P 04/2010 :

Description: AIR FILTER KFM MADE IN MALAYSIA

Application 1 : AC DELCO A975C

Application 2 : FRAM CA 4309

Application 3 : PUROLATOR A24278

Application 4 :

Application 5 :

Application 6 :

Application 7 :

Application 8 :

Application 9 :

Application 10 :

Application 11 :

Application 12 :

AIR FILTER KFM MADE IN

ZOOM+

ZOOM-



PARTS IMAGE



BOX IMAGE

KAF-260103

Parts Number :	KAF-260103
Manufacture 1 :	K.FM <input type="button" value="v"/>
Manufacturer Number 1 :	17220-PT2-305
Manufacture 2 :	<input type="button" value="v"/>
Manufacturer Number 2 :	
M.S.R.P 04/2010 :	
Description:	AIR FILTER KFM MADE IN MALAYSIA

AIR FILTER KFM MADE IN

ZOOM+ ZOOM-



PARTS IMAGE

- Application 1 : FRAM CA6807
- Application 2 : AC DELCO A1251C
- Application 3 : PUROLATOR A24680
- Application 4 :
- Application 5 :
- Application 6 :
- Application 7 :
- Application 8 :
- Application 9 :
- Application 10 :
- Application 11 :
- Application 12 :



BOX IMAGE

KAF-260201

Parts Number : KAF-260201

Manufacture 1 : K.FM

Manufacturer Number 1 : 17220-PO7-000

Manufacture 2 :

Manufacture Number 2 :

M.S.R.P 04/2010 :

Description: AIR FILTER KFM MADE IN MALAYSIA

Application 1 : AC DELCO A1287C

Application 2 : FRAM CA7174

Application 3 : PUROLATOR A34799

Application 4 :

Application 5 :

Application 6 :

Application 7 :

Application 8 :

Application 9 :

Application 10 :

Application 11 :

Application 12 :

AIR FILTER KFM MADE IN

ZOOM+

ZOOM-

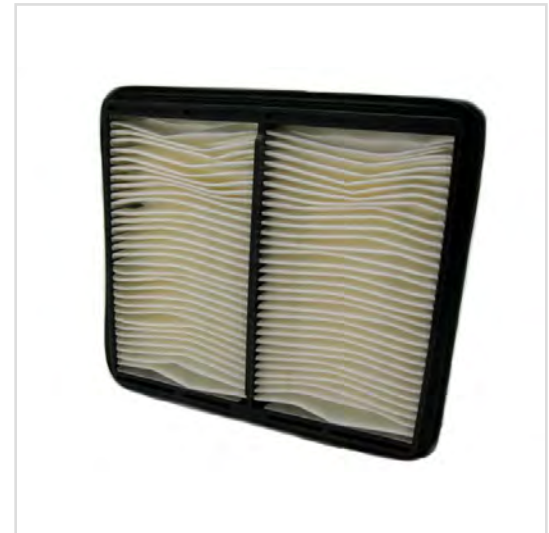

PARTS IMAGE



BOX IMAGE

KAF-260202

Parts Number : KAF-260202

Manufacture 1 : K.FM

Manufacturer Number 1 : 17220-P2F-A01

Manufacture 2 :

Manufacturer Number 2 :

M.S.R.P 04/2010 :

Description: AIR FILTER KFM MADE IN MALAYSIA

Application 1 : AC DELCO A1511C

Application 2 : FRAM CA 8040

Application 3 :

Application 4 :

Application 5 :

Application 6 :

Application 7 :

Application 8 :

Application 9 :

Application 10 :

Application 11 :

Application 12 :

AIR FILTER KFM MADE IN

ZOOM+

ZOOM-



PARTS IMAGE



BOX IMAGE

KAF-260601

Parts Number : KAF-260601

Manufacture 1 : K.FM

Manufacturer Number 1 : 17220-P8F-A00

Manufacture 2 :

Manufacturer Number 2 :

M.S.R.P 04/2010 :

Description: AIR FILTER KFM MADE IN MALAYSIA

Application 1 : AC DELCO A2051C

Application 2 : FRAM CA8760

Application 3 : PUROLATOR A 25352

Application 4 :

Application 5 :

Application 6 :

Application 7 :

Application 8 :

Application 9 :

Application 10 :

Application 11 :

Application 12 :

AIR FILTER KFM MADE IN

ZOOM+

ZOOM-



PARTS IMAGE



BOX IMAGE

KCF-224008

Parts Number : KCF-224008

Manufacture 1 : K.FM

Manufacturer Number 1 : 999M1-VP055

Manufacture 2 :

Manufacturer Number 2 :

M.S.R.P 04/2010 :

Description: CABIN FILTER KFM MADE IN USA

Application 1 :

Application 2 :

Application 3 :

Application 4 :

Application 5 :

Application 6 :

Application 7 :

Application 8 :

Application 9 :

Application 10 :

Application 11 :

Application 12 :

CABIN FILTER KFM MADE IN

ZOOM+

ZOOM-



PARTS IMAGE



BOX IMAGE

KCF-264005

Parts Number : KCF-264005

Manufacture 1 : K.FM

Manufacturer Number 1 : 80291-ST3-515

Manufacture 2 :

Manufacturer Number 2 :

M.S.R.P 04/2010 :

Description: CABIN FILTER KFM MADE IN USA

Application 1 :

Application 2 :

Application 3 :

Application 4 :

Application 5 :

Application 6 :

Application 7 :

Application 8 :

Application 9 :

Application 10 :

Application 11 :

Application 12 :

CABIN FILTER KFM MADE IN

ZOOM+

ZOOM-



PARTS IMAGE



BOX IMAGE

KCF-264013

Parts Number : KCF-264013

Manufacture 1 : K.FM

Manufacturer Number 1 : 80292-SEC-R01

Manufacture 2 :

Manufacture Number 2 :

M.S.R.P 04/2010 :

Description: CABIN FILTER KFM MADE IN USA

Application 1 :

Application 2 :

Application 3 :

Application 4 :

Application 5 :

Application 6 :

Application 7 :

Application 8 :

Application 9 :

Application 10 :

Application 11 :

Application 12 :

CABIN FILTER KFM MADE IN

ZOOM+

ZOOM-



PARTS IMAGE



BOX IMAGE

KL01-12-730

Parts Number : KL01-12-730

Manufacture 1 : NSK

Manufacturer Number 1 : 60TB0692

Manufacture 2 :

Manufacturer Number 2 :

M.S.R.P 04/2010 :

Description: BELT TENSIONER MADE IN JAPAN

Application 1 :

Application 2 :

Application 3 :

Application 4 :

Application 5 :

Application 6 :

Application 7 :

Application 8 :

Application 9 :

Application 10 :

Application 11 :

Application 12 :

BELT TENSIONER MADE IN

ZOOM+ ZOOM-



PARTS IMAGE



BOX IMAGE

KL01-12-740

BELT TENSIONER MADE IN

Parts Number : KL01-12-740

Manufacture 1 : NSK

Manufacturer Number 1 : 60TB0662

Manufacture 2 :

Manufacturer Number 2 :

M.S.R.P 04/2010 :

Description: BELT TENSIONER MADE IN JAPAN

Application 1 :

Application 2 :

Application 3 :

Application 4 :

Application 5 :

Application 6 :

Application 7 :

Application 8 :

Application 9 :

Application 10 :

Application 11 :

Application 12 :

ZOOM+ ZOOM-



PARTS IMAGE



BOX IMAGE

MD008965

BELT TENSIONER

Parts Number : MD008965

Manufacture 1 : NTN

Manufacturer Number 1 : JPU60-71+JF121

Manufacture 2 :

Manufacturer Number 2 :

M.S.R.P 04/2010 :

Description: BELT TENSIONER

Application 1 :

Application 2 :

Application 3 :

Application 4 :

Application 5 :

Application 6 :

Application 7 :

Application 8 :

Application 9 :

Application 10 :

Application 11 :

Application 12 :

ZOOM+

ZOOM-



PARTS IMAGE

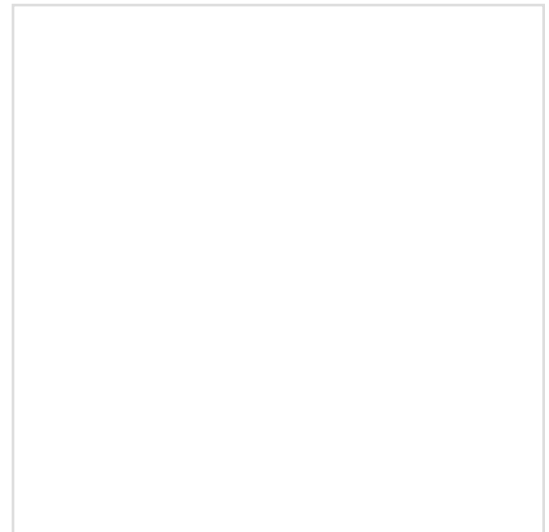

BOX IMAGE

MD009650

BELT TENSIONER

Parts Number : MD009650

Manufacture 1 : NTN

Manufacturer Number 1 : JPU60-257

Manufacture 2 :

Manufacturer Number 2 :

M.S.R.P 04/2010 :

Description: BELT TENSIONER

Application 1 :

Application 2 :

Application 3 :

Application 4 :

Application 5 :

Application 6 :

Application 7 :

Application 8 :

Application 9 :

Application 10 :

Application 11 :

Application 12 :

ZOOM+

ZOOM-

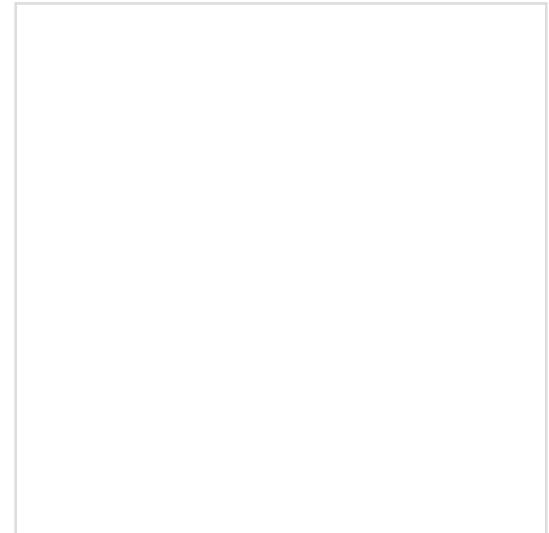

PARTS IMAGE

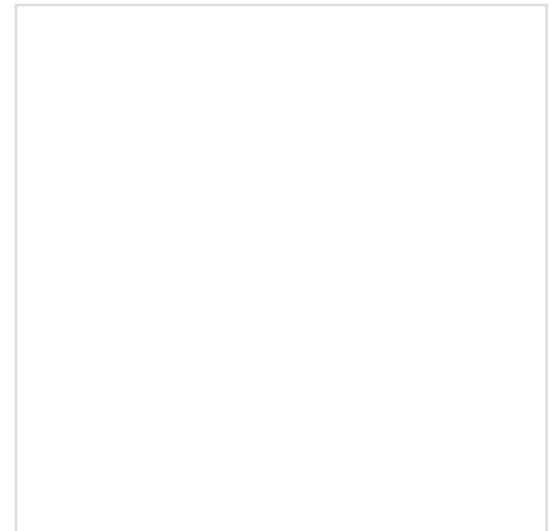

BOX IMAGE

MD011536

BELT TENSIONER MADE IN

Parts Number : MD011536

Manufacture 1 : NSK

Manufacturer Number 1 : 60TB041B12A

Manufacture 2 :

Manufacture Number 2 :

M.S.R.P 04/2010 :

Description: BELT TENSIONER MADE IN JAPAN

Application 1 :

Application 2 :

Application 3 :

Application 4 :

Application 5 :

Application 6 :

Application 7 :

Application 8 :

Application 9 :

Application 10 :

Application 11 :

Application 12 :

ZOOM+ ZOOM-



PARTS IMAGE



BOX IMAGE

MD030605

BELT TENSIONER

Parts Number : MD030605

Manufacture 1 : NTN

Manufacturer Number 1 : JPU60-71+JF129

Manufacture 2 :

Manufacture Number 2 :

M.S.R.P 04/2010 :

Description: BELT TENSIONER

Application 1 :

Application 2 :

Application 3 :

Application 4 :

Application 5 :

Application 6 :

Application 7 :

Application 8 :

Application 9 :

Application 10 :

Application 11 :

Application 12 :

ZOOM+ ZOOM-



PARTS IMAGE

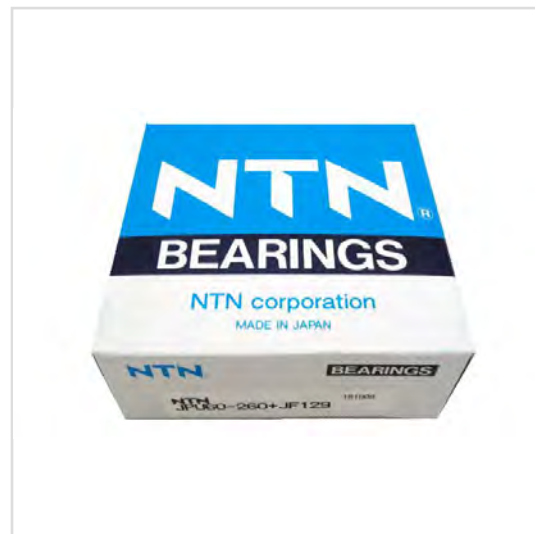

BOX IMAGE

MD040754

BELT TENSIONER

Parts Number : MD040754

Manufacture 1 : NTN

Manufacturer Number 1 : JPU60-242

Manufacture 2 :

Manufacturer Number 2 :

M.S.R.P 04/2010 :

Description: BELT TENSIONER

Application 1 :

Application 2 :

Application 3 :

Application 4 :

Application 5 :

Application 6 :

Application 7 :

Application 8 :

Application 9 :

Application 10 :

Application 11 :

Application 12 :

ZOOM+

ZOOM-

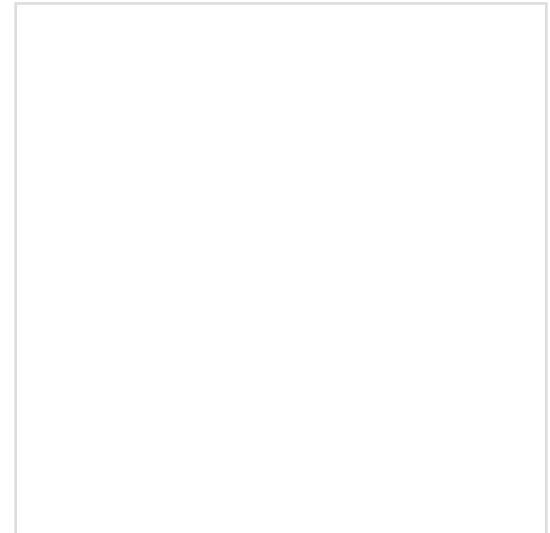

PARTS IMAGE

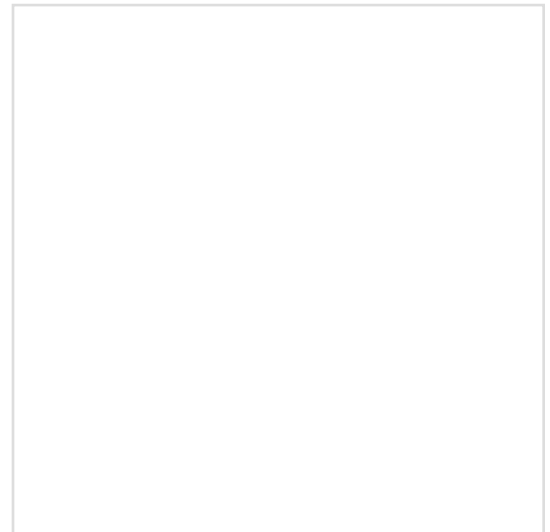

BOX IMAGE

MD104578

BELT TENSIONER

Parts Number : MD104578

Manufacture 1 : KOYO

Manufacturer Number 1 : PU316029RR1DV

Manufacture 2 :

Manufacture Number 2 :

M.S.R.P 04/2010 :

Description: BELT TENSIONER

Application 1 :

Application 2 :

Application 3 :

Application 4 :

Application 5 :

Application 6 :

Application 7 :

Application 8 :

Application 9 :

Application 10 :

Application 11 :

Application 12 :

ZOOM+

ZOOM-

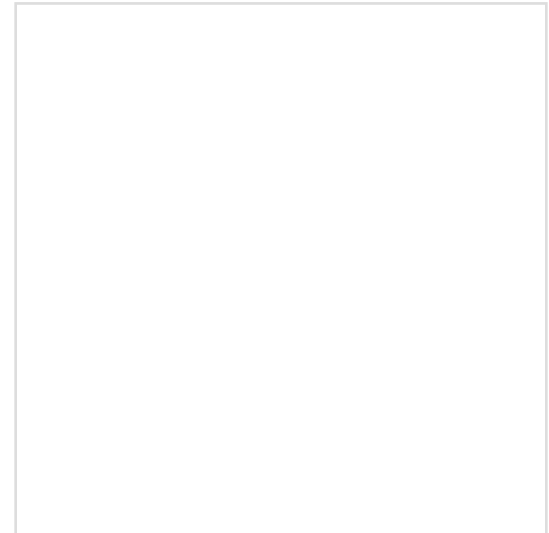

PARTS IMAGE

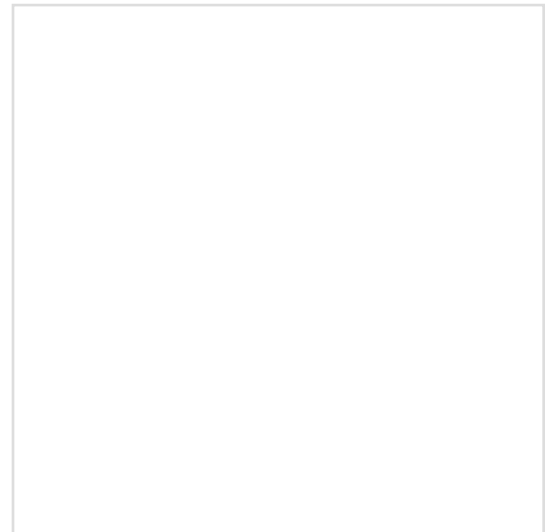

BOX IMAGE

MD109958

BELT TENSIONER

Parts Number : MD109958

Manufacture 1 : NTN

Manufacturer Number 1 : JPU60-260+JF397

Manufacture 2 :

Manufacturer Number 2 :

M.S.R.P 04/2010 :

Description: BELT TENSIONER

Application 1 :

Application 2 :

Application 3 :

Application 4 :

Application 5 :

Application 6 :

Application 7 :

Application 8 :

Application 9 :

Application 10 :

Application 11 :

Application 12 :

ZOOM+

ZOOM-

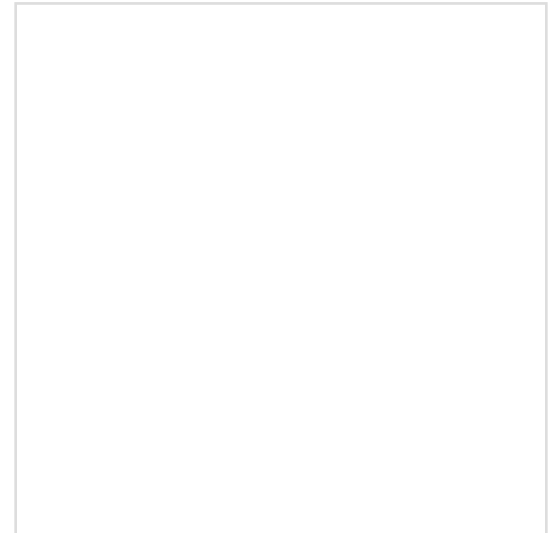

PARTS IMAGE

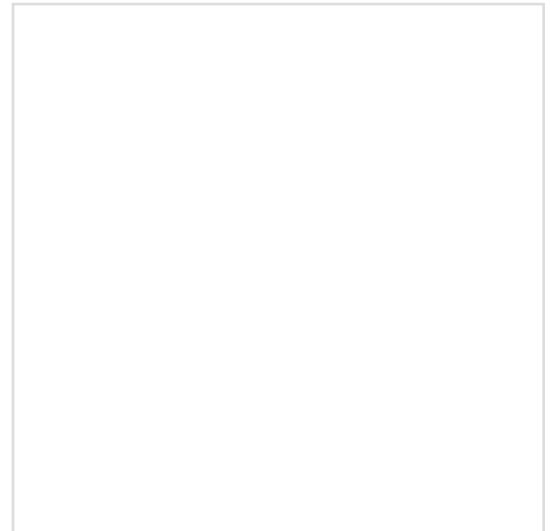

BOX IMAGE

MD115976

BELT TENSIONER

Parts Number : MD115976

Manufacture 1 : NTN

Manufacturer Number 1 : JPU55-54

Manufacture 2 :

Manufacture Number 2 :

M.S.R.P 04/2010 :

Description: BELT TENSIONER

Application 1 :

Application 2 :

Application 3 :

Application 4 :

Application 5 :

Application 6 :

Application 7 :

Application 8 :

Application 9 :

Application 10 :

Application 11 :

Application 12 :

ZOOM+

ZOOM-



PARTS IMAGE

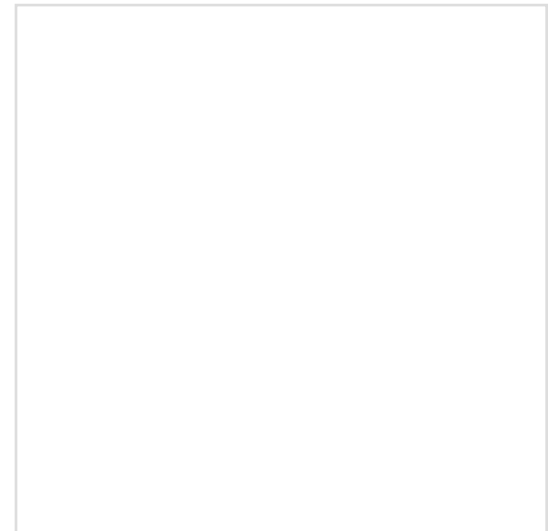

BOX IMAGE

MD128765

BELT TENSIONER

Parts Number : MD128765

Manufacture 1 : NTN

Manufacturer Number 1 : JPU60-243

Manufacture 2 :

Manufacture Number 2 :

M.S.R.P 04/2010 :

Description: BELT TENSIONER

Application 1 :

Application 2 :

Application 3 :

Application 4 :

Application 5 :

Application 6 :

Application 7 :

Application 8 :

Application 9 :

Application 10 :

Application 11 :

Application 12 :

ZOOM+

ZOOM-



PARTS IMAGE

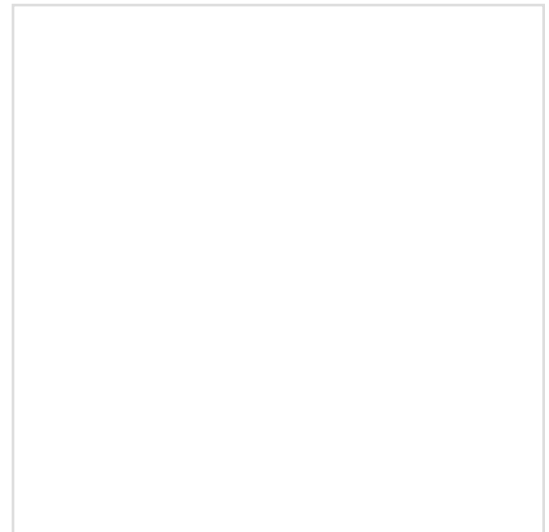

BOX IMAGE

MD129033

BELT TENSIONER

Parts Number : MD129033

Manufacture 1 : NTN

Manufacturer Number 1 : JPU60-216+JF391

Manufacture 2 :

Manufacturer Number 2 :

M.S.R.P 04/2010 :

Description: BELT TENSIONER

Application 1 :

Application 2 :

Application 3 :

Application 4 :

Application 5 :

Application 6 :

Application 7 :

Application 8 :

Application 9 :

Application 10 :

Application 11 :

Application 12 :

ZOOM+

ZOOM-

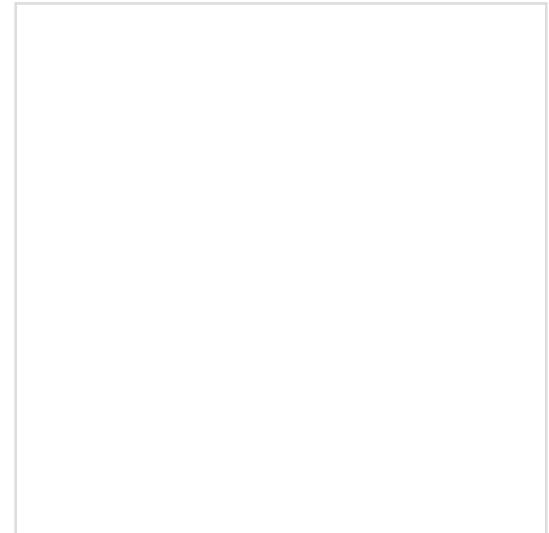

PARTS IMAGE

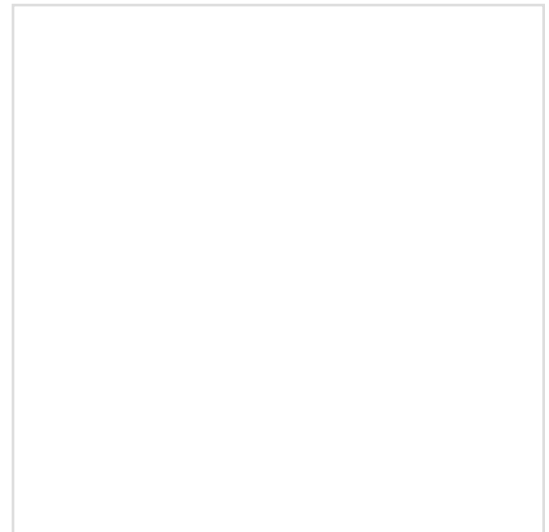

BOX IMAGE

MD129355

Parts Number : MD129355

Manufacture 1 : NTN

Manufacturer Number 1 : JPU60-215/JPU60-013B-1

Manufacture 2 :

Manufacture Number 2 :

M.S.R.P 04/2010 :

Description: BELT TENSIONER MADE IN JAPAN

BELT TENSIONER MADE IN



PARTS IMAGE

Application 1 :

Application 2 :

Application 3 :

Application 4 :

Application 5 :

Application 6 :

Application 7 :

Application 8 :

Application 9 :

Application 10 :

Application 11 :

Application 12 :



BOX IMAGE

MD140071

BELT TENSIONER

Parts Number : MD140071

Manufacture 1 : KOYO

Manufacturer Number 1 : PU106018BRR9D

Manufacture 2 :

Manufacturer Number 2 :

M.S.R.P 04/2010 :

Description: BELT TENSIONER

Application 1 :

Application 2 :

Application 3 :

Application 4 :

Application 5 :

Application 6 :

Application 7 :

Application 8 :

Application 9 :

Application 10 :

Application 11 :

Application 12 :

ZOOM+

ZOOM-



PARTS IMAGE



BOX IMAGE

MD140578

BELT TENSIONER

Parts Number : MD140578

Manufacture 1 : KOYO

Manufacturer Number 1 : PU316029RR1DV

Manufacture 2 :

Manufacture Number 2 :

M.S.R.P 04/2010 :

Description: BELT TENSIONER

Application 1 :

Application 2 :

Application 3 :

Application 4 :

Application 5 :

Application 6 :

Application 7 :

Application 8 :

Application 9 :

Application 10 :

Application 11 :

Application 12 :

ZOOM+

ZOOM-



PARTS IMAGE

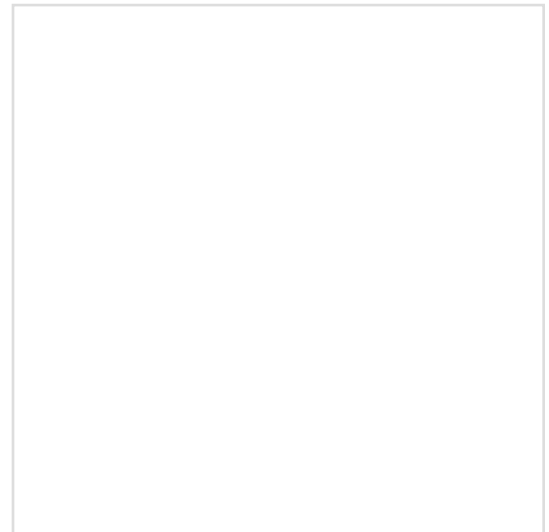

BOX IMAGE

MD146186

BELT TENSIONER

Parts Number : MD146186

Manufacture 1 : NTN

Manufacturer Number 1 : JPU60-238+JF441

Manufacture 2 :

Manufacture Number 2 :

M.S.R.P 04/2010 :

Description: BELT TENSIONER

Application 1 :

Application 2 :

Application 3 :

Application 4 :

Application 5 :

Application 6 :

Application 7 :

Application 8 :

Application 9 :

Application 10 :

Application 11 :

Application 12 :

ZOOM+

ZOOM-



PARTS IMAGE



BOX IMAGE

MD151447

BELT TENSIONER MADE IN

Parts Number : MD151447

Manufacture 1 : KOYO

Manufacturer Number 1 : PU305729ARR1DW

Manufacture 2 :

Manufacturer Number 2 :

M.S.R.P 04/2010 :

Description: BELT TENSIONER MADE IN JAPAN

Application 1 :

Application 2 :

Application 3 :

Application 4 :

Application 5 :

Application 6 :

Application 7 :

Application 8 :

Application 9 :

Application 10 :

Application 11 :

Application 12 :

ZOOM+

ZOOM-



PARTS IMAGE



BOX IMAGE

MD156604

BELT TENSIONER

Parts Number : MD156604

Manufacture 1 : KOYO

Manufacturer Number 1 : PU276033RR1D

Manufacture 2 :

Manufacture Number 2 :

M.S.R.P 04/2010 :

Description: BELT TENSIONER

Application 1 :

Application 2 :

Application 3 :

Application 4 :

Application 5 :

Application 6 :

Application 7 :

Application 8 :

Application 9 :

Application 10 :

Application 11 :

Application 12 :

ZOOM+

ZOOM-



PARTS IMAGE

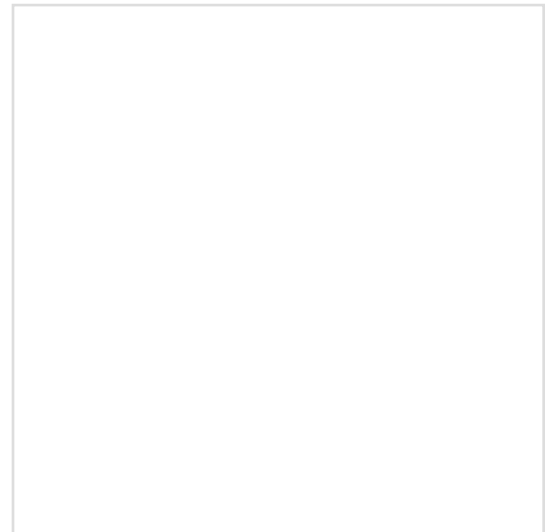

BOX IMAGE

MD175375

BELT TENSIONER

Parts Number : MD175375

Manufacture 1 : KOYO

Manufacturer Number 1 : PU305733ARR1DY1

Manufacture 2 :

Manufacturer Number 2 :

M.S.R.P 04/2010 :

Description: BELT TENSIONER

Application 1 :

Application 2 :

Application 3 :

Application 4 :

Application 5 :

Application 6 :

Application 7 :

Application 8 :

Application 9 :

Application 10 :

Application 11 :

Application 12 :

ZOOM+

ZOOM-



PARTS IMAGE

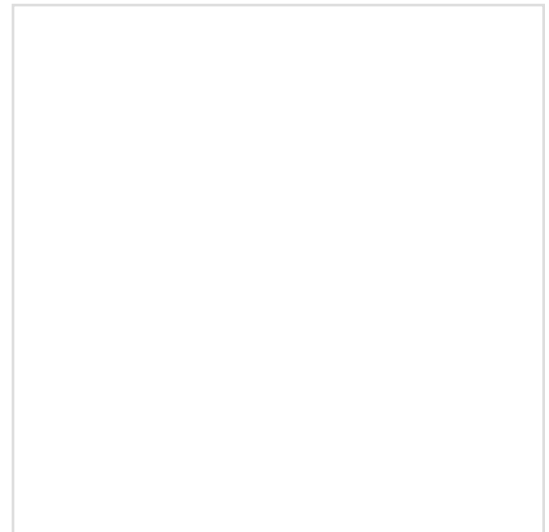

BOX IMAGE

MD192068

BELT TENSIONER MADE IN

Parts Number : MD192068

Manufacture 1 : NTN

Manufacturer Number 1 : JPU55-002B-1

Manufacture 2 :

Manufacture Number 2 :

M.S.R.P 04/2010 :

Description: BELT TENSIONER MADE IN JAPAN

Application 1 :

Application 2 :

Application 3 :

Application 4 :

Application 5 :

Application 6 :

Application 7 :

Application 8 :

Application 9 :

Application 10 :

Application 11 :

Application 12 :

ZOOM+

ZOOM-



PARTS IMAGE



BOX IMAGE

MD315265

BELT TENSIONER

Parts Number : MD315265

Manufacture 1 : KOYO

Manufacturer Number 1 : PU305733ARR1DY4

Manufacture 2 :

Manufacture Number 2 :

M.S.R.P 04/2010 :

Description: BELT TENSIONER

Application 1 :

Application 2 :

Application 3 :

Application 4 :

Application 5 :

Application 6 :

Application 7 :

Application 8 :

Application 9 :

Application 10 :

Application 11 :

Application 12 :

ZOOM+

ZOOM-



PARTS IMAGE

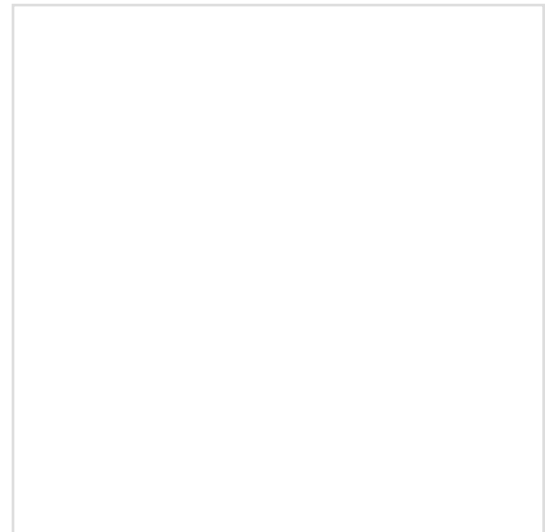

BOX IMAGE

MD320174

BELT TENSIONER

Parts Number : MD320174

Manufacture 1 : KOYO

Manufacturer Number 1 : PU305733DRR1DY6

Manufacture 2 :

Manufacture Number 2 :

M.S.R.P 04/2010 :

Description: BELT TENSIONER

Application 1 :

Application 2 :

Application 3 :

Application 4 :

Application 5 :

Application 6 :

Application 7 :

Application 8 :

Application 9 :

Application 10 :

Application 11 :

Application 12 :

ZOOM+

ZOOM-

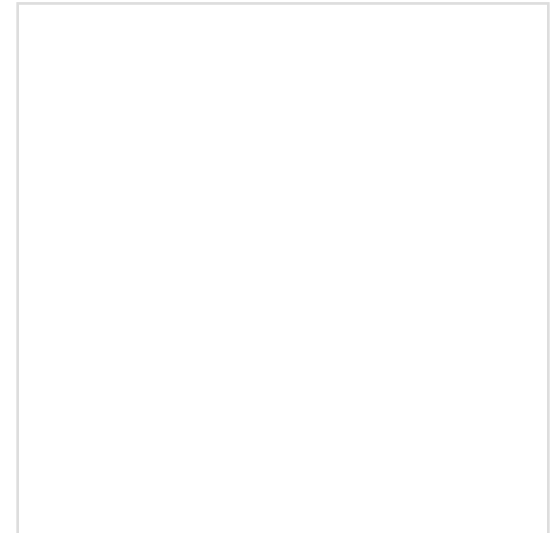

PARTS IMAGE

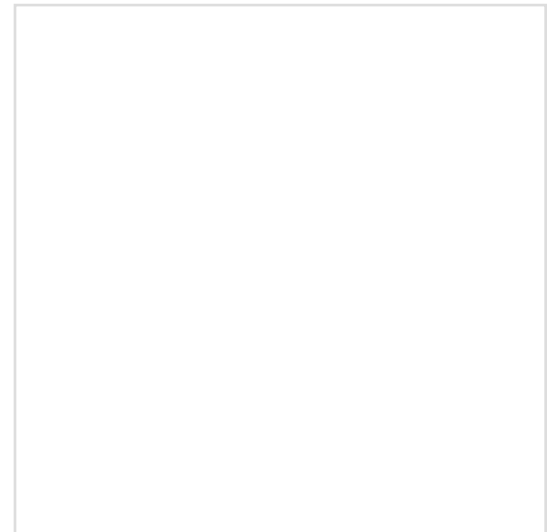

BOX IMAGE

MD329976

BELT TENSIONER MADE IN

Parts Number : MD329976

Manufacture 1 : NTN

Manufacturer Number 1 : JPU57-54+JF598

Manufacture 2 :

Manufacture Number 2 :

M.S.R.P 04/2010 :

Description: BELT TENSIONER MADE IN JAPAN

Application 1 :

Application 2 :

Application 3 :

Application 4 :

Application 5 :

Application 6 :

Application 7 :

Application 8 :

Application 9 :

Application 10 :

Application 11 :

Application 12 :

ZOOM+ ZOOM-



PARTS IMAGE



BOX IMAGE

MD751031

SENSOR TRANSMISSION

Parts Number : MD751031

Manufacture 1 :

Manufacturer Number 1 :

227

Manufacture 2 :

Manufacturer Number 2 :

M.S.R.P 04/2010 :

Description:

SENSOR TRANSMISSION PULSE
MADE IN JAPAN #OEMNTP

Application 1 :

Application 2 :

Application 3 :

Application 4 :

Application 5 :

Application 6 :

Application 7 :

Application 8 :

Application 9 :

Application 10 :

Application 11 :

Application 12 :

ZOOM+

ZOOM-

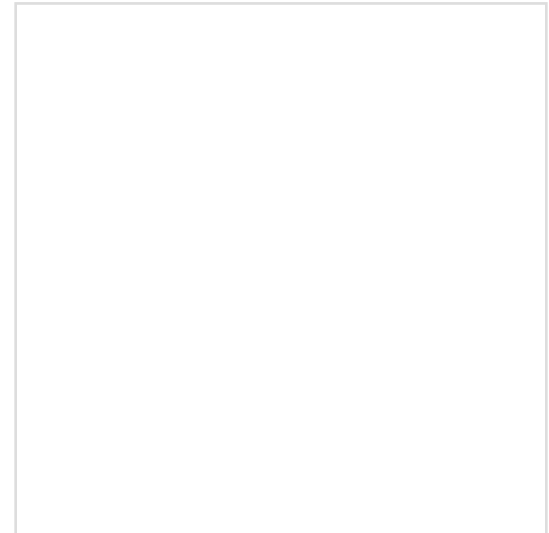

PARTS IMAGE

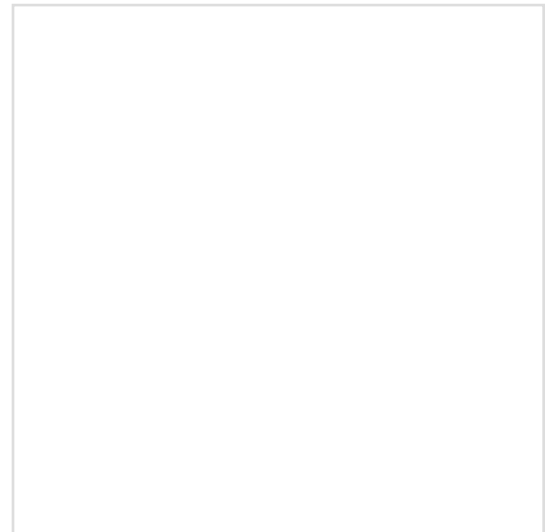

BOX IMAGE

NPO-102W

Parts Number : NPO-102W

Manufacture 1 : NISSIN

Manufacturer Number 1 : JB325 NKP10FF

Manufacture 2 :

Manufacture Number 2 :

M.S.R.P 04/2010 :

Description: BRAKE PAD MADE IN JAPAN

Application 1 :

Application 2 :

Application 3 :

Application 4 :

Application 5 :

Application 6 :

Application 7 :

Application 8 :

Application 9 :

Application 10 :

Application 11 :

Application 12 :

BRAKE PAD MADE IN JAPAN

ZOOM+

ZOOM-



PARTS IMAGE



BOX IMAGE

NPO-104W

Parts Number : NPO-104W

Manufacture 1 : NISSIN

Manufacturer Number 1 : II117A NKP10FF

Manufacture 2 :

Manufacture Number 2 :

M.S.R.P 04/2010 :

Description: BRAKE PAD MADE IN JAPAN

Application 1 :

Application 2 :

Application 3 :

Application 4 :

Application 5 :

Application 6 :

Application 7 :

Application 8 :

Application 9 :

Application 10 :

Application 11 :

Application 12 :

BRAKE PAD MADE IN JAPAN

ZOOM+

ZOOM-



PARTS IMAGE



BOX IMAGE

NPO-105W

Parts Number : NPO-105W

Manufacture 1 : NISSIN

Manufacturer Number 1 : 9V08V NKP10FF

Manufacture 2 :

Manufacture Number 2 :

M.S.R.P 04/2010 :

Description: BRAKE PAD MADE IN JAPAN

Application 1 : HONDA ODYSSEY TL 95-98

Application 2 : ACURA VIGOR 92-94

Application 3 : CR-V CL 97-98

Application 4 : ACURA INTEGRA 3 DOOR TYPE R 98

Application 5 : HONDA PRELDUE

Application 6 : HONDA ACCORD

Application 7 : ACURA NSX

Application 8 : ACURA LEGEND RL

Application 9 :

Application 10 :

Application 11 :

Application 12 :

BRAKE PAD MADE IN JAPAN

ZOOM+

ZOOM-



PARTS IMAGE



BOX IMAGE

NPO-106W

Parts Number : NPO-106W

Manufacture 1 : NISSIN

Manufacturer Number 1 : 4F21P NKP10FF

Manufacture 2 :

Manufacture Number 2 :

M.S.R.P 04/2010 :

Description: BRAKE PAD MADE IN JAPAN

Application 1 : HONDA CIVIC WAGON 4WD 88-91

Application 2 : HONDA CRX SI 90-91

Application 3 : HONDA PRELUDE S 88-90

Application 4 :

Application 5 :

Application 6 :

Application 7 :

Application 8 :

Application 9 :

Application 10 :

Application 11 :

Application 12 :

BRAKE PAD MADE IN JAPAN

ZOOM+

ZOOM-



PARTS IMAGE



BOX IMAGE

NPO-108W

Parts Number : NPO-108W

Manufacture 1 : NISSIN

Manufacturer Number 1 : 0F24V NKP40CGC

Manufacture 2 :

Manufacture Number 2 :

M.S.R.P 04/2010 :

Description: BRAKE PAD MADE IN JAPAN

Application 1 :

Application 2 :

Application 3 :

Application 4 :

Application 5 :

Application 6 :

Application 7 :

Application 8 :

Application 9 :

Application 10 :

Application 11 :

Application 12 :

BRAKE PAD MADE IN JAPAN

ZOOM+

ZOOM-



PARTS IMAGE



BOX IMAGE

NPO-109

Parts Number :	NPO-109
Manufacture 1 :	NISSIN <input type="button" value="v"/>
Manufacturer Number 1 :	IL156A NKP40CGG
Manufacture 2 :	<input type="button" value="v"/>
Manufacturer Number 2 :	
M.S.R.P 04/2010 :	
Description:	BRAKE PAD MADE IN JAPAN

BRAKE PAD MADE IN JAPAN

ZOOM+ ZOOM-



PARTS IMAGE

- Application 1 : HONDA ACCORD COUPE 89
- Application 2 :
- Application 3 :
- Application 4 :
- Application 5 :
- Application 6 :
- Application 7 :
- Application 8 :
- Application 9 :
- Application 10 :
- Application 11 :
- Application 12 :



BOX IMAGE

NPO-112W

Parts Number : NPO-112W

Manufacture 1 : NISSIN

Manufacturer Number 1 : 9S28V NKP10FF

Manufacture 2 :

Manufacturer Number 2 :

M.S.R.P 04/2010 :

Description: BRAKE PAD MADE IN JAPAN

Application 1 : HONDA ACCORD COUPE 93-98

Application 2 : HONDA ACCORD SEDAN 94

Application 3 : HONDA ACCORD SEDAN 4CYCLE 95-98

Application 4 : HONDA ACCORD SEDAN 90-93

Application 5 : ACURA 2.3L 97-98

Application 6 :

Application 7 :

Application 8 :

Application 9 :

Application 10 :

Application 11 :

Application 12 :

BRAKE PAD MADE IN JAPAN

ZOOM+

ZOOM-



PARTS IMAGE



BOX IMAGE

NPO-113W

Parts Number : NPO-113W

Manufacture 1 : NISSIN

Manufacturer Number 1 : 0C30V NKP10FF

Manufacture 2 :

Manufacture Number 2 :

M.S.R.P 04/2010 :

Description: BRAKE PAD MADE IN JAPAN

Application 1 :

Application 2 :

Application 3 :

Application 4 :

Application 5 :

Application 6 :

Application 7 :

Application 8 :

Application 9 :

Application 10 :

Application 11 :

Application 12 :

BRAKE PAD MADE IN JAPAN

ZOOM+

ZOOM-



PARTS IMAGE



BOX IMAGE

NPO-115W

Parts Number : NPO-115W

Manufacture 1 : NISSIN

Manufacturer Number 1 : 8D11P NKP10FF

Manufacture 2 :

Manufacture Number 2 :

M.S.R.P 04/2010 :

Description: BRAKE PAD MADE IN JAPAN

Application 1 :

Application 2 :

Application 3 :

Application 4 :

Application 5 :

Application 6 :

Application 7 :

Application 8 :

Application 9 :

Application 10 :

Application 11 :

Application 12 :

BRAKE PAD MADE IN JAPAN

ZOOM+

ZOOM-



PARTS IMAGE



BOX IMAGE

NPO-123W

Parts Number : NPO-123W

Manufacture 1 : NISSIN

Manufacturer Number 1 : JE057 NKP10FF

Manufacture 2 :

Manufacture Number 2 :

M.S.R.P 04/2010 :

Description: BRAKE PAD MADE IN JAPAN

Application 1 :

Application 2 :

Application 3 :

Application 4 :

Application 5 :

Application 6 :

Application 7 :

Application 8 :

Application 9 :

Application 10 :

Application 11 :

Application 12 :

BRAKE PAD MADE IN JAPAN

ZOOM+

ZOOM-



PARTS IMAGE



BOX IMAGE

NPO-128W

Parts Number : NPO-128W

Manufacture 1 : NISSIN

Manufacturer Number 1 : JF123 NKP10FF

Manufacture 2 :

Manufacture Number 2 :

M.S.R.P 04/2010 :

Description: BRAKE PAD MADE IN JAPAN

Application 1 :

Application 2 :

Application 3 :

Application 4 :

Application 5 :

Application 6 :

Application 7 :

Application 8 :

Application 9 :

Application 10 :

Application 11 :

Application 12 :

BRAKE PAD MADE IN JAPAN

ZOOM+

ZOOM-



PARTS IMAGE



BOX IMAGE

NPO-129W

Parts Number : NPO-129W

Manufacture 1 : NISSIN

Manufacturer Number 1 : JE110 NKP40CGG

Manufacture 2 :

Manufacture Number 2 :

M.S.R.P 04/2010 :

Description: BRAKE PAD MADE IN JAPAN

Application 1 :

Application 2 :

Application 3 :

Application 4 :

Application 5 :

Application 6 :

Application 7 :

Application 8 :

Application 9 :

Application 10 :

Application 11 :

Application 12 :

BRAKE PAD MADE IN JAPAN

ZOOM+

ZOOM-



PARTS IMAGE



BOX IMAGE

NPO-133W

Parts Number : NPO-133W

Manufacture 1 : NISSIN

Manufacturer Number 1 : HC002 MKP1OFF

Manufacture 2 :

Manufacture Number 2 :

M.S.R.P 04/2010 :

Description: BRAKE PAD MADE IN JAPAN

Application 1 : HONDA CIVIC SI 2005

Application 2 : ACURA RSX 02-06

Application 3 :

Application 4 :

Application 5 :

Application 6 :

Application 7 :

Application 8 :

Application 9 :

Application 10 :

Application 11 :

Application 12 :

BRAKE PAD MADE IN JAPAN

ZOOM+

ZOOM-



PARTS IMAGE



BOX IMAGE

NPO-134W-SA

Parts Number : NPO-134W-SA

Manufacture 1 : NISSIN

Manufacturer Number 1 : JE011 NKP40CGG

Manufacture 2 :

Manufacture Number 2 :

M.S.R.P 04/2010 :

Description: BRAKE PAD MADE IN JAPAN WITH SIM (6PCS)

Application 1 :

Application 2 :

Application 3 :

Application 4 :

Application 5 :

Application 6 :

Application 7 :

Application 8 :

Application 9 :

Application 10 :

Application 11 :

Application 12 :

BRAKE PAD MADE IN JAPAN

ZOOM+

ZOOM-



PARTS IMAGE



BOX IMAGE

NPO-150W

Parts Number : NPO-150W

Manufacture 1 : NISSIN

Manufacturer Number 1 : 0B11V NK40CGG

Manufacture 2 :

Manufacture Number 2 :

M.S.R.P 04/2010 :

Description: BRAKE PAD MADE IN JAPAN

- Application 1 :
- Application 2 :
- Application 3 :
- Application 4 :
- Application 5 :
- Application 6 :
- Application 7 :
- Application 8 :
- Application 9 :
- Application 10 :
- Application 11 :
- Application 12 :

BRAKE PAD MADE IN JAPAN

ZOOM+ ZOOM-



PARTS IMAGE



BOX IMAGE

OPT-P011

OIL PUMP AISIN

Parts Number : OPT-P011

Manufacture 1 : AISIN

Manufacturer Number 1 : 15110-71010

Manufacture 2 :

Manufacturer Number 2 :

M.S.R.P 04/2010 :

Description: OIL PUMP AISIN
MADE IN JAPAN

Application 1 :

Application 2 :

Application 3 :

Application 4 :

Application 5 :

Application 6 :

Application 7 :

Application 8 :

Application 9 :

Application 10 :

Application 11 :

Application 12 :

ZOOM+

ZOOM-



PARTS IMAGE



BOX IMAGE

PB-1001

PILOT BEARING MADE IN

Parts Number : PB-1001

Manufacture 1 : NACHI

Manufacturer Number 1 : 6001-2NSE

Manufacture 2 :

Manufacture Number 2 :

M.S.R.P 04/2010 :

Description: PILOT BEARING MADE IN JAPAN

Application 1 :

Application 2 :

Application 3 :

Application 4 :

Application 5 :

Application 6 :

Application 7 :

Application 8 :

Application 9 :

Application 10 :

Application 11 :

Application 12 :

ZOOM+ ZOOM-



PARTS IMAGE



BOX IMAGE

PB-1002

PILOT BEARING MADE IN

Parts Number : PB-1002

Manufacture 1 : NACHI

Manufacturer Number 1 : 6002-2NSE

Manufacture 2 :

Manufacturer Number 2 :

M.S.R.P 04/2010 :

Description: PILOT BEARING MADE IN JAPAN

Application 1 :

Application 2 :

Application 3 :

Application 4 :

Application 5 :

Application 6 :

Application 7 :

Application 8 :

Application 9 :

Application 10 :

Application 11 :

Application 12 :

ZOOM+

ZOOM-



PARTS IMAGE



BOX IMAGE

PB-1003

PILOT BEARING MADE IN

Parts Number : PB-1003

Manufacture 1 : NACHI

Manufacturer Number 1 : 6200-2NSE

Manufacture 2 :

Manufacturer Number 2 :

M.S.R.P 04/2010 :

Description: PILOT BEARING MADE IN JAPAN

Application 1 :

Application 2 :

Application 3 :

Application 4 :

Application 5 :

Application 6 :

Application 7 :

Application 8 :

Application 9 :

Application 10 :

Application 11 :

Application 12 :

ZOOM+

ZOOM-



PARTS IMAGE



BOX IMAGE

PB-1004

Parts Number : PB-1004

Manufacture 1 : NACHI

Manufacturer Number 1 : 6201-2NSL

Manufacture 2 : NSK

Manufacturer Number 2 : 6201DDUCE

M.S.R.P 04/2010 :

Description: PILOT BEARING MADE IN JAPAN

PILOT BEARING MADE IN

ZOOM+

ZOOM-



PARTS IMAGE

Application 1 :

Application 2 :

Application 3 :

Application 4 :

Application 5 :

Application 6 :

Application 7 :

Application 8 :

Application 9 :

Application 10 :

Application 11 :

Application 12 :



BOX IMAGE

PB-1005

PILOT BEARING MADE IN

Parts Number : PB-1005

Manufacture 1 : NACHI

Manufacturer Number 1 : 6202-ZZE

Manufacture 2 :

Manufacture Number 2 :

M.S.R.P 04/2010 :

Description: PILOT BEARING MADE IN JAPAN

Application 1 :

Application 2 :

Application 3 :

Application 4 :

Application 5 :

Application 6 :

Application 7 :

Application 8 :

Application 9 :

Application 10 :

Application 11 :

Application 12 :

ZOOM+

ZOOM-



PARTS IMAGE



BOX IMAGE

PB-1005X

PILOT BEARING MADE IN

Parts Number : PB-1005X

Manufacture 1 : NACHI

Manufacturer Number 1 : 6202-2NSE

Manufacture 2 :

Manufacturer Number 2 :

M.S.R.P 04/2010 :

Description: PILOT BEARING MADE IN JAPAN

Application 1 :

Application 2 :

Application 3 :

Application 4 :

Application 5 :

Application 6 :

Application 7 :

Application 8 :

Application 9 :

Application 10 :

Application 11 :

Application 12 :

ZOOM+

ZOOM-



PARTS IMAGE



BOX IMAGE

PB-1006

PILOT BEARING MADE IN

Parts Number : PB-1006

Manufacture 1 : NACHI

Manufacturer Number 1 : 6203-2NSE

Manufacture 2 :

Manufacturer Number 2 :

M.S.R.P 04/2010 :

Description: PILOT BEARING MADE IN JAPAN

Application 1 :

Application 2 :

Application 3 :

Application 4 :

Application 5 :

Application 6 :

Application 7 :

Application 8 :

Application 9 :

Application 10 :

Application 11 :

Application 12 :

ZOOM+

ZOOM-



PARTS IMAGE



BOX IMAGE

PB-1007

PILOT BEARING MADE IN

Parts Number : PB-1007

Manufacture 1 : NTN

Manufacturer Number 1 : 6205DDUC3E

Manufacture 2 :

Manufacture Number 2 :

M.S.R.P 04/2010 :

Description: PILOT BEARING MADE IN JAPAN

Application 1 :

Application 2 :

Application 3 :

Application 4 :

Application 5 :

Application 6 :

Application 7 :

Application 8 :

Application 9 :

Application 10 :

Application 11 :

Application 12 :

ZOOM+ ZOOM-



PARTS IMAGE



BOX IMAGE

PB-1008

PILOT BEARING MADE IN

Parts Number : PB-1008

Manufacture 1 : NTN

Manufacturer Number 1 : HK121PX5

Manufacture 2 :

Manufacture Number 2 :

M.S.R.P 04/2010 :

Description: PILOT BEARING MADE IN JAPAN

Application 1 :

Application 2 :

Application 3 :

Application 4 :

Application 5 :

Application 6 :

Application 7 :

Application 8 :

Application 9 :

Application 10 :

Application 11 :

Application 12 :

ZOOM+

ZOOM-

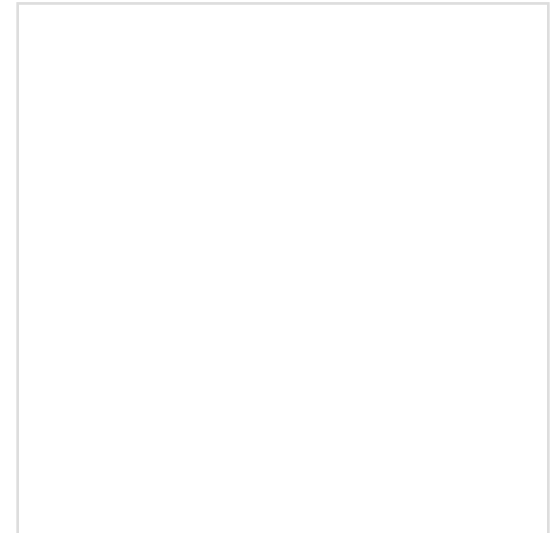

PARTS IMAGE

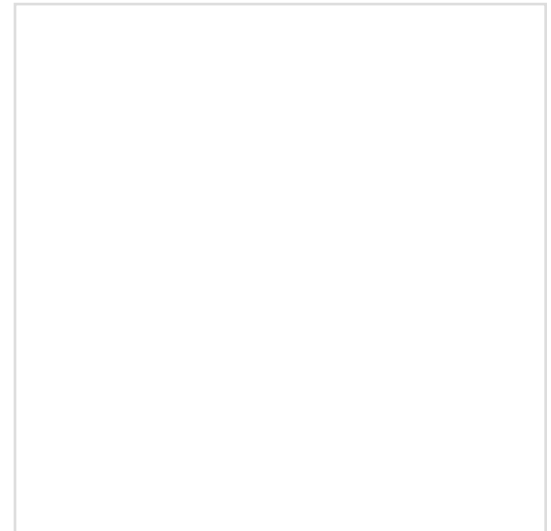

BOX IMAGE

PB-1009

PILOT BEARING MADE IN

Parts Number : PB-1009

Manufacture 1 : NACHI

Manufacturer Number 1 : 12BC03SNK

Manufacture 2 :

Manufacture Number 2 :

M.S.R.P 04/2010 :

Description: PILOT BEARING MADE IN JAPAN

Application 1 :

Application 2 :

Application 3 :

Application 4 :

Application 5 :

Application 6 :

Application 7 :

Application 8 :

Application 9 :

Application 10 :

Application 11 :

Application 12 :

ZOOM+

ZOOM-



PARTS IMAGE

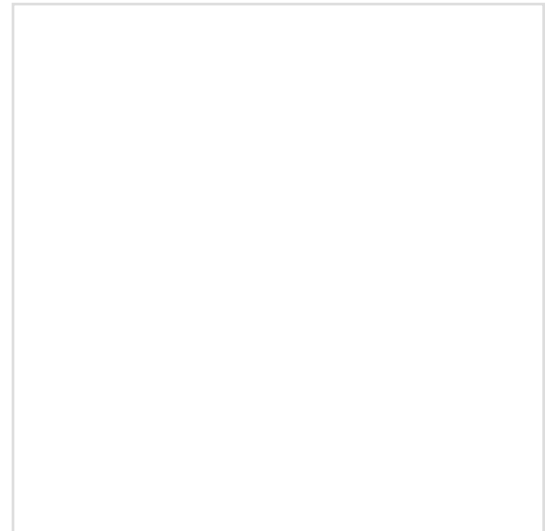

BOX IMAGE

PB-1010

PILOT BEARING MADE IN

Parts Number : PB-1010

Manufacture 1 : NACHI

Manufacturer Number 1 : 10BC02S4NK

Manufacture 2 :

Manufacture Number 2 :

M.S.R.P 04/2010 :

Description: PILOT BEARING MADE IN JAPAN

Application 1 :

Application 2 :

Application 3 :

Application 4 :

Application 5 :

Application 6 :

Application 7 :

Application 8 :

Application 9 :

Application 10 :

Application 11 :

Application 12 :

ZOOM+

ZOOM-



PARTS IMAGE

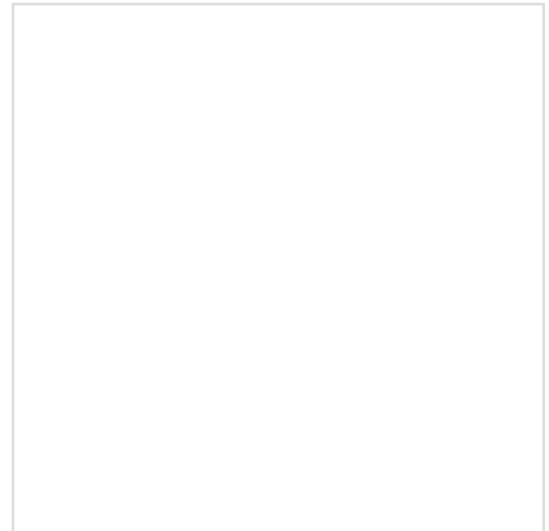

BOX IMAGE

PB-1011

PILOT BEARING MADE IN

Parts Number : PB-1011

Manufacture 1 : NSK

Manufacturer Number 1 : B17-114DDWAXC4

Manufacture 2 :

Manufacturer Number 2 :

M.S.R.P 04/2010 :

Description: PILOT BEARING MADE IN JAPAN

Application 1 :

Application 2 :

Application 3 :

Application 4 :

Application 5 :

Application 6 :

Application 7 :

Application 8 :

Application 9 :

Application 10 :

Application 11 :

Application 12 :

ZOOM+ ZOOM-



PARTS IMAGE



BOX IMAGE

PB-1012

PILOT BUSH MADE IN JAPAN

Parts Number : PB-1012

Manufacture 1 :

Manufacturer Number 1 : 32202-30000

Manufacture 2 : MITOYO KOGYO

Manufacture Number 2 :

M.S.R.P 04/2010 :

Description: PILOT BUSH MADE IN JAPAN
BULK

Application 1 :

Application 2 :

Application 3 :

Application 4 :

Application 5 :

Application 6 :

Application 7 :

Application 8 :

Application 9 :

Application 10 :

Application 11 :

Application 12 :

ZOOM+

ZOOM-



PARTS IMAGE



BOX IMAGE

PB-1013

PILOT BEARING MADE IN

Parts Number : PB-1013

Manufacture 1 :

Manufacturer Number 1 : 15BTM2016C-2

Manufacture 2 :

Manufacturer Number 2 :

M.S.R.P 04/2010 :

Description: PILOT BEARING MADE IN JAPAN

Application 1 :

Application 2 :

Application 3 :

Application 4 :

Application 5 :

Application 6 :

Application 7 :

Application 8 :

Application 9 :

Application 10 :

Application 11 :

Application 12 :

ZOOM+

ZOOM-

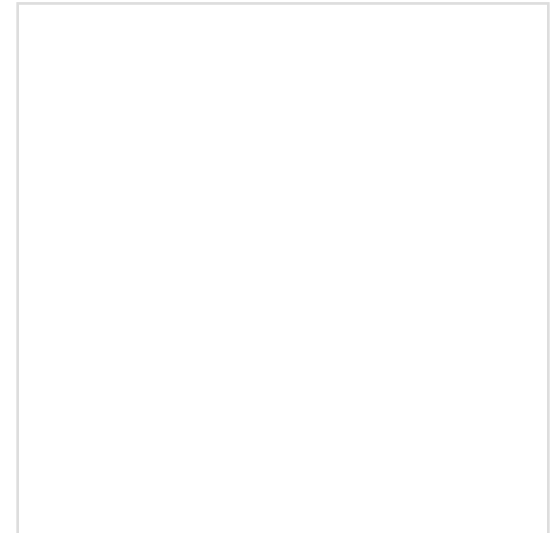

PARTS IMAGE

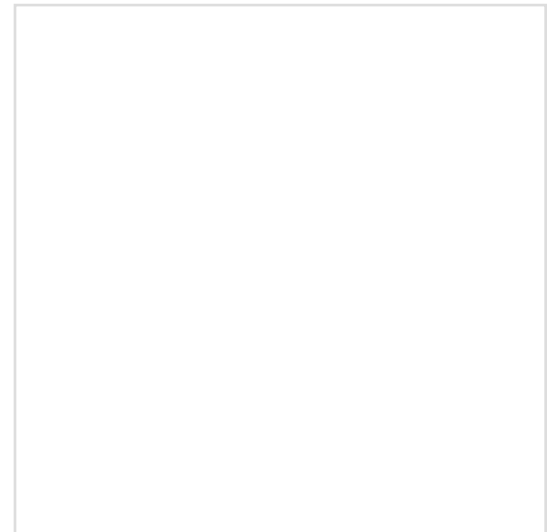

BOX IMAGE

PB-1014

PILOT BEARING MADE IN

Parts Number : PB-1014

Manufacture 1 :

Manufacturer Number 1 : 9-94129-827-0

Manufacture 2 :

Manufacture Number 2 :

M.S.R.P 04/2010 :

Description: PILOT BEARING MADE IN JAPAN

Application 1 :

Application 2 :

Application 3 :

Application 4 :

Application 5 :

Application 6 :

Application 7 :

Application 8 :

Application 9 :

Application 10 :

Application 11 :

Application 12 :

ZOOM+

ZOOM-



PARTS IMAGE

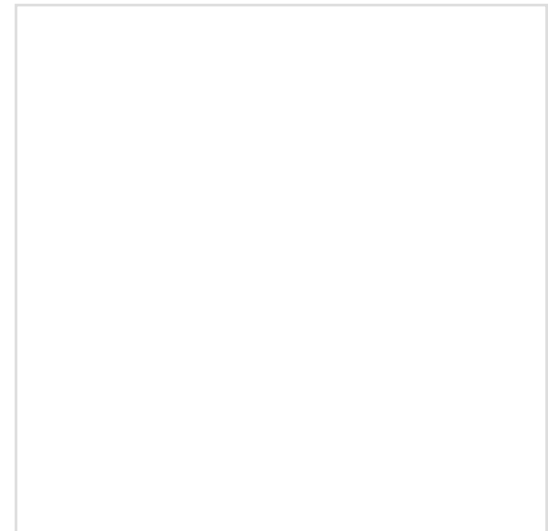

BOX IMAGE

PB-1015

PILOT BEARING MADE IN

Parts Number : PB-1015

Manufacture 1 :

Manufacturer Number 1 : 32202-18000

Manufacture 2 :

Manufacture Number 2 :

M.S.R.P 04/2010 :

Description: PILOT BEARING MADE IN JAPAN

Application 1 :

Application 2 :

Application 3 :

Application 4 :

Application 5 :

Application 6 :

Application 7 :

Application 8 :

Application 9 :

Application 10 :

Application 11 :

Application 12 :

ZOOM+

ZOOM-

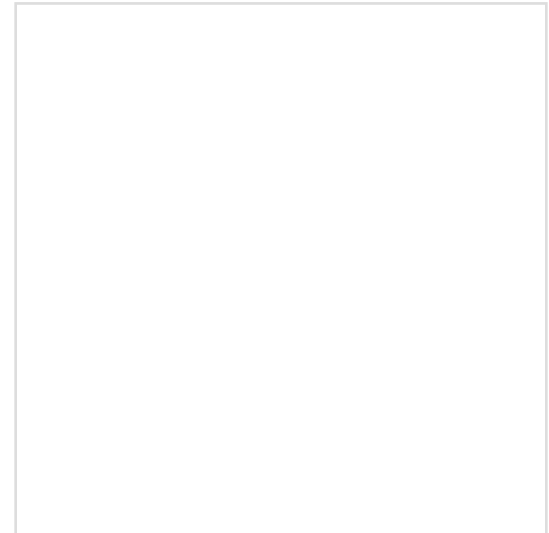

PARTS IMAGE

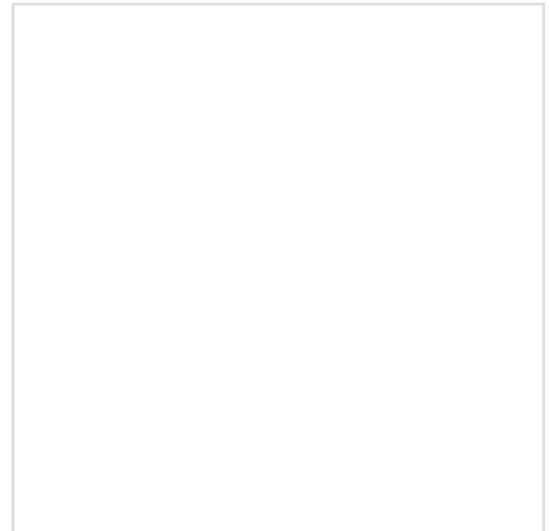

BOX IMAGE

PB-1016

PILOT BEARING MADE IN

Parts Number : PB-1016

Manufacture 1 : NACHI

Manufacturer Number 1 : 6904-2NSE

Manufacture 2 :

Manufacture Number 2 :

M.S.R.P 04/2010 :

Description: PILOT BEARING MADE IN JAPAN

Application 1 :

Application 2 :

Application 3 :

Application 4 :

Application 5 :

Application 6 :

Application 7 :

Application 8 :

Application 9 :

Application 10 :

Application 11 :

Application 12 :

ZOOM+

ZOOM-



PARTS IMAGE



BOX IMAGE

PB-1017

PILOT BEARING MADE IN

Parts Number : PB-1017

Manufacture 1 : NACHI

Manufacturer Number 1 : 6006NR

Manufacture 2 :

Manufacturer Number 2 :

M.S.R.P 04/2010 :

Description: PILOT BEARING MADE IN JAPAN

Application 1 :

Application 2 :

Application 3 :

Application 4 :

Application 5 :

Application 6 :

Application 7 :

Application 8 :

Application 9 :

Application 10 :

Application 11 :

Application 12 :

ZOOM+

ZOOM-



PARTS IMAGE



BOX IMAGE

PB-1019

PILOT BEARING MADE IN

Parts Number : PB-1019

Manufacture 1 : NSK

Manufacturer Number 1 : 6305-VV

Manufacture 2 :

Manufacture Number 2 :

M.S.R.P 04/2010 :

Description: PILOT BEARING MADE IN JAPAN

Application 1 :

Application 2 :

Application 3 :

Application 4 :

Application 5 :

Application 6 :

Application 7 :

Application 8 :

Application 9 :

Application 10 :

Application 11 :

Application 12 :

ZOOM+

ZOOM-



PARTS IMAGE

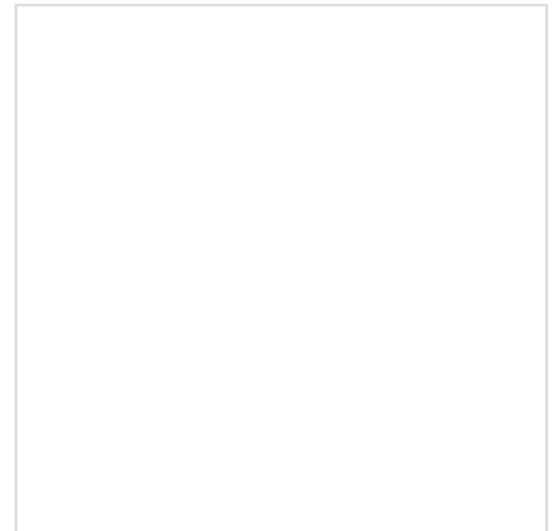

BOX IMAGE

PB-1020

PILOT BEARING MADE IN

Parts Number : PB-1020

Manufacture 1 : NACHI

Manufacturer Number 1 : 6005-2NSL

Manufacture 2 :

Manufacture Number 2 :

M.S.R.P 04/2010 :

Description: PILOT BEARING MADE IN JAPAN

Application 1 :

Application 2 :

Application 3 :

Application 4 :

Application 5 :

Application 6 :

Application 7 :

Application 8 :

Application 9 :

Application 10 :

Application 11 :

Application 12 :

ZOOM+

ZOOM-



PARTS IMAGE



BOX IMAGE

PB-1021

PILOT BEARING MADE IN

Parts Number : PB-1021

Manufacture 1 : NACHI

Manufacturer Number 1 : 6303-2NSL

Manufacture 2 :

Manufacture Number 2 :

M.S.R.P 04/2010 :

Description: PILOT BEARING MADE IN JAPAN

Application 1 :

Application 2 :

Application 3 :

Application 4 :

Application 5 :

Application 6 :

Application 7 :

Application 8 :

Application 9 :

Application 10 :

Application 11 :

Application 12 :

ZOOM+

ZOOM-



PARTS IMAGE

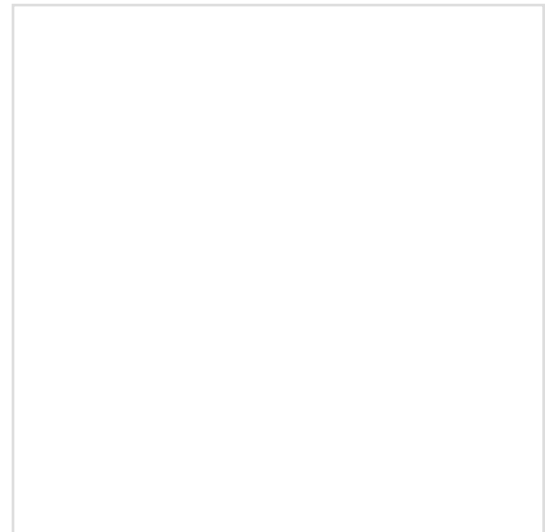

BOX IMAGE

PB-1022

PILOT BEARING MADE IN

Parts Number : PB-1022

Manufacture 1 : NACHI

Manufacturer Number 1 : 6306-2NSL

Manufacture 2 : NSK

Manufacturer Number 2 : 6306DDUCE

M.S.R.P 04/2010 :

Description: PILOT BEARING MADE IN JAPAN

Application 1 :

Application 2 :

Application 3 :

Application 4 :

Application 5 :

Application 6 :

Application 7 :

Application 8 :

Application 9 :

Application 10 :

Application 11 :

Application 12 :

ZOOM+

ZOOM-



PARTS IMAGE



BOX IMAGE

PB-1023

PILOT BEARING MADE IN

Parts Number : PB-1023

Manufacture 1 : NACHI

Manufacturer Number 1 : 6204-2NSL

Manufacture 2 :

Manufacture Number 2 :

M.S.R.P 04/2010 :

Description: PILOT BEARING MADE IN JAPAN

Application 1 :

Application 2 :

Application 3 :

Application 4 :

Application 5 :

Application 6 :

Application 7 :

Application 8 :

Application 9 :

Application 10 :

Application 11 :

Application 12 :

ZOOM+

ZOOM-



PARTS IMAGE

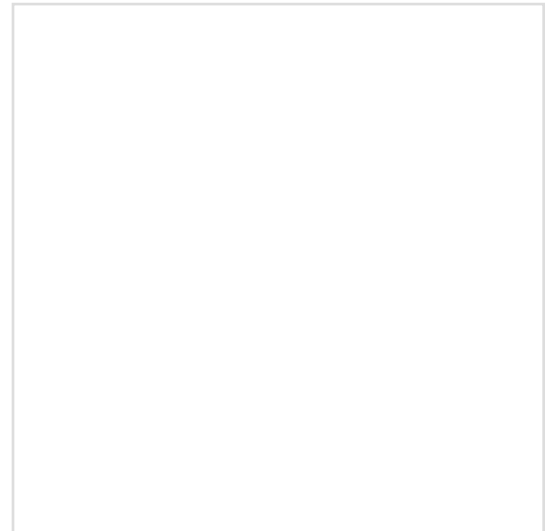

BOX IMAGE

PB-1029

PILOT BEARING MADE IN

Parts Number : PB-1029

Manufacture 1 : NACHI

Manufacturer Number 1 : 6301-2NSE

Manufacture 2 :

Manufacturer Number 2 :

M.S.R.P 04/2010 :

Description: PILOT BEARING MADE IN JAPAN

Application 1 :

Application 2 :

Application 3 :

Application 4 :

Application 5 :

Application 6 :

Application 7 :

Application 8 :

Application 9 :

Application 10 :

Application 11 :

Application 12 :

ZOOM+

ZOOM-

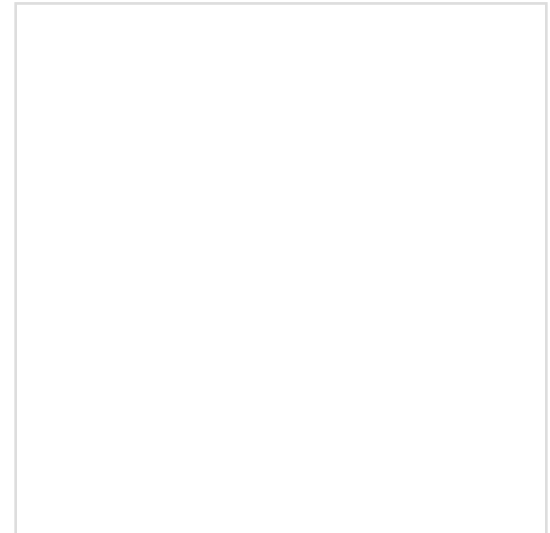

PARTS IMAGE

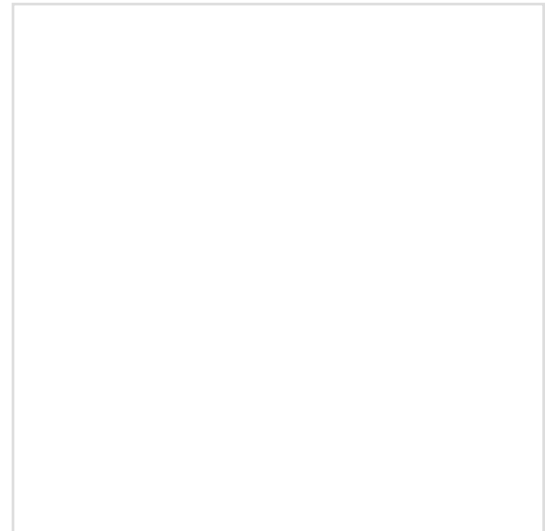

BOX IMAGE

RB-0101

CLUTCH BEARING MADE IN

Parts Number : RB-0101

Manufacture 1 : NSK

Manufacturer Number 1 : TK40-1B2

Manufacture 2 :

Manufacture Number 2 :

M.S.R.P 04/2010 :

Description: CLUTCH BEARING MADE IN JAPAN

Application 1 :

Application 2 :

Application 3 :

Application 4 :

Application 5 :

Application 6 :

Application 7 :

Application 8 :

Application 9 :

Application 10 :

Application 11 :

Application 12 :

ZOOM+ ZOOM-



PARTS IMAGE



BOX IMAGE

RB-0102

CLUTCH BEARING MADE IN

Parts Number : RB-0102

Manufacture 1 : NSK

Manufacturer Number 1 : TK40-4A

Manufacture 2 :

Manufacture Number 2 :

M.S.R.P 04/2010 :

Description: CLUTCH BEARING MADE IN JAPAN

Application 1 :

Application 2 :

Application 3 :

Application 4 :

Application 5 :

Application 6 :

Application 7 :

Application 8 :

Application 9 :

Application 10 :

Application 11 :

Application 12 :

ZOOM+ ZOOM-



PARTS IMAGE



BOX IMAGE

RB-0103

CLUTCH BEARING MADE IN

Parts Number : RB-0103

Manufacture 1 :

Manufacturer Number 1 :

Manufacture 2 :

Manufacturer Number 2 :

M.S.R.P 04/2010 :

Description:

RB-0103

CLUTCH BEARING MADE IN JAPAN

Application 1 :

Application 2 :

Application 3 :

Application 4 :

Application 5 :

Application 6 :

Application 7 :

Application 8 :

Application 9 :

Application 10 :

Application 11 :

Application 12 :

ZOOM+

ZOOM-

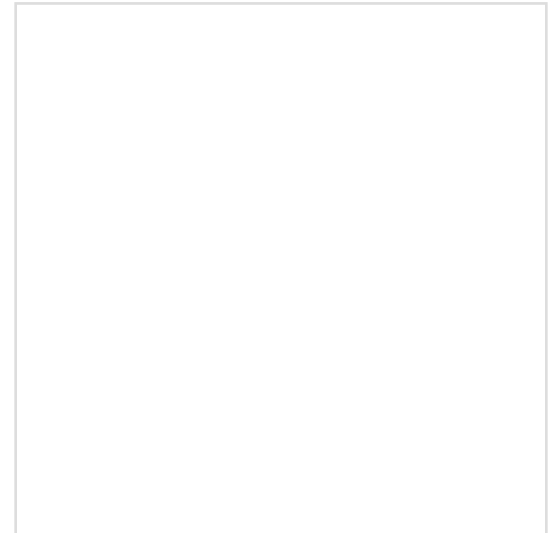

PARTS IMAGE

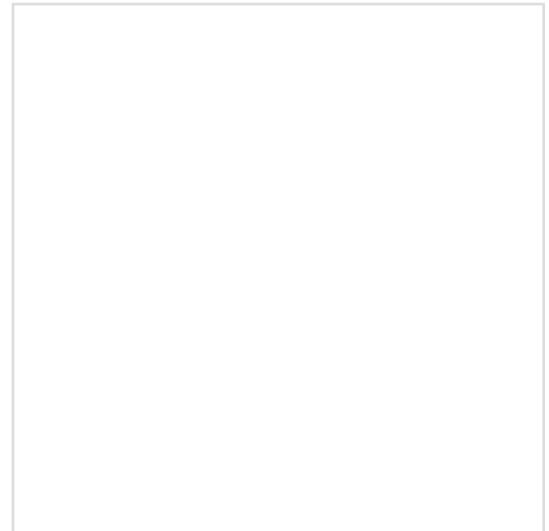

BOX IMAGE

RB-0104

CLUTCH BEARING MADE IN

Parts Number : RB-0104

Manufacture 1 :

Manufacturer Number 1 :

763

Manufacture 2 :

Manufacture Number 2 :

M.S.R.P 04/2010 :

Description:

CLUTCH BEARING MADE IN JAPAN

Application 1 :

Application 2 :

Application 3 :

Application 4 :

Application 5 :

Application 6 :

Application 7 :

Application 8 :

Application 9 :

Application 10 :

Application 11 :

Application 12 :

ZOOM+

ZOOM-

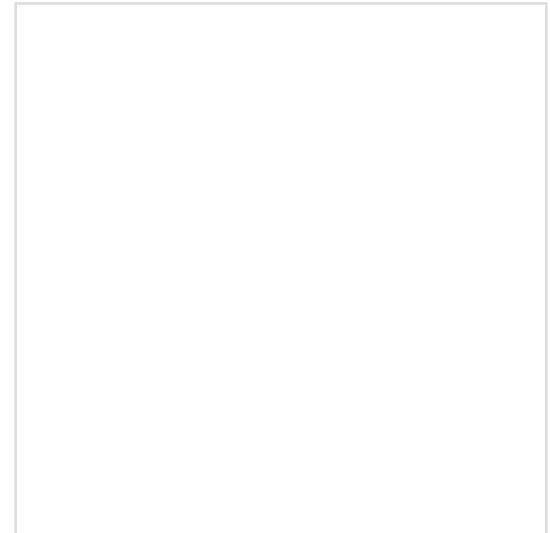

PARTS IMAGE

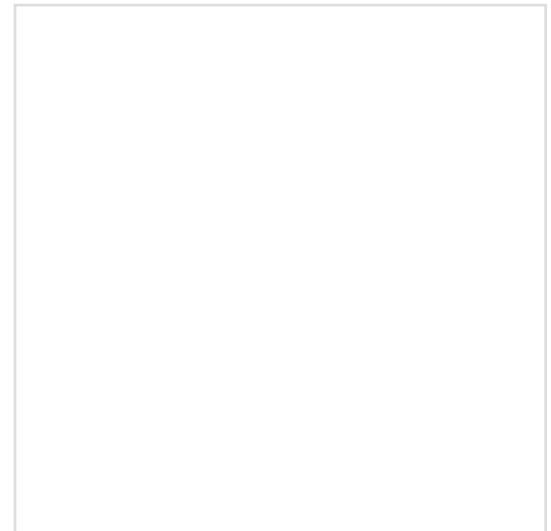

BOX IMAGE

RB-0105

CLUTCH BEARING MADE IN

Parts Number : RB-0105

Manufacture 1 :

Manufacturer Number 1 :

764

Manufacture 2 :

Manufacturer Number 2 :

M.S.R.P 04/2010 :

Description:

CLUTCH BEARING MADE IN JAPAN

Application 1 :

Application 2 :

Application 3 :

Application 4 :

Application 5 :

Application 6 :

Application 7 :

Application 8 :

Application 9 :

Application 10 :

Application 11 :

Application 12 :

ZOOM+

ZOOM-

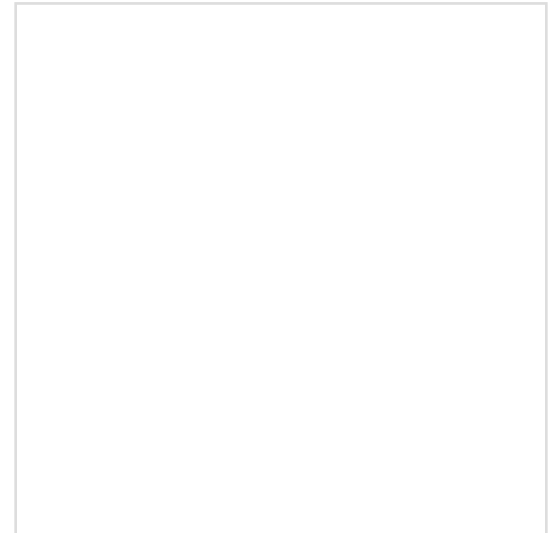

PARTS IMAGE

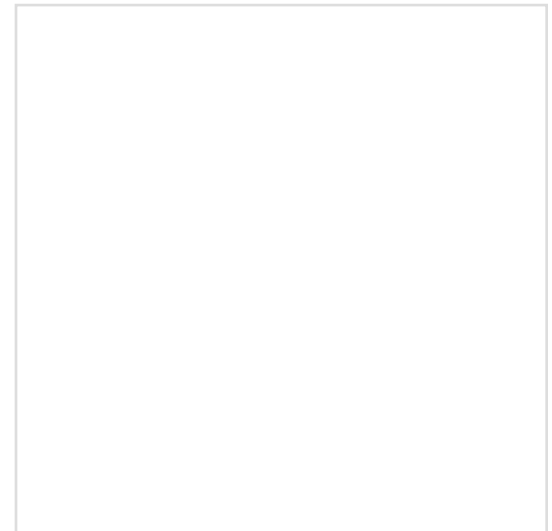

BOX IMAGE

RB-0106

CLUTCH BEARING MADE IN

Parts Number : RB-0106

Manufacture 1 : NSK

Manufacturer Number 1 : 48TKB3302A

Manufacture 2 :

Manufacturer Number 2 :

M.S.R.P 04/2010 :

Description: CLUTCH BEARING MADE IN JAPAN

Application 1 :

Application 2 :

Application 3 :

Application 4 :

Application 5 :

Application 6 :

Application 7 :

Application 8 :

Application 9 :

Application 10 :

Application 11 :

Application 12 :

ZOOM+

ZOOM-



PARTS IMAGE



BOX IMAGE

RB-0107

CLUTCH BEARING MADE IN

Parts Number : RB-0107

Manufacture 1 : NTN

Manufacturer Number 1 : FCR62-28-712E

Manufacture 2 :

Manufacturer Number 2 :

M.S.R.P 04/2010 :

Description: CLUTCH BEARING MADE IN JAPAN

Application 1 :

Application 2 :

Application 3 :

Application 4 :

Application 5 :

Application 6 :

Application 7 :

Application 8 :

Application 9 :

Application 10 :

Application 11 :

Application 12 :

ZOOM+

ZOOM-



PARTS IMAGE



BOX IMAGE

RB-0110

CLUTCH BEARING MADE IN

Parts Number : RB-0110

Manufacture 1 : NTN

Manufacturer Number 1 : FCR62-32-15/2E

Manufacture 2 :

Manufacture Number 2 :

M.S.R.P 04/2010 :

Description: CLUTCH BEARING MADE IN JAPAN

Application 1 :

Application 2 :

Application 3 :

Application 4 :

Application 5 :

Application 6 :

Application 7 :

Application 8 :

Application 9 :

Application 10 :

Application 11 :

Application 12 :

ZOOM+ ZOOM-



PARTS IMAGE



BOX IMAGE

RB-0111

CLUTCH BEARING MADE IN

Parts Number : RB-0111

Manufacture 1 : KOYO

Manufacturer Number 1 : RCT40SA3

Manufacture 2 :

Manufacturer Number 2 :

M.S.R.P 04/2010 :

Description: CLUTCH BEARING MADE IN JAPAN

Application 1 :

Application 2 :

Application 3 :

Application 4 :

Application 5 :

Application 6 :

Application 7 :

Application 8 :

Application 9 :

Application 10 :

Application 11 :

Application 12 :

ZOOM+

ZOOM-



PARTS IMAGE



BOX IMAGE

RB-0112

CLUTCH BEARING MADE IN

Parts Number : RB-0112

Manufacture 1 : NTN

Manufacturer Number 1 : FCR62-29-11/2E

Manufacture 2 :

Manufacturer Number 2 :

M.S.R.P 04/2010 :

Description: CLUTCH BEARING MADE IN JAPAN

Application 1 :

Application 2 :

Application 3 :

Application 4 :

Application 5 :

Application 6 :

Application 7 :

Application 8 :

Application 9 :

Application 10 :

Application 11 :

Application 12 :

ZOOM+

ZOOM-



PARTS IMAGE



BOX IMAGE

RB-0113

CLUTCH BEARING MADE IN

Parts Number : RB-0113

Manufacture 1 : NTN

Manufacturer Number 1 : FCR48-24-5/2E

Manufacture 2 :

Manufacturer Number 2 :

M.S.R.P 04/2010 :

Description: CLUTCH BEARING MADE IN JAPAN

Application 1 :

Application 2 :

Application 3 :

Application 4 :

Application 5 :

Application 6 :

Application 7 :

Application 8 :

Application 9 :

Application 10 :

Application 11 :

Application 12 :

ZOOM+

ZOOM-



PARTS IMAGE



BOX IMAGE

RB-0115

CLUTCH BEARING MADE IN

Parts Number : RB-0115

Manufacture 1 : NTN

Manufacturer Number 1 : FCR62-30-6/2E

Manufacture 2 :

Manufacturer Number 2 :

M.S.R.P 04/2010 :

Description: CLUTCH BEARING MADE IN JAPAN

Application 1 :

Application 2 :

Application 3 :

Application 4 :

Application 5 :

Application 6 :

Application 7 :

Application 8 :

Application 9 :

Application 10 :

Application 11 :

Application 12 :

ZOOM+

ZOOM-



PARTS IMAGE



BOX IMAGE

RB-0116

CLUTCH BEARING MADE IN

Parts Number : RB-0116

Manufacture 1 :

Manufacturer Number 1 :

772

Manufacture 2 :

Manufacture Number 2 :

M.S.R.P 04/2010 :

Description:

CLUTCH BEARING MADE IN JAPAN

Application 1 :

Application 2 :

Application 3 :

Application 4 :

Application 5 :

Application 6 :

Application 7 :

Application 8 :

Application 9 :

Application 10 :

Application 11 :

Application 12 :

ZOOM+

ZOOM-

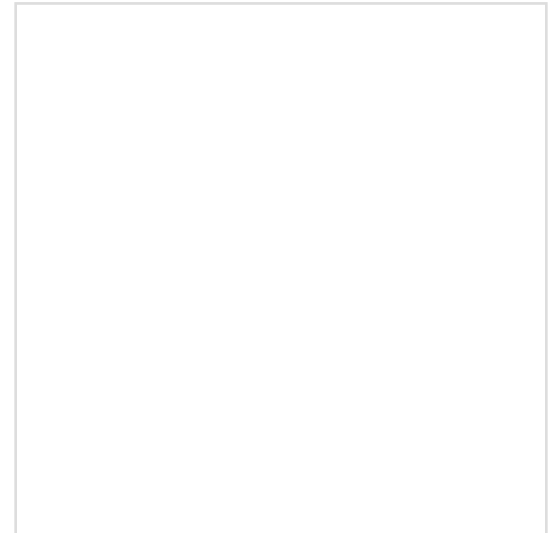

PARTS IMAGE

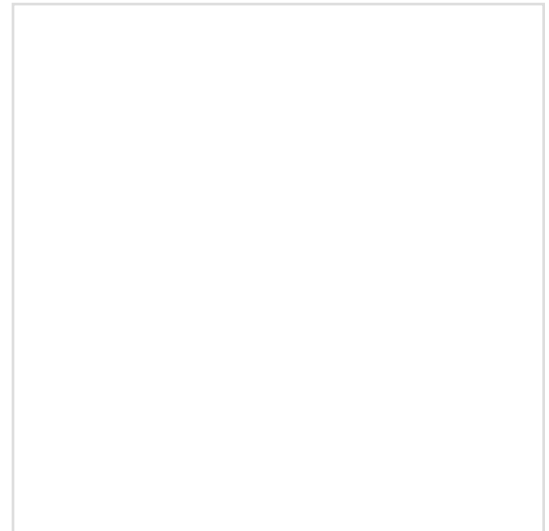

BOX IMAGE

RB-0117

CLUTCH BEARING MADE IN

Parts Number : RB-0117

Manufacture 1 : KOYO

Manufacturer Number 1 : RCT4000SA

Manufacture 2 :

Manufacturer Number 2 :

M.S.R.P 04/2010 :

Description: CLUTCH BEARING MADE IN JAPAN

Application 1 :

Application 2 :

Application 3 :

Application 4 :

Application 5 :

Application 6 :

Application 7 :

Application 8 :

Application 9 :

Application 10 :

Application 11 :

Application 12 :

ZOOM+

ZOOM-



PARTS IMAGE

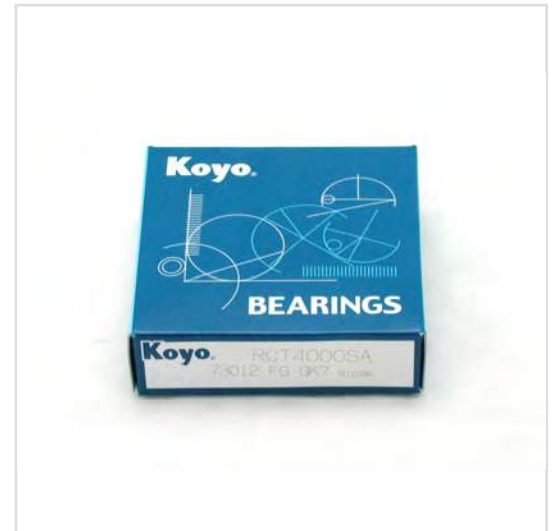

BOX IMAGE

RB-0201

CLUTCH BEARING MADE IN

Parts Number : RB-0201

Manufacture 1 : NSK

Manufacturer Number 1 : 40TKD01

Manufacture 2 :

Manufacture Number 2 :

M.S.R.P 04/2010 :

Description: CLUTCH BEARING MADE IN JAPAN

Application 1 :

Application 2 :

Application 3 :

Application 4 :

Application 5 :

Application 6 :

Application 7 :

Application 8 :

Application 9 :

Application 10 :

Application 11 :

Application 12 :

ZOOM+ ZOOM-



PARTS IMAGE



BOX IMAGE

RB-0202

CLUTCH BEARING MADE IN

Parts Number : RB-0202

Manufacture 1 : NACHI

Manufacturer Number 1 : 45TNK804

Manufacture 2 :

Manufacture Number 2 :

M.S.R.P 04/2010 :

Description: CLUTCH BEARING MADE IN JAPAN

Application 1 :

Application 2 :

Application 3 :

Application 4 :

Application 5 :

Application 6 :

Application 7 :

Application 8 :

Application 9 :

Application 10 :

Application 11 :

Application 12 :

ZOOM+

ZOOM-



PARTS IMAGE



BOX IMAGE

RB-0203

CLUTCH BEARING MADE IN

Parts Number : RB-0203

Manufacture 1 : KOYO

Manufacturer Number 1 : RCT52S

Manufacture 2 :

Manufacture Number 2 :

M.S.R.P 04/2010 :

Description: CLUTCH BEARING MADE IN JAPAN

Application 1 :

Application 2 :

Application 3 :

Application 4 :

Application 5 :

Application 6 :

Application 7 :

Application 8 :

Application 9 :

Application 10 :

Application 11 :

Application 12 :

ZOOM+ ZOOM-



PARTS IMAGE



BOX IMAGE

RB-0204

CLUTCH BEARING MADE IN

Parts Number : RB-0204

Manufacture 1 : NACHI

Manufacturer Number 1 : 40TRX30W2SB

Manufacture 2 :

Manufacturer Number 2 :

M.S.R.P 04/2010 :

Description: CLUTCH BEARING MADE IN JAPAN

Application 1 :

Application 2 :

Application 3 :

Application 4 :

Application 5 :

Application 6 :

Application 7 :

Application 8 :

Application 9 :

Application 10 :

Application 11 :

Application 12 :

ZOOM+

ZOOM-



PARTS IMAGE



BOX IMAGE

RB-0205

CLUTCH BEARING MADE IN

Parts Number : RB-0205

Manufacture 1 : KOYO

Manufacturer Number 1 : RCT40

Manufacture 2 :

Manufacture Number 2 :

M.S.R.P 04/2010 :

Description: CLUTCH BEARING MADE IN JAPAN

Application 1 :

Application 2 :

Application 3 :

Application 4 :

Application 5 :

Application 6 :

Application 7 :

Application 8 :

Application 9 :

Application 10 :

Application 11 :

Application 12 :

ZOOM+

ZOOM-



PARTS IMAGE



BOX IMAGE

RB-0206

CLUTCH BEARING MADE IN

Parts Number : RB-0206

Manufacture 1 : NSK

Manufacturer Number 1 : 33TKD03ENC5

Manufacture 2 :

Manufacture Number 2 :

M.S.R.P 04/2010 :

Description: CLUTCH BEARING MADE IN JAPAN

Application 1 :

Application 2 :

Application 3 :

Application 4 :

Application 5 :

Application 6 :

Application 7 :

Application 8 :

Application 9 :

Application 10 :

Application 11 :

Application 12 :

ZOOM+

ZOOM-



PARTS IMAGE



BOX IMAGE

RB-0207

CLUTCH BEARING MADE IN

Parts Number : RB-0207

Manufacture 1 :

Manufacturer Number 1 :

779

Manufacture 2 :

Manufacturer Number 2 :

M.S.R.P 04/2010 :

Description:

CLUTCH BEARING MADE IN JAPAN

Application 1 :

Application 2 :

Application 3 :

Application 4 :

Application 5 :

Application 6 :

Application 7 :

Application 8 :

Application 9 :

Application 10 :

Application 11 :

Application 12 :

ZOOM+

ZOOM-

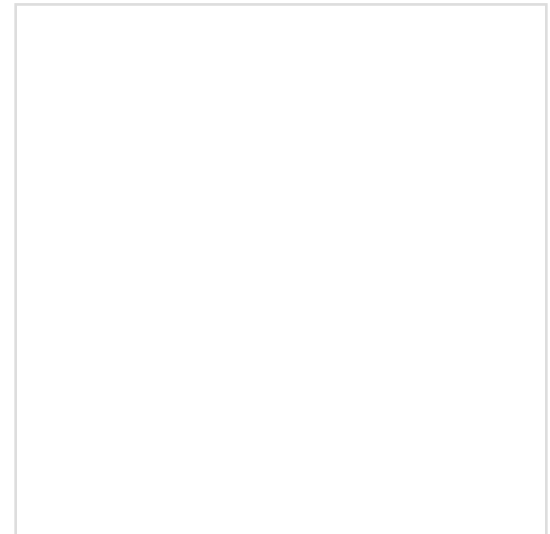

PARTS IMAGE

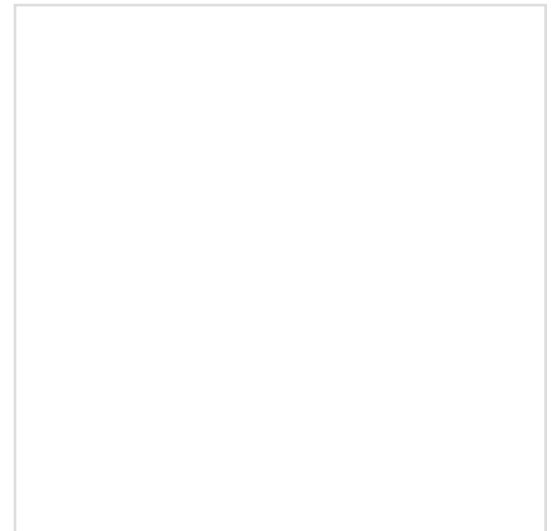

BOX IMAGE

RB-0208

CLUTCH BEARING MADE IN

Parts Number : RB-0208

Manufacture 1 : NSK

Manufacturer Number 1 : 50TKX3305R

Manufacture 2 :

Manufacturer Number 2 :

M.S.R.P 04/2010 :

Description: CLUTCH BEARING MADE IN JAPAN

Application 1 :

Application 2 :

Application 3 :

Application 4 :

Application 5 :

Application 6 :

Application 7 :

Application 8 :

Application 9 :

Application 10 :

Application 11 :

Application 12 :

ZOOM+

ZOOM-



PARTS IMAGE



BOX IMAGE

RB-0209

CLUTCH BEARING MADE IN

Parts Number : RB-0209

Manufacture 1 : NACHI

Manufacturer Number 1 : 80TCRG020-4

Manufacture 2 :

Manufacture Number 2 :

M.S.R.P 04/2010 :

Description: CLUTCH BEARING MADE IN JAPAN

Application 1 :

Application 2 :

Application 3 :

Application 4 :

Application 5 :

Application 6 :

Application 7 :

Application 8 :

Application 9 :

Application 10 :

Application 11 :

Application 12 :

ZOOM+

ZOOM-



PARTS IMAGE



BOX IMAGE

RB-0210

CLUTCH BEARING MADE IN

Parts Number : RB-0210

Manufacture 1 : NACHI

Manufacturer Number 1 : 50SCRN40P-8

Manufacture 2 :

Manufacture Number 2 :

M.S.R.P 04/2010 :

Description: CLUTCH BEARING MADE IN JAPAN

Application 1 :

Application 2 :

Application 3 :

Application 4 :

Application 5 :

Application 6 :

Application 7 :

Application 8 :

Application 9 :

Application 10 :

Application 11 :

Application 12 :

ZOOM+ ZOOM-



PARTS IMAGE



BOX IMAGE

RB-0211

CLUTCH BEARING MADE IN

Parts Number : RB-0211

Manufacture 1 : NACHI

Manufacturer Number 1 : 60SCRN31P-6

Manufacture 2 :

Manufacture Number 2 :

M.S.R.P 04/2010 :

Description: CLUTCH BEARING MADE IN JAPAN

Application 1 :

Application 2 :

Application 3 :

Application 4 :

Application 5 :

Application 6 :

Application 7 :

Application 8 :

Application 9 :

Application 10 :

Application 11 :

Application 12 :

ZOOM+ ZOOM-



PARTS IMAGE



BOX IMAGE

RB-0212

CLUTCH BEARING MADE IN

Parts Number : RB-0212

Manufacture 1 : NACHI

Manufacturer Number 1 : 50SCRN31P-4B

Manufacture 2 :

Manufacturer Number 2 :

M.S.R.P 04/2010 :

Description: CLUTCH BEARING MADE IN JAPAN

Application 1 :

Application 2 :

Application 3 :

Application 4 :

Application 5 :

Application 6 :

Application 7 :

Application 8 :

Application 9 :

Application 10 :

Application 11 :

Application 12 :

ZOOM+

ZOOM-



PARTS IMAGE



BOX IMAGE

RB-0213

CLUTCH BEARING MADE IN

Parts Number : RB-0213

Manufacture 1 : NSK

Manufacturer Number 1 : 50TKB3504B1R

Manufacture 2 :

Manufacture Number 2 :

M.S.R.P 04/2010 :

Description: CLUTCH BEARING MADE IN JAPAN

Application 1 :

Application 2 :

Application 3 :

Application 4 :

Application 5 :

Application 6 :

Application 7 :

Application 8 :

Application 9 :

Application 10 :

Application 11 :

Application 12 :

ZOOM+ ZOOM-



PARTS IMAGE



BOX IMAGE

RB-0214

CLUTCH BEARING MADE IN

Parts Number : RB-0214

Manufacture 1 : NSK

Manufacturer Number 1 : 50TKB3504B1RA1

Manufacture 2 :

Manufacture Number 2 :

M.S.R.P 04/2010 :

Description: CLUTCH BEARING MADE IN JAPAN

Application 1 :

Application 2 :

Application 3 :

Application 4 :

Application 5 :

Application 6 :

Application 7 :

Application 8 :

Application 9 :

Application 10 :

Application 11 :

Application 12 :

ZOOM+ ZOOM-



PARTS IMAGE



BOX IMAGE

RB-0215

CLUTCH BEARING MADE IN

Parts Number : RB-0215

Manufacture 1 : NSK

Manufacturer Number 1 : 60TKZ3502ARA

Manufacture 2 :

Manufacture Number 2 :

M.S.R.P 04/2010 :

Description: CLUTCH BEARING MADE IN JAPAN

Application 1 :

Application 2 :

Application 3 :

Application 4 :

Application 5 :

Application 6 :

Application 7 :

Application 8 :

Application 9 :

Application 10 :

Application 11 :

Application 12 :

ZOOM+

ZOOM-



PARTS IMAGE



BOX IMAGE

RB-0216

CLUTCH BEARING MADE IN

Parts Number : RB-0216

Manufacture 1 : NACHI

Manufacturer Number 1 : 50SCRN60P-2-P

Manufacture 2 :

Manufacturer Number 2 :

M.S.R.P 04/2010 :

Description: CLUTCH BEARING MADE IN JAPAN

Application 1 :

Application 2 :

Application 3 :

Application 4 :

Application 5 :

Application 6 :

Application 7 :

Application 8 :

Application 9 :

Application 10 :

Application 11 :

Application 12 :

ZOOM+

ZOOM-



PARTS IMAGE



BOX IMAGE

RB-0217

CLUTCH BEARING MADE IN

Parts Number : RB-0217

Manufacture 1 : NACHI

Manufacturer Number 1 : 88TCRG020-3

Manufacture 2 :

Manufacture Number 2 :

M.S.R.P 04/2010 :

Description: CLUTCH BEARING MADE IN JAPAN

Application 1 :

Application 2 :

Application 3 :

Application 4 :

Application 5 :

Application 6 :

Application 7 :

Application 8 :

Application 9 :

Application 10 :

Application 11 :

Application 12 :

ZOOM+

ZOOM-



PARTS IMAGE



BOX IMAGE

RB-0218

CLUTCH BEARING MADE IN

Parts Number : RB-0218

Manufacture 1 : KOYO

Manufacturer Number 1 : RCT337SA3-2

Manufacture 2 :

Manufacturer Number 2 :

M.S.R.P 04/2010 :

Description: CLUTCH BEARING MADE IN JAPAN

Application 1 :

Application 2 :

Application 3 :

Application 4 :

Application 5 :

Application 6 :

Application 7 :

Application 8 :

Application 9 :

Application 10 :

Application 11 :

Application 12 :

ZOOM+

ZOOM-



PARTS IMAGE



BOX IMAGE

RB-0219

CLUTCH BEARING MADE IN

Parts Number : RB-0219

Manufacture 1 : NSK

Manufacturer Number 1 : 60TKZ3502AR

Manufacture 2 :

Manufacture Number 2 :

M.S.R.P 04/2010 :

Description: CLUTCH BEARING MADE IN JAPAN

Application 1 :

Application 2 :

Application 3 :

Application 4 :

Application 5 :

Application 6 :

Application 7 :

Application 8 :

Application 9 :

Application 10 :

Application 11 :

Application 12 :

ZOOM+ ZOOM-



PARTS IMAGE



BOX IMAGE

RB-0301

CLUTCH BEARING MADE IN

Parts Number : RB-0301

Manufacture 1 :

Manufacturer Number 1 :

Manufacture 2 :

Manufacturer Number 2 :

M.S.R.P 04/2010 :

Description: CLUTCH BEARING MADE IN JAPAN

Application 1 :

Application 2 :

Application 3 :

Application 4 :

Application 5 :

Application 6 :

Application 7 :

Application 8 :

Application 9 :

Application 10 :

Application 11 :

Application 12 :

ZOOM+

ZOOM-



PARTS IMAGE

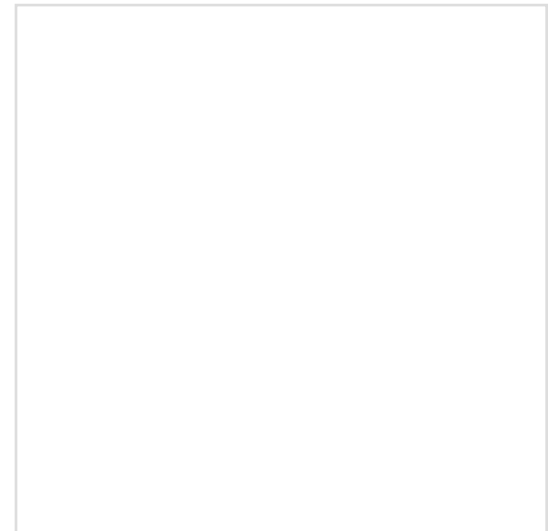

BOX IMAGE

RB-0302

CLUTCH BEARING MADE IN

Parts Number : RB-0302

Manufacture 1 : NACHI

Manufacturer Number 1 : 47SCRN031-2

Manufacture 2 :

Manufacture Number 2 :

M.S.R.P 04/2010 :

Description: CLUTCH BEARING MADE IN JAPAN

Application 1 :

Application 2 :

Application 3 :

Application 4 :

Application 5 :

Application 6 :

Application 7 :

Application 8 :

Application 9 :

Application 10 :

Application 11 :

Application 12 :

ZOOM+

ZOOM-



PARTS IMAGE



BOX IMAGE

RB-0303

CLUTCH BEARING MADE IN

Parts Number : RB-0303

Manufacture 1 : NSK

Manufacturer Number 1 : 55TKA3102A

Manufacture 2 :

Manufacturer Number 2 :

M.S.R.P 04/2010 :

Description: CLUTCH BEARING MADE IN JAPAN

Application 1 :

Application 2 :

Application 3 :

Application 4 :

Application 5 :

Application 6 :

Application 7 :

Application 8 :

Application 9 :

Application 10 :

Application 11 :

Application 12 :

ZOOM+

ZOOM-



PARTS IMAGE



BOX IMAGE

RB-0304

CLUTCH BEARING MADE IN

Parts Number : RB-0304

Manufacture 1 : NSK

Manufacturer Number 1 : 47TKX3101AU430

Manufacture 2 :

Manufacturer Number 2 :

M.S.R.P 04/2010 :

Description: CLUTCH BEARING MADE IN JAPAN

Application 1 :

Application 2 :

Application 3 :

Application 4 :

Application 5 :

Application 6 :

Application 7 :

Application 8 :

Application 9 :

Application 10 :

Application 11 :

Application 12 :

ZOOM+ ZOOM-



PARTS IMAGE



BOX IMAGE

RB-0305

CLUTCH BEARING MADE IN

Parts Number : RB-0305

Manufacture 1 : NTN

Manufacturer Number 1 : X5-FCR47-5/2E

Manufacture 2 :

Manufacture Number 2 :

M.S.R.P 04/2010 :

Description: CLUTCH BEARING MADE IN JAPAN

Application 1 :

Application 2 :

Application 3 :

Application 4 :

Application 5 :

Application 6 :

Application 7 :

Application 8 :

Application 9 :

Application 10 :

Application 11 :

Application 12 :

ZOOM+ ZOOM-



PARTS IMAGE



BOX IMAGE

RB-0306

CLUTCH BEARING MADE IN

Parts Number : RB-0306

Manufacture 1 : NACHI

Manufacturer Number 1 : 55SCRN41P-6

Manufacture 2 :

Manufacture Number 2 :

M.S.R.P 04/2010 :

Description: CLUTCH BEARING MADE IN JAPAN

Application 1 :

Application 2 :

Application 3 :

Application 4 :

Application 5 :

Application 6 :

Application 7 :

Application 8 :

Application 9 :

Application 10 :

Application 11 :

Application 12 :

ZOOM+ ZOOM-



PARTS IMAGE



BOX IMAGE

RB-0307

CLUTCH BEARING MADE IN

Parts Number : RB-0307

Manufacture 1 : NACHI

Manufacturer Number 1 : 47SCRN40P-4

Manufacture 2 :

Manufacture Number 2 :

M.S.R.P 04/2010 :

Description: CLUTCH BEARING MADE IN JAPAN

Application 1 :

Application 2 :

Application 3 :

Application 4 :

Application 5 :

Application 6 :

Application 7 :

Application 8 :

Application 9 :

Application 10 :

Application 11 :

Application 12 :

ZOOM+

ZOOM-



PARTS IMAGE



BOX IMAGE

RB-0308

CLUTCH BEARING MADE IN

Parts Number : RB-0308

Manufacture 1 : NACHI

Manufacturer Number 1 : 68TCRG40-11

Manufacture 2 :

Manufacture Number 2 :

M.S.R.P 04/2010 :

Description: CLUTCH BEARING MADE IN JAPAN

Application 1 :

Application 2 :

Application 3 :

Application 4 :

Application 5 :

Application 6 :

Application 7 :

Application 8 :

Application 9 :

Application 10 :

Application 11 :

Application 12 :

ZOOM+ ZOOM-



PARTS IMAGE



BOX IMAGE

RB-0309

CLUTCH BEARING MADE IN

Parts Number : RB-0309

Manufacture 1 : NACHI

Manufacturer Number 1 : 68TCRG42-10

Manufacture 2 :

Manufacturer Number 2 :

M.S.R.P 04/2010 :

Description: CLUTCH BEARING MADE IN JAPAN

Application 1 :

Application 2 :

Application 3 :

Application 4 :

Application 5 :

Application 6 :

Application 7 :

Application 8 :

Application 9 :

Application 10 :

Application 11 :

Application 12 :

ZOOM+ ZOOM-



PARTS IMAGE



BOX IMAGE

RB-0310

CLUTCH BEARING MADE IN

Parts Number : RB-0310

Manufacture 1 : NSK

Manufacturer Number 1 : 55TKB3502A

Manufacture 2 :

Manufacturer Number 2 :

M.S.R.P 04/2010 :

Description: CLUTCH BEARING MADE IN JAPAN

Application 1 :

Application 2 :

Application 3 :

Application 4 :

Application 5 :

Application 6 :

Application 7 :

Application 8 :

Application 9 :

Application 10 :

Application 11 :

Application 12 :

ZOOM+

ZOOM-



PARTS IMAGE



BOX IMAGE

RB-0311

CLUTCH BEARING MADE IN

Parts Number : RB-0311

Manufacture 1 :

Manufacturer Number 1 : 863

Manufacture 2 :

Manufacture Number 2 :

M.S.R.P 04/2010 :

Description: CLUTCH BEARING MADE IN JAPAN

Application 1 :

Application 2 :

Application 3 :

Application 4 :

Application 5 :

Application 6 :

Application 7 :

Application 8 :

Application 9 :

Application 10 :

Application 11 :

Application 12 :

ZOOM+

ZOOM-

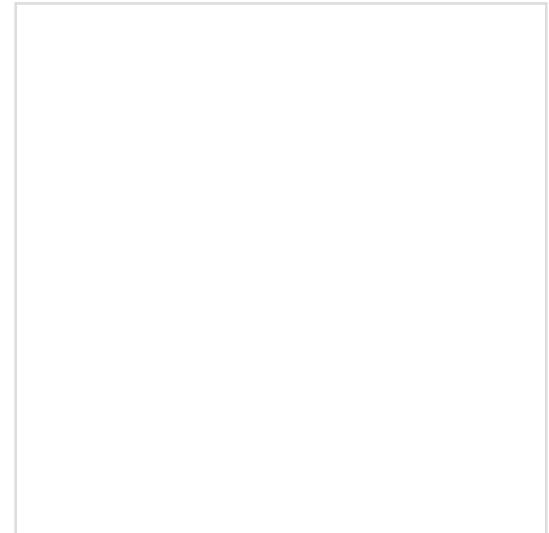

PARTS IMAGE

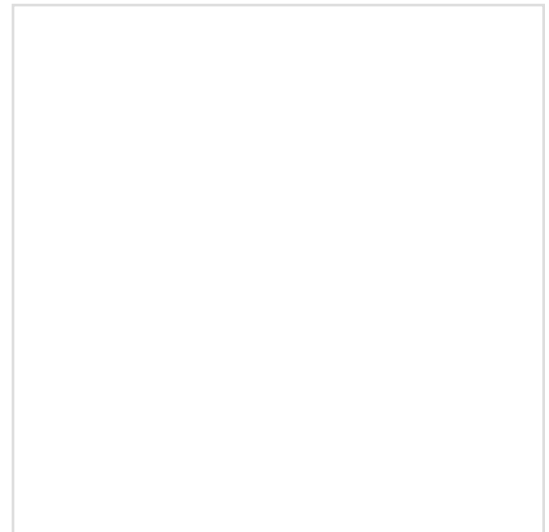

BOX IMAGE

RB-0311C

CLUTCH BEARING MADE IN

Parts Number : RB-0311C

Manufacture 1 :

Manufacturer Number 1 :

Manufacture 2 :

Manufacture Number 2 :

M.S.R.P 04/2010 :

Description: CLUTCH BEARING MADE IN CHINA

Application 1 :

Application 2 :

Application 3 :

Application 4 :

Application 5 :

Application 6 :

Application 7 :

Application 8 :

Application 9 :

Application 10 :

Application 11 :

Application 12 :

ZOOM+ ZOOM-



PARTS IMAGE



BOX IMAGE

RB-0313

CLUTCH BEARING MADE IN

Parts Number : RB-0313

Manufacture 1 : NACHI

Manufacturer Number 1 : 55SCRN34P-8

Manufacture 2 :

Manufacture Number 2 :

M.S.R.P 04/2010 :

Description: CLUTCH BEARING MADE IN JAPAN

Application 1 :

Application 2 :

Application 3 :

Application 4 :

Application 5 :

Application 6 :

Application 7 :

Application 8 :

Application 9 :

Application 10 :

Application 11 :

Application 12 :

ZOOM+ ZOOM-



PARTS IMAGE



BOX IMAGE

RB-0402

CLUTCH BEARING MADE IN

Parts Number : RB-0402

Manufacture 1 : NACHI

Manufacturer Number 1 : 48SCRN32K

Manufacture 2 :

Manufacture Number 2 :

M.S.R.P 04/2010 :

Description: CLUTCH BEARING MADE IN JAPAN

Application 1 :

Application 2 :

Application 3 :

Application 4 :

Application 5 :

Application 6 :

Application 7 :

Application 8 :

Application 9 :

Application 10 :

Application 11 :

Application 12 :

ZOOM+ ZOOM-



PARTS IMAGE



BOX IMAGE

RB-0402A

CLUTCH BEARING MADE IN

Parts Number : RB-0402A

Manufacture 1 :

Manufacturer Number 1 : 801

Manufacture 2 :

Manufacturer Number 2 :

M.S.R.P 04/2010 :

Description: CLUTCH BEARING MADE IN JAPAN

Application 1 :

Application 2 :

Application 3 :

Application 4 :

Application 5 :

Application 6 :

Application 7 :

Application 8 :

Application 9 :

Application 10 :

Application 11 :

Application 12 :

ZOOM+

ZOOM-

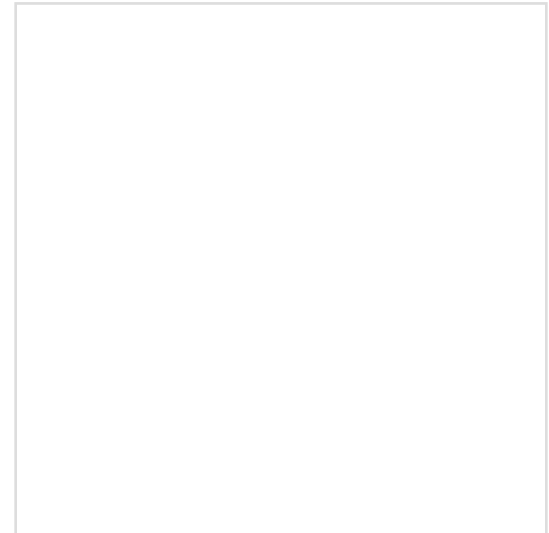

PARTS IMAGE

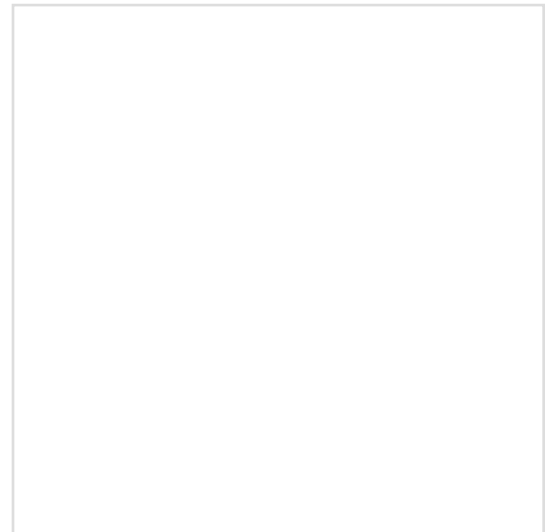

BOX IMAGE

RB-0403

CLUTCH BEARING MADE IN

Parts Number : RB-0403

Manufacture 1 : NTN

Manufacturer Number 1 : FCR55-1/2E

Manufacture 2 :

Manufacture Number 2 :

M.S.R.P 04/2010 :

Description: CLUTCH BEARING MADE IN JAPAN

Application 1 :

Application 2 :

Application 3 :

Application 4 :

Application 5 :

Application 6 :

Application 7 :

Application 8 :

Application 9 :

Application 10 :

Application 11 :

Application 12 :

ZOOM+ ZOOM-



PARTS IMAGE



BOX IMAGE

RB-0404

CLUTCH BEARING MADE IN

Parts Number : RB-0404

Manufacture 1 : KOYO

Manufacturer Number 1 : RCTS325SA

Manufacture 2 :

Manufacture Number 2 :

M.S.R.P 04/2010 :

Description: CLUTCH BEARING MADE IN JAPAN

Application 1 :

Application 2 :

Application 3 :

Application 4 :

Application 5 :

Application 6 :

Application 7 :

Application 8 :

Application 9 :

Application 10 :

Application 11 :

Application 12 :

ZOOM+

ZOOM-



PARTS IMAGE



BOX IMAGE

RB-0404A

CLUTCH BEARING MADE IN

Parts Number : RB-0404A

Manufacture 1 :

Manufacturer Number 1 :

804

Manufacture 2 :

Manufacture Number 2 :

M.S.R.P 04/2010 :

Description:

CLUTCH BEARING MADE IN JAPAN

Application 1 :

Application 2 :

Application 3 :

Application 4 :

Application 5 :

Application 6 :

Application 7 :

Application 8 :

Application 9 :

Application 10 :

Application 11 :

Application 12 :

ZOOM+

ZOOM-

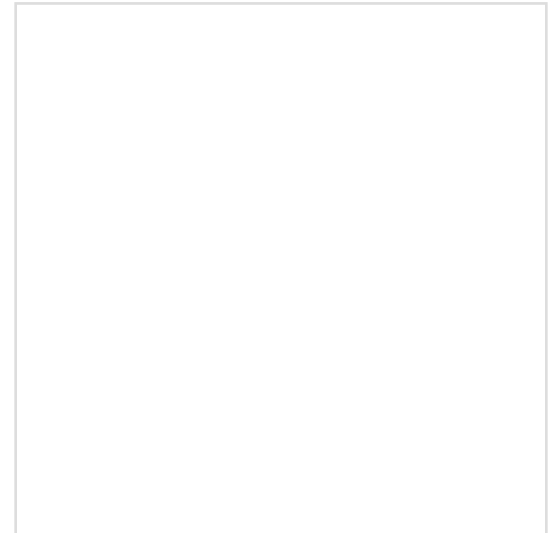

PARTS IMAGE

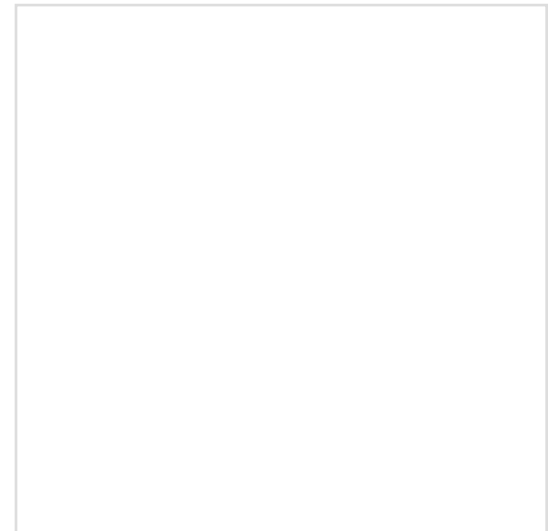

BOX IMAGE

RB-0405

CLUTCH BEARING MADE IN

Parts Number : RB-0405

Manufacture 1 : NSK

Manufacturer Number 1 : 58TKA3703C

Manufacture 2 :

Manufacture Number 2 :

M.S.R.P 04/2010 :

Description: CLUTCH BEARING MADE IN JAPAN

Application 1 :

Application 2 :

Application 3 :

Application 4 :

Application 5 :

Application 6 :

Application 7 :

Application 8 :

Application 9 :

Application 10 :

Application 11 :

Application 12 :

ZOOM+ ZOOM-



PARTS IMAGE



BOX IMAGE

RB-0407

CLUTCH BEARING MADE IN

Parts Number : RB-0407

Manufacture 1 : KOYO

Manufacturer Number 1 : RCTS30SA1

Manufacture 2 :

Manufacture Number 2 :

M.S.R.P 04/2010 :

Description: CLUTCH BEARING MADE IN JAPAN

Application 1 :

Application 2 :

Application 3 :

Application 4 :

Application 5 :

Application 6 :

Application 7 :

Application 8 :

Application 9 :

Application 10 :

Application 11 :

Application 12 :

ZOOM+

ZOOM-



PARTS IMAGE



BOX IMAGE

RB-0408

CLUTCH BEARING MADE IN

Parts Number : RB-0408

Manufacture 1 :

Manufacturer Number 1 : PA66-GF35/H/MS

Manufacture 2 :

Manufacturer Number 2 :

M.S.R.P 04/2010 :

Description: CLUTCH BEARING MADE IN BRAZIL

Application 1 :

Application 2 :

Application 3 :

Application 4 :

Application 5 :

Application 6 :

Application 7 :

Application 8 :

Application 9 :

Application 10 :

Application 11 :

Application 12 :

ZOOM+

ZOOM-



PARTS IMAGE



BOX IMAGE

RB-0409

CLUTCH BEARING MADE IN

Parts Number : RB-0409

Manufacture 1 : VALEO

Manufacturer Number 1 : PRB-04

Manufacture 2 :

Manufacturer Number 2 :

M.S.R.P 04/2010 :

Description: CLUTCH BEARING MADE IN KOREA

Application 1 :

Application 2 :

Application 3 :

Application 4 :

Application 5 :

Application 6 :

Application 7 :

Application 8 :

Application 9 :

Application 10 :

Application 11 :

Application 12 :

ZOOM+

ZOOM-



PARTS IMAGE



BOX IMAGE

RB-0410

CLUTCH BEARING MADE IN

Parts Number : RB-0410

Manufacture 1 : VALEO

Manufacturer Number 1 : PRB-05

Manufacture 2 :

Manufacture Number 2 :

M.S.R.P 04/2010 :

Description: CLUTCH BEARING MADE IN KOREA
VALEO / GMB

Application 1 :

Application 2 :

Application 3 :

Application 4 :

Application 5 :

Application 6 :

Application 7 :

Application 8 :

Application 9 :

Application 10 :

Application 11 :

Application 12 :

ZOOM+

ZOOM-



PARTS IMAGE



BOX IMAGE

RB-0411

CLUTCH BEARING MADE IN

Parts Number : RB-0411

Manufacture 1 : NSK

Manufacturer Number 1 : 48TKT3202

Manufacture 2 :

Manufacturer Number 2 :

M.S.R.P 04/2010 :

Description: CLUTCH BEARING MADE IN JAPAN

Application 1 :

Application 2 :

Application 3 :

Application 4 :

Application 5 :

Application 6 :

Application 7 :

Application 8 :

Application 9 :

Application 10 :

Application 11 :

Application 12 :

ZOOM+ ZOOM-



PARTS IMAGE



BOX IMAGE

RB-0501

CLUTCH BEARING MADE IN

Parts Number : RB-0501

Manufacture 1 :

Manufacturer Number 1 :

810

Manufacture 2 :

Manufacture Number 2 :

M.S.R.P 04/2010 :

Description:

CLUTCH BEARING MADE IN JAPAN

Application 1 :

Application 2 :

Application 3 :

Application 4 :

Application 5 :

Application 6 :

Application 7 :

Application 8 :

Application 9 :

Application 10 :

Application 11 :

Application 12 :

ZOOM+

ZOOM-

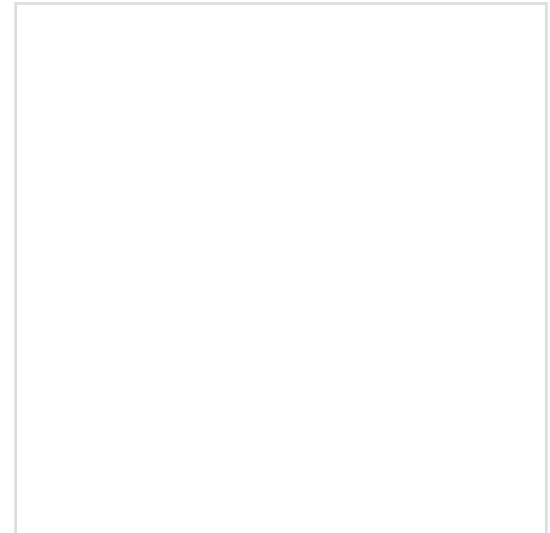

PARTS IMAGE

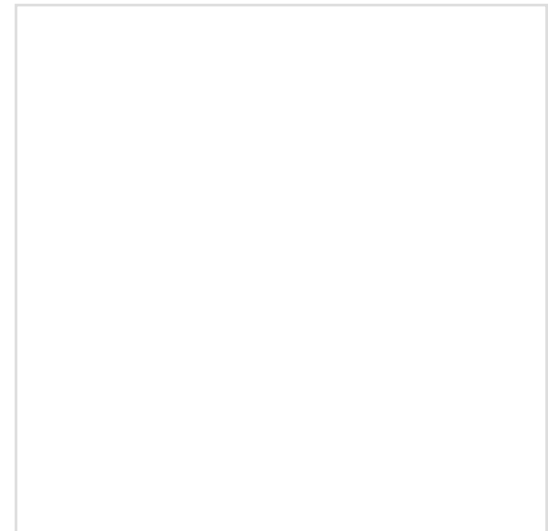

BOX IMAGE

RB-0502

CLUTCH BEARING MADE IN

Parts Number : RB-0502

Manufacture 1 : NACHI

Manufacturer Number 1 : 54SCRN42P

Manufacture 2 :

Manufacturer Number 2 :

M.S.R.P 04/2010 :

Description: CLUTCH BEARING MADE IN JAPAN

Application 1 :

Application 2 :

Application 3 :

Application 4 :

Application 5 :

Application 6 :

Application 7 :

Application 8 :

Application 9 :

Application 10 :

Application 11 :

Application 12 :

ZOOM+

ZOOM-



PARTS IMAGE



BOX IMAGE

RB-0502A

Parts Number : RB-0502A

Manufacture 1 : SECO

Manufacturer Number 1 : SRB-01

Manufacture 2 :

Manufacture Number 2 :

M.S.R.P 04/2010 :

Description: CLUTCH BEARING MADE IN KOREA

Application 1 :

Application 2 :

Application 3 :

Application 4 :

Application 5 :

Application 6 :

Application 7 :

Application 8 :

Application 9 :

Application 10 :

Application 11 :

Application 12 :

CLUTCH BEARING MADE IN



PARTS IMAGE



BOX IMAGE

RB-0504

CLUTCH BEARING MADE IN

Parts Number : RB-0504

Manufacture 1 : NACHI

Manufacturer Number 1 : 47SCRN34K-6

Manufacture 2 :

Manufacture Number 2 :

M.S.R.P 04/2010 :

Description: CLUTCH BEARING MADE IN JAPAN

Application 1 :

Application 2 :

Application 3 :

Application 4 :

Application 5 :

Application 6 :

Application 7 :

Application 8 :

Application 9 :

Application 10 :

Application 11 :

Application 12 :

ZOOM+ ZOOM-



PARTS IMAGE



BOX IMAGE

RB-0507

CLUTCH BEARING MADE IN

Parts Number : RB-0507

Manufacture 1 : NTN

Manufacturer Number 1 : FCR44-32-2/2E

Manufacture 2 :

Manufacturer Number 2 :

M.S.R.P 04/2010 :

Description: CLUTCH BEARING MADE IN JAPAN

Application 1 :

Application 2 :

Application 3 :

Application 4 :

Application 5 :

Application 6 :

Application 7 :

Application 8 :

Application 9 :

Application 10 :

Application 11 :

Application 12 :

ZOOM+

ZOOM-



PARTS IMAGE



BOX IMAGE

RB-0511

CLUTCH BEARING MADE IN

Parts Number : RB-0511

Manufacture 1 : NTN

Manufacturer Number 1 : FCR54-48-4/2E

Manufacture 2 :

Manufacturer Number 2 :

M.S.R.P 04/2010 :

Description: CLUTCH BEARING MADE IN JAPAN

Application 1 :

Application 2 :

Application 3 :

Application 4 :

Application 5 :

Application 6 :

Application 7 :

Application 8 :

Application 9 :

Application 10 :

Application 11 :

Application 12 :

ZOOM+ ZOOM-



PARTS IMAGE



BOX IMAGE

RB-0512

CLUTCH BEARING MADE IN

Parts Number : RB-0512

Manufacture 1 : SECO

Manufacturer Number 1 : SRB-02

Manufacture 2 :

Manufacture Number 2 :

M.S.R.P 04/2010 :

Description: CLUTCH BEARING MADE IN KOREA

Application 1 :

Application 2 :

Application 3 :

Application 4 :

Application 5 :

Application 6 :

Application 7 :

Application 8 :

Application 9 :

Application 10 :

Application 11 :

Application 12 :

ZOOM+ ZOOM-



PARTS IMAGE



BOX IMAGE

RB-0514

CLUTCH BEARING MADE IN

Parts Number : RB-0514

Manufacture 1 : KOYO

Manufacturer Number 1 : RCT363SA1

Manufacture 2 :

Manufacture Number 2 :

M.S.R.P 04/2010 :

Description: CLUTCH BEARING MADE IN JAPAN

Application 1 :

Application 2 :

Application 3 :

Application 4 :

Application 5 :

Application 6 :

Application 7 :

Application 8 :

Application 9 :

Application 10 :

Application 11 :

Application 12 :

ZOOM+

ZOOM-



PARTS IMAGE



BOX IMAGE

RB-0601

CLUTCH BEARING MADE IN

Parts Number : RB-0601

Manufacture 1 : NSK

Manufacturer Number 1 : 48TKA3214

Manufacture 2 :

Manufacturer Number 2 :

M.S.R.P 04/2010 :

Description: CLUTCH BEARING MADE IN JAPAN

Application 1 :

Application 2 :

Application 3 :

Application 4 :

Application 5 :

Application 6 :

Application 7 :

Application 8 :

Application 9 :

Application 10 :

Application 11 :

Application 12 :

ZOOM+ ZOOM-



PARTS IMAGE



BOX IMAGE

RB-0602

CLUTCH BEARING MADE IN

Parts Number : RB-0602

Manufacture 1 : NSK

Manufacturer Number 1 : 48TKX3211BR

Manufacture 2 :

Manufacture Number 2 :

M.S.R.P 04/2010 :

Description: CLUTCH BEARING MADE IN JAPAN

Application 1 :

Application 2 :

Application 3 :

Application 4 :

Application 5 :

Application 6 :

Application 7 :

Application 8 :

Application 9 :

Application 10 :

Application 11 :

Application 12 :

ZOOM+ ZOOM-



PARTS IMAGE



BOX IMAGE

RB-0603

CLUTCH BEARING MADE IN

Parts Number : RB-0603

Manufacture 1 : KOYO

Manufacturer Number 1 : RCT422SA1

Manufacture 2 :

Manufacturer Number 2 :

M.S.R.P 04/2010 :

Description: CLUTCH BEARING MADE IN JAPAN

Application 1 :

Application 2 :

Application 3 :

Application 4 :

Application 5 :

Application 6 :

Application 7 :

Application 8 :

Application 9 :

Application 10 :

Application 11 :

Application 12 :

ZOOM+ ZOOM-



PARTS IMAGE



BOX IMAGE

RB-0605C

CLUTCH BEARING MADE IN

Parts Number : RB-0605C

Manufacture 1 :

Manufacturer Number 1 : NAB3875SA

Manufacture 2 :

Manufacture Number 2 :

M.S.R.P 04/2010 :

Description: CLUTCH BEARING MADE IN CHINA

Application 1 :

Application 2 :

Application 3 :

Application 4 :

Application 5 :

Application 6 :

Application 7 :

Application 8 :

Application 9 :

Application 10 :

Application 11 :

Application 12 :

ZOOM+ ZOOM-



PARTS IMAGE



BOX IMAGE

RB-0606

CLUTCH BEARING MADE IN

Parts Number : RB-0606

Manufacture 1 :

Manufacturer Number 1 :

816

Manufacture 2 :

Manufacture Number 2 :

M.S.R.P 04/2010 :

Description:

CLUTCH BEARING MADE IN JAPAN

Application 1 :

Application 2 :

Application 3 :

Application 4 :

Application 5 :

Application 6 :

Application 7 :

Application 8 :

Application 9 :

Application 10 :

Application 11 :

Application 12 :

ZOOM+

ZOOM-

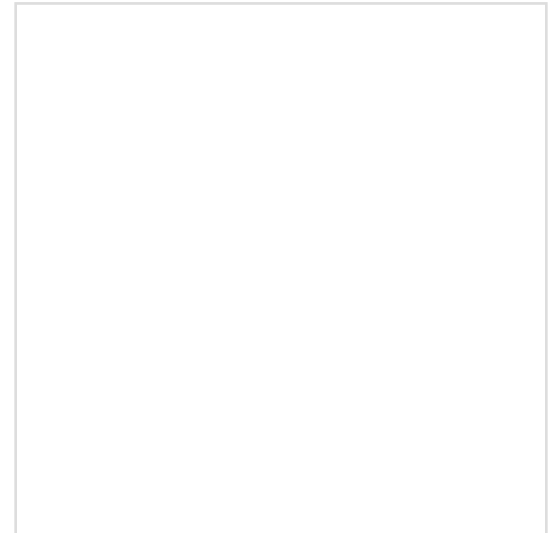

PARTS IMAGE

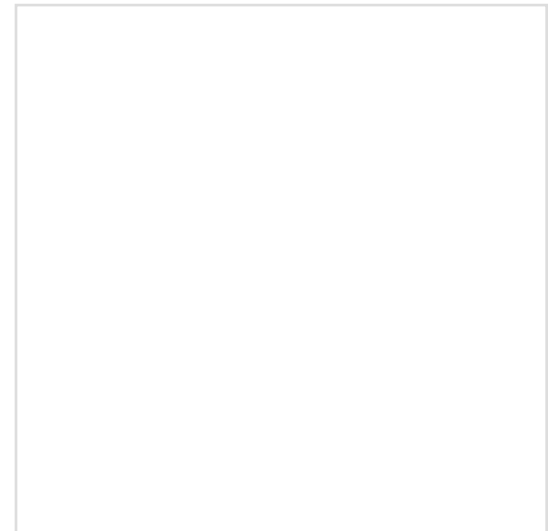

BOX IMAGE

RB-0607

CLUTCH BEARING MADE IN

Parts Number : RB-0607

Manufacture 1 : NSK

Manufacturer Number 1 : 60TKZ3201R

Manufacture 2 :

Manufacture Number 2 :

M.S.R.P 04/2010 :

Description: CLUTCH BEARING MADE IN JAPAN

Application 1 :

Application 2 :

Application 3 :

Application 4 :

Application 5 :

Application 6 :

Application 7 :

Application 8 :

Application 9 :

Application 10 :

Application 11 :

Application 12 :

ZOOM+

ZOOM-



PARTS IMAGE



BOX IMAGE

RB-0608

CLUTCH BEARING MADE IN

Parts Number : RB-0608

Manufacture 1 :

Manufacturer Number 1 :

Manufacture 2 :

Manufacturer Number 2 :

M.S.R.P 04/2010 :

Description:

RB-0608

CLUTCH BEARING MADE IN JAPAN

Application 1 :

Application 2 :

Application 3 :

Application 4 :

Application 5 :

Application 6 :

Application 7 :

Application 8 :

Application 9 :

Application 10 :

Application 11 :

Application 12 :

ZOOM+

ZOOM-

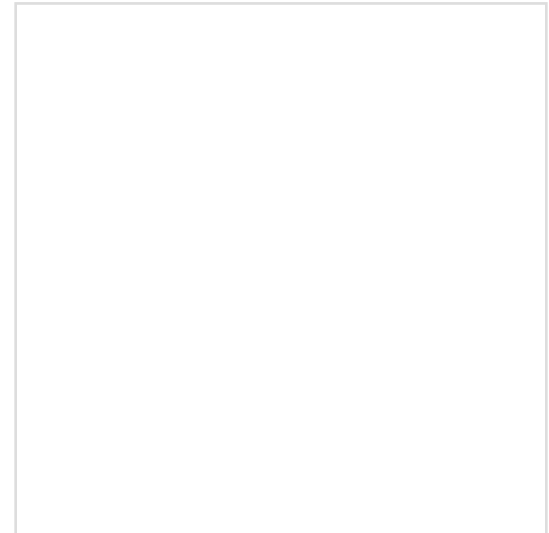

PARTS IMAGE

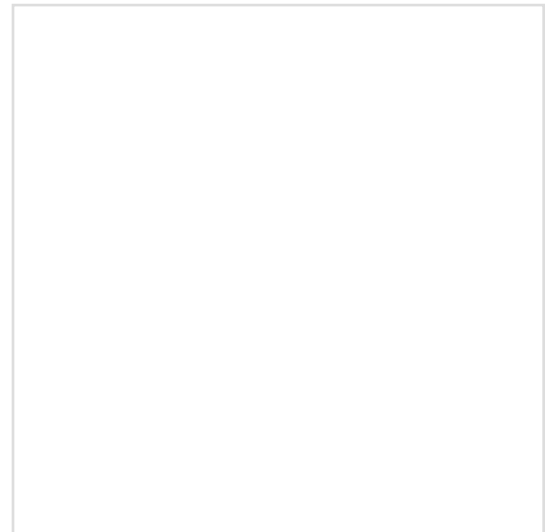

BOX IMAGE

RB-0701

CLUTCH BEARING MADE IN

Parts Number : RB-0701

Manufacture 1 : KOYO

Manufacturer Number 1 : RCT282SA

Manufacture 2 :

Manufacture Number 2 :

M.S.R.P 04/2010 :

Description: CLUTCH BEARING MADE IN JAPAN

Application 1 :

Application 2 :

Application 3 :

Application 4 :

Application 5 :

Application 6 :

Application 7 :

Application 8 :

Application 9 :

Application 10 :

Application 11 :

Application 12 :

ZOOM+

ZOOM-



PARTS IMAGE



BOX IMAGE

RB-0702

CLUTCH BEARING MADE IN

Parts Number : RB-0702

Manufacture 1 : NSK

Manufacturer Number 1 : 44TKB2805BR

Manufacture 2 :

Manufacturer Number 2 :

M.S.R.P 04/2010 :

Description: CLUTCH BEARING MADE IN JAPAN

Application 1 :

Application 2 :

Application 3 :

Application 4 :

Application 5 :

Application 6 :

Application 7 :

Application 8 :

Application 9 :

Application 10 :

Application 11 :

Application 12 :

ZOOM+ ZOOM-



PARTS IMAGE



BOX IMAGE

RB-0703

CLUTCH BEARING MADE IN

Parts Number : RB-0703

Manufacture 1 :

Manufacturer Number 1 :

819

Manufacture 2 :

Manufacture Number 2 :

M.S.R.P 04/2010 :

Description:

CLUTCH BEARING MADE IN JAPAN

Application 1 :

Application 2 :

Application 3 :

Application 4 :

Application 5 :

Application 6 :

Application 7 :

Application 8 :

Application 9 :

Application 10 :

Application 11 :

Application 12 :

ZOOM+

ZOOM-

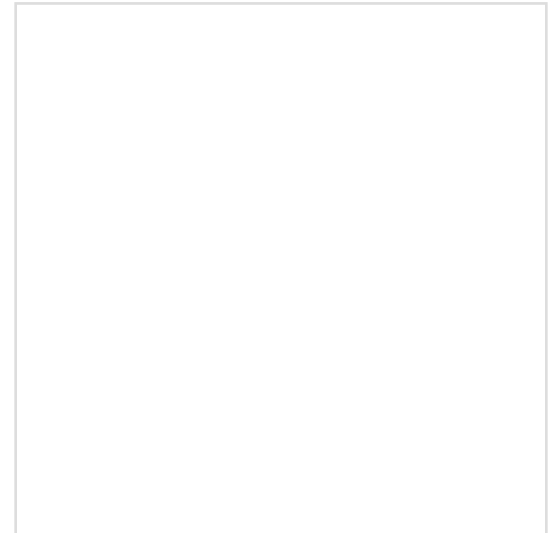

PARTS IMAGE

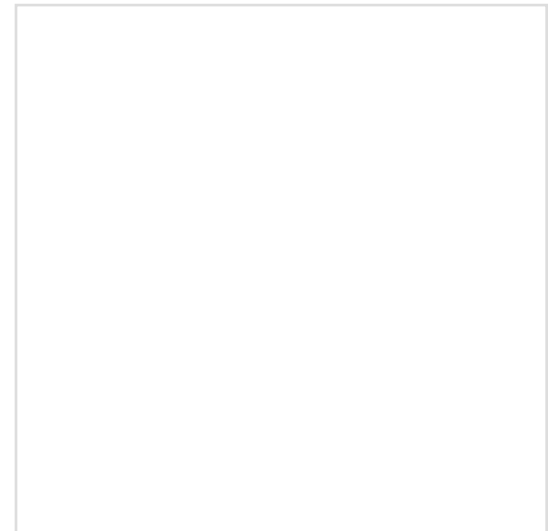

BOX IMAGE

RB-0801

CLUTCH BEARING MADE IN

Parts Number : RB-0801

Manufacture 1 : KOYO

Manufacturer Number 1 : RCTS338SA1

Manufacture 2 :

Manufacture Number 2 :

M.S.R.P 04/2010 :

Description: CLUTCH BEARING MADE IN JAPAN

Application 1 :

Application 2 :

Application 3 :

Application 4 :

Application 5 :

Application 6 :

Application 7 :

Application 8 :

Application 9 :

Application 10 :

Application 11 :

Application 12 :

ZOOM+

ZOOM-



PARTS IMAGE



BOX IMAGE

RB-0801A

CLUTCH BEARING MADE IN

Parts Number : RB-0801A

Manufacture 1 :

Manufacturer Number 1 :

821

Manufacture 2 :

Manufacture Number 2 :

M.S.R.P 04/2010 :

Description:

CLUTCH BEARING MADE IN JAPAN

Application 1 :

Application 2 :

Application 3 :

Application 4 :

Application 5 :

Application 6 :

Application 7 :

Application 8 :

Application 9 :

Application 10 :

Application 11 :

Application 12 :

ZOOM+

ZOOM-

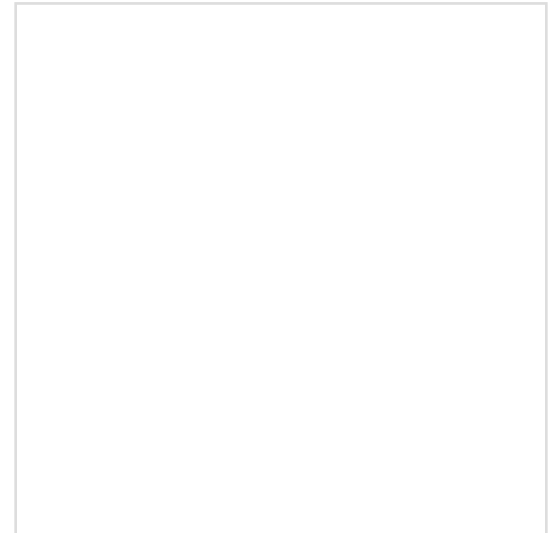

PARTS IMAGE

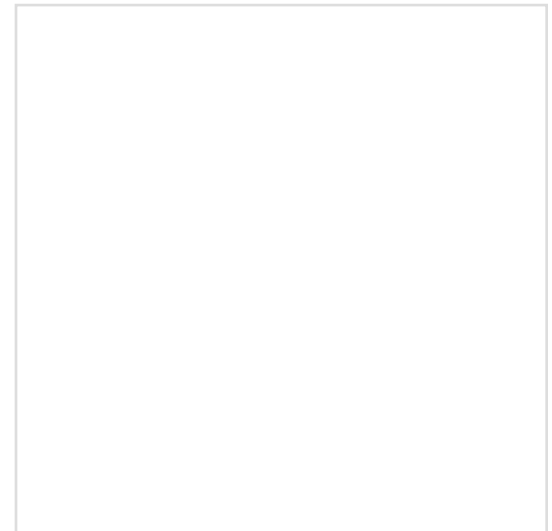

BOX IMAGE

RB-0802

CLUTCH BEARING MADE IN

Parts Number : RB-0802

Manufacture 1 : NTN

Manufacturer Number 1 : FCR-35-6/5K

Manufacture 2 :

Manufacturer Number 2 :

M.S.R.P 04/2010 :

Description: CLUTCH BEARING MADE IN JAPAN

Application 1 :

Application 2 :

Application 3 :

Application 4 :

Application 5 :

Application 6 :

Application 7 :

Application 8 :

Application 9 :

Application 10 :

Application 11 :

Application 12 :

ZOOM+

ZOOM-



PARTS IMAGE



BOX IMAGE

RB-0803

CLUTCH BEARING MADE IN

Parts Number : RB-0803

Manufacture 1 : NTN

Manufacturer Number 1 : FCR50-41-3/2E

Manufacture 2 :

Manufacturer Number 2 :

M.S.R.P 04/2010 :

Description: CLUTCH BEARING MADE IN JAPAN

Application 1 :

Application 2 :

Application 3 :

Application 4 :

Application 5 :

Application 6 :

Application 7 :

Application 8 :

Application 9 :

Application 10 :

Application 11 :

Application 12 :

ZOOM+

ZOOM-



PARTS IMAGE



BOX IMAGE

RB-0901

CLUTCH BEARING MADE IN

Parts Number : RB-0901

Manufacture 1 : NACHI

Manufacturer Number 1 : 35TRK39

Manufacture 2 : NSK

Manufacture Number 2 : 35TMX29B2UN3S5

M.S.R.P 04/2010 :

Description: CLUTCH BEARING MADE IN JAPAN

Application 1 :

Application 2 :

Application 3 :

Application 4 :

Application 5 :

Application 6 :

Application 7 :

Application 8 :

Application 9 :

Application 10 :

Application 11 :

Application 12 :

ZOOM+

ZOOM-



PARTS IMAGE



BOX IMAGE

RB-0902

CLUTCH BEARING MADE IN

Parts Number : RB-0902

Manufacture 1 : NTN

Manufacturer Number 1 : FCR62-16-8/2E

Manufacture 2 :

Manufacturer Number 2 :

M.S.R.P 04/2010 :

Description: CLUTCH BEARING MADE IN JAPAN

Application 1 :

Application 2 :

Application 3 :

Application 4 :

Application 5 :

Application 6 :

Application 7 :

Application 8 :

Application 9 :

Application 10 :

Application 11 :

Application 12 :

ZOOM+ ZOOM-



PARTS IMAGE



BOX IMAGE

RB-0904

CLUTCH BEARING MADE IN

Parts Number : RB-0904

Manufacture 1 : NTN

Manufacturer Number 1 : FCR62-42-13

Manufacture 2 : SUBARU

Manufacture Number 2 : BRG833

M.S.R.P 04/2010 :

Description: CLUTCH BEARING MADE IN JAPAN

Application 1 :

Application 2 :

Application 3 :

Application 4 :

Application 5 :

Application 6 :

Application 7 :

Application 8 :

Application 9 :

Application 10 :

Application 11 :

Application 12 :

ZOOM+

ZOOM-



PARTS IMAGE



BOX IMAGE

RB-0905

CLUTCH BEARING MADE IN

Parts Number : RB-0905

Manufacture 1 : KOYO

Manufacturer Number 1 : CBU442829

Manufacture 2 :

Manufacturer Number 2 :

M.S.R.P 04/2010 :

Description: CLUTCH BEARING MADE IN JAPAN

Application 1 :

Application 2 :

Application 3 :

Application 4 :

Application 5 :

Application 6 :

Application 7 :

Application 8 :

Application 9 :

Application 10 :

Application 11 :

Application 12 :

ZOOM+

ZOOM-



PARTS IMAGE



BOX IMAGE

RB-0906

CLUTCH BEARING MADE IN

Parts Number : RB-0906

Manufacture 1 :

Manufacturer Number 1 :

827

Manufacture 2 :

Manufacturer Number 2 :

M.S.R.P 04/2010 :

Description:

CLUTCH BEARING MADE IN JAPAN

Application 1 :

Application 2 :

Application 3 :

Application 4 :

Application 5 :

Application 6 :

Application 7 :

Application 8 :

Application 9 :

Application 10 :

Application 11 :

Application 12 :

ZOOM+

ZOOM-

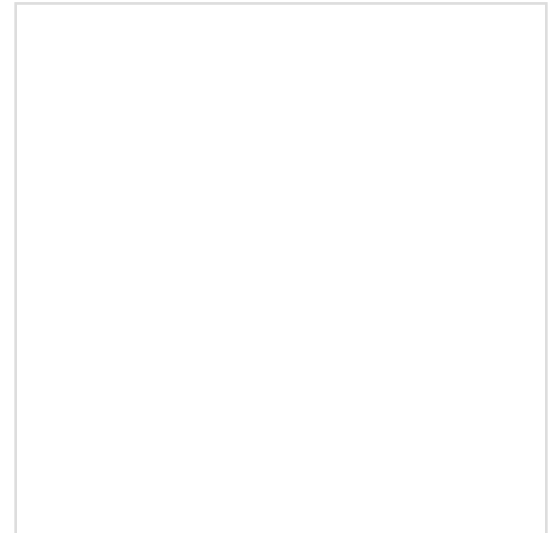

PARTS IMAGE

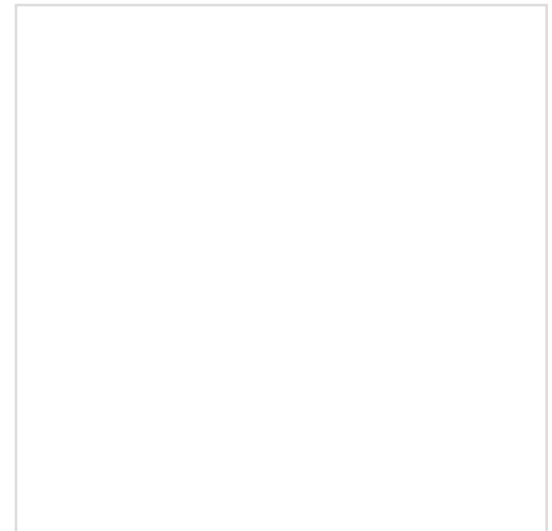

BOX IMAGE

RB-0907

CLUTCH BEARING MADE IN

Parts Number : RB-0907

Manufacture 1 : NSK

Manufacturer Number 1 : 44TKB2806A

Manufacture 2 :

Manufacturer Number 2 :

M.S.R.P 04/2010 :

Description: CLUTCH BEARING MADE IN JAPAN

Application 1 :

Application 2 :

Application 3 :

Application 4 :

Application 5 :

Application 6 :

Application 7 :

Application 8 :

Application 9 :

Application 10 :

Application 11 :

Application 12 :

ZOOM+ ZOOM-



PARTS IMAGE



BOX IMAGE

RB-1001

CLUTCH BEARING MADE IN

Parts Number : RB-1001

Manufacture 1 :

Manufacturer Number 1 :

829

Manufacture 2 :

Manufacture Number 2 :

M.S.R.P 04/2010 :

Description:

CLUTCH BEARING MADE IN JAPAN

Application 1 :

Application 2 :

Application 3 :

Application 4 :

Application 5 :

Application 6 :

Application 7 :

Application 8 :

Application 9 :

Application 10 :

Application 11 :

Application 12 :

ZOOM+

ZOOM-

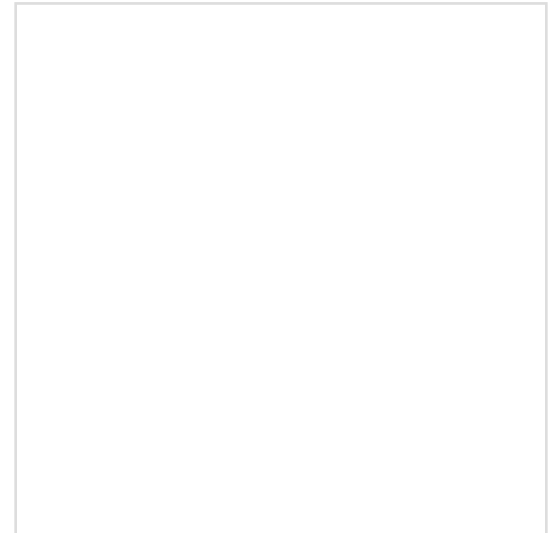

PARTS IMAGE

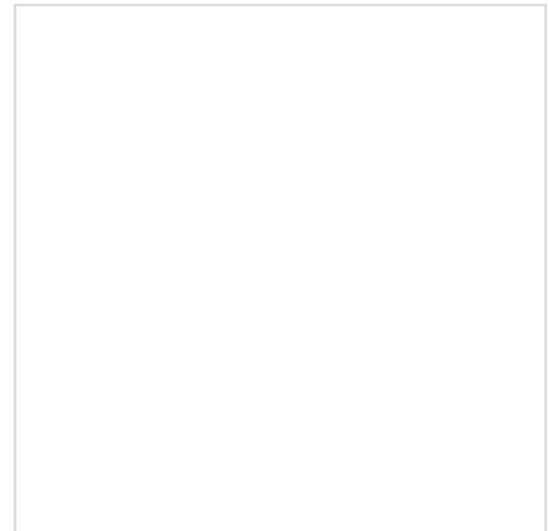

BOX IMAGE

RB-1002

CLUTCH BEARING MADE IN

Parts Number : RB-1002

Manufacture 1 : NSK

Manufacturer Number 1 : 24TK308B2

Manufacture 2 :

Manufacturer Number 2 :

M.S.R.P 04/2010 :

Description: CLUTCH BEARING MADE IN JAPAN

Application 1 :

Application 2 :

Application 3 :

Application 4 :

Application 5 :

Application 6 :

Application 7 :

Application 8 :

Application 9 :

Application 10 :

Application 11 :

Application 12 :

ZOOM+

ZOOM-



PARTS IMAGE



BOX IMAGE

RB-1003

CLUTCH BARRING MADE IN

Parts Number : RB-1003

Manufacture 1 :

Manufacturer Number 1 :

831

Manufacture 2 :

Manufacture Number 2 :

M.S.R.P 04/2010 :

Description:

CLUTCH BARRING MADE IN JAPAN

Application 1 :

Application 2 :

Application 3 :

Application 4 :

Application 5 :

Application 6 :

Application 7 :

Application 8 :

Application 9 :

Application 10 :

Application 11 :

Application 12 :

ZOOM+

ZOOM-

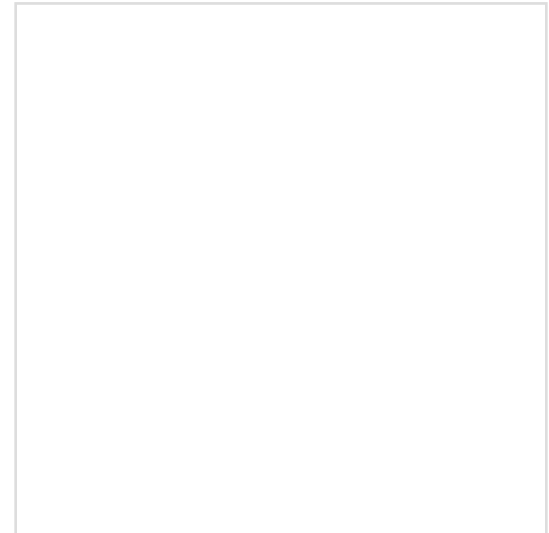

PARTS IMAGE

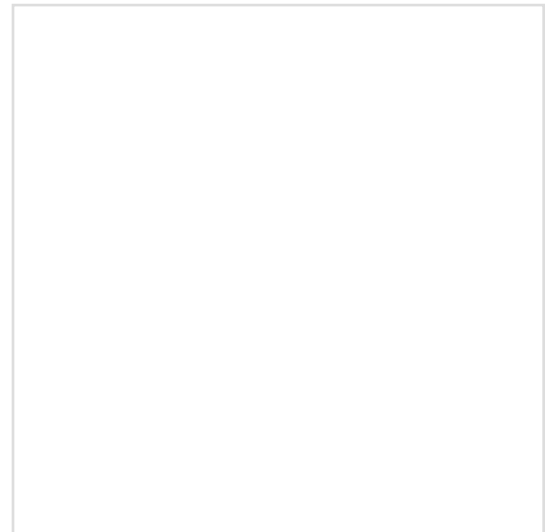

BOX IMAGE

RB-1101

CLUTCH BEARING MADE IN

Parts Number : RB-1101

Manufacture 1 : KOYO

Manufacturer Number 1 : RCT283SA

Manufacture 2 :

Manufacture Number 2 :

M.S.R.P 04/2010 :

Description: CLUTCH BEARING MADE IN JAPAN

Application 1 :

Application 2 :

Application 3 :

Application 4 :

Application 5 :

Application 6 :

Application 7 :

Application 8 :

Application 9 :

Application 10 :

Application 11 :

Application 12 :

ZOOM+

ZOOM-



PARTS IMAGE



BOX IMAGE

RB-1102

CLUTCH BEARING MADE IN

Parts Number : RB-1102

Manufacture 1 : NSK

Manufacturer Number 1 : 61TKB3001

Manufacture 2 :

Manufacturer Number 2 :

M.S.R.P 04/2010 :

Description: CLUTCH BEARING MADE IN JAPAN

Application 1 :

Application 2 :

Application 3 :

Application 4 :

Application 5 :

Application 6 :

Application 7 :

Application 8 :

Application 9 :

Application 10 :

Application 11 :

Application 12 :

ZOOM+ ZOOM-



PARTS IMAGE



BOX IMAGE

RB-1103

CLUTCH BEARING MADE IN

Parts Number : RB-1103

Manufacture 1 :

Manufacturer Number 1 : 834

Manufacture 2 :

Manufacturer Number 2 :

M.S.R.P 04/2010 :

Description: CLUTCH BEARING MADE IN JAPAN

Application 1 :

Application 2 :

Application 3 :

Application 4 :

Application 5 :

Application 6 :

Application 7 :

Application 8 :

Application 9 :

Application 10 :

Application 11 :

Application 12 :

ZOOM+

ZOOM-



PARTS IMAGE

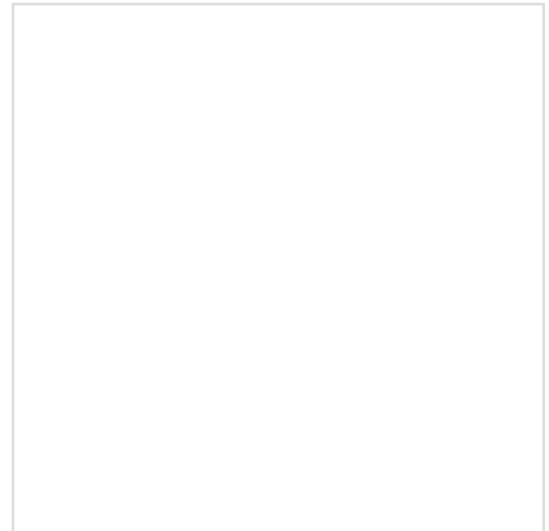

BOX IMAGE

RB-1104

CLUTCH BEARING MADE IN

Parts Number : RB-1104

Manufacture 1 :

Manufacturer Number 1 :

835

Manufacture 2 :

Manufacturer Number 2 :

M.S.R.P 04/2010 :

Description:

CLUTCH BEARING MADE IN JAPAN

Application 1 :

Application 2 :

Application 3 :

Application 4 :

Application 5 :

Application 6 :

Application 7 :

Application 8 :

Application 9 :

Application 10 :

Application 11 :

Application 12 :

ZOOM+

ZOOM-

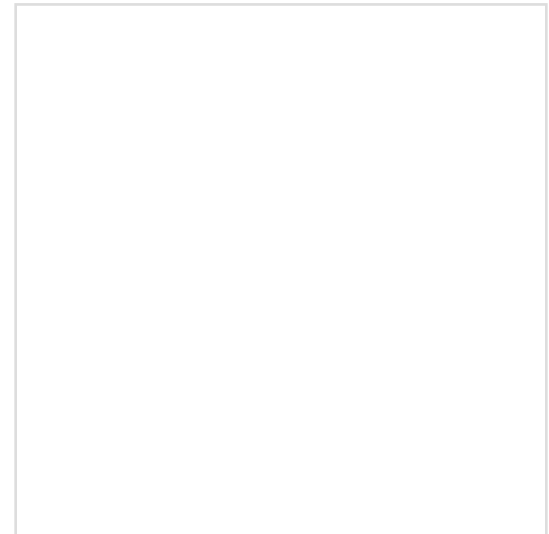

PARTS IMAGE

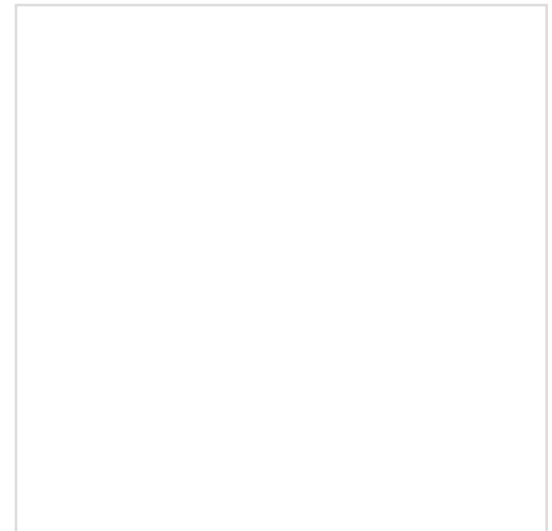

BOX IMAGE

RB-1105

CLUTCH BEARING MADE IN

Parts Number : RB-1105

Manufacture 1 : NTN

Manufacturer Number 1 : CE01186CB

Manufacture 2 :

Manufacturer Number 2 :

M.S.R.P 04/2010 :

Description: CLUTCH BEARING MADE IN JAPAN

Application 1 :

Application 2 :

Application 3 :

Application 4 :

Application 5 :

Application 6 :

Application 7 :

Application 8 :

Application 9 :

Application 10 :

Application 11 :

Application 12 :

ZOOM+

ZOOM-



PARTS IMAGE

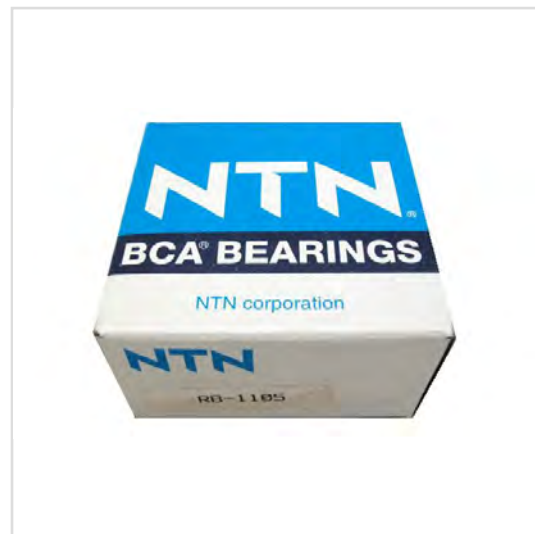

BOX IMAGE

RB-1106

CLUTCH BEARING MADE IN

Parts Number : RB-1106

Manufacture 1 :

Manufacturer Number 1 :

837

Manufacture 2 :

Manufacture Number 2 :

M.S.R.P 04/2010 :

Description:

CLUTCH BEARING MADE IN JAPAN

Application 1 :

Application 2 :

Application 3 :

Application 4 :

Application 5 :

Application 6 :

Application 7 :

Application 8 :

Application 9 :

Application 10 :

Application 11 :

Application 12 :

ZOOM+

ZOOM-

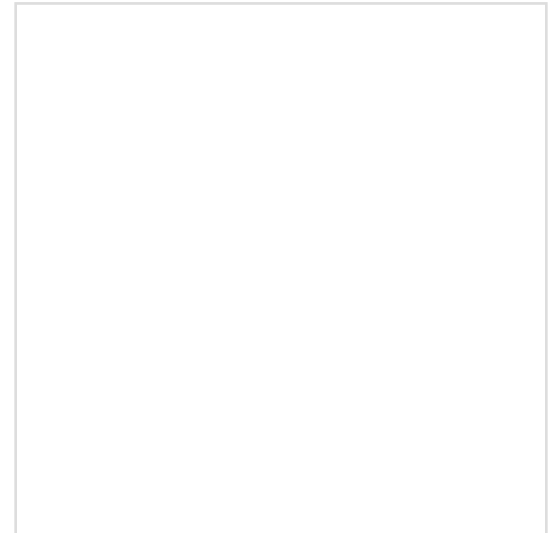

PARTS IMAGE

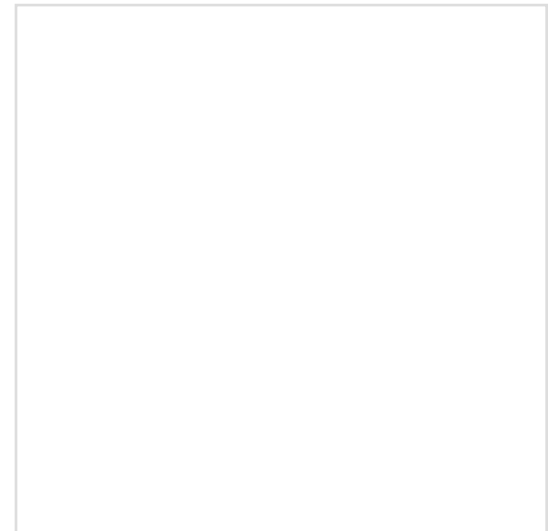

BOX IMAGE

RB-1107

CLUTCH BEARING MADE IN

Parts Number : RB-1107

Manufacture 1 :

Manufacturer Number 1 :

838

Manufacture 2 :

Manufacturer Number 2 :

M.S.R.P 04/2010 :

Description:

CLUTCH BEARING MADE IN JAPAN

Application 1 :

Application 2 :

Application 3 :

Application 4 :

Application 5 :

Application 6 :

Application 7 :

Application 8 :

Application 9 :

Application 10 :

Application 11 :

Application 12 :

ZOOM+

ZOOM-

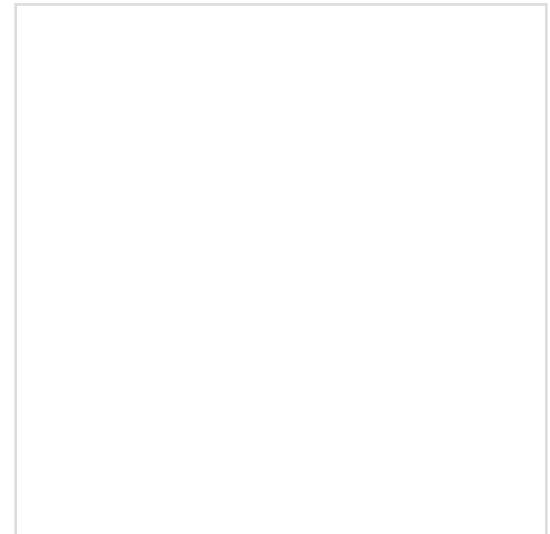

PARTS IMAGE

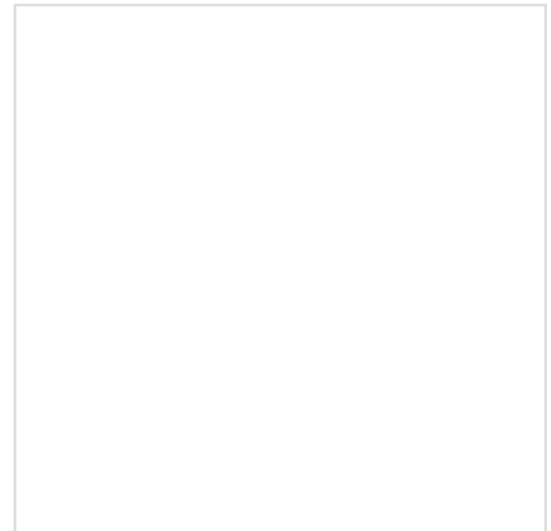

BOX IMAGE

RB-1108

CLUTCH BEARING MADE IN

Parts Number : RB-1108

Manufacture 1 : NSK

Manufacturer Number 1 : 56TKZ3701604

Manufacture 2 :

Manufacturer Number 2 :

M.S.R.P 04/2010 :

Description: CLUTCH BEARING MADE IN JAPAN

Application 1 :

Application 2 :

Application 3 :

Application 4 :

Application 5 :

Application 6 :

Application 7 :

Application 8 :

Application 9 :

Application 10 :

Application 11 :

Application 12 :

ZOOM+

ZOOM-



PARTS IMAGE



BOX IMAGE

RB-1109

CLUTCH BEARING MADE IN

Parts Number : RB-1109

Manufacture 1 :

Manufacturer Number 1 : 840

Manufacture 2 :

Manufacturer Number 2 :

M.S.R.P 04/2010 :

Description: CLUTCH BEARING MADE IN JAPAN

Application 1 :

Application 2 :

Application 3 :

Application 4 :

Application 5 :

Application 6 :

Application 7 :

Application 8 :

Application 9 :

Application 10 :

Application 11 :

Application 12 :

ZOOM+

ZOOM-

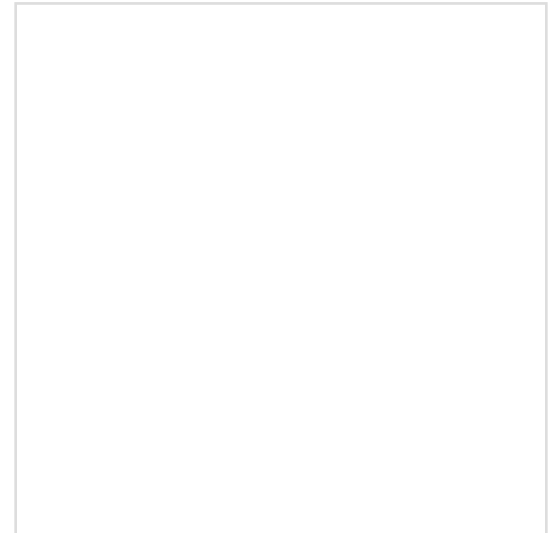

PARTS IMAGE

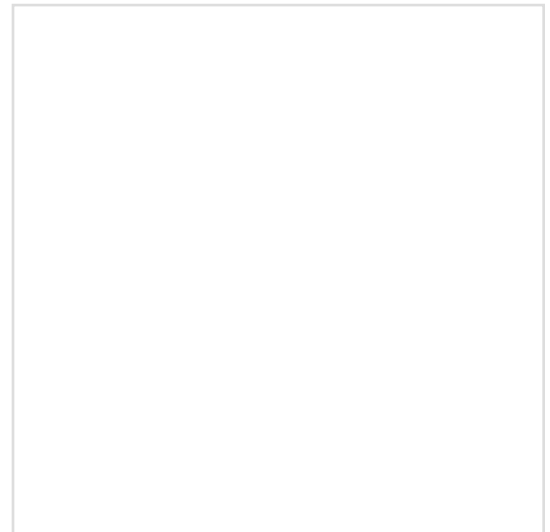

BOX IMAGE

RB-1110

Parts Number : RB-1110

Manufacture 1 : KOYO

Manufacturer Number 1 : CBU543625J

Manufacture 2 :

Manufacture Number 2 :

M.S.R.P 04/2010 :

Description: CLUTCH BARRING MADE IN JAPAN

Application 1 :

Application 2 :

Application 3 :

Application 4 :

Application 5 :

Application 6 :

Application 7 :

Application 8 :

Application 9 :

Application 10 :

Application 11 :

Application 12 :

CLUTCH BARRING MADE IN

ZOOM+

ZOOM-



PARTS IMAGE



BOX IMAGE

RB-1111

CLUTCH BEARING MADE IN

Parts Number : RB-1111

Manufacture 1 :

Manufacturer Number 1 :

842

Manufacture 2 :

Manufacture Number 2 :

M.S.R.P 04/2010 :

Description:

CLUTCH BEARING MADE IN JAPAN

Application 1 :

Application 2 :

Application 3 :

Application 4 :

Application 5 :

Application 6 :

Application 7 :

Application 8 :

Application 9 :

Application 10 :

Application 11 :

Application 12 :

ZOOM+

ZOOM-

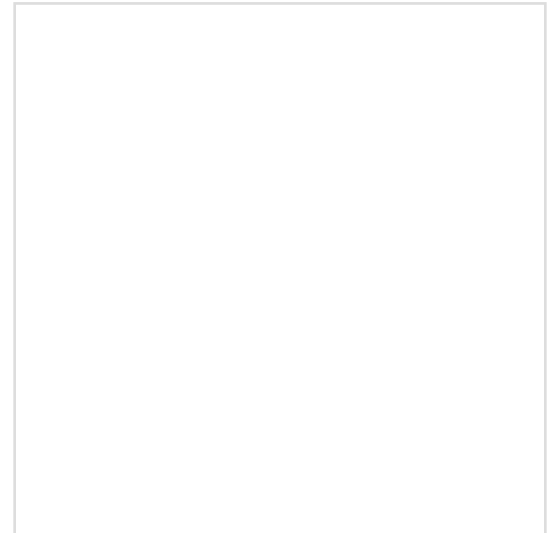

PARTS IMAGE

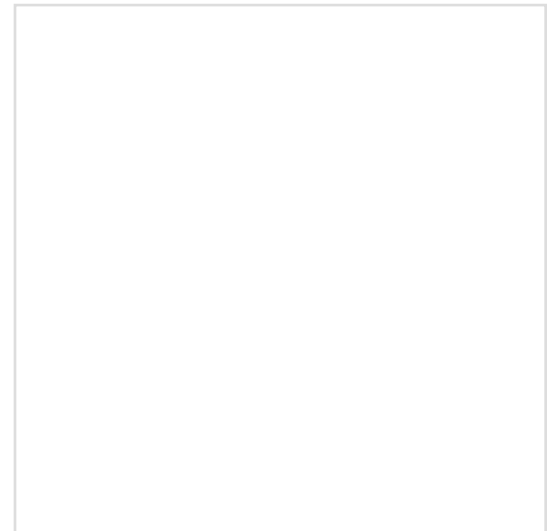

BOX IMAGE

RB-1112

CLUTCH BEARING MADE IN

Parts Number : RB-1112

Manufacture 1 :

Manufacturer Number 1 : 843

Manufacture 2 :

Manufacturer Number 2 :

M.S.R.P 04/2010 :

Description: CLUTCH BEARING MADE IN JAPAN

Application 1 :

Application 2 :

Application 3 :

Application 4 :

Application 5 :

Application 6 :

Application 7 :

Application 8 :

Application 9 :

Application 10 :

Application 11 :

Application 12 :

ZOOM+

ZOOM-

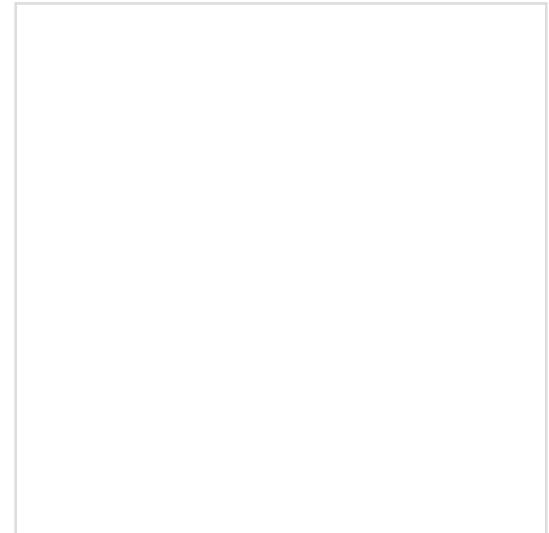

PARTS IMAGE

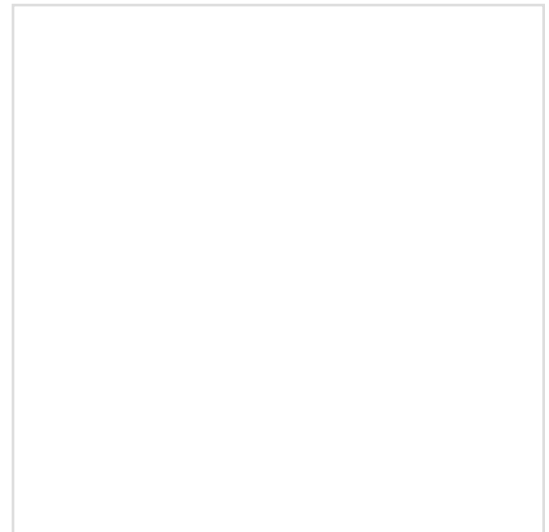

BOX IMAGE

RB-1122

CLUTCH BEARING MADE IN

Parts Number : RB-1122

Manufacture 1 : NTN

Manufacturer Number 1 :

Manufacture 2 :

Manufacture Number 2 :

M.S.R.P 04/2010 :

Description: CLUTCH BEARING MADE IN JAPAN

Application 1 :

Application 2 :

Application 3 :

Application 4 :

Application 5 :

Application 6 :

Application 7 :

Application 8 :

Application 9 :

Application 10 :

Application 11 :

Application 12 :

ZOOM+

ZOOM-



PARTS IMAGE



BOX IMAGE

RB-1149

CLUTCH BEARING MADE IN

Parts Number : RB-1149

Manufacture 1 : NTN

Manufacturer Number 1 :

Manufacture 2 :

Manufacture Number 2 :

M.S.R.P 04/2010 :

Description: CLUTCH BEARING MADE IN JAPAN

Application 1 :

Application 2 :

Application 3 :

Application 4 :

Application 5 :

Application 6 :

Application 7 :

Application 8 :

Application 9 :

Application 10 :

Application 11 :

Application 12 :

ZOOM+

ZOOM-



PARTS IMAGE



BOX IMAGE

RB-1150

Parts Number : RB-1150

Manufacture 1 : NTN

Manufacturer Number 1 :

Manufacture 2 :

Manufacturer Number 2 :

M.S.R.P 04/2010 :

Description: CLUTCH BEARING MADE IN JAPAN

Application 1 :

Application 2 :

Application 3 :

Application 4 :

Application 5 :

Application 6 :

Application 7 :

Application 8 :

Application 9 :

Application 10 :

Application 11 :

Application 12 :

CLUTCH BEARING MADE IN

ZOOM+

ZOOM-



PARTS IMAGE



BOX IMAGE

RB-1201

Parts Number : RB-1201

Manufacture 1 : NAK

Manufacturer Number 1 : 45TNK20A

Manufacture 2 :

Manufacturer Number 2 :

M.S.R.P 04/2010 :

Description: CLUTCH BEARING MADE IN JAPAN

Application 1 :

Application 2 :

Application 3 :

Application 4 :

Application 5 :

Application 6 :

Application 7 :

Application 8 :

Application 9 :

Application 10 :

Application 11 :

Application 12 :

CLUTCH BEARING MADE IN

ZOOM+

ZOOM-



PARTS IMAGE



BOX IMAGE

RB-1202

CLUTCH BEARING MADE IN

Parts Number : RB-1202

Manufacture 1 : NSK

Manufacturer Number 1 : TK52Z-1B

Manufacture 2 :

Manufacturer Number 2 :

M.S.R.P 04/2010 :

Description: CLUTCH BEARING MADE IN JAPAN

Application 1 :

Application 2 :

Application 3 :

Application 4 :

Application 5 :

Application 6 :

Application 7 :

Application 8 :

Application 9 :

Application 10 :

Application 11 :

Application 12 :

ZOOM+

ZOOM-



PARTS IMAGE



BOX IMAGE

RB-1203

CLUTCH BEARING MADE IN

Parts Number : RB-1203

Manufacture 1 : NSK

Manufacturer Number 1 : TK55-1A1

Manufacture 2 :

Manufacturer Number 2 :

M.S.R.P 04/2010 :

Description: CLUTCH BEARING MADE IN JAPAN

Application 1 :

Application 2 :

Application 3 :

Application 4 :

Application 5 :

Application 6 :

Application 7 :

Application 8 :

Application 9 :

Application 10 :

Application 11 :

Application 12 :

ZOOM+ ZOOM-



PARTS IMAGE



BOX IMAGE

RB-1204

CLUTCH BEARING MADE IN

Parts Number : RB-1204

Manufacture 1 : NSK

Manufacturer Number 1 : TK70-1A1

Manufacture 2 :

Manufacturer Number 2 :

M.S.R.P 04/2010 :

Description: CLUTCH BEARING MADE IN JAPAN

Application 1 :

Application 2 :

Application 3 :

Application 4 :

Application 5 :

Application 6 :

Application 7 :

Application 8 :

Application 9 :

Application 10 :

Application 11 :

Application 12 :

ZOOM+ ZOOM-



PARTS IMAGE



BOX IMAGE

RB-1205

CLUTCH BEARING MADE IN

Parts Number : RB-1205

Manufacture 1 : NSK

Manufacturer Number 1 : 65TNK20

Manufacture 2 :

Manufacturer Number 2 :

M.S.R.P 04/2010 :

Description: CLUTCH BEARING MADE IN JAPAN

Application 1 :

Application 2 :

Application 3 :

Application 4 :

Application 5 :

Application 6 :

Application 7 :

Application 8 :

Application 9 :

Application 10 :

Application 11 :

Application 12 :

ZOOM+ ZOOM-



PARTS IMAGE



BOX IMAGE

RB-1206

CLUTCH BEARING MADE IN

Parts Number : RB-1206

Manufacture 1 : NSK

Manufacturer Number 1 : 78TKC5401

Manufacture 2 :

Manufacturer Number 2 :

M.S.R.P 04/2010 :

Description: CLUTCH BEARING MADE IN JAPAN

Application 1 :

Application 2 :

Application 3 :

Application 4 :

Application 5 :

Application 6 :

Application 7 :

Application 8 :

Application 9 :

Application 10 :

Application 11 :

Application 12 :

ZOOM+

ZOOM-



PARTS IMAGE



BOX IMAGE

RB-1207

CLUTCH BEARING MADE IN

Parts Number : RB-1207

Manufacture 1 :

Manufacturer Number 1 :

850

Manufacture 2 :

Manufacture Number 2 :

M.S.R.P 04/2010 :

Description:

CLUTCH BEARING MADE IN JAPAN

Application 1 :

Application 2 :

Application 3 :

Application 4 :

Application 5 :

Application 6 :

Application 7 :

Application 8 :

Application 9 :

Application 10 :

Application 11 :

Application 12 :

ZOOM+

ZOOM-

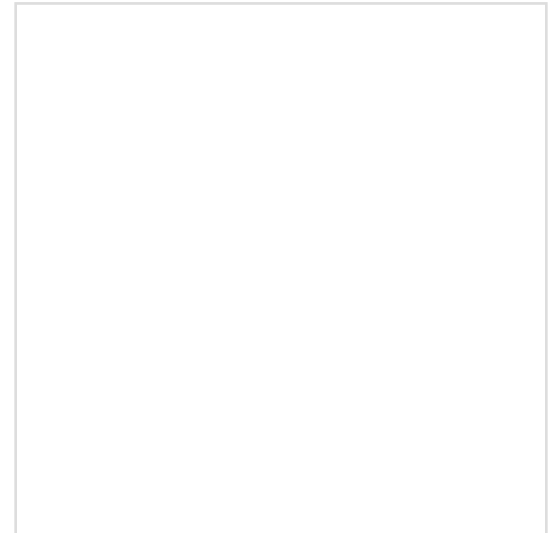

PARTS IMAGE

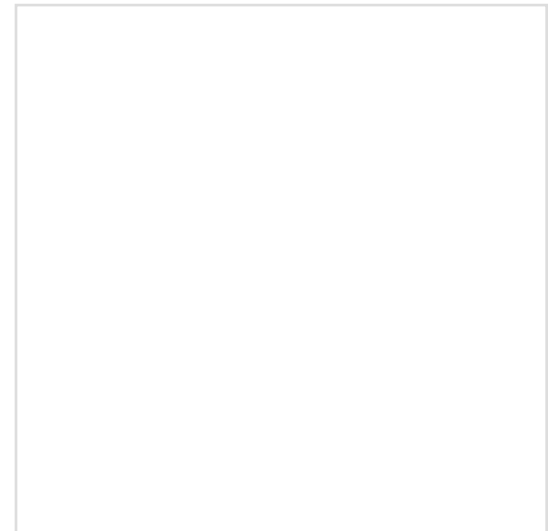

BOX IMAGE

RB-1208

CLUTCH BEARING MADE IN

Parts Number : RB-1208

Manufacture 1 :

Manufacturer Number 1 : 851

Manufacture 2 :

Manufacture Number 2 :

M.S.R.P 04/2010 :

Description: CLUTCH BEARING MADE IN JAPAN

Application 1 :

Application 2 :

Application 3 :

Application 4 :

Application 5 :

Application 6 :

Application 7 :

Application 8 :

Application 9 :

Application 10 :

Application 11 :

Application 12 :

ZOOM+

ZOOM-



PARTS IMAGE

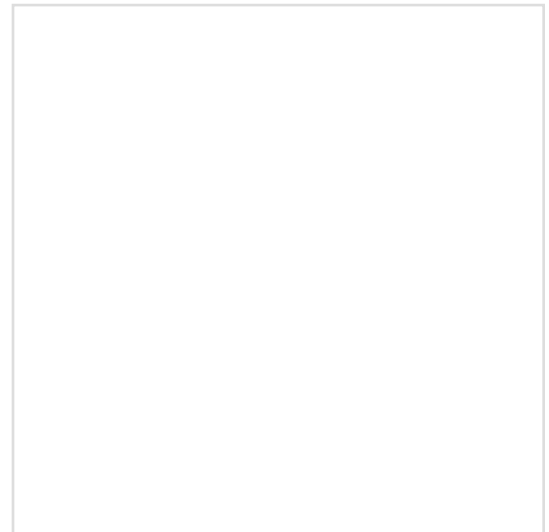

BOX IMAGE

RB-1210

CLUTCH BEARING MADE IN

Parts Number : RB-1210

Manufacture 1 : NSK

Manufacturer Number 1 : 40TMK20B1

Manufacture 2 :

Manufacture Number 2 :

M.S.R.P 04/2010 :

Description: CLUTCH BEARING MADE IN JAPAN

Application 1 :

Application 2 :

Application 3 :

Application 4 :

Application 5 :

Application 6 :

Application 7 :

Application 8 :

Application 9 :

Application 10 :

Application 11 :

Application 12 :

ZOOM+ ZOOM-



PARTS IMAGE



BOX IMAGE

RB-1211

CLUTCH BEARING MADE IN

Parts Number : RB-1211

Manufacture 1 : NSK

Manufacturer Number 1 : 48TKA3210

Manufacture 2 :

Manufacture Number 2 :

M.S.R.P 04/2010 :

Description: CLUTCH BEARING MADE IN JAPAN

Application 1 :

Application 2 :

Application 3 :

Application 4 :

Application 5 :

Application 6 :

Application 7 :

Application 8 :

Application 9 :

Application 10 :

Application 11 :

Application 12 :

ZOOM+ ZOOM-



PARTS IMAGE



BOX IMAGE

RB-1212

CLUTCH BEARING MADE IN

Parts Number : RB-1212

Manufacture 1 :

Manufacturer Number 1 :

854

Manufacture 2 :

Manufacture Number 2 :

M.S.R.P 04/2010 :

Description:

CLUTCH BEARING MADE IN JAPAN

Application 1 :

Application 2 :

Application 3 :

Application 4 :

Application 5 :

Application 6 :

Application 7 :

Application 8 :

Application 9 :

Application 10 :

Application 11 :

Application 12 :

ZOOM+

ZOOM-

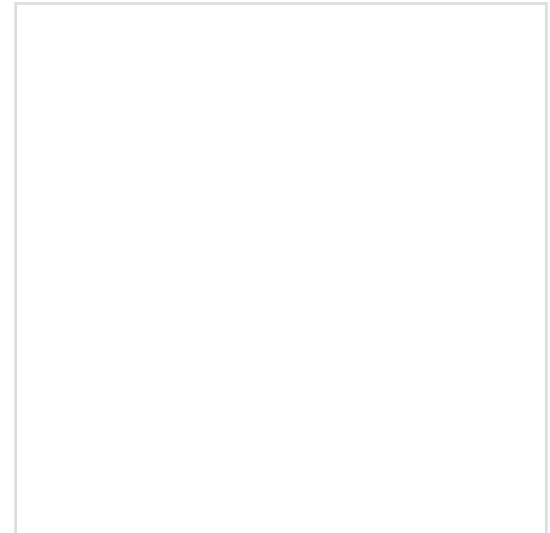

PARTS IMAGE

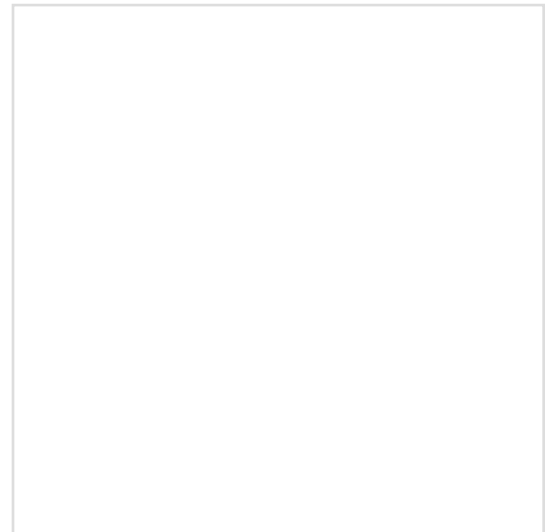

BOX IMAGE

RB-1213

CLUTCH BEARING MADE IN

Parts Number : RB-1213

Manufacture 1 :

Manufacturer Number 1 :

855

Manufacture 2 :

Manufacture Number 2 :

M.S.R.P 04/2010 :

Description:

CLUTCH BEARING MADE IN JAPAN

Application 1 :

Application 2 :

Application 3 :

Application 4 :

Application 5 :

Application 6 :

Application 7 :

Application 8 :

Application 9 :

Application 10 :

Application 11 :

Application 12 :

ZOOM+

ZOOM-

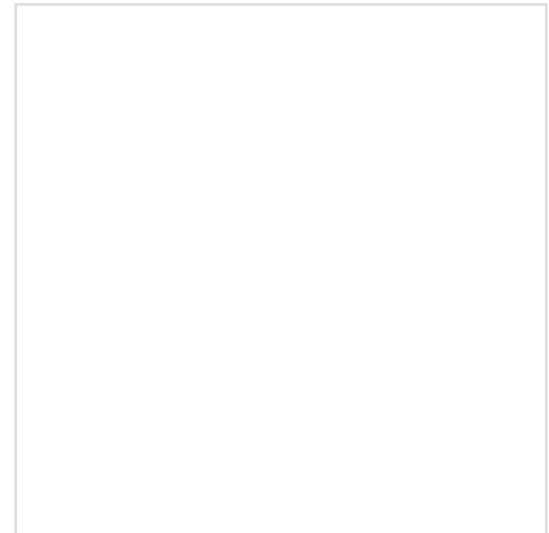

PARTS IMAGE

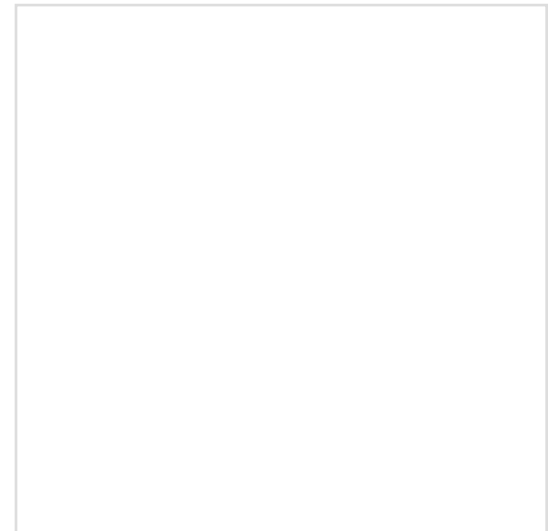

BOX IMAGE

RB-1214

CLUTCH BEARING MADE IN

Parts Number : RB-1214

Manufacture 1 :

Manufacturer Number 1 :

856

Manufacture 2 :

Manufacture Number 2 :

M.S.R.P 04/2010 :

Description:

CLUTCH BEARING MADE IN JAPAN

Application 1 :

Application 2 :

Application 3 :

Application 4 :

Application 5 :

Application 6 :

Application 7 :

Application 8 :

Application 9 :

Application 10 :

Application 11 :

Application 12 :

ZOOM+

ZOOM-

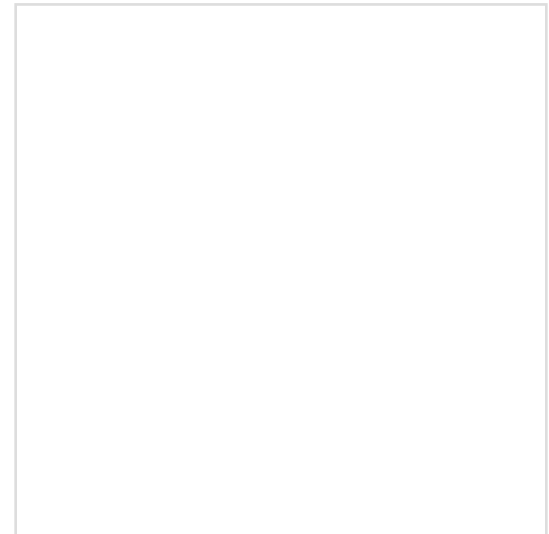

PARTS IMAGE

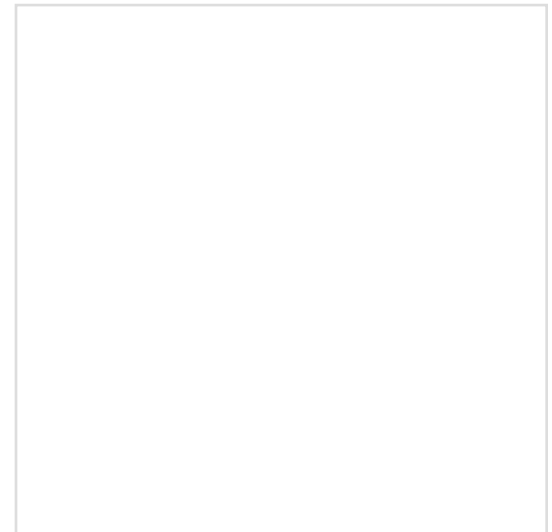

BOX IMAGE

RB-1215

CLUTCH BEARING MADE IN

Parts Number : RB-1215

Manufacture 1 : KOYO

Manufacturer Number 1 : RCT4700SA FG

Manufacture 2 :

Manufacturer Number 2 :

M.S.R.P 04/2010 :

Description: CLUTCH BEARING MADE IN JAPAN

Application 1 :

Application 2 :

Application 3 :

Application 4 :

Application 5 :

Application 6 :

Application 7 :

Application 8 :

Application 9 :

Application 10 :

Application 11 :

Application 12 :

ZOOM+

ZOOM-



PARTS IMAGE



BOX IMAGE

RB-1216

CLUTCH BEARING MADE IN

Parts Number : RB-1216

Manufacture 1 :

Manufacturer Number 1 :

858

Manufacture 2 :

Manufacture Number 2 :

M.S.R.P 04/2010 :

Description:

CLUTCH BEARING MADE IN JAPAN

Application 1 :

Application 2 :

Application 3 :

Application 4 :

Application 5 :

Application 6 :

Application 7 :

Application 8 :

Application 9 :

Application 10 :

Application 11 :

Application 12 :

ZOOM+

ZOOM-

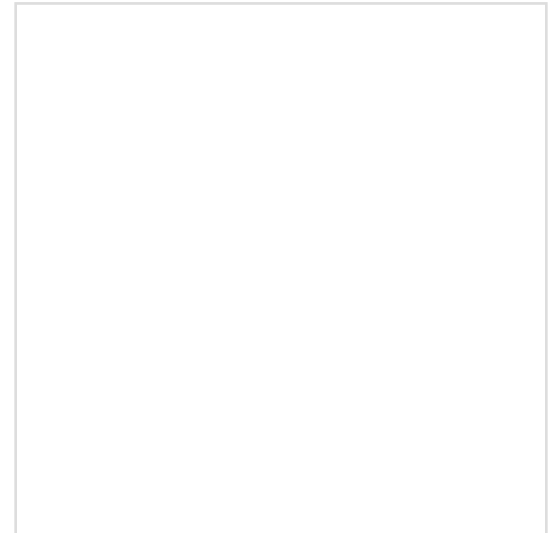

PARTS IMAGE

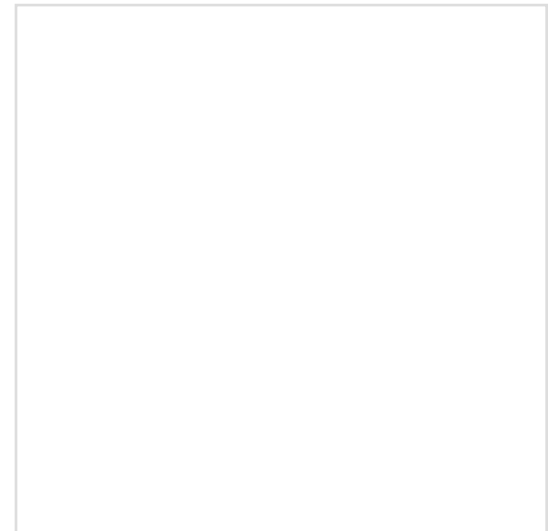

BOX IMAGE

RB-1217

CLUTCH BEARING MADE IN

Parts Number : RB-1217

Manufacture 1 :

Manufacturer Number 1 :

859

Manufacture 2 :

Manufacture Number 2 :

M.S.R.P 04/2010 :

Description:

CLUTCH BEARING MADE IN JAPAN

Application 1 :

Application 2 :

Application 3 :

Application 4 :

Application 5 :

Application 6 :

Application 7 :

Application 8 :

Application 9 :

Application 10 :

Application 11 :

Application 12 :

ZOOM+

ZOOM-

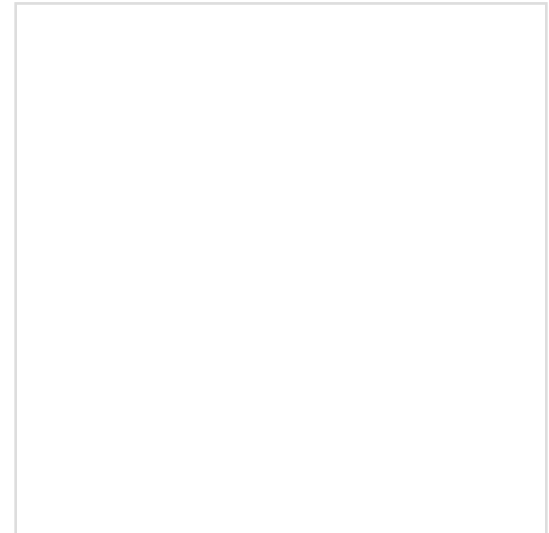

PARTS IMAGE

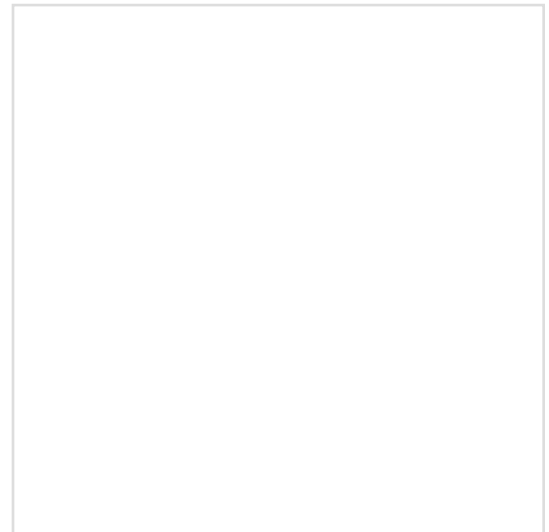

BOX IMAGE

RB-1218

CLUTCH BEARING MADE IN

Parts Number : RB-1218

Manufacture 1 : NSK

Manufacturer Number 1 : 65TNK003

Manufacture 2 :

Manufacture Number 2 :

M.S.R.P 04/2010 :

Description: CLUTCH BEARING MADE IN JAPAN

Application 1 :

Application 2 :

Application 3 :

Application 4 :

Application 5 :

Application 6 :

Application 7 :

Application 8 :

Application 9 :

Application 10 :

Application 11 :

Application 12 :

ZOOM+ ZOOM-



PARTS IMAGE



BOX IMAGE

RF03-12-720

Parts Number : RF03-12-720

Manufacture 1 : NTN

Manufacturer Number 1 : X3-JPU60-57+57UC4

Manufacture 2 :

Manufacture Number 2 :

M.S.R.P 04/2010 :

Description:

Application 1 :

Application 2 :

Application 3 :

Application 4 :

Application 5 :

Application 6 :

Application 7 :

Application 8 :

Application 9 :

Application 10 :

Application 11 :

Application 12 :

ZOOM+

ZOOM-

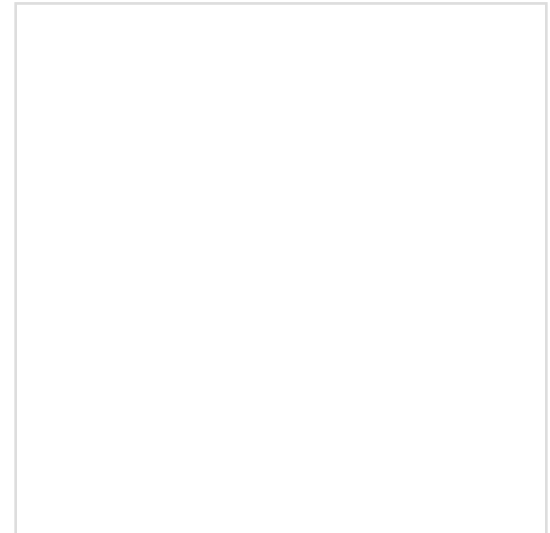

PARTS IMAGE

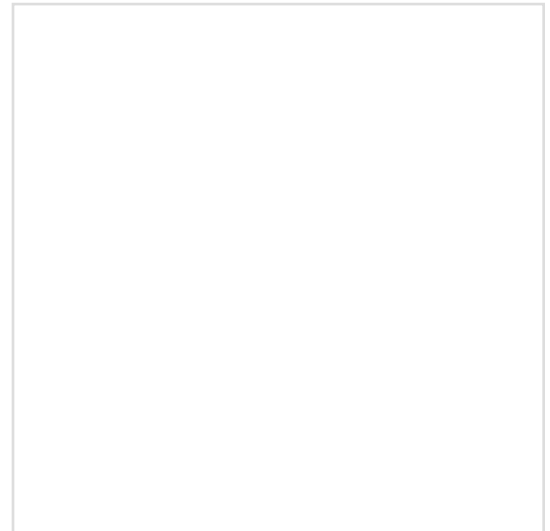

BOX IMAGE

V1-2140

Parts Number : V1-2140

Manufacture 1 : PARUAT / HITACHI

Manufacturer Number 1 : V1-2140 DS

Manufacture 2 :

Manufacture Number 2 : 30100-71N04

M.S.R.P 04/2010 :

Description: CLUTCH DISC MADE IN JAPAN

Application 1 : 30100-76N04

Application 2 : 30100-1N04

Application 3 : NISSAN CA`18 85-87

Application 4 : NISSAN SR18 1990

Application 5 :

Application 6 :

Application 7 :

Application 8 :

Application 9 :

Application 10 :

Application 11 :

Application 12 :

CLUTCH DISC MADE IN JAPAN

ZOOM+

ZOOM-



PARTS IMAGE



BOX IMAGE

V1-2230

Parts Number :	V1-2230
Manufacture 1 :	PARUAT / HITACHI <input type="button" value="v"/>
Manufacturer Number 1 :	30100-31U02
Manufacture 2 :	<input type="button" value="v"/>
Manufacturer Number 2 :	30100-52F03/80S08
M.S.R.P 04/2010 :	
Description:	CLUTCH DISC MADE IN JAPAN VALEO

CLUTCH DISC MADE IN JAPAN

ZOOM+ ZOOM-



PARTS IMAGE

- Application 1 :** NISSAN SC33 RD28 88-90
- Application 2 :** NISSAN HR31 RB20 87-89
- Application 3 :**
- Application 4 :**
- Application 5 :**
- Application 6 :**
- Application 7 :**
- Application 8 :**
- Application 9 :**
- Application 10 :**
- Application 11 :**
- Application 12 :**



BOX IMAGE

V1-2500

CLUTCH DISC MADE IN JAPAN

Parts Number :	V1-2500
Manufacture 1 :	PARUAT / HITACHI <input type="button" value="v"/>
Manufacturer Number 1 :	V1-2500 D4
Manufacture 2 :	<input type="button" value="v"/>
Manufacture Number 2 :	30100-OW000
M.S.R.P 04/2010 :	
Description:	CLUTCH DISC MADE IN JAPAN 250X160 / 25.4X T24

ZOOM+ ZOOM-



PARTS IMAGE

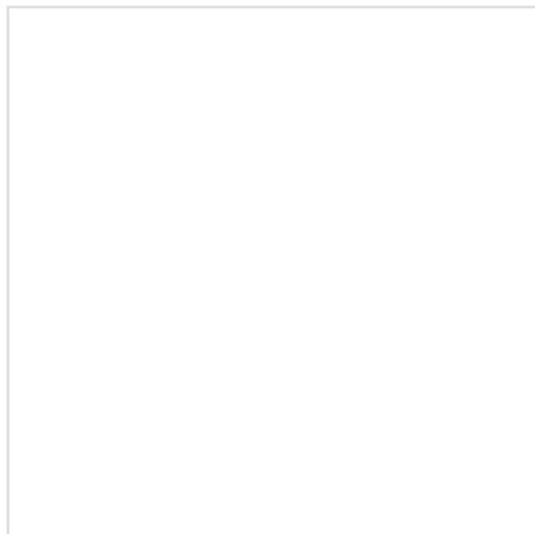

BOX IMAGE

- Application 1 :** 30100-22P00
- Application 2 :** 30100-88G00/01
- Application 3 :** NISSAN VG30 1987
- Application 4 :** NISSAN ED33 82-82
- Application 5 :** DK # NSD037, NSD053Y
- Application 6 :** ASCO # DN-018, DN-063
- Application 7 :**
- Application 8 :**
- Application 9 :**
- Application 10 :**
- Application 11 :**
- Application 12 :**

V2-2162

CLUTCH DISC MADE IN JAPAN

Parts Number : V2-2162

Manufacture 1 : PARUAT / HITACHI

Manufacturer Number 1 : 282

Manufacture 2 :

Manufacture Number 2 :

M.S.R.P 04/2010 :

Description: CLUTCH DISC MADE IN JAPAN

Application 1 :

Application 2 :

Application 3 :

Application 4 :

Application 5 :

Application 6 :

Application 7 :

Application 8 :

Application 9 :

Application 10 :

Application 11 :

Application 12 :

ZOOM+

ZOOM-



PARTS IMAGE

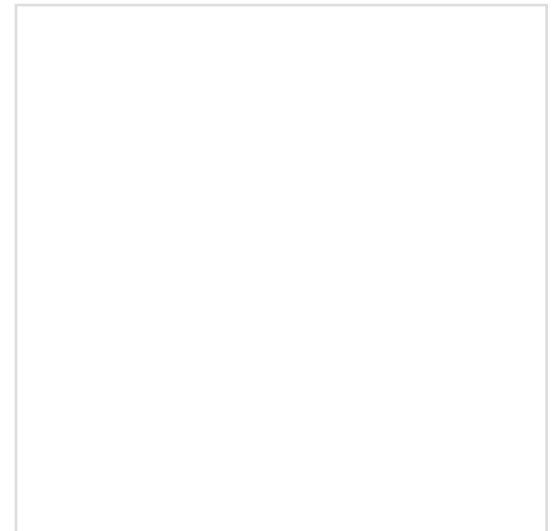

BOX IMAGE

V2-2407

CLUTCH COVER MADE IN

Parts Number :	V2-2407
Manufacture 1 :	PARUAT / HITACHI <input type="button" value="v"/>
Manufacturer Number 1 :	30210-6E600
Manufacture 2 :	<input type="button" value="v"/>
Manufacture Number 2 :	30210-85E01
M.S.R.P 04/2010 :	
Description:	CLUTCH COVER MADE IN JAPAN VALEO

- Application 1 :** NISSAN MAXIMA HJ30 VG30E 89-90
- Application 2 :**
- Application 3 :**
- Application 4 :**
- Application 5 :**
- Application 6 :**
- Application 7 :**
- Application 8 :**
- Application 9 :**
- Application 10 :**
- Application 11 :**
- Application 12 :**

ZOOM+ ZOOM-



PARTS IMAGE



BOX IMAGE

V2-2503

CLUTCH COVER MADE IN

Parts Number :	V2-2503
Manufacture 1 :	PARUAT / HITACHI <input type="button" value="v"/>
Manufacturer Number 1 :	30210-40P00
Manufacture 2 :	<input type="button" value="v"/>
Manufacturer Number 2 :	30210-4
M.S.R.P 04/2010 :	
Description:	CLUTCH COVER MADE IN JAPAN

ZOOM+ ZOOM-



PARTS IMAGE



BOX IMAGE

- Application 1 : NISSAN Z32 VG30DTT 89
- Application 2 :
- Application 3 :
- Application 4 :
- Application 5 :
- Application 6 :
- Application 7 :
- Application 8 :
- Application 9 :
- Application 10 :
- Application 11 :
- Application 12 :

V3-023

WATER PUMP MADE IN JAPAN

Parts Number : V3-023

Manufacture 1 : PARUAT / HITACHI

Manufacturer Number 1 : 21010-50A94

Manufacture 2 :

Manufacturer Number 2 :

M.S.R.P 04/2010 :

Description: WATER PUMP MADE IN JAPAN

Application 1 :

Application 2 :

Application 3 :

Application 4 :

Application 5 :

Application 6 :

Application 7 :

Application 8 :

Application 9 :

Application 10 :

Application 11 :

Application 12 :

ZOOM+

ZOOM-



PARTS IMAGE



BOX IMAGE

V3-032

CLUTCH DISC MADE IN JAPAN

Parts Number : V3-032

Manufacture 1 : PARUAT / HITACHI

Manufacturer Number 1 : 286I

Manufacture 2 :

Manufacture Number 2 :

M.S.R.P 04/2010 :

Description: CLUTCH DISC MADE IN JAPAN

Application 1 :

Application 2 :

Application 3 :

Application 4 :

Application 5 :

Application 6 :

Application 7 :

Application 8 :

Application 9 :

Application 10 :

Application 11 :

Application 12 :

ZOOM+

ZOOM-



PARTS IMAGE

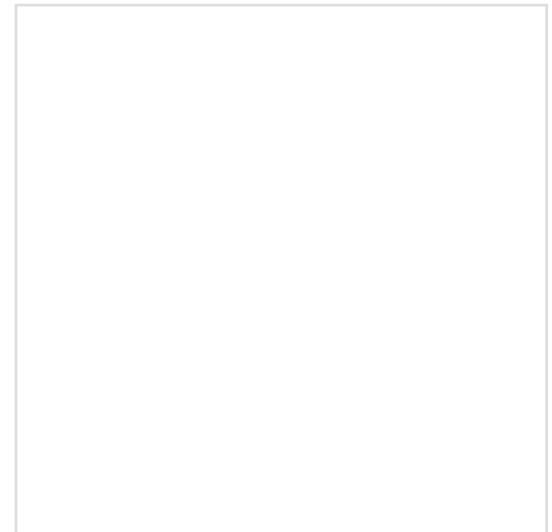

BOX IMAGE

V3-055

WATER PUMP MADE IN JAPAN

Parts Number :	V3-055
Manufacture 1 :	PARUAT / HITACHI <input type="button" value="v"/>
Manufacturer Number 1 :	21010-30R00
Manufacture 2 :	<input type="button" value="v"/>
Manufacturer Number 2 :	21010-30405
M.S.R.P 04/2010 :	
Description:	WATER PUMP MADE IN JAPAN

- Application 1 :** PRAIR KA24E 90-
- Application 2 :**
- Application 3 :**
- Application 4 :**
- Application 5 :**
- Application 6 :**
- Application 7 :**
- Application 8 :**
- Application 9 :**
- Application 10 :**
- Application 11 :**
- Application 12 :**

ZOOM+ ZOOM-



PARTS IMAGE



BOX IMAGE

V3-110

WATER PUMP MADE IN JAPAN

Parts Number : V3-110

Manufacture 1 : PARUAT / HITACHI

Manufacturer Number 1 : 21010-67U25

Manufacture 2 :

Manufacturer Number 2 :

M.S.R.P 04/2010 :

Description: WATER PUMP MADE IN JAPAN

Application 1 : INFINTI Q45 VH45DE 1993-

Application 2 : NISSAN PRESIDENT PG50 / VH45DE 1993-

Application 3 :

Application 4 :

Application 5 :

Application 6 :

Application 7 :

Application 8 :

Application 9 :

Application 10 :

Application 11 :

Application 12 :

ZOOM+

ZOOM-



PARTS IMAGE



BOX IMAGE

V3-120

WATER PUMP MADE IN JAPAN

Parts Number : V3-120

Manufacture 1 : PARUAT / HITACHI

Manufacturer Number 1 : 21010-1E400

Manufacture 2 :

Manufacturer Number 2 :

M.S.R.P 04/2010 :

Description: WATER PUMP MADE IN JAPAN

Application 1 : NISSAN KA24DE 1993

Application 2 :

Application 3 :

Application 4 :

Application 5 :

Application 6 :

Application 7 :

Application 8 :

Application 9 :

Application 10 :

Application 11 :

Application 12 :

ZOOM+

ZOOM-



PARTS IMAGE



BOX IMAGE

V3-124

WATER PUMP MADE IN JAPAN

Parts Number : V3-124

Manufacture 1 : PARUAT / HITACHI

Manufacturer Number 1 : 21010-31U25

Manufacture 2 :

Manufacturer Number 2 :

M.S.R.P 04/2010 :

Description: WATER PUMP MADE IN JAPAN

Application 1 : INFINITI I30 VQ30DE

Application 2 :

Application 3 :

Application 4 :

Application 5 :

Application 6 :

Application 7 :

Application 8 :

Application 9 :

Application 10 :

Application 11 :

Application 12 :

ZOOM+

ZOOM-



PARTS IMAGE



BOX IMAGE

V3-129

WATER PUMP MADE IN JAPAN

Parts Number : V3-129

Manufacture 1 : PARUAT / HITACHI

Manufacturer Number 1 : 285

Manufacture 2 :

Manufacture Number 2 :

M.S.R.P 04/2010 :

Description: WATER PUMP MADE IN JAPAN

Application 1 :

Application 2 :

Application 3 :

Application 4 :

Application 5 :

Application 6 :

Application 7 :

Application 8 :

Application 9 :

Application 10 :

Application 11 :

Application 12 :

ZOOM+

ZOOM-

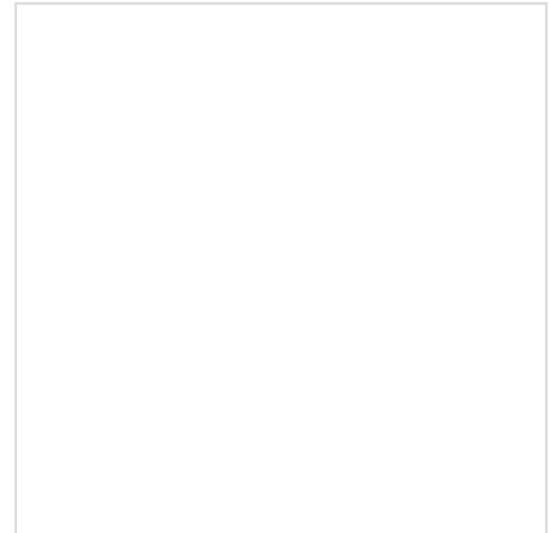

PARTS IMAGE

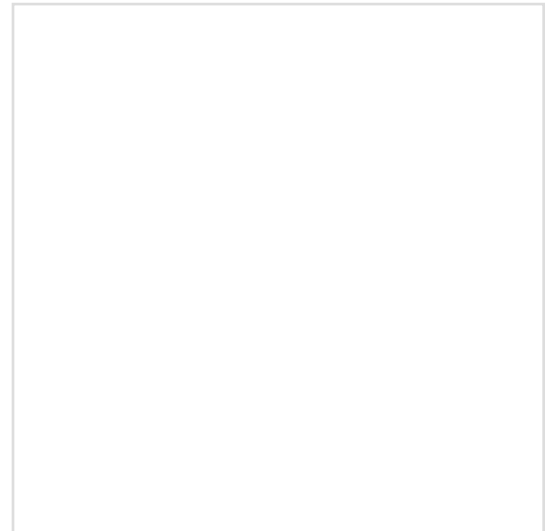

BOX IMAGE

V4-020

OIL PUMP MADE IN JAPAN

Parts Number : V4-020

Manufacture 1 : PARUAT / HITACHI

Manufacturer Number 1 : 15010-V5002

Manufacture 2 :

Manufacturer Number 2 :

M.S.R.P 04/2010 :

Description: OIL PUMP MADE IN JAPAN

Application 1 : NISSAN 300ZX V6 W/O TURBO 84-87

Application 2 : NISSAN MAXIMA V6 87

Application 3 : NISSAN 200ZX V6 87

Application 4 :

Application 5 :

Application 6 :

Application 7 :

Application 8 :

Application 9 :

Application 10 :

Application 11 :

Application 12 :

ZOOM+

ZOOM-



PARTS IMAGE

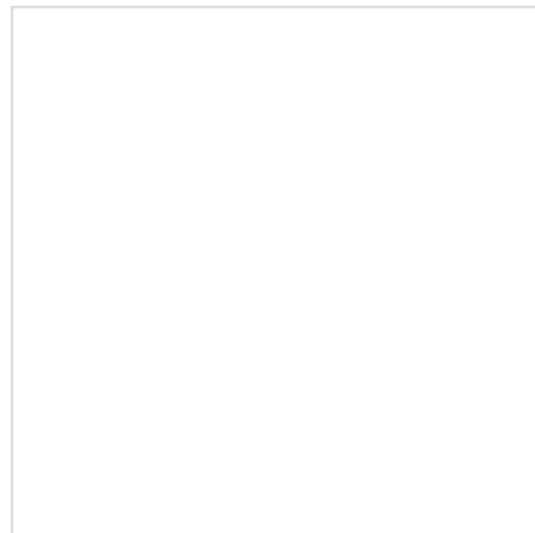

BOX IMAGE

V4-047

OIL PUMP MADE IN JAPAN

Parts Number :	V4-047
Manufacture 1 :	PARUAT / HITACHI <input type="button" value="v"/>
Manufacturer Number 1 :	15010-21001
Manufacture 2 :	<input type="button" value="v"/>
Manufacturer Number 2 :	
M.S.R.P 04/2010 :	
Description:	OIL PUMP MADE IN JAPAN



PARTS IMAGE



BOX IMAGE

- Application 1 : NISSAN L16/ L20B
- Application 2 :
- Application 3 :
- Application 4 :
- Application 5 :
- Application 6 :
- Application 7 :
- Application 8 :
- Application 9 :
- Application 10 :
- Application 11 :
- Application 12 :

WB-0101

WHEEL BEARING

Parts Number : WB-0101

Manufacture 1 : NSK

Manufacturer Number 1 : B32-10C5

Manufacture 2 :

Manufacturer Number 2 :

M.S.R.P 04/2010 :

Description: WHEEL BEARING

Application 1 :

Application 2 :

Application 3 :

Application 4 :

Application 5 :

Application 6 :

Application 7 :

Application 8 :

Application 9 :

Application 10 :

Application 11 :

Application 12 :

ZOOM+

ZOOM-



PARTS IMAGE

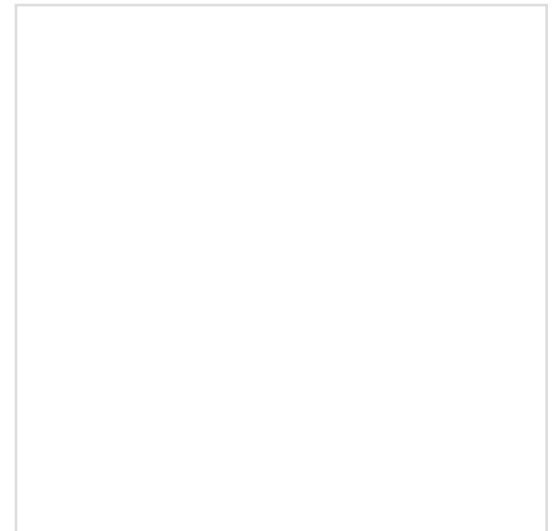

BOX IMAGE

WB-0101A

Parts Number : WB-0101A

Manufacture 1 : NSK

Manufacturer Number 1 : B32-10C5+08R1

Manufacture 2 : NACHI

Manufacture Number 2 :

M.S.R.P 04/2010 :

Description: WHEEL BEARING MADE IN JAPAN

Application 1 :

Application 2 :

Application 3 :

Application 4 :

Application 5 :

Application 6 :

Application 7 :

Application 8 :

Application 9 :

Application 10 :

Application 11 :

Application 12 :

WHEEL BEARING MADE IN

ZOOM+ ZOOM-



PARTS IMAGE



BOX IMAGE

WB-0102

WHEEL BEARING

Parts Number : WB-0102

Manufacture 1 : NSK

Manufacturer Number 1 : 28BWD01JCA48

Manufacture 2 :

Manufacture Number 2 :

M.S.R.P 04/2010 :

Description: WHEEL BEARING

Application 1 :

Application 2 :

Application 3 :

Application 4 :

Application 5 :

Application 6 :

Application 7 :

Application 8 :

Application 9 :

Application 10 :

Application 11 :

Application 12 :

ZOOM+

ZOOM-



PARTS IMAGE

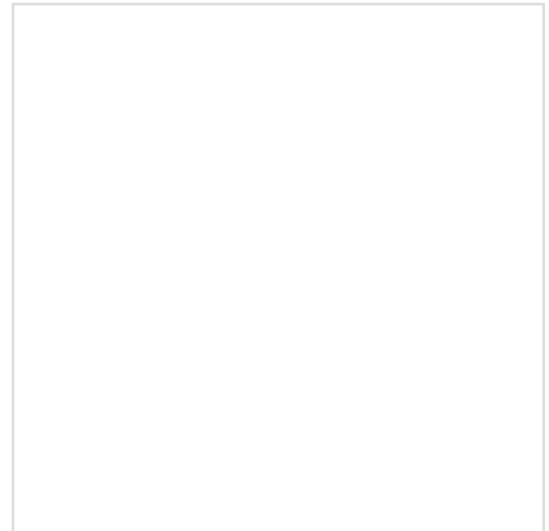

BOX IMAGE

WB-0103

WHEEL BEARING MADE IN

Parts Number : WB-0103

Manufacture 1 : NSK

Manufacturer Number 1 : 31KW01G5

Manufacture 2 :

Manufacture Number 2 : 43210-D0100

M.S.R.P 04/2010 :

Description: WHEEL BEARING MADE IN JAPAN

Application 1 :

Application 2 :

Application 3 :

Application 4 :

Application 5 :

Application 6 :

Application 7 :

Application 8 :

Application 9 :

Application 10 :

Application 11 :

Application 12 :

ZOOM+ ZOOM-



PARTS IMAGE



BOX IMAGE

WB-0104

WHEEL BEARING

Parts Number : WB-0104

Manufacture 1 : NSK

Manufacturer Number 1 : 38BWD06D1ACA01

Manufacture 2 :

Manufacture Number 2 :

M.S.R.P 04/2010 :

Description: WHEEL BEARING

Application 1 :

Application 2 :

Application 3 :

Application 4 :

Application 5 :

Application 6 :

Application 7 :

Application 8 :

Application 9 :

Application 10 :

Application 11 :

Application 12 :

ZOOM+

ZOOM-



PARTS IMAGE

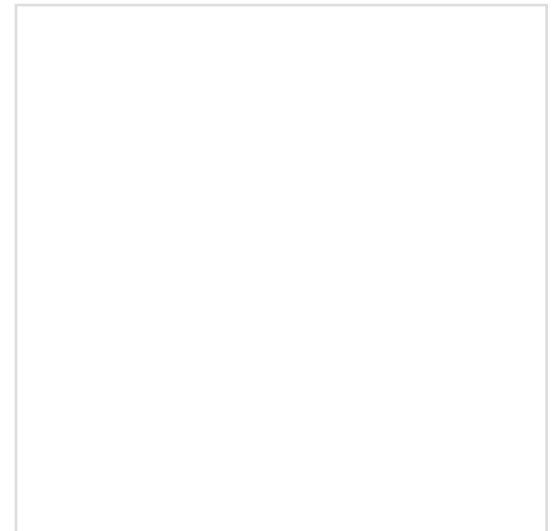

BOX IMAGE

WB-0105

WHEEL BEARING MADE IN

Parts Number : WB-0105

Manufacture 1 : NSK

Manufacturer Number 1 : 42KWD02AG3CA123

Manufacture 2 :

Manufacturer Number 2 : 28016-AA011

M.S.R.P 04/2010 :

Description: WHEEL BEARING MADE IN JAPAN

Application 1 : SUBARU LEGACY W/O TURBO 90-94

Application 2 : SUBARU LEGACY TURBO 90-94

Application 3 : SUBARU IMPREZA 92-97

Application 4 : SUBARU LEGACY 1995

Application 5 : SUBARU LEGACY 14" WHEEL 96-98

Application 6 : SUBARU LEGACY 15" WHEEL 96-98

Application 7 : SUBARU FORESTER 98-02

Application 8 : SUBARU IMPREZA 14" WHEEL 98-00

Application 9 : SUBARU IMPREZA 15" WHEEL 98-00

Application 10 : SUBARU IMPREZA 01

Application 11 : SUBARU IMPREZA OUTBACK 2.0L 2.5L 02-03

Application 12 : SUBARU OUTBACK 2.5L 3.0L BAJA SPORT

ZOOM+

ZOOM-



PARTS IMAGE



BOX IMAGE

WB-0106

Parts Number : WB-0106

Manufacture 1 : KOYO

Manufacturer Number 1 : 6306RS

Manufacture 2 : NACHI

Manufacturer Number 2 : 6306NSE

M.S.R.P 04/2010 :

Description: WHEEL BEARING MADE IN JAPAN

WHEEL BEARING MADE IN

ZOOM+

ZOOM-



PARTS IMAGE

Application 1 :

Application 2 :

Application 3 :

Application 4 :

Application 5 :

Application 6 :

Application 7 :

Application 8 :

Application 9 :

Application 10 :

Application 11 :

Application 12 :



BOX IMAGE

WB-0107

Parts Number : WB-0107

Manufacture 1 : NSK

Manufacturer Number 1 : H02BWD06-JB-5CA01

Manufacture 2 :

Manufacturer Number 2 : 40210-30R01/R06

M.S.R.P 04/2010 :

Description: WHEEL BEARING MADE IN JAPAN

Application 1 : NISSAN MAXIMA 88-91

Application 2 : NISSAN AXXESS 90-

Application 3 : INFINITI G20 91-02

Application 4 : NISSAN MAXIMA SOHC 92-94

Application 5 : NISSAN MAXIMA DOHC 92-94

Application 6 : NISSAN MAXIMA 95-99

Application 7 : INFINITI I30 96-99

Application 8 : NISSAN ALTIMA 98-01

Application 9 :

Application 10 :

Application 11 :

Application 12 :

WHEEL BEARING MADE IN

ZOOM+

ZOOM-



PARTS IMAGE



BOX IMAGE

WB-0109

WHEEL BEARING MADE IN

Parts Number : WB-0109

Manufacture 1 : NSK

Manufacturer Number 1 : LM300849RG3-811R

Manufacture 2 :

Manufacturer Number 2 :

M.S.R.P 04/2010 :

Description: WHEEL BEARING MADE IN JAPAN

Application 1 :

Application 2 :

Application 3 :

Application 4 :

Application 5 :

Application 6 :

Application 7 :

Application 8 :

Application 9 :

Application 10 :

Application 11 :

Application 12 :

ZOOM+

ZOOM-



PARTS IMAGE



BOX IMAGE

WB-0112

Parts Number :	WB-0112
Manufacture 1 :	NACHI <input type="button" value="v"/>
Manufacturer Number 1 :	30BVV06-2G
Manufacture 2 :	NSK <input type="button" value="v"/>
Manufacture Number 2 :	30BWD04CA19JB01
M.S.R.P 04/2010 :	
Description:	WHEEL BEARING MADE IN JAPAN

WHEEL BEARING MADE IN

ZOOM+ ZOOM-



PARTS IMAGE

- Application 1 :
- Application 2 :
- Application 3 :
- Application 4 :
- Application 5 :
- Application 6 :
- Application 7 :
- Application 8 :
- Application 9 :
- Application 10 :
- Application 11 :
- Application 12 :



BOX IMAGE

WB-0113

Parts Number :	WB-0113
Manufacture 1 :	NSK <input type="button" value="v"/>
Manufacturer Number 1 :	HO/38KWD04AG3CA1-01
Manufacture 2 :	NTN <input type="button" value="v"/>
Manufacturer Number 2 :	4+CR1-0849CS133#01
M.S.R.P 04/2010 :	
Description:	WHEEL BEARING MADE IN JAPAN

WHEEL BEARING MADE IN

ZOOM+ ZOOM-



PARTS IMAGE

- Application 1 :
- Application 2 :
- Application 3 :
- Application 4 :
- Application 5 :
- Application 6 :
- Application 7 :
- Application 8 :
- Application 9 :
- Application 10 :
- Application 11 :
- Application 12 :



BOX IMAGE

WB-0114

Parts Number : WB-0114

Manufacture 1 : NSK

Manufacturer Number 1 : 35BW05C4

Manufacture 2 :

Manufacturer Number 2 :

M.S.R.P 04/2010 :

Description: WHEEL BEARING MADE IN JAPAN

WHEEL BEARING MADE IN



PARTS IMAGE

- Application 1 :
- Application 2 :
- Application 3 :
- Application 4 :
- Application 5 :
- Application 6 :
- Application 7 :
- Application 8 :
- Application 9 :
- Application 10 :
- Application 11 :
- Application 12 :



BOX IMAGE

WB-0118

WHEEL BEARING MADE IN USA

Parts Number : WB-0118
Manufacture 1 : NSK
Manufacturer Number 1 : HO/27BWK04D3G31F
Manufacture 2 :
Manufacturer Number 2 :
M.S.R.P 04/2010 :
Description: WHEEL BEARING MADE IN USA

ZOOM+ ZOOM-



PARTS IMAGE

- Application 1 :
- Application 2 :
- Application 3 :
- Application 4 :
- Application 5 :
- Application 6 :
- Application 7 :
- Application 8 :
- Application 9 :
- Application 10 :
- Application 11 :
- Application 12 :



BOX IMAGE

WB-0120

Parts Number : WB-0120

Manufacture 1 : NTN

Manufacturer Number 1 : 4T-CR1-0826CS165/TU0807-1/L244

Manufacture 2 :

Manufacture Number 2 :

M.S.R.P 04/2010 :

Description: WHEEL BEARING MADE IN JAPAN

Application 1 :

Application 2 :

Application 3 :

Application 4 :

Application 5 :

Application 6 :

Application 7 :

Application 8 :

Application 9 :

Application 10 :

Application 11 :

Application 12 :

WHEEL BEARING MADE IN



PARTS IMAGE



BOX IMAGE

WB-0121

WHEEL BEARING MADE IN

Parts Number : WB-0121

Manufacture 1 : KOYO

Manufacturer Number 1 : DAC4781WSH2CS56FG-2

Manufacture 2 :

Manufacture Number 2 : 40210-0B000

M.S.R.P 04/2010 :

Description: WHEEL BEARING MADE IN JAPAN

Application 1 : NISSAN QUEST 99-02

Application 2 :

Application 3 :

Application 4 :

Application 5 :

Application 6 :

Application 7 :

Application 8 :

Application 9 :

Application 10 :

Application 11 :

Application 12 :

ZOOM+

ZOOM-



PARTS IMAGE

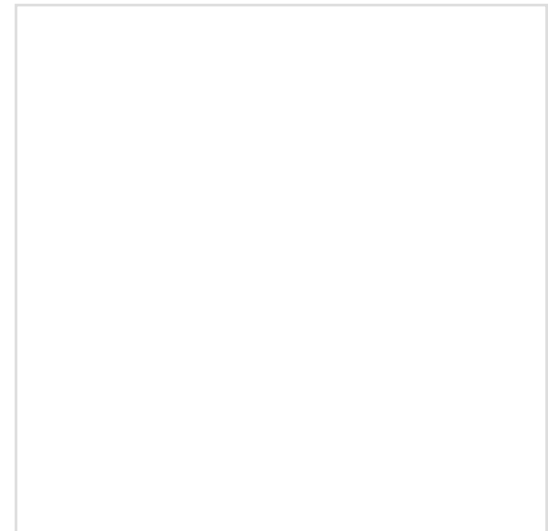

BOX IMAGE

WB-0122

Parts Number : WB-0122

Manufacture 1 : NSK

Manufacturer Number 1 : HR30304BJ

Manufacture 2 :

Manufacture Number 2 : 40215-P0100

M.S.R.P 04/2010 :

Description: WHEEL BEARING MADE IN JAPAN

Application 1 :

Application 2 :

Application 3 :

Application 4 :

Application 5 :

Application 6 :

Application 7 :

Application 8 :

Application 9 :

Application 10 :

Application 11 :

Application 12 :

WHEEL BEARING MADE IN

ZOOM+

ZOOM-



PARTS IMAGE



BOX IMAGE

WB-0125

Parts Number :	WB-0125
Manufacture 1 :	NSK <input type="button" value="v"/>
Manufacturer Number 1 :	H043BWD12A-JB-5C01
Manufacture 2 :	<input type="button" value="v"/>
Manufacture Number 2 :	40210-24000 /2Y000
M.S.R.P 04/2010 :	
Description:	WHEEL BEARING MADE IN JAPAN

WHEEL BEARING MADE IN

ZOOM+ ZOOM-



PARTS IMAGE

- Application 1 : NISSAN MAXIMA 00-03
- Application 2 :
- Application 3 :
- Application 4 :
- Application 5 :
- Application 6 :
- Application 7 :
- Application 8 :
- Application 9 :
- Application 10 :
- Application 11 :
- Application 12 :



BOX IMAGE

WB-0127

Parts Number : WB-0127

Manufacture 1 : NTN

Manufacturer Number 1 : HUB042-58

Manufacture 2 :

Manufacturer Number 2 :

M.S.R.P 04/2010 :

Description: WHEEL BEARING MADE IN JAPAN
HUB

Application 1 :

Application 2 :

Application 3 :

Application 4 :

Application 5 :

Application 6 :

Application 7 :

Application 8 :

Application 9 :

Application 10 :

Application 11 :

Application 12 :

WHEEL BEARING MADE IN

ZOOM+

ZOOM-



PARTS IMAGE



BOX IMAGE

WB-0129

WHEEL BEARING MADE IN

Parts Number : WB-0129

Manufacture 1 : NSK

Manufacturer Number 1 : 40BWD15ACA50

Manufacture 2 :

Manufacturer Number 2 : 40210-4Z000

M.S.R.P 04/2010 :

Description: WHEEL BEARING MADE IN JAPAN

Application 1 : NISSAN SENTRA 1.8L 00-06

Application 2 : NISSAN SENTRA 2.0L 00-07

Application 3 : NIISAN SENTRA 2.5L 00-06

Application 4 :

Application 5 :

Application 6 :

Application 7 :

Application 8 :

Application 9 :

Application 10 :

Application 11 :

Application 12 :

ZOOM+

ZOOM-



PARTS IMAGE



BOX IMAGE

WB-0130

WHEEL BEARING MADE IN

Parts Number : WB-0130

Manufacture 1 : NSK

Manufacturer Number 1 : 27BWK06A-Y-2

Manufacture 2 :

Manufacturer Number 2 :

M.S.R.P 04/2010 :

Description: WHEEL BEARING MADE IN JAPAN

Application 1 :

Application 2 :

Application 3 :

Application 4 :

Application 5 :

Application 6 :

Application 7 :

Application 8 :

Application 9 :

Application 10 :

Application 11 :

Application 12 :

ZOOM+ ZOOM-



PARTS IMAGE



BOX IMAGE

WB-0201

Parts Number : WB-0201

Manufacture 1 : NACHI

Manufacturer Number 1 : 30BCDS2+C06

Manufacture 2 : NACHI

Manufacture Number 2 : BR06

M.S.R.P 04/2010 :

Description: WHEEL BEARING WITH LOCKING COLLAR EB MADE IN JAPAN

Application 1 :

Application 2 :

Application 3 :

Application 4 :

Application 5 :

Application 6 :

Application 7 :

Application 8 :

Application 9 :

Application 10 :

Application 11 :

Application 12 :

WHEEL BEARING WITH

ZOOM+

ZOOM-



PARTS IMAGE



BOX IMAGE

WB-0202

WHEEL BEARING

Parts Number :	WB-0202
Manufacture 1 :	NSK <input type="button" value="v"/>
Manufacturer Number 1 :	B35-53AC4+C14
Manufacture 2 :	<input type="button" value="v"/>
Manufacturer Number 2 :	
M.S.R.P 04/2010 :	
Description:	WHEEL BEARING

- Application 1 :
- Application 2 :
- Application 3 :
- Application 4 :
- Application 5 :
- Application 6 :
- Application 7 :
- Application 8 :
- Application 9 :
- Application 10 :
- Application 11 :
- Application 12 :

ZOOM+ ZOOM-



PARTS IMAGE



BOX IMAGE

WB-0203

WHEEL BEARING

Parts Number : WB-0203

Manufacture 1 : NSK

Manufacturer Number 1 : 6308ADDUC4

Manufacture 2 : NTN

Manufacture Number 2 : 6308LLUC3

M.S.R.P 04/2010 :

Description: WHEEL BEARING

Application 1 : 90363-40020

Application 2 : TOYOTA PICK UP 84-94 L4/V6 2WD/4WD

Application 3 : TOYOTA TACOMA 95-00 L4/V6 2WD/4WD

Application 4 : TOYOTA 4RUNNER 84-89 L4/V6 2WD/4WD

Application 5 : TOYOTA 4RUNNER 90-95 L4/ V6 2WD/4WD

Application 6 : TOYOTA 4RUNNER 96-02 L4/V6 2WD/ 4WD

Application 7 : TOYOTA T100 93-98 L4/V6

Application 8 :

Application 9 :

Application 10 :

Application 11 :

Application 12 :

ZOOM+

ZOOM-



PARTS IMAGE



BOX IMAGE

WB-0203A

WHEEL BEARING & LOCKING

Parts Number :	WB-0203A
Manufacture 1 :	NSK <input type="text"/>
Manufacturer Number 1 :	6308ADDUC4 AS2S 006
Manufacture 2 :	AUB <input type="text"/>
Manufacture Number 2 :	015B-R
M.S.R.P 04/2010 :	
Description:	WHEEL BEARING & LOCKING COLLAR

- Application 1 :
- Application 2 :
- Application 3 :
- Application 4 :
- Application 5 :
- Application 6 :
- Application 7 :
- Application 8 :
- Application 9 :
- Application 10 :
- Application 11 :
- Application 12 :

ZOOM+ ZOOM-



PARTS IMAGE



BOX IMAGE

WB-0203A

WHEEL BEARING & LOCKING

Parts Number :	WB-0203A
Manufacture 1 :	KOYO <input type="text"/>
Manufacturer Number 1 :	6308TPT4C5+R
Manufacture 2 :	KOYO <input type="text"/>
Manufacture Number 2 :	015B-R
M.S.R.P 04/2010 :	
Description:	WHEEL BEARING & LOCKING COLLAR

- Application 1 :
- Application 2 :
- Application 3 :
- Application 4 :
- Application 5 :
- Application 6 :
- Application 7 :
- Application 8 :
- Application 9 :
- Application 10 :
- Application 11 :
- Application 12 :

ZOOM+ ZOOM-



PARTS IMAGE



BOX IMAGE

WB-0203A

Parts Number : WB-0203A

Manufacture 1 : NSK

Manufacturer Number 1 : 6308ADDUC4 AS2S 006

Manufacture 2 : FBJ

Manufacture Number 2 : 015B-R

M.S.R.P 04/2010 :

Description: WHEEL BEARING & LOCKING COLLAR MADE IN JAPAN

Application 1 :

Application 2 :

Application 3 :

Application 4 :

Application 5 :

Application 6 :

Application 7 :

Application 8 :

Application 9 :

Application 10 :

Application 11 :

Application 12 :

WHEEL BEARING & LOCKING

ZOOM+

ZOOM-



PARTS IMAGE



BOX IMAGE

WB-0204

WHEEL BEARING

Parts Number : WB-0204

Manufacture 1 : NSK

Manufacturer Number 1 : 28BWD01ACA60

Manufacture 2 :

Manufacture Number 2 :

M.S.R.P 04/2010 :

Description: WHEEL BEARING

Application 1 :

Application 2 :

Application 3 :

Application 4 :

Application 5 :

Application 6 :

Application 7 :

Application 8 :

Application 9 :

Application 10 :

Application 11 :

Application 12 :

ZOOM+ ZOOM-



PARTS IMAGE



BOX IMAGE

WB-0205

WHEEL BEARING

Parts Number :	WB-0205
Manufacture 1 :	KOYO <input type="button" value="v"/>
Manufacturer Number 1 :	DAC357233B-1WCS79
Manufacture 2 :	NSK <input type="button" value="v"/>
Manufacture Number 2 :	35BWD06ACA125
M.S.R.P 04/2010 :	
Description:	WHEEL BEARING

- Application 1 :
- Application 2 :
- Application 3 :
- Application 4 :
- Application 5 :
- Application 6 :
- Application 7 :
- Application 8 :
- Application 9 :
- Application 10 :
- Application 11 :
- Application 12 :

ZOOM+ ZOOM-



PARTS IMAGE



BOX IMAGE

WB-0206

WHEEL BEARING

Parts Number : WB-0206

Manufacture 1 : NSK

Manufacturer Number 1 : 38BWD09ACA120

Manufacture 2 :

Manufacturer Number 2 : 90369-38006

M.S.R.P 04/2010 :

Description: WHEEL BEARING

Application 1 : TOYOTA TERCEL 86-99

Application 2 : TOYOTA PASEO 92-98

Application 3 :

Application 4 :

Application 5 :

Application 6 :

Application 7 :

Application 8 :

Application 9 :

Application 10 :

Application 11 :

Application 12 :

ZOOM+

ZOOM-



PARTS IMAGE



BOX IMAGE

WB-0207

WHEEL BEARING

Parts Number : WB-0207

Manufacture 1 : KOYO

Manufacturer Number 1 : LM102949/10

Manufacture 2 :

Manufacture Number 2 : 90080-36067/90368-45087/MB092749

M.S.R.P 04/2010 :

Description: WHEEL BEARING

- Application 1 :** MITSUBISHI MONTERO 83-04
- Application 2 :** TOYOTA LANDCRUISER 83-04
- Application 3 :** TOYOTA 4RUNNER 84-89
- Application 4 :** TOYOTA PICK UP 84-95
- Application 5 :** MAZDA B2600 2WD 86-93
- Application 6 :** TOYOTA T100 93-98
- Application 7 :** LEXUS LX450 96-97
- Application 8 :**
- Application 9 :**
- Application 10 :**
- Application 11 :**
- Application 12 :**

ZOOM+ ZOOM-



PARTS IMAGE



BOX IMAGE

WB-0208

WHEEL BEARING

Parts Number : WB-0208

Manufacture 1 : NSK

Manufacturer Number 1 : 43BWD06CA133

Manufacture 2 :

Manufacture Number 2 :

M.S.R.P 04/2010 :

Description: WHEEL BEARING

Application 1 :

Application 2 :

Application 3 :

Application 4 :

Application 5 :

Application 6 :

Application 7 :

Application 8 :

Application 9 :

Application 10 :

Application 11 :

Application 12 :

ZOOM+

ZOOM-



PARTS IMAGE

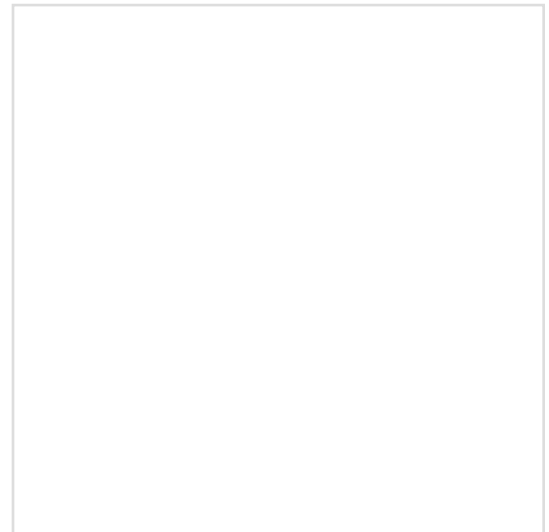

BOX IMAGE

WB-0208D

WHEEL BEARING

Parts Number : WB-0208D

Manufacture 1 : NSK

Manufacturer Number 1 : 43BWD06BCA133

Manufacture 2 : NACHI

Manufacturer Number 2 : 43BVV08GGCS123

M.S.R.P 04/2010 :

Description: WHEEL BEARING

Application 1 : 90369-43008 /43009

Application 2 : LEXUS ES300 92-01

Application 3 : TOYOTA CAMRY 4CYL/ V6 92-03

Application 4 : TOYOTA AVALONE V6 98-03

Application 5 : TOYOTA SIENNA V6 98-03

Application 6 : LEXUS RX300 V6 99-03

Application 7 : TOYOTA CAMRY SOLARA 4CYL/ V6 00-03

Application 8 : TOYTOA RAV4 03-05

Application 9 : TOYOTA MR2 90-95

Application 10 :

Application 11 :

Application 12 :

ZOOM+

ZOOM-



PARTS IMAGE



BOX IMAGE

WB-0210

WHEEL BEARING

Parts Number : WB-0210
Manufacture 1 : NSK
Manufacturer Number 1 : 32BWD05CA75
Manufacture 2 :
Manufacturer Number 2 :
M.S.R.P 04/2010 :
Description: WHEEL BEARING

- Application 1 :
- Application 2 :
- Application 3 :
- Application 4 :
- Application 5 :
- Application 6 :
- Application 7 :
- Application 8 :
- Application 9 :
- Application 10 :
- Application 11 :
- Application 12 :

ZOOM+ ZOOM-



PARTS IMAGE



BOX IMAGE

WB-0211

WHEEL BEARING

Parts Number :	WB-0211
Manufacture 1 :	NSK <input type="button" value="v"/>
Manufacturer Number 1 :	38BWD12CA133
Manufacture 2 :	NACHI <input type="button" value="v"/>
Manufacture Number 2 :	38BVV07-30G
M.S.R.P 04/2010 :	
Description:	WHEEL BEARING

- Application 1 :** 90363-38006/90369-38011
- Application 2 :** TOYOTA COROLLA 90-02
- Application 3 :**
- Application 4 :**
- Application 5 :**
- Application 6 :**
- Application 7 :**
- Application 8 :**
- Application 9 :**
- Application 10 :**
- Application 11 :**
- Application 12 :**

ZOOM+ ZOOM-



PARTS IMAGE



BOX IMAGE

WB-0212

WHEEL BEARING

Parts Number : WB-0212

Manufacture 1 : NSK

Manufacturer Number 1 : 43BWD03CA133

Manufacture 2 :

Manufacture Number 2 : 90369-43005

M.S.R.P 04/2010 :

Description: WHEEL BEARING

Application 1 : TOYOTA SUPRA 86-98

Application 2 : TOYOTA CRESSIDA 89-92

Application 3 : LEXUS LS400 90-00

Application 4 : LEXUS SC300 92-00

Application 5 : LEXUS SC400 92-00

Application 6 : LEXUS GS300 93-06

Application 7 :

Application 8 :

Application 9 :

Application 10 :

Application 11 :

Application 12 :

ZOOM+

ZOOM-



PARTS IMAGE



BOX IMAGE

WB-0213

WHEEL BEARING

Parts Number :	WB-0213
Manufacture 1 :	NACHI <input type="button" value="v"/>
Manufacturer Number 1 :	35BVV07-7G/9G
Manufacture 2 :	KOYO <input type="button" value="v"/>
Manufacture Number 2 :	DAC35772-3C580
M.S.R.P 04/2010 :	
Description:	WHEEL BEARING

- Application 1 :** 90369-35034/90903-63006
- Application 2 :** TOYOTA CRESSIDA 89-92
- Application 3 :** LEXUS LS400 90-00
- Application 4 :** LEXUS SC300 92-00
- Application 5 :** LEXUS SC400 92-00
- Application 6 :** LEXUS GS300 93-06
- Application 7 :** LEXUS GS400 98-00
- Application 8 :** LEXUS GS430 01-05
- Application 9 :** LEXUS SC430 02-10
- Application 10 :** TOYOTA SUPRA 86-98
- Application 11 :**
- Application 12 :**

ZOOM+ ZOOM-



PARTS IMAGE



BOX IMAGE

WB-0214

WHEEL BEARING

Parts Number :	WB-0214
Manufacture 1 :	NTN <input type="button" value="v"/>
Manufacturer Number 1 :	4T-JLM104948/104910
Manufacture 2 :	<input type="button" value="v"/>
Manufacture Number 2 :	90368-49084
M.S.R.P 04/2010 :	
Description:	WHEEL BEARING

- Application 1 :** TOYOTA LANDCRUISER 83-96
- Application 2 :** TOYOTA 4RUNNER 84-85
- Application 3 :** TOYOTA PICK UP 84-94
- Application 4 :** TOYOTA T100 94-98
- Application 5 :** TOYOTA LEXUS LX450 96-97
- Application 6 :**
- Application 7 :**
- Application 8 :**
- Application 9 :**
- Application 10 :**
- Application 11 :**
- Application 12 :**

ZOOM+ ZOOM-



PARTS IMAGE



BOX IMAGE

WB-0215

WHEEL BEARING

Parts Number : WB-0215

Manufacture 1 : KOYO

Manufacturer Number 1 : 46T090804ALFT

Manufacture 2 :

Manufacture Number 2 :

M.S.R.P 04/2010 :

Description: WHEEL BEARING

Application 1 :

Application 2 :

Application 3 :

Application 4 :

Application 5 :

Application 6 :

Application 7 :

Application 8 :

Application 9 :

Application 10 :

Application 11 :

Application 12 :

ZOOM+

ZOOM-

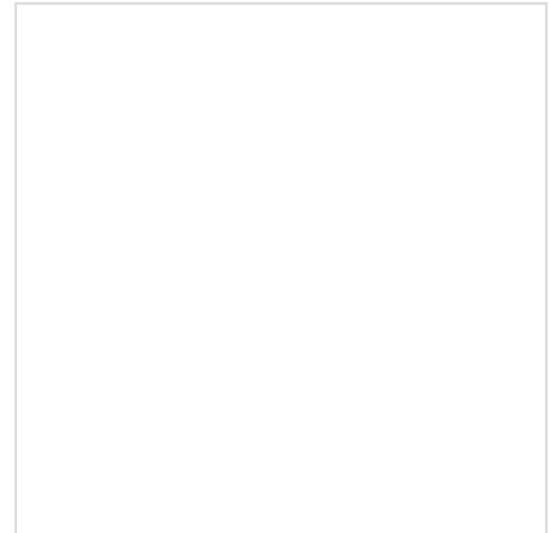

PARTS IMAGE

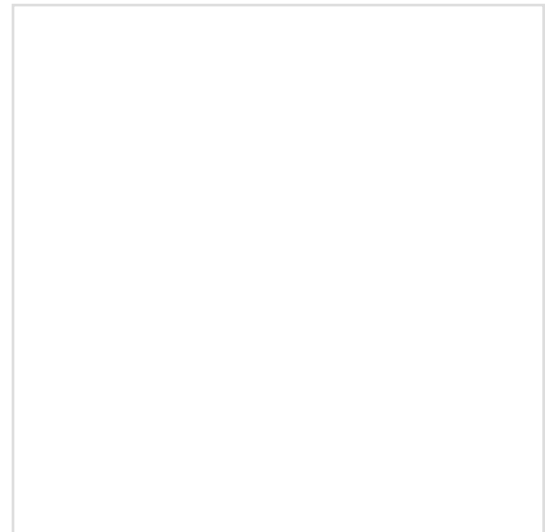

BOX IMAGE

WB-0216

WHEEL BEARING

Parts Number : WB-0216

Manufacture 1 : NACHI

Manufacturer Number 1 : 30BCDS3+C06

Manufacture 2 :

Manufacture Number 2 :

M.S.R.P 04/2010 :

Description: WHEEL BEARING

Application 1 :

Application 2 :

Application 3 :

Application 4 :

Application 5 :

Application 6 :

Application 7 :

Application 8 :

Application 9 :

Application 10 :

Application 11 :

Application 12 :

ZOOM+

ZOOM-



PARTS IMAGE

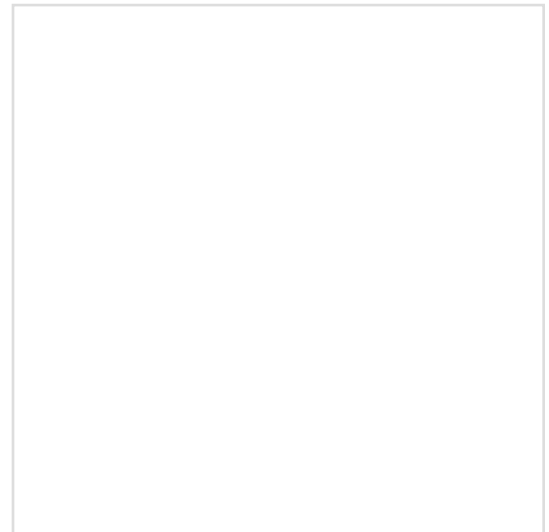

BOX IMAGE

WB-0217

WHEEL BEARING

Parts Number : WB-0217

Manufacture 1 : NSK

Manufacturer Number 1 : TF138ORG3/TF1328RG01

Manufacture 2 :

Manufacture Number 2 :

M.S.R.P 04/2010 :

Description: WHEEL BEARING

Application 1 :

Application 2 :

Application 3 :

Application 4 :

Application 5 :

Application 6 :

Application 7 :

Application 8 :

Application 9 :

Application 10 :

Application 11 :

Application 12 :

ZOOM+

ZOOM-

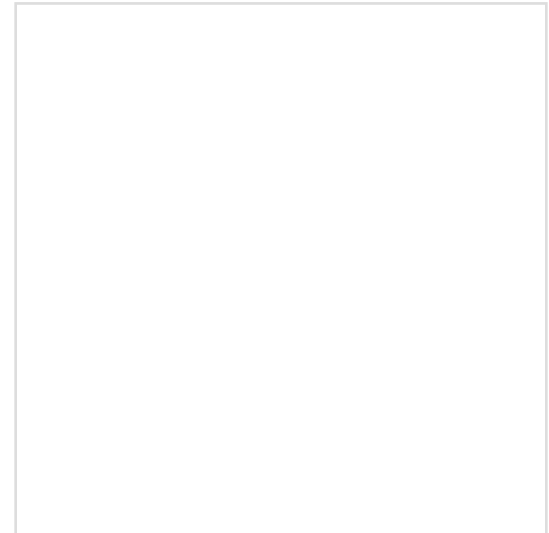

PARTS IMAGE

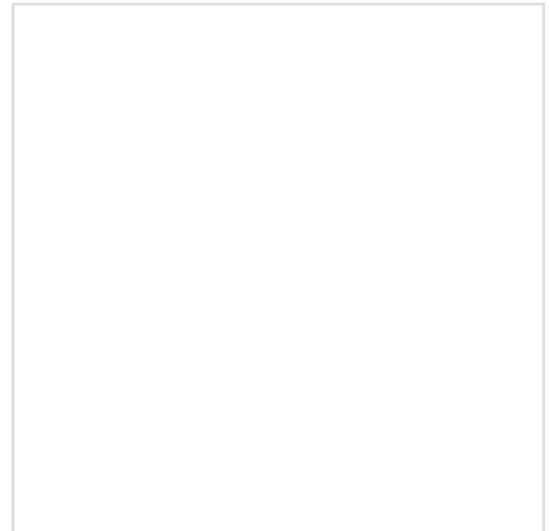

BOX IMAGE

WB-0218

WHEEL BEARING

Parts Number :	WB-0218
Manufacture 1 :	NSK <input type="button" value="v"/>
Manufacturer Number 1 :	TFM38549R/50R
Manufacture 2 :	<input type="button" value="v"/>
Manufacturer Number 2 :	
M.S.R.P 04/2010 :	
Description:	WHEEL BEARING

- Application 1 :
- Application 2 :
- Application 3 :
- Application 4 :
- Application 5 :
- Application 6 :
- Application 7 :
- Application 8 :
- Application 9 :
- Application 10 :
- Application 11 :
- Application 12 :

ZOOM+ ZOOM-



PARTS IMAGE



BOX IMAGE

WB-0219

WHEEL BEARING

Parts Number : WB-0219

Manufacture 1 : KOYO

Manufacturer Number 1 : HCST3749

Manufacture 2 :

Manufacturer Number 2 :

M.S.R.P 04/2010 :

Description: WHEEL BEARING

Application 1 :

Application 2 :

Application 3 :

Application 4 :

Application 5 :

Application 6 :

Application 7 :

Application 8 :

Application 9 :

Application 10 :

Application 11 :

Application 12 :

ZOOM+

ZOOM-



PARTS IMAGE

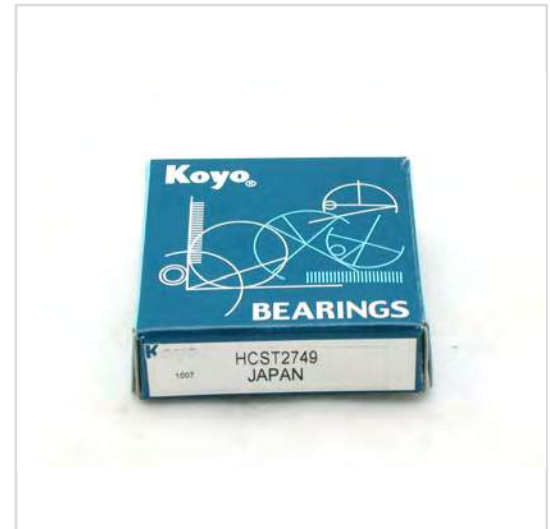

BOX IMAGE

WB-0220

WHEEL BEARING

Parts Number : WB-0220
Manufacture 1 : NSK
Manufacturer Number 1 : 30BWK17-Y-2
Manufacture 2 :
Manufacturer Number 2 :
M.S.R.P 04/2010 :
Description: WHEEL BEARING

- Application 1 :
- Application 2 :
- Application 3 :
- Application 4 :
- Application 5 :
- Application 6 :
- Application 7 :
- Application 8 :
- Application 9 :
- Application 10 :
- Application 11 :
- Application 12 :

ZOOM+ ZOOM-



PARTS IMAGE



BOX IMAGE

WB-0221

WHEEL BEARING

Parts Number :	WB-0221
Manufacture 1 :	NSK <input type="button" value="v"/>
Manufacturer Number 1 :	28BWK12-Y-2CP4
Manufacture 2 :	<input type="button" value="v"/>
Manufacturer Number 2 :	
M.S.R.P 04/2010 :	
Description:	WHEEL BEARING

- Application 1 :
- Application 2 :
- Application 3 :
- Application 4 :
- Application 5 :
- Application 6 :
- Application 7 :
- Application 8 :
- Application 9 :
- Application 10 :
- Application 11 :
- Application 12 :

ZOOM+ ZOOM-



PARTS IMAGE



BOX IMAGE

WB-0222

WHEEL BEARING

Parts Number :	WB-0222
Manufacture 1 :	NSK <input type="button" value="v"/>
Manufacturer Number 1 :	38WK01J-Y-2CA41
Manufacture 2 :	<input type="button" value="v"/>
Manufacturer Number 2 :	
M.S.R.P 04/2010 :	
Description:	WHEEL BEARING

- Application 1 :
- Application 2 :
- Application 3 :
- Application 4 :
- Application 5 :
- Application 6 :
- Application 7 :
- Application 8 :
- Application 9 :
- Application 10 :
- Application 11 :
- Application 12 :

ZOOM+ ZOOM-



PARTS IMAGE



BOX IMAGE

WB-0223

WHEEL BEARING

Parts Number :	WB-0223
Manufacture 1 :	NSK <input type="button" value="v"/>
Manufacturer Number 1 :	38BWD24CA78
Manufacture 2 :	<input type="button" value="v"/>
Manufacturer Number 2 :	
M.S.R.P 04/2010 :	
Description:	WHEEL BEARING

- Application 1 :
- Application 2 :
- Application 3 :
- Application 4 :
- Application 5 :
- Application 6 :
- Application 7 :
- Application 8 :
- Application 9 :
- Application 10 :
- Application 11 :
- Application 12 :

ZOOM+ ZOOM-



PARTS IMAGE



BOX IMAGE

WB-0224

WHEEL BEARING

Parts Number : WB-0224

Manufacture 1 : NSK

Manufacturer Number 1 : B30-141C4

Manufacture 2 :

Manufacture Number 2 :

M.S.R.P 04/2010 :

Description: WHEEL BEARING

Application 1 :

Application 2 :

Application 3 :

Application 4 :

Application 5 :

Application 6 :

Application 7 :

Application 8 :

Application 9 :

Application 10 :

Application 11 :

Application 12 :

ZOOM+

ZOOM-



PARTS IMAGE

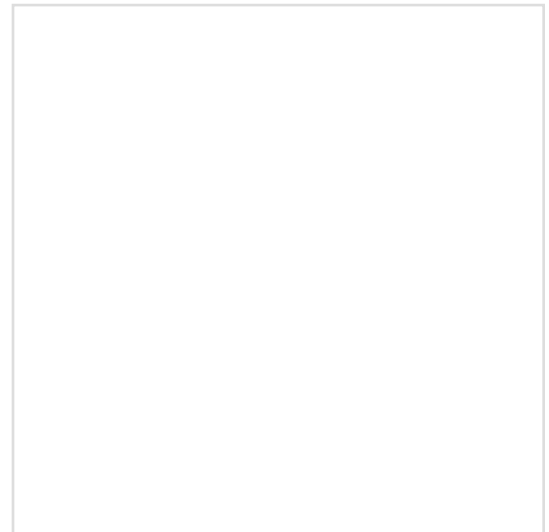

BOX IMAGE

WB-0226

WHEEL BEARING

Parts Number : WB-0226

Manufacture 1 : NSK

Manufacturer Number 1 : 30TM02

Manufacture 2 :

Manufacture Number 2 :

M.S.R.P 04/2010 :

Description: WHEEL BEARING

Application 1 :

Application 2 :

Application 3 :

Application 4 :

Application 5 :

Application 6 :

Application 7 :

Application 8 :

Application 9 :

Application 10 :

Application 11 :

Application 12 :

ZOOM+

ZOOM-



PARTS IMAGE



BOX IMAGE

WB-0227

WHEEL BEARING

Parts Number : WB-0227

Manufacture 1 : NTN

Manufacturer Number 1 : LM48548/M12649

Manufacture 2 :

Manufacture Number 2 : 04421-35020

M.S.R.P 04/2010 :

Description: WHEEL BEARING

Application 1 : TOYOTA PICK UP 92-94

Application 2 : TOYOTA 4RUNNER 95

Application 3 : TOYOTA TACOMA 95-04

Application 4 :

Application 5 :

Application 6 :

Application 7 :

Application 8 :

Application 9 :

Application 10 :

Application 11 :

Application 12 :

ZOOM+

ZOOM-



PARTS IMAGE



BOX IMAGE

WB-0228

WHEEL BEARING

Parts Number : WB-0228

Manufacture 1 : NSK

Manufacturer Number 1 : 30BWD01-A-CA85

Manufacture 2 :

Manufacturer Number 2 :

M.S.R.P 04/2010 :

Description: WHEEL BEARING

Application 1 :

Application 2 :

Application 3 :

Application 4 :

Application 5 :

Application 6 :

Application 7 :

Application 8 :

Application 9 :

Application 10 :

Application 11 :

Application 12 :

ZOOM+

ZOOM-



PARTS IMAGE



BOX IMAGE

WB-0230AN

Parts Number : WB-0230AN

Manufacture 1 : NACHI

Manufacturer Number 1 : P1-35BCD08S6

Manufacture 2 : KOYO

Manufacturer Number 2 : C14

M.S.R.P 04/2010 :

Description: WHEEL BEARING MADE IN JAPAN

WHEEL BEARING MADE IN

ZOOM+

ZOOM-



PARTS IMAGE

Application 1 :

Application 2 :

Application 3 :

Application 4 :

Application 5 :

Application 6 :

Application 7 :

Application 8 :

Application 9 :

Application 10 :

Application 11 :

Application 12 :



BOX IMAGE

WB-0231

WHEEL BEARING

Parts Number : WB-0231

Manufacture 1 : NACHI

Manufacturer Number 1 : 540BCV09S1-2

Manufacture 2 :

Manufacturer Number 2 : 90363-40068

M.S.R.P 04/2010 :

Description: WHEEL BEARING

Application 1 : TOYOTA TACOMA 00-04

Application 2 : TOYOTA TUNDRA 00-06

Application 3 :

Application 4 :

Application 5 :

Application 6 :

Application 7 :

Application 8 :

Application 9 :

Application 10 :

Application 11 :

Application 12 :

ZOOM+

ZOOM-

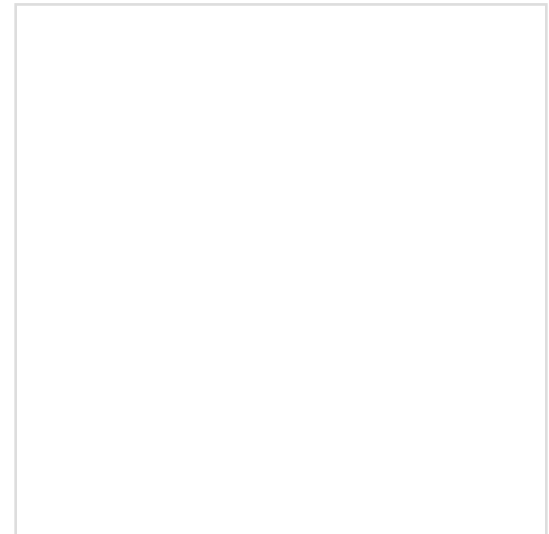

PARTS IMAGE

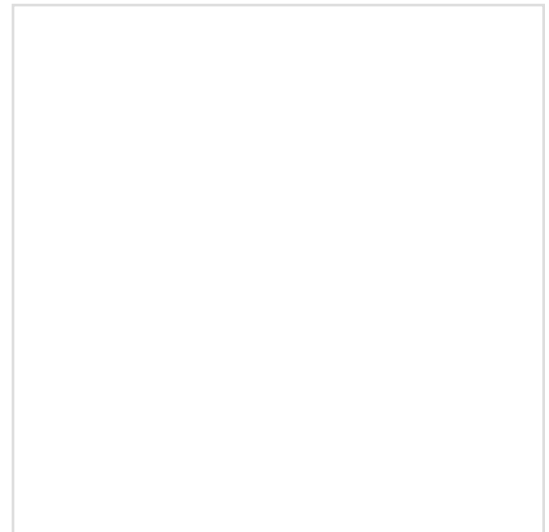

BOX IMAGE

WB-0234

WHEEL BEARING

Parts Number :	WB-0234
Manufacture 1 :	NACHI <input type="button" value="v"/>
Manufacturer Number 1 :	32BVV07-8G
Manufacture 2 :	<input type="button" value="v"/>
Manufacture Number 2 :	90363-32035
M.S.R.P 04/2010 :	
Description:	WHEEL BEARING

- Application 1 :** LEXUS IS 300 01-05
- Application 2 :**
- Application 3 :**
- Application 4 :**
- Application 5 :**
- Application 6 :**
- Application 7 :**
- Application 8 :**
- Application 9 :**
- Application 10 :**
- Application 11 :**
- Application 12 :**

ZOOM+ ZOOM-



PARTS IMAGE



BOX IMAGE

WB-0236

WHEEL BEARING

Parts Number : WB-0236

Manufacture 1 :

Manufacturer Number 1 :

567

Manufacture 2 :

Manufacturer Number 2 :

M.S.R.P 04/2010 :

Description:

WHEEL BEARING

Application 1 :

Application 2 :

Application 3 :

Application 4 :

Application 5 :

Application 6 :

Application 7 :

Application 8 :

Application 9 :

Application 10 :

Application 11 :

Application 12 :

ZOOM+

ZOOM-

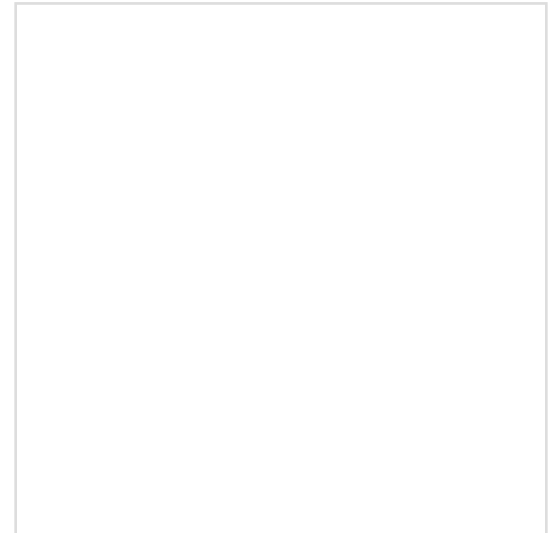

PARTS IMAGE

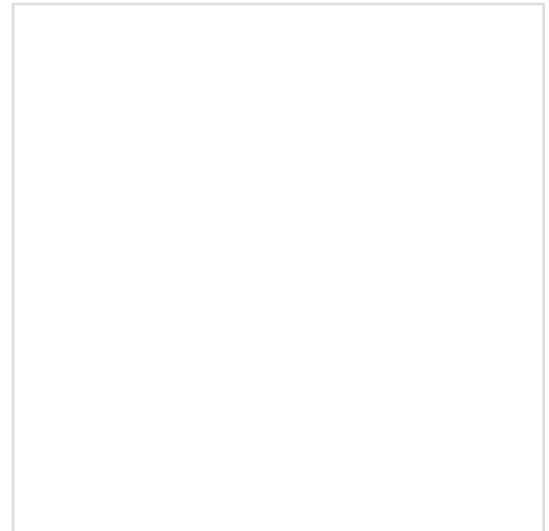

BOX IMAGE

WB-0237

WHEEL BEARING

Parts Number : WB-0237

Manufacture 1 :

Manufacturer Number 1 : 575

Manufacture 2 :

Manufacturer Number 2 :

M.S.R.P 04/2010 :

Description: WHEEL BEARING

Application 1 :

Application 2 :

Application 3 :

Application 4 :

Application 5 :

Application 6 :

Application 7 :

Application 8 :

Application 9 :

Application 10 :

Application 11 :

Application 12 :

ZOOM+

ZOOM-



PARTS IMAGE

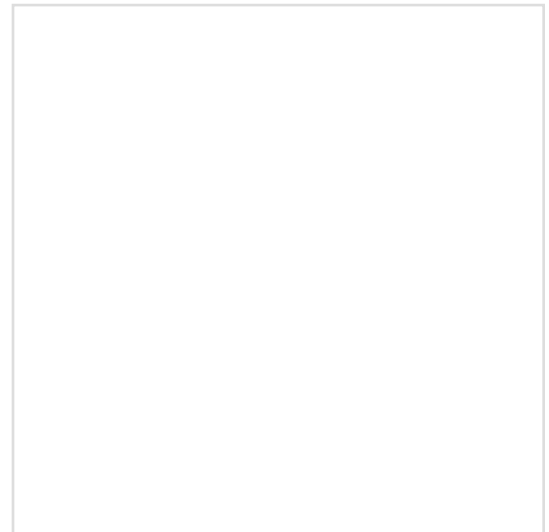

BOX IMAGE

WB-0238

WHEEL BEARING

Parts Number :	WB-0238
Manufacture 1 :	NSK <input type="button" value="v"/>
Manufacturer Number 1 :	49BWKH16-Y-5 F +RAIS
Manufacture 2 :	<input type="button" value="v"/>
Manufacture Number 2 :	
M.S.R.P 04/2010 :	
Description:	WHEEL BEARING

ZOOM+ ZOOM-



PARTS IMAGE

- Application 1 :
- Application 2 :
- Application 3 :
- Application 4 :
- Application 5 :
- Application 6 :
- Application 7 :
- Application 8 :
- Application 9 :
- Application 10 :
- Application 11 :
- Application 12 :

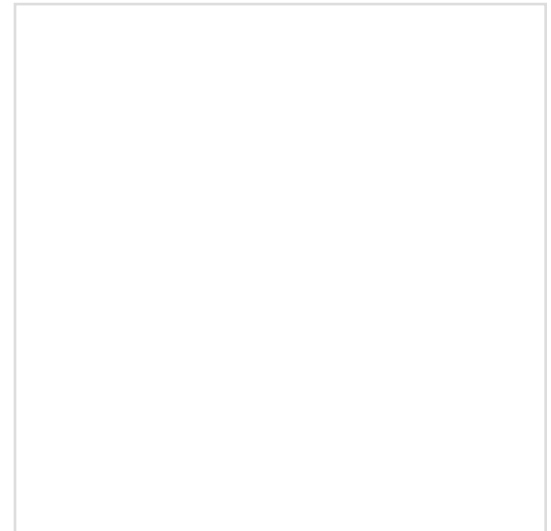

BOX IMAGE

WB-0239

WHEEL BEARING

Parts Number : WB-0239

Manufacture 1 : KOYO

Manufacturer Number 1 : DAC4584W1CS81

Manufacture 2 :

Manufacturer Number 2 : 90080-36193

M.S.R.P 04/2010 :

Description: WHEEL BEARING

Application 1 : TOYOTA HIGHLANDER L4 V6 HYBRID 01-07

Application 2 : TOYOTA CAMRY / SOLARA 02-10

Application 3 : TOYOTA CAMRY L4 V6 HYBRID 02-10

Application 4 : TOYOTA AVALON 05-10

Application 5 : TOYOTA SIENNA 3.3L 3.5LV6 04-10

Application 6 : TOYOTA MATRIX 09-10

Application 7 : TOYOTA VENZA L4 V6 09-10

Application 8 : LEXUS ES330 04-06

Application 9 : LEXUS RX330 04-06

Application 10 : LEXUS ES350 07-10

Application 11 : LEXUS RX350 RX400h 07-10

Application 12 : LEXUS HS250h

ZOOM+

ZOOM-



PARTS IMAGE



BOX IMAGE

WB-0241

WHEEL BEARING

Parts Number :	WB-0241
Manufacture 1 :	KOYO <input type="button" value="v"/>
Manufacturer Number 1 :	3DACF026F-15AS
Manufacture 2 :	KOYO <input type="button" value="v"/>
Manufacturer Number 2 :	3DACF026F9ES
M.S.R.P 04/2010 :	
Description:	WHEEL BEARING HUB BEARING REAR RIGHT

- Application 1 :** 42450-06020/21/30, 42450-48010/11
- Application 2 :** TOYOTA CAMRY SOLARA I4 V6 01-10
- Application 3 :** TOYOTA CAMRY L4 V6 01-10
- Application 4 :** TOYOTA HIGHLANDER LT V6 01-04
- Application 5 :** TOYOTA AVALON V6 05-10
- Application 6 :** LEXUS ES300 V6 01-03
- Application 7 :** LEXUS ES330 04-06
- Application 8 :** LEXUS ES 350 V6 07-10
- Application 9 :**
- Application 10 :**
- Application 11 :**
- Application 12 :**

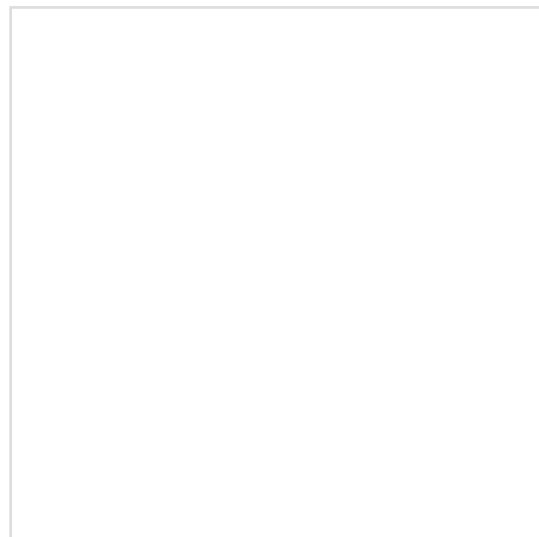

PARTS IMAGE

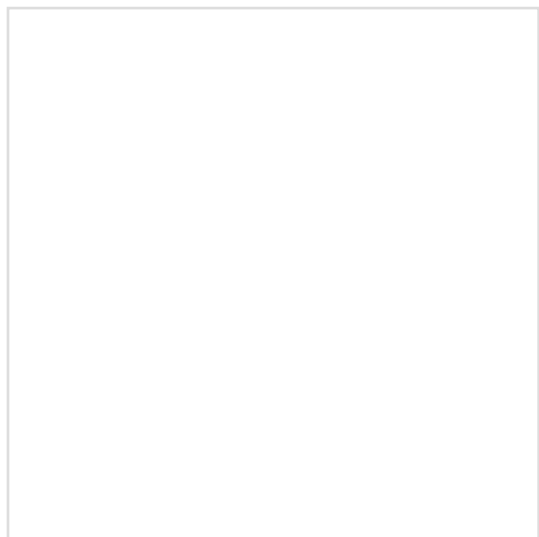

BOX IMAGE

WB-0242

WHEEL BEARING

Parts Number :	WB-0242
Manufacture 1 :	KOYO <input type="button" value="v"/>
Manufacturer Number 1 :	3DACF026F-16AS
Manufacture 2 :	KOYO <input type="button" value="v"/>
Manufacture Number 2 :	3DACF026F8ES
M.S.R.P 04/2010 :	
Description:	WHEEL BEARING HUB BEARING REAR RIGHT

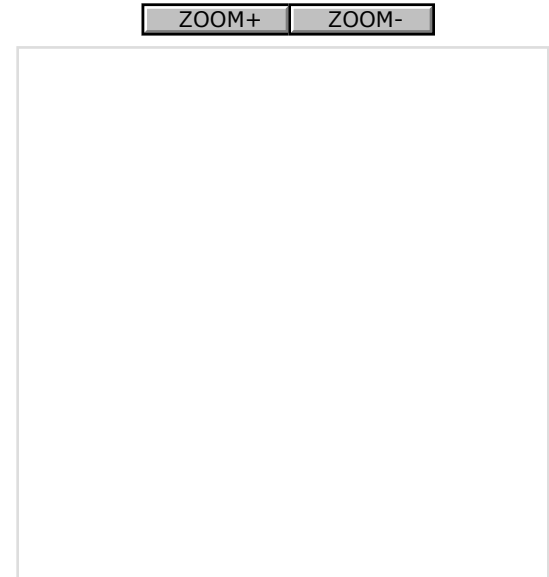

PARTS IMAGE

- Application 1 :** 42460-06020/21/30, 42460-48010/11
- Application 2 :** TOYOTA CAMRY SOLARA I4 V6 01-10
- Application 3 :** TOYOTA CAMRY L4 V6 01-10
- Application 4 :** TOYOTA HIGHLANDER LT V6 01-04
- Application 5 :** TOYOTA AVALON V6 05-10
- Application 6 :** LEXUS ES300 V6 01-03
- Application 7 :** LEXUS ES330 04-06
- Application 8 :** LEXUS ES 350 V6 07-10
- Application 9 :**
- Application 10 :**
- Application 11 :**
- Application 12 :**

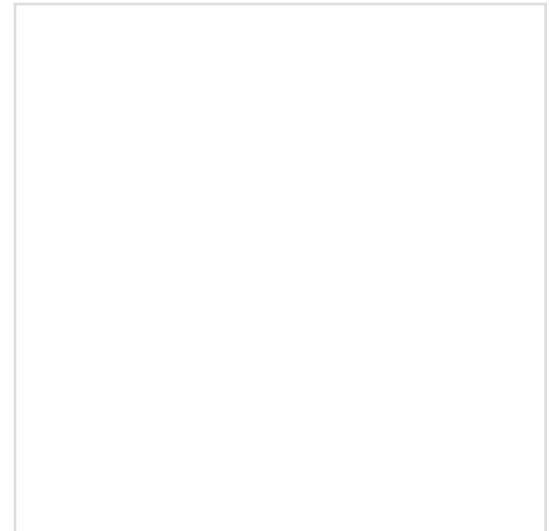

BOX IMAGE

WB-0243

WHEEL BEARING

Parts Number : WB-0243

Manufacture 1 : KOYO

Manufacturer Number 1 : DAC4075W-2CS73

Manufacture 2 :

Manufacturer Number 2 :

M.S.R.P 04/2010 :

Description: WHEEL BEARING

Application 1 :

Application 2 :

Application 3 :

Application 4 :

Application 5 :

Application 6 :

Application 7 :

Application 8 :

Application 9 :

Application 10 :

Application 11 :

Application 12 :

ZOOM+

ZOOM-



PARTS IMAGE



BOX IMAGE

WB-0244

WHEEL BEARING

Parts Number : WB-0244

Manufacture 1 : KOYO

Manufacturer Number 1 : DAC4586WCS69

Manufacture 2 :

Manufacture Number 2 :

M.S.R.P 04/2010 :

Description: WHEEL BEARING
HUB BEARING FRONT

Application 1 : TOYOTA HIGH LANDER 08-10

Application 2 : LEXUS RX350 2010

Application 3 :

Application 4 :

Application 5 :

Application 6 :

Application 7 :

Application 8 :

Application 9 :

Application 10 :

Application 11 :

Application 12 :

ZOOM+

ZOOM-



PARTS IMAGE

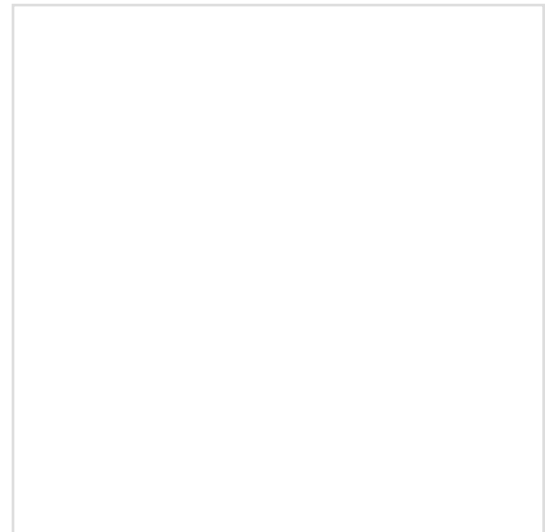

BOX IMAGE

WB-0246

WHEEL BEARING

Parts Number : WB-0246

Manufacture 1 : KOYO

Manufacturer Number 1 : DAC4889W-1CS16

Manufacture 2 :

Manufacture Number 2 : 90369-48001

M.S.R.P 04/2010 :

Description: WHEEL BEARING

Application 1 : TOYOTA LANDCRUISER 98-07

Application 2 :

Application 3 :

Application 4 :

Application 5 :

Application 6 :

Application 7 :

Application 8 :

Application 9 :

Application 10 :

Application 11 :

Application 12 :

ZOOM+

ZOOM-

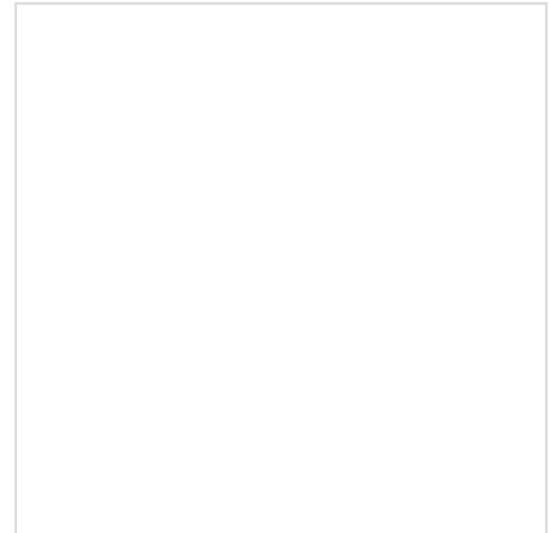

PARTS IMAGE

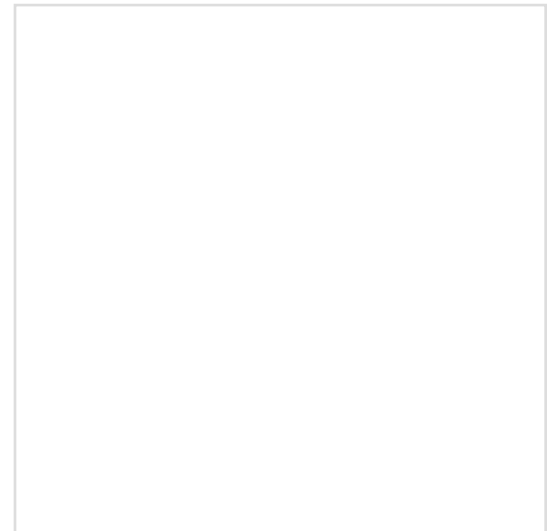

BOX IMAGE

WB-0301

WHEEL BEARING

Parts Number : WB-0301

Manufacture 1 : NSK

Manufacturer Number 1 : 35BWD01CCA38

Manufacture 2 :

Manufacture Number 2 :

M.S.R.P 04/2010 :

Description: WHEEL BEARING

Application 1 :

Application 2 :

Application 3 :

Application 4 :

Application 5 :

Application 6 :

Application 7 :

Application 8 :

Application 9 :

Application 10 :

Application 11 :

Application 12 :

ZOOM+

ZOOM-



PARTS IMAGE

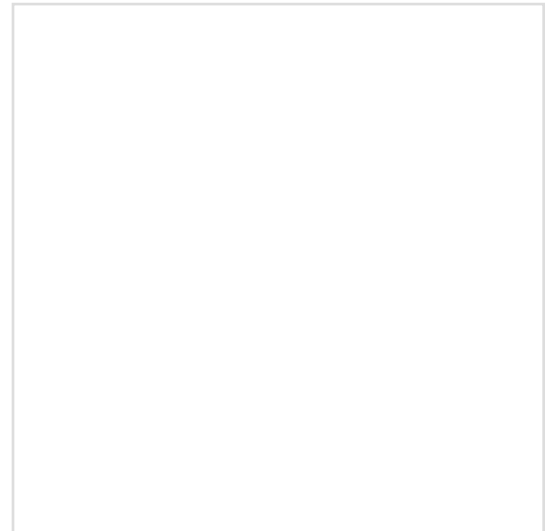

BOX IMAGE

WB-0302

WHEEL BEARING

Parts Number : WB-0302

Manufacture 1 : NSK

Manufacturer Number 1 : 36BWD01BCA60

Manufacture 2 :

Manufacture Number 2 :

M.S.R.P 04/2010 :

Description: WHEEL BEARING

Application 1 :

Application 2 :

Application 3 :

Application 4 :

Application 5 :

Application 6 :

Application 7 :

Application 8 :

Application 9 :

Application 10 :

Application 11 :

Application 12 :

ZOOM+

ZOOM-

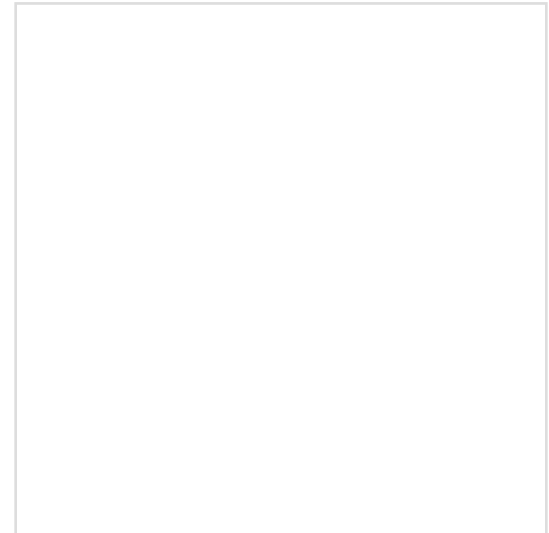

PARTS IMAGE

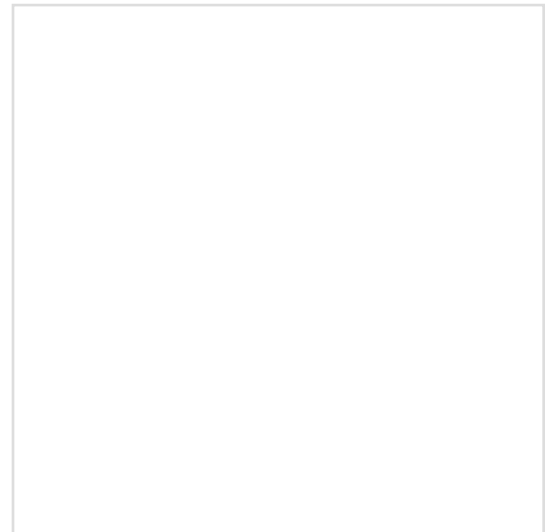

BOX IMAGE

WB-0303

WHEEL BEARING

Parts Number : WB-0303

Manufacture 1 : NSK

Manufacturer Number 1 : 40BWD05CA60

Manufacture 2 :

Manufacturer Number 2 : 44300-SE0-018

M.S.R.P 04/2010 :

Description: WHEEL BEARING

Application 1 : HONDA ACCORD 2D 88-89

Application 2 : HONDA ACCORD 4D 86-89

Application 3 :

Application 4 :

Application 5 :

Application 6 :

Application 7 :

Application 8 :

Application 9 :

Application 10 :

Application 11 :

Application 12 :

ZOOM+

ZOOM-



PARTS IMAGE



BOX IMAGE

WB-0304

WHEEL BEARING

Parts Number :	WB-0304
Manufacture 1 :	NSK <input type="button" value="v"/>
Manufacturer Number 1 :	43BWK03DY2CA20
Manufacture 2 :	NTN <input type="button" value="v"/>
Manufacture Number 2 :	HUB081-46
M.S.R.P 04/2010 :	
Description:	WHEEL BEARING

- Application 1 :** 44200-SM1-008/ 44200-SM4-013
- Application 2 :** HONDA ACCORD 14 90-97
- Application 3 :**
- Application 4 :**
- Application 5 :**
- Application 6 :**
- Application 7 :**
- Application 8 :**
- Application 9 :**
- Application 10 :**
- Application 11 :**
- Application 12 :**

ZOOM+ ZOOM-



PARTS IMAGE



BOX IMAGE

WB-0305

WHEEL BEARING

Parts Number : WB-0305

Manufacture 1 : NACHI

Manufacturer Number 1 : 62/28C3 W/O RING

Manufacture 2 :

Manufacture Number 2 :

M.S.R.P 04/2010 :

Description: WHEEL BEARING

Application 1 :

Application 2 :

Application 3 :

Application 4 :

Application 5 :

Application 6 :

Application 7 :

Application 8 :

Application 9 :

Application 10 :

Application 11 :

Application 12 :

ZOOM+

ZOOM-



PARTS IMAGE

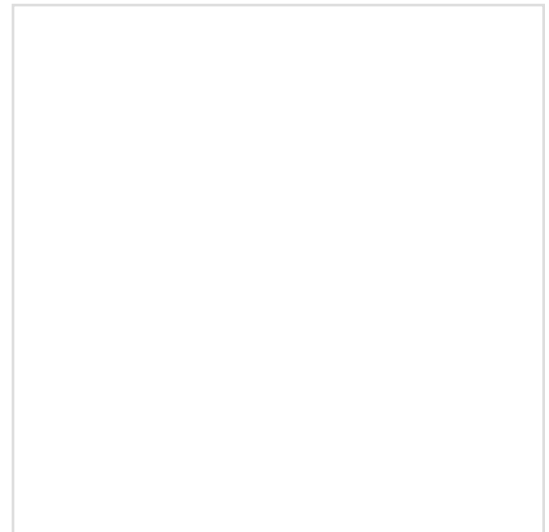

BOX IMAGE

WB-0306

WHEEL BEARING

Parts Number : WB-0306

Manufacture 1 : KOYO

Manufacturer Number 1 : DAC4484CW2RSCS76

Manufacture 2 : NTN

Manufacture Number 2 : DE0978LLCS64PX1/01

M.S.R.P 04/2010 :

Description: WHEEL BEARING

Application 1 :

Application 2 :

Application 3 :

Application 4 :

Application 5 :

Application 6 :

Application 7 :

Application 8 :

Application 9 :

Application 10 :

Application 11 :

Application 12 :

ZOOM+

ZOOM-

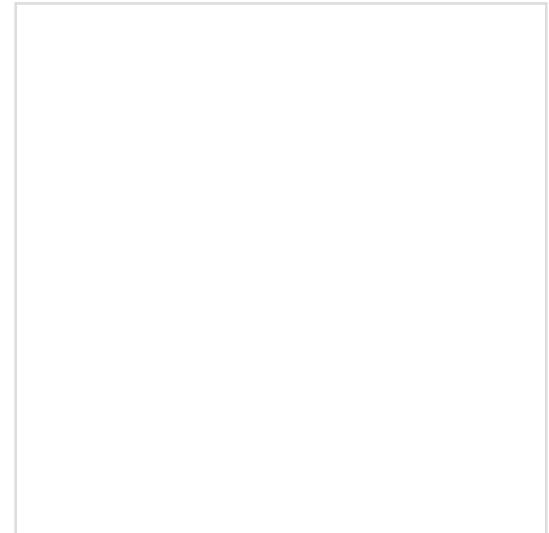

PARTS IMAGE

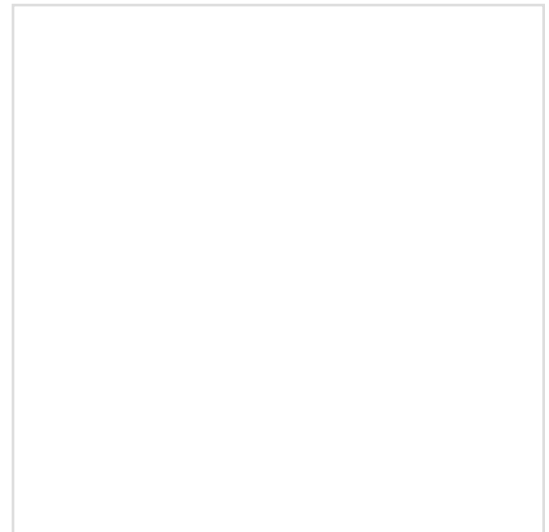

BOX IMAGE

WB-0307

WHEEL BEARING

Parts Number :	WB-0307
Manufacture 1 :	NACHI <input type="button" value="v"/>
Manufacturer Number 1 :	H28BVV10-3
Manufacture 2 :	NTN <input type="button" value="v"/>
Manufacture Number 2 :	HUB008-72
M.S.R.P 04/2010 :	
Description:	WHEEL BEARING

- Application 1 :** 42200-SB2-018/ 42200-SF4-008
- Application 2 :** HONDA CIVIC 84-91
- Application 3 :** HONDA CRX 88-91
- Application 4 :**
- Application 5 :**
- Application 6 :**
- Application 7 :**
- Application 8 :**
- Application 9 :**
- Application 10 :**
- Application 11 :**
- Application 12 :**

ZOOM+ ZOOM-



PARTS IMAGE



BOX IMAGE

WB-0308

WHEEL BEARING MADE IN

Parts Number : WB-0308

Manufacture 1 : NTN

Manufacturer Number 1 : DE0745LLCS32PX1/5A

Manufacture 2 :

Manufacturer Number 2 :

M.S.R.P 04/2010 :

Description: WHEEL BEARING MADE IN JAPAN

Application 1 :

Application 2 :

Application 3 :

Application 4 :

Application 5 :

Application 6 :

Application 7 :

Application 8 :

Application 9 :

Application 10 :

Application 11 :

Application 12 :

ZOOM+

ZOOM-



PARTS IMAGE

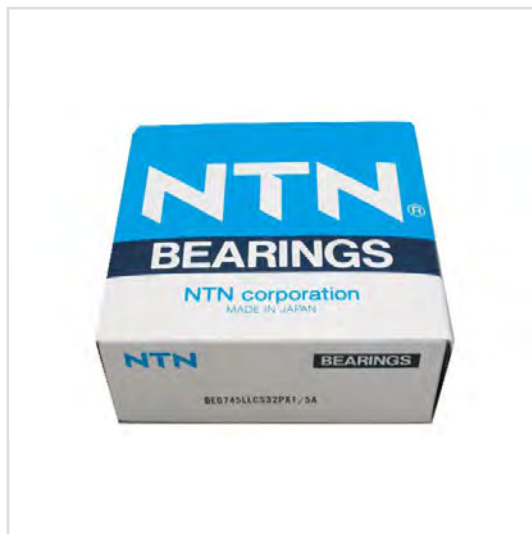

BOX IMAGE

WB-0309

WHEEL BEARING

Parts Number :	WB-0309
Manufacture 1 :	NTN <input type="button" value="v"/>
Manufacturer Number 1 :	DE0829LLCS32PX1/5A
Manufacture 2 :	KOYO <input type="button" value="v"/>
Manufacturer Number 2 :	DAC4278C2
M.S.R.P 04/2010 :	
Description:	WHEEL BEARING

- Application 1 :
- Application 2 :
- Application 3 :
- Application 4 :
- Application 5 :
- Application 6 :
- Application 7 :
- Application 8 :
- Application 9 :
- Application 10 :
- Application 11 :
- Application 12 :

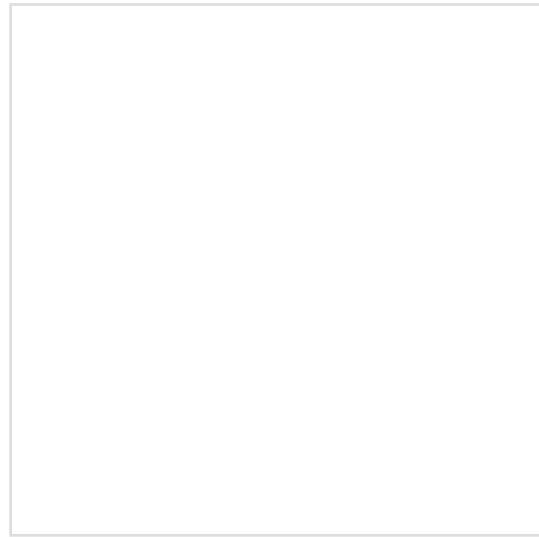

PARTS IMAGE

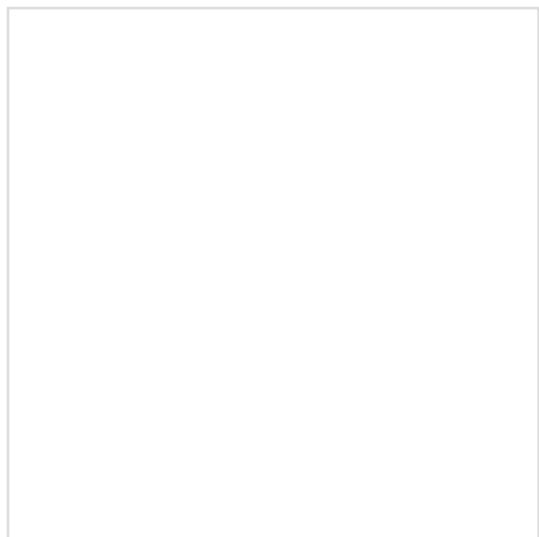

BOX IMAGE

WB-0310

WHEEL BEARING

Parts Number : WB-0310

Manufacture 1 : NACHI

Manufacturer Number 1 : 6304

Manufacture 2 :

Manufacture Number 2 :

M.S.R.P 04/2010 :

Description: WHEEL BEARING

Application 1 :

Application 2 :

Application 3 :

Application 4 :

Application 5 :

Application 6 :

Application 7 :

Application 8 :

Application 9 :

Application 10 :

Application 11 :

Application 12 :

ZOOM+

ZOOM-



PARTS IMAGE



BOX IMAGE

WB-0311

WHEEL BEARING

Parts Number : WB-0311

Manufacture 1 : NACHI

Manufacturer Number 1 : F25BVV10-7

Manufacture 2 :

Manufacture Number 2 :

M.S.R.P 04/2010 :

Description: WHEEL BEARING

Application 1 :

Application 2 :

Application 3 :

Application 4 :

Application 5 :

Application 6 :

Application 7 :

Application 8 :

Application 9 :

Application 10 :

Application 11 :

Application 12 :

ZOOM+

ZOOM-



PARTS IMAGE

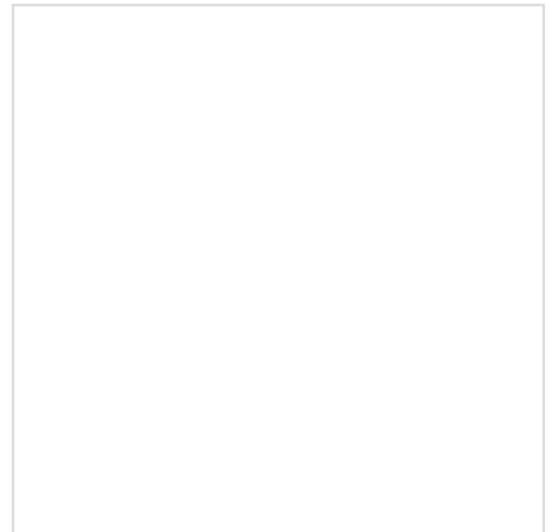

BOX IMAGE

WB-0312

WHEEL BEARING

Parts Number : WB-0312

Manufacture 1 : NACHI

Manufacturer Number 1 : 38BVV07-10G / 45BWD12J1CA85

Manufacture 2 :

Manufacture Number 2 : 44300-SB2-966

M.S.R.P 04/2010 :

Description: WHEEL BEARING

Application 1 : HONDA CIVIC 84-88

Application 2 : HONDA CRX 85-88

Application 3 : ACURA INTEGRA 86-89

Application 4 :

Application 5 :

Application 6 :

Application 7 :

Application 8 :

Application 9 :

Application 10 :

Application 11 :

Application 12 :

ZOOM+

ZOOM-



PARTS IMAGE



BOX IMAGE

WB-0313

WHEEL BEARING

Parts Number : WB-0313

Manufacture 1 : KOYO

Manufacturer Number 1 : DAC3872ACS42

Manufacture 2 :

Manufacture Number 2 :

M.S.R.P 04/2010 :

Description: WHEEL BEARING

Application 1 : 91051-SB0-004

Application 2 :

Application 3 :

Application 4 :

Application 5 :

Application 6 :

Application 7 :

Application 8 :

Application 9 :

Application 10 :

Application 11 :

Application 12 :

ZOOM+

ZOOM-



PARTS IMAGE

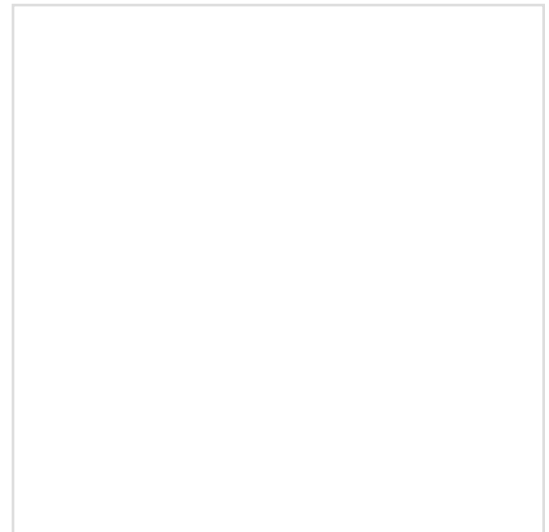

BOX IMAGE

WB-0314

WHEEL BEARING

Parts Number : WB-0314

Manufacture 1 : NTN

Manufacturer Number 1 : DE08A48LLCS46PX1 = AU0811-6LXL

Manufacture 2 :

Manufacture Number 2 : 44300-S04-004/008, 44300-SR3-004

M.S.R.P 04/2010 :

Description: WHEEL BEARING

Application 1 : HONDA CIVIC 92-00

Application 2 : HONDA CR-V LX 02-04

Application 3 :

Application 4 :

Application 5 :

Application 6 :

Application 7 :

Application 8 :

Application 9 :

Application 10 :

Application 11 :

Application 12 :

ZOOM+

ZOOM-



PARTS IMAGE



BOX IMAGE

WB-0315

WHEEL BEARING

Parts Number :	WB-0315
Manufacture 1 :	KOYO <input type="button" value="v"/>
Manufacturer Number 1 :	DAC4278A2RSC52
Manufacture 2 :	<input type="button" value="v"/>
Manufacturer Number 2 :	
M.S.R.P 04/2010 :	
Description:	WHEEL BEARING

- Application 1 : 44300-SD4-038
- Application 2 :
- Application 3 :
- Application 4 :
- Application 5 :
- Application 6 :
- Application 7 :
- Application 8 :
- Application 9 :
- Application 10 :
- Application 11 :
- Application 12 :

ZOOM+ ZOOM-



PARTS IMAGE



BOX IMAGE

WB-0316

WHEEL BEARING

Parts Number :	WB-0316
Manufacture 1 :	NTN <input type="button" value="v"/>
Manufacturer Number 1 :	HUB083-64
Manufacture 2 :	<input type="button" value="v"/>
Manufacturer Number 2 :	
M.S.R.P 04/2010 :	
Description:	WHEEL BEARING

ZOOM+ ZOOM-



PARTS IMAGE

- Application 1 :
- Application 2 :
- Application 3 :
- Application 4 :
- Application 5 :
- Application 6 :
- Application 7 :
- Application 8 :
- Application 9 :
- Application 10 :
- Application 11 :
- Application 12 :



BOX IMAGE

WB-0317

WHEEL BEARING

Parts Number : WB-0317

Manufacture 1 : NTN

Manufacturer Number 1 : HUB008-1

Manufacture 2 :

Manufacturer Number 2 :

M.S.R.P 04/2010 :

Description: WHEEL BEARING

Application 1 :

Application 2 :

Application 3 :

Application 4 :

Application 5 :

Application 6 :

Application 7 :

Application 8 :

Application 9 :

Application 10 :

Application 11 :

Application 12 :

ZOOM+

ZOOM-



PARTS IMAGE

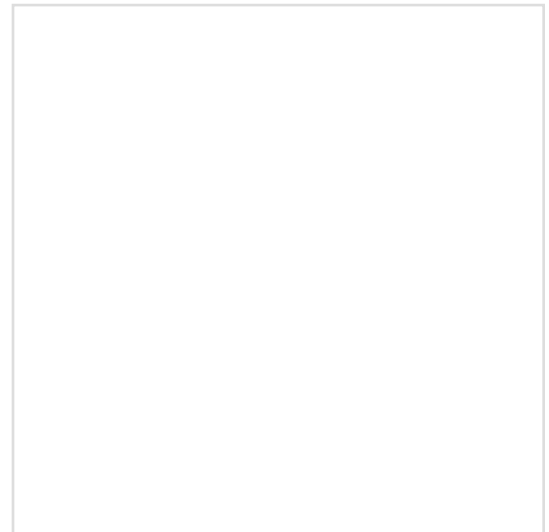

BOX IMAGE

WB-0318

Parts Number : WB-0318

Manufacture 1 : NTN

Manufacturer Number 1 : HUB083-65

Manufacture 2 :

Manufacturer Number 2 :

M.S.R.P 04/2010 :

Description: WHEEL BEARING MADE IN JAPAN

WHEEL BEARING MADE IN



PARTS IMAGE

Application 1 :

Application 2 :

Application 3 :

Application 4 :

Application 5 :

Application 6 :

Application 7 :

Application 8 :

Application 9 :

Application 10 :

Application 11 :

Application 12 :



BOX IMAGE

WB-0319

WHEEL BEARING

Parts Number : WB-0319

Manufacture 1 : NTN

Manufacturer Number 1 : HUB083-69/30

Manufacture 2 :

Manufacturer Number 2 :

M.S.R.P 04/2010 :

Description: WHEEL BEARING

Application 1 :

Application 2 :

Application 3 :

Application 4 :

Application 5 :

Application 6 :

Application 7 :

Application 8 :

Application 9 :

Application 10 :

Application 11 :

Application 12 :

ZOOM+

ZOOM-



PARTS IMAGE

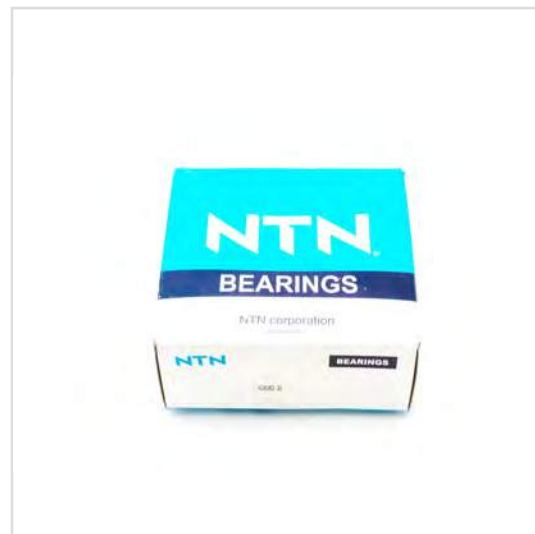

BOX IMAGE

WB-0320

WHEEL BEARING

Parts Number :	WB-0320
Manufacture 1 :	NTN <input type="button" value="v"/>
Manufacturer Number 1 :	HUB094-13
Manufacture 2 :	<input type="button" value="v"/>
Manufacturer Number 2 :	
M.S.R.P 04/2010 :	
Description:	WHEEL BEARING

- Application 1 :
- Application 2 :
- Application 3 :
- Application 4 :
- Application 5 :
- Application 6 :
- Application 7 :
- Application 8 :
- Application 9 :
- Application 10 :
- Application 11 :
- Application 12 :

ZOOM+ ZOOM-



PARTS IMAGE



BOX IMAGE

WB-0321

WHEEL BEARING

Parts Number : WB-0321

Manufacture 1 : NTN

Manufacturer Number 1 : HUB028-16

Manufacture 2 :

Manufacturer Number 2 :

M.S.R.P 04/2010 :

Description: WHEEL BEARING

Application 1 :

Application 2 :

Application 3 :

Application 4 :

Application 5 :

Application 6 :

Application 7 :

Application 8 :

Application 9 :

Application 10 :

Application 11 :

Application 12 :

ZOOM+

ZOOM-



PARTS IMAGE

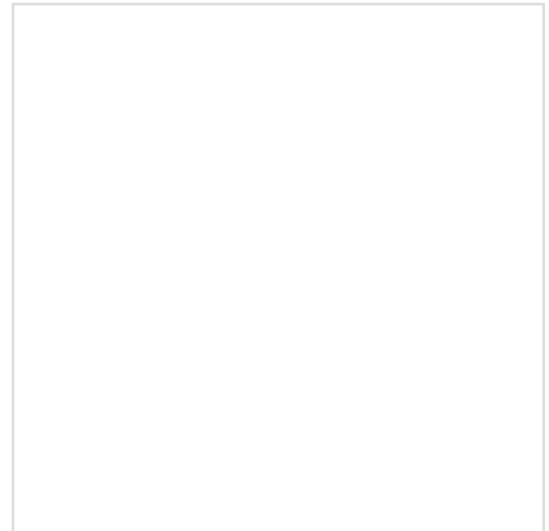

BOX IMAGE

WB-0322

WHEEL BEARING

Parts Number : WB-0322

Manufacture 1 : NTN

Manufacturer Number 1 : DE1015LLCS82PX1/L260

Manufacture 2 :

Manufacturer Number 2 : 44300-SPO-004

M.S.R.P 04/2010 :

Description: WHEEL BEARING

Application 1 : ACURA 3.5RL 96-04

Application 2 :

Application 3 :

Application 4 :

Application 5 :

Application 6 :

Application 7 :

Application 8 :

Application 9 :

Application 10 :

Application 11 :

Application 12 :

ZOOM+

ZOOM-

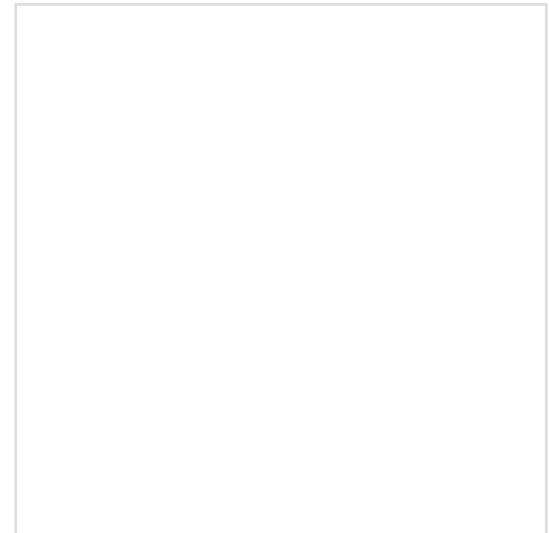

PARTS IMAGE

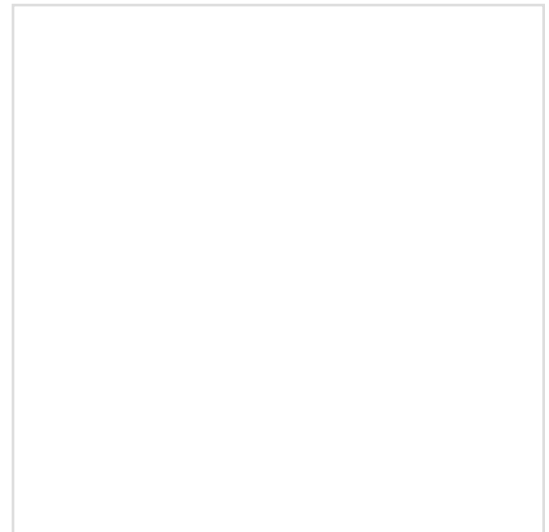

BOX IMAGE

WB-0323

Parts Number : WB-0323

Manufacture 1 : NTN

Manufacturer Number 1 : HUB005-36

Manufacture 2 :

Manufacturer Number 2 :

M.S.R.P 04/2010 :

Description: WHEEL BEARING MADE IN JAPAN

Application 1 :

Application 2 :

Application 3 :

Application 4 :

Application 5 :

Application 6 :

Application 7 :

Application 8 :

Application 9 :

Application 10 :

Application 11 :

Application 12 :

WHEEL BEARING MADE IN



PARTS IMAGE



BOX IMAGE

WB-0324

WHEEL BEARING

Parts Number : WB-0324

Manufacture 1 : NTN

Manufacturer Number 1 : HUB005-63

Manufacture 2 :

Manufacture Number 2 :

M.S.R.P 04/2010 :

Description: WHEEL BEARING

Application 1 :

Application 2 :

Application 3 :

Application 4 :

Application 5 :

Application 6 :

Application 7 :

Application 8 :

Application 9 :

Application 10 :

Application 11 :

Application 12 :

ZOOM+

ZOOM-

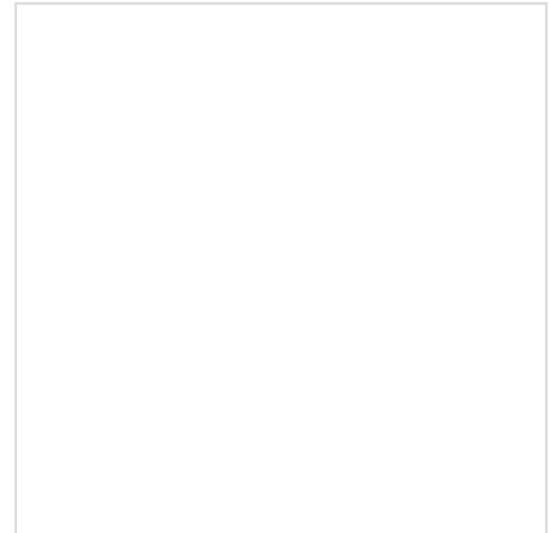

PARTS IMAGE

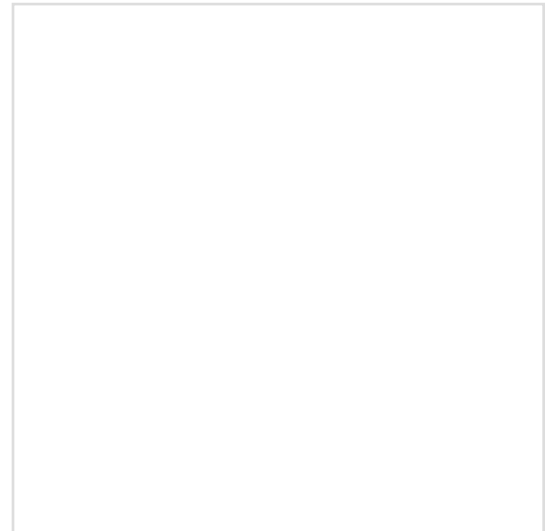

BOX IMAGE

WB-0325

WHEEL BEARING

Parts Number : WB-0325

Manufacture 1 : NTN

Manufacturer Number 1 : HUB005-37

Manufacture 2 :

Manufacturer Number 2 : 42450-63011

M.S.R.P 04/2010 :

Description: WHEEL BEARING

Application 1 : TOYOTA CELICA GT GT-S 00-05

Application 2 : SCION tC 05-010

Application 3 :

Application 4 :

Application 5 :

Application 6 :

Application 7 :

Application 8 :

Application 9 :

Application 10 :

Application 11 :

Application 12 :

ZOOM+

ZOOM-



PARTS IMAGE

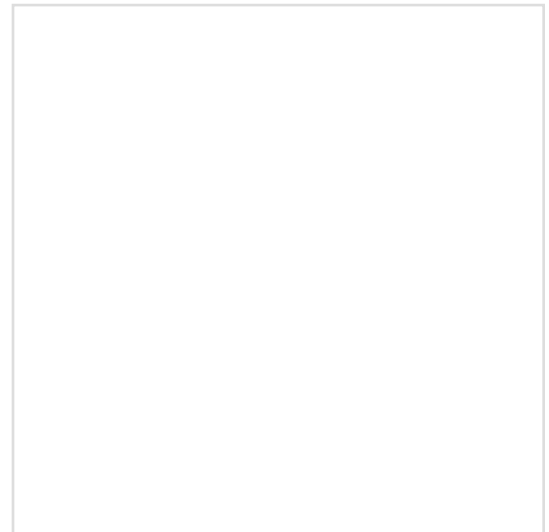

BOX IMAGE

WB-0326

WHEEL BEARING

Parts Number : WB-0326

Manufacture 1 : NSK

Manufacturer Number 1 : 43BWK04Y2CA20

Manufacture 2 :

Manufacturer Number 2 :

M.S.R.P 04/2010 :

Description: WHEEL BEARING

Application 1 :

Application 2 :

Application 3 :

Application 4 :

Application 5 :

Application 6 :

Application 7 :

Application 8 :

Application 9 :

Application 10 :

Application 11 :

Application 12 :

ZOOM+

ZOOM-



PARTS IMAGE



BOX IMAGE

WB-0327

WHEEL BEARING

Parts Number : WB-0327

Manufacture 1 : NTN

Manufacturer Number 1 : AU0907-1LX3L/L260

Manufacture 2 : KOYO

Manufacturer Number 2 : DAC4379W-1CS57

M.S.R.P 04/2010 :

Description: WHEEL BEARING

Application 1 : 44300-S04-A02 / 44300-S5A-008

Application 2 : ACURA INTEGRA RS LS SE GS TYPE R 94-01

Application 3 : HONDA CIVIC DX HX LX GX HYBRID 01-05

Application 4 : HONDA CIVIC DEL SOL 93-96

Application 5 :

Application 6 :

Application 7 :

Application 8 :

Application 9 :

Application 10 :

Application 11 :

Application 12 :

ZOOM+

ZOOM-



PARTS IMAGE



BOX IMAGE

WB-0328

WHEEL BEARING

Parts Number :	WB-0328
Manufacture 1 :	NTN <input type="button" value="v"/>
Manufacturer Number 1 :	HUB005-66
Manufacture 2 :	<input type="button" value="v"/>
Manufacturer Number 2 :	
M.S.R.P 04/2010 :	
Description:	WHEEL BEARING

- Application 1 :
- Application 2 :
- Application 3 :
- Application 4 :
- Application 5 :
- Application 6 :
- Application 7 :
- Application 8 :
- Application 9 :
- Application 10 :
- Application 11 :
- Application 12 :

ZOOM+ ZOOM-



PARTS IMAGE



BOX IMAGE

WB-0329

WHEEL BEARING

Parts Number : WB-0329

Manufacture 1 : NTN

Manufacturer Number 1 : HUB112-16

Manufacture 2 :

Manufacturer Number 2 :

M.S.R.P 04/2010 :

Description: WHEEL BEARING

Application 1 :

Application 2 :

Application 3 :

Application 4 :

Application 5 :

Application 6 :

Application 7 :

Application 8 :

Application 9 :

Application 10 :

Application 11 :

Application 12 :

ZOOM+

ZOOM-



PARTS IMAGE

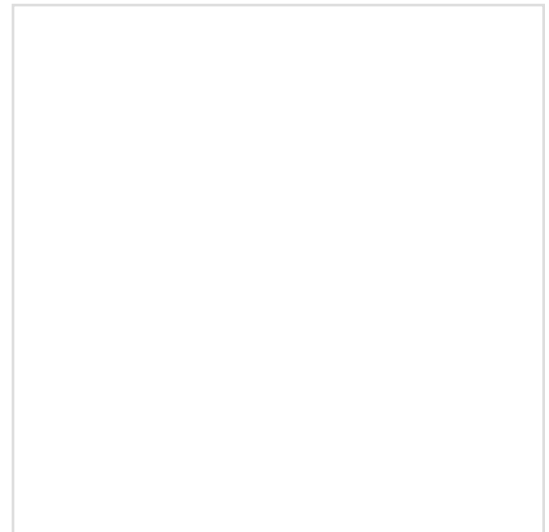

BOX IMAGE

WB-0331

WHEEL BEARING

Parts Number : WB-0331

Manufacture 1 : NTN

Manufacturer Number 1 : HUB112-1

Manufacture 2 :

Manufacturer Number 2 :

M.S.R.P 04/2010 :

Description: WHEEL BEARING

Application 1 :

Application 2 :

Application 3 :

Application 4 :

Application 5 :

Application 6 :

Application 7 :

Application 8 :

Application 9 :

Application 10 :

Application 11 :

Application 12 :

ZOOM+

ZOOM-



PARTS IMAGE



BOX IMAGE

WB-0332

WHEEL BEARING

Parts Number : WB-0332

Manufacture 1 : NTN

Manufacturer Number 1 : HUB091-18

Manufacture 2 :

Manufacturer Number 2 :

M.S.R.P 04/2010 :

Description: WHEEL BEARING

Application 1 :

Application 2 :

Application 3 :

Application 4 :

Application 5 :

Application 6 :

Application 7 :

Application 8 :

Application 9 :

Application 10 :

Application 11 :

Application 12 :

ZOOM+

ZOOM-



PARTS IMAGE

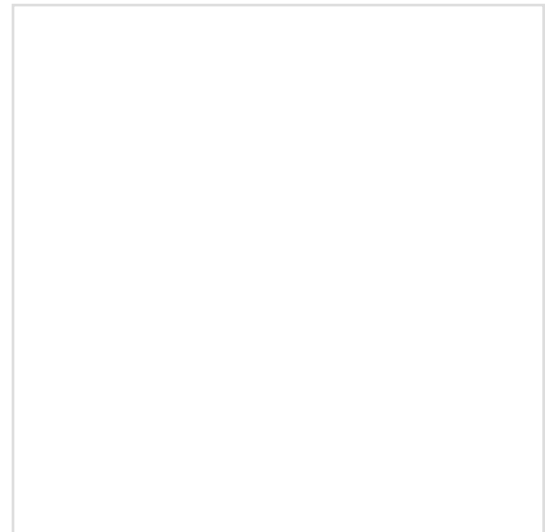

BOX IMAGE

WB-0333

WHEEL BEARING

Parts Number :	WB-0333
Manufacture 1 :	NTN <input type="button" value="v"/>
Manufacturer Number 1 :	HUB082-13
Manufacture 2 :	<input type="button" value="v"/>
Manufacturer Number 2 :	
M.S.R.P 04/2010 :	
Description:	WHEEL BEARING

- Application 1 :
- Application 2 :
- Application 3 :
- Application 4 :
- Application 5 :
- Application 6 :
- Application 7 :
- Application 8 :
- Application 9 :
- Application 10 :
- Application 11 :
- Application 12 :

ZOOM+ ZOOM-



PARTS IMAGE



BOX IMAGE

WB-0334

WHEEL BEARING

Parts Number : WB-0334

Manufacture 1 : NTN

Manufacturer Number 1 : HUB150-5

Manufacture 2 :

Manufacturer Number 2 :

M.S.R.P 04/2010 :

Description: WHEEL BEARING

Application 1 : ACURA 3.5RL 96-04

Application 2 :

Application 3 :

Application 4 :

Application 5 :

Application 6 :

Application 7 :

Application 8 :

Application 9 :

Application 10 :

Application 11 :

Application 12 :

ZOOM+

ZOOM-



PARTS IMAGE



BOX IMAGE

WB-0335

WHEEL BEARING

Parts Number :	WB-0335
Manufacture 1 :	NTN <input type="button" value="v"/>
Manufacturer Number 1 :	HUB112-14
Manufacture 2 :	<input type="button" value="v"/>
Manufacturer Number 2 :	
M.S.R.P 04/2010 :	
Description:	WHEEL BEARING

- Application 1 :
- Application 2 :
- Application 3 :
- Application 4 :
- Application 5 :
- Application 6 :
- Application 7 :
- Application 8 :
- Application 9 :
- Application 10 :
- Application 11 :
- Application 12 :

ZOOM+ ZOOM-



PARTS IMAGE



BOX IMAGE

WB-0336

WHEEL BEARING

Parts Number : WB-0336

Manufacture 1 : NSK

Manufacturer Number 1 : 45BWD07CA78/86

Manufacture 2 :

Manufacturer Number 2 :

M.S.R.P 04/2010 :

Description: WHEEL BEARING

Application 1 : 44300-S47-008

Application 2 : 44300-S84-A01

Application 3 : HONDA ACCORD L4 98-02

Application 4 : HONDA ACCORD V6 98-02

Application 5 : ACURA 3.2TL 99-02

Application 6 : HONDA S2000 00-09

Application 7 : ACURA 3.2 TL TYPE S 02-03

Application 8 : ACURA RSX L, TYPE-S, 02-06

Application 9 : HONDA CR-V 02-04

Application 10 : HONDA ELEMENT 03-05

Application 11 :

Application 12 :

ZOOM+

ZOOM-



PARTS IMAGE



BOX IMAGE

WB-0337

WHEEL BEARING

Parts Number : WB-0337

Manufacture 1 : NTN

Manufacturer Number 1 : HUB-094-18

Manufacture 2 :

Manufacturer Number 2 :

M.S.R.P 04/2010 :

Description: WHEEL BEARING

Application 1 :

Application 2 :

Application 3 :

Application 4 :

Application 5 :

Application 6 :

Application 7 :

Application 8 :

Application 9 :

Application 10 :

Application 11 :

Application 12 :

ZOOM+

ZOOM-



PARTS IMAGE

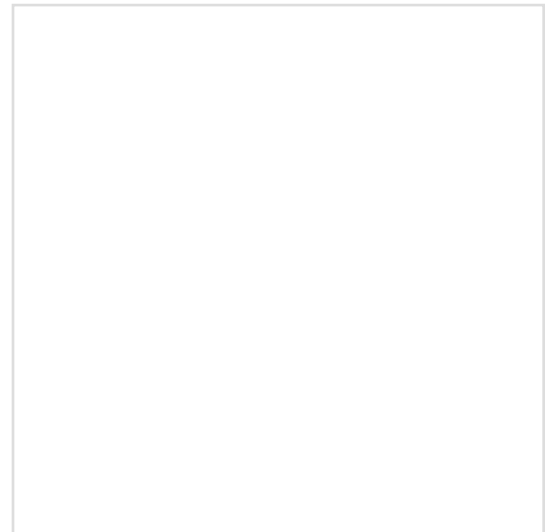

BOX IMAGE

WB-0340

WHEEL BEARING

Parts Number : WB-0340

Manufacture 1 : NTN

Manufacturer Number 1 : HUB132-2

Manufacture 2 :

Manufacturer Number 2 :

M.S.R.P 04/2010 :

Description: WHEEL BEARING

Application 1 :

Application 2 :

Application 3 :

Application 4 :

Application 5 :

Application 6 :

Application 7 :

Application 8 :

Application 9 :

Application 10 :

Application 11 :

Application 12 :

ZOOM+ ZOOM-



PARTS IMAGE



BOX IMAGE

WB-0341

WHEEL BEARING

Parts Number : WB-0341

Manufacture 1 : NTN

Manufacturer Number 1 : HUB181-26

Manufacture 2 :

Manufacturer Number 2 :

M.S.R.P 04/2010 :

Description: WHEEL BEARING

Application 1 :

Application 2 :

Application 3 :

Application 4 :

Application 5 :

Application 6 :

Application 7 :

Application 8 :

Application 9 :

Application 10 :

Application 11 :

Application 12 :

ZOOM+

ZOOM-



PARTS IMAGE

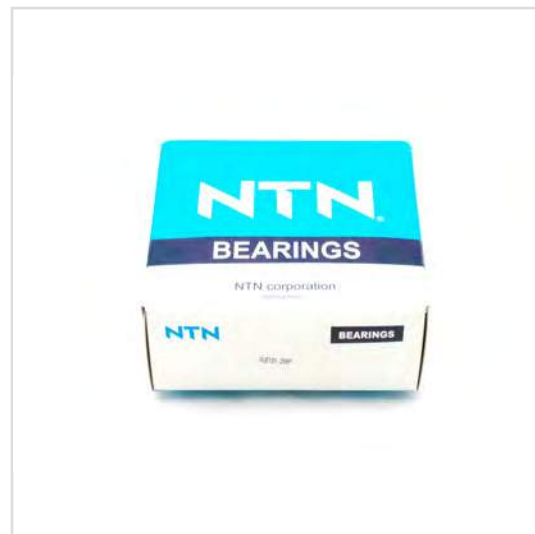

BOX IMAGE

WB-0342

WHEEL BEARING

Parts Number :	WB-0342
Manufacture 1 :	NTN <input type="button" value="v"/>
Manufacturer Number 1 :	HUB181-32
Manufacture 2 :	<input type="button" value="v"/>
Manufacturer Number 2 :	
M.S.R.P 04/2010 :	
Description:	WHEEL BEARING

- Application 1 :
- Application 2 :
- Application 3 :
- Application 4 :
- Application 5 :
- Application 6 :
- Application 7 :
- Application 8 :
- Application 9 :
- Application 10 :
- Application 11 :
- Application 12 :

ZOOM+ ZOOM-



PARTS IMAGE



BOX IMAGE

WB-0343

WHEEL BEARING (USA)

Parts Number : WB-0343

Manufacture 1 : NTN

Manufacturer Number 1 : HUB227-24

Manufacture 2 :

Manufacturer Number 2 :

M.S.R.P 04/2010 :

Description: WHEEL BEARING (USA)

Application 1 :

Application 2 :

Application 3 :

Application 4 :

Application 5 :

Application 6 :

Application 7 :

Application 8 :

Application 9 :

Application 10 :

Application 11 :

Application 12 :

ZOOM+

ZOOM-



PARTS IMAGE



BOX IMAGE

WB-0345

WHEEL BEARING

Parts Number : WB-0345

Manufacture 1 : NTN

Manufacturer Number 1 : HUB227-26

Manufacture 2 :

Manufacturer Number 2 :

M.S.R.P 04/2010 :

Description: WHEEL BEARING

Application 1 :

Application 2 :

Application 3 :

Application 4 :

Application 5 :

Application 6 :

Application 7 :

Application 8 :

Application 9 :

Application 10 :

Application 11 :

Application 12 :

ZOOM+

ZOOM-



PARTS IMAGE



BOX IMAGE

WB-0346

WHEEL BEARING (USA)

Parts Number :	WB-0346
Manufacture 1 :	NTN <input type="button" value="v"/>
Manufacturer Number 1 :	AU0901-12LL
Manufacture 2 :	<input type="button" value="v"/>
Manufacturer Number 2 :	
M.S.R.P 04/2010 :	
Description:	WHEEL BEARING (USA)

- Application 1 :
- Application 2 :
- Application 3 :
- Application 4 :
- Application 5 :
- Application 6 :
- Application 7 :
- Application 8 :
- Application 9 :
- Application 10 :
- Application 11 :
- Application 12 :

ZOOM+ ZOOM-



PARTS IMAGE



BOX IMAGE

WB-0347

WHEEL BEARING

Parts Number : WB-0347
Manufacture 1 : NSK
Manufacturer Number 1 : 48WD01BCA93
Manufacture 2 :
Manufacturer Number 2 :
M.S.R.P 04/2010 :
Description: WHEEL BEARING

- Application 1 :
- Application 2 :
- Application 3 :
- Application 4 :
- Application 5 :
- Application 6 :
- Application 7 :
- Application 8 :
- Application 9 :
- Application 10 :
- Application 11 :
- Application 12 :

ZOOM+ ZOOM-



PARTS IMAGE



BOX IMAGE

WB-0348

WHEEL BEARING

Parts Number : WB-0348

Manufacture 1 : NSK

Manufacturer Number 1 : 48BWD02A2CA97

Manufacture 2 :

Manufacture Number 2 :

M.S.R.P 04/2010 :

Description: WHEEL BEARING

Application 1 :

Application 2 :

Application 3 :

Application 4 :

Application 5 :

Application 6 :

Application 7 :

Application 8 :

Application 9 :

Application 10 :

Application 11 :

Application 12 :

ZOOM+ ZOOM-



PARTS IMAGE



BOX IMAGE

WB-0349

WHEEL BEARING

Parts Number : WB-0349

Manufacture 1 : NSK

Manufacturer Number 1 : 45BWD12J1CA85

Manufacture 2 :

Manufacture Number 2 :

M.S.R.P 04/2010 :

Description: WHEEL BEARING

Application 1 :

Application 2 :

Application 3 :

Application 4 :

Application 5 :

Application 6 :

Application 7 :

Application 8 :

Application 9 :

Application 10 :

Application 11 :

Application 12 :

ZOOM+ ZOOM-



PARTS IMAGE



BOX IMAGE

WB-0350

WHEEL BEARING

Parts Number :	WB-0350
Manufacture 1 :	NTN <input type="button" value="v"/>
Manufacturer Number 1 :	HUB189-2
Manufacture 2 :	<input type="button" value="v"/>
Manufacturer Number 2 :	
M.S.R.P 04/2010 :	
Description:	WHEEL BEARING

- Application 1 :
- Application 2 :
- Application 3 :
- Application 4 :
- Application 5 :
- Application 6 :
- Application 7 :
- Application 8 :
- Application 9 :
- Application 10 :
- Application 11 :
- Application 12 :

ZOOM+ ZOOM-



PARTS IMAGE



BOX IMAGE

WB-0401

WHEEL BEARING

Parts Number : WB-0401

Manufacture 1 : NTN

Manufacturer Number 1 : 4T-CR0676PX2

Manufacture 2 :

Manufacture Number 2 :

M.S.R.P 04/2010 :

Description: WHEEL BEARING

Application 1 :

Application 2 :

Application 3 :

Application 4 :

Application 5 :

Application 6 :

Application 7 :

Application 8 :

Application 9 :

Application 10 :

Application 11 :

Application 12 :

ZOOM+

ZOOM-



PARTS IMAGE

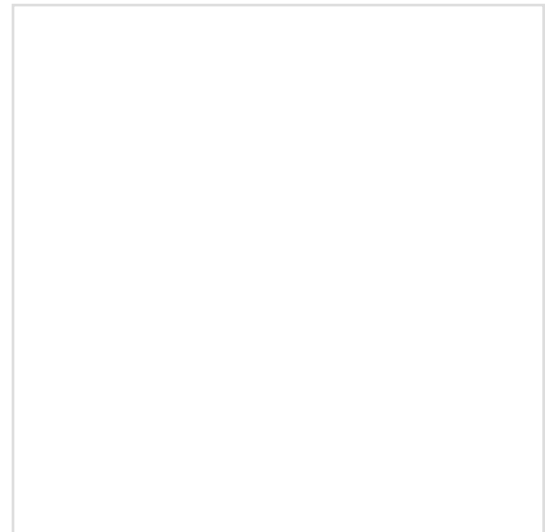

BOX IMAGE

WB-0402

WHEEL BEARING

Parts Number :	WB-0402
Manufacture 1 :	NSK <input type="button" value="v"/>
Manufacturer Number 1 :	TF28KW04G5SA
Manufacture 2 :	<input type="button" value="v"/>
Manufacturer Number 2 :	
M.S.R.P 04/2010 :	
Description:	WHEEL BEARING

- Application 1 :
- Application 2 :
- Application 3 :
- Application 4 :
- Application 5 :
- Application 6 :
- Application 7 :
- Application 8 :
- Application 9 :
- Application 10 :
- Application 11 :
- Application 12 :

ZOOM+ ZOOM-



PARTS IMAGE



BOX IMAGE

WB-0403

WHEEL BEARING

Parts Number : WB-0403

Manufacture 1 : NSK

Manufacturer Number 1 : 62/28DDU

Manufacture 2 :

Manufacture Number 2 :

M.S.R.P 04/2010 :

Description: WHEEL BEARING

Application 1 :

Application 2 :

Application 3 :

Application 4 :

Application 5 :

Application 6 :

Application 7 :

Application 8 :

Application 9 :

Application 10 :

Application 11 :

Application 12 :

ZOOM+

ZOOM-



PARTS IMAGE

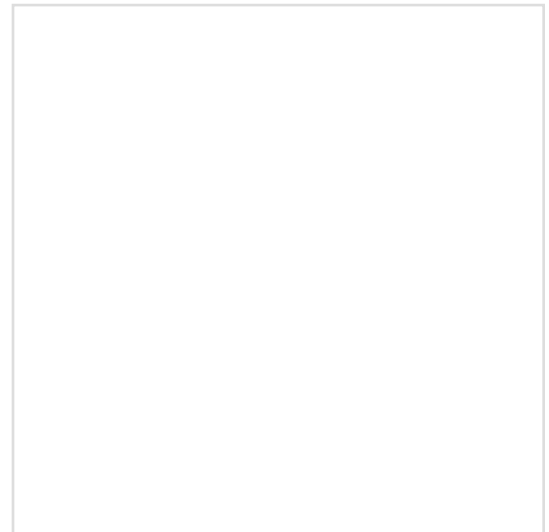

BOX IMAGE

WB-0404

WHEEL BEARING

Parts Number :	WB-0404
Manufacture 1 :	KOYO <input type="button" value="v"/>
Manufacturer Number 1 :	57410/LM29710
Manufacture 2 :	NSK <input type="button" value="v"/>
Manufacturer Number 2 :	TF38KW01CG5
M.S.R.P 04/2010 :	
Description:	WHEEL BEARING

- Application 1 :
- Application 2 :
- Application 3 :
- Application 4 :
- Application 5 :
- Application 6 :
- Application 7 :
- Application 8 :
- Application 9 :
- Application 10 :
- Application 11 :
- Application 12 :

ZOOM+ ZOOM-



PARTS IMAGE



BOX IMAGE

WB-0405

WHEEL BEARING

Parts Number :	WB-0405
Manufacture 1 :	NSK <input type="button" value="v"/>
Manufacturer Number 1 :	TF28KW02G5SA
Manufacture 2 :	<input type="button" value="v"/>
Manufacturer Number 2 :	
M.S.R.P 04/2010 :	
Description:	WHEEL BEARING

- Application 1 :
- Application 2 :
- Application 3 :
- Application 4 :
- Application 5 :
- Application 6 :
- Application 7 :
- Application 8 :
- Application 9 :
- Application 10 :
- Application 11 :
- Application 12 :

ZOOM+ ZOOM-



PARTS IMAGE



BOX IMAGE

WB-0406

WHEEL BEARING

Parts Number : WB-0406

Manufacture 1 : KOYO

Manufacturer Number 1 : DAC4080M1CS68GA2

Manufacture 2 :

Manufacturer Number 2 :

M.S.R.P 04/2010 :

Description: WHEEL BEARING

Application 1 :

Application 2 :

Application 3 :

Application 4 :

Application 5 :

Application 6 :

Application 7 :

Application 8 :

Application 9 :

Application 10 :

Application 11 :

Application 12 :

ZOOM+

ZOOM-



PARTS IMAGE



BOX IMAGE

WB-0408

WHEEL BEARING

Parts Number : WB-0408

Manufacture 1 : NSK

Manufacturer Number 1 : 45BWD03CA101

Manufacture 2 :

Manufacturer Number 2 :

M.S.R.P 04/2010 :

Description: WHEEL BEARING

Application 1 :

Application 2 :

Application 3 :

Application 4 :

Application 5 :

Application 6 :

Application 7 :

Application 8 :

Application 9 :

Application 10 :

Application 11 :

Application 12 :

ZOOM+

ZOOM-



PARTS IMAGE



BOX IMAGE

WB-0409

WHEEL BEARING

Parts Number : WB-0409

Manufacture 1 : NSK

Manufacturer Number 1 : 28BWK080DG3Y2CA01

Manufacture 2 :

Manufacture Number 2 :

M.S.R.P 04/2010 :

Description: WHEEL BEARING

Application 1 :

Application 2 :

Application 3 :

Application 4 :

Application 5 :

Application 6 :

Application 7 :

Application 8 :

Application 9 :

Application 10 :

Application 11 :

Application 12 :

ZOOM+

ZOOM-

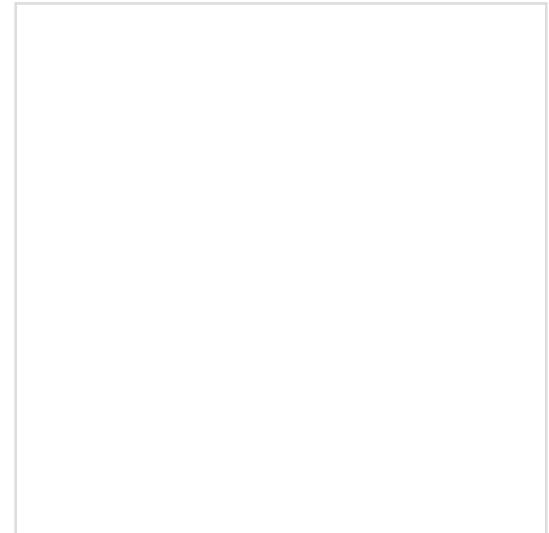

PARTS IMAGE

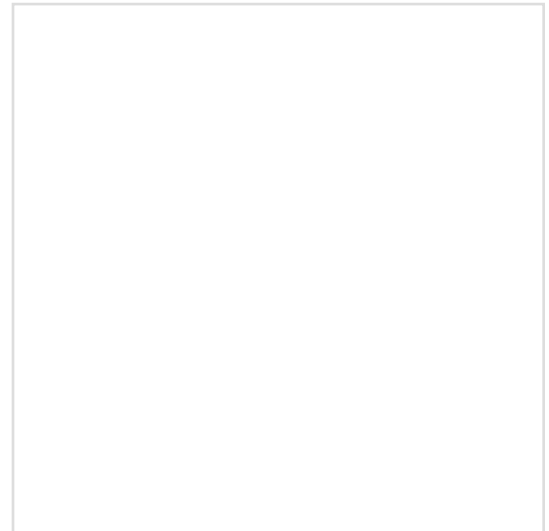

BOX IMAGE

WB-0410

WHEEL BEARING

Parts Number : WB-0410

Manufacture 1 : KOYO

Manufacturer Number 1 : DAC4074CWCS73

Manufacture 2 :

Manufacture Number 2 :

M.S.R.P 04/2010 :

Description: WHEEL BEARING

Application 1 :

Application 2 :

Application 3 :

Application 4 :

Application 5 :

Application 6 :

Application 7 :

Application 8 :

Application 9 :

Application 10 :

Application 11 :

Application 12 :

ZOOM+

ZOOM-



PARTS IMAGE

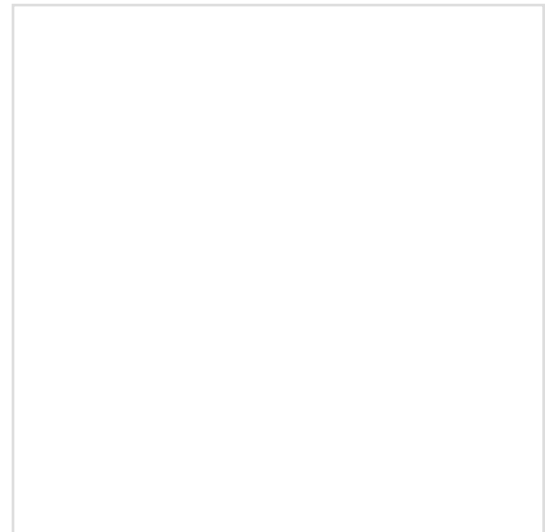

BOX IMAGE

WB-0415

WHEEL BEARING

Parts Number : WB-0415

Manufacture 1 : KOYO

Manufacturer Number 1 : DACF1034B-3MG

Manufacture 2 :

Manufacturer Number 2 :

M.S.R.P 04/2010 :

Description: WHEEL BEARING

Application 1 :

Application 2 :

Application 3 :

Application 4 :

Application 5 :

Application 6 :

Application 7 :

Application 8 :

Application 9 :

Application 10 :

Application 11 :

Application 12 :

ZOOM+

ZOOM-

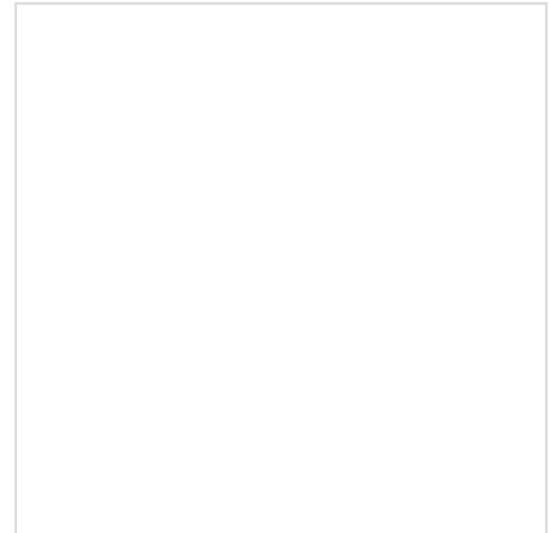

PARTS IMAGE

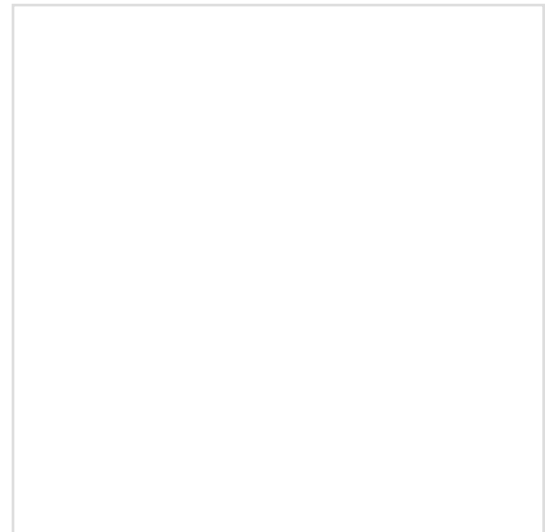

BOX IMAGE

WB-0501

WHEEL BEARING

Parts Number : WB-0501

Manufacture 1 : NSK

Manufacturer Number 1 : HR320/28XJA

Manufacture 2 :

Manufacturer Number 2 :

M.S.R.P 04/2010 :

Description: WHEEL BEARING

Application 1 :

Application 2 :

Application 3 :

Application 4 :

Application 5 :

Application 6 :

Application 7 :

Application 8 :

Application 9 :

Application 10 :

Application 11 :

Application 12 :

ZOOM+ ZOOM-



PARTS IMAGE



BOX IMAGE

WB-0503

WHEEL BEARING

Parts Number : WB-0503

Manufacture 1 : NTN

Manufacturer Number 1 : ET-CR1-0678LLCS7

Manufacture 2 :

Manufacture Number 2 :

M.S.R.P 04/2010 :

Description: WHEEL BEARING

Application 1 :

Application 2 :

Application 3 :

Application 4 :

Application 5 :

Application 6 :

Application 7 :

Application 8 :

Application 9 :

Application 10 :

Application 11 :

Application 12 :

ZOOM+

ZOOM-

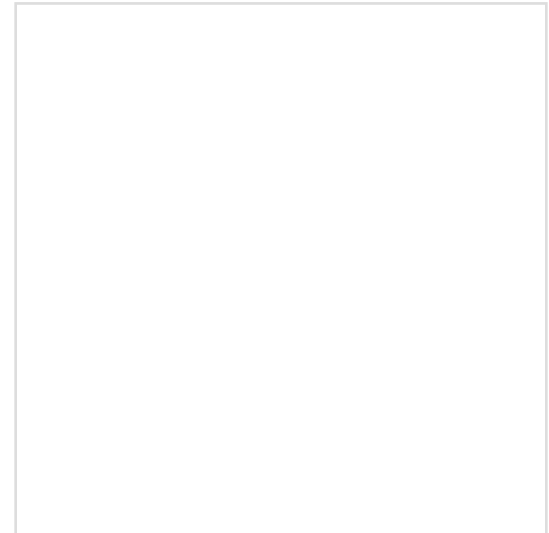

PARTS IMAGE

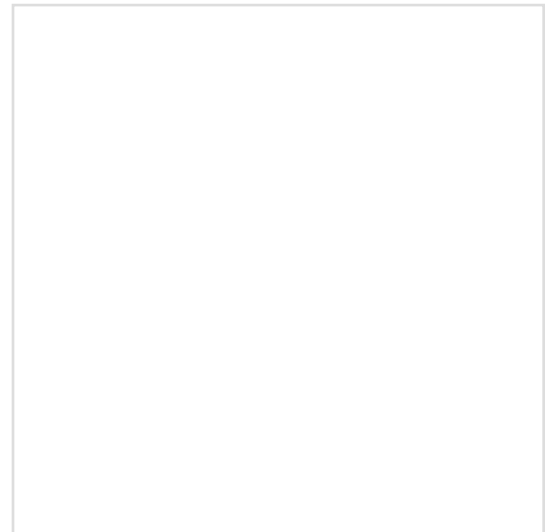

BOX IMAGE

WB-0504

WHEEL BEARING

Parts Number : WB-0504

Manufacture 1 : NTN

Manufacturer Number 1 : 4TCR10868LLCS150/5C

Manufacture 2 :

Manufacture Number 2 :

M.S.R.P 04/2010 :

Description: WHEEL BEARING

Application 1 :

Application 2 :

Application 3 :

Application 4 :

Application 5 :

Application 6 :

Application 7 :

Application 8 :

Application 9 :

Application 10 :

Application 11 :

Application 12 :

ZOOM+

ZOOM-



PARTS IMAGE

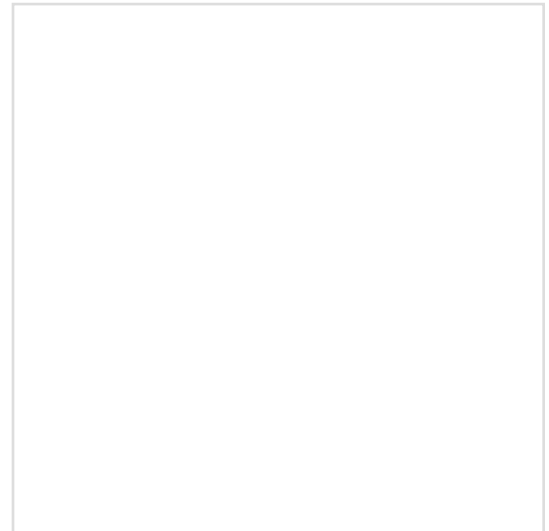

BOX IMAGE

WB-0505

WHEEL BEARING

Parts Number : WB-0505

Manufacture 1 : NSK

Manufacturer Number 1 : 6206VV

Manufacture 2 :

Manufacture Number 2 :

M.S.R.P 04/2010 :

Description: WHEEL BEARING

Application 1 :

Application 2 :

Application 3 :

Application 4 :

Application 5 :

Application 6 :

Application 7 :

Application 8 :

Application 9 :

Application 10 :

Application 11 :

Application 12 :

ZOOM+ ZOOM-



PARTS IMAGE



BOX IMAGE

WB-0506

WHEEL BEARING

Parts Number : WB-0506

Manufacture 1 : NSK

Manufacturer Number 1 : 40BWD06ACA109

Manufacture 2 :

Manufacturer Number 2 :

M.S.R.P 04/2010 :

Description: WHEEL BEARING

Application 1 :

Application 2 :

Application 3 :

Application 4 :

Application 5 :

Application 6 :

Application 7 :

Application 8 :

Application 9 :

Application 10 :

Application 11 :

Application 12 :

ZOOM+

ZOOM-



PARTS IMAGE



BOX IMAGE

WB-0507

WHEEL BEARING

Parts Number : WB-0507

Manufacture 1 : NSK

Manufacturer Number 1 : 38BWD10BCA41

Manufacture 2 :

Manufacturer Number 2 :

M.S.R.P 04/2010 :

Description: WHEEL BEARING

Application 1 :

Application 2 :

Application 3 :

Application 4 :

Application 5 :

Application 6 :

Application 7 :

Application 8 :

Application 9 :

Application 10 :

Application 11 :

Application 12 :

ZOOM+ ZOOM-



PARTS IMAGE



BOX IMAGE

WB-0508

WHEEL BEARING

Parts Number : WB-0508

Manufacture 1 : NSK

Manufacturer Number 1 : EP36BWK02B1Y2CAA01

Manufacture 2 :

Manufacturer Number 2 :

M.S.R.P 04/2010 :

Description: WHEEL BEARING

Application 1 :

Application 2 :

Application 3 :

Application 4 :

Application 5 :

Application 6 :

Application 7 :

Application 8 :

Application 9 :

Application 10 :

Application 11 :

Application 12 :

ZOOM+

ZOOM-



PARTS IMAGE



BOX IMAGE

WB-0509

WHEEL BEARING

Parts Number : WB-0509

Manufacture 1 : KOYO

Manufacturer Number 1 : DAC4280W-2CS40FGPZGA

Manufacture 2 :

Manufacture Number 2 :

M.S.R.P 04/2010 :

Description: WHEEL BEARING

Application 1 :

Application 2 :

Application 3 :

Application 4 :

Application 5 :

Application 6 :

Application 7 :

Application 8 :

Application 9 :

Application 10 :

Application 11 :

Application 12 :

ZOOM+

ZOOM-

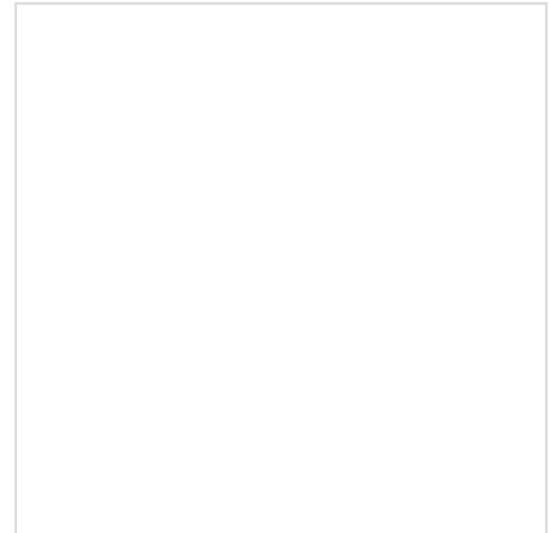

PARTS IMAGE

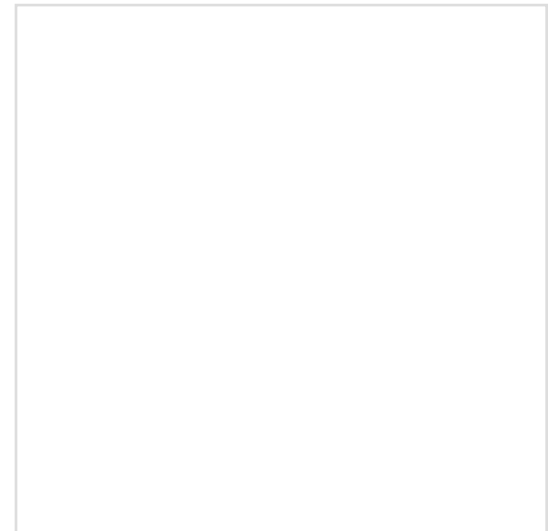

BOX IMAGE

WB-0510

WHEEL BEARING

Parts Number : WB-0510

Manufacture 1 : NTN

Manufacturer Number 1 : DEO8A27LLCS56PX1/5C

Manufacture 2 :

Manufacture Number 2 :

M.S.R.P 04/2010 :

Description: WHEEL BEARING

Application 1 :

Application 2 :

Application 3 :

Application 4 :

Application 5 :

Application 6 :

Application 7 :

Application 8 :

Application 9 :

Application 10 :

Application 11 :

Application 12 :

ZOOM+

ZOOM-



PARTS IMAGE

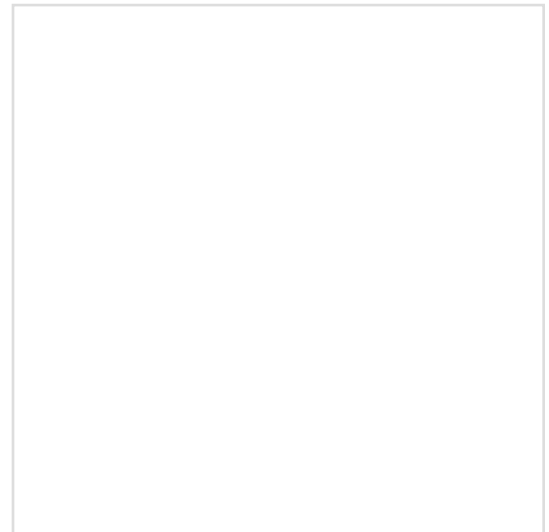

BOX IMAGE

WB-0511

WHEEL BEARING

Parts Number : WB-0511

Manufacture 1 : NTN

Manufacturer Number 1 : HUB053-50

Manufacture 2 :

Manufacturer Number 2 :

M.S.R.P 04/2010 :

Description: WHEEL BEARING

Application 1 :

Application 2 :

Application 3 :

Application 4 :

Application 5 :

Application 6 :

Application 7 :

Application 8 :

Application 9 :

Application 10 :

Application 11 :

Application 12 :

ZOOM+

ZOOM-

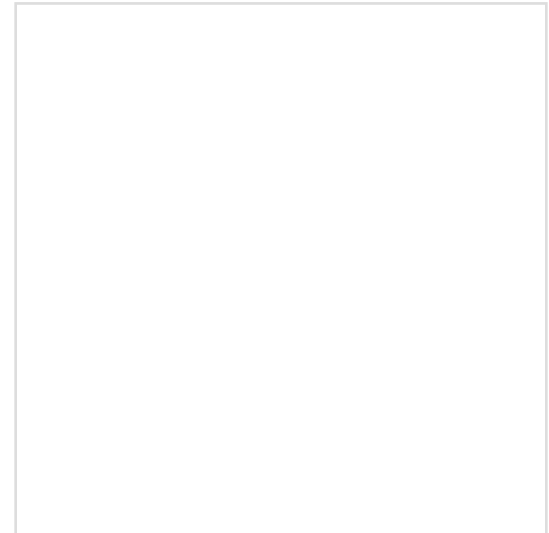

PARTS IMAGE

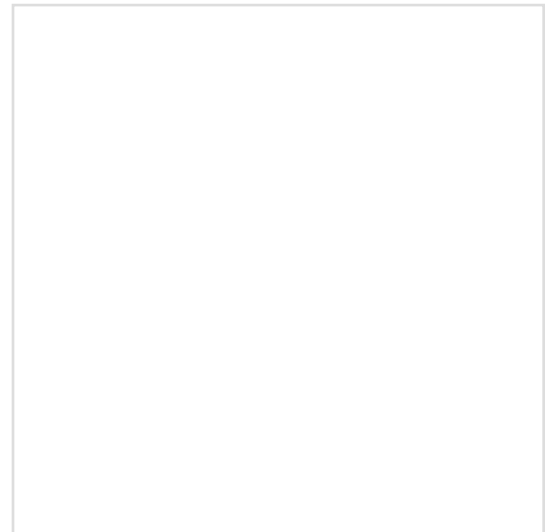

BOX IMAGE

WB-0513

WHEEL BEARING

Parts Number : WB-0513

Manufacture 1 : NSK

Manufacturer Number 1 : EP36BWK02M-Y-2CA1-01

Manufacture 2 :

Manufacture Number 2 :

M.S.R.P 04/2010 :

Description: WHEEL BEARING

Application 1 :

Application 2 :

Application 3 :

Application 4 :

Application 5 :

Application 6 :

Application 7 :

Application 8 :

Application 9 :

Application 10 :

Application 11 :

Application 12 :

ZOOM+

ZOOM-



PARTS IMAGE

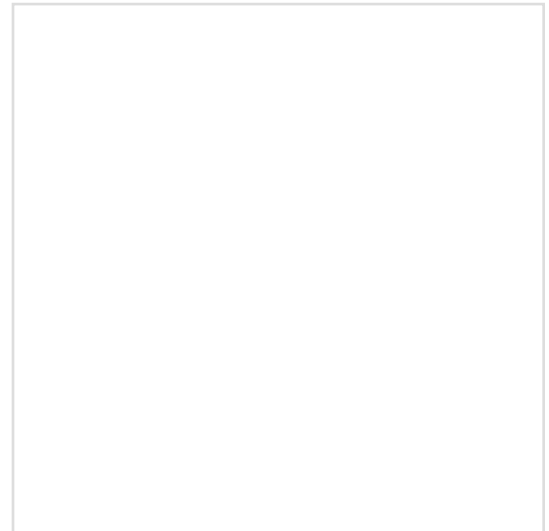

BOX IMAGE

WB-0514

WHEEL BEARING

Parts Number : WB-0514

Manufacture 1 : NTN

Manufacturer Number 1 : 4T-CR1-0822LLCS1#03

Manufacture 2 :

Manufacturer Number 2 :

M.S.R.P 04/2010 :

Description: WHEEL BEARING

Application 1 :

Application 2 :

Application 3 :

Application 4 :

Application 5 :

Application 6 :

Application 7 :

Application 8 :

Application 9 :

Application 10 :

Application 11 :

Application 12 :

ZOOM+

ZOOM-



PARTS IMAGE



BOX IMAGE

WB-0516

WHEEL BEARING

Parts Number : WB-0516

Manufacture 1 : NACHI

Manufacturer Number 1 : 6307-2NSL

Manufacture 2 :

Manufacturer Number 2 :

M.S.R.P 04/2010 :

Description: WHEEL BEARING

Application 1 :

Application 2 :

Application 3 :

Application 4 :

Application 5 :

Application 6 :

Application 7 :

Application 8 :

Application 9 :

Application 10 :

Application 11 :

Application 12 :

ZOOM+

ZOOM-



PARTS IMAGE



BOX IMAGE

WB-0517

WHEEL BEARING

Parts Number :	WB-0517
Manufacture 1 :	NTN <input type="button" value="v"/>
Manufacturer Number 1 :	HUB055-27
Manufacture 2 :	NACHI <input type="button" value="v"/>
Manufacture Number 2 :	F28BVV10-M3
M.S.R.P 04/2010 :	
Description:	WHEEL BEARING

ZOOM+ ZOOM-



PARTS IMAGE

- Application 1 :
- Application 2 :
- Application 3 :
- Application 4 :
- Application 5 :
- Application 6 :
- Application 7 :
- Application 8 :
- Application 9 :
- Application 10 :
- Application 11 :
- Application 12 :



BOX IMAGE

WB-0520

WHEEL BEARING

Parts Number : WB-0520

Manufacture 1 : KOYO

Manufacturer Number 1 : DAC4583CS62

Manufacture 2 :

Manufacture Number 2 :

M.S.R.P 04/2010 :

Description: WHEEL BEARING

Application 1 :

Application 2 :

Application 3 :

Application 4 :

Application 5 :

Application 6 :

Application 7 :

Application 8 :

Application 9 :

Application 10 :

Application 11 :

Application 12 :

ZOOM+

ZOOM-



PARTS IMAGE

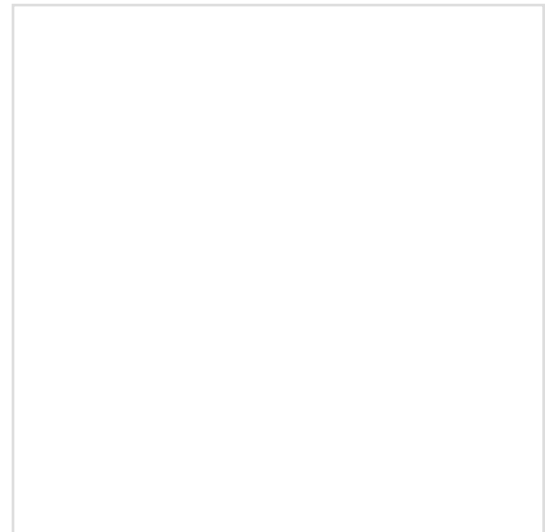

BOX IMAGE

WB-0601

WHEEL BEARING

Parts Number : WB-0601

Manufacture 1 : NSK

Manufacturer Number 1 : 34BWD04BCA70

Manufacture 2 :

Manufacturer Number 2 :

M.S.R.P 04/2010 :

Description: WHEEL BEARING

Application 1 :

Application 2 :

Application 3 :

Application 4 :

Application 5 :

Application 6 :

Application 7 :

Application 8 :

Application 9 :

Application 10 :

Application 11 :

Application 12 :

ZOOM+

ZOOM-



PARTS IMAGE



BOX IMAGE

WB-0602

WHEEL BEARING

Parts Number : WB-0602

Manufacture 1 : KOYO

Manufacturer Number 1 : DAC3468RSCS53

Manufacture 2 : NSK

Manufacturer Number 2 : 34BWD09ACA75

M.S.R.P 04/2010 :

Description: WHEEL BEARING

Application 1 :

Application 2 :

Application 3 :

Application 4 :

Application 5 :

Application 6 :

Application 7 :

Application 8 :

Application 9 :

Application 10 :

Application 11 :

Application 12 :

ZOOM+

ZOOM-

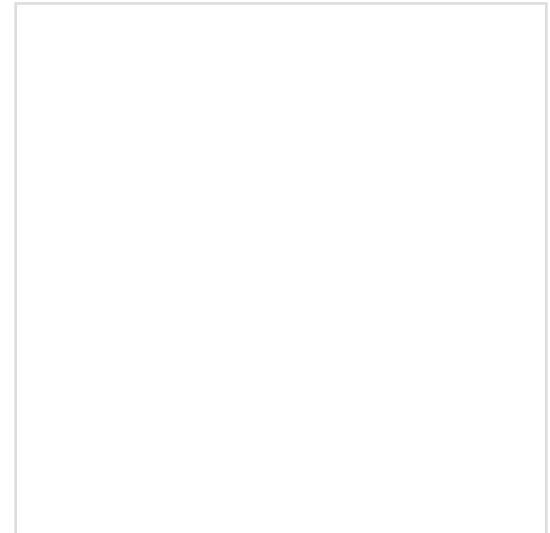

PARTS IMAGE

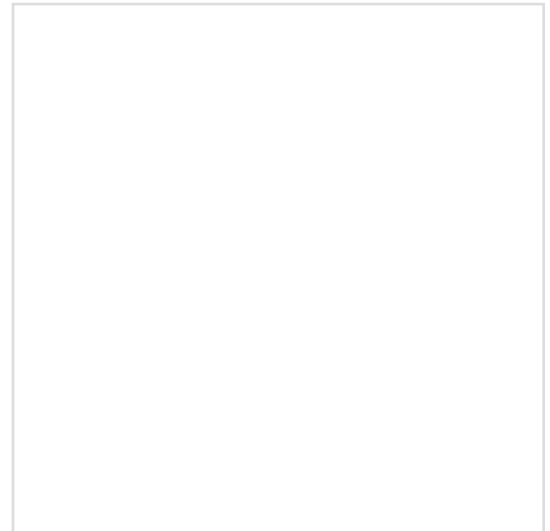

BOX IMAGE

WB-0603

WHEEL BEARING

Parts Number : WB-0603

Manufacture 1 : NSK

Manufacturer Number 1 : 38KWD02G3CA126

Manufacture 2 :

Manufacture Number 2 :

M.S.R.P 04/2010 :

Description: WHEEL BEARING

Application 1 :

Application 2 :

Application 3 :

Application 4 :

Application 5 :

Application 6 :

Application 7 :

Application 8 :

Application 9 :

Application 10 :

Application 11 :

Application 12 :

ZOOM+

ZOOM-

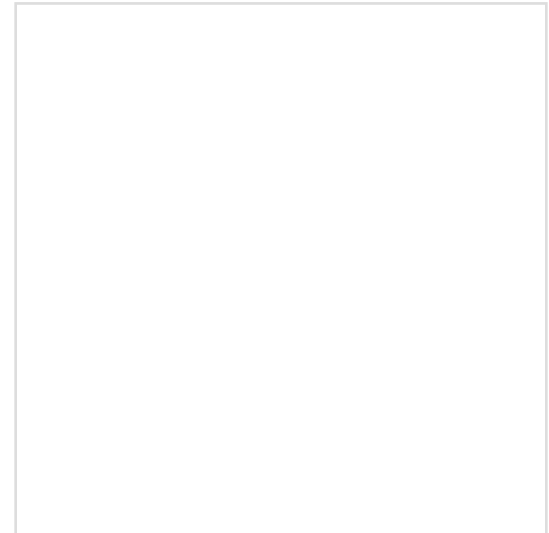

PARTS IMAGE

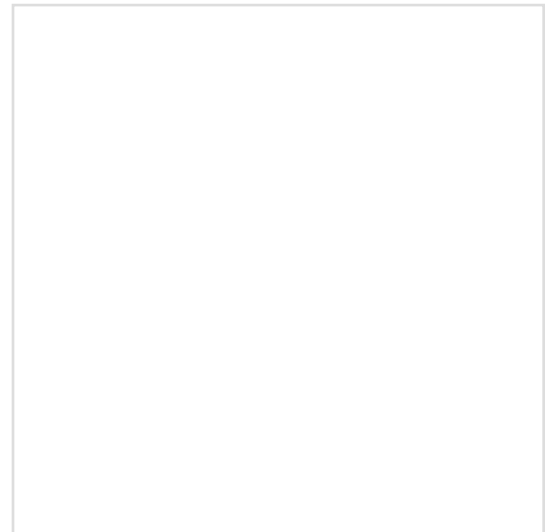

BOX IMAGE

WB-0604

WHEEL BEARING

Parts Number : WB-0604

Manufacture 1 : NSK

Manufacturer Number 1 : 38KWD01G3CA104

Manufacture 2 :

Manufacture Number 2 :

M.S.R.P 04/2010 :

Description: WHEEL BEARING

Application 1 :

Application 2 :

Application 3 :

Application 4 :

Application 5 :

Application 6 :

Application 7 :

Application 8 :

Application 9 :

Application 10 :

Application 11 :

Application 12 :

ZOOM+

ZOOM-



PARTS IMAGE

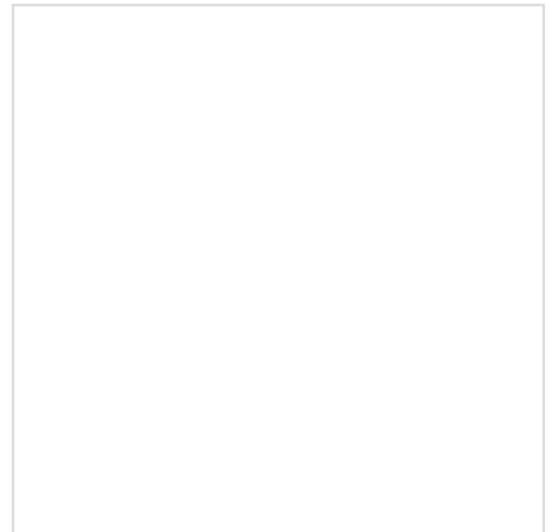

BOX IMAGE

WB-0605

WHEEL BEARING

Parts Number : WB-0605

Manufacture 1 : NSK

Manufacturer Number 1 : B35-80AC4

Manufacture 2 :

Manufacturer Number 2 :

M.S.R.P 04/2010 :

Description: WHEEL BEARING

Application 1 :

Application 2 :

Application 3 :

Application 4 :

Application 5 :

Application 6 :

Application 7 :

Application 8 :

Application 9 :

Application 10 :

Application 11 :

Application 12 :

ZOOM+

ZOOM-



PARTS IMAGE

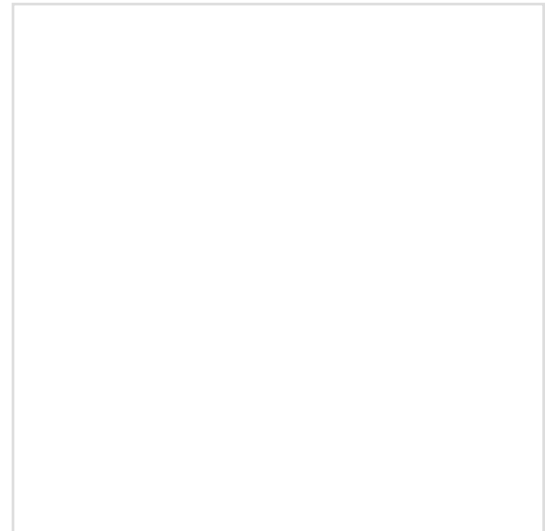

BOX IMAGE

WB-0606

WHEEL BEARING

Parts Number : WB-0606

Manufacture 1 : NSK

Manufacturer Number 1 : 40BW03CG32

Manufacture 2 :

Manufacture Number 2 :

M.S.R.P 04/2010 :

Description: WHEEL BEARING

Application 1 :

Application 2 :

Application 3 :

Application 4 :

Application 5 :

Application 6 :

Application 7 :

Application 8 :

Application 9 :

Application 10 :

Application 11 :

Application 12 :

ZOOM+

ZOOM-



PARTS IMAGE

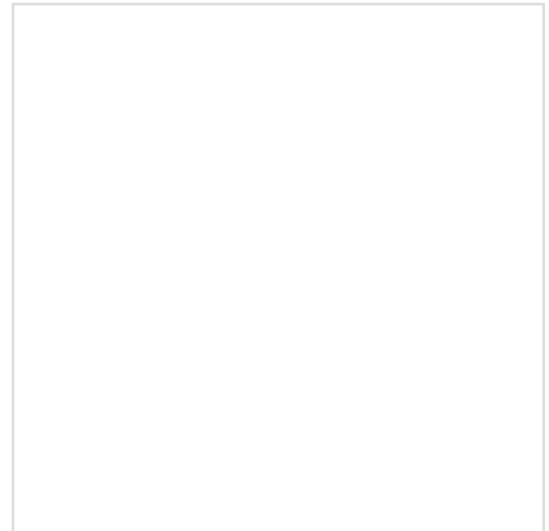

BOX IMAGE

WB-0608

WHEEL BEARING

Parts Number : WB-0608

Manufacture 1 :

Manufacturer Number 1 : 427

Manufacture 2 :

Manufacture Number 2 :

M.S.R.P 04/2010 :

Description: WHEEL BEARING

Application 1 :

Application 2 :

Application 3 :

Application 4 :

Application 5 :

Application 6 :

Application 7 :

Application 8 :

Application 9 :

Application 10 :

Application 11 :

Application 12 :

ZOOM+

ZOOM-

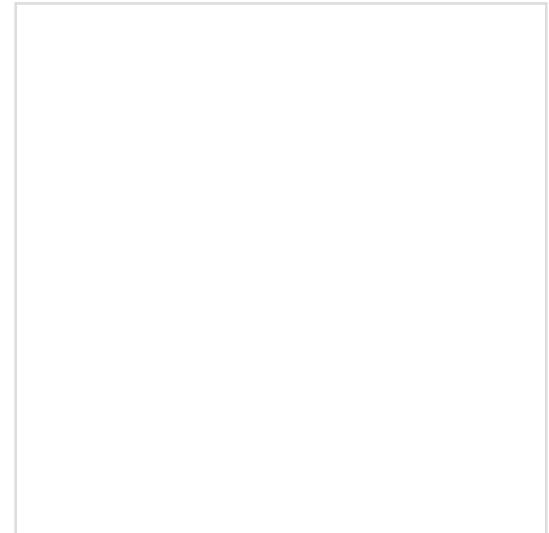

PARTS IMAGE

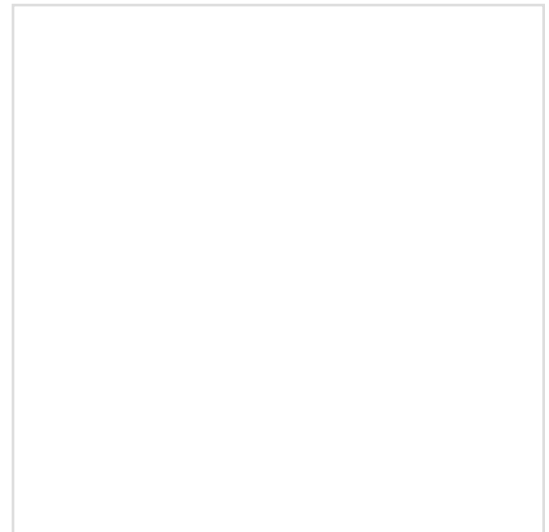

BOX IMAGE

WB-0609

WHEEL BEARING

Parts Number : WB-0609

Manufacture 1 :

Manufacturer Number 1 : 428

Manufacture 2 :

Manufacturer Number 2 :

M.S.R.P 04/2010 :

Description: WHEEL BEARING

Application 1 :

Application 2 :

Application 3 :

Application 4 :

Application 5 :

Application 6 :

Application 7 :

Application 8 :

Application 9 :

Application 10 :

Application 11 :

Application 12 :

ZOOM+

ZOOM-



PARTS IMAGE

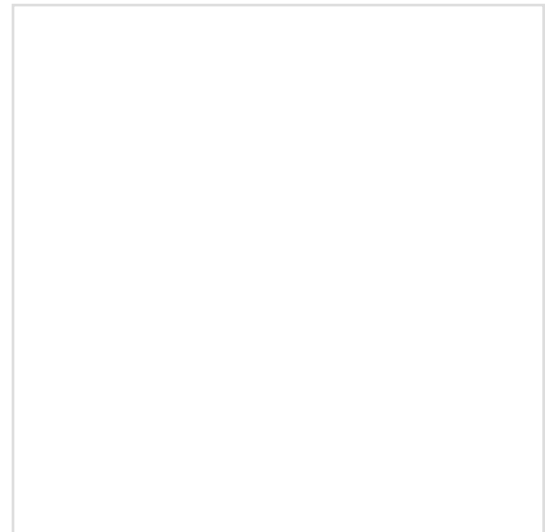

BOX IMAGE

WB-0610

WHEEL BEARING

Parts Number :	WB-0610
Manufacture 1 :	NSK <input type="button" value="v"/>
Manufacturer Number 1 :	HR32008XJ
Manufacture 2 :	<input type="button" value="v"/>
Manufacturer Number 2 :	
M.S.R.P 04/2010 :	
Description:	WHEEL BEARING

- Application 1 :
- Application 2 :
- Application 3 :
- Application 4 :
- Application 5 :
- Application 6 :
- Application 7 :
- Application 8 :
- Application 9 :
- Application 10 :
- Application 11 :
- Application 12 :

ZOOM+ ZOOM-



PARTS IMAGE



BOX IMAGE

WB-0701

WHEEL BEARING

Parts Number :	WB-0701
Manufacture 1 :	NSK <input type="button" value="v"/>
Manufacturer Number 1 :	HR32007XJ
Manufacture 2 :	<input type="button" value="v"/>
Manufacturer Number 2 :	
M.S.R.P 04/2010 :	
Description:	WHEEL BEARING

- Application 1 :
- Application 2 :
- Application 3 :
- Application 4 :
- Application 5 :
- Application 6 :
- Application 7 :
- Application 8 :
- Application 9 :
- Application 10 :
- Application 11 :
- Application 12 :

ZOOM+ ZOOM-



PARTS IMAGE



BOX IMAGE

WB-0702

WHEEL BEARING

Parts Number :	WB-0702
Manufacture 1 :	KOYO <input type="button" value="v"/>
Manufacturer Number 1 :	DG35821WYAC4
Manufacture 2 :	<input type="button" value="v"/>
Manufacturer Number 2 :	
M.S.R.P 04/2010 :	
Description:	WHEEL BEARING

- Application 1 :
- Application 2 :
- Application 3 :
- Application 4 :
- Application 5 :
- Application 6 :
- Application 7 :
- Application 8 :
- Application 9 :
- Application 10 :
- Application 11 :
- Application 12 :

ZOOM+ ZOOM-



PARTS IMAGE



BOX IMAGE

WB-0703

WHEEL BEARING

Parts Number : WB-0703

Manufacture 1 : NSK

Manufacturer Number 1 : W8BKW06D1Y2CA33

Manufacture 2 :

Manufacture Number 2 :

M.S.R.P 04/2010 :

Description: WHEEL BEARING

Application 1 :

Application 2 :

Application 3 :

Application 4 :

Application 5 :

Application 6 :

Application 7 :

Application 8 :

Application 9 :

Application 10 :

Application 11 :

Application 12 :

ZOOM+

ZOOM-



PARTS IMAGE

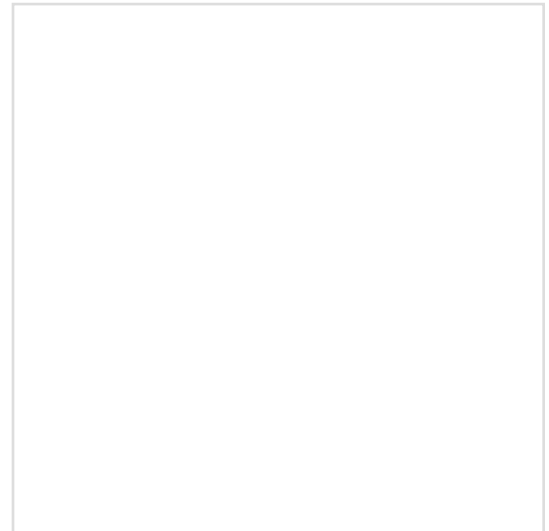

BOX IMAGE

WB-0801

WHEEL BEARING

Parts Number : WB-0801

Manufacture 1 : NSK

Manufacturer Number 1 : 41KWD01G3CA54

Manufacture 2 :

Manufacturer Number 2 :

M.S.R.P 04/2010 :

Description: WHEEL BEARING

Application 1 :

Application 2 :

Application 3 :

Application 4 :

Application 5 :

Application 6 :

Application 7 :

Application 8 :

Application 9 :

Application 10 :

Application 11 :

Application 12 :

ZOOM+

ZOOM-



PARTS IMAGE

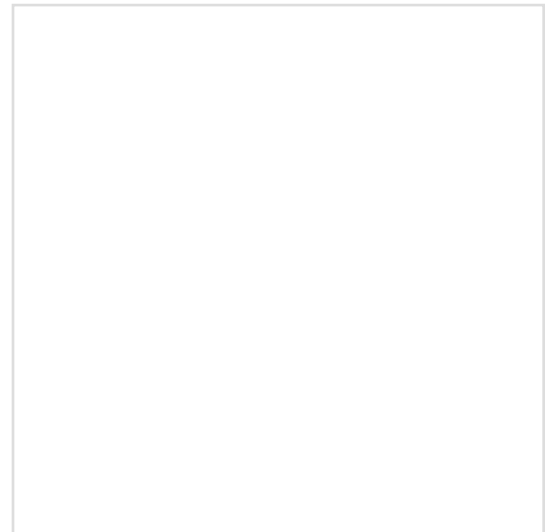

BOX IMAGE

WB-0803

WHEEL BEARING

Parts Number :	WB-0803
Manufacture 1 :	KOYO <input type="button" value="v"/>
Manufacturer Number 1 :	57414/LM300811
Manufacture 2 :	<input type="button" value="v"/>
Manufacturer Number 2 :	
M.S.R.P 04/2010 :	
Description:	WHEEL BEARING

- Application 1 :
- Application 2 :
- Application 3 :
- Application 4 :
- Application 5 :
- Application 6 :
- Application 7 :
- Application 8 :
- Application 9 :
- Application 10 :
- Application 11 :
- Application 12 :

ZOOM+ ZOOM-



PARTS IMAGE



BOX IMAGE

WB-0804

WHEEL BEARING

Parts Number : WB-0804

Manufacture 1 : NACHI

Manufacturer Number 1 : 6204NSLC3

Manufacture 2 :

Manufacture Number 2 :

M.S.R.P 04/2010 :

Description: WHEEL BEARING

Application 1 :

Application 2 :

Application 3 :

Application 4 :

Application 5 :

Application 6 :

Application 7 :

Application 8 :

Application 9 :

Application 10 :

Application 11 :

Application 12 :

ZOOM+

ZOOM-

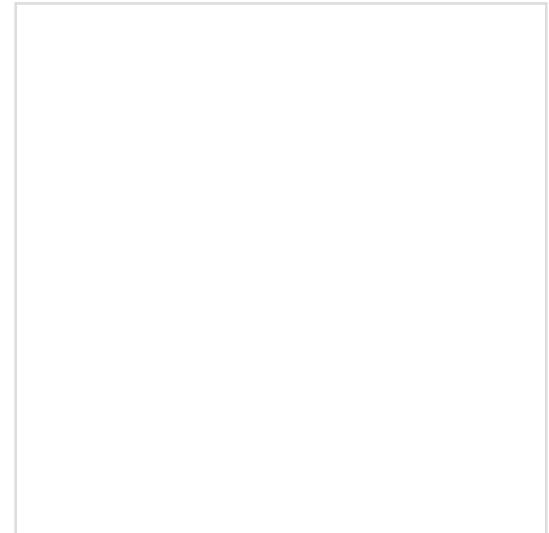

PARTS IMAGE

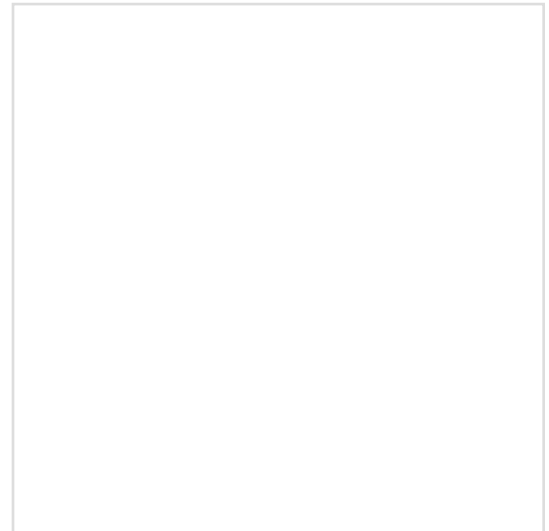

BOX IMAGE

WB-0807

WHEEL BEARING

Parts Number : WB-0807

Manufacture 1 : KOYO

Manufacturer Number 1 : DAC407ZCS34

Manufacture 2 :

Manufacturer Number 2 :

M.S.R.P 04/2010 :

Description: WHEEL BEARING

Application 1 :

Application 2 :

Application 3 :

Application 4 :

Application 5 :

Application 6 :

Application 7 :

Application 8 :

Application 9 :

Application 10 :

Application 11 :

Application 12 :

ZOOM+

ZOOM-



PARTS IMAGE



BOX IMAGE

WB-0902

WHEEL BEARING

Parts Number :	WB-0902
Manufacture 1 :	NSK <input type="button" value="v"/>
Manufacturer Number 1 :	45KWB03G3CA122
Manufacture 2 :	<input type="button" value="v"/>
Manufacturer Number 2 :	
M.S.R.P 04/2010 :	
Description:	WHEEL BEARING

- Application 1 :
- Application 2 :
- Application 3 :
- Application 4 :
- Application 5 :
- Application 6 :
- Application 7 :
- Application 8 :
- Application 9 :
- Application 10 :
- Application 11 :
- Application 12 :

ZOOM+ ZOOM-



PARTS IMAGE



BOX IMAGE

WB-0903

WHEEL BEARING

Parts Number : WB-0903

Manufacture 1 : NTN

Manufacturer Number 1 : 6305C3

Manufacture 2 :

Manufacture Number 2 :

M.S.R.P 04/2010 :

Description: WHEEL BEARING

Application 1 :

Application 2 :

Application 3 :

Application 4 :

Application 5 :

Application 6 :

Application 7 :

Application 8 :

Application 9 :

Application 10 :

Application 11 :

Application 12 :

ZOOM+

ZOOM-



PARTS IMAGE

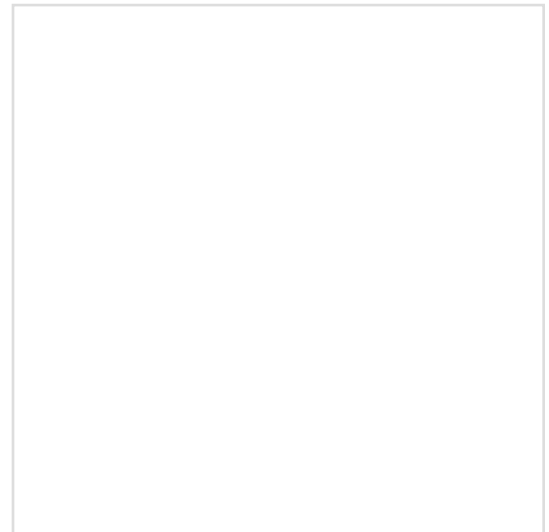

BOX IMAGE

WB-0904

WHEEL BEARING

Parts Number : WB-0904

Manufacture 1 : KOYO

Manufacturer Number 1 : DACF1049AC10

Manufacture 2 :

Manufacturer Number 2 :

M.S.R.P 04/2010 :

Description: WHEEL BEARING

Application 1 :

Application 2 :

Application 3 :

Application 4 :

Application 5 :

Application 6 :

Application 7 :

Application 8 :

Application 9 :

Application 10 :

Application 11 :

Application 12 :

ZOOM+

ZOOM-

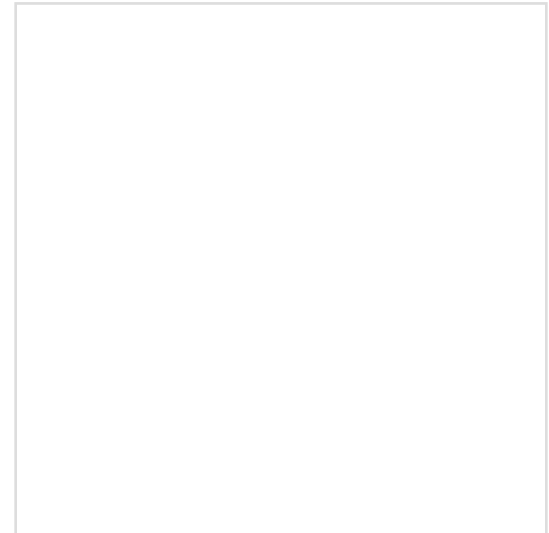

PARTS IMAGE

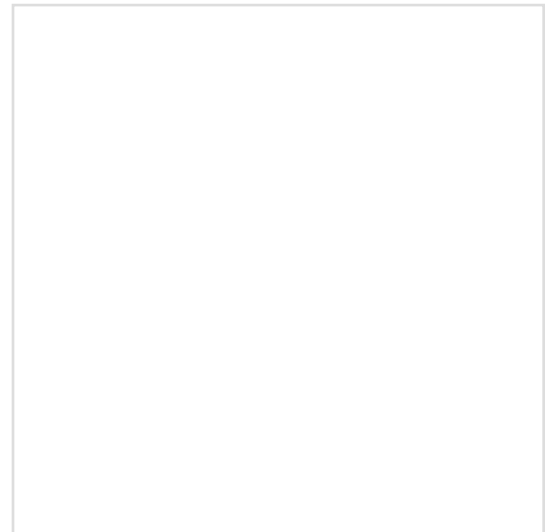

BOX IMAGE

WB-0905

WHEEL BEARING

Parts Number :	WB-0905
Manufacture 1 :	NTN <input type="button" value="v"/>
Manufacturer Number 1 :	4T-CR1-08AD2CS96/01
Manufacture 2 :	<input type="button" value="v"/>
Manufacturer Number 2 :	
M.S.R.P 04/2010 :	
Description:	WHEEL BEARING

- Application 1 :
- Application 2 :
- Application 3 :
- Application 4 :
- Application 5 :
- Application 6 :
- Application 7 :
- Application 8 :
- Application 9 :
- Application 10 :
- Application 11 :
- Application 12 :

ZOOM+ ZOOM-



PARTS IMAGE



BOX IMAGE

WB-0906

WHEEL BEARING

Parts Number : WB-0906

Manufacture 1 : NTN

Manufacturer Number 1 : TMB206CCS

Manufacture 2 :

Manufacturer Number 2 :

M.S.R.P 04/2010 :

Description: WHEEL BEARING

Application 1 :

Application 2 :

Application 3 :

Application 4 :

Application 5 :

Application 6 :

Application 7 :

Application 8 :

Application 9 :

Application 10 :

Application 11 :

Application 12 :

ZOOM+

ZOOM-



PARTS IMAGE

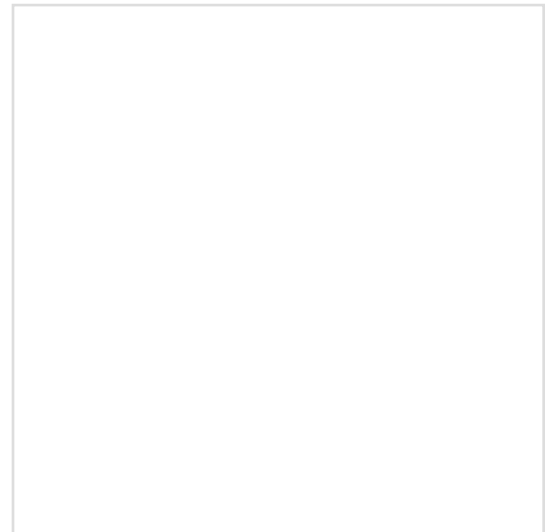

BOX IMAGE

WB-0907

WHEEL BEARING MADE IN

Parts Number : WB-0907

Manufacture 1 : NTN

Manufacturer Number 1 : AU0827-4/L588

Manufacture 2 :

Manufacturer Number 2 :

M.S.R.P 04/2010 :

Description: WHEEL BEARING MADE IN JAPAN

Application 1 :

Application 2 :

Application 3 :

Application 4 :

Application 5 :

Application 6 :

Application 7 :

Application 8 :

Application 9 :

Application 10 :

Application 11 :

Application 12 :

ZOOM+ ZOOM-



PARTS IMAGE



BOX IMAGE

WB-0910

WHEEL BEARING

Parts Number : WB-0910

Manufacture 1 :

Manufacturer Number 1 :

568

Manufacture 2 :

Manufacture Number 2 :

M.S.R.P 04/2010 :

Description:

WHEEL BEARING

Application 1 :

Application 2 :

Application 3 :

Application 4 :

Application 5 :

Application 6 :

Application 7 :

Application 8 :

Application 9 :

Application 10 :

Application 11 :

Application 12 :

ZOOM+

ZOOM-

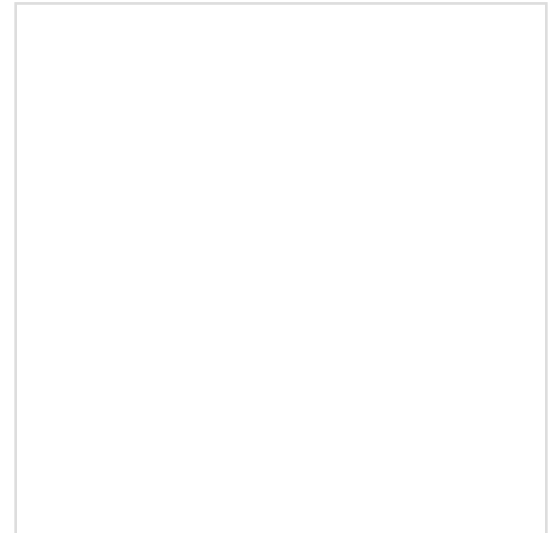

PARTS IMAGE

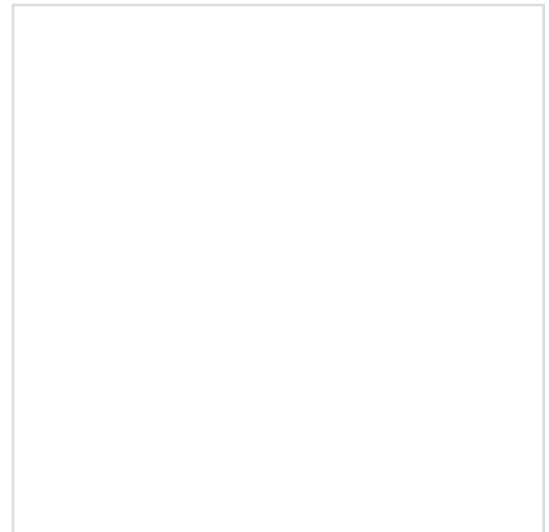

BOX IMAGE

WB-0913

WHEEL BEARING

Parts Number : WB-0913

Manufacture 1 :

Manufacturer Number 1 :

576

Manufacture 2 :

Manufacture Number 2 :

M.S.R.P 04/2010 :

Description:

WHEEL BEARING

Application 1 :

Application 2 :

Application 3 :

Application 4 :

Application 5 :

Application 6 :

Application 7 :

Application 8 :

Application 9 :

Application 10 :

Application 11 :

Application 12 :

ZOOM+

ZOOM-

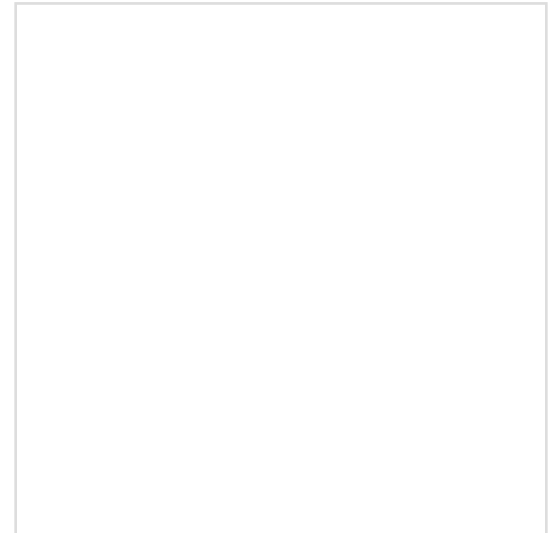

PARTS IMAGE

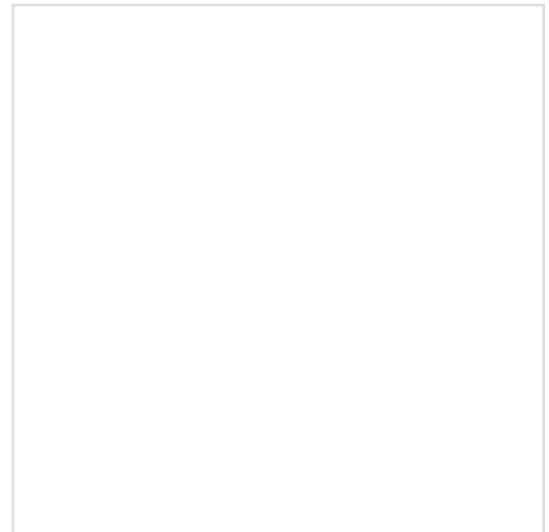

BOX IMAGE

WB-1001

WHEEL BEARING

Parts Number : WB-1001

Manufacture 1 : NTN

Manufacturer Number 1 : 4T-LM29748/LM29710

Manufacture 2 :

Manufacturer Number 2 :

M.S.R.P 04/2010 :

Description: WHEEL BEARING

Application 1 :

Application 2 :

Application 3 :

Application 4 :

Application 5 :

Application 6 :

Application 7 :

Application 8 :

Application 9 :

Application 10 :

Application 11 :

Application 12 :

ZOOM+

ZOOM-



PARTS IMAGE



BOX IMAGE

WB-1001A

WHEEL BEARING

Parts Number : WB-1001A

Manufacture 1 : KOREA

Manufacturer Number 1 : KM29748/LM2971

Manufacture 2 :

Manufacturer Number 2 :

M.S.R.P 04/2010 :

Description: WHEEL BEARING

Application 1 :

Application 2 :

Application 3 :

Application 4 :

Application 5 :

Application 6 :

Application 7 :

Application 8 :

Application 9 :

Application 10 :

Application 11 :

Application 12 :

ZOOM+

ZOOM-



PARTS IMAGE



BOX IMAGE

WB-1002

WHEEL BEARING

Parts Number :	WB-1002
Manufacture 1 :	KOYO <input type="button" value="v"/>
Manufacturer Number 1 :	LM48548/10
Manufacture 2 :	<input type="button" value="v"/>
Manufacturer Number 2 :	
M.S.R.P 04/2010 :	
Description:	WHEEL BEARING

- Application 1 :
- Application 2 :
- Application 3 :
- Application 4 :
- Application 5 :
- Application 6 :
- Application 7 :
- Application 8 :
- Application 9 :
- Application 10 :
- Application 11 :
- Application 12 :

ZOOM+ ZOOM-



PARTS IMAGE



BOX IMAGE

WB-1003

WHEEL BEARING

Parts Number : WB-1003

Manufacture 1 : KOYO

Manufacturer Number 1 : M12649/10

Manufacture 2 :

Manufacturer Number 2 :

M.S.R.P 04/2010 :

Description: WHEEL BEARING

Application 1 :

Application 2 :

Application 3 :

Application 4 :

Application 5 :

Application 6 :

Application 7 :

Application 8 :

Application 9 :

Application 10 :

Application 11 :

Application 12 :

ZOOM+ ZOOM-



PARTS IMAGE



BOX IMAGE

WB-1004

WHEEL BEARING

Parts Number : WB-1004

Manufacture 1 : KOYO

Manufacturer Number 1 : JL69349/10

Manufacture 2 :

Manufacture Number 2 :

M.S.R.P 04/2010 :

Description: WHEEL BEARING

Application 1 :

Application 2 :

Application 3 :

Application 4 :

Application 5 :

Application 6 :

Application 7 :

Application 8 :

Application 9 :

Application 10 :

Application 11 :

Application 12 :

ZOOM+

ZOOM-

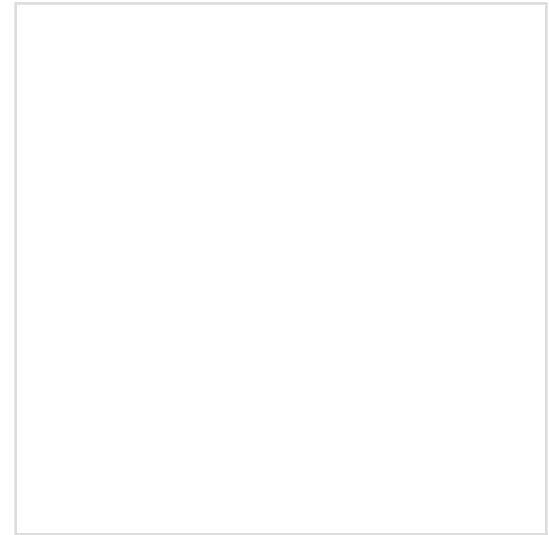

PARTS IMAGE

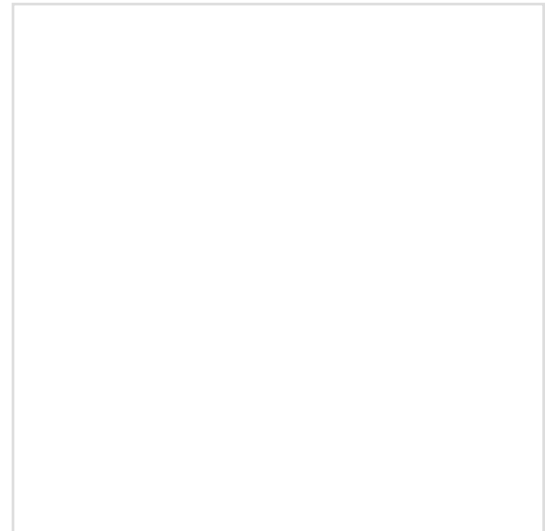

BOX IMAGE

WB-1005

WHEEL BEARING

Parts Number : WB-1005

Manufacture 1 : NSK

Manufacturer Number 1 : HR32005XJA

Manufacture 2 :

Manufacture Number 2 :

M.S.R.P 04/2010 :

Description: WHEEL BEARING

Application 1 :

Application 2 :

Application 3 :

Application 4 :

Application 5 :

Application 6 :

Application 7 :

Application 8 :

Application 9 :

Application 10 :

Application 11 :

Application 12 :

ZOOM+

ZOOM-



PARTS IMAGE

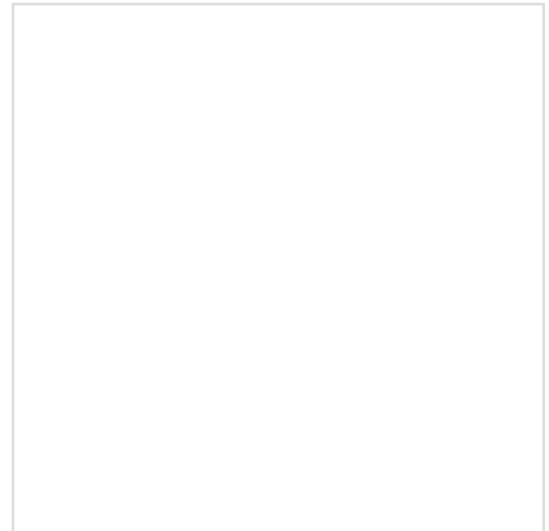

BOX IMAGE

WB-1006

WHEEL BEARING

Parts Number : WB-1006

Manufacture 1 : NSK

Manufacturer Number 1 : HR30204J

Manufacture 2 :

Manufacture Number 2 :

M.S.R.P 04/2010 :

Description: WHEEL BEARING

Application 1 :

Application 2 :

Application 3 :

Application 4 :

Application 5 :

Application 6 :

Application 7 :

Application 8 :

Application 9 :

Application 10 :

Application 11 :

Application 12 :

ZOOM+

ZOOM-



PARTS IMAGE



BOX IMAGE

WB-1007

WHEEL BEARING

Parts Number : WB-1007

Manufacture 1 : NSK

Manufacturer Number 1 : HR30208J

Manufacture 2 :

Manufacturer Number 2 :

M.S.R.P 04/2010 :

Description: WHEEL BEARING

Application 1 :

Application 2 :

Application 3 :

Application 4 :

Application 5 :

Application 6 :

Application 7 :

Application 8 :

Application 9 :

Application 10 :

Application 11 :

Application 12 :

ZOOM+

ZOOM-



PARTS IMAGE

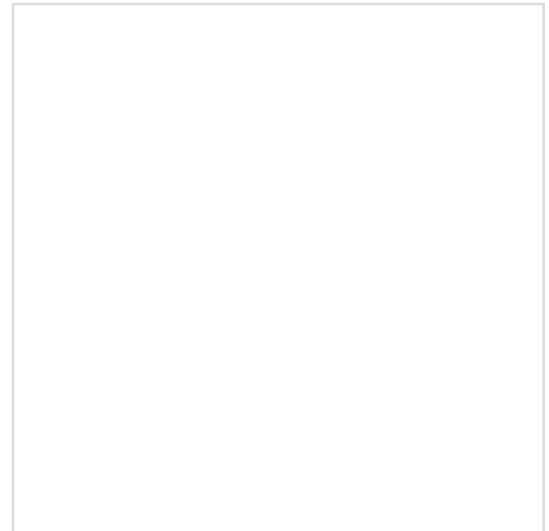

BOX IMAGE

WB-1008

WHEEL BEARING

Parts Number : WB-1008

Manufacture 1 : KOYO

Manufacturer Number 1 : LM67048/10

Manufacture 2 :

Manufacture Number 2 :

M.S.R.P 04/2010 :

Description: WHEEL BEARING

Application 1 :

Application 2 :

Application 3 :

Application 4 :

Application 5 :

Application 6 :

Application 7 :

Application 8 :

Application 9 :

Application 10 :

Application 11 :

Application 12 :

ZOOM+

ZOOM-

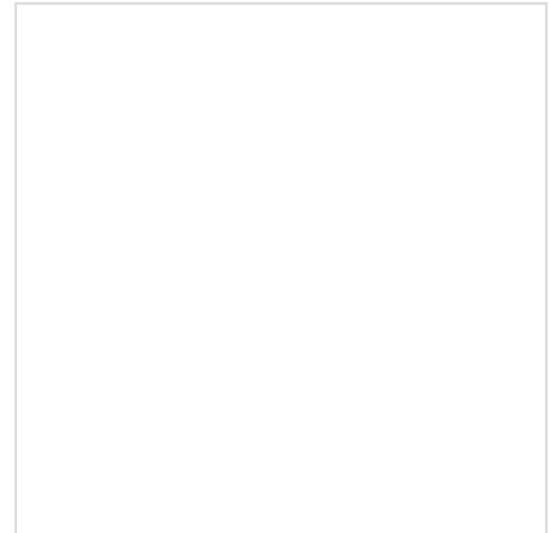

PARTS IMAGE

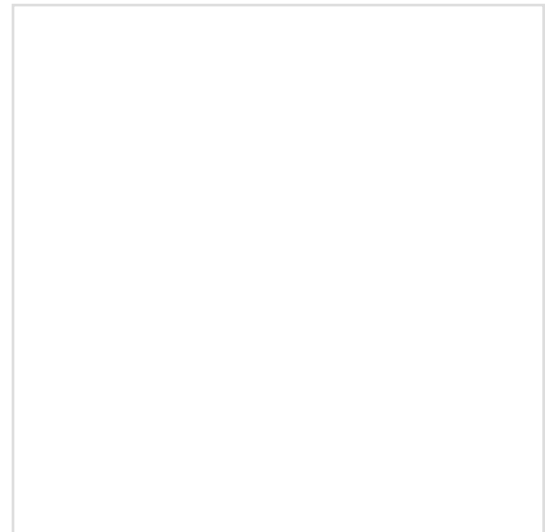

BOX IMAGE

WB-1009

WHEEL BEARING

Parts Number : WB-1009

Manufacture 1 : KOYO

Manufacturer Number 1 : LM11949/10

Manufacture 2 :

Manufacture Number 2 :

M.S.R.P 04/2010 :

Description: WHEEL BEARING

Application 1 :

Application 2 :

Application 3 :

Application 4 :

Application 5 :

Application 6 :

Application 7 :

Application 8 :

Application 9 :

Application 10 :

Application 11 :

Application 12 :

ZOOM+

ZOOM-



PARTS IMAGE

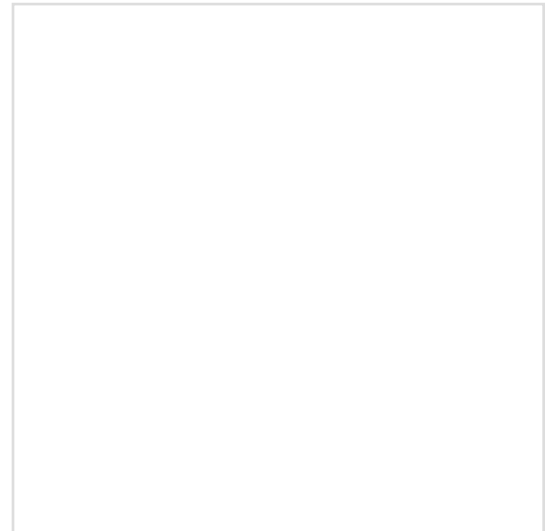

BOX IMAGE

WB-1010

WHEEL BEARING

Parts Number : WB-1010

Manufacture 1 : KOYO

Manufacturer Number 1 : L44649-R/10

Manufacture 2 :

Manufacture Number 2 :

M.S.R.P 04/2010 :

Description: WHEEL BEARING

Application 1 :

Application 2 :

Application 3 :

Application 4 :

Application 5 :

Application 6 :

Application 7 :

Application 8 :

Application 9 :

Application 10 :

Application 11 :

Application 12 :

ZOOM+

ZOOM-

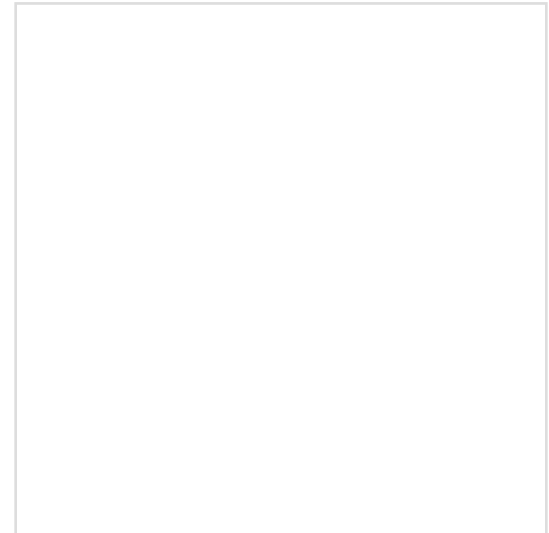

PARTS IMAGE

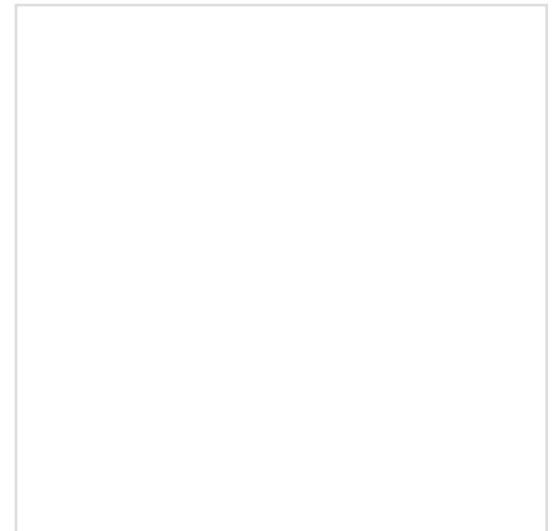

BOX IMAGE

WB-1011

WHEEL BEARING

Parts Number : WB-1011

Manufacture 1 : NTN

Manufacturer Number 1 : 4T-L45449/L45410

Manufacture 2 :

Manufacture Number 2 :

M.S.R.P 04/2010 :

Description: WHEEL BEARING

Application 1 :

Application 2 :

Application 3 :

Application 4 :

Application 5 :

Application 6 :

Application 7 :

Application 8 :

Application 9 :

Application 10 :

Application 11 :

Application 12 :

ZOOM+

ZOOM-



PARTS IMAGE

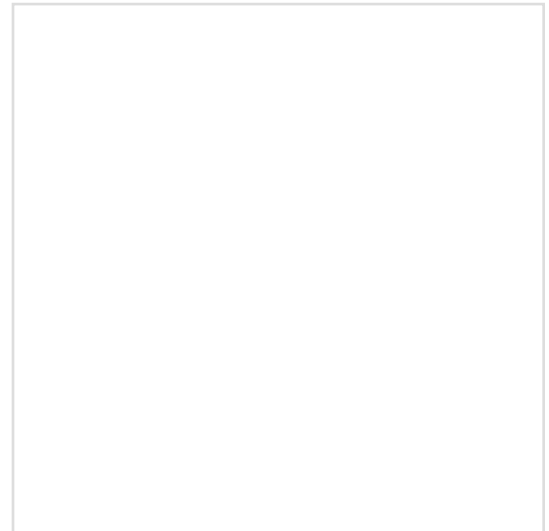

BOX IMAGE

WB-1012

WHEEL BEARING

Parts Number : WB-1012

Manufacture 1 : NTN

Manufacturer Number 1 : 4T-LM11749/LM11710

Manufacture 2 :

Manufacture Number 2 :

M.S.R.P 04/2010 :

Description: WHEEL BEARING

Application 1 :

Application 2 :

Application 3 :

Application 4 :

Application 5 :

Application 6 :

Application 7 :

Application 8 :

Application 9 :

Application 10 :

Application 11 :

Application 12 :

ZOOM+

ZOOM-



PARTS IMAGE

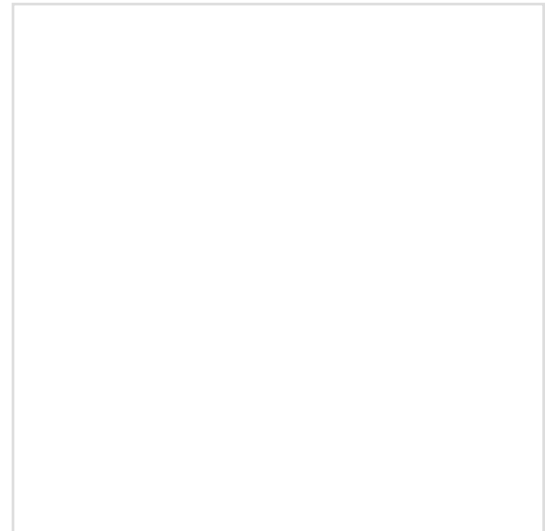

BOX IMAGE

WB-1013

WHEEL BEARING

Parts Number :	WB-1013
Manufacture 1 :	NTN <input type="button" value="v"/>
Manufacturer Number 1 :	6207LLUC3
Manufacture 2 :	NSK <input type="button" value="v"/>
Manufacture Number 2 :	6207LLUC3/L627
M.S.R.P 04/2010 :	
Description:	WHEEL BEARING

- Application 1 :
- Application 2 :
- Application 3 :
- Application 4 :
- Application 5 :
- Application 6 :
- Application 7 :
- Application 8 :
- Application 9 :
- Application 10 :
- Application 11 :
- Application 12 :

ZOOM+ ZOOM-



PARTS IMAGE



BOX IMAGE

WB-1014

WHEEL BEARING

Parts Number : WB-1014

Manufacture 1 : NACHI

Manufacturer Number 1 : 38BVV07-26G

Manufacture 2 :

Manufacture Number 2 :

M.S.R.P 04/2010 :

Description: WHEEL BEARING

Application 1 :

Application 2 :

Application 3 :

Application 4 :

Application 5 :

Application 6 :

Application 7 :

Application 8 :

Application 9 :

Application 10 :

Application 11 :

Application 12 :

ZOOM+

ZOOM-

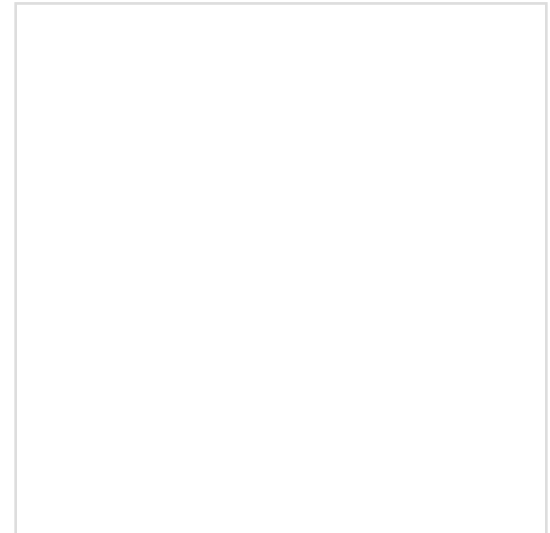

PARTS IMAGE

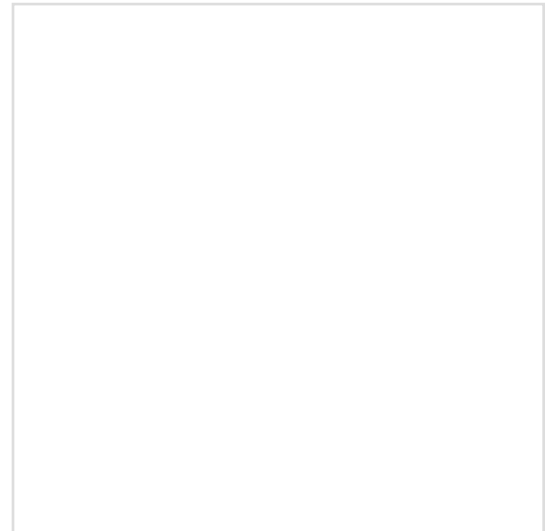

BOX IMAGE

WB-1014A

WHEEL BEARING

Parts Number :	WB-1014A
Manufacture 1 :	NTN <input type="button" value="v"/>
Manufacturer Number 1 :	H0/38BWD15ACA63
Manufacture 2 :	NSK <input type="button" value="v"/>
Manufacturer Number 2 :	H038BWD15AACA63
M.S.R.P 04/2010 :	
Description:	WHEEL BEARING

- Application 1 :
- Application 2 :
- Application 3 :
- Application 4 :
- Application 5 :
- Application 6 :
- Application 7 :
- Application 8 :
- Application 9 :
- Application 10 :
- Application 11 :
- Application 12 :

ZOOM+ ZOOM-



PARTS IMAGE



BOX IMAGE

WB-1015

WHEEL BEARING

Parts Number : WB-1015

Manufacture 1 : NSK

Manufacturer Number 1 : HR30205J

Manufacture 2 :

Manufacture Number 2 :

M.S.R.P 04/2010 :

Description: WHEEL BEARING

Application 1 :

Application 2 :

Application 3 :

Application 4 :

Application 5 :

Application 6 :

Application 7 :

Application 8 :

Application 9 :

Application 10 :

Application 11 :

Application 12 :

ZOOM+

ZOOM-

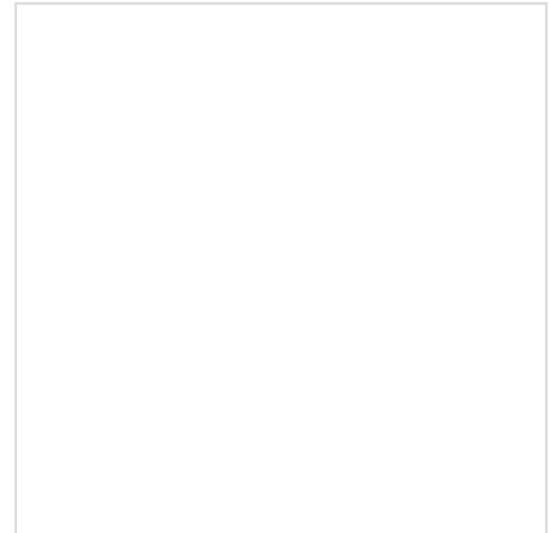

PARTS IMAGE

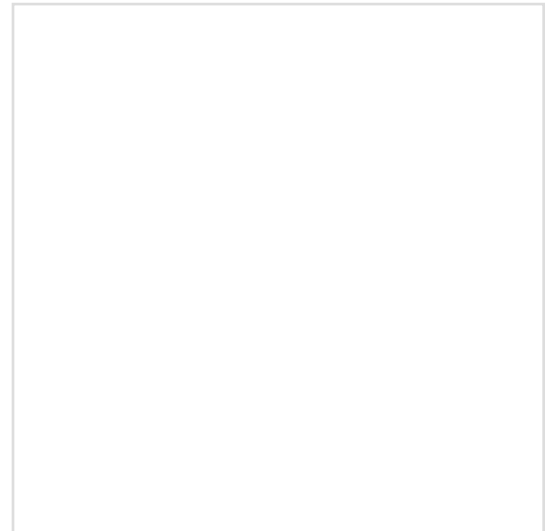

BOX IMAGE

WB-1016

WHEEL BEARING

Parts Number : WB-1016

Manufacture 1 : NACHI

Manufacturer Number 1 : 6206NSLC4

Manufacture 2 :

Manufacturer Number 2 :

M.S.R.P 04/2010 :

Description: WHEEL BEARING

Application 1 :

Application 2 :

Application 3 :

Application 4 :

Application 5 :

Application 6 :

Application 7 :

Application 8 :

Application 9 :

Application 10 :

Application 11 :

Application 12 :

ZOOM+

ZOOM-



PARTS IMAGE



BOX IMAGE

WB-1017

WHEEL BEARING

Parts Number : WB-1017

Manufacture 1 : NSK

Manufacturer Number 1 : HR32207J

Manufacture 2 :

Manufacturer Number 2 :

M.S.R.P 04/2010 :

Description: WHEEL BEARING

Application 1 :

Application 2 :

Application 3 :

Application 4 :

Application 5 :

Application 6 :

Application 7 :

Application 8 :

Application 9 :

Application 10 :

Application 11 :

Application 12 :

ZOOM+ ZOOM-



PARTS IMAGE



BOX IMAGE

WB-1027

WHEEL BEARING

Parts Number : WB-1027

Manufacture 1 : KOYO

Manufacturer Number 1 : L68149/11

Manufacture 2 :

Manufacture Number 2 :

M.S.R.P 04/2010 :

Description: WHEEL BEARING

Application 1 :

Application 2 :

Application 3 :

Application 4 :

Application 5 :

Application 6 :

Application 7 :

Application 8 :

Application 9 :

Application 10 :

Application 11 :

Application 12 :

ZOOM+ ZOOM-



PARTS IMAGE



BOX IMAGE

WB-1028

WHEEL BEARING

Parts Number : WB-1028

Manufacture 1 : NACHI

Manufacturer Number 1 : 6008-2NSE

Manufacture 2 :

Manufacture Number 2 :

M.S.R.P 04/2010 :

Description: WHEEL BEARING

Application 1 :

Application 2 :

Application 3 :

Application 4 :

Application 5 :

Application 6 :

Application 7 :

Application 8 :

Application 9 :

Application 10 :

Application 11 :

Application 12 :

ZOOM+

ZOOM-



PARTS IMAGE

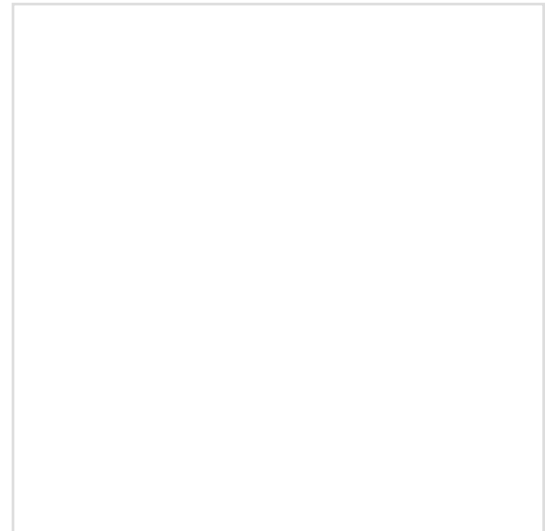

BOX IMAGE

WB-1029

WHEEL BEARING

Parts Number : WB-1029

Manufacture 1 : NACHI

Manufacturer Number 1 : 6009-2NSE

Manufacture 2 :

Manufacture Number 2 :

M.S.R.P 04/2010 :

Description: WHEEL BEARING

Application 1 :

Application 2 :

Application 3 :

Application 4 :

Application 5 :

Application 6 :

Application 7 :

Application 8 :

Application 9 :

Application 10 :

Application 11 :

Application 12 :

ZOOM+

ZOOM-



PARTS IMAGE

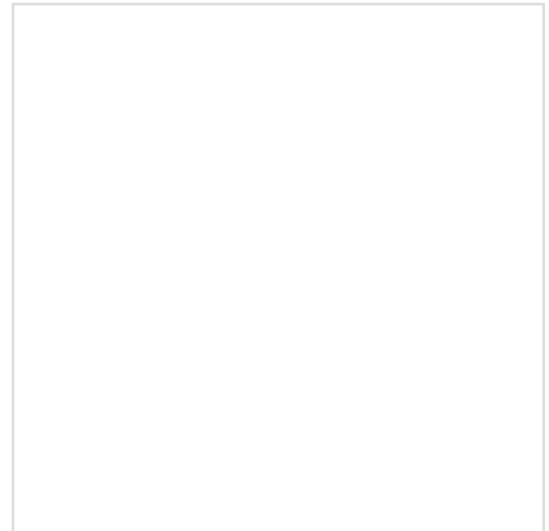

BOX IMAGE

WB-1030

WHEEL BEARING

Parts Number : WB-1030

Manufacture 1 : NTN

Manufacturer Number 1 : 4T-368S

Manufacture 2 :

Manufacture Number 2 :

M.S.R.P 04/2010 :

Description: WHEEL BEARING

Application 1 :

Application 2 :

Application 3 :

Application 4 :

Application 5 :

Application 6 :

Application 7 :

Application 8 :

Application 9 :

Application 10 :

Application 11 :

Application 12 :

ZOOM+

ZOOM-

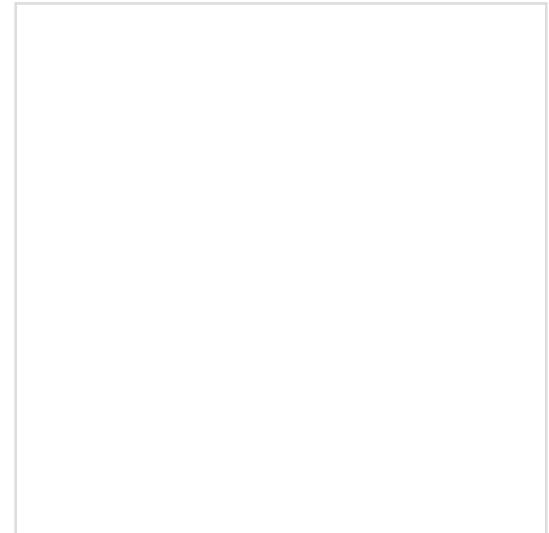

PARTS IMAGE

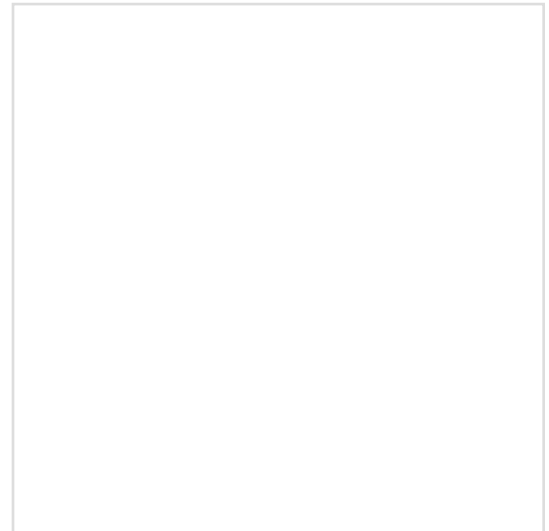

BOX IMAGE

WB-1031

WHEEL BEARING

Parts Number : WB-1031

Manufacture 1 : KOYO

Manufacturer Number 1 : LM12749/10

Manufacture 2 :

Manufacture Number 2 :

M.S.R.P 04/2010 :

Description: WHEEL BEARING

Application 1 :

Application 2 :

Application 3 :

Application 4 :

Application 5 :

Application 6 :

Application 7 :

Application 8 :

Application 9 :

Application 10 :

Application 11 :

Application 12 :

ZOOM+

ZOOM-



PARTS IMAGE

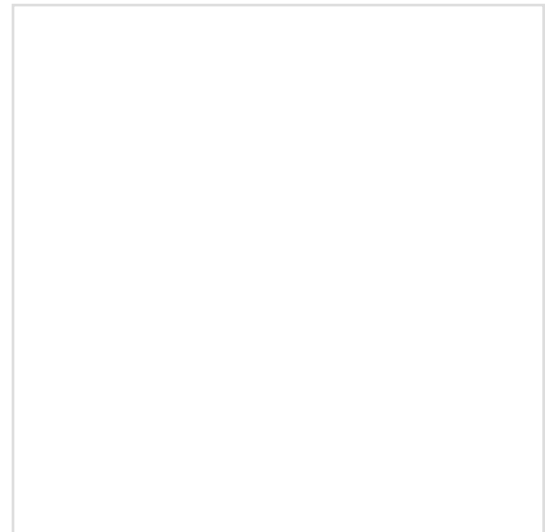

BOX IMAGE

WB-1032

WHEEL BEARING

Parts Number : WB-1032

Manufacture 1 : KOYO

Manufacturer Number 1 : LM12749/11

Manufacture 2 :

Manufacture Number 2 :

M.S.R.P 04/2010 :

Description: WHEEL BEARING

Application 1 :

Application 2 :

Application 3 :

Application 4 :

Application 5 :

Application 6 :

Application 7 :

Application 8 :

Application 9 :

Application 10 :

Application 11 :

Application 12 :

ZOOM+

ZOOM-

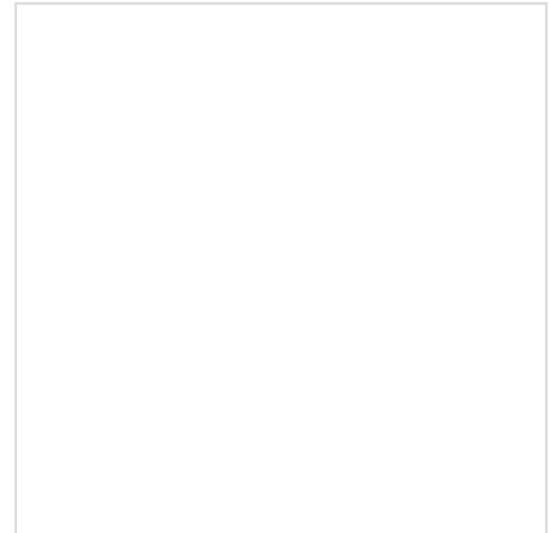

PARTS IMAGE

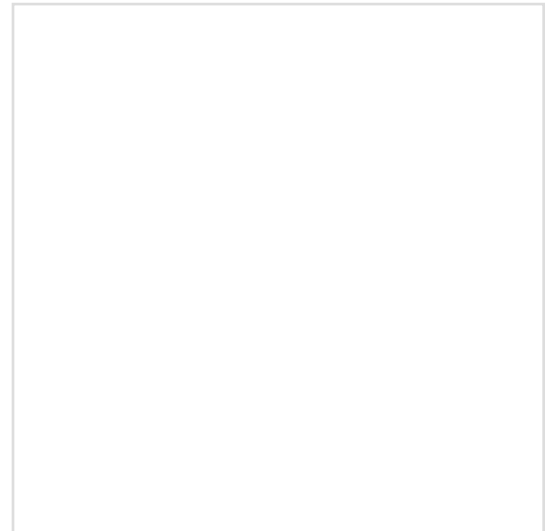

BOX IMAGE

WB-1033

WHEEL BEARING

Parts Number : WB-1033

Manufacture 1 : NTN

Manufacturer Number 1 : 4T-M20104S/M201#02

Manufacture 2 :

Manufacture Number 2 :

M.S.R.P 04/2010 :

Description: WHEEL BEARING

Application 1 :

Application 2 :

Application 3 :

Application 4 :

Application 5 :

Application 6 :

Application 7 :

Application 8 :

Application 9 :

Application 10 :

Application 11 :

Application 12 :

ZOOM+

ZOOM-



PARTS IMAGE

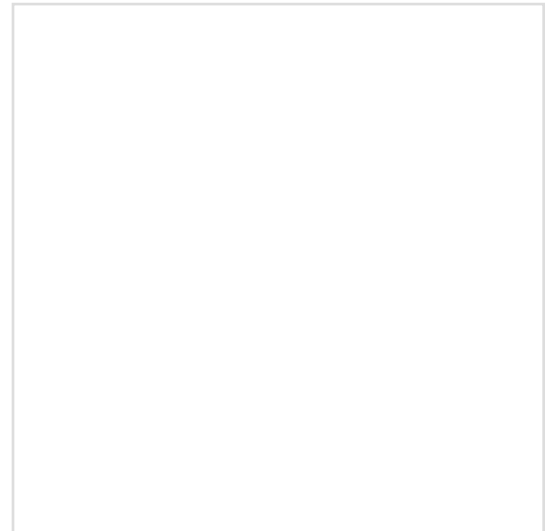

BOX IMAGE

WB-1034

WHEEL BEARING

Parts Number : WB-1034

Manufacture 1 : KOYO

Manufacturer Number 1 : L68149/10

Manufacture 2 :

Manufacture Number 2 :

M.S.R.P 04/2010 :

Description: WHEEL BEARING

Application 1 :

Application 2 :

Application 3 :

Application 4 :

Application 5 :

Application 6 :

Application 7 :

Application 8 :

Application 9 :

Application 10 :

Application 11 :

Application 12 :

ZOOM+

ZOOM-



PARTS IMAGE



BOX IMAGE

WB-1035

WHEEL BEARING

Parts Number : WB-1035

Manufacture 1 : KOYO

Manufacturer Number 1 : L44643/10

Manufacture 2 :

Manufacture Number 2 :

M.S.R.P 04/2010 :

Description: WHEEL BEARING

Application 1 :

Application 2 :

Application 3 :

Application 4 :

Application 5 :

Application 6 :

Application 7 :

Application 8 :

Application 9 :

Application 10 :

Application 11 :

Application 12 :

ZOOM+

ZOOM-

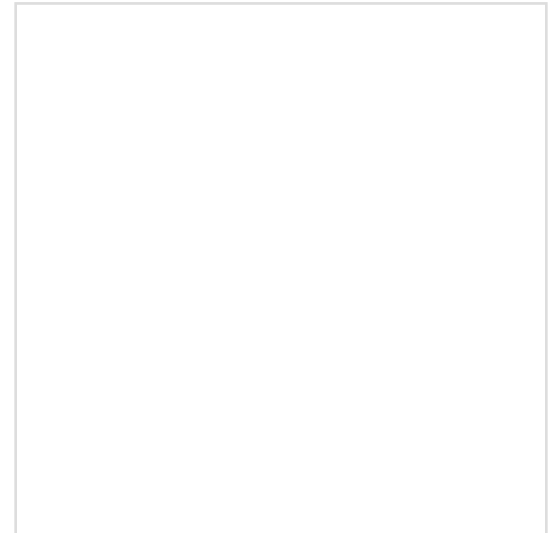

PARTS IMAGE

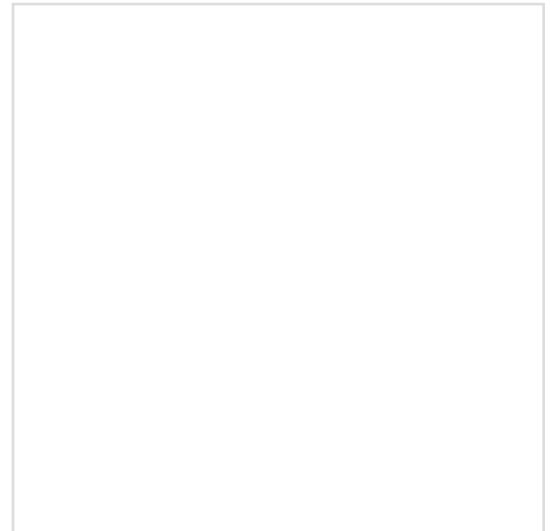

BOX IMAGE

WB-1036

WHEEL BEARING

Parts Number : WB-1036

Manufacture 1 : NTN

Manufacturer Number 1 : 4T-07100/07196

Manufacture 2 :

Manufacture Number 2 :

M.S.R.P 04/2010 :

Description: WHEEL BEARING

Application 1 :

Application 2 :

Application 3 :

Application 4 :

Application 5 :

Application 6 :

Application 7 :

Application 8 :

Application 9 :

Application 10 :

Application 11 :

Application 12 :

ZOOM+

ZOOM-



PARTS IMAGE

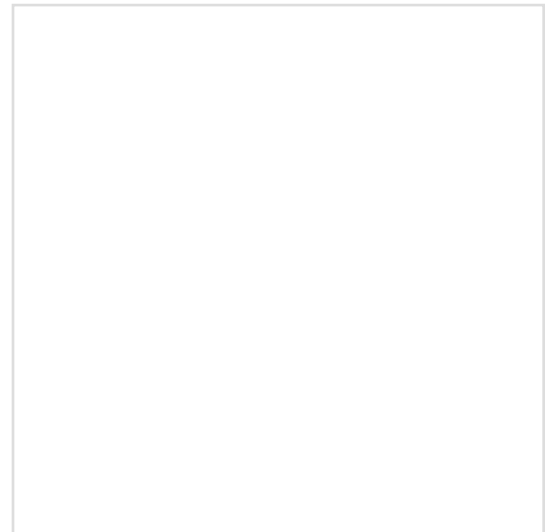

BOX IMAGE

WB-1037

WHEEL BEARING

Parts Number : WB-1037

Manufacture 1 : NTN

Manufacturer Number 1 : 4T-JLM506848E/JL#01

Manufacture 2 :

Manufacture Number 2 :

M.S.R.P 04/2010 :

Description: WHEEL BEARING

Application 1 :

Application 2 :

Application 3 :

Application 4 :

Application 5 :

Application 6 :

Application 7 :

Application 8 :

Application 9 :

Application 10 :

Application 11 :

Application 12 :

ZOOM+

ZOOM-

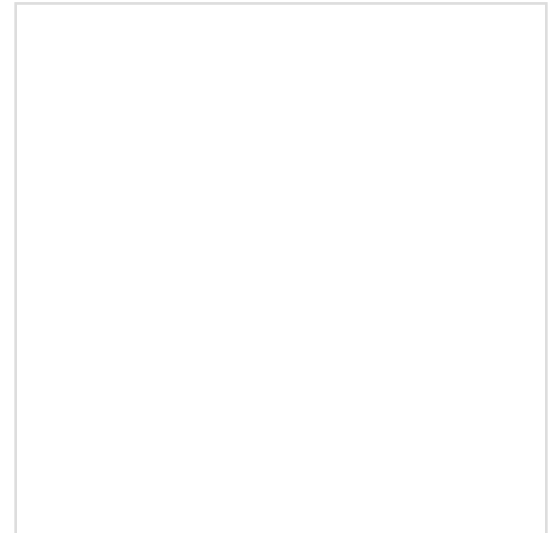

PARTS IMAGE

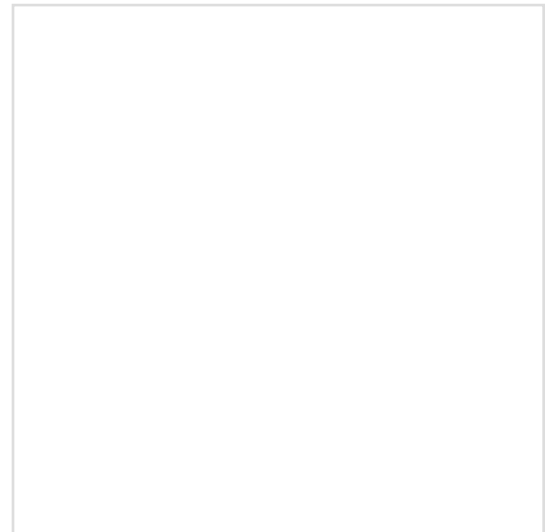

BOX IMAGE

WB-1038

WHEEL BEARING

Parts Number : WB-1038

Manufacture 1 : NTN

Manufacturer Number 1 : 4T-LM10494E/LM1#01

Manufacture 2 :

Manufacture Number 2 :

M.S.R.P 04/2010 :

Description: WHEEL BEARING

Application 1 :

Application 2 :

Application 3 :

Application 4 :

Application 5 :

Application 6 :

Application 7 :

Application 8 :

Application 9 :

Application 10 :

Application 11 :

Application 12 :

ZOOM+

ZOOM-

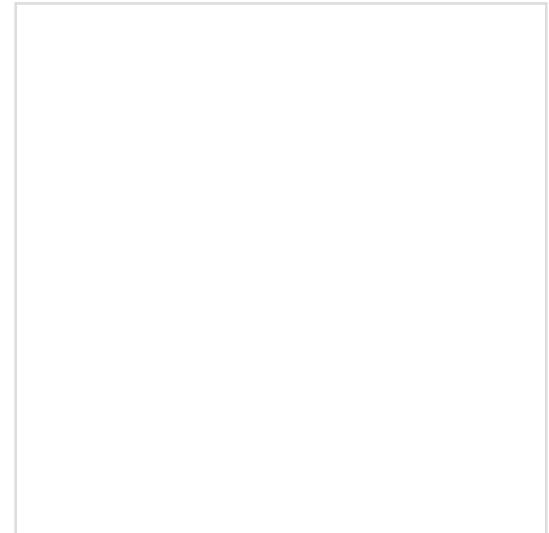

PARTS IMAGE

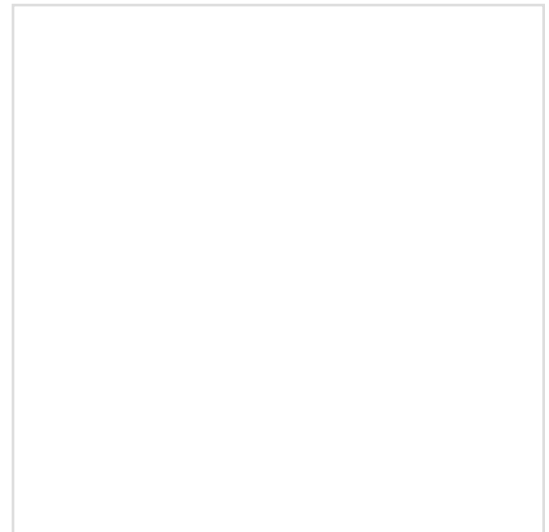

BOX IMAGE

WB-1039

WHEEL BEARING

Parts Number : WB-1039

Manufacture 1 : NTN

Manufacturer Number 1 : 4T-JL68145/JL681117

Manufacture 2 :

Manufacture Number 2 :

M.S.R.P 04/2010 :

Description: WHEEL BEARING

Application 1 :

Application 2 :

Application 3 :

Application 4 :

Application 5 :

Application 6 :

Application 7 :

Application 8 :

Application 9 :

Application 10 :

Application 11 :

Application 12 :

ZOOM+

ZOOM-



PARTS IMAGE

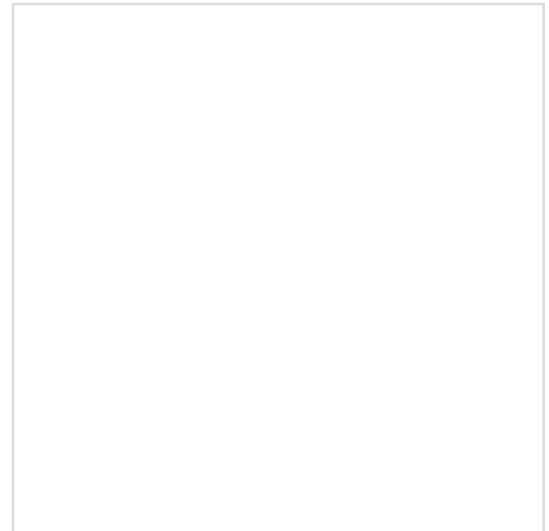

BOX IMAGE

WB-1040

WHEEL BEARING

Parts Number : WB-1040

Manufacture 1 : NTN

Manufacturer Number 1 : 4T-320/32XX1

Manufacture 2 :

Manufacture Number 2 :

M.S.R.P 04/2010 :

Description: WHEEL BEARING

Application 1 :

Application 2 :

Application 3 :

Application 4 :

Application 5 :

Application 6 :

Application 7 :

Application 8 :

Application 9 :

Application 10 :

Application 11 :

Application 12 :

ZOOM+

ZOOM-

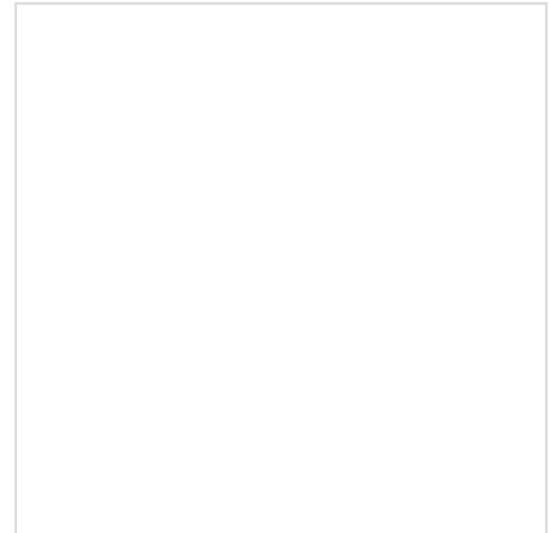

PARTS IMAGE

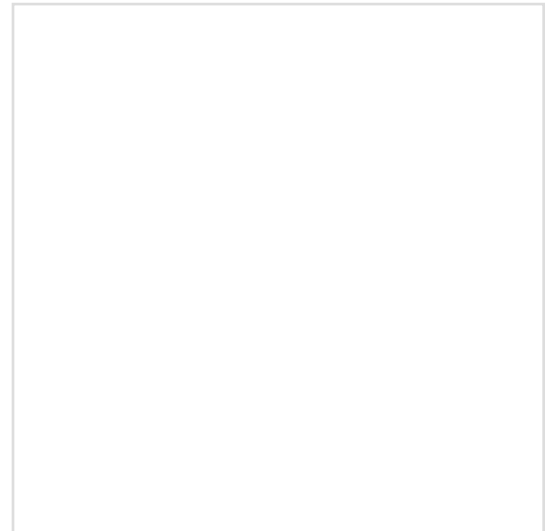

BOX IMAGE

WB-1041

WHEEL BEARING

Parts Number : WB-1041

Manufacture 1 : NTN

Manufacturer Number 1 : 4T-LM12748/LM12710

Manufacture 2 :

Manufacture Number 2 :

M.S.R.P 04/2010 :

Description: WHEEL BEARING

Application 1 :

Application 2 :

Application 3 :

Application 4 :

Application 5 :

Application 6 :

Application 7 :

Application 8 :

Application 9 :

Application 10 :

Application 11 :

Application 12 :

ZOOM+

ZOOM-



PARTS IMAGE

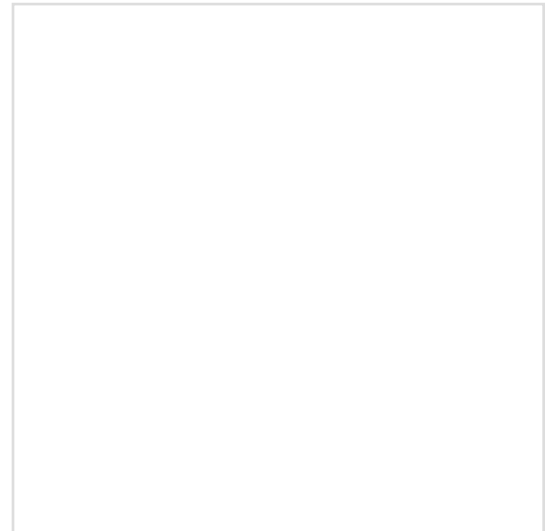

BOX IMAGE

WB-1042

WHEEL BEARING

Parts Number : WB-1042

Manufacture 1 : NTN

Manufacturer Number 1 : 4T-17887/17831

Manufacture 2 :

Manufacture Number 2 :

M.S.R.P 04/2010 :

Description: WHEEL BEARING

Application 1 :

Application 2 :

Application 3 :

Application 4 :

Application 5 :

Application 6 :

Application 7 :

Application 8 :

Application 9 :

Application 10 :

Application 11 :

Application 12 :

ZOOM+

ZOOM-

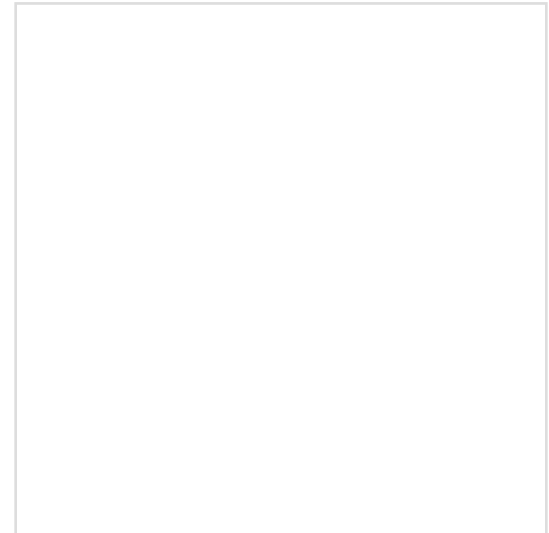

PARTS IMAGE

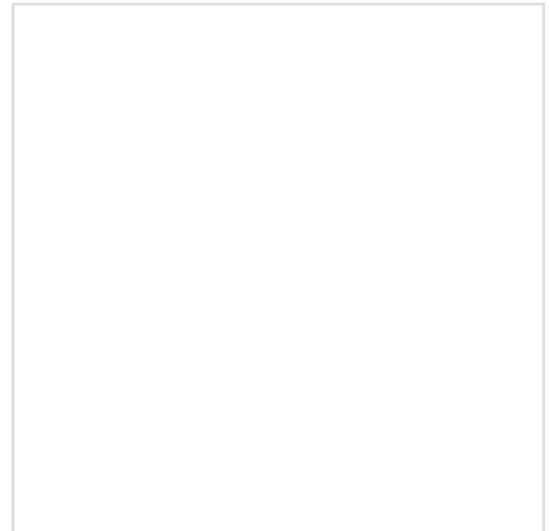

BOX IMAGE

WB-1043

WHEEL BEARING

Parts Number : WB-1043

Manufacture 1 : NTN

Manufacturer Number 1 : 4T-368S/362

Manufacture 2 :

Manufacture Number 2 :

M.S.R.P 04/2010 :

Description: WHEEL BEARING

Application 1 :

Application 2 :

Application 3 :

Application 4 :

Application 5 :

Application 6 :

Application 7 :

Application 8 :

Application 9 :

Application 10 :

Application 11 :

Application 12 :

ZOOM+

ZOOM-



PARTS IMAGE

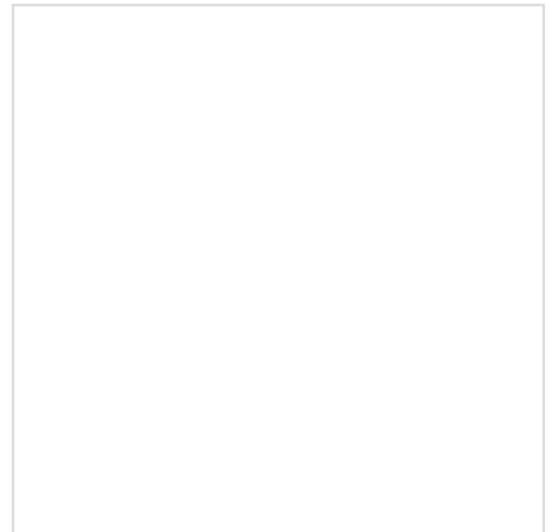

BOX IMAGE

WB-1044

WHEEL BEARING

Parts Number : WB-1044

Manufacture 1 : NTN

Manufacturer Number 1 : 4T-387/382

Manufacture 2 :

Manufacture Number 2 :

M.S.R.P 04/2010 :

Description: WHEEL BEARING

Application 1 :

Application 2 :

Application 3 :

Application 4 :

Application 5 :

Application 6 :

Application 7 :

Application 8 :

Application 9 :

Application 10 :

Application 11 :

Application 12 :

ZOOM+

ZOOM-



PARTS IMAGE

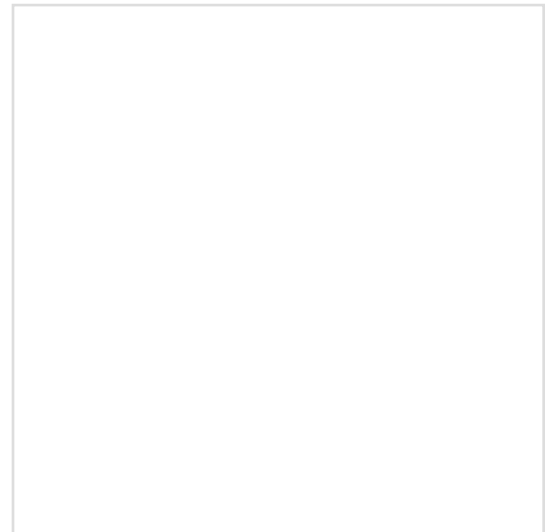

BOX IMAGE

WB-1045

WHEEL BEARING

Parts Number : WB-1045

Manufacture 1 : NTN

Manufacturer Number 1 : 4T-388A/382

Manufacture 2 :

Manufacture Number 2 :

M.S.R.P 04/2010 :

Description: WHEEL BEARING

Application 1 :

Application 2 :

Application 3 :

Application 4 :

Application 5 :

Application 6 :

Application 7 :

Application 8 :

Application 9 :

Application 10 :

Application 11 :

Application 12 :

ZOOM+

ZOOM-



PARTS IMAGE

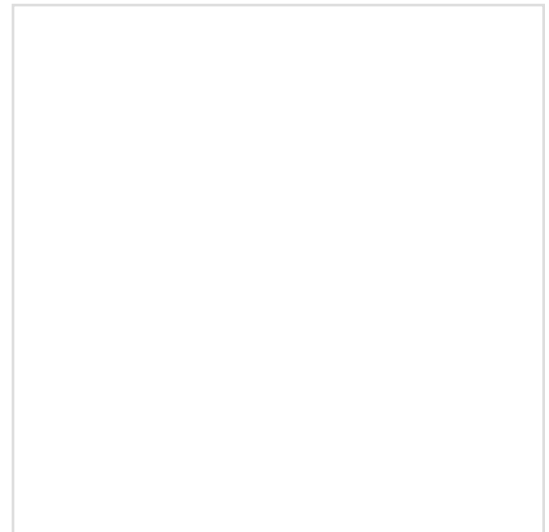

BOX IMAGE

WB-1046

WHEEL BEARING

Parts Number : WB-1046

Manufacture 1 : NTN

Manufacturer Number 1 : 4T-JL26749/JL267#01

Manufacture 2 :

Manufacture Number 2 :

M.S.R.P 04/2010 :

Description: WHEEL BEARING

Application 1 :

Application 2 :

Application 3 :

Application 4 :

Application 5 :

Application 6 :

Application 7 :

Application 8 :

Application 9 :

Application 10 :

Application 11 :

Application 12 :

ZOOM+

ZOOM-

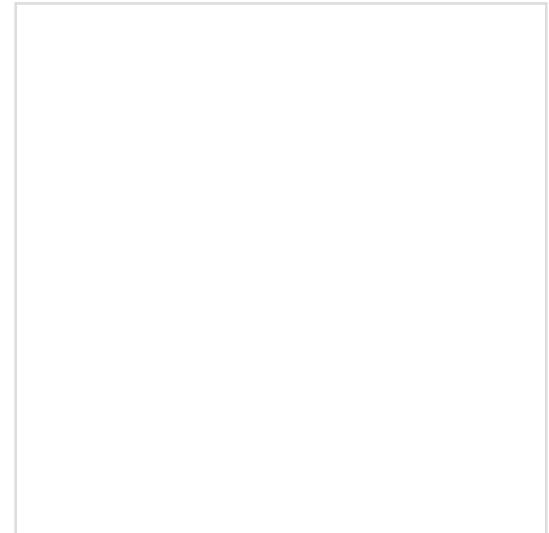

PARTS IMAGE

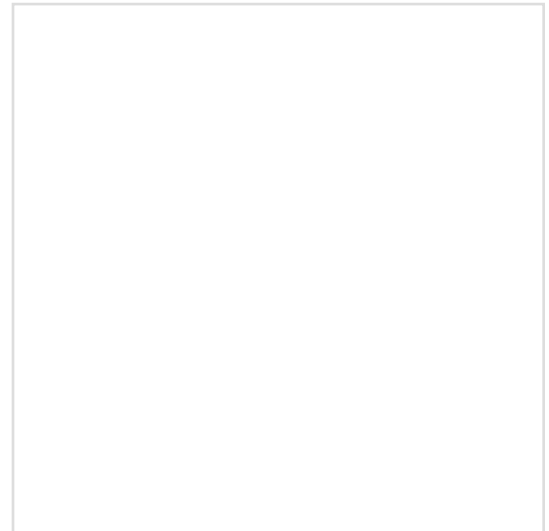

BOX IMAGE

WB-1048

Parts Number : WB-1048

Manufacture 1 : NTN

Manufacturer Number 1 : 4T-CRT-0685CS110

Manufacture 2 :

Manufacture Number 2 :

M.S.R.P 04/2010 :

Description: WHEEL BEARING MADE IN JAPAN

WHEEL BEARING MADE IN



PARTS IMAGE

Application 1 :

Application 2 :

Application 3 :

Application 4 :

Application 5 :

Application 6 :

Application 7 :

Application 8 :

Application 9 :

Application 10 :

Application 11 :

Application 12 :



BOX IMAGE

WB-1101

WHEEL BEARING

Parts Number : WB-1101

Manufacture 1 : NACHI

Manufacturer Number 1 : 6007-2NSE

Manufacture 2 :

Manufacturer Number 2 :

M.S.R.P 04/2010 :

Description: WHEEL BEARING

Application 1 :

Application 2 :

Application 3 :

Application 4 :

Application 5 :

Application 6 :

Application 7 :

Application 8 :

Application 9 :

Application 10 :

Application 11 :

Application 12 :

ZOOM+

ZOOM-



PARTS IMAGE



BOX IMAGE

WB-1102

WHEEL BEARING

Parts Number : WB-1102

Manufacture 1 : NSK

Manufacturer Number 1 : 40BWD08ACA55

Manufacture 2 :

Manufacture Number 2 :

M.S.R.P 04/2010 :

Description: WHEEL BEARING

Application 1 :

Application 2 :

Application 3 :

Application 4 :

Application 5 :

Application 6 :

Application 7 :

Application 8 :

Application 9 :

Application 10 :

Application 11 :

Application 12 :

ZOOM+

ZOOM-



PARTS IMAGE

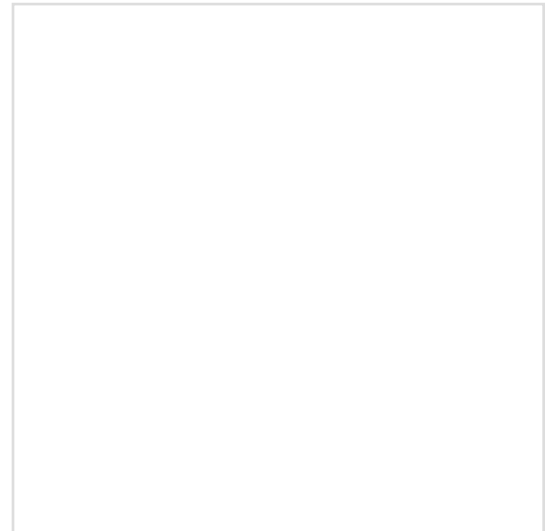

BOX IMAGE

WB-1103

WHEEL BEARING

Parts Number : WB-1103

Manufacture 1 : NTN

Manufacturer Number 1 : 4T-2777

Manufacture 2 :

Manufacture Number 2 :

M.S.R.P 04/2010 :

Description: WHEEL BEARING

Application 1 :

Application 2 :

Application 3 :

Application 4 :

Application 5 :

Application 6 :

Application 7 :

Application 8 :

Application 9 :

Application 10 :

Application 11 :

Application 12 :

ZOOM+

ZOOM-

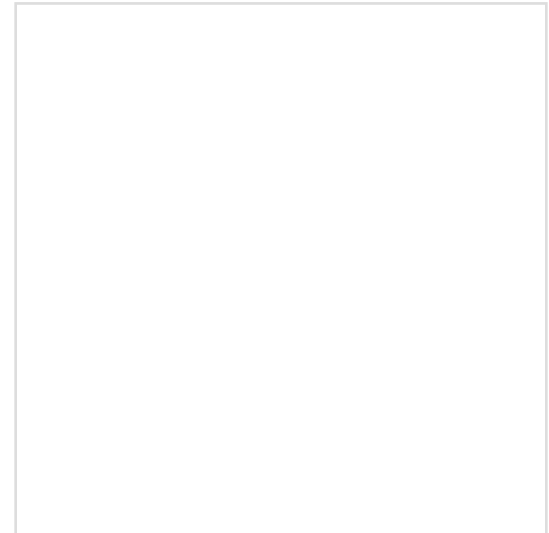

PARTS IMAGE

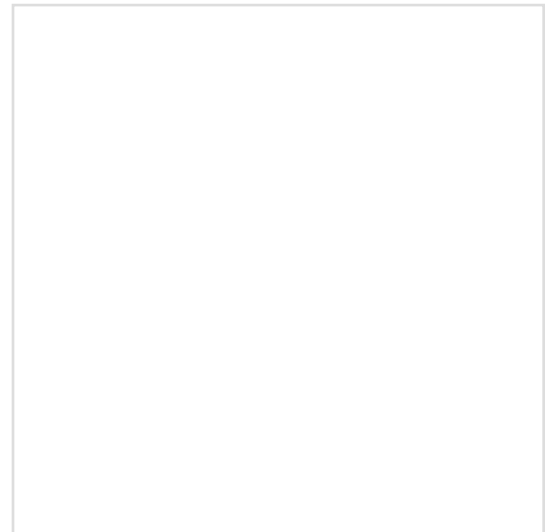

BOX IMAGE