

Nuggets of Gold

- Troubleshooting Tips For diagnosing vibration problems
- Balancing
- Alignment
- Motors
- Pumps
- Signal Processing Considerations
- DC Drives

General Thought WHEN HIGH VIBRATION IS PRESENT

- 1: There may be a large force
- 2: The structure may be weak
- 3: Resonance amplification may be present

Balancing

1: When balancing, plot the original and trial vectors on all bearings and orientations. When all vectors point towards the same solution; you are in the right plane. When the vectors do not point towards the same solution, try another plane. If this still doesn't work, try a multi-plane solution.

Vectors Agree In weight adjustment



Vectors disagree in weight adjustment



MOTOR GENERATOR SET ON DRAG LINE

SIX ROTORS WITH SEVEN SHARED BEARINGS SOLIDLY COUPLED ON A METAL DECK.

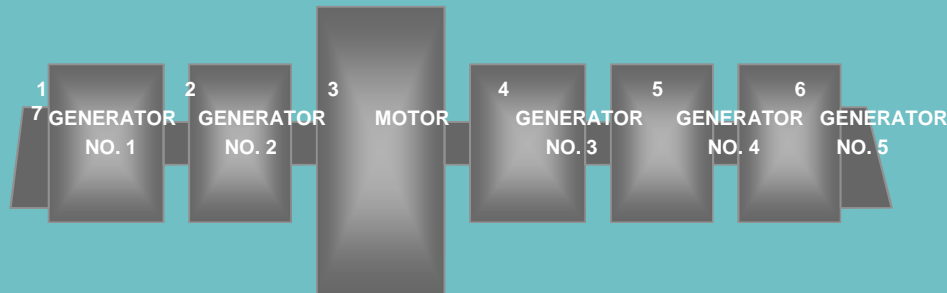

ORIGINAL READINGS

	BRG. 1	BRG 2	BRG 3	BRG 4	BRG 5	BRG 6	BRG 10
H	7.8 45 DEG	5.4 45 DEG	.8 80 DEG	1.5 220 DEG	1.7 253 DEG	2.1 245 DEG	2.6 260 DEG
V	10.3 50	9.1 50	9.7 45	8.6 47	5.6 63	2.5 107	5.1 180

BALANCE SHOT ADDED TO No. 1 GENERATOR 8.25 OZ at 310 DEGREES

H	5.9 37	3.9 35	.6 45	.8 270	.9 270	.8 270	1.1 45
V	11.0 45	9.6 45	10.1 36	8.8 40	5.4 45	4.1 117	5.9 200

NOTE I- LEVELS WENT DOWN

UNCOUPLED GENERATORS

H	6.8 25	4.5 34
V	7.9 68	6.5 63

NOTE THAT EVEN UNCOUPLED

PERFORMED RESONANCE TEST

ADDED 50 OZ BALANCE WEIGHT

After a weight was installed, Horizontals went down Verticals went down. This is a strong sign that you are adding weight to wrong plane

2: When a rotor runs above its 1st critical and there is an indication of a bow, translate a portion of the static balance component from the ends to the center of the rotor.

If this is not done, the rotor will run good on a balance machine but bad in its own bearings at high speed. This is due to internal bending moments produced by unbalance forces acting on the axial distance between the mass unbalance and the correction weights.

BOWED FLEXIBLE ROTOR REQUIRING MID SPAN SHOT

END PLANE SHOTS

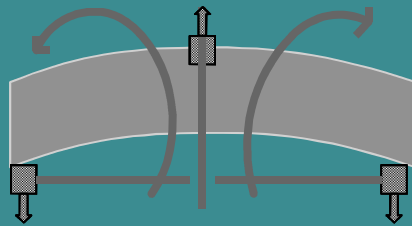

CREATES INTERNAL BENDING MOMENTS

MID SPAN SHOT

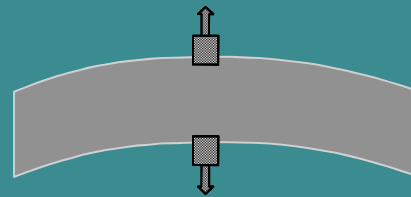

IF SHOT IS DIRECTLY ACROSS FROM BOW NO BENDING MOMENTS ARE CREATED.

WHEN A ROTOR OPERATES BELOW ITS FIRST BENDING MODE, IT ACTS LIKE A RIGID BODY AND THE BALANCE WEIGHT CAN BE ADDED ANYWHERE ALONG THE ROTOR. IF, HOWEVER, THE ROTOR OPERATES ABOVE ITS BENDING MODE, IT BECOMES A FLEXIBLE ROTOR AND THE WEIGHT NEEDS TO BE PLACED OPPOSITE THE HEAVY SPOT TO PREVENT INTERNAL BENDING MOMENTS.

CASE HISTORY: A STATIC BALANCE SHOT IN THE END PLANES WAS INSTALLED ON A HIGH PRESSURE TURBINE ROTOR WITH A BOW. 18 OZ WERE ADDED IN EACH END, WITH ALMOST NO EFFECT. WHEN WEIGHT WAS ADDED IN THE MID SPAN, THE ROTOR WAS EASILY BALANCED.

3: When balancing 2 pole motors which are above 1000 HP, beware of thermal vectors. This class of rotor will operate well uncoupled, but will often have high levels of vibration when pulling full current. This is because the rotor can bow as a function of heating by the current flow.

Corpoven Refinery
Venezuela



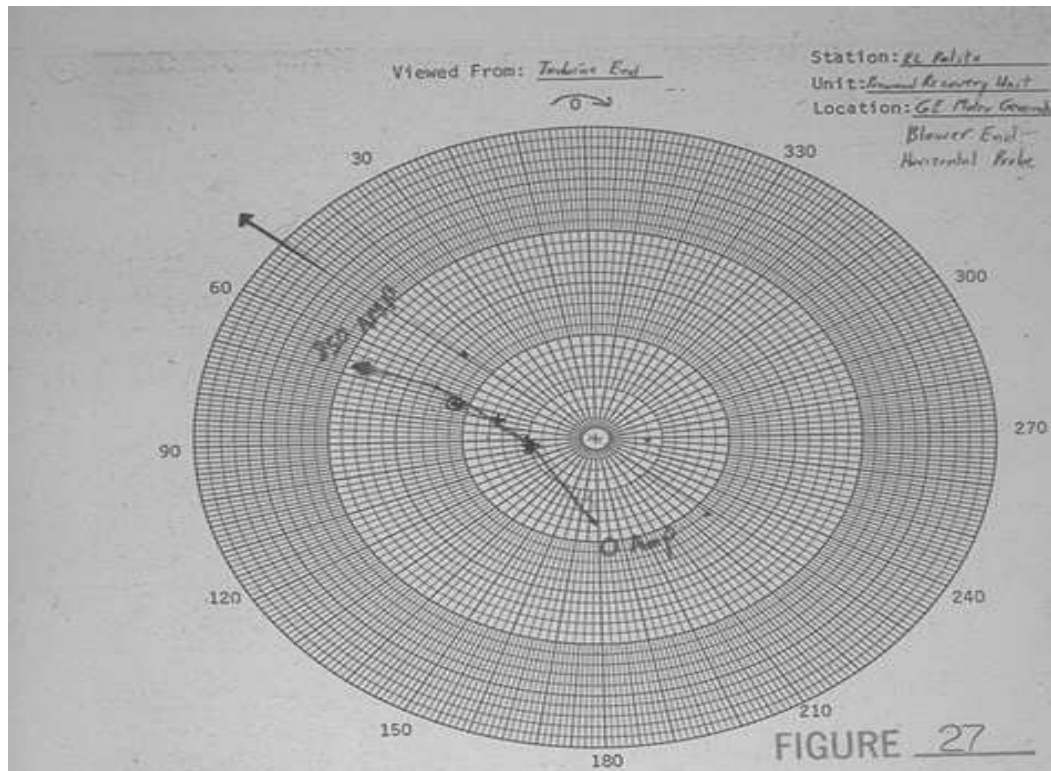

Date	Overall	IX	Phase	AMPS	TAPE-HP	TEAC
6-22-85		1.6	176°	0	A 185 Ft.	
"	*	1.0	97°	240	A 90	25-50
"		2.6	66°	690	A 120	
"		3.9	68°	830	A 985	412-460
AFTER Balancing						
15-7-85	⊙	2.2	70	700	II 250	505-545
27-1-86	+	1.5	74	200	V 100	671-690

4: During a startup, if a high speed compressor has low response as it passes through its critical, but the level increases steadily with RPM, without much of a phase shift, then suspect unbalance in the coupling. On a polar plot, the response line will point straight outward because the amplitude increases without any shift in phase.

COMPRESSOR WITH UNBALANCE IN COUPLING

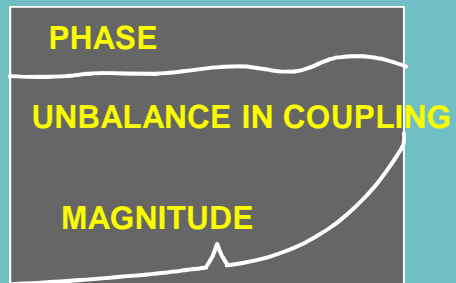
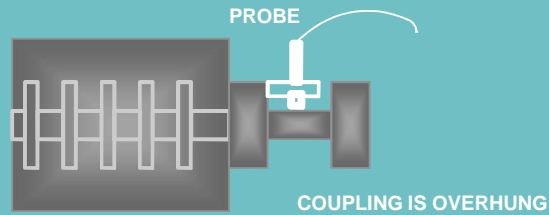

7000 RPM COMP.
BEFORE BAL.
3.8 MILS 240 DEG
WT. ADDED
23.7 GM @ 50DEG
AFTER BALANCE
.6 MILS 203 DEG

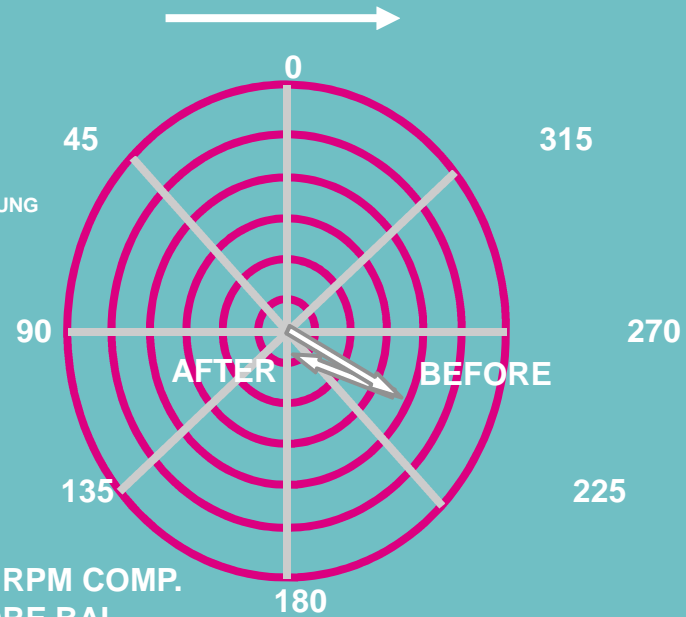

5: When balancing a large machine with multiple rotors, if there is no other clear indication, then on the first trial weight attempt, add weight in the rotor with the largest inertia. Learned from Art Crawford. Once that is done, refer to balancing tip No. 1

MOTOR GENERATOR SET ON DRAG LINE

SIX ROTORS WITH SEVEN SHARED BEARINGS SOLIDLY COUPLED ON A METAL DECK.

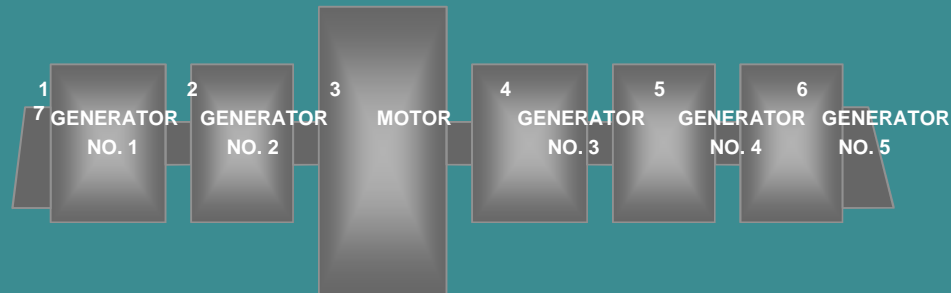

ORIGINAL READINGS

	BRG. 1	BRG 2	BRG 3	BRG 4	BRG 5	BRG 6	BRG 10
H	7.8 45 DEG	5.4 45 DEG	.8 80 DEG	1.5 220 DEG	1.7 253 DEG	2.1 245 DEG	2.6 260 DEG
V	10.3 50	9.1 50	9.7 45	8.6 47	5.6 63	2.5 107	5.1 180

BALANCE SHOT ADDED TO No. 1 GENERATOR 8.25 OZ at 310 DEGREES

H	5.9 37	3.9 35	.6 45	.8 270	.9 270	.8 270	1.1 45
V	11.0 45	9.6 45	10.1 36	8.8 40	5.4 45	1.1 117	5.9 200

NOTE I- LEVELS WENT DOWN IN THE HORIZONTAL DIRECTION, BUT UP IN THE VERTICAL DIRECTION

UNCOUPLED GENERATORS 1 & 2 FROM MOTOR

H	6.8 25	4.5 34	1.0 350	1.6 270	1.8 270	2.0 243	2.7 236
V	7.9 68	6.5 63	6.6 45	5.9 45	3.8 45	1.9 45	1.8 270

NOTE THAT EVEN UNCOUPLED, GENERATOR NO. 1 IS OPERATING WITH ALMOST 8 MILS OF VIBRATION

PERFORMED RESONANCE TEST- STRUCTURE FOUND TO BE OPERATING NEAR RESONANCE

ADDED 50 OZ BALANCE WEIGHT TO MOTOR , ALL LEVELS DROPPED TO BELOW 3 MILS.

6: Do not attempt to balance when the phase is moving. This is a sign that there is a rub. Machines that operate below a critical tend to bow into the rub and the rub gets worse with time. **Machines that operate above a critical can bow away from the rub causing the phase angle to continually move against rotation. Note that if a above critical machine has a light rub, it can be a bad idea to shut it down, because then it will have to coast down through its critical speed.**

7: When the horizontal and vertical phase are the same or 180 degrees out, then look for rocking or a loose base. Another thing to consider is that if a machine is operating between a vertical and horizontal natural frequency then this can also cause unusual phase relationships between the vertical and horizontal directions.

6 CASES OF LOOSENESS

Case History 1- The phase on a turbine bearing was identical in the vertical and axial directions with the axial vibration being very high. It was discovered that one of the hold down bolts was broken off beneath the surface of the concrete allowing the bearing to rock.

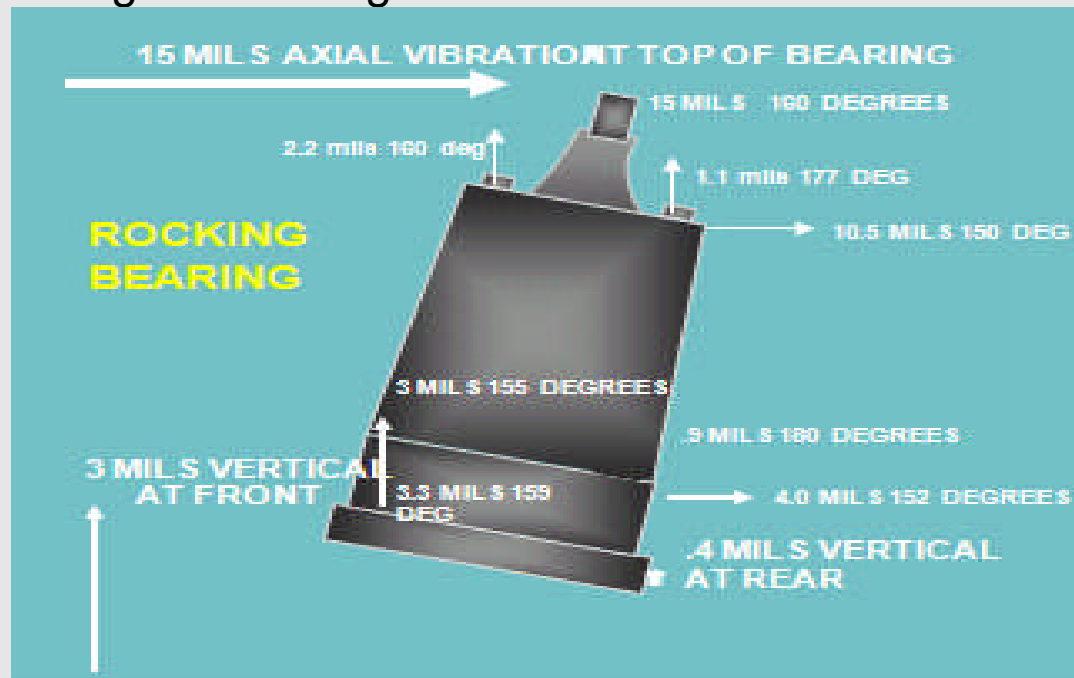

Case 2- On a large fan, the horizontal and vertical vibration phase angles were identical. The base bolts were loose allowing the bearing to rock. The maintenance manager did not believe it so a cup of water was poured on the base next to the bearing. When the water alternately shot out from between the bearing housing and the base plate, he agreed to have the bolts tightened. The horizontal vibration dropped from 12 mils to less than 2 mils.

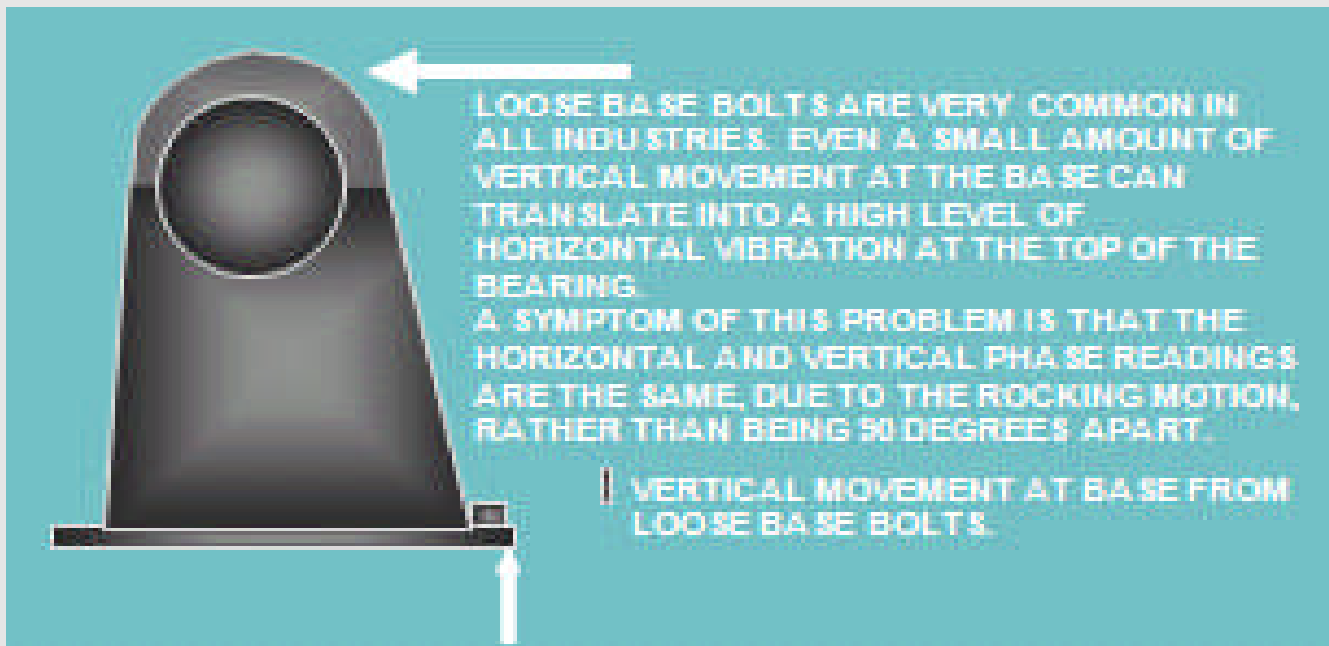

CASE 3- A power plant had spent \$30000 on a mill motor trying to get the vibration levels reduced. The rotor had been balanced several times, but the amplitude was still high.

MOTOR VIBRATION WAS 8 MILS. BOLT WAS TIGHT BUT NOT MAKING CONTACT. WHEN WASHER WAS ADDED, VIBRATION DROPPED TO BELOW 1 MIL.

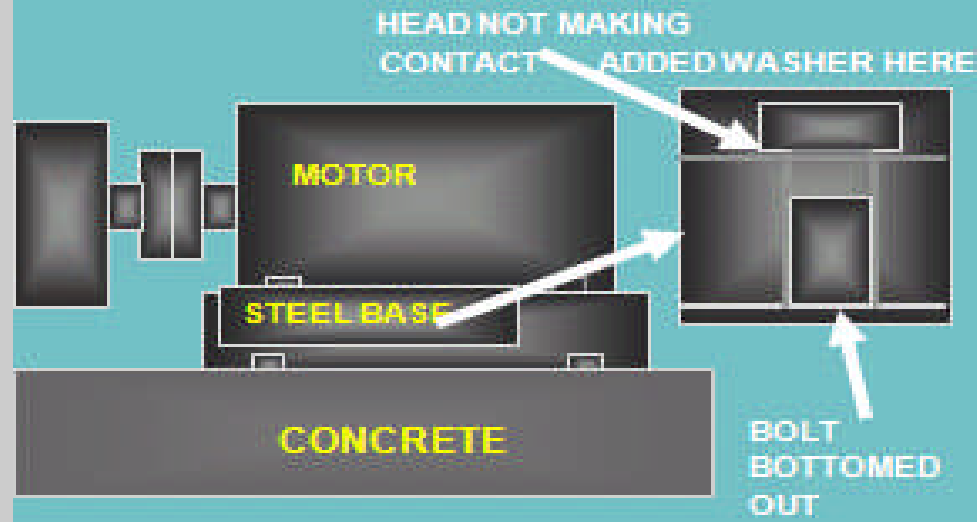

APPARENT COUPLE UNBALANCE IN A FAN THAT OPERATES BELOW 1st NATURAL FREQUENCY

POSSIBLE CAUSES

DISSIMILAR PEDESTAL STIFFNESSES

- WRONG PLACEMENT OF VIBRATION PICKUPS
- LOOSE BASE BOLTS
- PHASE REVERSAL WITHIN ONE PICKUP

- NOTE- IF THERE IS A LARGE COUPLE COMPONENT IN A FAN THAT OPERATES WELL BELOW ITS 1ST CRITICAL, THEN BE VERY SUSPICIOUS AND AVOID INSTALLING A COUPLE SHOT

EXAMPLE OF A LARGE FAN WITH APPARENT COUPLE UNBALANCE

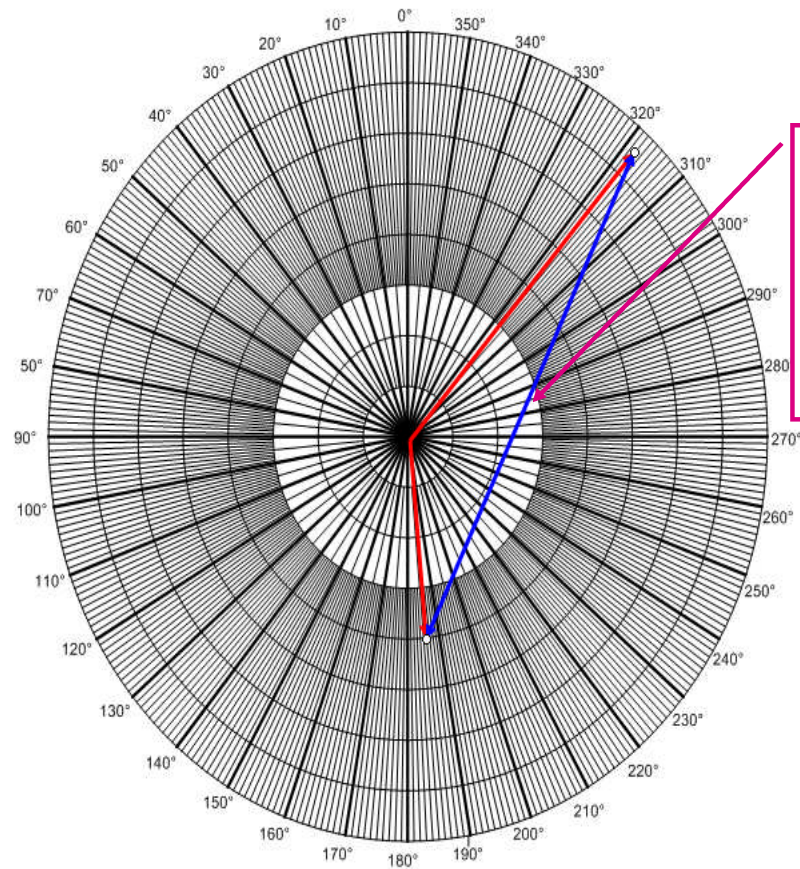

Vectors showed what appeared to be a large amount of couple unbalance

SOLUTION

- The large couple component raised the level of suspicion.
- The results of a previous balance person showed the response to be highly non-linear
- The base bolt tightness was therefore checked and all the bolts were all found to be significantly loose.
- The bolts were tightened, the couple component disappeared and the levels dropped to 1/4th their original values.
- Following bolt tightening, the fan was then easily balanced.

PLUNGER BOLT HOLDS BEARING TIGHT WITHIN HOUSING.

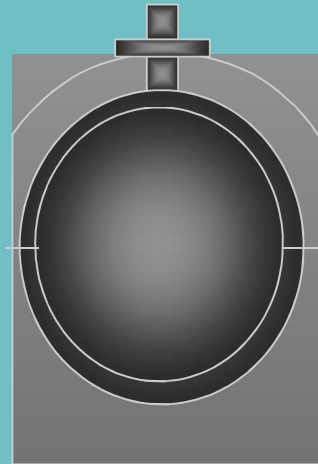

IF PLUNGER BOLT IS NOT TIGHT, THEN BEARING WILL MOVE RELATIVE TO HOUSING. THIS MOVEMENT RESULTS IN A NON-LINEAR SYSTEM. BALANCING IS VERY DIFFICULT, IF NOT IMPOSSIBLE IN THIS SITUATION.

LOOSE BEARING IN HOUSING COMPLICATES BALANCING

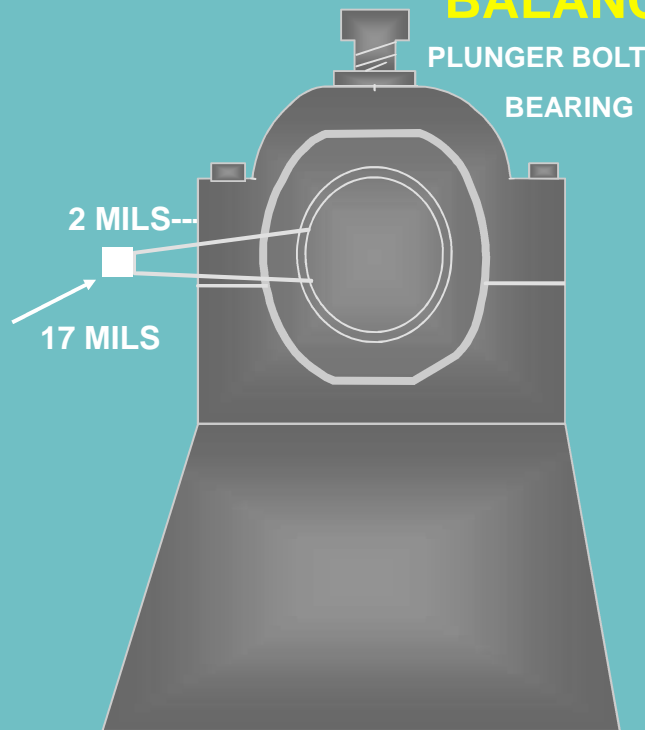

IF A BEARING IS LOOSE IN ITS HOUSING, A NONLINEAR SYSTEM IS CREATED AND BALANCING IS ALMOST IMPOSSIBLE.

CASE HISTORY

A LARGE ID FAN COULD NOT BE BALANCED. THE CASING LEVELS WERE SLIGHTLY OVER 2 MILS, HOWEVER, WHEN SHAFT STICK LEVELS WERE MEASURED, THE AMPLITUDE WAS GREATER THAN 17 MILS. SINCE THE SHAFT TO INNER BEARING CLEARANCE WAS ONLY 8 MILS, THIS MEANT THAT THE BEARING HAD TO BE MOVING IN THE HOUSING. WHEN THE PLUNGER BOLT WAS TIGHTENED, THE CASING LEVEL ROSE TO 21.5 MILS. AFTER THE TIGHTENING, THE FAN WAS EASILY BALANCED.

8: When balancing a rotor and the phase suddenly shifts 180 degrees, then this is a sign that the rotor may be loose. Case History- While balancing a large centrifuge, with a strobe light the vibration vector changed from 3 mils at a given phase angle to approximately that amount 180 degrees out. The change was instantaneous. It was discovered upon examination that the tapered fit of the shaft and bowl assembly was loose.

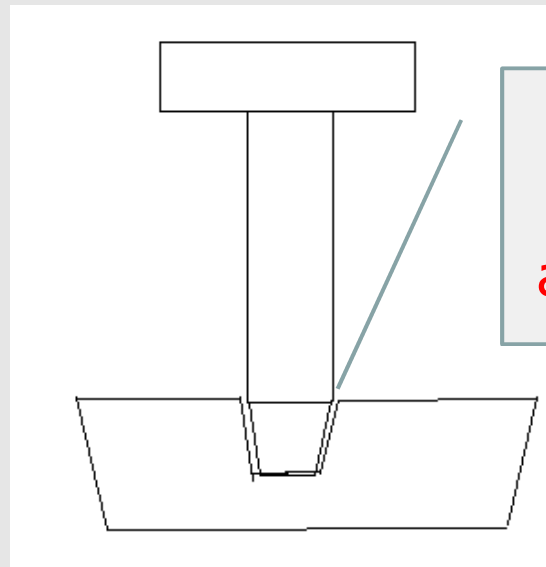

**Loose fit
between bowl
and drive shaft**

LARGE POWER GENERATION GAS TURBINES

- A different sort of an animal
- Balancing Cross effects are often much larger than direct influence.

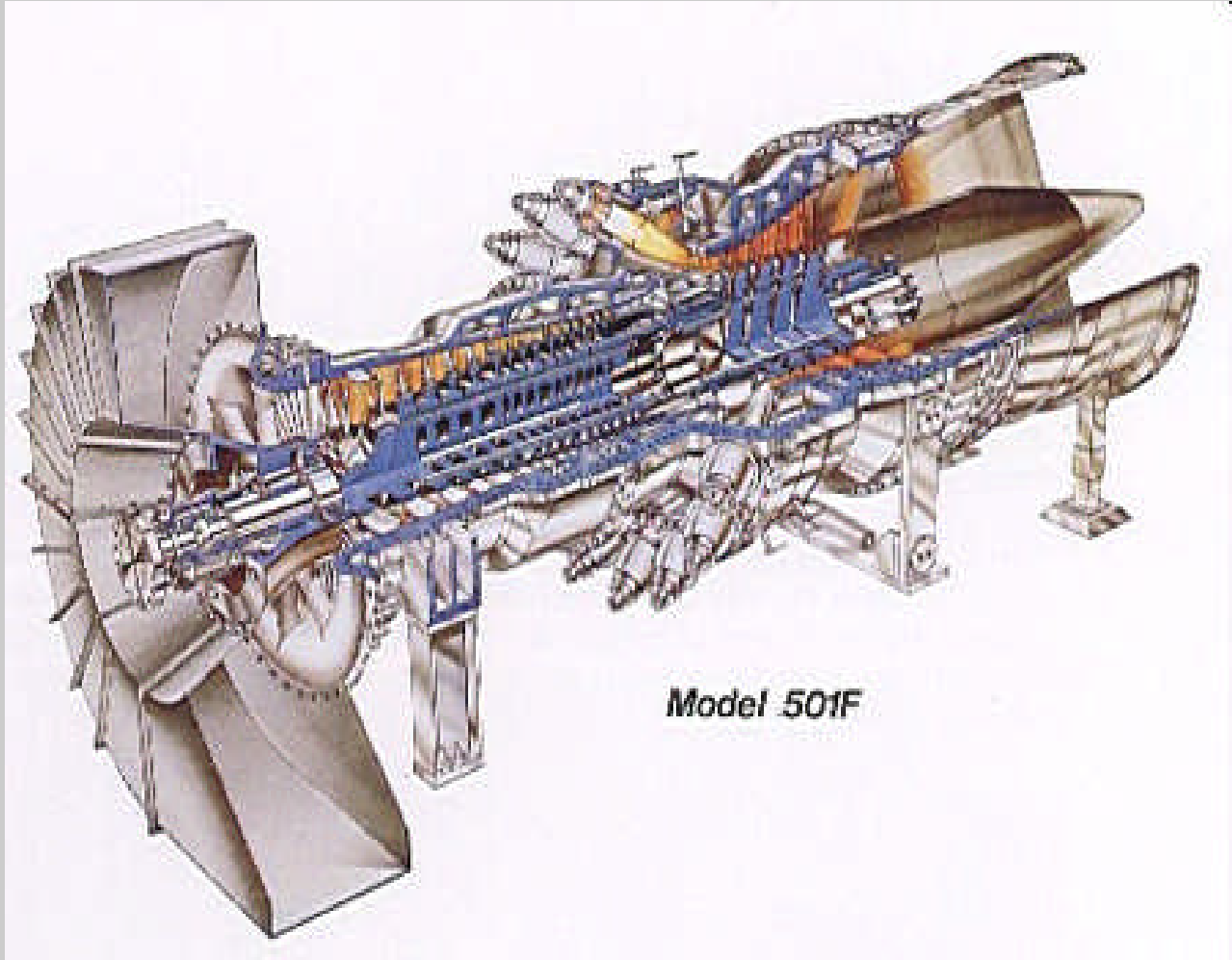

Model 501F

DIRECT AND CROSS EFFECT WESTINGHOUSE 100 MW 501 GT

Exhaust End Shot on Exhaust End 18.6 oz/mil 25 Degree lag

Exhaust End Shot on Compressor End 4.7 oz/mil 46 degree lag

Compressor end shot on Compressor end 18 oz/mil 353 degree lag

Compressor end shot on Exhaust end 8.6 oz/mil 30 degree lag

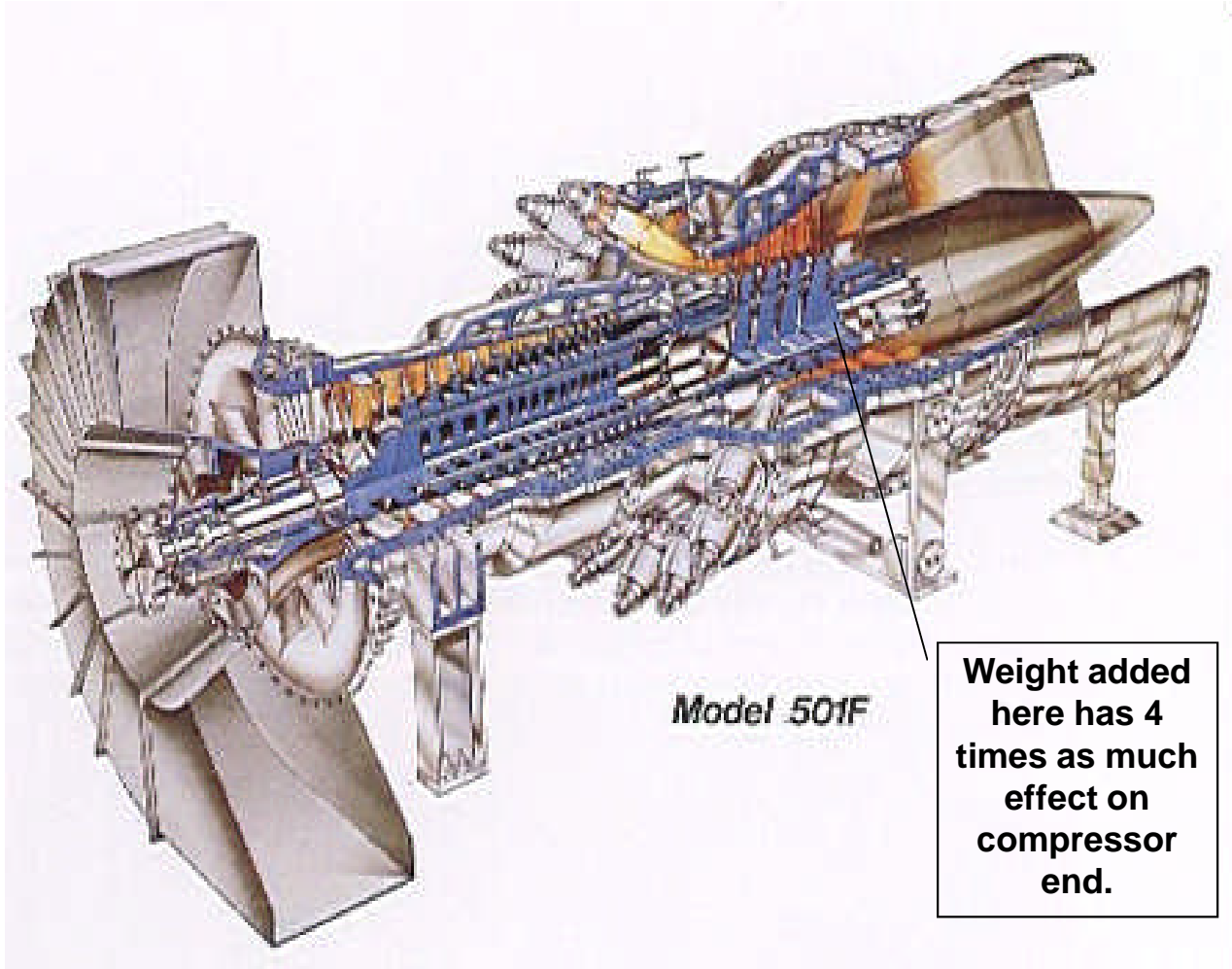

Model 501F

Weight added here has 4 times as much effect on compressor end.

ALIGNMENT

1: When aligning gear boxes with sleeve bearings, beware of pop up pinions. Their contribution to the shaft alignment does not show up when you take hot alignment readings. Their effect also does not show up on laser alignment systems mounted on the cases or via optical means. Source: Charlie Jackson

Case History: A speed increaser Gearbox at a refinery had an input of approximately 1200 RPM and an output of 9600 RPM. **The amount of upward movement of the pinion was greater than the tolerable misalignment for the short high speed coupling.** The amount of shaft movement vertical and horizontal was included in the alignment settings. The unit operated for several years without any problem or excessive coupling wear.

2: When aligning turbines setting on condensers, beware of vacuum draw down. It can be a much greater effect than thermal growth.

1- A large turbine was experiencing oil whip. As the unit was brought to speed, at almost exactly twice the critical speed, an approximately $\frac{1}{2}$ running speed component appeared as the speed continued to increase, the frequency of the instability remained locked at the critical speed frequency. A complex glycol proximity probe alignment system was installed to measure the bearing movement. When condenser vacuum was applied there was a .016" difference in elevation between the No. 2 and No. 3 bearings.

500 MW TURBINE OIL WHIRL-WHIP

- When turbine would be shut down, if it was not started up within 2-3 hours, it could not be started up for two days because of excessive vibration.
- SOUNDS LIKE XENON POISONING ON A NUCLEAR REACTOR

MACHINE LAY OUT

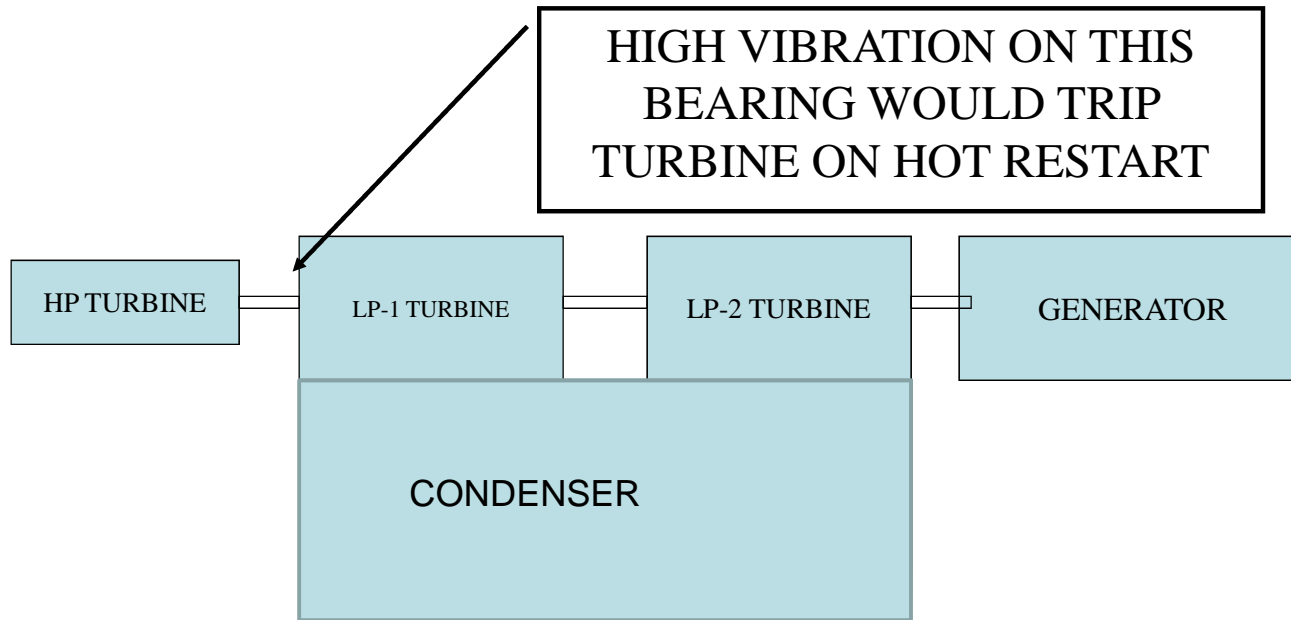

VIBRATION SPECTRUM

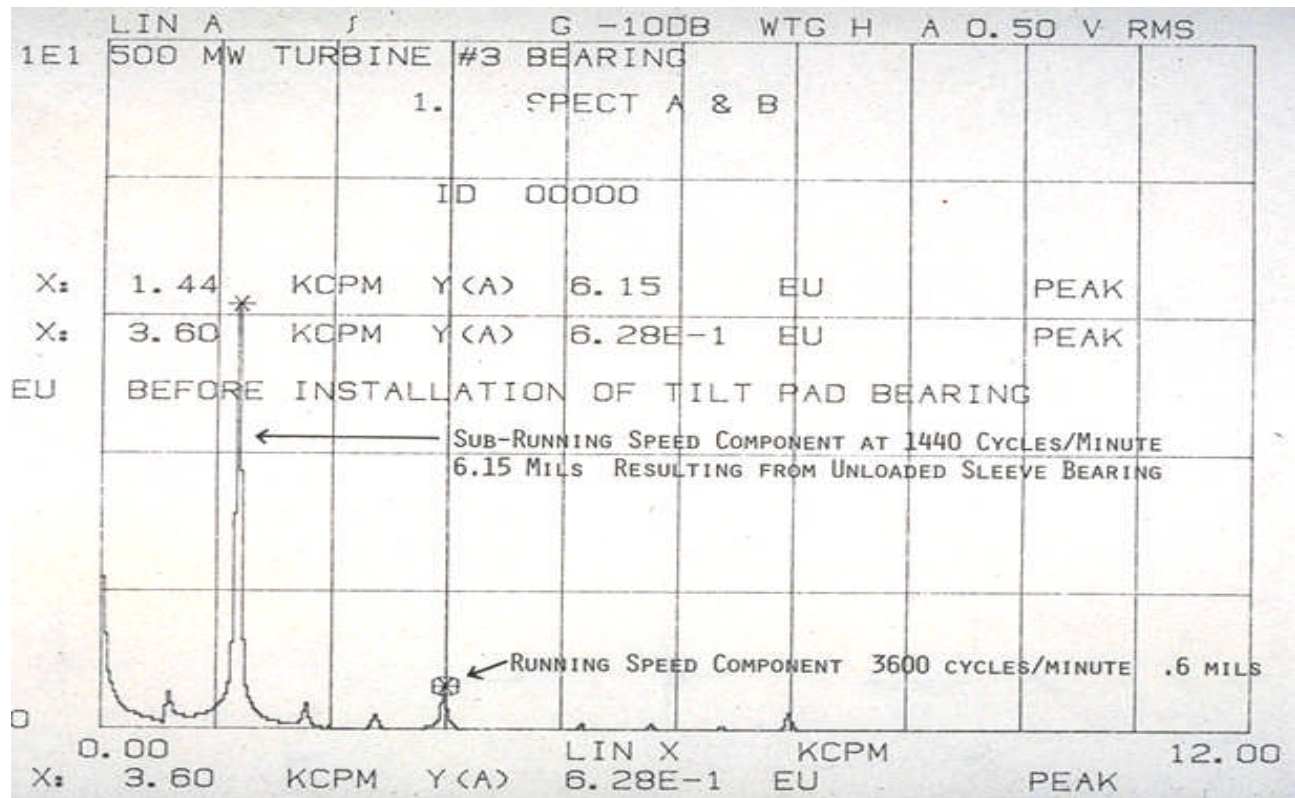

MAP PLOT

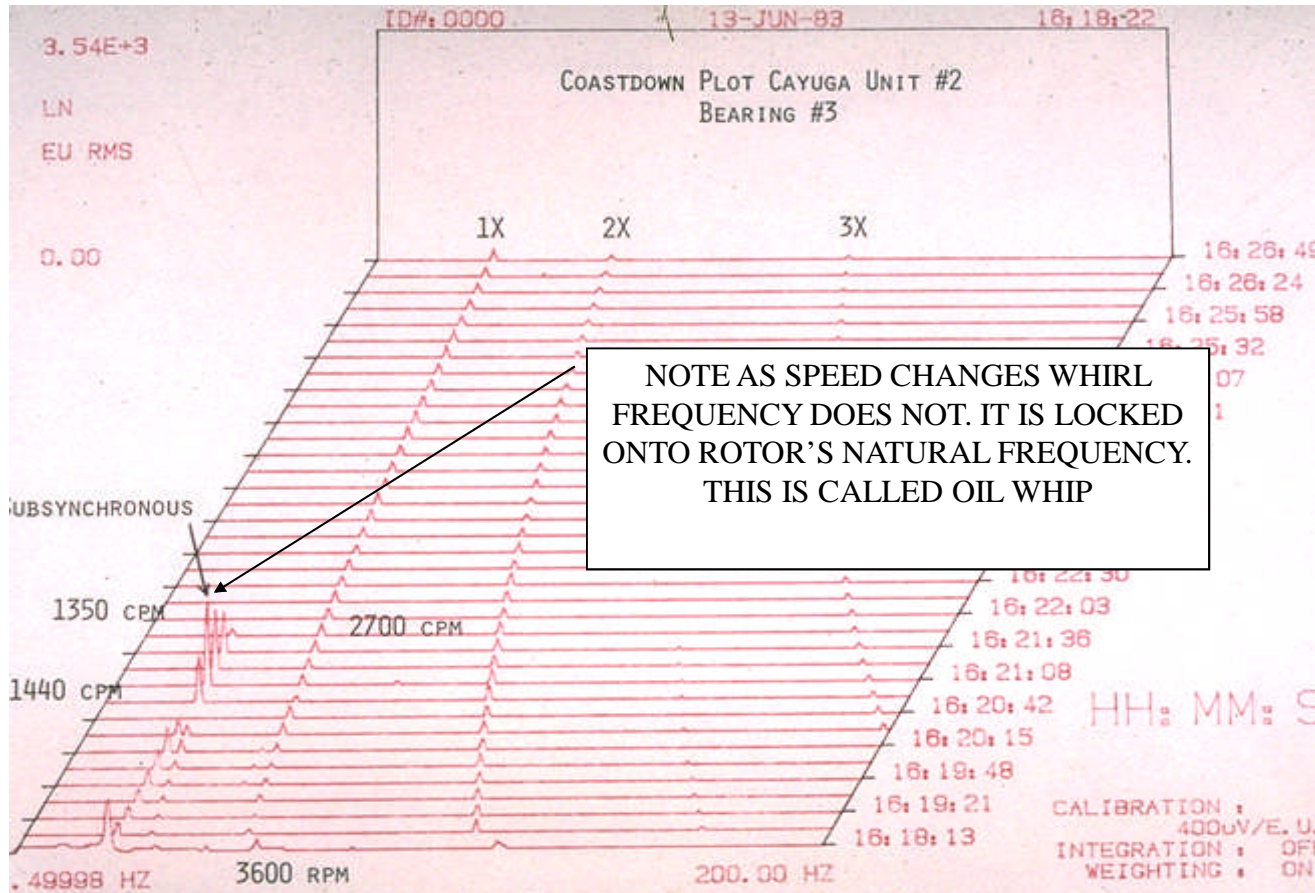

ALIGNMENT TEST SYSTEM

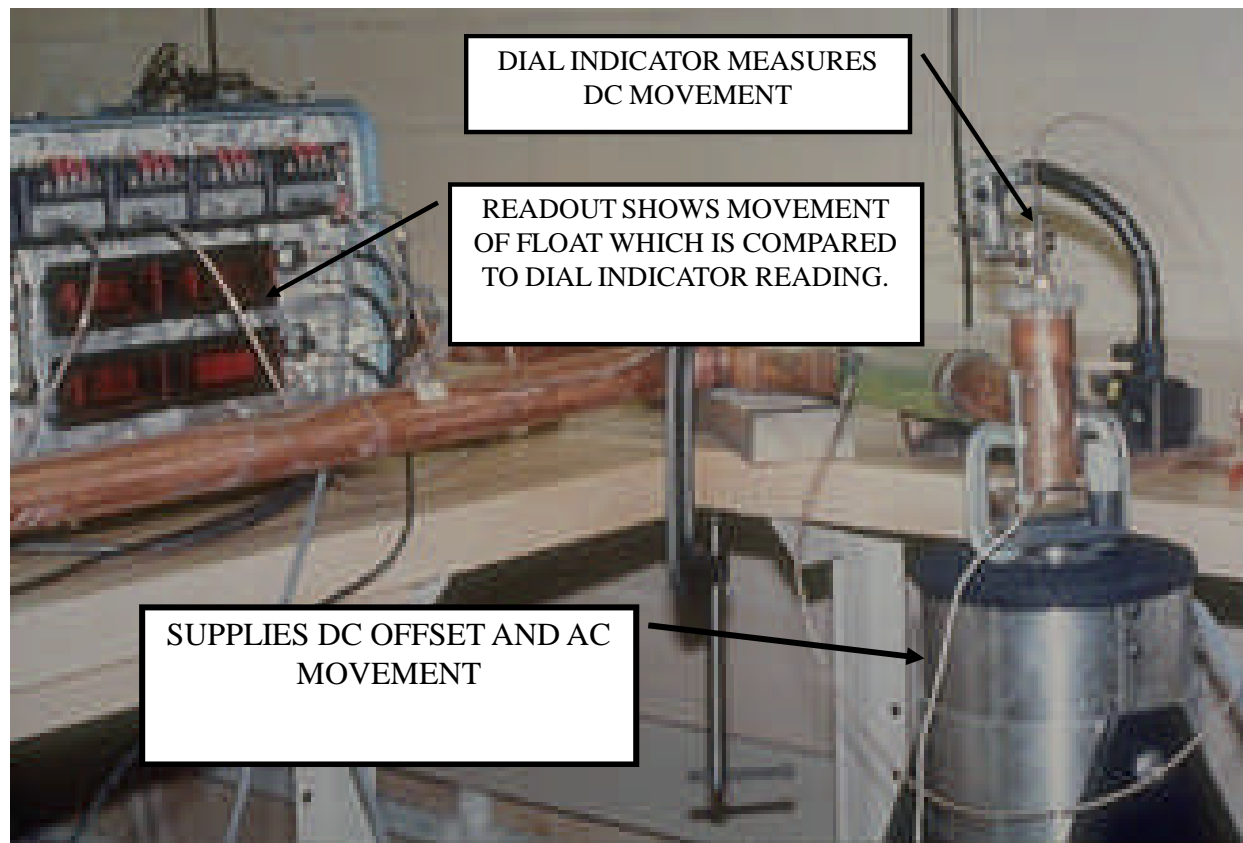

HEART OF SYSTEM

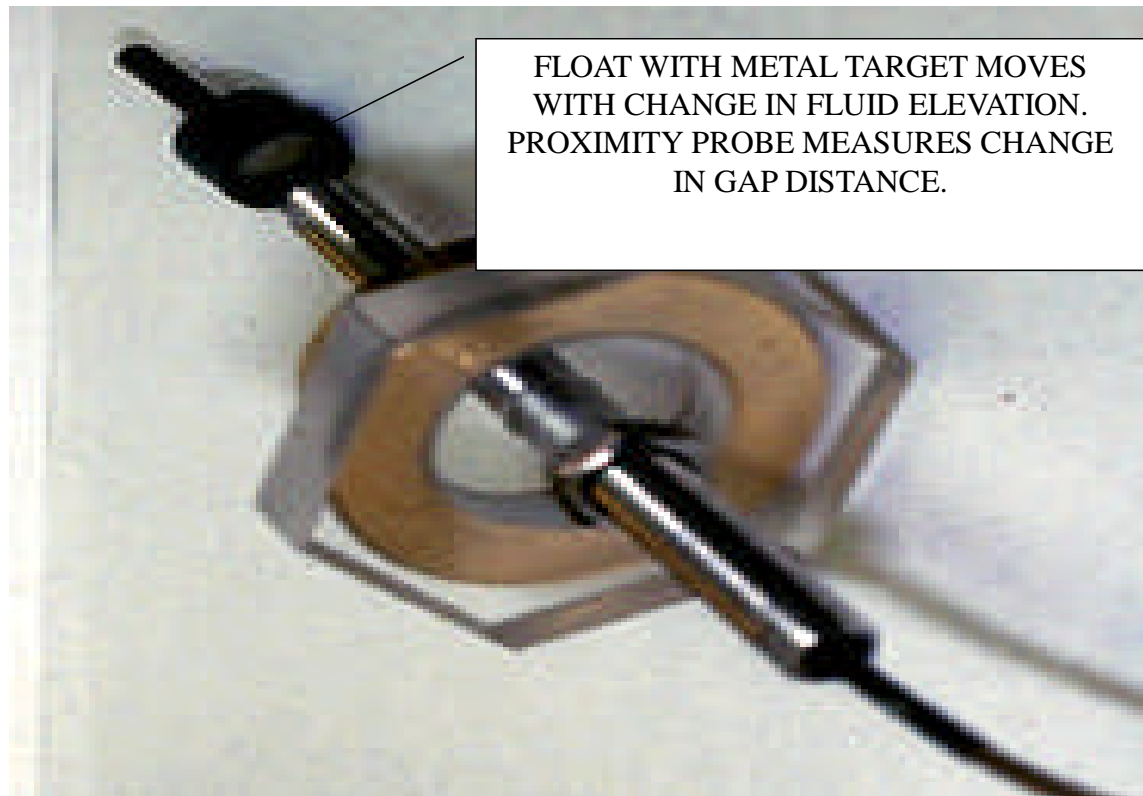

SETUP ON TURBINE



REFERENCE PICKUP TO ACCOUNT FOR FLUID EXPANSION OR LOSS

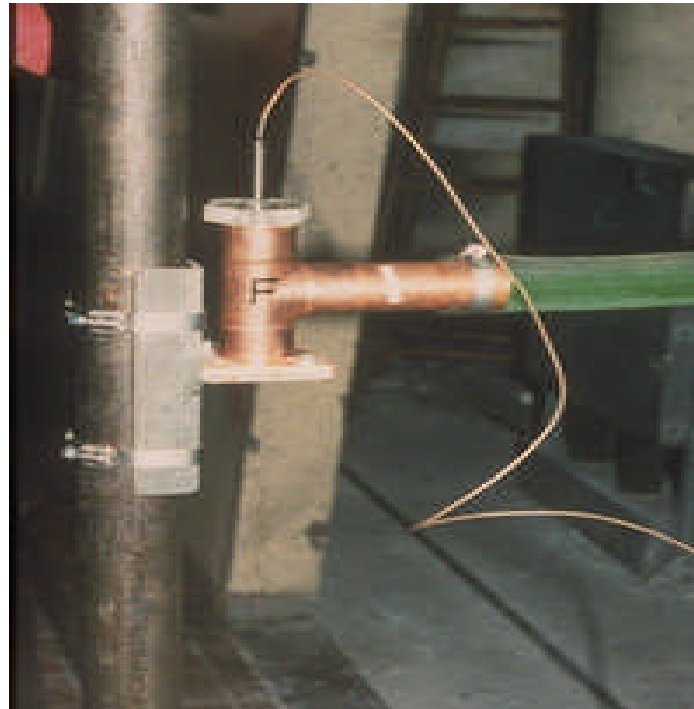

TEST RESULTS

MILS MOVEMENT VERSUS VACUUM



DISCUSSION

VACUUM DRAW DOWN COMBINED WITH THERMAL DIFFERENTIAL GROWTH UNLOADED BEARING CAUSING IT TO GO UNSTABLE. WHEN BOTH WERE COLD, IT WOULD BE STABLE. WHEN BOTH WERE HOT, IT WOULD BE STABLE. THE PROBLEM OCCURRED AFTER A TRIP, WHEN THE THINNER LP SECTION WOULD COOL DOWN QUICKER THAN THE THICK HP SECTION. THIS DIFFERENTIAL ADDED TO THE VACUUM DRAW DOWN WAS TOO MUCH.

BEARING METAL TEMPERATURE CONFIRMED THIS FINDING.

SOLUTION

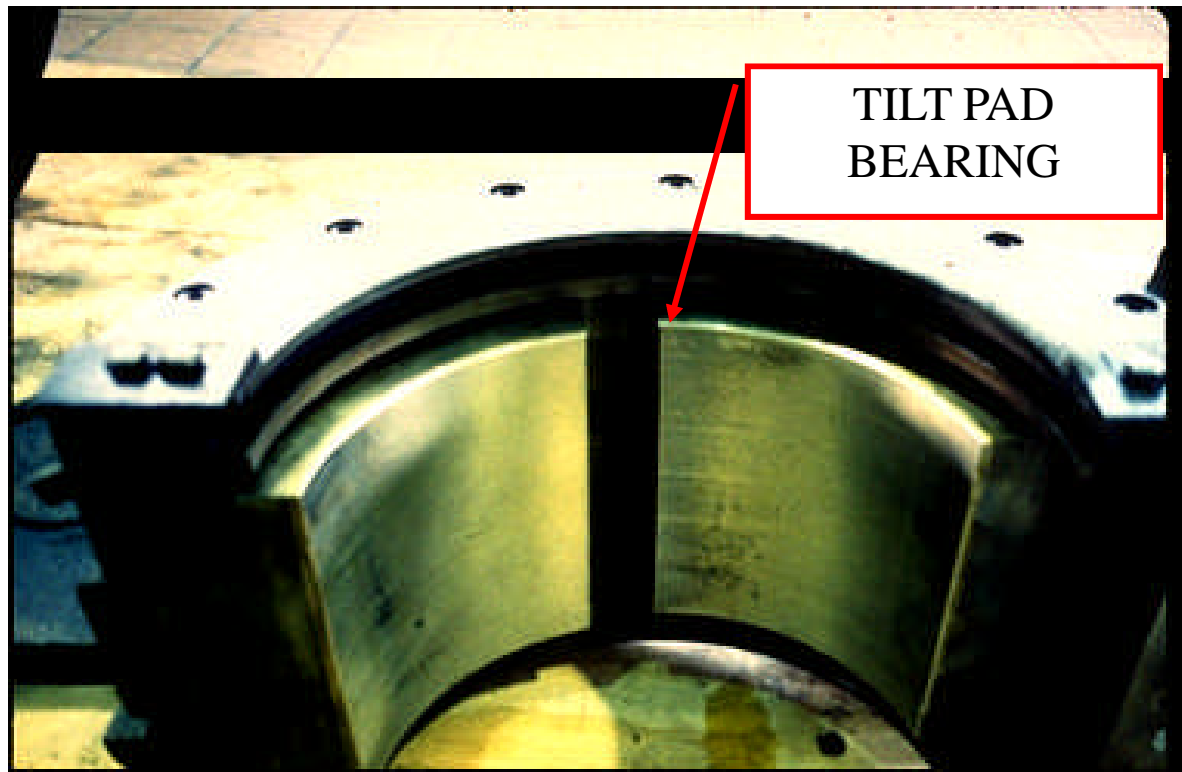

FINAL RESULTS

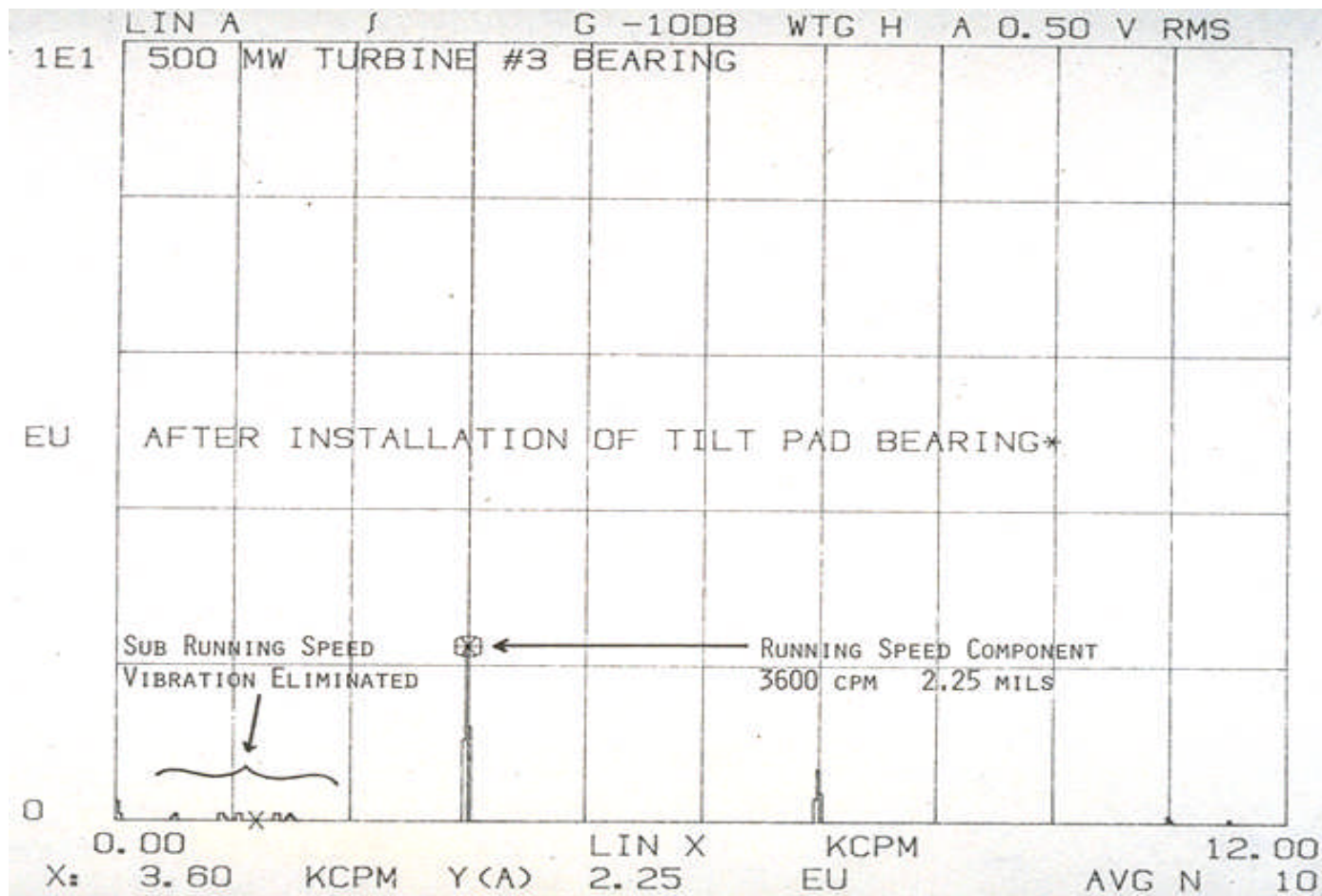

. Case 2- Two boiler feed pumps were having vibration problems and wearing out their gear couplings. When dynamic alignment was performed between the turbines and pumps, it was discovered that when vacuum was pulled on the turbines that they dropped .020" relative to the pumps.

COUPLINGS BEING DESTROYED ON STEAM
GENERATOR FEED PUMP AT NUCLEAR
STATION



VIBRATION SPECTRUM

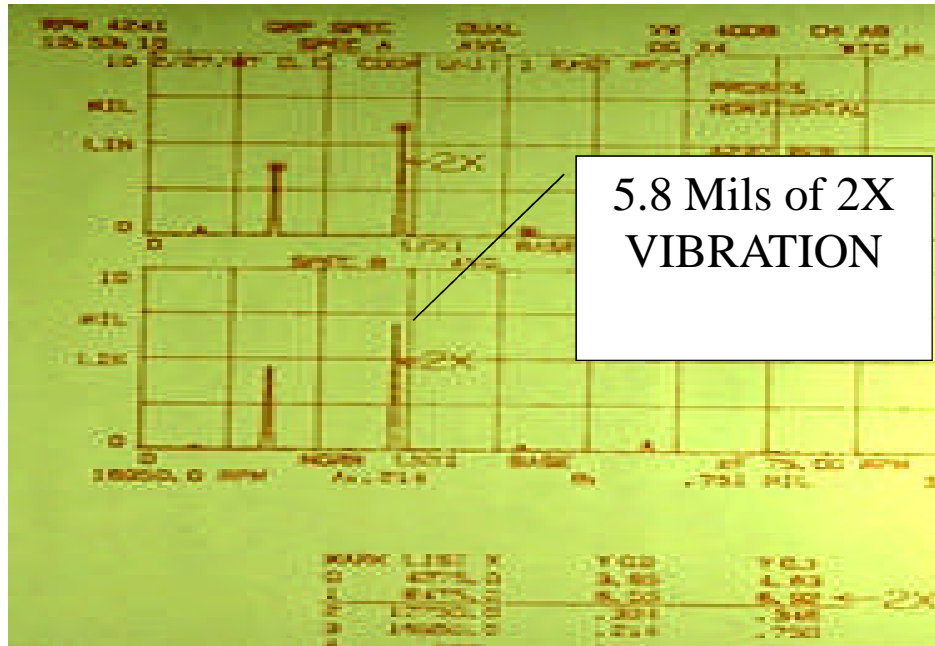

ORBIT DISPLAY

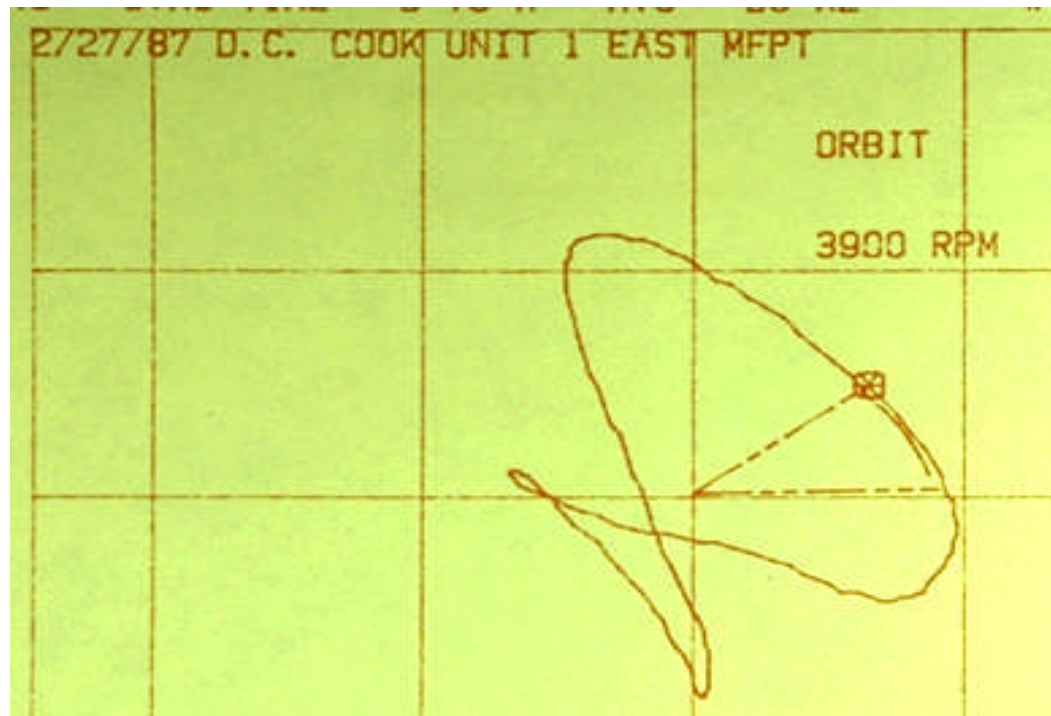

PROBLEM-ALIGNMENT SPEC. WAS WRONG

- Vacuum draw down was 20 mils
- Even though pump was center mounted, it was growing.
- Turbine was growing unevenly

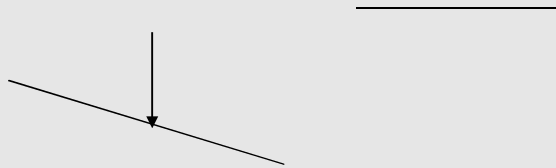

PUMP NEEDED TO BE SET LOW RATHER THAN HIGH

CHILLER TURBINE WAS DESTROYING BEARINGS

UPPER HALF OF BEARINGS WERE FAILING BY FATIGUE



MACHINE SETUP

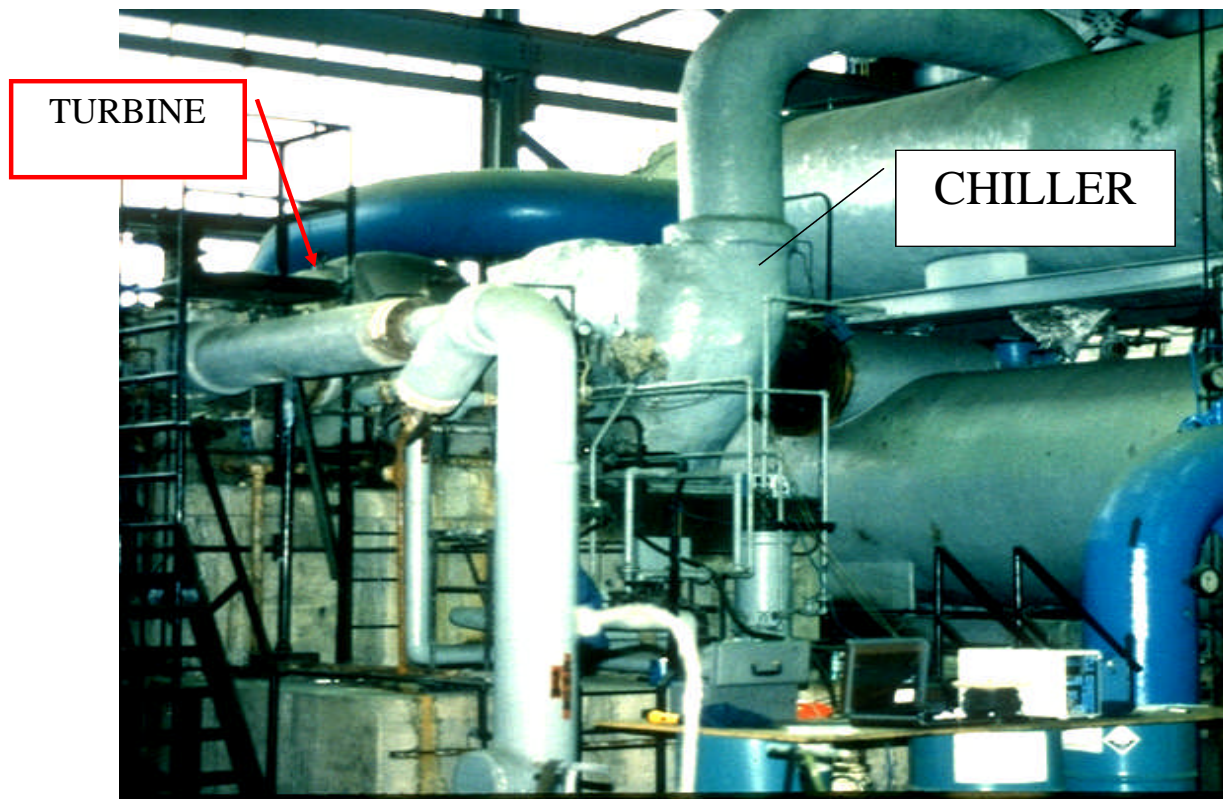

MONITORING OF ALIGNMENT

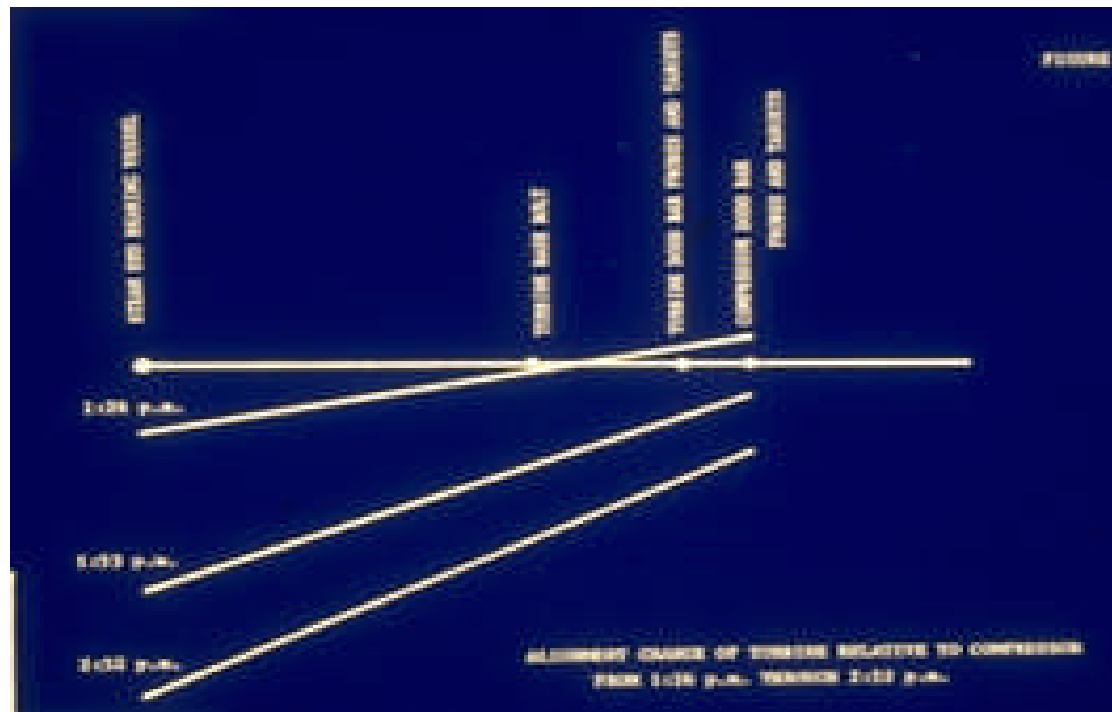

MACHINE LAYOUT

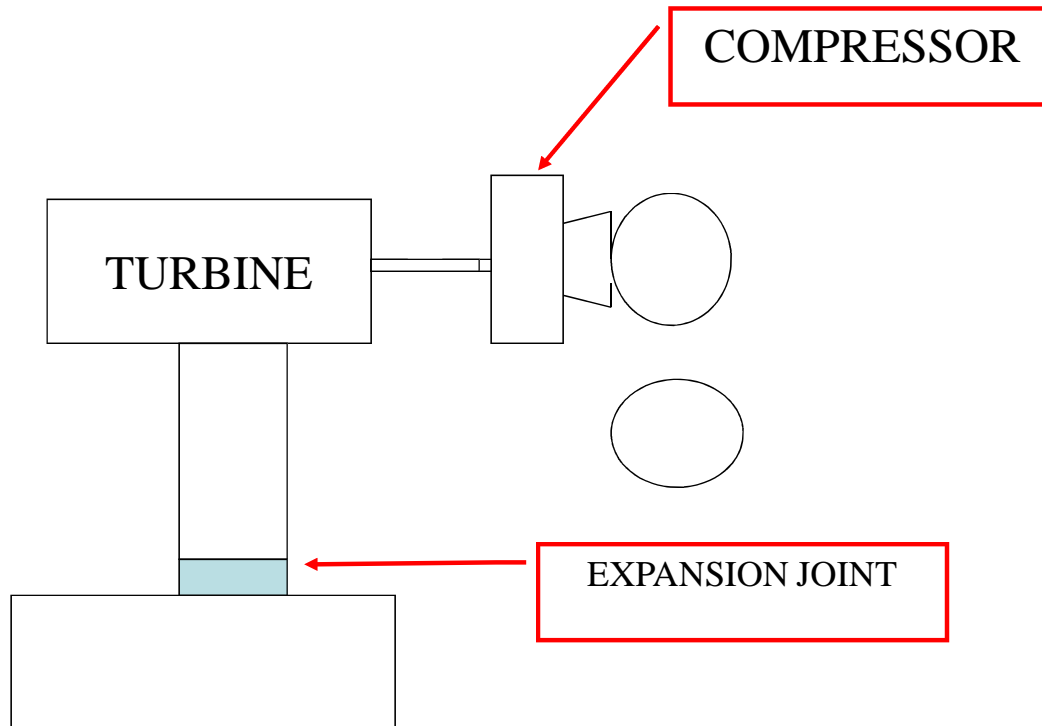

TEST RESULTS

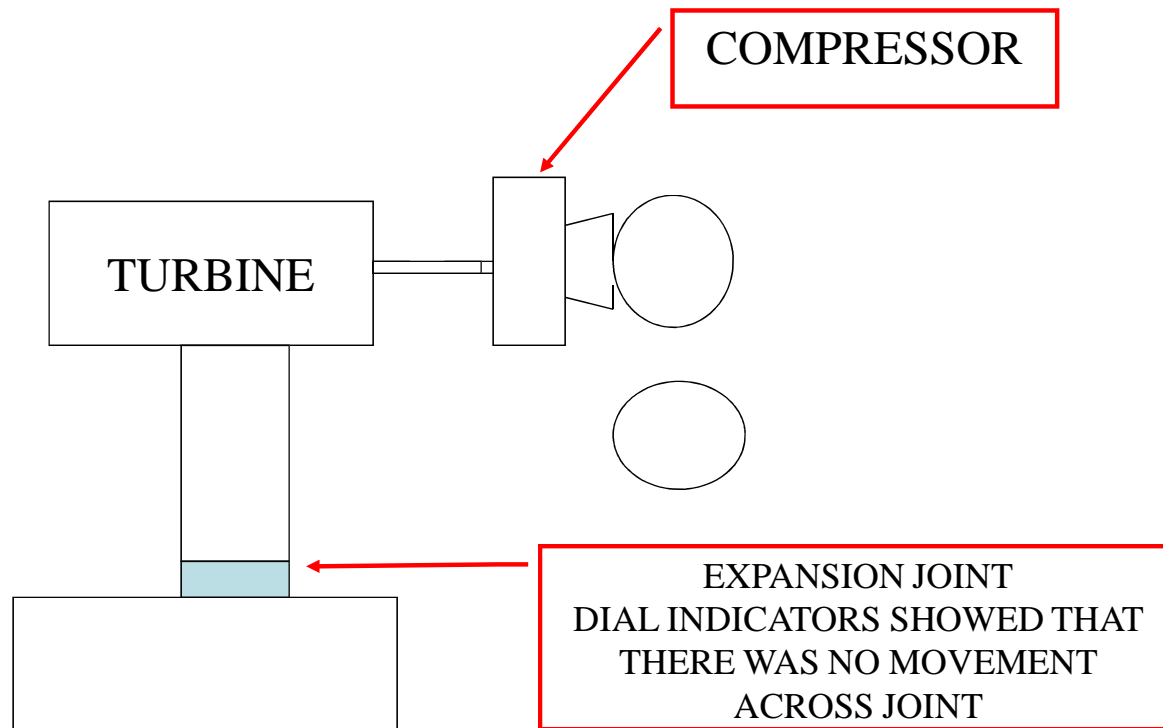

ACTUAL PROBLEM

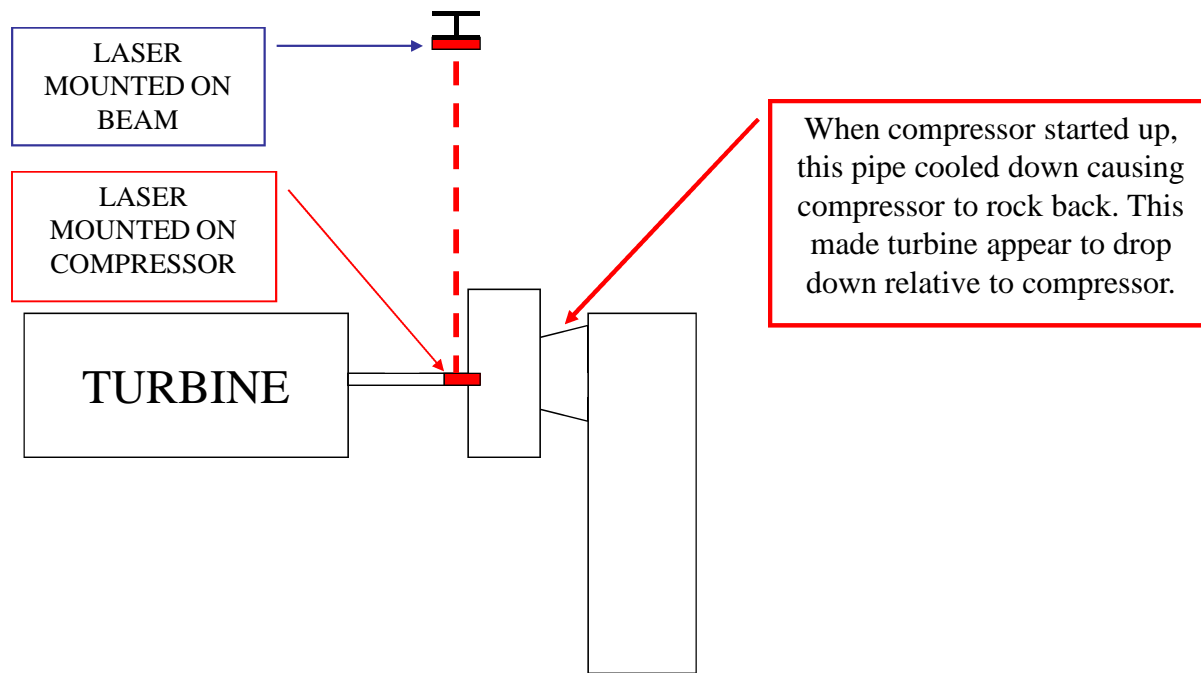

3: If a machine operates well for a few weeks following an overhaul, then 2X running speed shows up in the proximity probe spectrum, suspect a locked coupling. The amount of misalignment may not have changed. The problem is that either the coupling grease has broken down or escaped from the coupling.

PUMPS

LOMAKIN EFFECT

A LARGE PUMP WOULD OPERATE FOR A YEAR OR SO, THEN THE VIBRATION WOULD GET HIGH. THIS HAPPENED REPEATABLY. AFTER THE OVERHAULS, THE PUMP WOULD OPERATE OK FOR A FEW MONTHS. **THE ROTOR WAS NEVER FOUND TO BE OUT OF BALANCE.**

PUMPS

1: Pump seals can act like bearings and stiffen the shaft to the point that the critical speed will be pushed out beyond the operating speed. When the seals wear, the critical speed may move back into the operating range. This seal stiffening phenomenon is often referred to as the Lomakin effect.

Case History- A large feed pump had a history of operating well after it was overhauled with new seals, but after time the running speed vibration would increase. A system was set up to monitor the amplitude and phase as the pump was brought to speed. It was discovered that after the seals experienced wear that the pump was operating just below a rotor critical speed.

TEST RESULTS

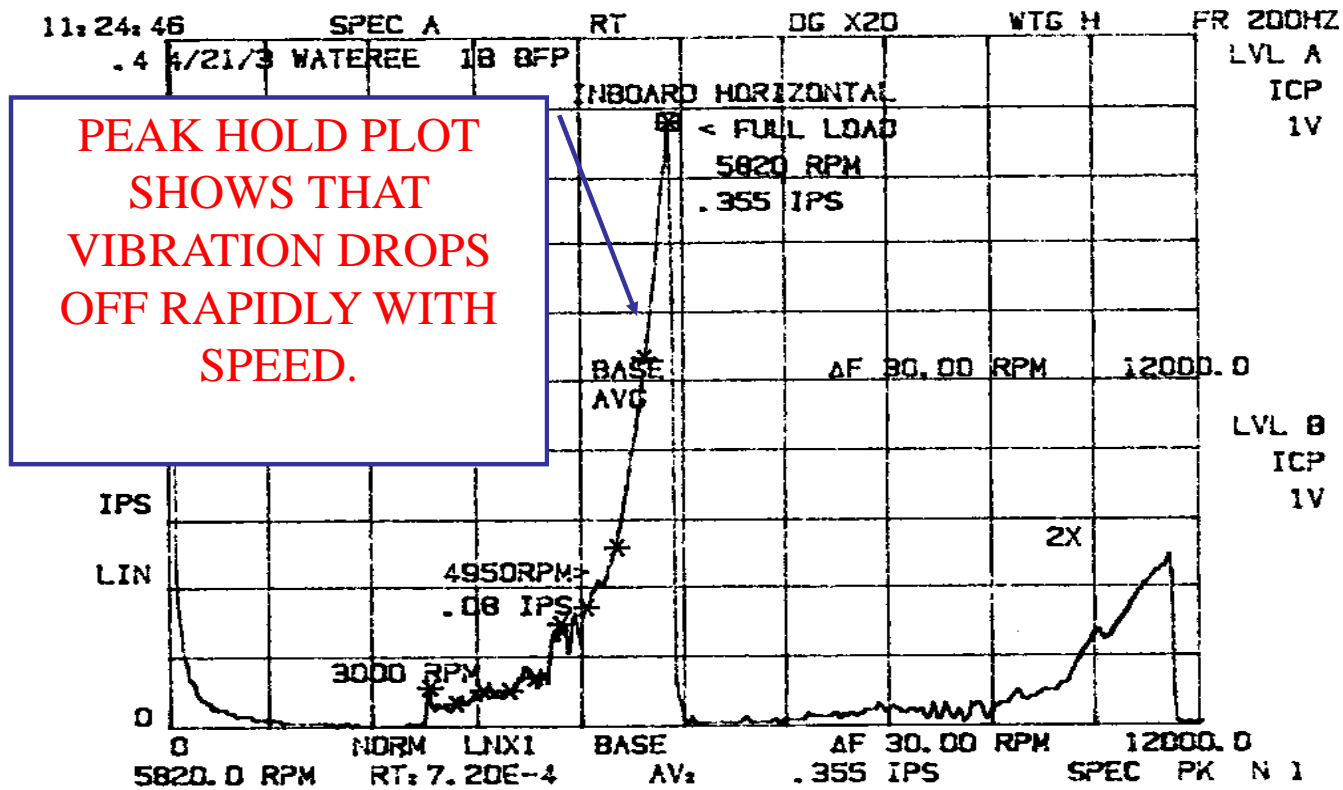

LOMAKIN EFFECT

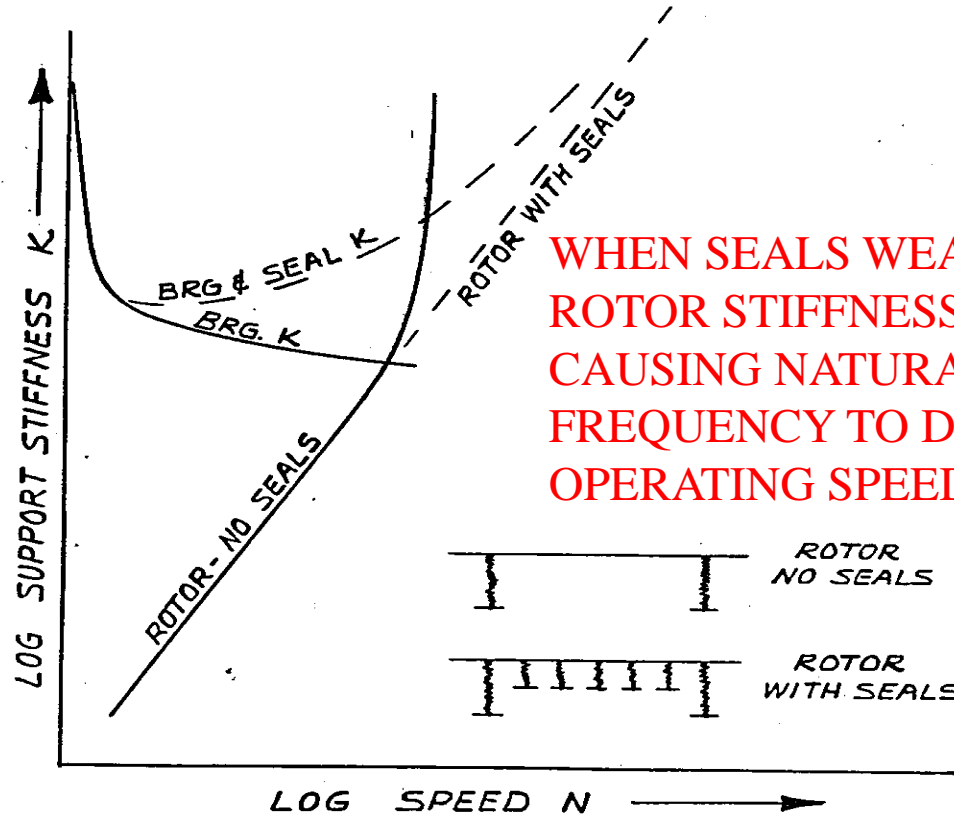

2: Pump seals can unload the bearings making them unstable or reduce their damping. Running speed levels will be much higher than normal and will be unstable. Due to the low loading, even though the vibration response is high, the machine can often operated indefinitely.

Case History- A steam generator feed pump at a nuclear power plant had above normal levels of vibration present on its proximity probes, but there was never any damage to the bearings. An analysis of the pump was performed and it was determined that the seals were supporting the shaft to the point that the bearings were only carrying a small fraction of the rotor's weight. Collaborated on this case with Malcolm Leader who did the rotor analysis.

3: When analyzing pumps, measure the suction pressure, the discharge pressure, calculate the total developed head then look at the pump head curve before doing anything else. Case History 1- Three identical pumps were operating side by side. One of the pumps was failing bearings every few weeks. A study of the suction and discharge pressure showed that the pump was operating at near shut off head conditions. The problem was that during recirculation conditions, the flow was way too small due to the presence of a one inch orifice plate instead of the required three inch orifice plate. Replacement of the orifice plate solved the bearing failure problem.

FLOW IS BALANCED SO THERE SHOULD BE NO THRUST

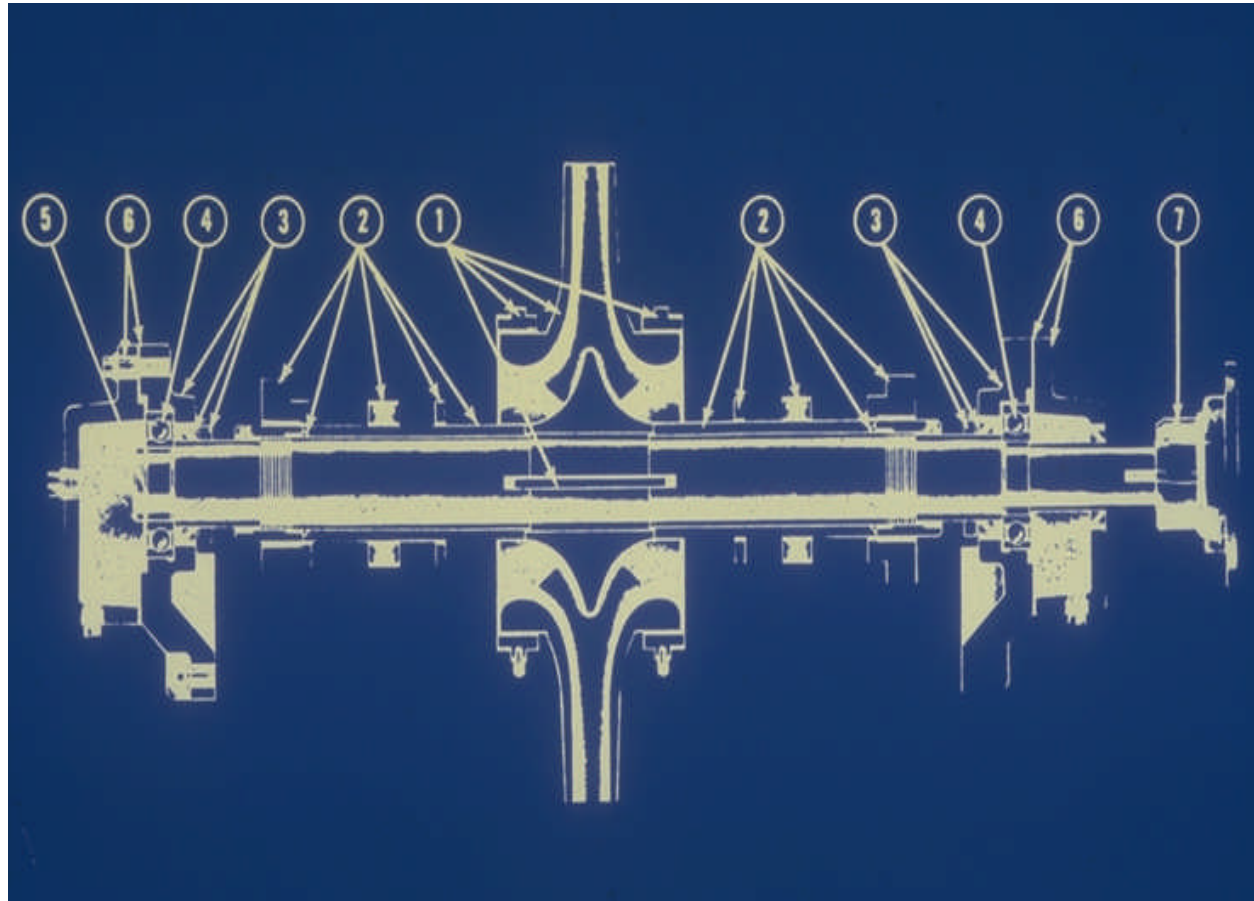

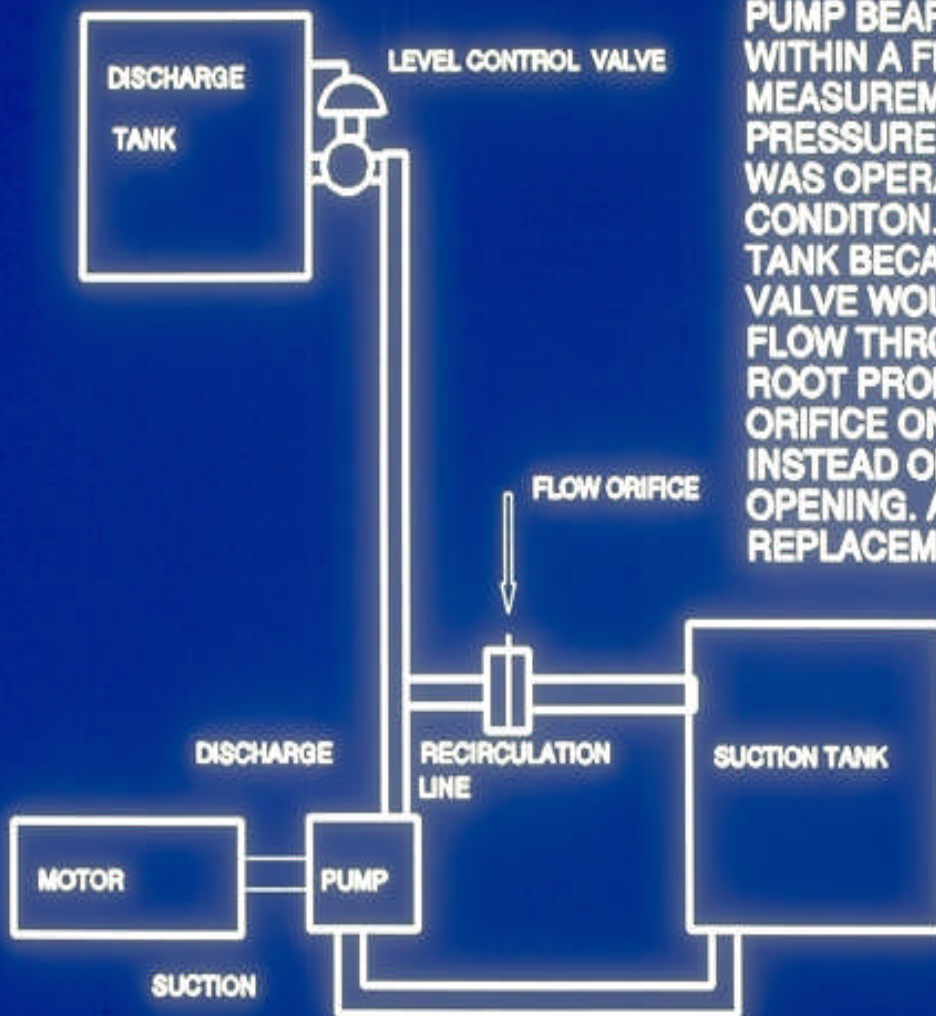

PUMP BEARINGS WERE FAILING WITHIN A FEW WEEKS. MEASUREMENT OF DISCHARGE PRESSURE SHOWED THAT PUMP WAS OPERATING IN DEAD HEAD CONDITON. WHEN DISCHARGE TANK BECAME FULL, CONTROL VALVE WOULD SHUT, FORCING FLOW THROUGH ORIFICE. THE ROOT PROBLEM WAS THAT THE ORIFICE ONLY HAD A 1" OPENING INSTEAD OF THE DESIGNED 3" OPENING. AFTER ORIFICE REPLACEMENT, FAILURES ENDED.

2- Several large circulating water pumps had high levels of broad band vibration followed by failure of the cases and impellers. It was found that the discharge pressure was one third of the design point, meaning that the pumps were operating in a run out condition. The problem was that at times only one pump was in operation instead of the two pumps that were considered in the initial design.

4: If multiple pumps are in the same header, then if one pump is dominate, then it will force the weaker pump back on its flow head curve.

5: Vertical pumps have a high incidence of resonance problems. Always test for resonance in the direction in line with the discharge line and in a direction 90 degrees out from that orientation. Discharge lines can stiffen the pump and the cutout that allows the coupling to be removed can weaken the structure. **The combined effect of the discharge line and access hole cutout results in vastly different natural frequencies in the two orthogonal directions.** The result can be 20 mils vibration in one direction and 2 mils in the other direction.



VERTICAL PUMP BENDING MODE NATURAL FREQUENCY SOLVED BY INSTALLING STIFFENERS TO ALTER NATURAL FREQUENCY

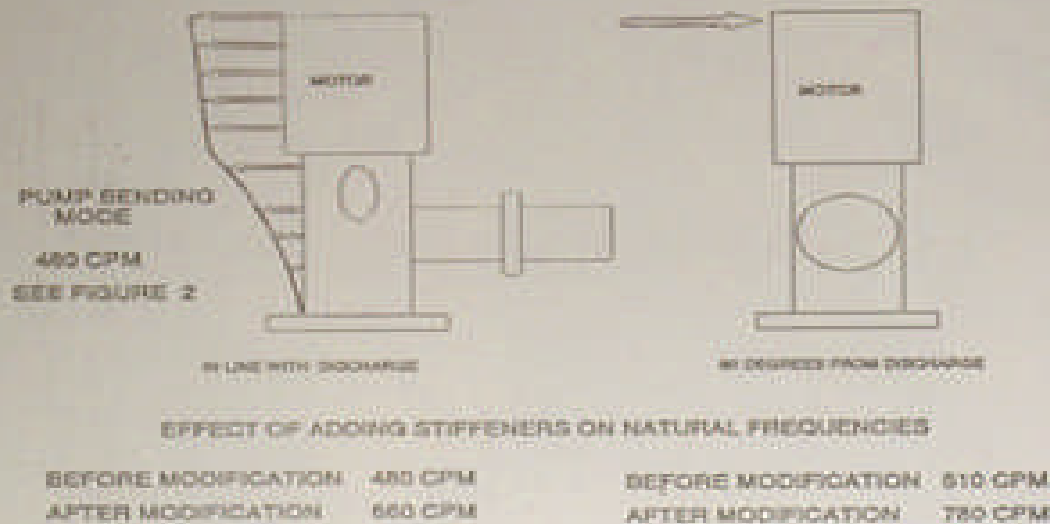

NATURAL FREQUENCY OF LARGE VERTICAL PUMP IN LINE WITH DISCHARGE

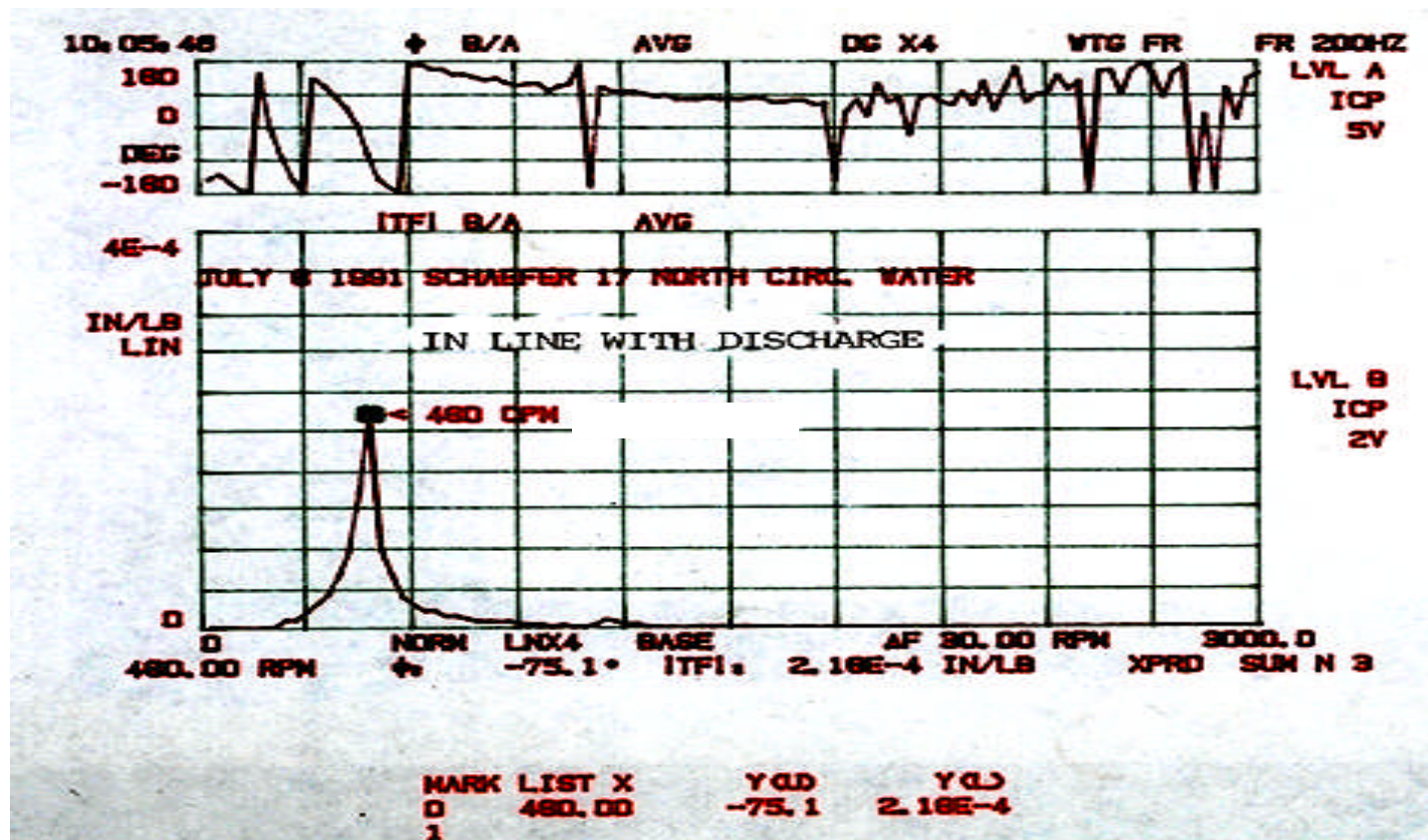

90 DEGREES OUT FROM DISCHARGE

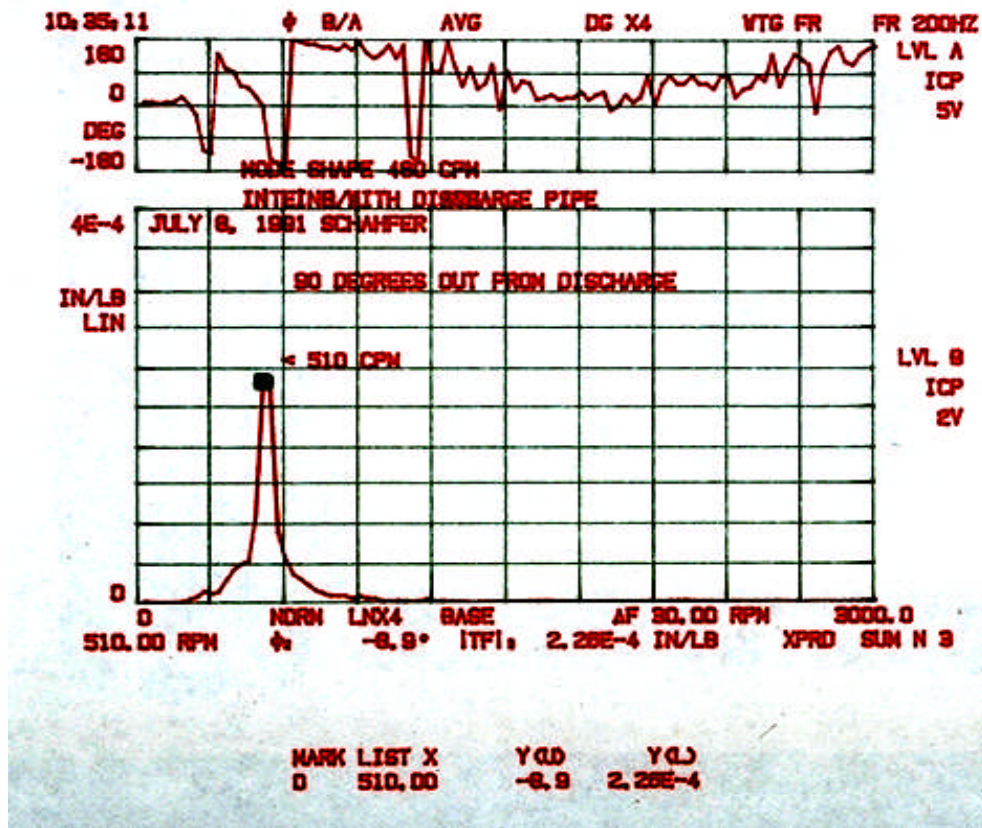
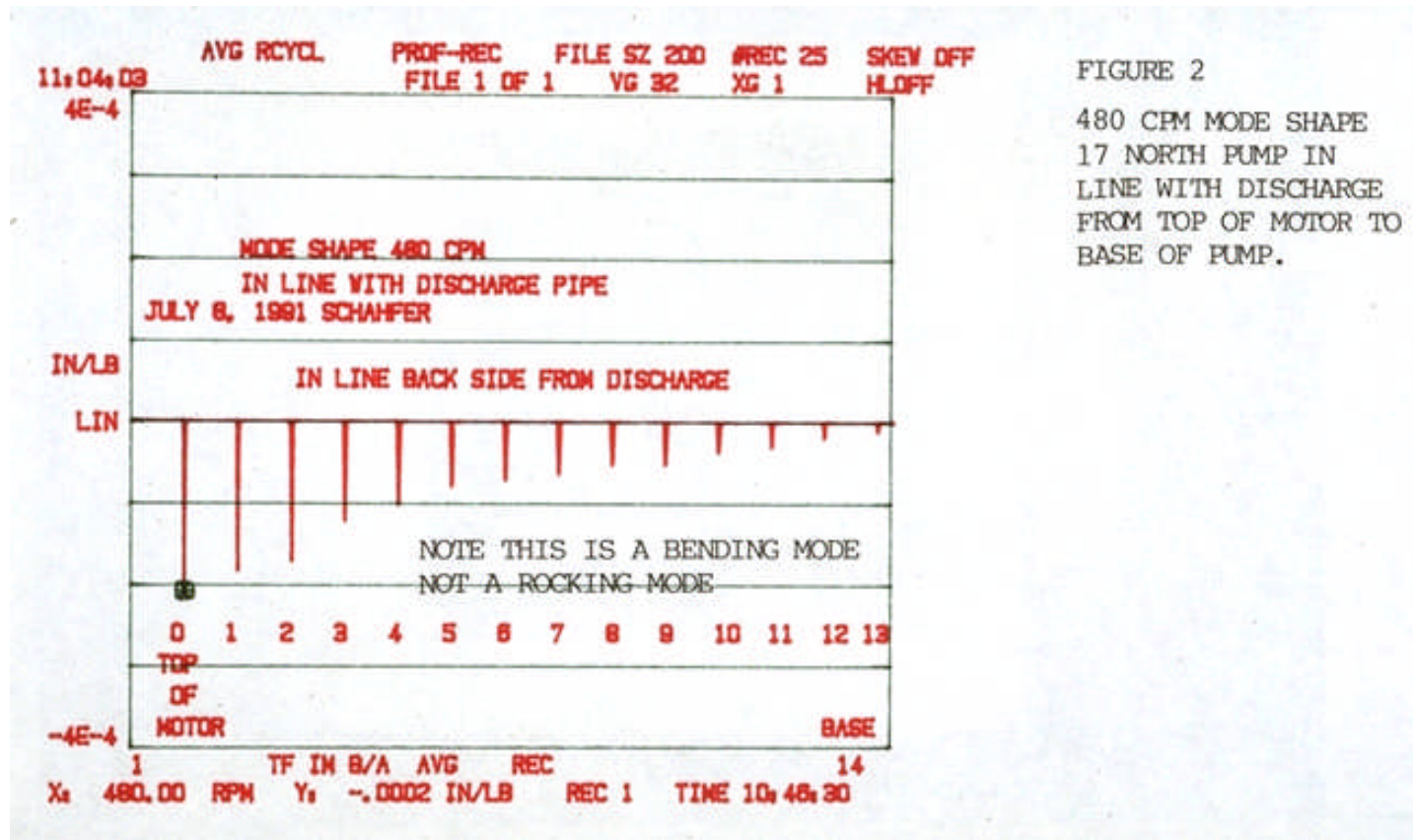

FIGURE 3
FREQUENCY RESPONSE OF
17 NORTH PUMP 90 DEGREES
OUT FROM DISCHARGE PUMP.

MODE SHAPE OF 480 CPM MODE



AMPLIFICATION FACTOR CALCULATION USING LOG DEC APPROACH

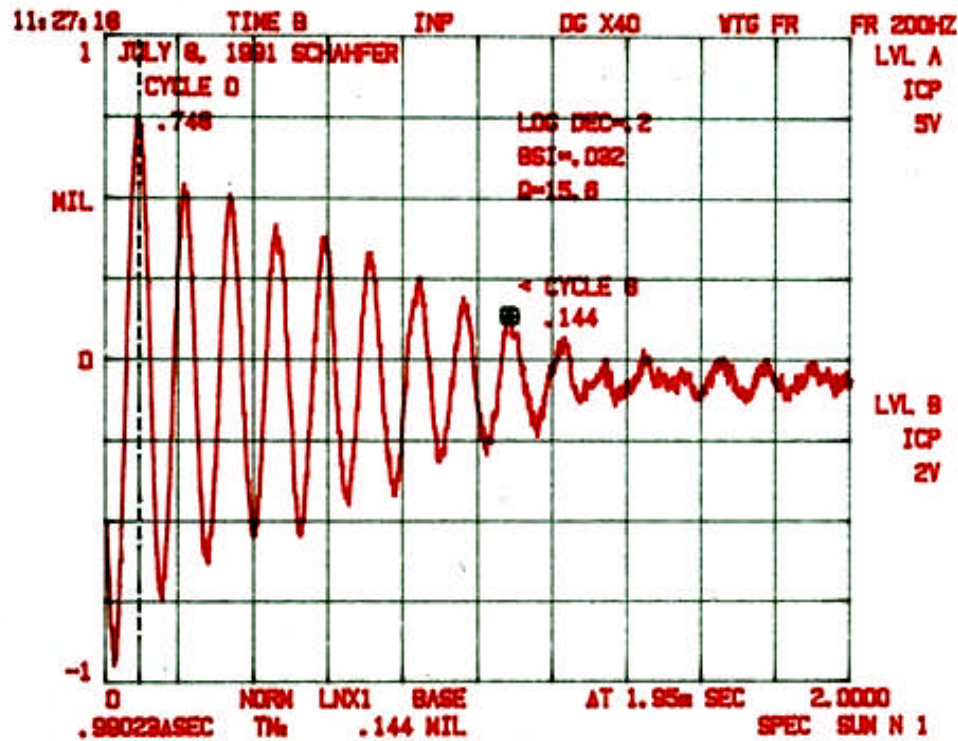
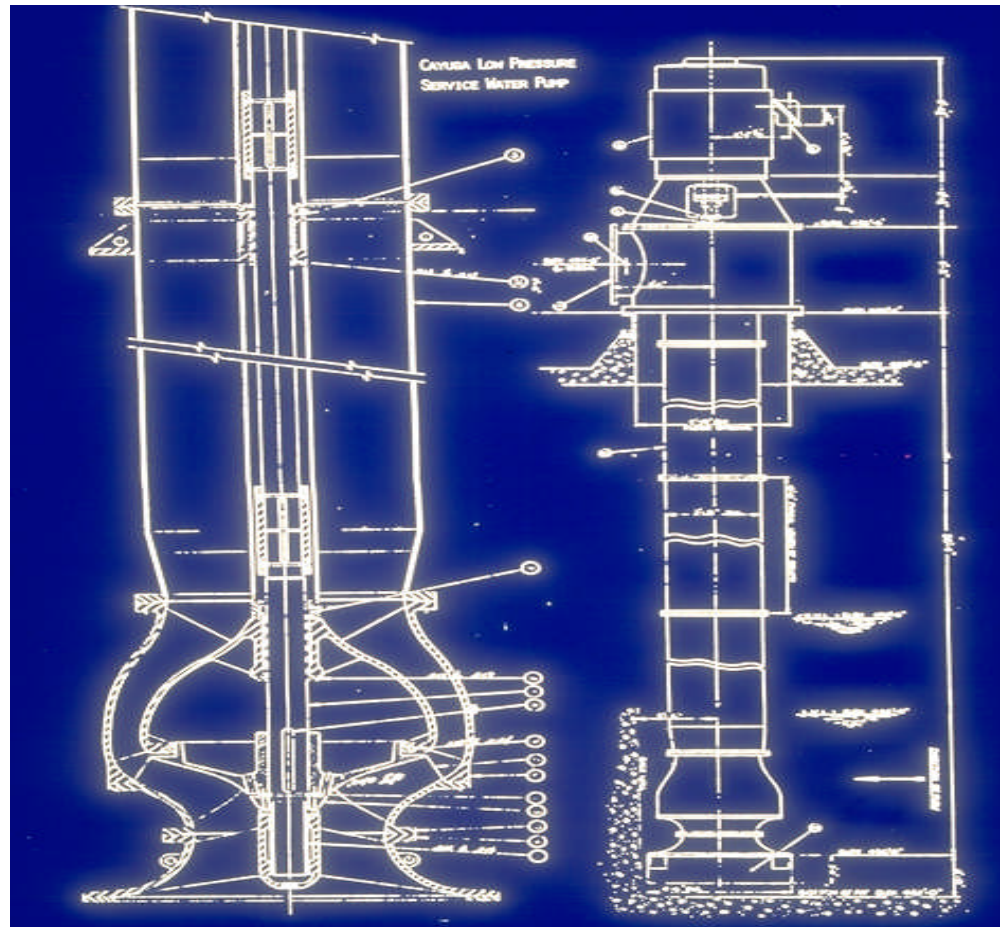

FIGURE 4
RESPONSE PLOT AFTER
IMPACT ON 17 NORTH
PUMP. RESPONSE INDICATES
THAT DAMPING IS LOW
RESULTING IN 16:1
AMPLIFICATION FACTOR.

6: One of the most important settings on a vertical pump is the lift. The lift is the distance between the impeller and the stationary components. It is determined by measuring the gap in the coupling before the bolts are tightened and the impeller is lifted off the bottom of the pump. If the lift is too much, then the pump will be inefficient and will not produce the desired head or flow. If the lift is too small, then the impeller can contact stationary components.

VERTICAL PUMP



7: At the Best Efficiency Point, the angle of the fluid coming off the impeller matches the angle of the diffusers. Operating off of this point will result in lower efficiency and higher levels of vibration.

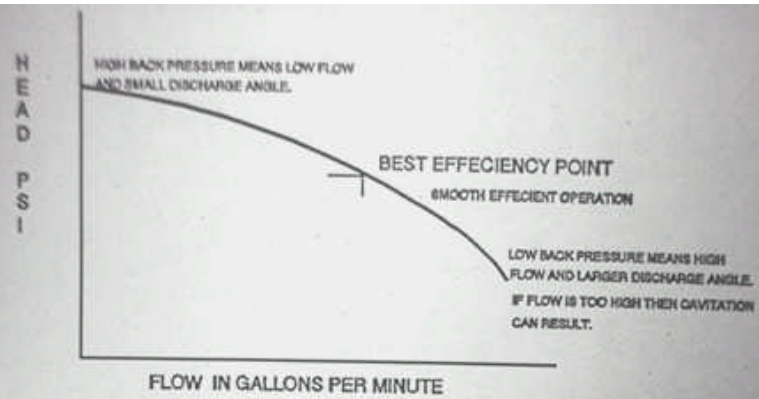

AS BACK PRESSURE IS DECREASED FLOW THROUGH PUMP INCREASES AND FLUID DISCHARGE ANGLE INCREASES.

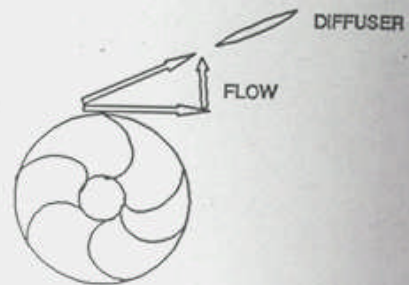

AT BEST EFFICIENCY DESIGN POINT FLUID DISCHARGE ANGLE MATCHES ANGLE OF DIFFUSER AND FLOW IS SMOOTH WITH MINIMAL DISTURBANCES.

IF FLOW IS DECREASED (TOO MUCH BACK PRESSURE) OR IS INCREASED (TOO LITTLE BACK PRESSURE) THE FLUID ANGLE NO LONGER MATCHES DIFFUSER ANGLE RESULTING IN HIGHER VIBRATION AND A LOSS IN EFFICIENCY.

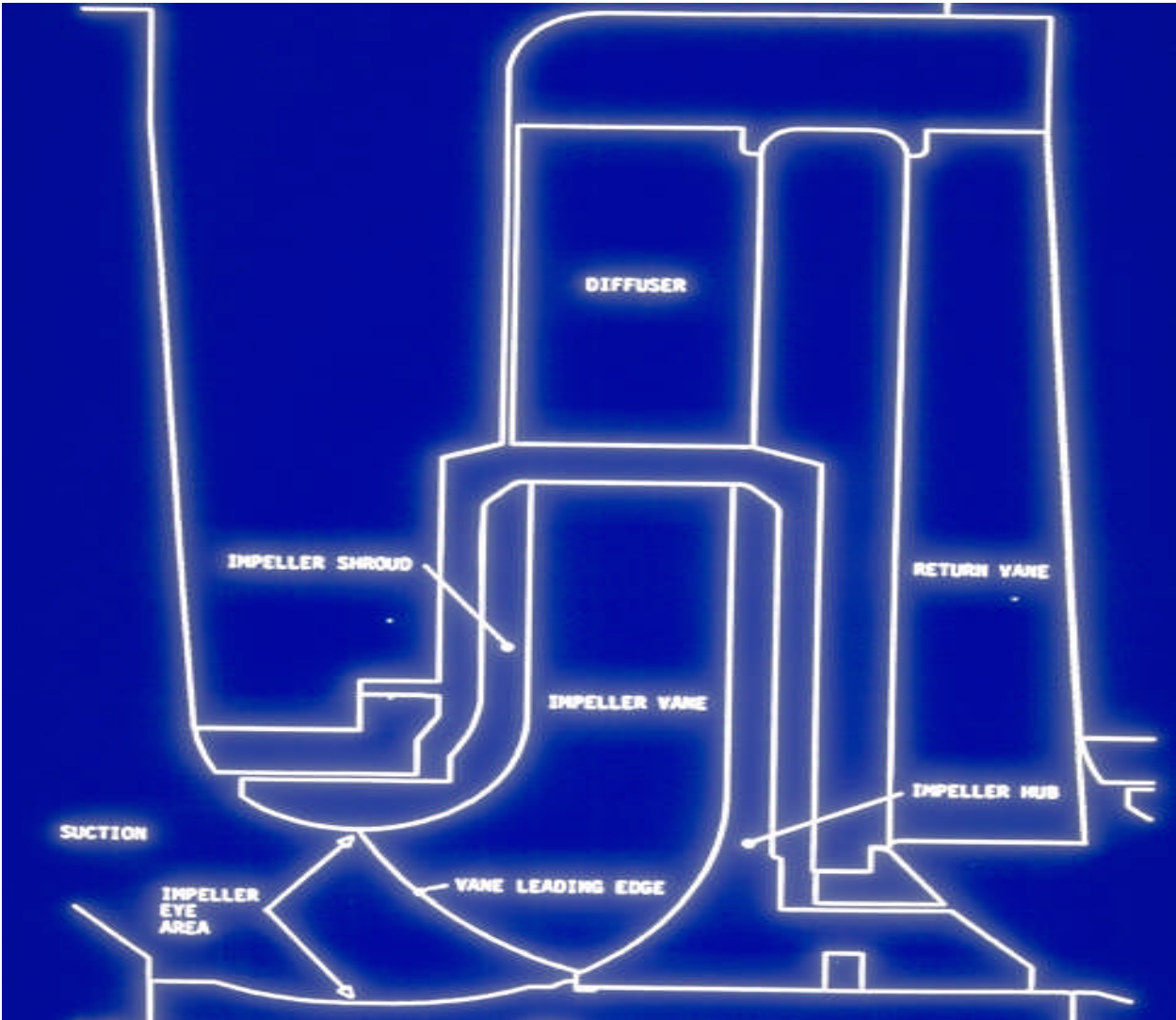

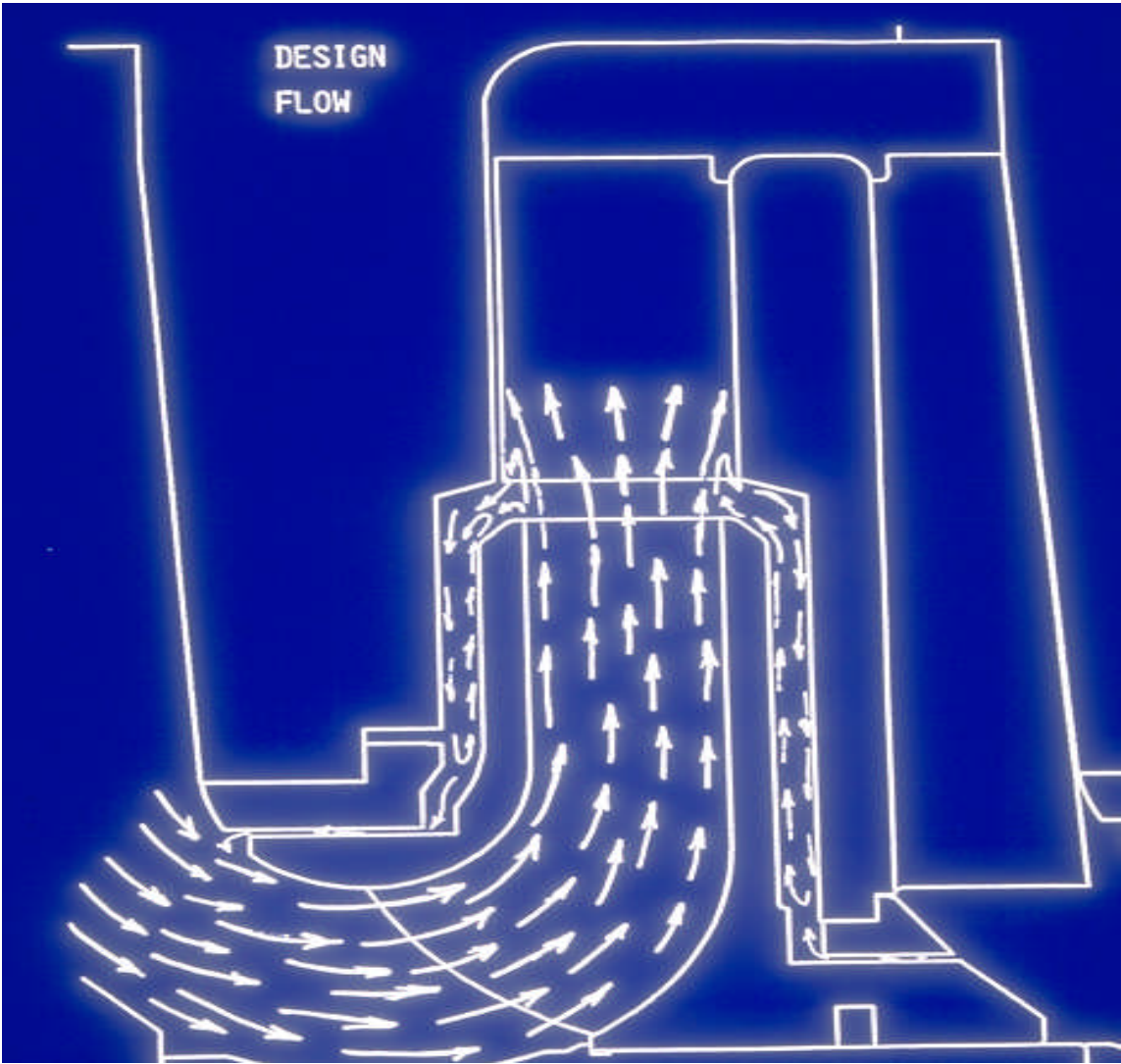

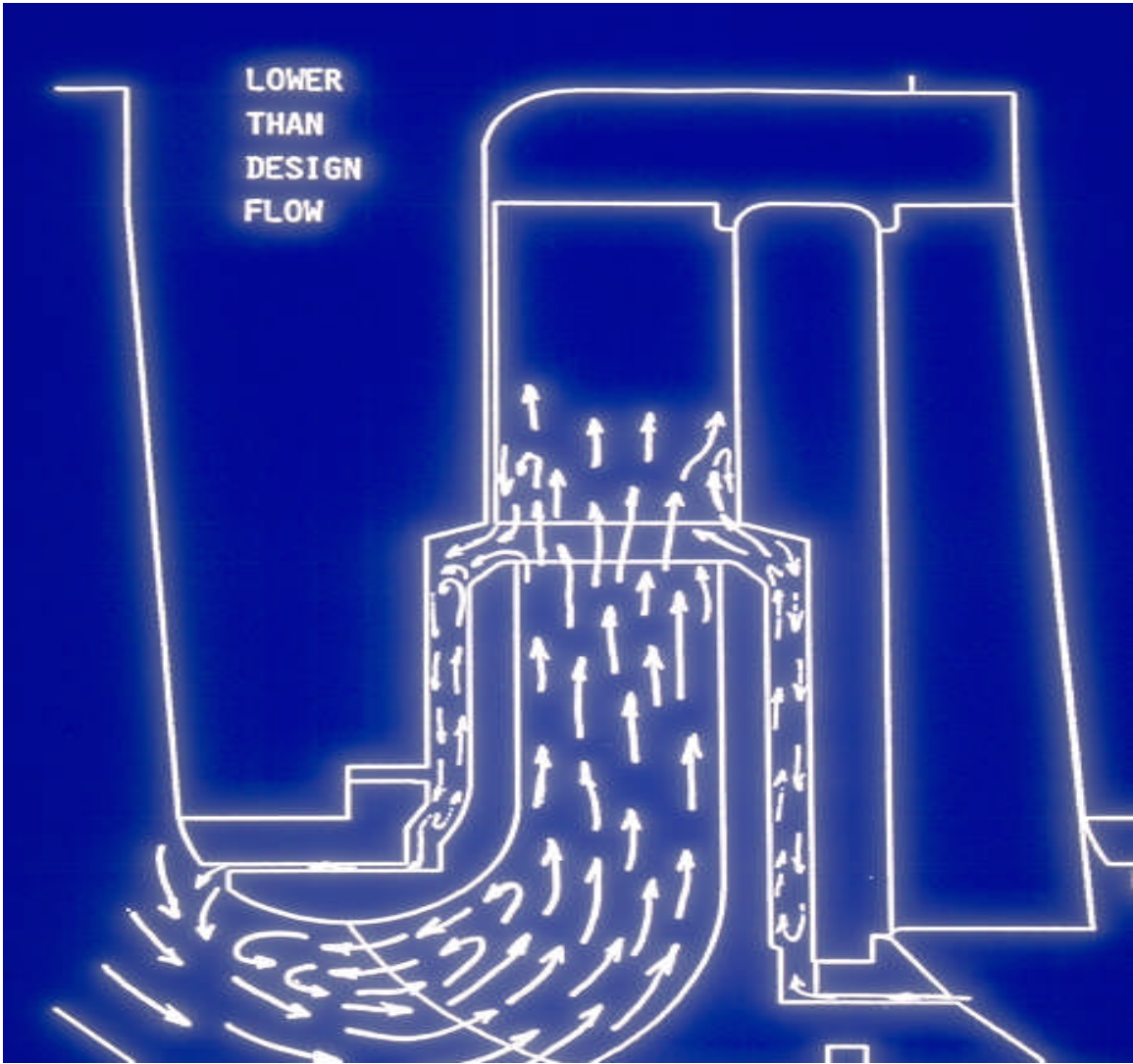

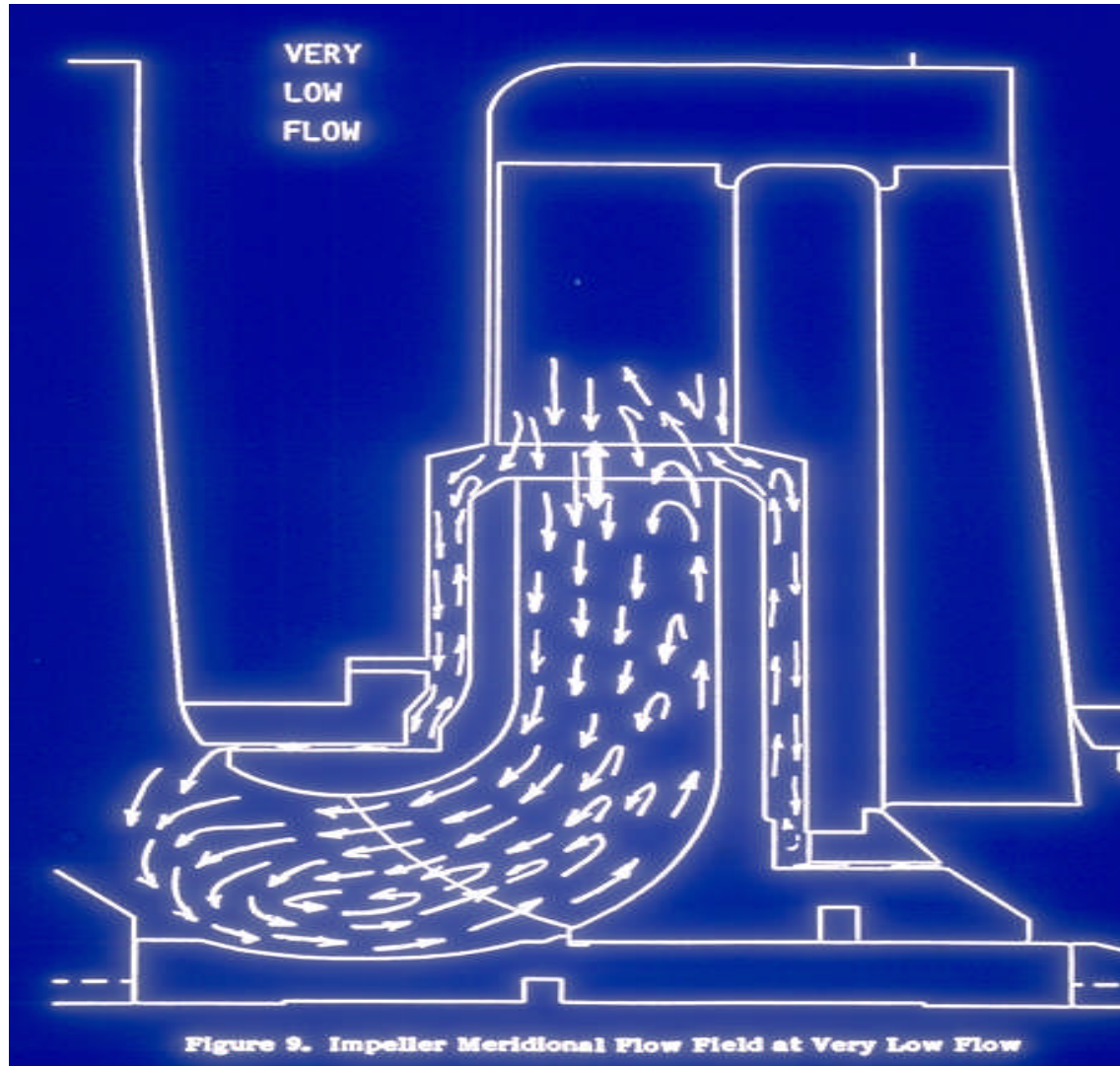

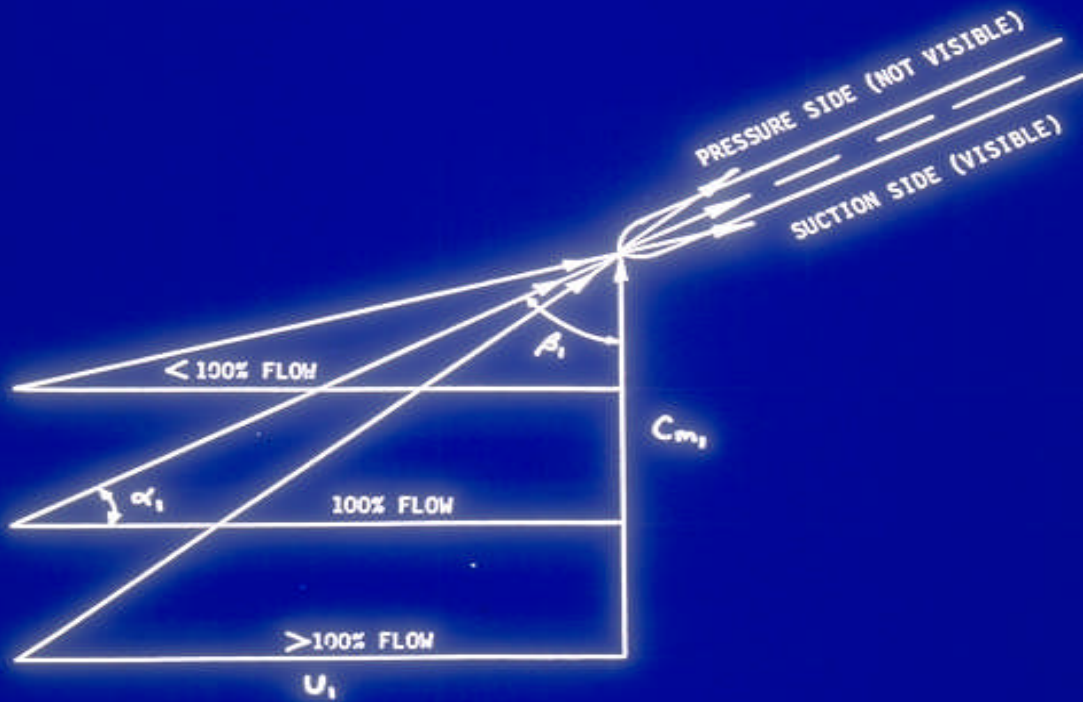
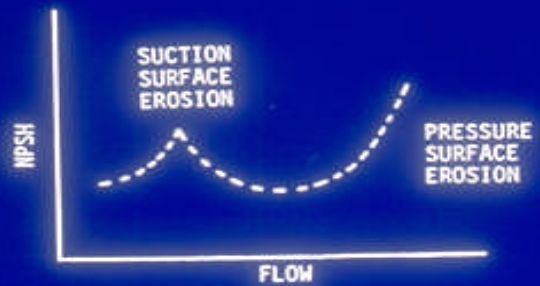

8: If the discharge valve of a large pump is not completely closed, then this can cause the startup time to increase, resulting in an over current trip.

Case history- A water company could not get a large vertical pump to start. They brought in electrical experts, but everything checked out properly. It was suggested by the vibration analyst that the valve might be leaking. When it was examined, it was discovered that the seal was damaged. When the valve was repaired, the motor started with no problem.

Sleeve Bearings

Important Points

1: Improper bonding of the babbitt to the base metal will cause sleeve bearings to run hot because of poor heat transfer in the areas where the bonding was not complete.

In many cases, you will see fans and air movers blowing air across the bearing to cool it, when the actual cause of the high reading at the thermocouple is poor bonding.

An ultrasonic exam of the bearing will quickly identify the problem.

2: A good rule of thumb is that a machine that operates with shaft motion levels of less than 25% of clearance is running with acceptable amplitudes. Above 30% is a low level alarm and above 40% is a high level alarm. Levels greater than 50% will cause rapid fatigue of the babbitt. Source: Jim McHugh

3: When an axial resonance is suspected on a machine with sleeve bearings, it is necessary to rotate the shaft during the impact test. This gets the shaft up on the oil film and decouples the end bell from the shaft, so that a realistic natural frequency can be determined. Case History- A large feed pump motor had .6 in/second of axial vibration. Resonance was suspected. When a static impact test was performed, there did not appear to be a problem. However, when a strap wrench was used to rotate the shaft and get the shaft up on the oil film, a natural frequency appeared at almost exactly running speed. This is a very common occurrence and the number of times this has occurred are almost too numerous to list.

RESPONSE TO IMPACTS IN AXIAL DIRECTION ON LARGE MOTOR WITH SLEEVE BEARINGS

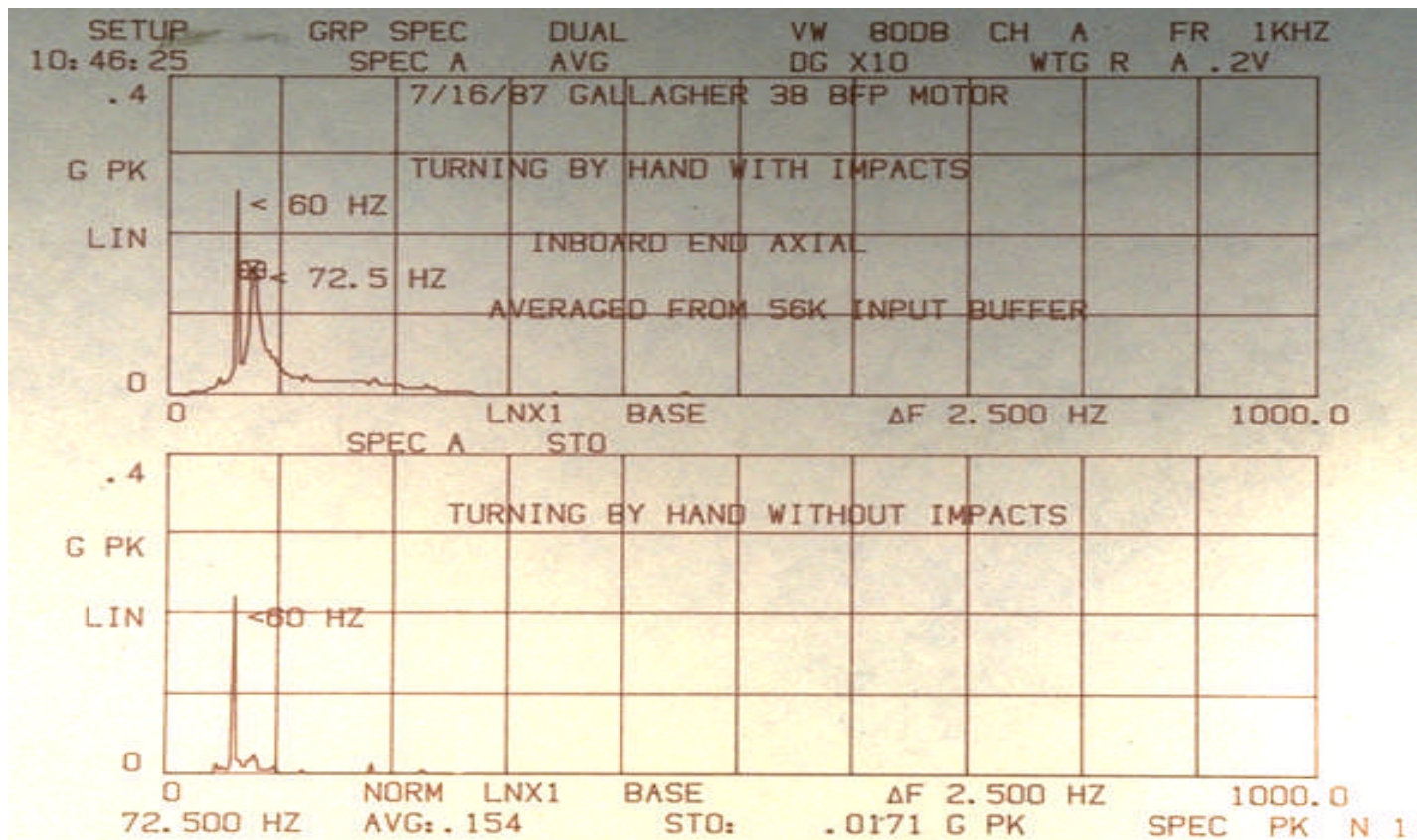

RESPONSE ON END BELL IN AXIAL DIRECTION
WHILE TURNING SLOWLY AS COMPARED TO
SITTING STILL

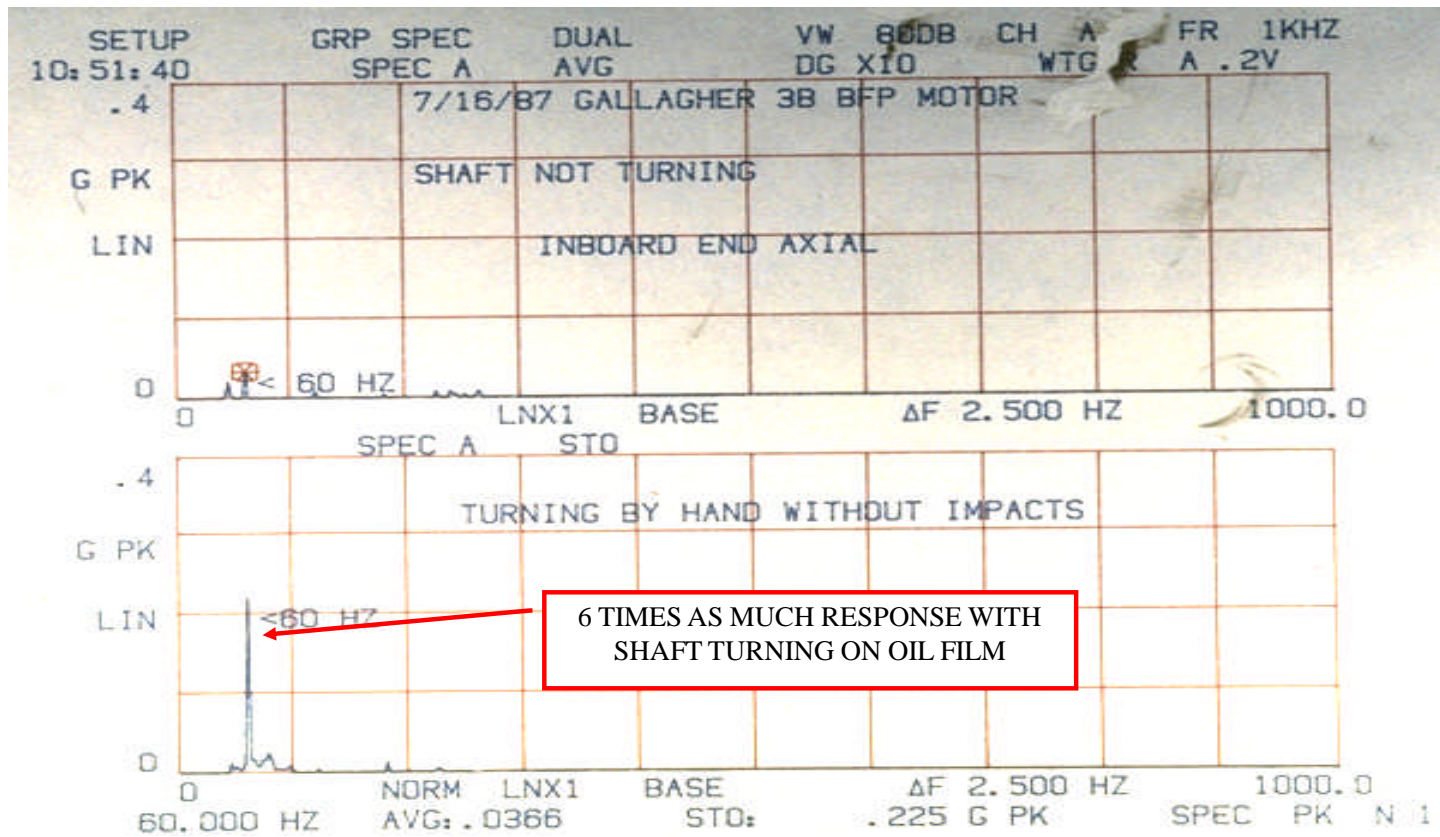

RESPONSE TO IMPACTS IN AXIAL DIRECTION ON MOTOR WITH SLEEVE BEARINGS WHILE SHAFT IS STATIC AND TURNING

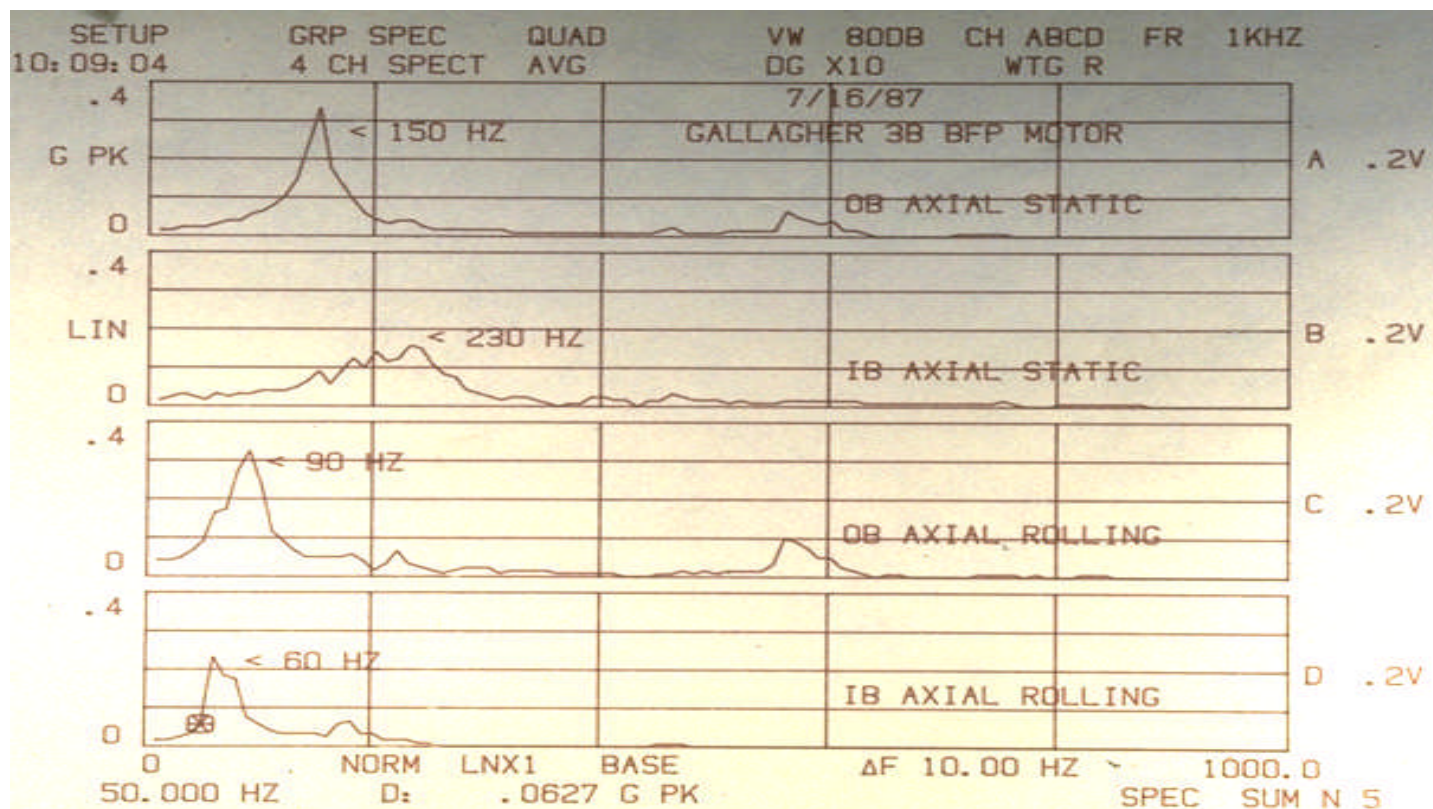

4: If excessive clearances are suspected in a machine with sleeve bearings, then put a dial indicator on the shaft and do a lift check.

SIGNAL PROCESSING

1: When performing resonance tests, do not use the Hanning or any similar windows, unless the impact and response signals are delayed to move them to the center of the time block. Since the response is maximum after the impact, this data must be moved away from the edge of the time block where it would be destroyed or severely attenuated by the Weighting factor. Use of a Uniform Window does not require a delay, because it does not attenuate the signal at the beginning or end of the time block.

SOME 360 HZ VIBRATION IS ALWAYS PRESENT ON D.C. DRIVES OF THIS TYPE. THE QUESTION WAS, WHY WAS IT SO HIGH. A RESONANCE TEST FOUND THAT THE HOUSING HAD A NATURAL FREQUENCY AT 372 HZ.

372 HZ IS CLOSE TO 360 HZ SCR FIRING FREQUENCY

A customer had tested this motor and did not find a resonance near 360 HZ. They had used a Hanning window that destroyed the data at the beginning of the time block.

FIGURE 3
SPARE YANKEE DRIVE MOTOR
NATURAL FREQUENCY TEST
INBOARD BEARING.

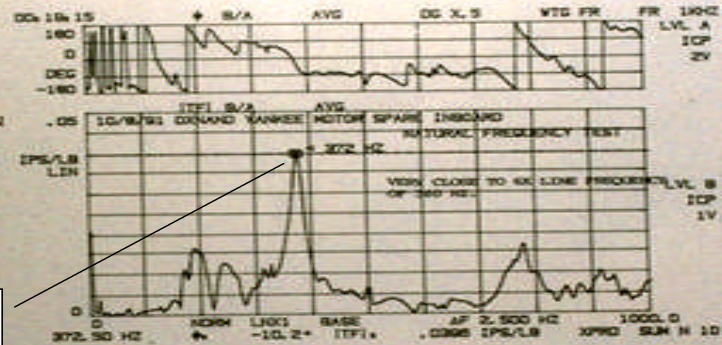
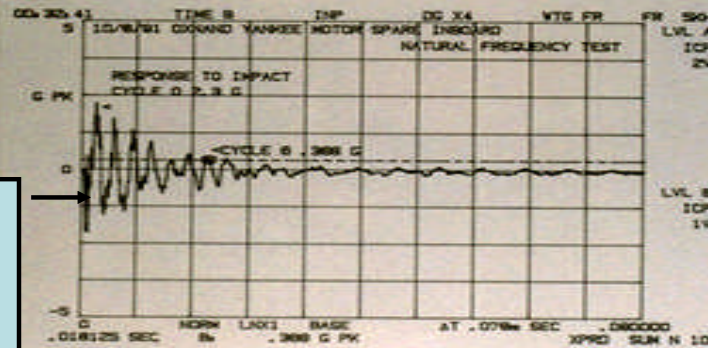

FIGURE 4
RESPONSE PLOT SHOWING
DECAY OF VIBRATION
AFTER IMPACT AND CALCULATION
OF AMPLIFICATION FACTOR.



PEAK LIST X	Y			AMPLIFICATION FACTOR
.00069998	.538	.0072858	1.38	LOG DEC= 1/6 X LN(2.3/.368)
.0014844	.780	.0076582	1.09	LOG DEC= .296
.0018750	1.40	.0066219	1.01	RES= .296/(2*PI)*.047
.0020312	2.30	.012969	.354	Q= 1/(2*.047)= 10.6
.0024219	1.81	.015078	.548	AMPLIFICATION FACTOR=10.6
.0029569	1.18	.0153		RESONANCE MARKS VIBRATION
.0042909	.591			AT THAT FREQUENCY 10.6 TIMES
.0048094	1.78			HIGHER.
.0048438	1.40			
.0070312	.680			

2: **The FFT is a batch process.** Impacts or other transient processes which occur in time frames which are short compared to the period of the analysis time block result in significant amplitude errors regarding peak values. Therefore a user should always take a look at the time domain when transients are present. **THIS IS WHY IT IS EXTREMELY IMPORTANT TO LOOK AT ACCELERATION TIME WAVES WHEN IMPACTS ARE PRESENT**

3: A simple way to determine a mode shape is to take a transfer function at equally spaced points along the structure, then plot the normalized amplitudes of the imaginary components above the location of the test points on a scaled plot. Note that this works for acceleration and displacement data. If velocity data is used, plot the normalized values of the real part of the transfer function.

MODE SHAPE OF 480 CPM MODE

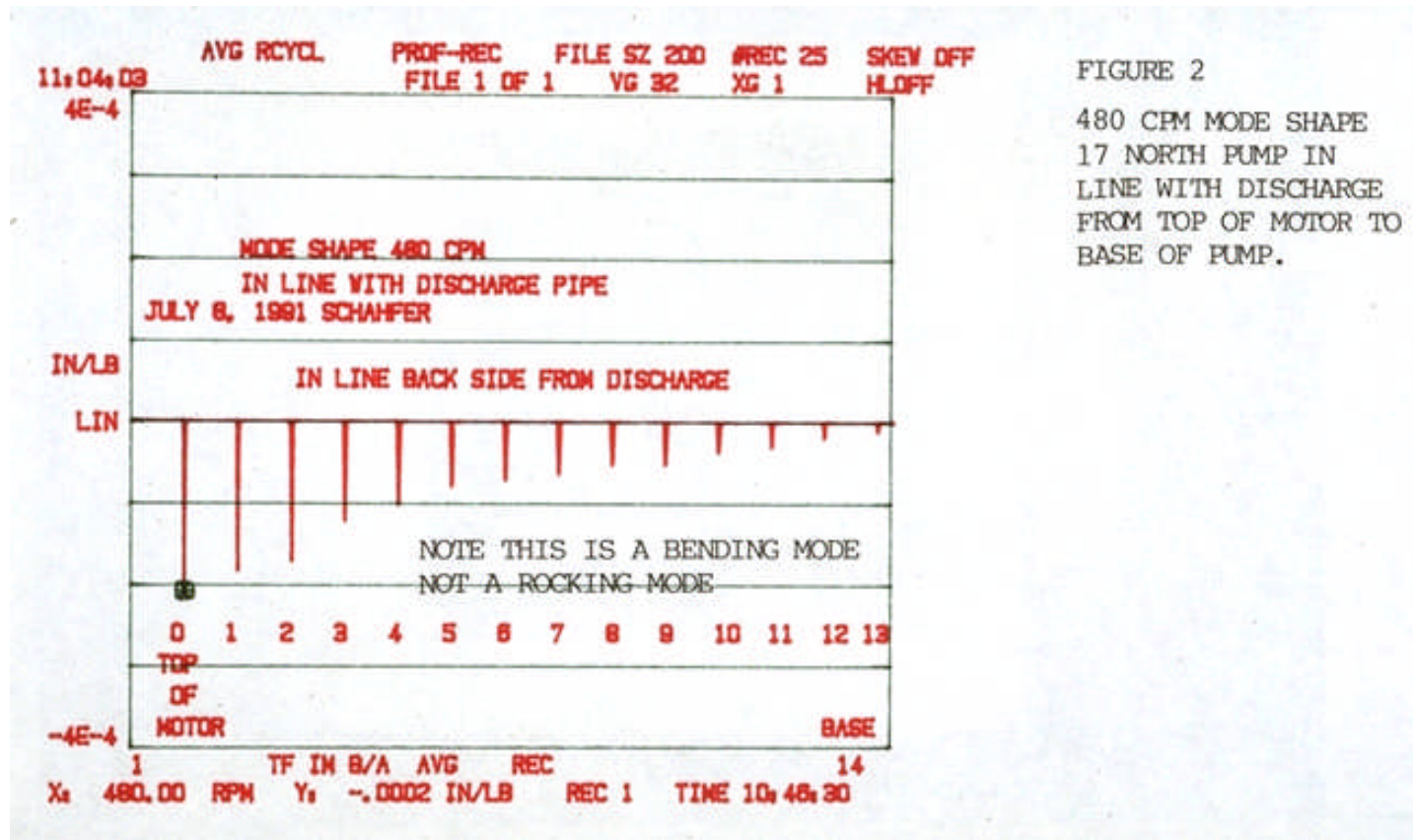

FIGURE 2
480 CPM MODE SHAPE
17 NORTH PUMP IN
LINE WITH DISCHARGE
FROM TOP OF MOTOR TO
BASE OF PUMP.

4: Beware of fat peaks- A fat peak can be the result of a beat, modulation, speed changes or a resonance being excited.

Note that the amplitude of the peak in the spectrum can be significantly in error as compared to the actual peak value. This is because the energy is spread out over several cells. Supplied by Jack Frarey.

5: When attempting to measure the loc decrement to determine the damping, if the desired frequency is low, then if possible, **use analog integration** so the time plot will be in displacement. **This technique lowers the influence on the time plot of the higher frequencies** which might dominate if an accelerometer is being used.

EXAMPLE OF NATURAL FREQUENCY TEST AND CALCULATION OF AMPLIFICATION FACTOR.

TRANSFER FUNCTION SHOWING NATURAL FREQUENCY AT 1770 CPM WHICH CORRESPONDS TO EQUIPMENT OPERATING SPEED

NATURAL FREQUENCY 1770 CPM

$N_0 = .0914, N_{10} = .027$
 $PSI = 1/10 * 1 / (2 * \pi) * \ln(.0914 / .027) = .0194$
 $Q = 1 / (2 * .0194) = 25.7$

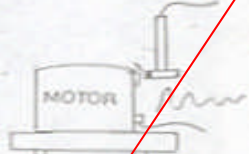
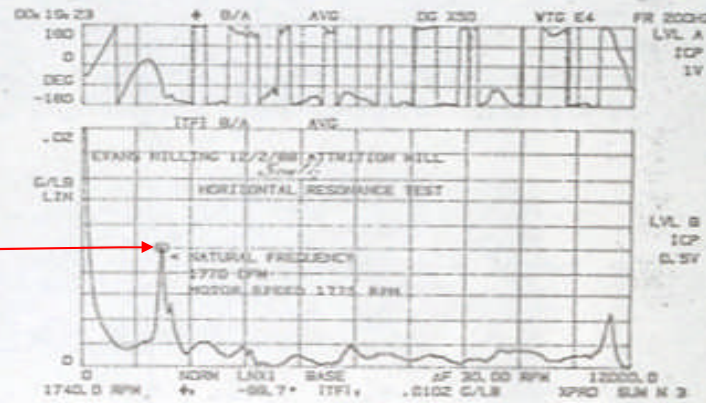

Time decay in g's. Note the presence of higher frequency in time plot.

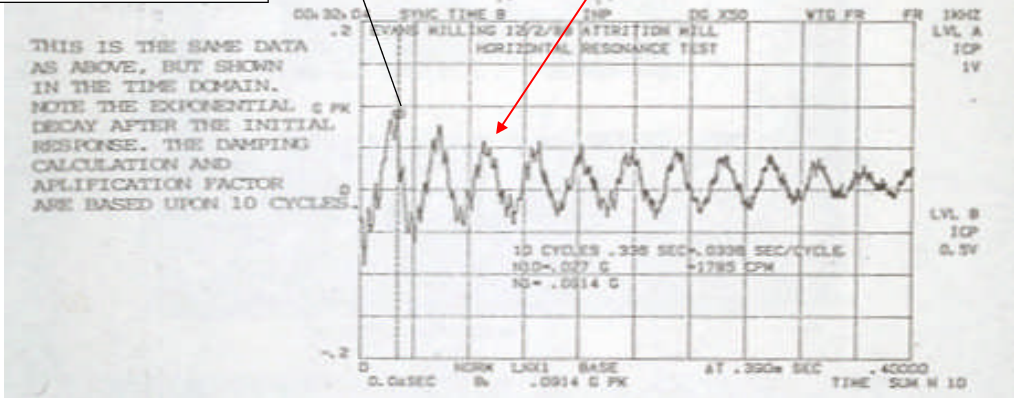

AMPLIFICATION FACTOR CALCULATION USING LOG DEC APPROACH WITH ANALOG INTEGRATION

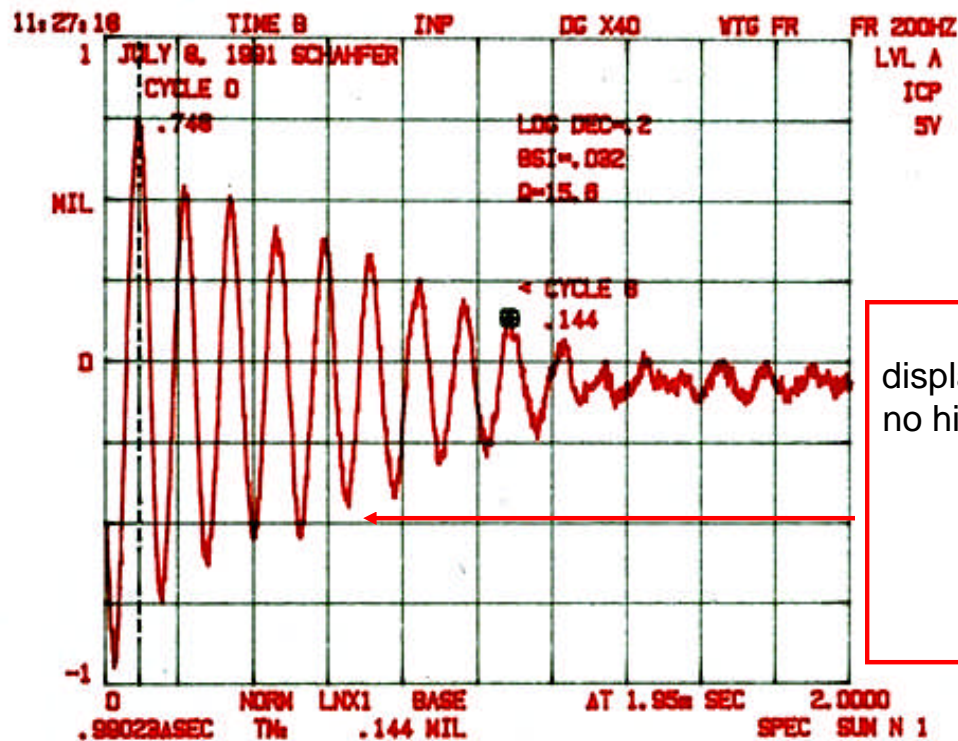

FIGURE 4
RESPONSE PLOT AFTER
IMPACT ON 17 NORTH
PUMP. RESPONSE INDICATES
THAT DAMPING IS LOW
RESULTING IN 16:1
AMPLIFICATION FACTOR.

Time plot is in displacement. Note that no high frequencies are present.

6: Long time samples are useful when low frequency beats are present.

7: Long time samples are also useful when rapid transients occur on a random basis.

8: Long time samples are bad when the frequency is shifting.

Vibratory conveyors that were shaking houses 1/2 mile from foundry. Calculated Peak-Peak 4.1 mils. Actual P-P over 7 mils. People feel much higher levels than spectrum indicates.

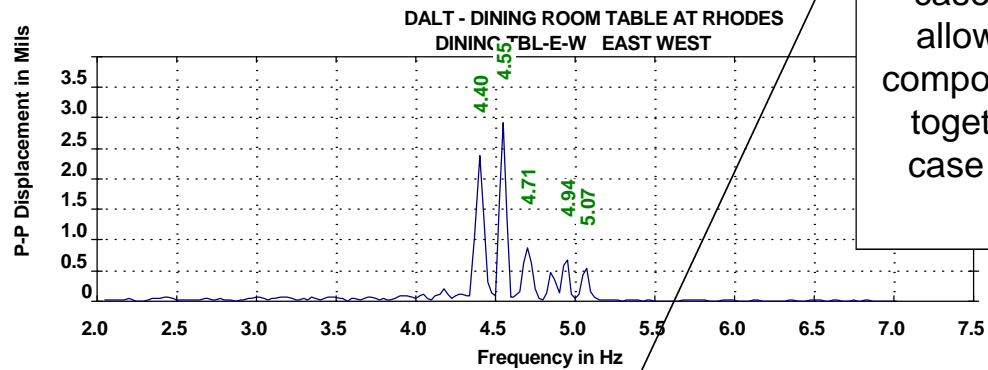

Long time block, in this case 20 seconds, allows time for all components to phase together so worse case can be seen.

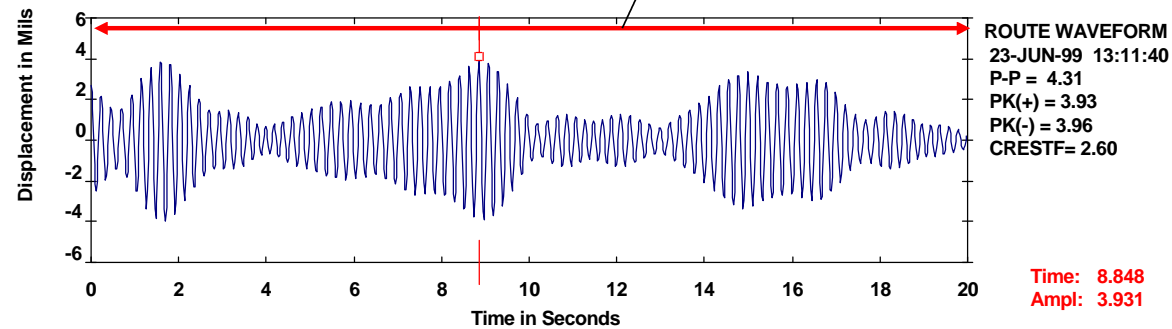

9: If a signal is clipped, then this effectively introduces a DC shift into the data. This can prove disastrous if the data is then integrated. Example:

A high output accelerometer was used to measure vibration on a pump. The signal was integrated into velocity. Unfortunately, the pump cavitated. The cavitation overloaded the accelerometer's electronics introducing a DC shift. The overall output of the pump then fictitiously read several inches per second and all the alarms went off. Source: Jack Fraey

10: When trying to separate two closely spaced signals, remember that the frequency resolution is not the number of lines divided by F_{\max} . It is not even the number of lines divided by F_{\max} X the weighting window factor. **It is actually the number of lines divided by F_{\max} X the widow factor X 2.** If the factor of 2 is not included, then the modulating effect of the window function can create false sidebands that are mistaken for actual frequencies. Source: Jack Frarey

A BEAT THAT COMPLETES ONE CYCLE DURING TIME BLOCK-CENTERED IN BUFFER

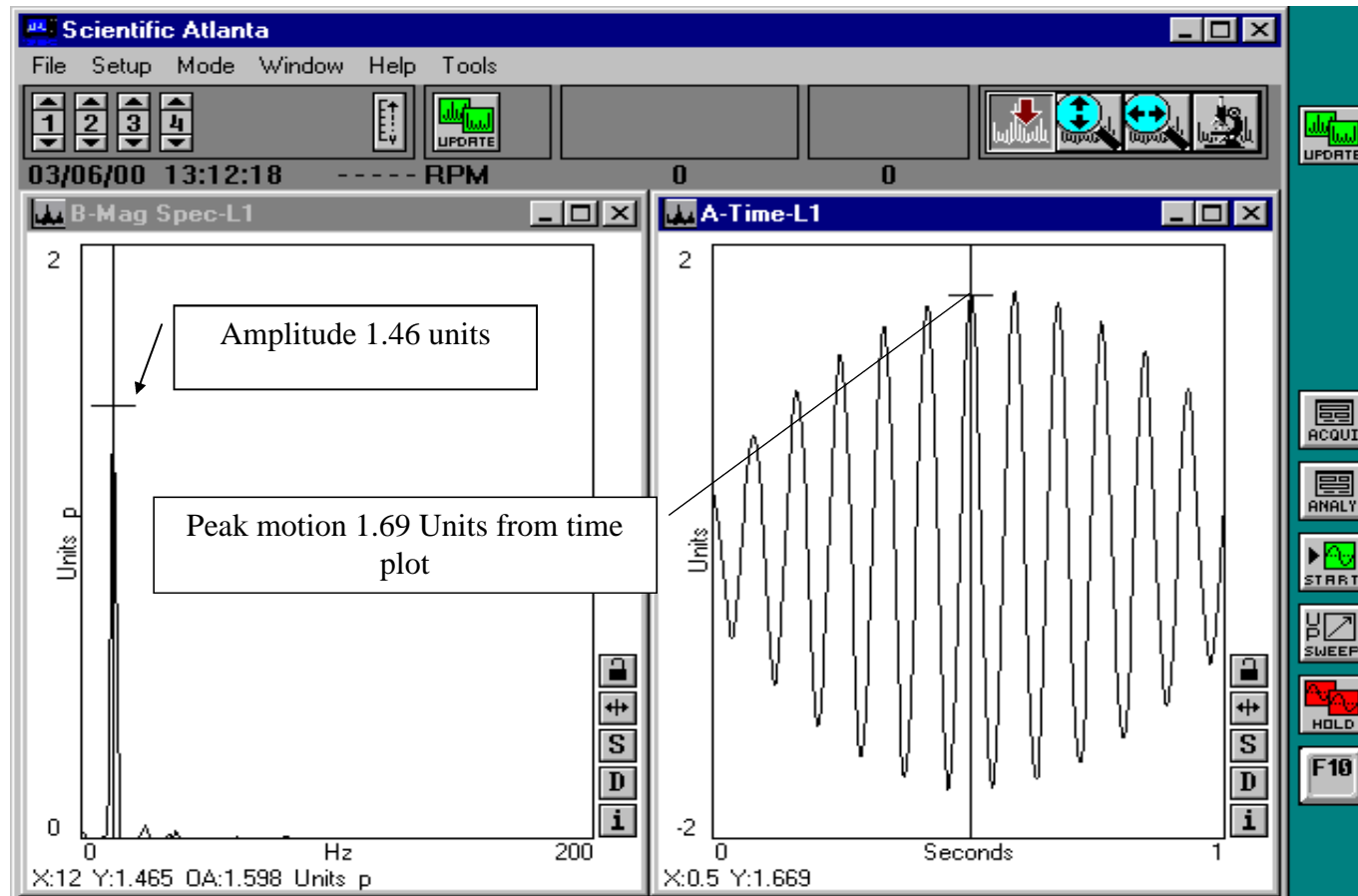

A beat with one cycle in time buffer-Peak Amplitude at beginning and end of buffer-minimum at center

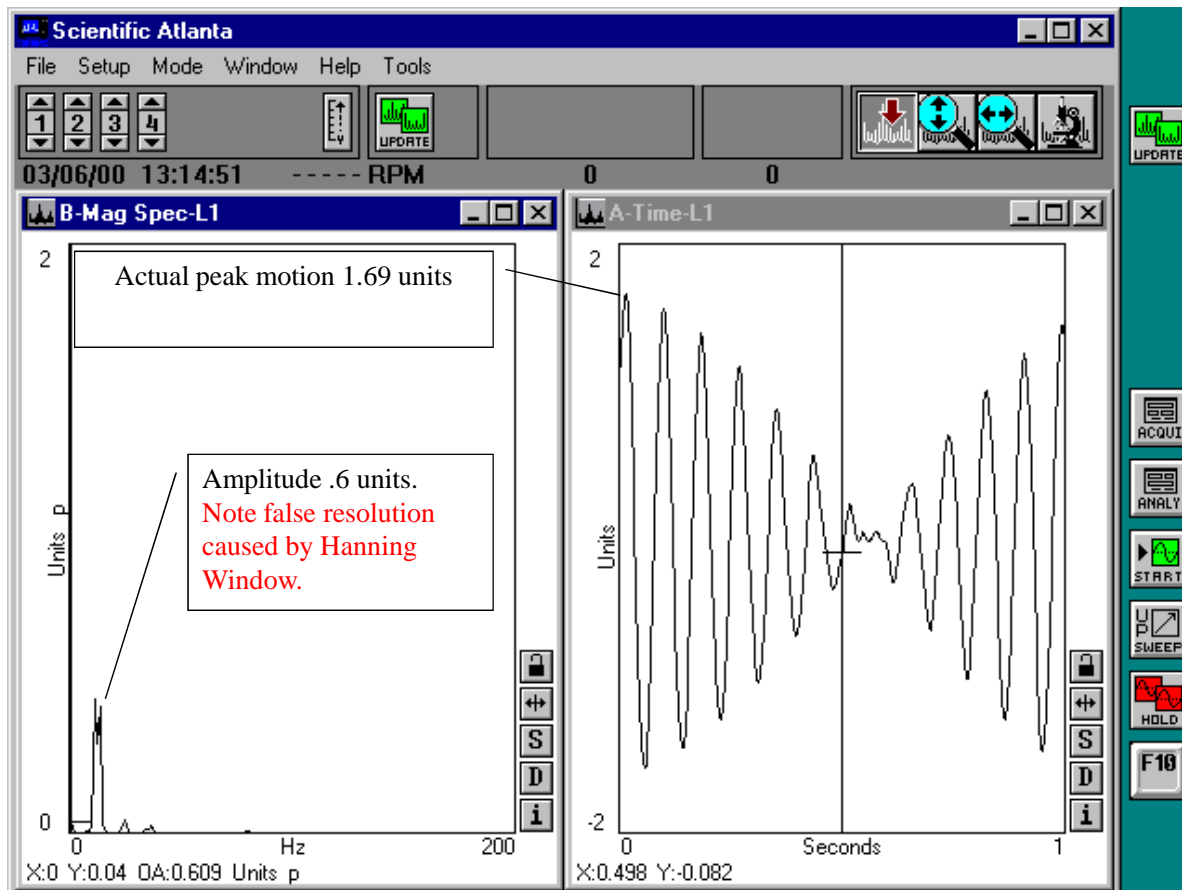

11: When viewing a spectrum and time plot, there are often times when things do not seem to add up. For instance, the spectrum may show low levels and generate no concern. On the other hand, the time plot might show very high amplitudes. One reason for this is the fact that the time based data was sampled at a frequency that is equivalent to $2.56 F_{max}$. According to the Nyquist sampling law, this is sufficient to pick up frequencies at $1.28 F_{max}$. **This means that the time data can see higher frequencies than are displayed in the spectral plot.** Example: When viewing data from a motor, the spectrum showed nothing over .03 in/sec. In the acceleration time plot levels as high as 8 g's were observed. The maximum frequency was set at 1000 HZ. The actual problem was that the 1750 RPM motor had rotor bars generating a signal just above 1000 HZ . The vibration was visible in the time plot, but was beyond the 1000 Hz F_{max} , so it was not seen in the spectrum. Solution: When this type of situation is encountered, then increase the F_{max} .

12: A similar discrepancy can occur when analog overall levels are compared to spectral data or overall values computed from the spectral data. The analog overall value includes energy all the way out to say 20000 Hz. The digital overall value only includes those components that are in the calculated spectrum. If there is a discrepancy, then as stated in the previous topic, increase the Fmax to determine what is causing the difference.

RESONANCE

1: When performing a resonance test, if a peak shows up at the frequency of interest, but the phase shift is small, then this is an indication that there is a resonant component that may be located some distance from where the test is being performed. For instance if a section of pipe is tested for a resonance and there is a peak, but a small phase shift, then there might be for example a nearby control valve that is resonant. If the control valve itself is tested, then the normal 180 degree phase shift would be present when its natural frequency is excited.

RESONANCE TEST ON VERTICAL PUMP WHERE PUMP IS RESONANT AT RUNNING SPEED AND RESPONSE WAS MEASURED ON MOTOR

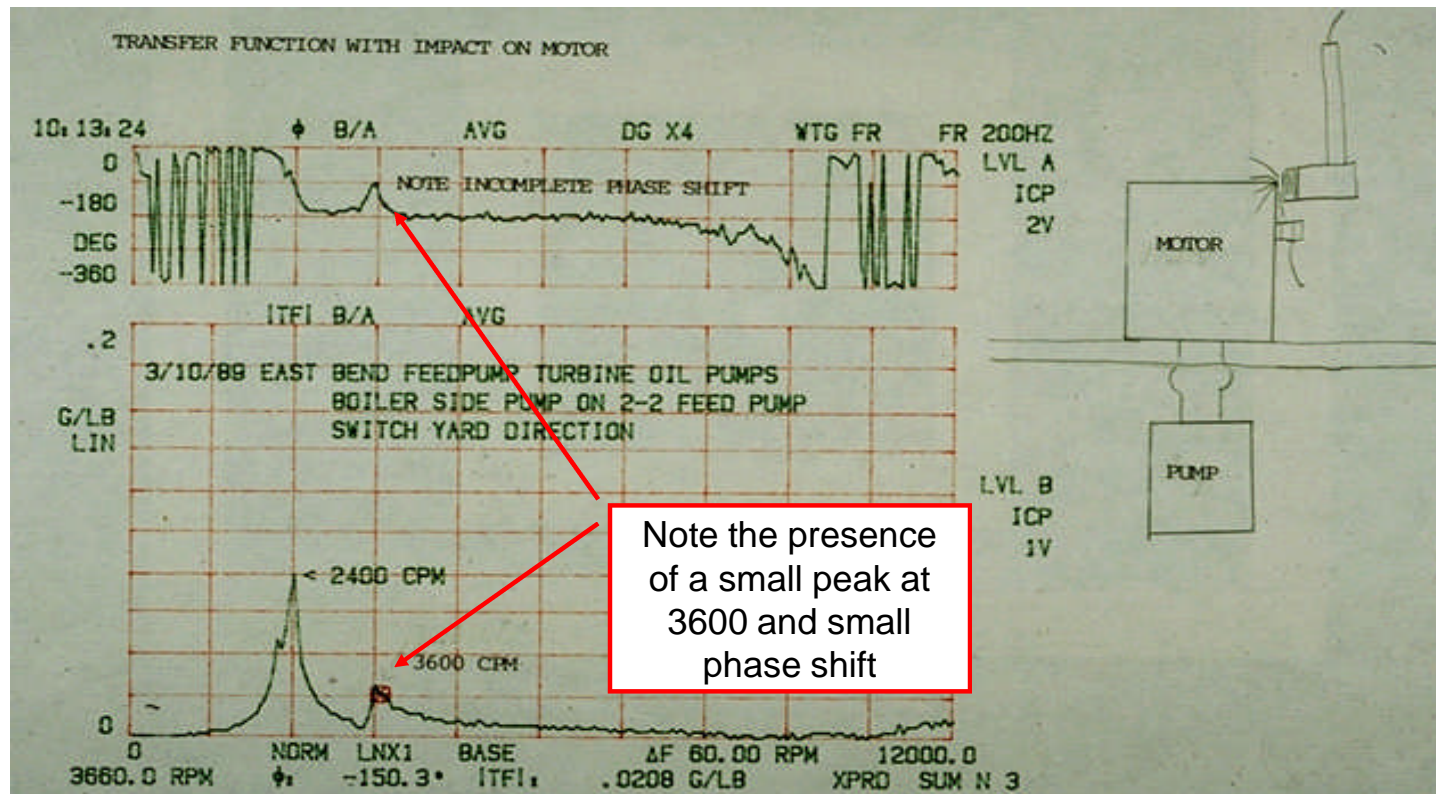

RESPONSE IS MEASURED ON PUMP

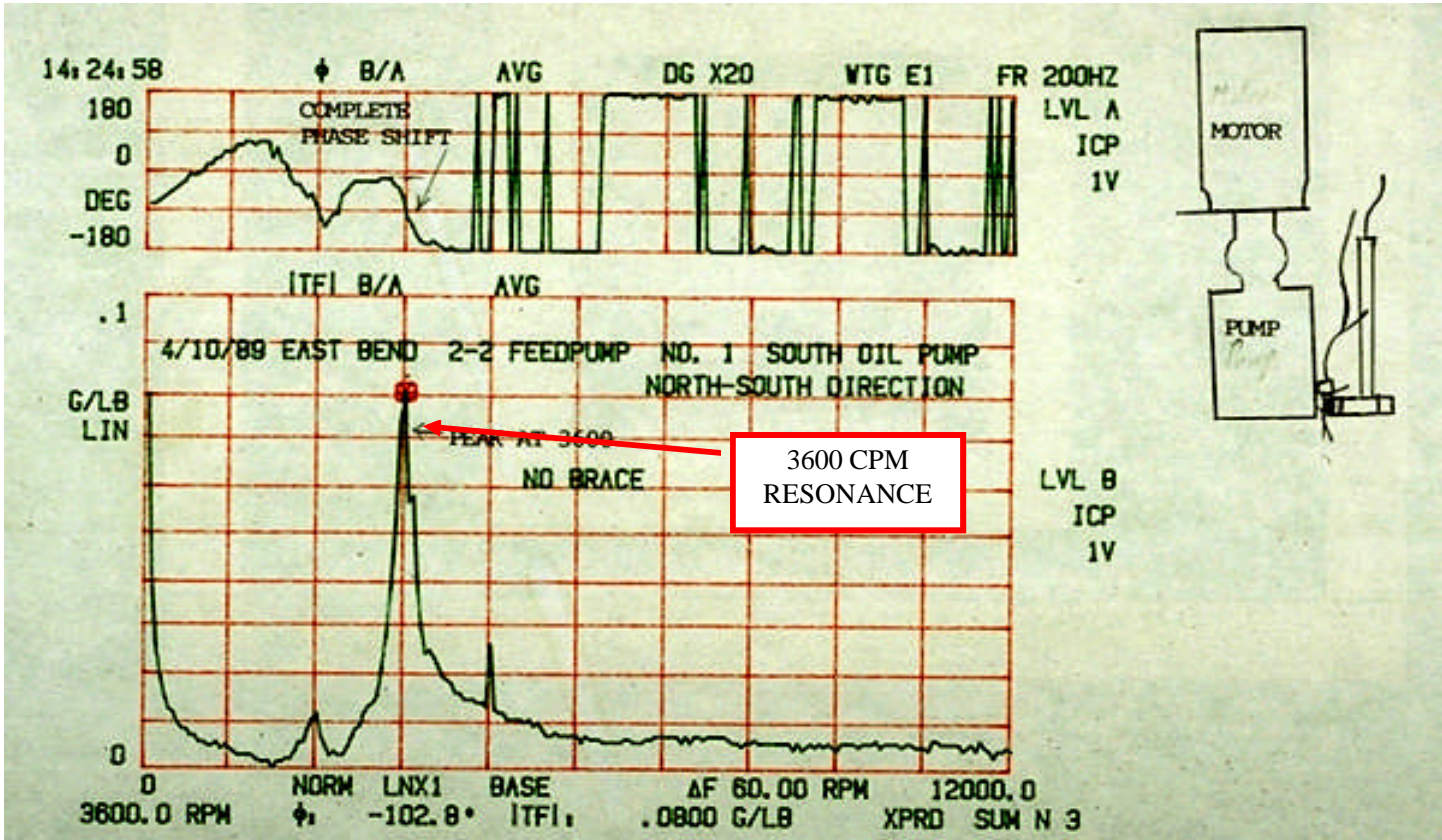

2: When anchor bolts or rebar break under the surface of concrete, this reduction in stiffness can alter the natural frequency and result in resonance problems. Case History- Three identical pumps were installed. On one pump, the 120HZ vibration on the motor was several times higher than on the other two. When the motor positions were swapped, the problem always occurred in the same location, indicating that problem was location related instead of motor related. A resonance test showed that there was a resonance near 120 Hz at the location with the high levels, but not at the other two locations. When the foundation was broken up, it was discovered that the re-bar was broken in the foundation that had the problem.

3. When doing impact tests, beware of trying to get too much resolution. For instance, if you have a vertical pump that has a suspected resonance at 10 HZ and you choose a 100 HZ Fmax with 800 lines of resolution, then the sample time is 8 seconds. If the response decays away in 1 second, then there will be 7 seconds of noise present versus 1 second of good data. The phase shift will look rough and the coherence will be low. If on the other hand a 500 Hz Fmax and 400 lines of resolution are chosen, then the sample time will be .8 seconds. In this instance, the data will be much cleaner.

4: The opposite situation could also be true. If a lightly damped component is excited then it may continue to ring clear to the end of the time block. This can cause problems when the FFT is performed because a discontinuity is introduced. In this case an exponential weighting factor may need to be introduced to drive the response to zero and eliminate the discontinuity. It has to be noted that if a log decrement calculation is made on data that has been modified by an exponential weighting factor that the answers will be wrong.

Solution- Use exponential weighting factor when viewing spectrum, but shut it off when viewing the time domain.

5: A convenient way to locate support beams in a floor is to perform an impact test and look for a reversal in the direction of the imaginary components.

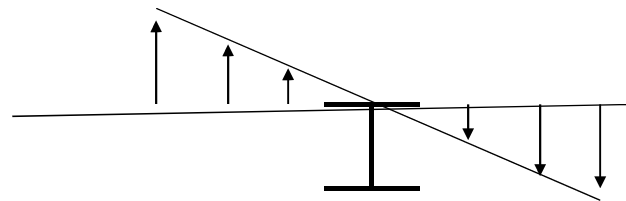

INDUCTION MOTOR CURRENT TESTING

1: When taking spectrum of the current, measure the ratio of the lower number of poles times slip frequency side band in dB to the level of the line frequency current in dB . If there are no other recommendations, then use the 54-45dB rule. If the side band is more than 54 dB below the line frequency signal, then the rotor is probably OK. If the side band is less than 45 dB below the line frequency, then the rotor is probably bad.

HABASH RIVER UNIT #1 TURBINE AUX. OIL PUMP
CURRENT PROBE DATA 5/14/82 SITAR, GESHEIN, BAKTER

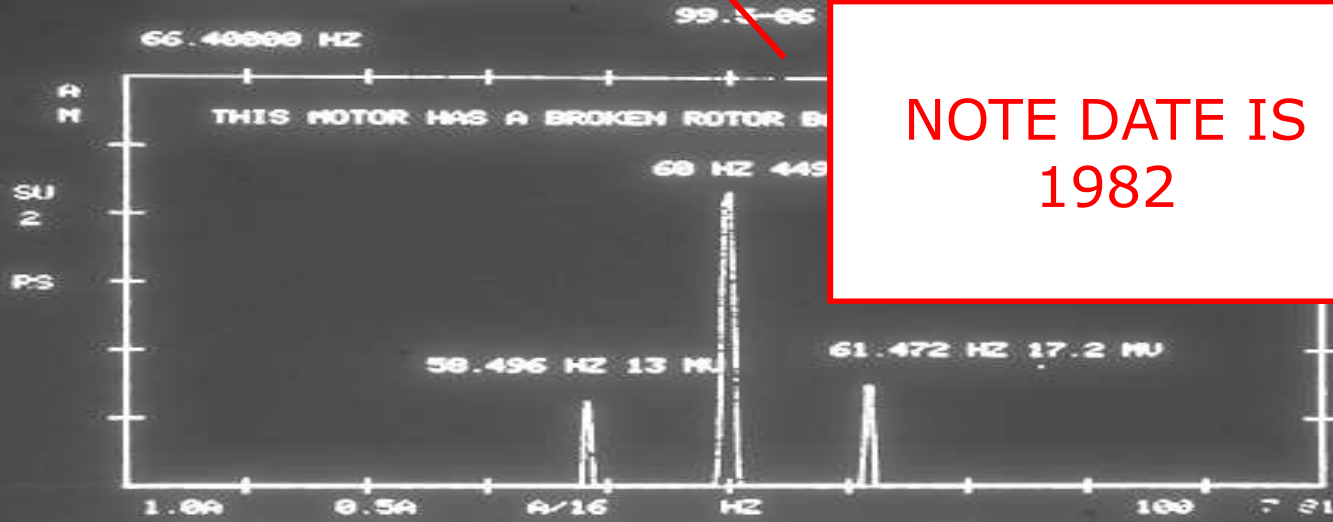

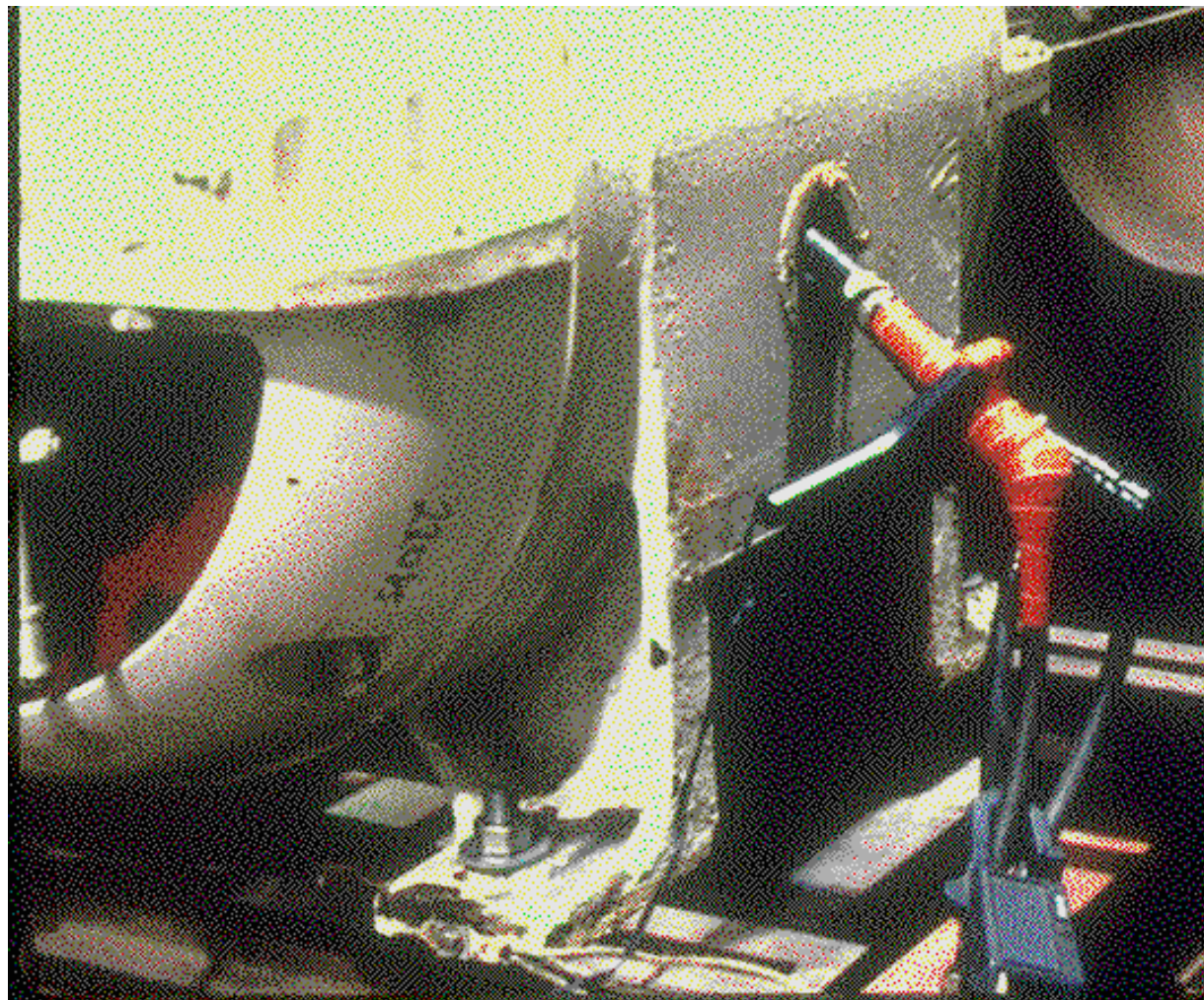

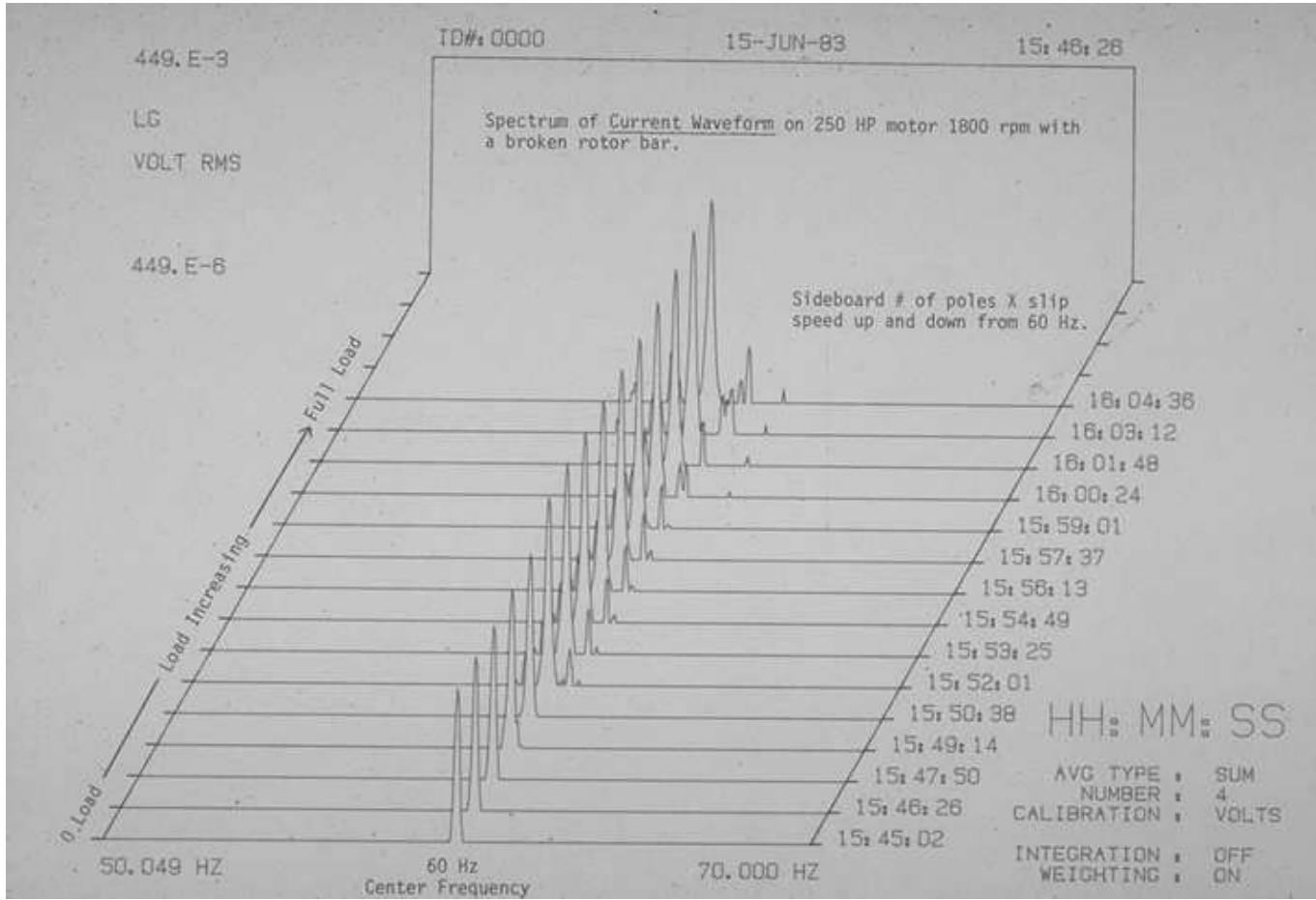

47.6E-3

ID#: 0000

18-JUN-83

08:18:23

LG

INCH P-P

47.6E-8

Vibration spectrum showing sidebands on a 250 HP 1800 RPM motor. As the load increases, the sideboards move away from the center frequency, due to increased amount of slip. The sidebands are the number of poles X the slip speed up and down from running speed. The sidebands also show up on the 2nd and 3rd harmonics.

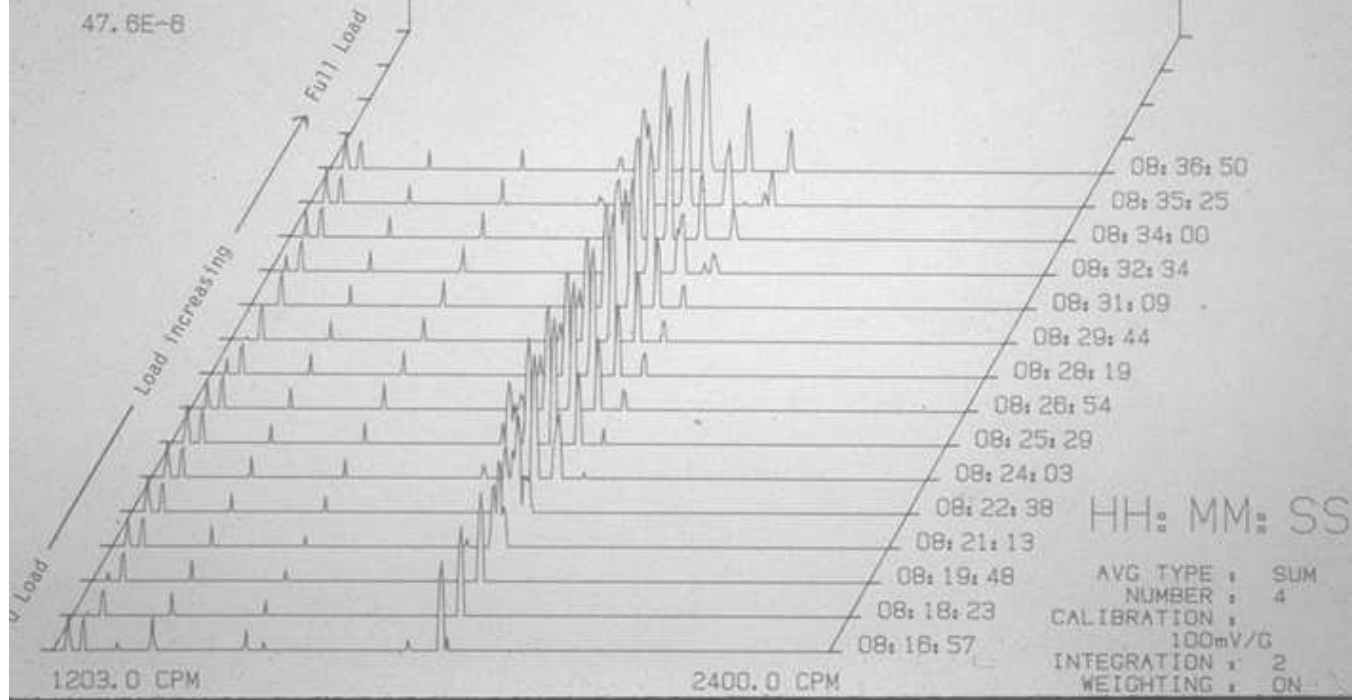

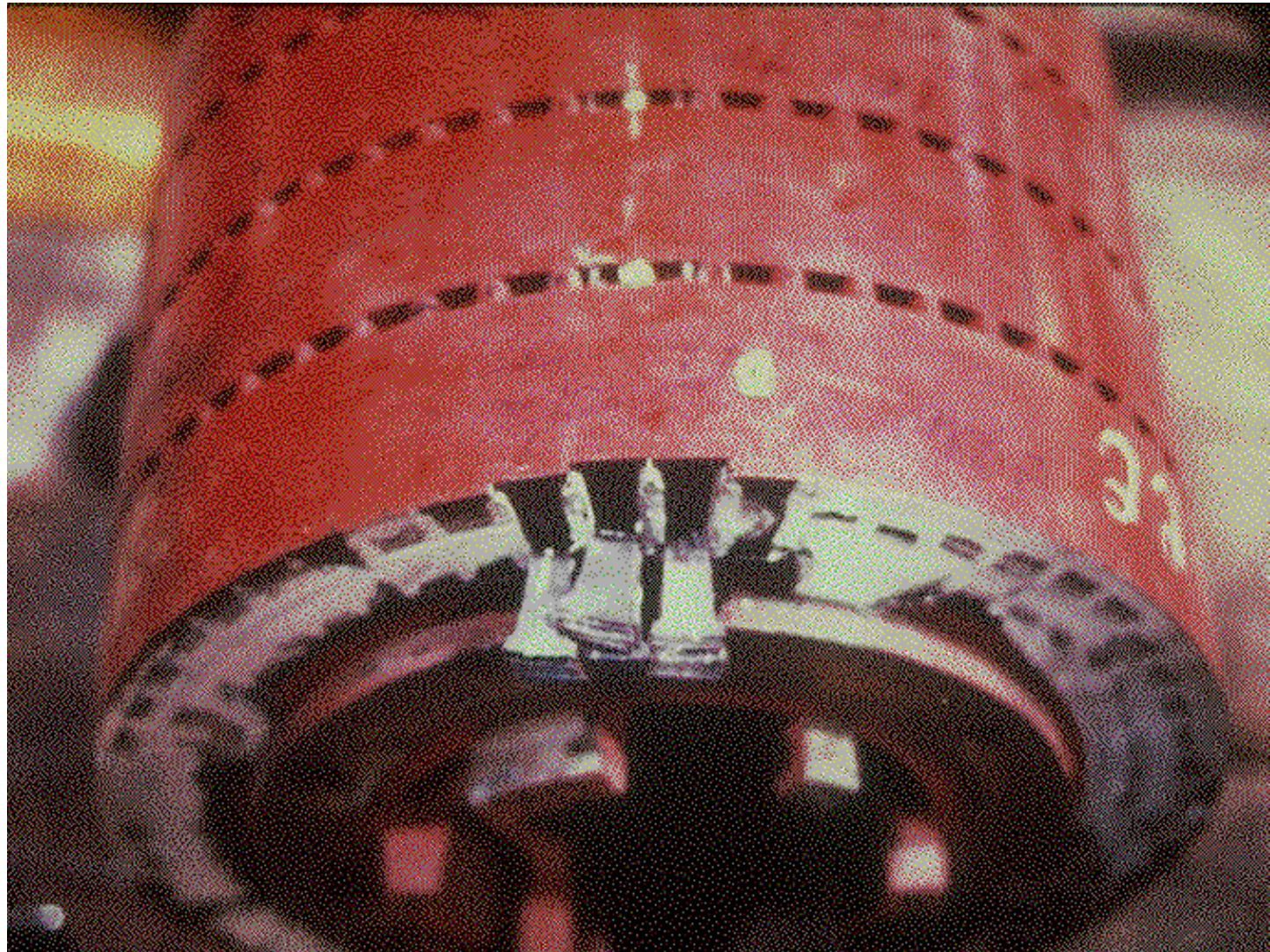
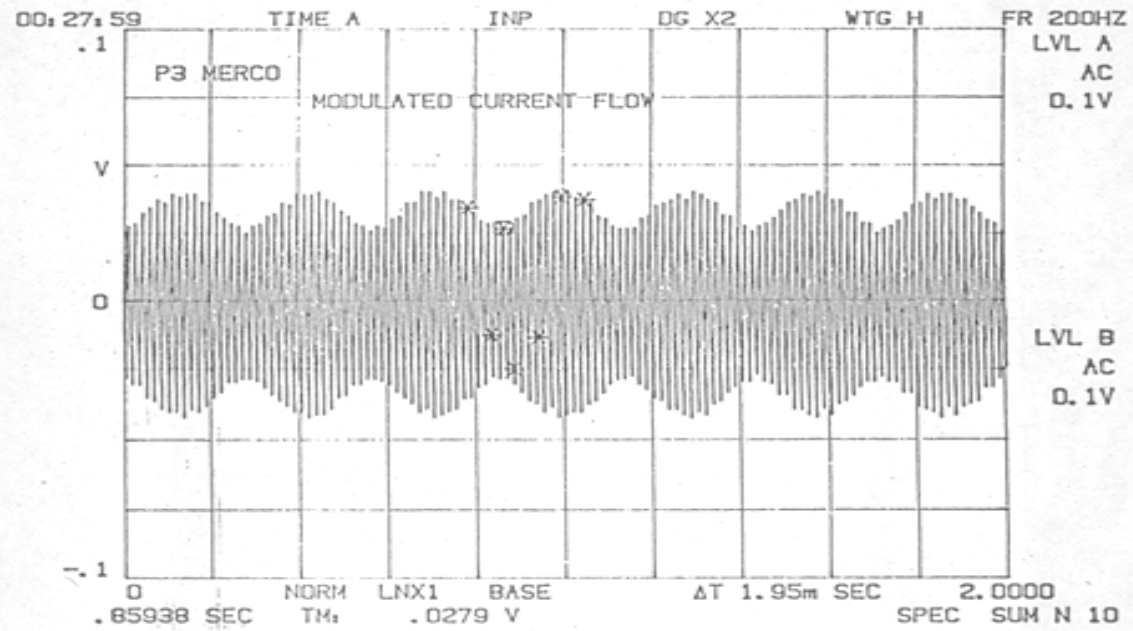
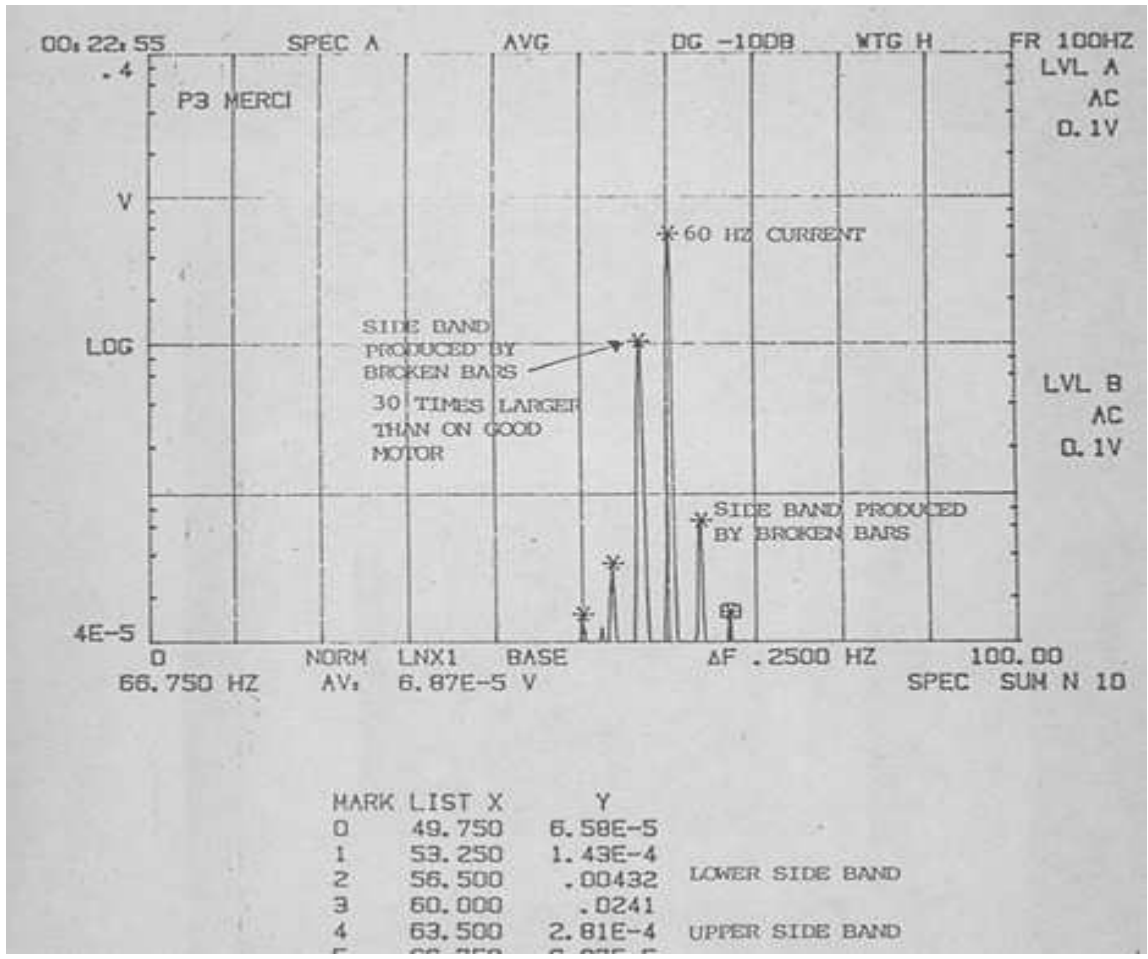

FIGURE 1



MARK LIST X Y
0 .77734

THIS FIGURE SHOWS THE MODULATION OF THE CURRENT GOING TO THE P-3 MERCO MOTOR. FOR A HEALTHY MOTOR, THE CURRENT WILL FLOW STEADILLY. WHEN BROKEN BARS ARE PRESENT, THE IMPEDENCE VARIES AS THE MAGNETIC POLES GO PAST THE BROKEN BARS. THIS CAUSES THE VARIATIONS IN MOTOR CURRENT. THE POLES PASS AT THE RATE OF THE NUMBER OF POLES TIMES THE SLIP FREQUENCY.



PHOTOGRAPHS OF DAMAGE
TO P-3 MERCO MOTOR ROTOR

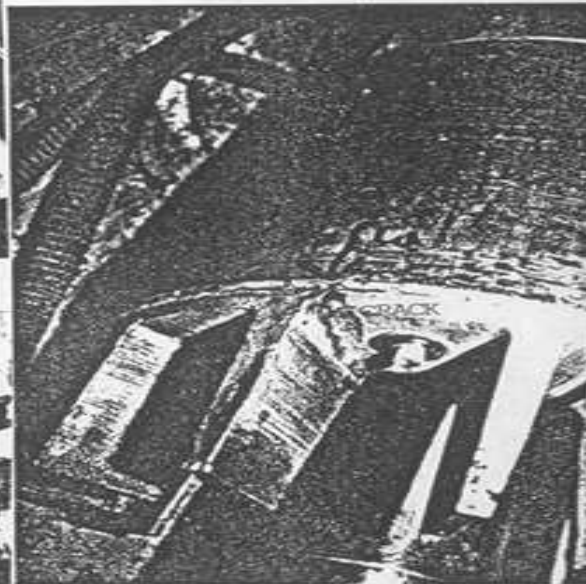
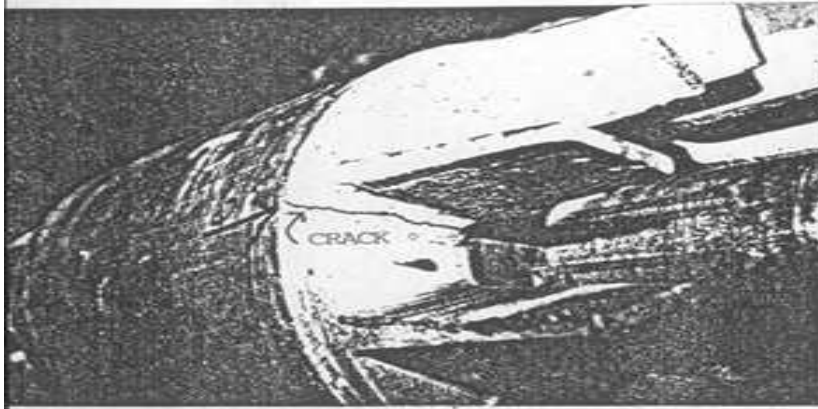
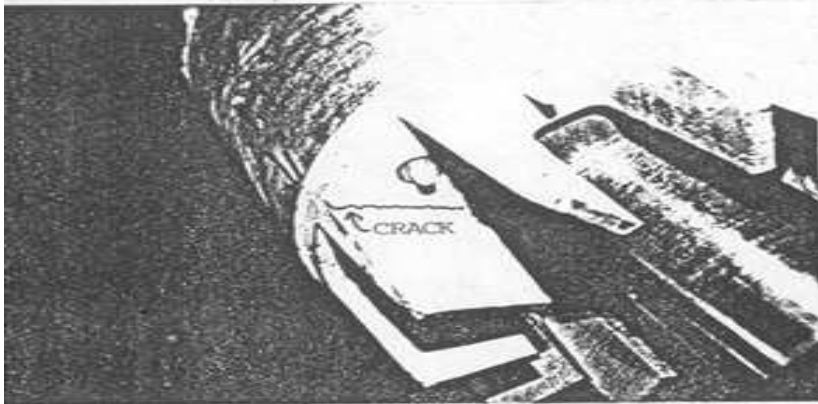

2: Beware of cast aluminum rotors. Cast aluminum rotors will sometimes have voids that will cause false positives of the above described side band test. When in doubt, test the motor over several starting cycles to determine if the level is stable or getting worse.

3: Pole modulation- If the number of spiders in the rotor equals the number of poles, the current will modulate and look just like a broken rotor bar is present. The way to tell if this is the case is to vary the load on the motor. If it is pole modulation, then the side band ratio will be higher at low load. If there is an actual broken bar problem, the opposite will be true. When a broken bar is present the degree of modulation will increase at higher loads. Case History- A power plant had 8 pole motors on its FD fans. Every year a current spectrum test was performed to identify broken rotor bars. It was noted both FD fan motors had indications of what appeared to be broken rotor bars. The interesting thing was that the modulation was less at high loads than at low loads. The cause of the modulation turned out to be pole modulation. The motors ran for many years and never had any problems, even though an expert system program kept calling them out as having broken rotor bars.

4: Mechanical Modulation- Beware of motor current testing, if there is a speed reduction gearbox coupled to the motor. Low speed mechanical modulation will sometimes cause the current to modulate thereby mimicking a rotor problem. Always determine the motor speed to within 1 RPM, then calculate the number of poles times slip frequency side band frequency. If there is any variation in the calculated versus the actual frequency, then suspect mechanical modulation. Examples:

Case 1: Coal barge unloader. The rate at which the buckets dug into the barge of coal was exactly the number of motor poles times the slip frequency making it impossible to perform an accurate rotor bar analysis.

Case 2- In large coal mills, the rate at which the rolls pass over the rotating table is very close to the number of poles times the slip frequency. This has resulted in several mill motors being falsely called out as having bad rotor bars.

Case 3- A coal conveyor motor was called out as having rotor problems. It was discovered that the speed of the output gear was close to the number of poles times the slip frequency. The problem was with the gear instead of with the motor rotor. Very accurately determining the speed of the motor allowed a calculation to be made that determined that the modulating frequency was a match with the gear instead of the number of poles times the slip frequency.

5: Two pole and four pole motors with broken rotor bars will often cause number of poles times slip frequency side bands in both the current and vibration spectra. Higher pole lower speed motors, particularly those driving high inertia loads will create number of poles times slip side bands in the current spectra, but will in many cases not cause them to appear at all in the vibration spectra.

INDUCTION MOTORS VIBRATION TESTING

1: Rotor eccentricity- An eccentric rotor will of course result in unbalance. If the rotor is balanced, there can still be a problem of a rotating deviation in the air gap. This causes unequal pull on the rotor as the magnetic poles pass the rotating gap deviation. **This occurs at the number of poles times the slip frequency, which is the same frequency that is generated by a broken rotor bar.** Note that in neither case will this low (usually less than 1.5 Hz) frequency show up in the spectrum, but they can both appear as side bands of running speed in the vibration spectrum. The way to tell the difference between an eccentric rotor and broken rotor bars is to obtain a current spectrum. **A broken rotor bar will generate no. poles times slip frequency around the line frequency in the current spectrum where as the eccentric rotor will not.**

FIGURE 1
ZOOM PLOT OF CURRENT
WAVEFORM. LACK OF ANY
SIGNIFICANT SIDE BANDS
AROUND 60 HZ AT THE
NUMBER OF POLES(2) TIMES
SLIP FREQUENCY INDICATES
ROTOR BARS ARE OK.

ECCENTRIC ROTOR

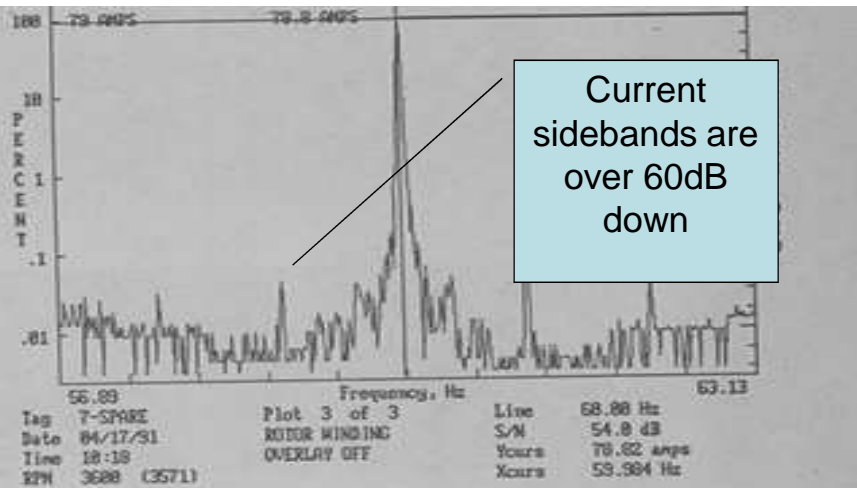

Current sidebands are over 60dB down

FIGURE 2
ZOOM PLOT OF VIBRATION
SPECTRUM. SIDE BANDS AT
2 TIMES SLIP SUGGEST
EITHER ROTOR BAR PROBLEMS
OR ECCENTRICITY. SINCE
CURRENT WAVEFORM ZOOM PLOT
ABOVE RULED OUT ROTOR BARS,
THE PRIME CANDIDATE IS
ECCENTRICITY.

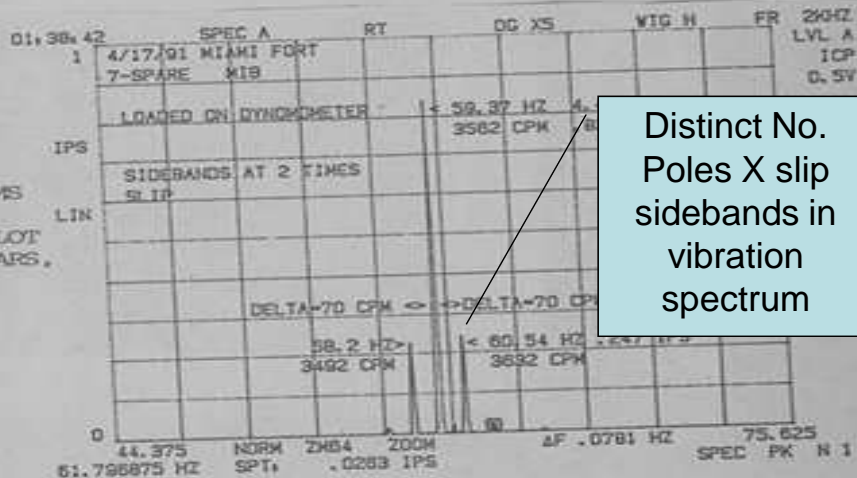

Distinct No. Poles X slip sidebands in vibration spectrum

FIGURE 3
COAST DOWN PLOT IN PEAK
HOLD SHOWING THE RAPID DROP
OFF OF VIBRATION. THIS
INDICATES THAT THE ROTOR
MAY BE OPERATING NEAR A
NATURAL FREQUENCY.

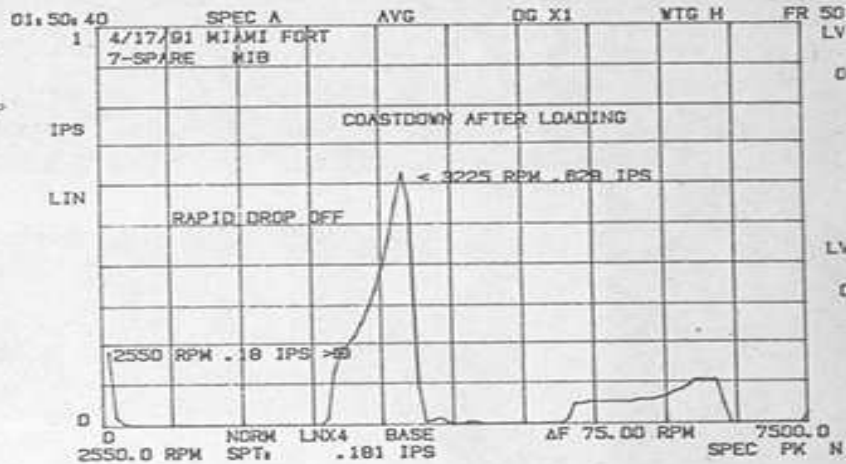
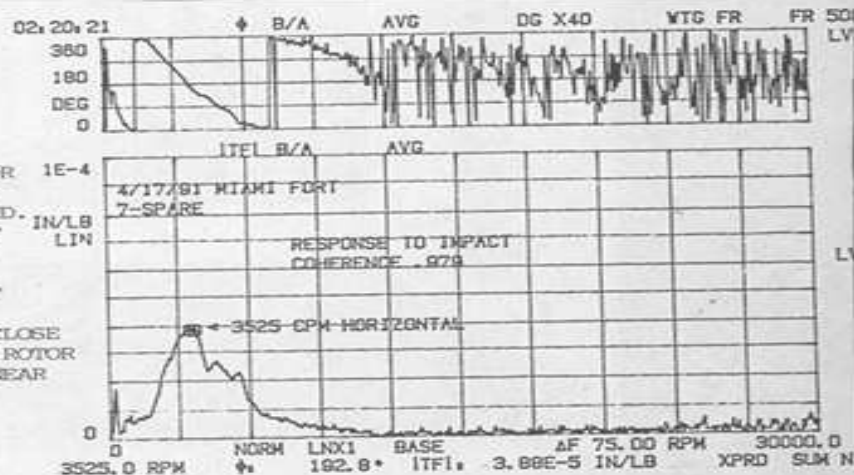

FIGURE 4
FREQUENCY RESPONSE PLOT
THIS PLOT SHOWS THE
RESPONSE OF THE MOTOR ROTOR
TO AN IMPACT. A 3525 CPM
NATURAL FREQUENCY WAS FOUND.
THIS WOULD CHANGE SOMEWHAT
WITH THE ROTOR SPINNING
IN ITS BEARINGS DUE TO
GYROSCOPICS AND THE EFFECT
OF THE BEARING OIL FILM.
IT IS NONE THE LESS VERY CLOSE
TO OPERATING SPEED SO THE ROTOR
IS UNDOUBTEDLY OPERATING NEAR
ITS FIRST BENDING MODE.



2: New high efficiency motors are much more susceptible to soft foot than older heavy frame motors.

3: Large 2 pole motors that have shorted laminations can have very high levels of thermal vectors that cause the amount of unbalance to vary with load. Case History- A 4000 Hp motor in a power plant was overhauled. After the overhaul, the motor vibration would increase and the bearings would be destroyed. The plant sent the motor back to the motor shop for balancing, but upon return, it again wiped out the bearings.

The motor was then sent to the manufacturer to be balanced in a high speed balance pit. Upon return, it again wiped out the bearings. Solution-

Proximity probes were installed on the motor and the amplitude and phase were monitored as the motor was loaded. The motor had an 8 mil thermal vector. The motor was compromise balanced and ran for several years. It was discovered that the original motor shop that overhauled the motor had dropped the rotor and damaged some of the laminations. The eddy current heating in the shorted laminations had caused the rotor to bow thereby causing the large thermal vector. If this condition is suspected, induction heating the rotor then looking at it with an infrared camera will allow the hot spots to be seen.

THERMAL SENSITIVE MOTOR

Station: UTILITY Protractor Numbered: CW Rotation: CCW
 Unit: 3 Viewed From: IB Viewed From: IB
 Location: REP MOTOR Instrument Lag: 0° Test Equipment: M-747

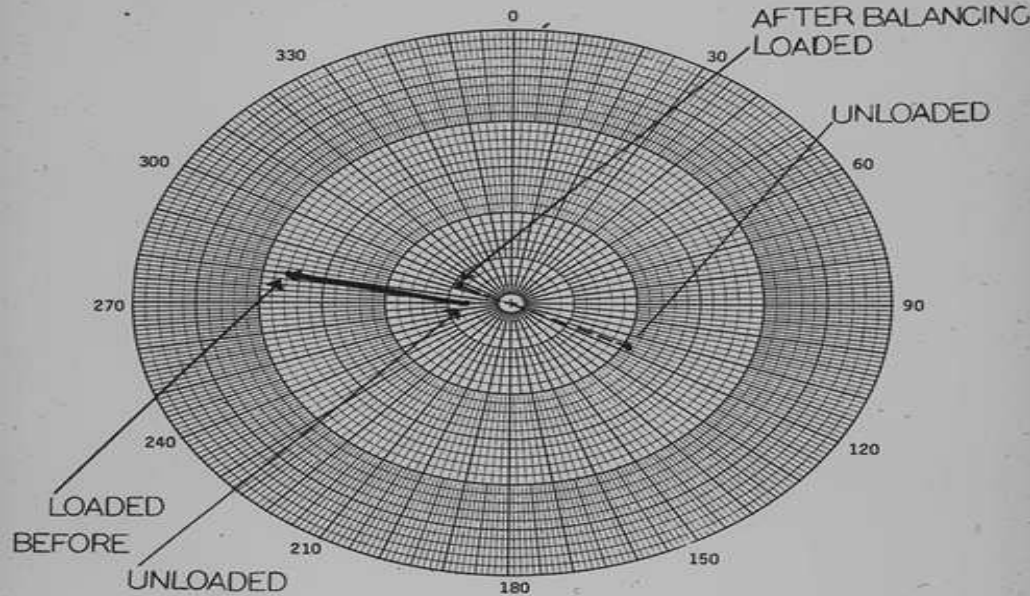

Date readings were taken:

Operating Conditions: UNLOADED TO LOADED

	Amplitude	Phase	Corrected Phase
Bearing # <u>IB</u> UNLOADED	<u>15</u>	<u>270°</u>	<u>270°</u>
Bearing # <u>IB</u> LOADED	<u>22</u>	<u>280°</u>	<u>280°</u>

Description of weight change: 200 GMS. AT 90°

Date readings were taken:

Operating Conditions: UNLOADED TO LOADED

	Amplitude	Phase	Corrected Phase
Bearing # <u>IB</u> UNLOADED	<u>41</u>	<u>118°</u>	<u>118°</u>
Bearing # <u>IB</u> LOADED	<u>19</u>	<u>325°</u>	<u>325°</u>

Notes: 5.6 MIL THERMAL CHANGE

DC MOTORS

1: D.C. MOTORS- The spectrum of the current to a D.C. Motor can be used to find problems with SCRs or firing circuits. The rectifier input supply frequency (50 or 60 HZ) times 6 for 3 phase full wave rectifiers will normally be present in the current spectrum. **When 1/3 or 2/3 of the firing frequency is present, it indicates failed SCRs or firing circuits.** It is much simpler to look at the current spectrum or current waveform than to try to see the problem with vibration. Vibration is a secondary effect reflecting the problem which is actually of electrical origin.

1/2 HALF WAVE RECTIFIER

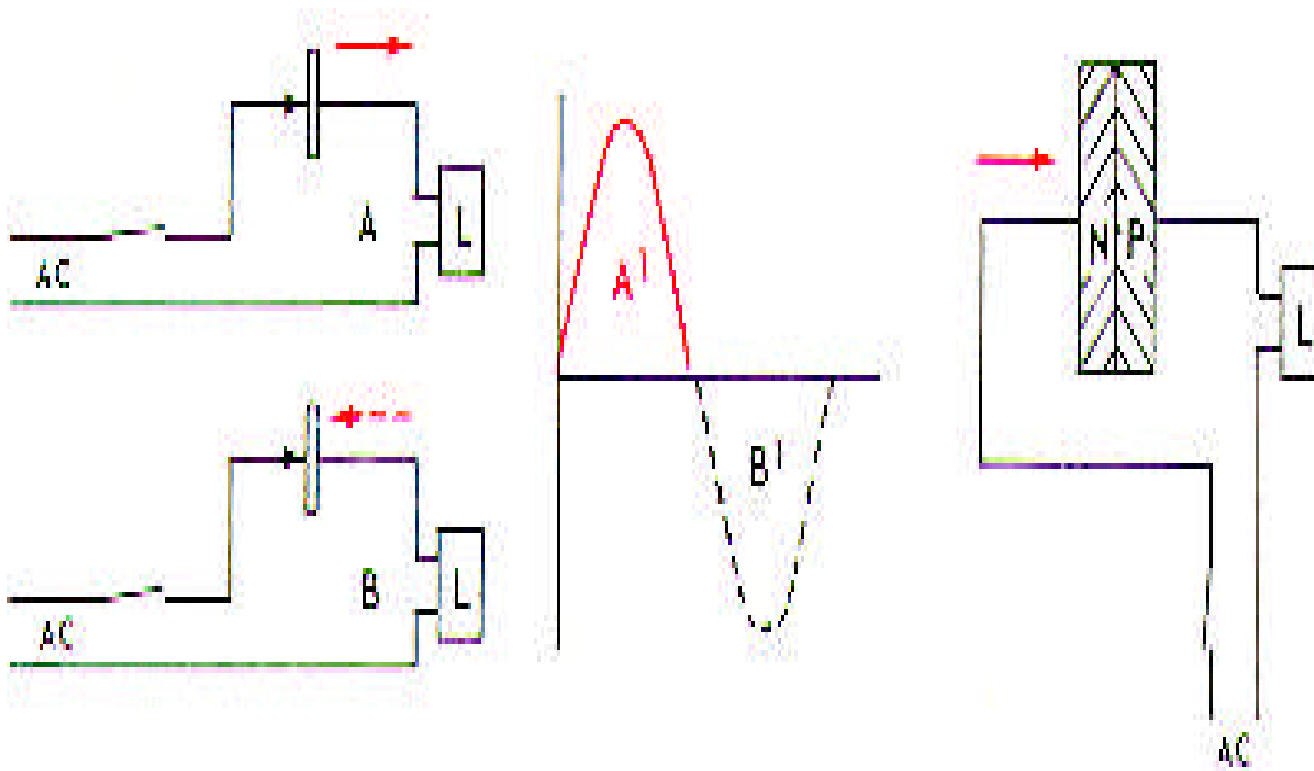

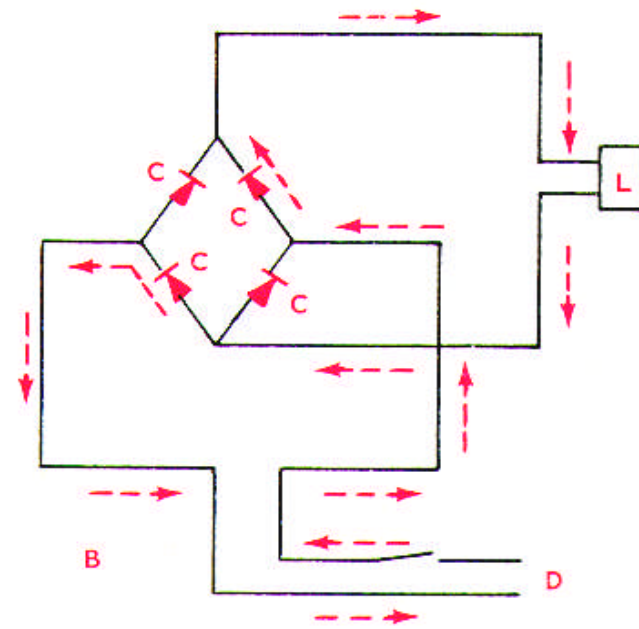
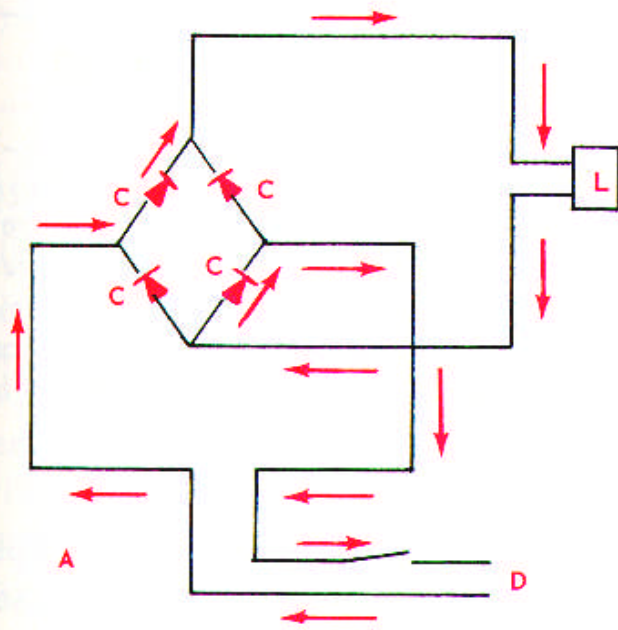
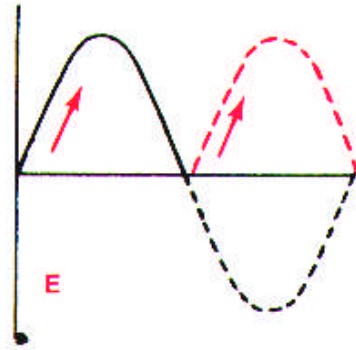

WHAT DOES THE
CURRENT PATTERN OF A
NORMAL DRIVER LOOK
LIKE

**CURRENT WAVEFORM FROM FAN PUMP DRIVE
NORMAL PATTERN
FOLLOWING REPLACEMENT OF FIEL SCR**

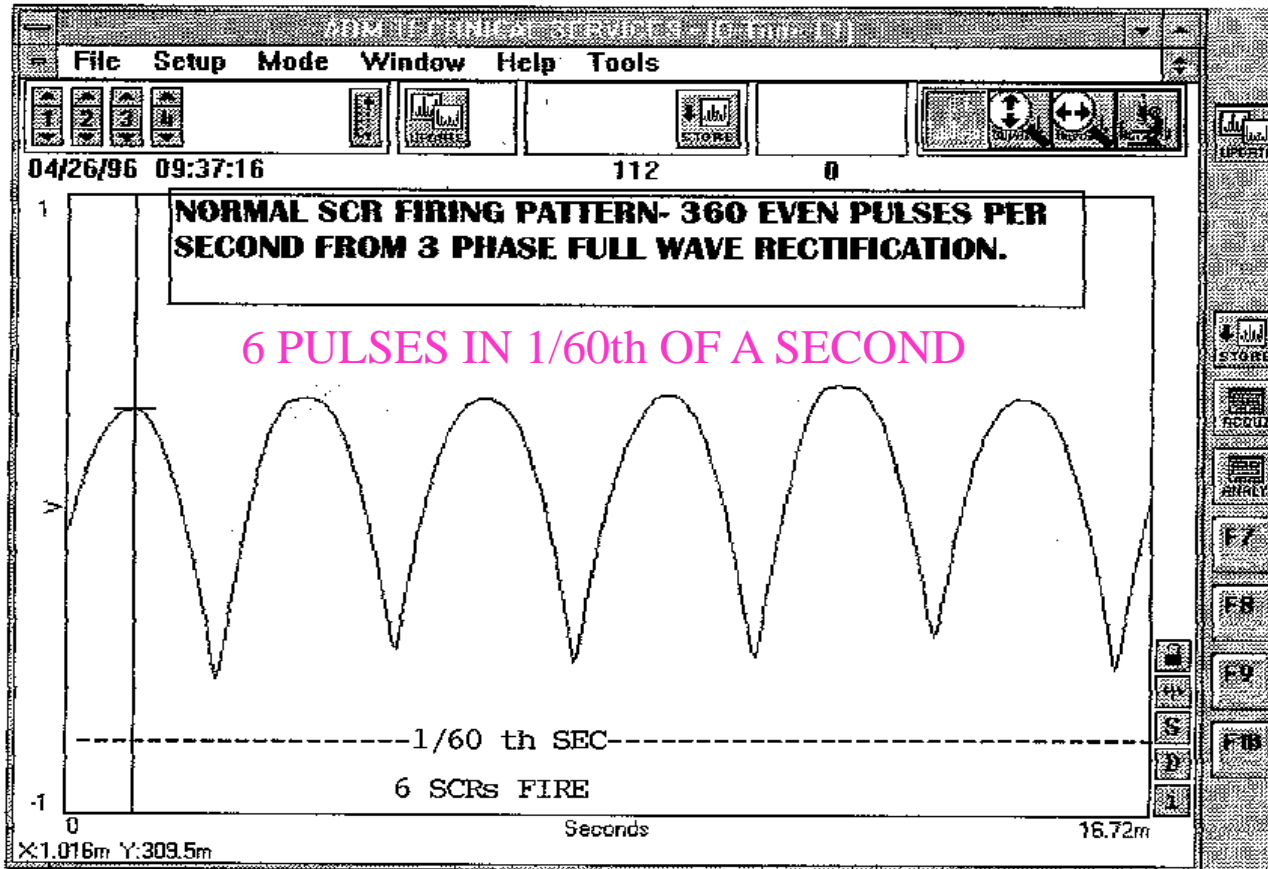

WHAT DOES THE
WAVEFORM OF A BAD
DRIVE LOOK LIKE ?

THIS IS AN EXAMPLE OF 2 SCRs NOT FIRING IN A FULL WAVE RECTIFIED DC DRIVE
 FILE IS STORED UNDER SCRMISS.WAV

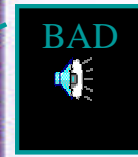
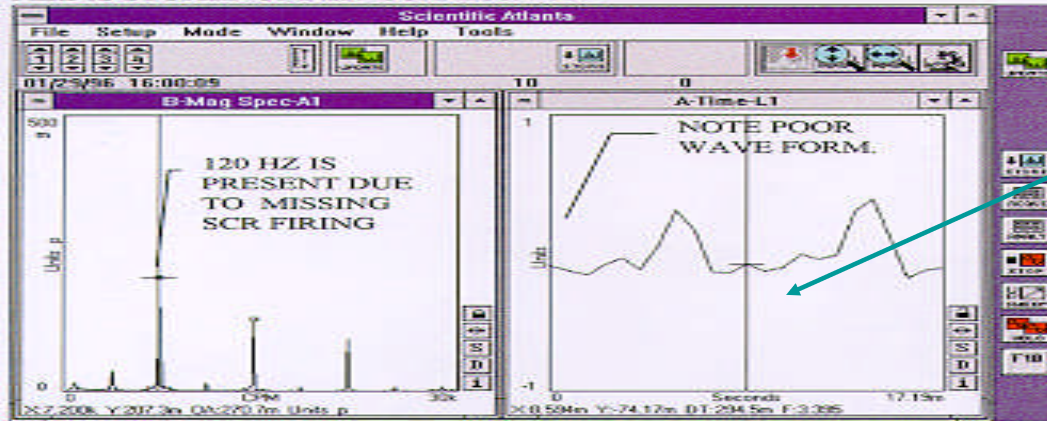

BELOW IS WHAT A PROPER WAVE FORM WITH ALL SCRs FIRING NOTE SIX PULSES IN 16 MSEC. PERIOD= 6 X 60 CYCLES/SEC WHICH IS PROPER FULL WAVE 3 PHASE SCR FIRING FREQUENCY.

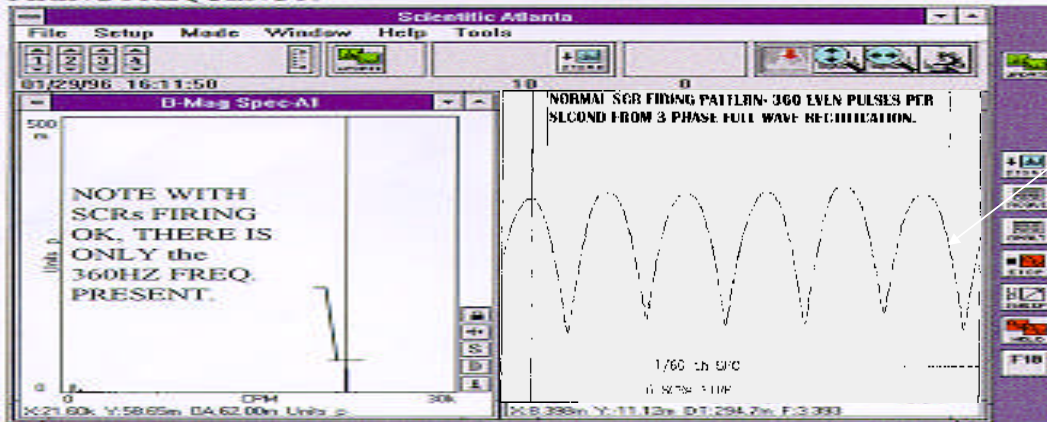

FEBRUARY 18, 1998
VISY FAN PUMP DRIVE
250 AMP LOAD

WHEN SCR'S WERE REPLACED, THE WAVEFORM AND SPECTRUM RETURNED TO NORMAL.

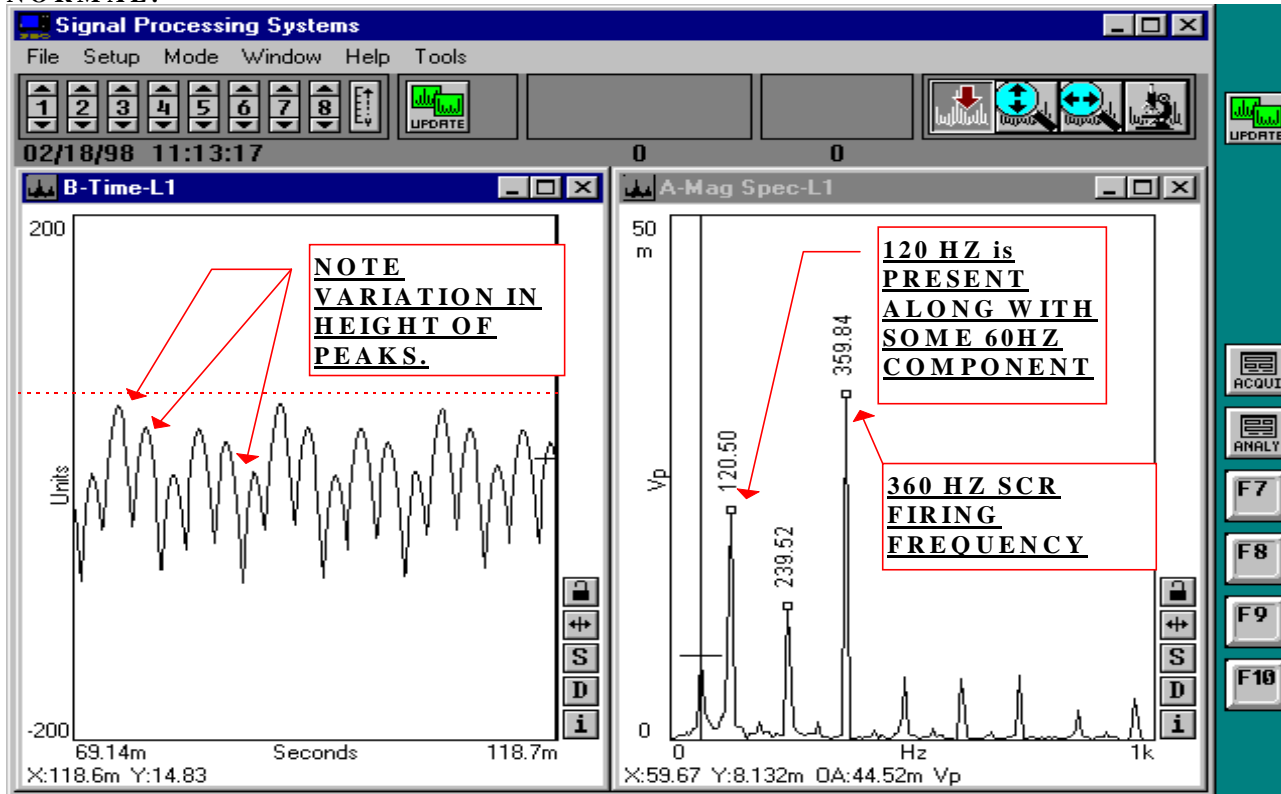

2: D.C. MOTORS- The current spectrum from a D.C. Motor can also be used to find tuning problems with D.C. Drives. Improperly tuned drives will produce frequencies at the oscillation rate of the instability. These frequencies can also appear in the vibration spectra and are very difficult to analyze since they do not have a mechanical origin. These oscillation frequencies are unpredictable. They are a result of the interaction between the rotating inertias of the mechanical components, the torsional stiffness of the shafts and the tuning of the electrical control system. If a completely unexplainable frequency appears on a drive, then it may well be due to this complex interaction.

BAD TUNING, WHERE
SPEED IS CONSTANTLY
MOVING UP AND DOWN.

**CURRENT WAVE FORMS FROM MAIN POWER CABLES TO
PRESS DC DRIVE MOTORS.**

**2nd PRESS CURRENT WAVEFORMS
BEFORE ADJUSTMENTS AFTER ADJUSTMENTS**

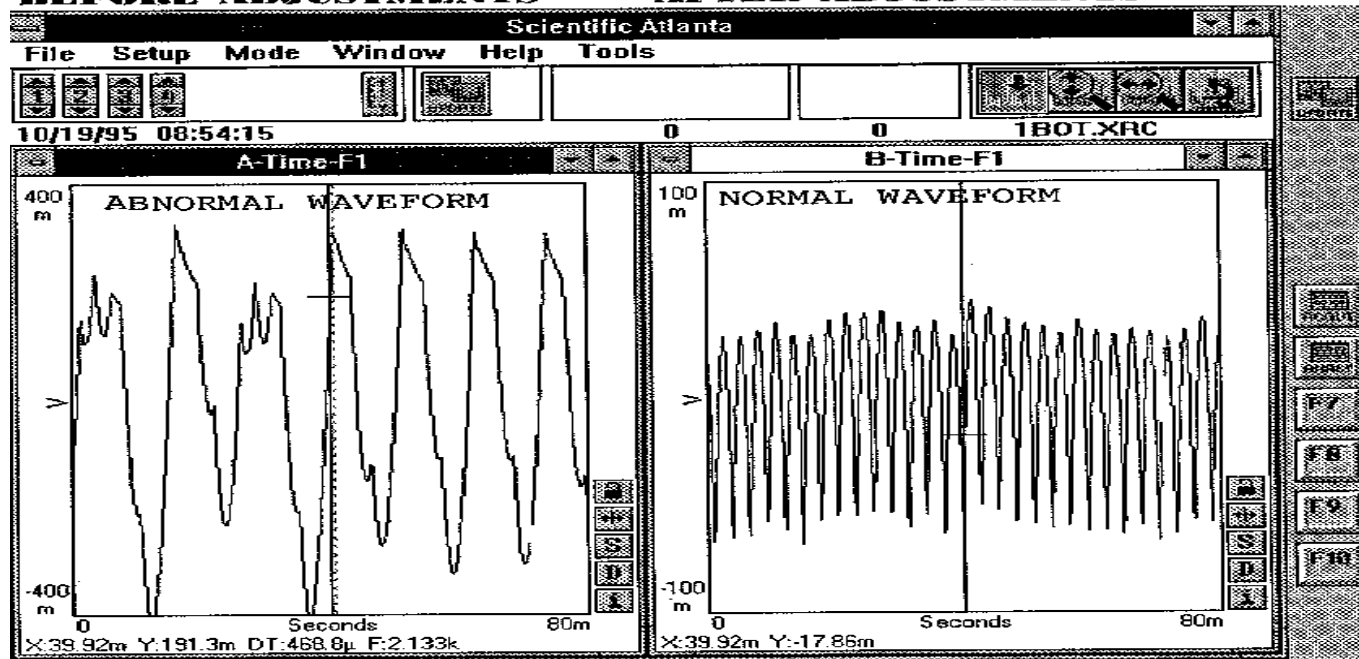

The upper left time plot of the motor current shows what was present on the 2nd press bottom drive prior to making adjustments to the drive. The figure to the right is from the 1st press bottom drive. The next page shows the FFT transform of the above data.

COMPARISON BETWEEN ABNORMAL CURRENT SPECTRUM FROM POORLY ADJUSTED DC DRIVE AND WELL TUNED DRIVE.

2nd BOTTOM DRIVE BEFORE ADJUSTMENTS 2nd BOTTOM DRIVE AFTER ADJUSTMENTS

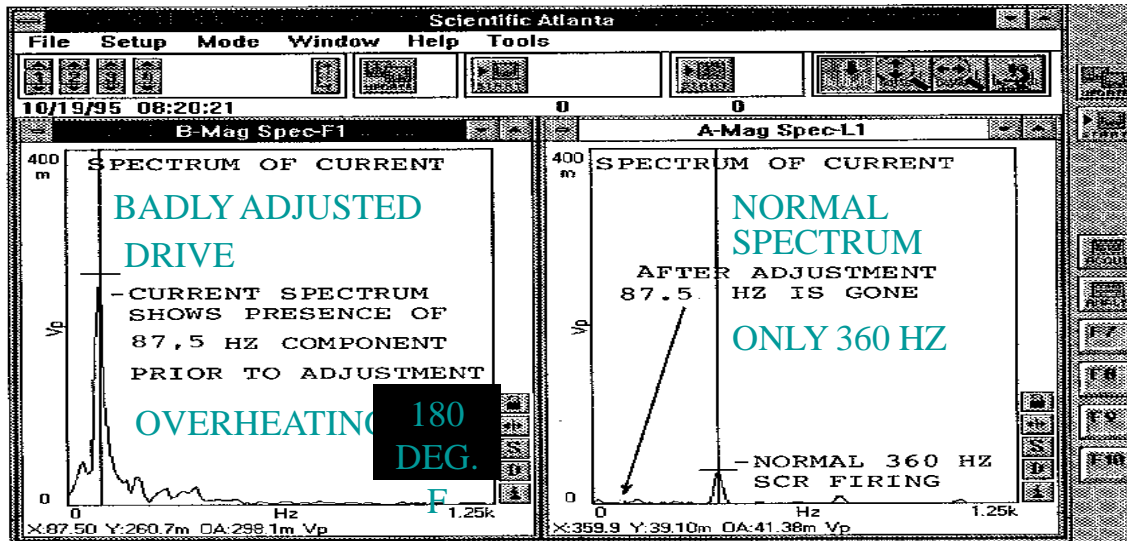

The spectrum on the left was taken from a current probe located on the 2nd bottom drive when the motor was vibrating at 1 inch/second and was operating at 180 degrees. The vibration signature showed a very high level of a 87.5 HZ frequency component, which is the identical frequency in the upper left spectrum.

The upper right spectrum was taken on the same motor after the drive controls were adjusted properly. Note that the only frequency which is present is the normal 360 HZ SCR firing frequency. The vibration on the motor dropped to below .1 in/sec and the 87.5 HZ component was no longer present after the drive was tuned properly.

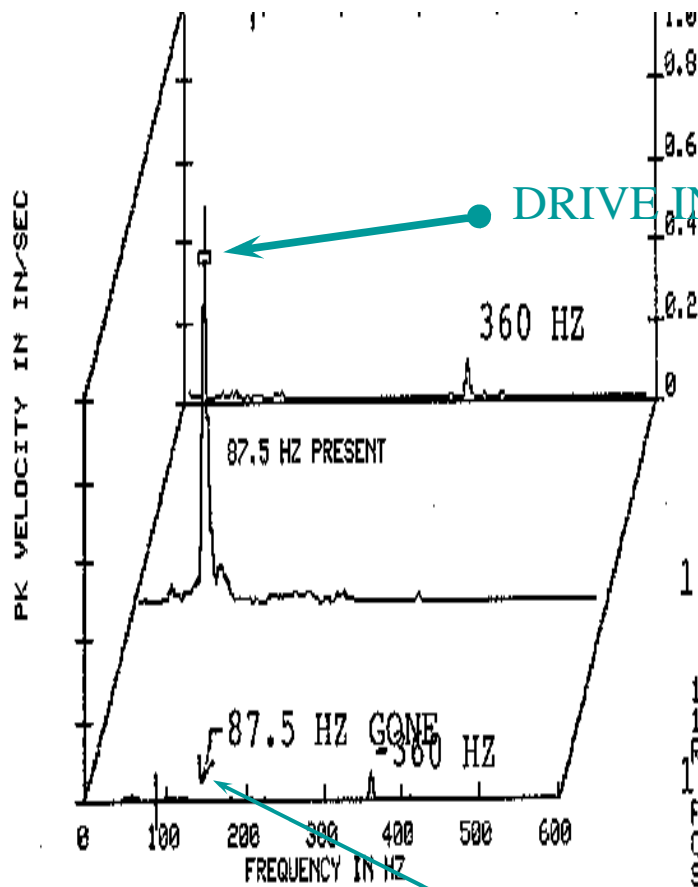

ADJUSTING TO STATE

DRIVE INSTABILITY

27 SEPTEMBER 1995
BEFORE PROBLEM

17 OCTOBER 1995
DURING PROBLEM

17-OCT-95
15:30:21
RPS= 60.00
18 OCTOBER 1995 AFTER ADJUSTMENTS
FREQ: 87.50
ORDR: 1.458
SP 2: .851

AFTER TUNING

SOMETIMES THE
PROCESS CAN CAUSE THE
DRIVE TO APPEAR
UNSTABLE

3: DC MOTORS- Unknown frequencies in the spectrum of the current going to a DC drive can originate from other mechanical equipment in the drive train. Case History- The current on a couch roll of a paper machine had an unknown component in its spectrum. It turned out to be the vane pass frequency of the fan pump located several yards away in the basement. The fan pump was causing pressure pulsations in the head box that caused the paper to be deposited in varying thicknesses. As the thicker material passed over the vacuum rolls, this caused the tension to increase which changed the tangential force on the couch roll which in turn caused the current draw to the couch roll to modulate at that rate.

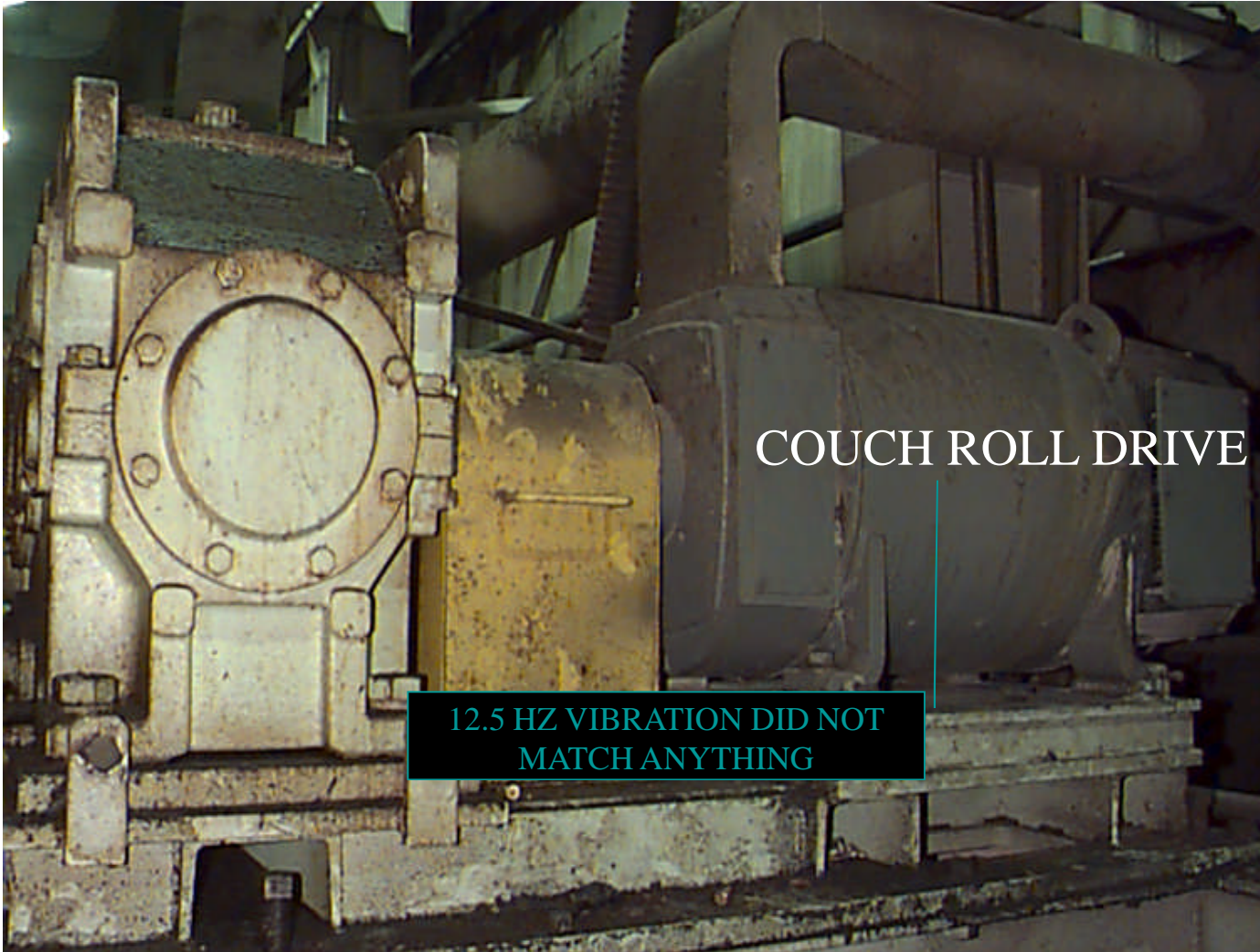

COUCH ROLL DRIVE

12.5 HZ VIBRATION DID NOT
MATCH ANYTHING

MAY 25, 1996 COUCH ROLL DRIVE A1 LEAD CURRENT

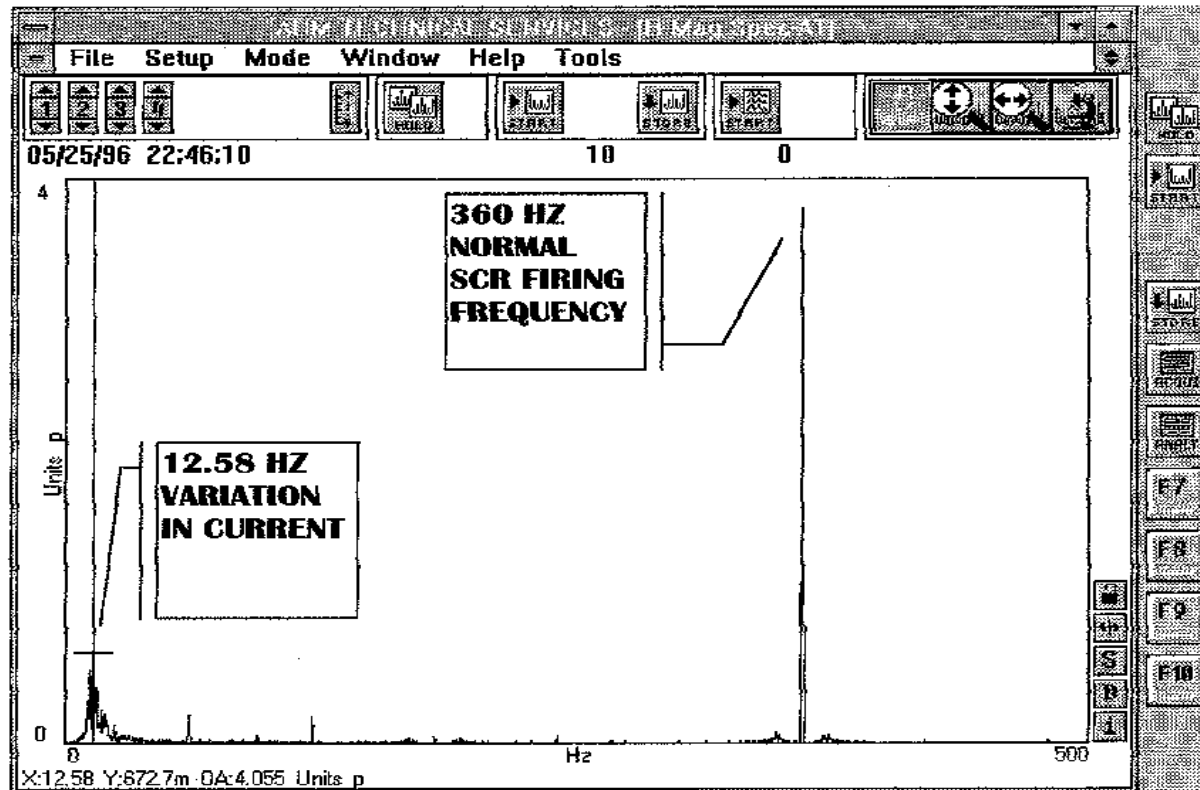

12.58 HZ SIGNAL MATCHES VANEPASS OF FAN PUMP

5: DRIVE ROLL VIBRATES AT VANE PASS
DUE TO CHANGES IN TENSION AND MOTOR
CURRENT VARIES AT SAME RATE.

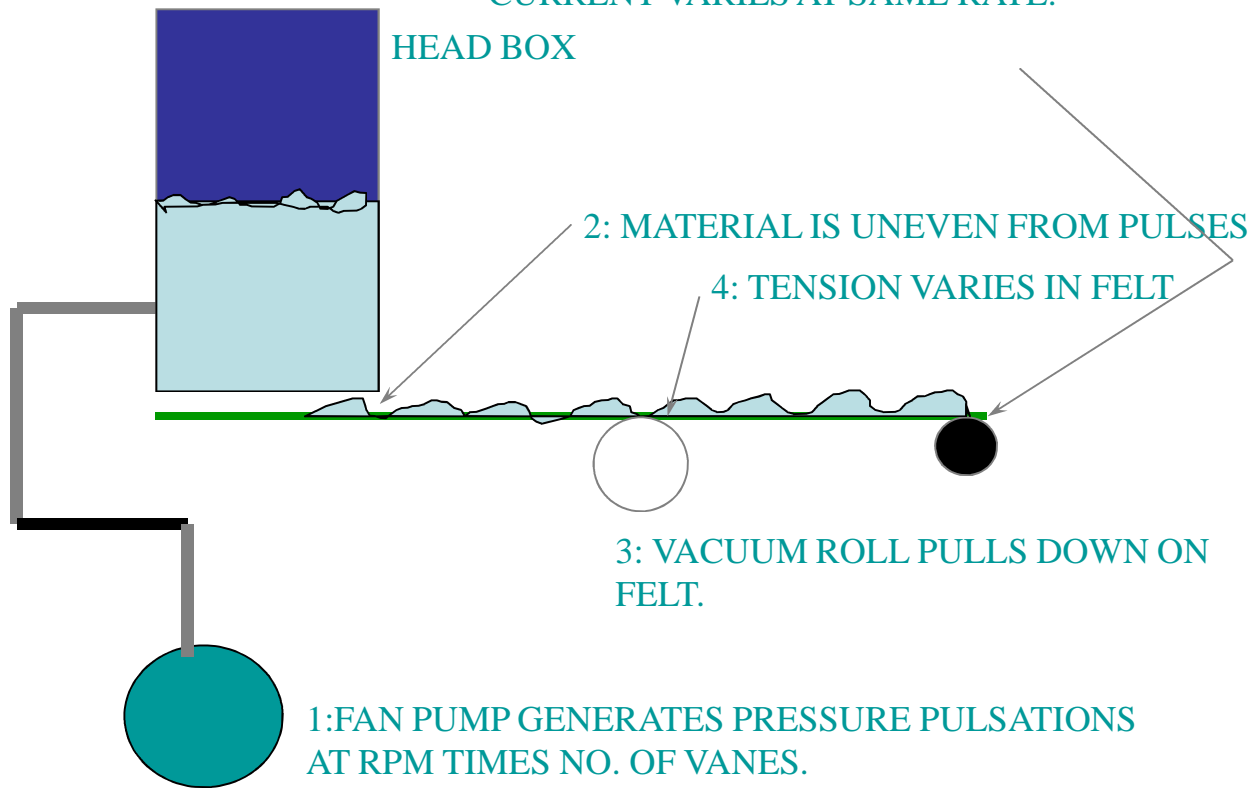

VARIABLE FREQUENCY DRIVES
CAN CAUSE PREMATURE
BEARING FAILURES

1: Line length is a factor in voltage spikes. Rapid switching of inverters causes voltage spikes that can be amplified by longer line lengths

2: Solutions to minimize bearing failures that result from VFD problems.

A: Lower the firing frequency of the inverter The switching speed is a critical factor in regards to VFD drive problems. "When VFD drives were first introduced in the eighties, there were few field problems. The carrier frequencies were generally below 2.5 kHz. As the switching frequencies increased, the number of problems also went up

B: Keep the line length between the inverter and the motor as short as possible.

C: Insulate bearings- Both bearings need to be insulated. In addition, the coupling must also be insulated or the current can travel through the coupling to the driven unit's bearings and then to ground.

D: Shaft Grounding- Grounding the shaft with carbon brushes allows the potential to travel to ground. The problem with this approach is that brushes need to be maintained. If the brushes wear out, then the current will again start flowing through the bearings.

E: Conductive grease- Conductive grease allows the current to drain off rather than building up to a destructive potential. The downside to conductive grease is that it has been reported that bearing life is not as long as with standard grease.

F: Ceramic Bearings- Since ceramic bearings are nonconductive, they are another method of achieving electrical isolation between the rotor and the frame. Do not forget to insulate the coupling.

G: Output filters- These devices filter out the unwanted high order harmonics.

H: Isolation Transformers- "An isolation transformer with a delta primary and a wye secondary will greatly reduce common mode voltages within a drive and motor system.

GEARBOXES

1: Gear boxes which have common prime factors between the teeth of intermeshing gears can produce sub harmonics of the tooth mesh frequency.

Case History- A large drag line gear box had 1 in/sec of exact $\frac{1}{2}$ tooth mesh vibration. **It was discovered that there was a common prime factor of two on the pinion and bull gear.** The pinion was worn badly . When the pinion was replaced, the $\frac{1}{2}$ tooth mesh vibration disappeared.

2: Side bands are often the result of modulation by a defective component in a gear box. However, beware of making hasty conclusions when analyzing a planetary gear box, where modulation naturally occurs due to a continually varying transmission path caused by rotation of the planetary gears. Jack Frarey

3: Non-linear modulation resulting from looseness can generate families of side bands. The worse the looseness, the greater the number of side bands.

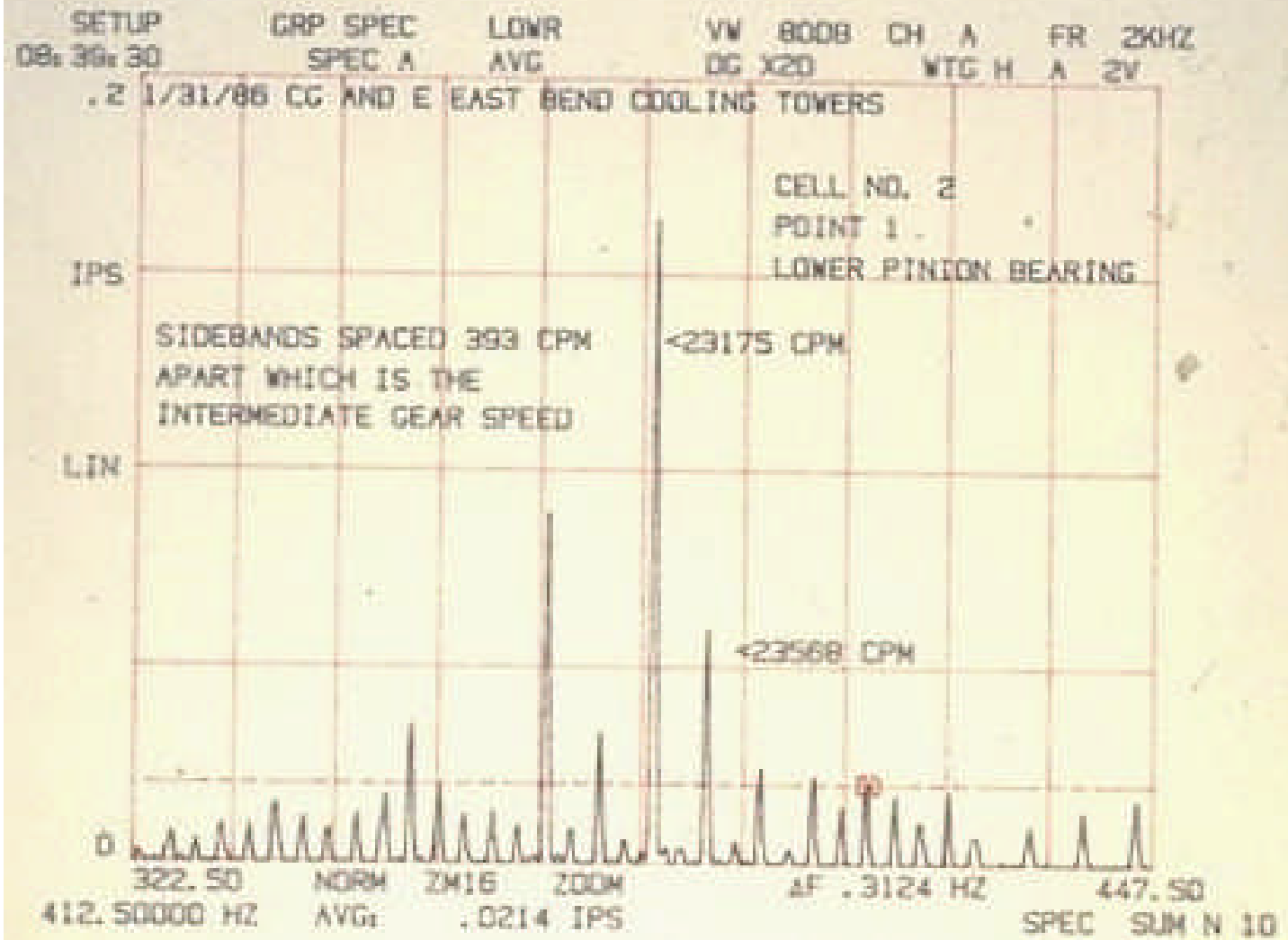

TORSIONAL VIBRATION

- 1: When making torsional measurements, pulse trains need to be placed on anti-nodes and strain gauges installed on nodes.
- 2: As a synchronous motor comes up to speed, the torsional stimulation will start out at 120 HZ and then drop off in frequency as the motor comes up to speed.
- 3: If a torsional natural frequency needs to be altered, then the most likely place to make a modification whether it be stiffness or damping is in the coupling.

FANS

1: Always take an axial reading on the bearing that absorbs the thrust.

2: If a fan is mounted on isolation springs, then lock up the isolators prior to balancing.

3: On large sleeve bearing fans, excessive motion of the shaft can be the result of the plunger hold down bolts being loose. This condition can be picked up by either a shaft stick reading or a proximity probe. The casing level may be moderate, but the shaft motion can be severe. For instance, there may be three mils of vibration on a large fan's bearing housing and maybe 15 mils on the shaft. If the bearing clearance is only .008" then it is a good bet that the bearing is moving within the housing. Tightening up the plunger bolt will raise the casing motion and reduce the absolute shaft motion. Once this is done, it will be possible to balance the fan. In the case where the bearing can move within the housing, the system is highly nonlinear and balancing is almost impossible.

4: Large airfoil blade fans have hollow blades. These blades can fill with dust or even worse with water when they are pressure washed.

OIL WHIRL

Oil Whirl

1: If oil whirl occurs, check bearing clearances, oil temperature and alignment. Any of these can cause a marginal system to whirl. If these simple field fixes do not work, then call a bearing expert.

There are too many things involved in bearing design to try to do it yourself.

2: Oil whirl will remain oil whirl until the machine reaches a speed of twice the rotor's natural frequency at that point it can turn into oil whip. Even if the speed is increased, the whip frequency will remain locked in at the shaft critical speed. (note the critical speed will change slightly as the speed increases due to oil film stiffness and gyroscopics that change with speed).

LOW STIFFNESS PROBLEMS

TROUBLE BREWING

EXPANSION JOINTS

PRESSURE PULSATIONS

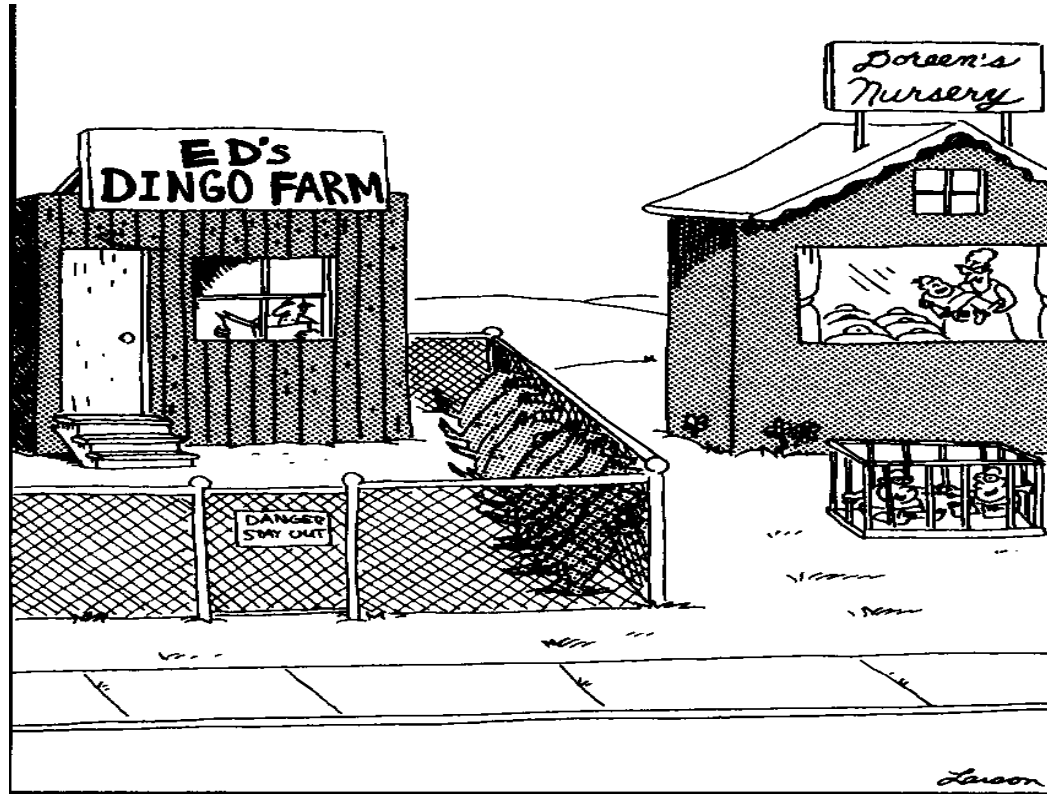

Trouble brewing

1: Beware of expansion joints when dynamic pulses are present. Also beware of long bolts holding expansion bolts together. Expansion joints have very low stiffness, so small pressure pulsations can result in large axial movements. Long bolts can have low stiffness values. $K=EA/L$ If L is big, then K is small. The combination of a large expansion joint restrained by long bolts can result in very high levels of vibration if pressure pulsations are present. Case History - A pipe in a refinery had over 2.3 inches per second of vibration at 4500 CPM on its end cap which was mounted past an expansion joint. Pressure pulsation from throttling by a valve caused high amounts of motion due to the large area (1075 square inches) on which the pulses acted combined with 20 ft. long restraining bolts that had low K values.

WHY AM I IN THIS BUSINESS?

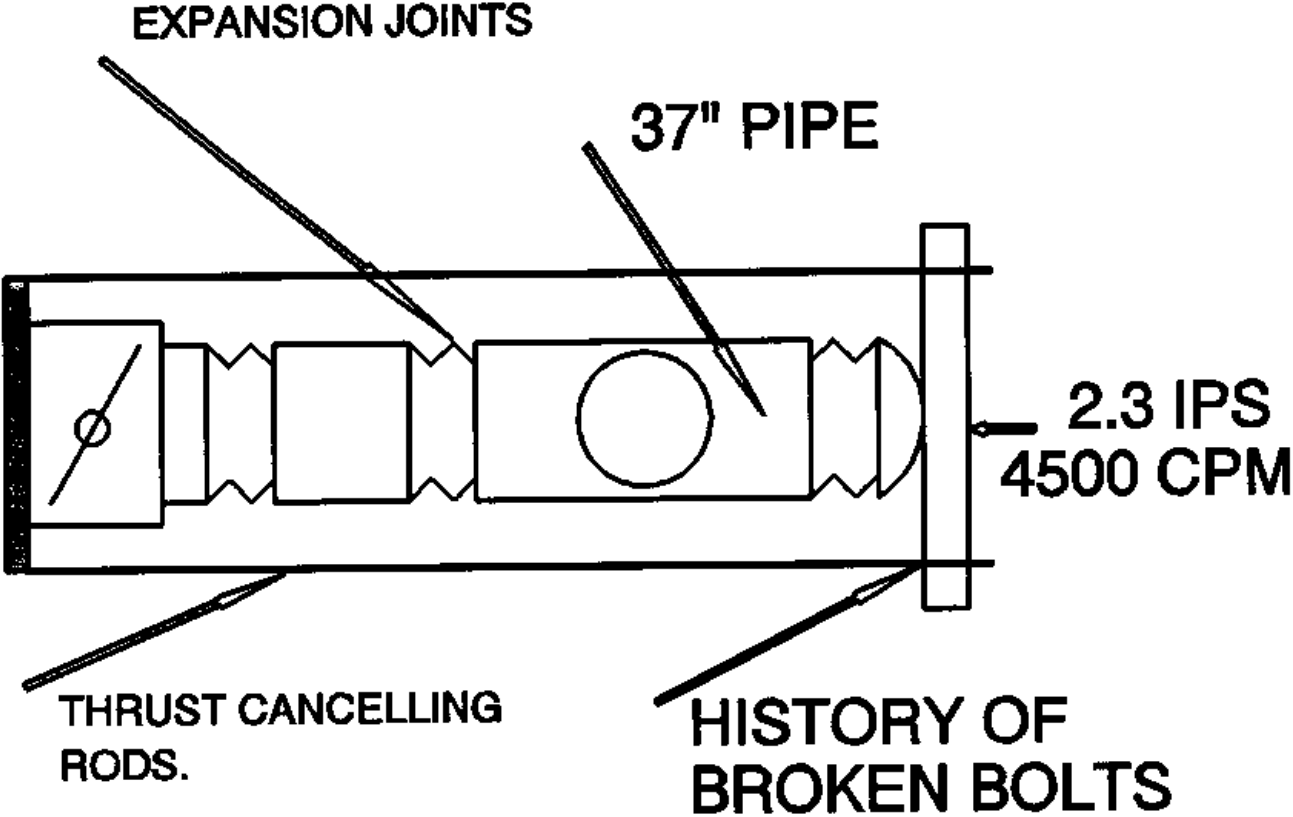

SOLUTION

- A 37" pipe has an area of 1075 square inches.
- Stiffness of bolts is EA/L
- Partially closed butterfly valve was generating broad band noise that caused pipe to resonate.
- Missing baffle allowed pressure pulsations to move end cap.

MISSING COMPONENT

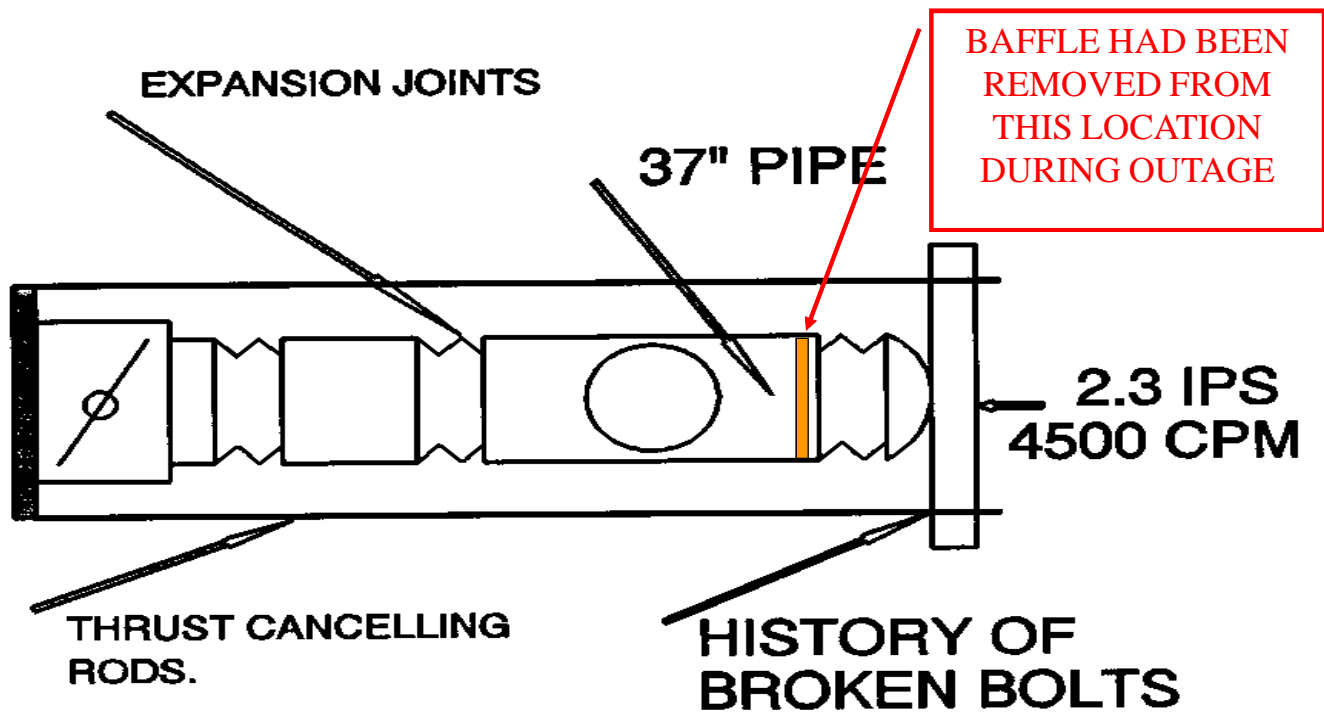

IMPORTANT POINTS

- 1: Large areas can generate large forces
- 2: Expansion joints allow those large forces to generate high levels of vibration
- 3: Long bolts are not very stiff
- 4: Do not remove components you do not understand. Just because it is full of holes does not mean that it is not needed.

2: Beware of large thin surfaces that are subject to pressure pulsations. Case History- A 6' by 8' window was vibrating excessively in a large building. The thinness of the window meant that its stiffness was very low. This in combination with its large area combined to produce large amounts of movement as a result of pressure pulsations from a loose heat exchanger coil that was vibrating in a duct feeding the atrium of the building.

PUFFS OF AIR

AT AN OFFICE BUILDING WITH AN ATRIUM
WINDOWS IN THE LOWER OFFICES WERE VIBRATING

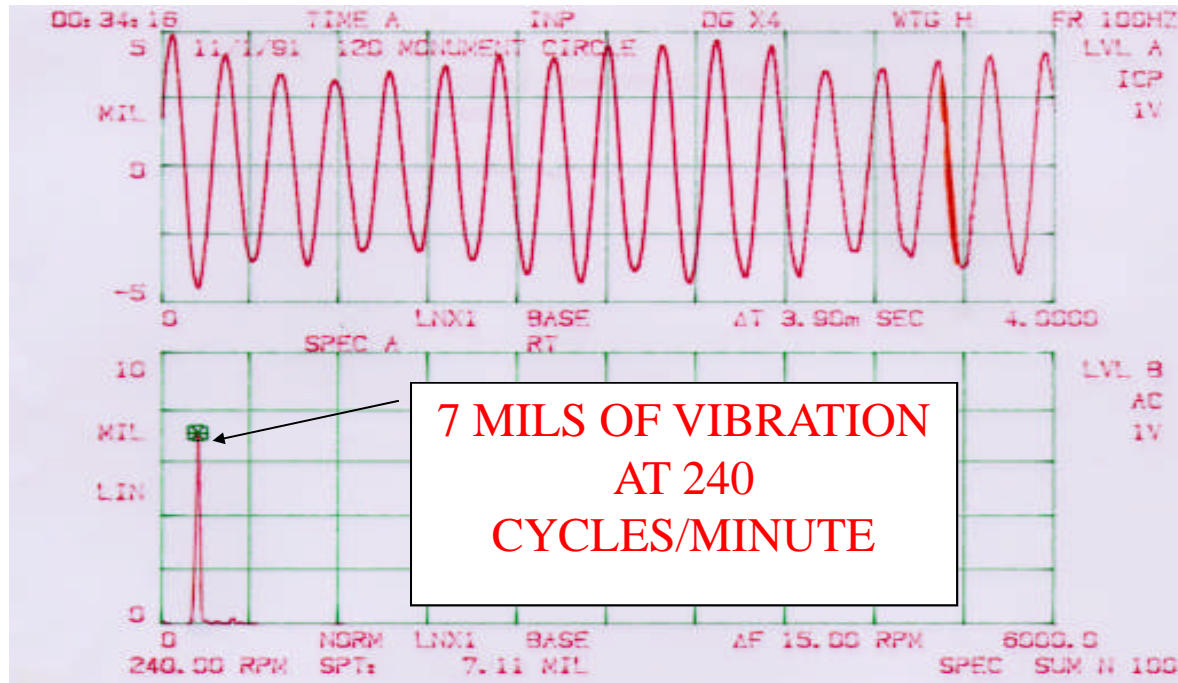

BUILDING LAYOUT

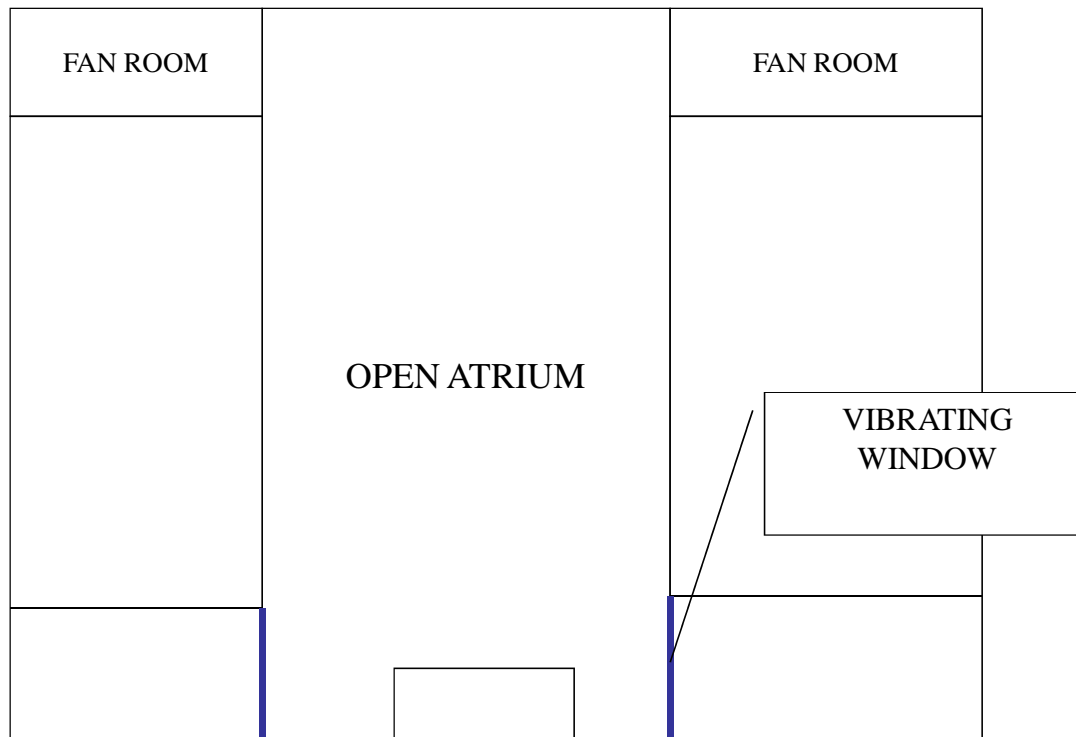

LOOSE COIL

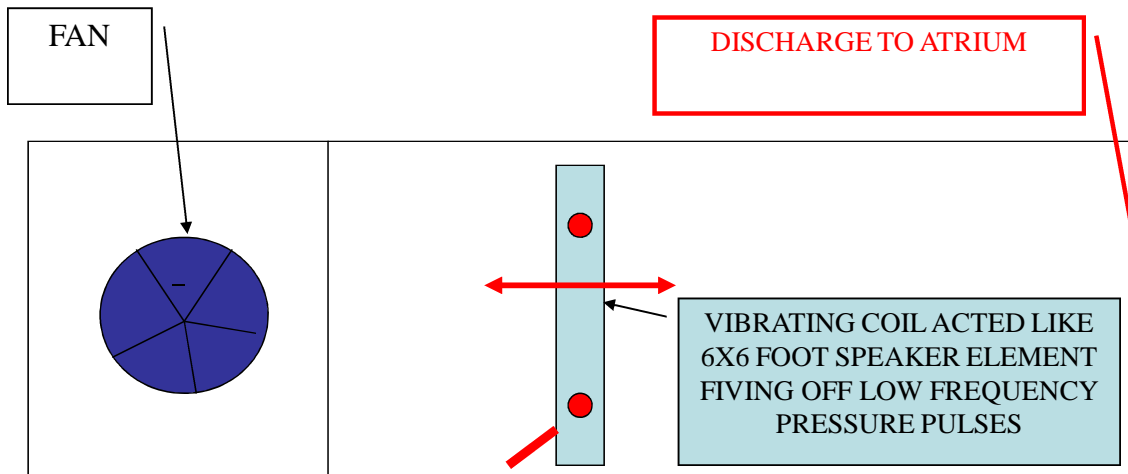

COIL WAS SUPPORTED BY ONLY SUPPLY AND RETURN PIPE. NATURAL FREQUENCY 240 CPM.

3: Even worse- Beware of large thin surfaces that have a natural frequency that equals that of a pressure pulsation. Case history- A large circular window had a natural frequency of 33 Hz which was the firing frequency of newly installed high efficiency boilers. The exhaust stack from the boilers was located only a few feet from the window. The window had extremely high levels of movement which in turn generated a very high level of 33Hz sound in the building which annoyed the people who were occupants of this large sub-woofer of a building. To make matters even worse, the stair well leading up to the window was exactly one wave length of the 33 Hz signal. Solution- Exhaust stacks were lengthened to a point well above window.

SOUND PROBLEM FROM FURNACE

At a university, the new alumni office was experiencing high levels of both sound and vibration. The problem was traced to new pulse furnaces that had been installed.

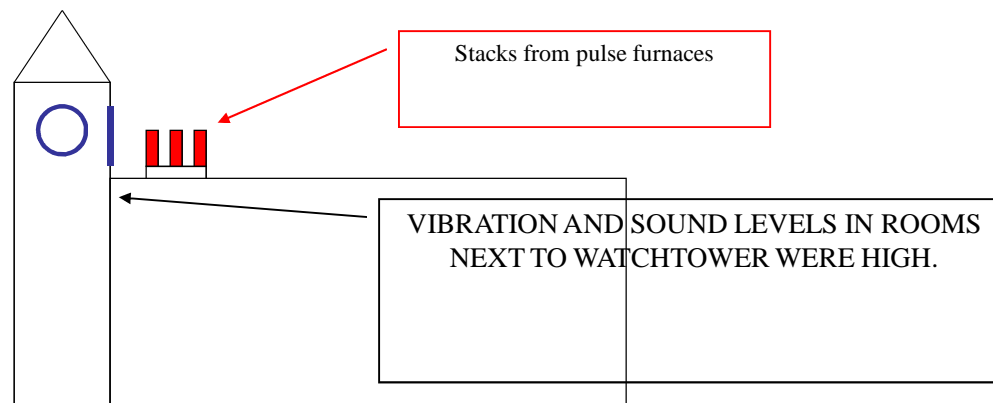

LAYOUT OF BUILDING

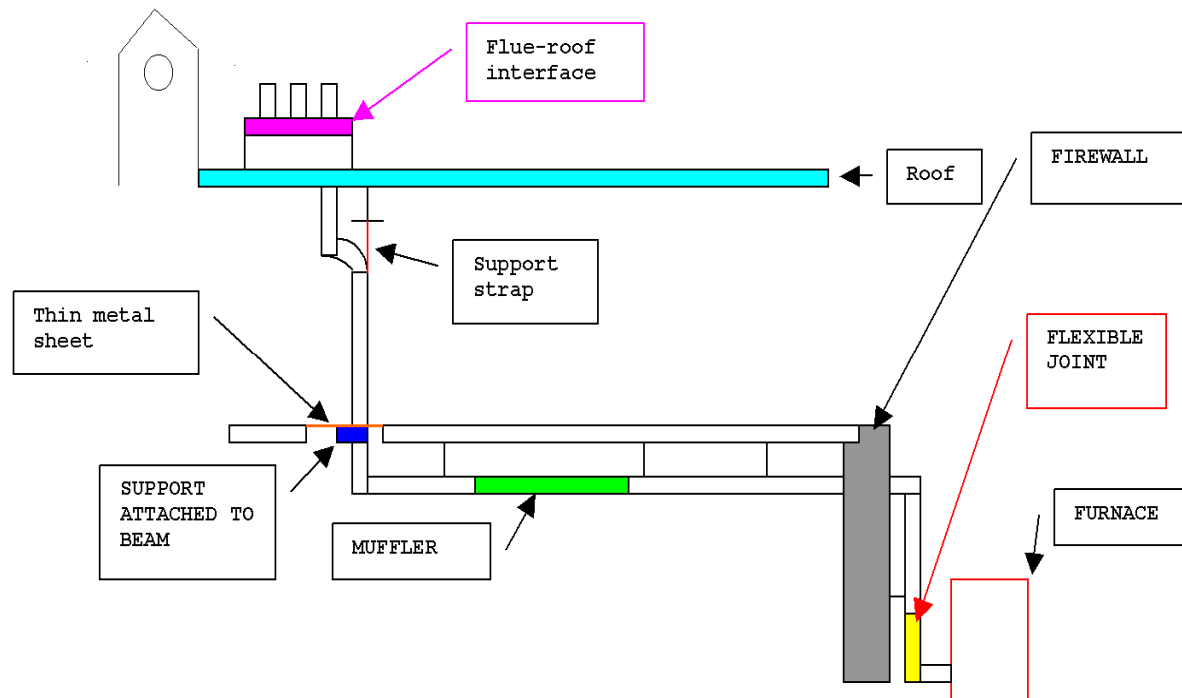

BAD LUCK

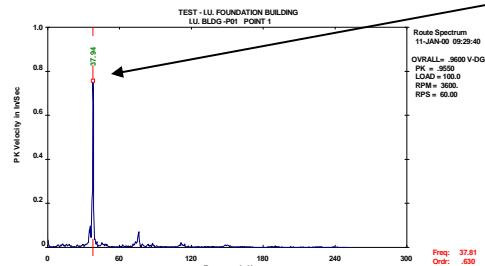

FIRING
FREQUENCY OF
FURNACE IS 33
HZ

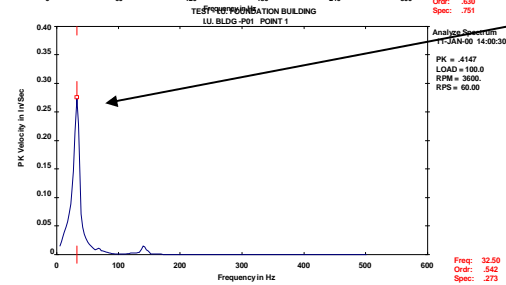

Response of 3 foot
diameter window in
watch tower
to impact 33 hz.

More Bad Luck

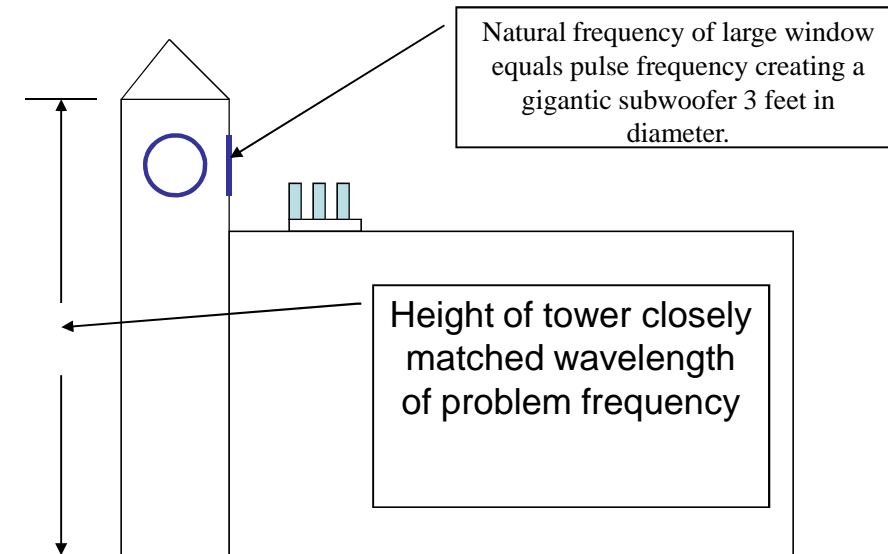

TEST TECHNIQUES

1: Don't forget to use a strobe light- In the past Strobe lights were used frequently due to fact that they were utilized to obtain the phase readings. Their use will almost certainly remain relevant as long as there is rotating equipment. Strobe lights are still the best way to looks at belts or to see if the elements in a coupling have cracked. They can also be used to determine the size of a key or locate a keway or look at balance weights. Strobes that are triggered by the vibration signal are useful to freeze the rotating element that is causing the vibration. **Case History- A paper mill was going to remove a roll to get it balanced. The frequency of the vibration matched the frequency that the group of wire rolls was vibrating at. This was determined by a calculation of the RPM of the roll base upon the roll diameter and the product's speed. A strobe fired by the vibration was used to verify that the roll was the source. To everyone's surprise, the strobe froze a different roll.** It turned out that the drawings had incorrect diameters. The strobe didn't lie or care about drawings, it just froze the correct component.

2. Phase locked loop strobes with a phase delay are very useful for providing a once per revolution output that can be used for balancing.

The use of a phase lock strobe can make it unnecessary to stop a machine so that photo-reflective tape can be installed. This can save hours of time on a balance job, particularly when a machine is limited to the number of starts that it can go through.

3: **Don't forget shaft sticks-** While it would be great to have proximity probes on every machine to measure shaft motion, in the real world this is just not the case. A shaft stick can measure the absolute motion of a shaft. Note, before using a shaft stick, use the strobe mentioned in point 1 to make sure there is not a keyway where the shaft stick is to be placed against the shaft.

4: It is handy to have an analog integration box for certain tests that allow the time waveform from an accelerometer to be viewed in displacement. Case 1- Two large vertical pumps had resonant frequencies near their operating speed. One of the calculations that were needed was to determine the damping so the amplification factor could be obtained. By using an analog integrator, the time waveform of the low frequency response could be directly measured and used for the log decrement calculation. Case 2- Foundries have low frequency vibratory conveyors that move the castings throughout the plant. These often cause vibration problems beyond the plant boundaries that result in complaints by neighbors. These conveyors which operate around 5 HZ move in and out of phase with one another causing the vibration levels to vary significantly with time. If a spectrum is taken of one snapshot in time, the overall value is hard to obtain. It is much easier to look at the motion in the time domain over a period of several seconds. The maximum peak to peak motions that people offsite are feeling can then be easily determined. If analog integration is available, then a long term time plot of the motion in displacement is very useful in determining the maximum levels of motion that are being experienced.

Vibratory conveyors that were shaking houses 1/2 mile from foundry. Calculated Peak-Peak 4.1 mils. Actual P-P over 7 mils. People feel much higher levels than spectrum indicates.

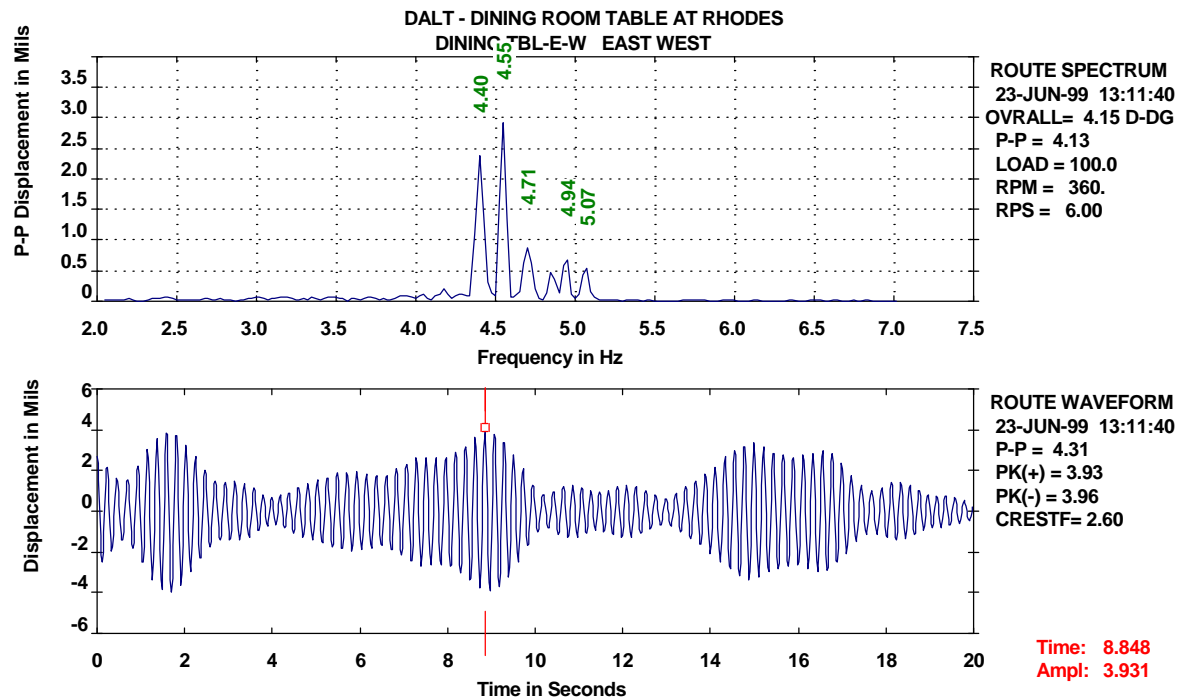

5: A microphone with an analog output that can be used to supply a signal to a spectrum analyzer can be very useful in the analysis of vibrations that are transmitted by the air rather than through solid material. Note that most microphones have a pretty severe roll of below 20Hz, so the true pressure pulsation amplitude may not be present at a lower frequency. The spectral data can still however be used to identify the problem.

6: If a temporary shaft rider is needed, then Ebelon rod works well. Ebelon is graphite impregnated Teflon and it will last a significant amount of time in contact with a reasonably smooth shaft.

Some Final Thoughts

A vibration analyst must understand the basic laws of physics ($F=ma$ and $F=kx$ and that dynamic stiffness is different than static stiffness). They must also understand signal processing so they do not get bad data. They must have an appreciation for human nature so they can get the truth out of mechanics and operations personnel. They need to understand how fans, motors, gear boxes, compressors, pumps and turbines work. But most of all they must be able to put all these things together under adverse conditions and then be able to think clearly and arrive at a logical conclusion.