



from **MARVIN**
Windows and Doors

Built to perform.®

ALL ULTREX®
S E R I E S



BUILT TO
PERFORM.

Built to Perform[®].



“At Integrity[®] from Marvin[®] Windows and Doors, we didn’t join the fiberglass window and door industry – we pioneered it. In 1994, Integrity was born from The Marvin Companies’ century-long heritage of service, craftsmanship and quality with a focus on all-out performance.”

Jason Marvin

Integrity windows and doors are made with Ultrex[®], a pultruded fiberglass with a patented acrylic capping that outperforms and outlasts vinyl, roll-form aluminum and other fiberglass composites. We use Ultrex and our proprietary pultrusion process to manufacture high-demand windows and doors that endure all elements without showing age or wear.

Though we are dedicated to leading the way in innovation, we never forget the cornerstones of our business. We are highly selective in choosing our business partners – including independently-owned dealers and distributors – to ensure our customers have the best experience possible. We use an efficient manufacturing and delivery system so our products are received when expected. We create products to be easily installed and operated with virtually no maintenance required.

Our values and work ethic are forged by the communities where we’re proud to make our quality products. When you choose Integrity windows and doors, you support a small-town, family-owned and operated company with deep roots in the community; some Marvin employees are fourth-generation, following the family tradition. We share profits with our employees; we support our communities; we treat our dealers and customers fairly and with respect.

At Integrity, we believe it is essential to live up to our name.





Integrity from Marvin was the first major window and door manufacturer to offer ENERGY STAR® qualified performance on all of its standard windows and doors.

- 4 Integrity® from Marvin®
- 6 Ultrex® Performance
- 10 Energy Efficiency
- 12 Delivery and Features
- 14 Product Options
- 18 Exterior Trim
- 20 Casement and Awning
- 22 Single Hung
- 24 Double Hung
- 26 Glider
- 28 Round Top
- 30 Polygon
- 32 Sliding Patio Door
- 34 Ordering Information
- 35 Lite Cuts
- 36 Specifications
- 72 Egress Openings
- 80 Altitude Guidelines
- 86 Thermal Performance
- 88 Sound Transmission
- 87 Performance Grade Ratings

Overachieve

THE REPUTATION LIVES ON.

One hundred years of innovation and uncompromising product performance standards: that's the legacy of Marvin Windows and Doors.

Our history was built on quality craftsmanship, a reputation for excellent service and a commitment to community. Today, third- and fourth-generation Marvin family members remain actively involved in the company, keeping the original spirit of corporate responsibility alive.

So when you specify Integrity, you can rest assured that every window and door is protected by a company renowned for standing behind its products with world class service and support for nearly a century.

In the end, our promise to you is simple: durable, high-performance products that bring lasting value to your home.



Our history was built on quality craftsmanship and a reputation for excellent service. Our future incorporates the unique innovation of Ultrex.

**THE MATERIAL
YOU CHOOSE FOR YOUR
WINDOWS AND DOORS
MATTERS**

Get tough

**8X
STRONGER
THAN VINYL***

ULTREX FIBERGLASS OFFERS UNMATCHED PERFORMANCE AND UNBEATABLE SATISFACTION.

Durable doesn't begin to describe how tough Ultrex® fiberglass is. Strong, stable, and virtually indestructible, ULTREX FIBERGLASS IS QUITE POSSIBLY THE PERFECT BUILDING MATERIAL®, creating windows and doors that leave other materials in the dust.

Made from pultruded fiberglass, Ultrex outperforms the competition on nearly every measure. Non-conductive and non-corrosive, Ultrex resists the ravages of heat, cold, time and pressure to provide the most worry-free windows and doors available today.

Pioneered by Marvin®, Ultrex has what it takes – from its durability and performance characteristics, to its first-to-market and ingenuity – to create products of incomparable value.

Low-maintenance and high-durability. Everything you want your home to be, and everything that Ultrex delivers.

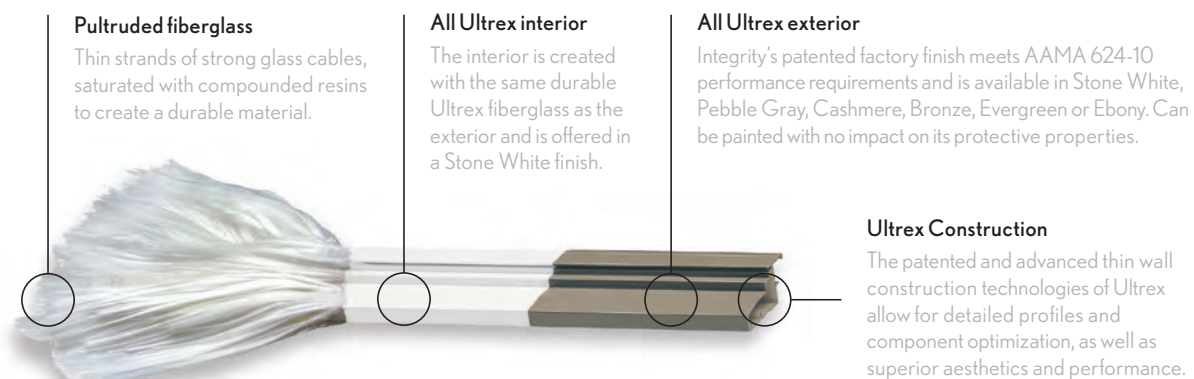

* Comparison of Flexural Modulus.

Temperatures may fluctuate, but Ultrex® won't.

Ultrex has an extremely low rate of thermal contraction and expansion. In fact, it expands and contracts at virtually the same miniscule amount as glass, maintaining a tight seal with no leaks, seal failures or stress cracks that can compromise energy-efficiency and long-term performance.

This is especially so when compared to vinyl, which can distort in extreme heat and crack in fluctuating temperatures. But Integrity® windows and doors can withstand temperature extremes while maintaining a tight seal.

3x less expansion than wood/vinyl composites.

Ultrex resists distortion even at temperatures up to 285°F. Rapid temperature change doesn't faze Ultrex: When the mercury climbs from -30°F to 70°F, a 6' stile changes less than 1/32" in length.

Designed for beauty. Engineered for life.

Our 20+ years of experience in the composite fenestration industry led us to ensure that every part is optimized for the ultimate in performance and fit, including detailed radius profiles and clean, balanced sightlines.

Windows and doors made with Ultrex won't get scratched, dinged or marred as easily as vinyl. Our patented, mechanically bonded acrylic finish is up to three times thicker than competitive finishes, and it resists UV degradation up to five times longer than vinyl – even on dark colors.

Premium Finish.

Ultrex is the *first and only* fiberglass finish to be verified to 624-10, AAMA's voluntary finish specifications for fiber reinforced thermoset profiles (fiberglass). The Ultrex patented acrylic cap finish is verified AAMA 623-10 and 624-10, and has passed the AAMA 625-10 lab based performance test protocols; 625-10 outdoor weathering test protocols are in process.

**PATENTED FINISH
FIRST AND
ONLY
AAMA VERIFIED
624-10**

EXPANSION MEASUREMENT

Ultrex expands and contracts at virtually the same rate as glass.

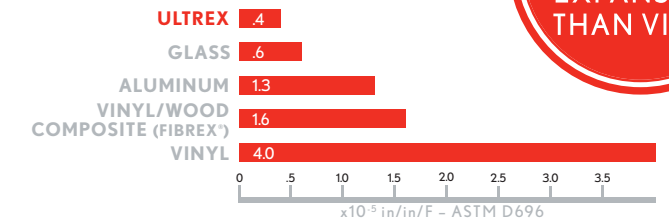

**ULTREX:
8X LESS
EXPANSION
THAN VINYL**

JUST ONE
SQUARE INCH OF
ULTREX CAN SUPPORT
**34,000
POUNDS!**

The tensile strength of Ultrex means one square inch can support up to 34,000 lbs. So, two monster trucks? No problem.

So now imagine how much your entire window can handle!

And Ultrex is so tough, we have to use diamond-edge blades just to cut it to size.



Ultrex® fiberglass. Quite possibly the perfect building material.®



Stay true

Ultrax[®] fiberglass also stands up mightily to rain, wind, heat and time, looking beautiful and performing well long after other window and door materials have lost their luster.

Pioneers



One hundred years of innovation and uncompromising product performance standards: that's the legacy of Marvin Windows and Doors. And it's why we build energy efficiency into every Integrity from Marvin product.

"We are always striving to be better, more efficient, and of course more sustainable. It's a proud part of our culture and will continue to be for generations to come."
Susan Marvin, Vice Chair of the Board,
Marvin[®] Windows and Doors

FLEXURAL MODULUS

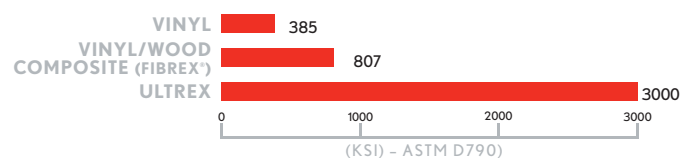

Stability.

The strength of Ultrax fiberglass also translates into superior stability. Ultrax is more rigid than vinyl and wood/vinyl composites. So issues of instability and less-than-perfect alignment that can complicate installation – and long-term performance – are not a concern with Integrity[®] windows and doors.

The exceptional strength and stability of Ultrax eases installation and establishes a secure, long-lasting fit that stays square and true under all conditions.

Built to Perform[®].

It's more than our tagline, it is our promise to you. Ultrax is so resilient, it outperforms and outlasts vinyl and vinyl/wood composites, time and time again. Strong yet light, Ultrax provides sturdy, reliable support from top to bottom, end to end.

A history of integrity.

Marvin has a long history of product innovations, industry firsts and commitment to community. Integrity[®] Windows and Doors takes pride in the fact that our corporation is green-minded with recycling efforts and employee awareness. In addition, we incorporate green components into our product packaging and even our distribution process.

Beyond that, being green is also about conserving energy – and Integrity is energy efficient. Not only are the products extremely durable, Integrity from Marvin was the first major window and door manufacturer to offer its ultra durable Ultrax[®] energy-efficient Low E2 insulated glass with Argon and ENERGY STAR[®] qualified performance on all of its standard windows and doors.

Today, Marvin is credited with several industry firsts and is recognized for innovative products and uncompromising product performance standards. Third- and fourth-generation Marvin family members remain actively involved in the company and keep the original spirit of corporate responsibility alive today.

Superior performance you can feel good about.

At Integrity, sustainability is part of the manufacturing philosophy: make a product able to withstand the power of the great outdoors, while preserving the natural resources from which it was made.

- Ultrax is made from silica sand, a safe and renewable natural resource.
- The Ultrax manufacturing facility captures and destroys 95% of all VOCs.
- The Ultrax manufacturing facility fully complies with the 1990 Clean Air Act and has been designated as a Maximum Achievable Control Technology (MACT) facility as outlined by the Environmental Protection Agency (EPA).
- The glass in our products contains 15%–33% recycled content.
- Integrity products offer ENERGY STAR qualified performance.
- Even more green awards and information at IntegrityWindows.com.



OUR INSULATED GLASS CONTAINS 15%-33% RECYCLED CONTENT

ULTRAX

VINYL

ULTRAX

COMPOSITES

ULTRAX

COMPOSITES



Integrity windows have a clean glazing bead profile and have solid, square, weathertight joints. Vinyl corners can arrive with messy welded corners and joints that aren't square.



With a finish up to 3x thicker than competitive finishes Integrity products won't dent, crack, chip, or peel. Its unmatched detailed profiles and superior tooling capabilities provide for a cleaner fit and finish.



Integrity windows use a patented, mechanically bonded finish, shown on the left, compared to the competitive finishes that are painted on and can be unsightly.

* "Life cycle assessment of windows for the North American residential market: Case Study" by the University of British Columbia Scandinavian Journal of Forest Research, 2008.

Shine on



CREATE A MORE COMFORTABLE INTERIOR AND LOWER ENERGY BILLS – REGARDLESS OF THE SEASON.

REDUCE COOLING COSTS BY 7-15%*

Keep heat inside during cooler weather and block the sun's rays during warmer weather with double-pane windows with Low E coating.

Ultrex® fiberglass resembles materials like wood that create an insulated barrier – keeping extreme weather outside.



Stellar energy performance ratings.

The NFRC defined an energy performance rating system for the entire window and door industry. It rates:

- U-factor, or how well a window keeps heat inside a building.
- Solar heat gain, or a window's ability to block warming caused by sunlight.
- Visible light transmittance, or how much light gets through a product.
- Air leakage or heat loss and gain by infiltration through cracks in the window assembly.

Fortunately, Ultrex is far less conductive than aluminum. It provides an insulated barrier against extreme weather temperatures, keeping homes comfortable, and reducing heating and cooling costs.

The National Fenestration Rating Council, the Department of Energy, and the U.S. Environmental Protection Agency were all impressed, **so much so that Integrity® Windows and Doors received one of the highest performance ratings.**

5000x LESS CONDUCTIVE THAN ALUMINUM = REDUCED ENERGY COSTS

Winter sun is absorbed and conducted indoors.

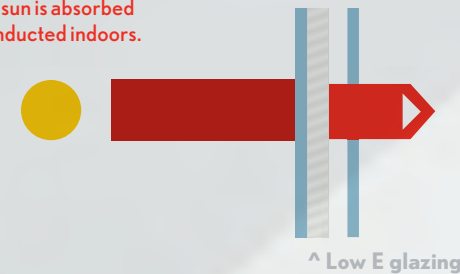

Summer sun is filtered and reflected back outdoors.

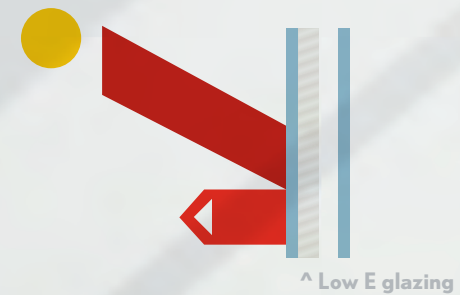

Low E and Argon gas means UV rays are screened to reduce fading and damage to upholstery and carpets. Integrity® offers both Low E2 and Low E3 glass for the ultimate in energy efficiency.



Save energy costs without sacrificing comfort.

Integrity from Marvin® offers a complete line of ENERGY STAR® qualified windows and doors. ENERGY STAR qualified windows can save you 15% of your total energy bill.*

First, Ultrex® is 5000 times less conductive than aluminum.

Next, we were the first major window and door manufacturer to offer energy-efficient Low E2 glass and ENERGY STAR qualified performance on all of our standard windows and doors. Compared to non-qualified products, ENERGY STAR qualified windows and doors cut heating and cooling costs by 7-15%.*

And now Integrity offers Low E1, Low E2, Low E3 insulated glass with Argon gas, which has thermal conductivity 30% lower than that of air. It adds improved solar and thermal protection by distinguishing between visible light and damaging UV and near-infrared rays to offer the ultimate glass performance, and provides a selection of energy-efficient solutions depending on your climate and needs.

Environmentally sound, in more ways than one.

Integrity from Marvin® takes our Built to perform® philosophy to heart, and works diligently to ensure that we hold ourselves to the highest quality and environmental standards possible. That is why Integrity from Marvin is proud that our Fargo facility is both ISO 9001:2008 and ISO 14001:2004 certified.

The International Organization for Standardization (ISO) is a worldwide federation established in 1947 that defines standards for Quality Management Systems (ISO 9001:2008) and Environmental Management Systems (ISO 14001:2004). These universal standards allow companies to provide more streamlined and efficient transactions, and help companies facilitate quality and environmental sustainability throughout their organizations.

ISO certification is a voluntary undertaking and speaks to the depth of an organization's commitment to quality and the environment.

Integrity from Marvin willingly took on this challenge in an effort to raise our own high standards of quality and test our quality management systems against the world's highest standards. To receive certification, Integrity underwent an extensive detailed audit process that requires an unwavering commitment to quality and the environment and continuous resolve for improved management systems. Integrity Windows and Doors is proud to have achieved both our ISO 9001:2008 and ISO 14001:2004 certification and will continue to focus our efforts to ensure consistent quality and environmental standards in serving you now and into the future.

For more information on the International Organization for Standardization (ISO) and their certifications, visit www.iso.org.



* ENERGY STAR at energystar.gov



Limitless options mean remodeling bliss.

Wanting a window or door that adds to the overall aesthetic of your home, while keeping with its general character isn't easy during a remodel. Fortunately, All Ultrex® from Integrity® can help.

From its sustainable Ultrex fiberglass construction and ENERGY STAR® qualification, to its special sizing (to 1/64") and proven on-time delivery – you can be confident that Integrity is the right choice now and for the future of your home.



On-time delivery, every time.

Managing a project can be difficult enough without worrying about your window or door order. Integrity's 10 day delivery to local distributors has been consistently providing complete defect-free window and door orders for over 10 years.

Pro's choice

For more than 15 years, we have been the go-to product for building professionals. From commercial to residential and new construction, to remodeling and replacement, All Ultrex has the solution for your job site.

Condos, townhouses, public housing, schools, businesses, banks, retail, churches... whatever your project, Integrity® has the experience to meet your needs.



No matter the project, Ultrex fiberglass has you covered.



Perfect fit and built to last.

Every commercial project has its own unique requirements and Integrity is equipped to meet those challenges. Our unique Ultrex® fiberglass construction, factory services, unmatched delivery and dedicated service and support personnel make Integrity the perfect choice.

Easy to specify, easy to order — our short lead times, consistent delivery and remarkable quality make your life easier.

Weather-tight, solid and durable Ultrex® material means there are virtually no call-backs. Plus, we ensure that every part is optimized for the ultimate in performance and fit, including detailed radius profiles and clean, balanced sightlines for an architecturally inspired appearance.

Designed to last for generations, Integrity® is backed by a fully transferable 20/10 warranty (10-year coverage on manufacturing materials and workmanship, and 20-year coverage on glass).



Rest assured

WE MAKE INSTALLATION SIMPLE AND EFFICIENT.



Builders, contractors, architects and homeowners all agree: Integrity windows and doors are designed for excellence.



HOMEOWNERS APPRECIATE THE PEACE OF MIND OF INTEGRITY® PRODUCTS

10 DAY DELIVERY TO THE LOCAL DISTRIBUTOR

Your Integrity products are delivered in 10 days to the distributor making your project run smoother. Ten years of an on-time record is something you can count on.

The following features make choosing Integrity even easier.

- 1 Pre-attached folding nailing fin and drip cap for easier installation. Available through-jamb and installation bracket options.
- 2 Factory-installed screens are a standard offering with operating windows. At no extra cost, we can ship your screens separately to reduce on-site damage prior to installation.
- 3 Factory-applied jamb extensions save time and labor. We supply 4 9/16", and 6 9/16" standard width jambs.
- 4 Factory-applied sheetrock return accommodates 1/2" to 5/8" drywall, while the 3/4" receiver accommodates box jambs and thicker installation methods.
- 5 Create your own assemblies with available standard factory mulling, reinforced factory mulling or field mulling kits.
- 6 3" and 1" frame expanders provide installation flexibility, while our frame filler increases the frame depth to 3 1/4" for a seamless replacement installation.
- 7 Special sizes are available on windows and doors to 1/64" for the perfect fit every time.
- 8 J-channel installs easily with various installation applications, while the detailed profile provides a more dramatic finished appearance.



1



2



3



4



5

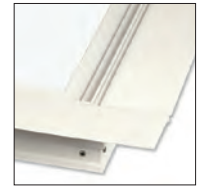

6



7

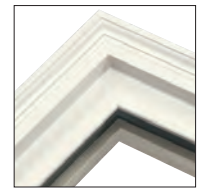

8

Finishes.

Interior Finishes: Comes standard in Stone White.

Exterior Finishes: Stone White, Cashmere, Pebble Gray, Bronze, Evergreen or Ebony. All are AAMA 624-10 verified and fully paintable without affecting the durability.

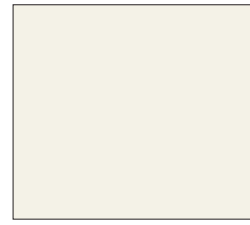

Stone White
(exterior and interior)

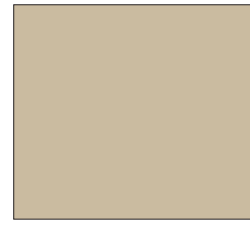

Cashmere
(exterior)

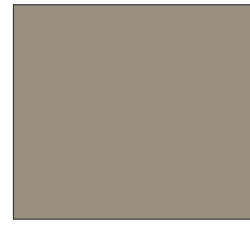

Pebble Gray
(exterior)



Bronze
(exterior)



Evergreen
(exterior)



Ebony
(exterior)

Glazing.

Integrity windows and doors are available in Low E1, Low E2, Low E3 and Low E3/ERS insulated glass with Argon gas for a selection of energy-efficient glazing options.*

Tempered Glass: Is standard on large units and doors, and available on most other units.

Obscure Glass: Obscure glass provides privacy and safety. Secure a modicum of privacy without sacrificing the energy efficiency and light.

Sound Abatement: Variable thickness glass provide enhanced STC and OITC sound abatement performance, while still providing a full selection of glass and divided lite options.



Tempered Glass



Obscure Glass



Variable Thickness Glass

* Argon gas not available in high elevations where capillary tubes are required.

Grilles.

Profiled Grilles-Between-the-Glass:

Available in several popular lite cut options (see page 35) for a classic divided lite look and easy glass cleaning. Available in Stone White interior and Stone White, Pebble Gray, Cashmere, Bronze, Evergreen and Ebony exterior.



Grilles-Between-the-Glass**
shown in Stone White

Hardware Finishes.

Integrity® window and door hardware is available in five finish options: White, Almond Frost, Brass (PVD), Satin Nickel (PVD) and Oil Rubbed Bronze (PVD).

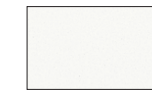

White



Almond Frost



Brass (PVD)



Satin Nickel
(PVD)



Oil Rubbed Bronze
(PVD)

Handle Collections.

Integrity door handles are available in two distinct hardware collections. Select from either the Cambridge Collection or Northfield Collection to meet your design needs. Available factory keyed and keyed alike options.



Cambridge Collection
shown in Almond Frost



Northfield Collection
shown in Satin Nickel

Accessibility Options.

Opening Control Device: Limits opening to 4", while providing for full egress. ASTM F2090-10 compliant. Available on Casement, Double Hung, Single Hung, and Glider Windows.

32" Handle: Handle provides a 32" net clear opening on Sliding Patio Doors.

Sash Limiter: Permanently limits sash movement for safety and security.

Non-Operable Lock: Renders sash inoperable when security is a paramount concern.



Casement Opening
Control Device



Double Hung/Single Hung
Opening Control Device



32" Handle



Single/Double Hung
Sash Limiter



Non-Operable Lock



Awning Sash Limiter

** Not available in polygons except direct-glaze rectangles.



Integrity® Exterior Trim solutions offer builders and remodelers easy installation for both windows and doors from a company they can trust. And homeowners can take advantage of the consistent low maintenance, superior durability and premium performance of Ultrex®.



Exterior Trim

THE STRONGEST CHOICE IN EXTERIOR TRIM.

Configurations

Multiple configurations are available in lineal lengths and factory pre-cut kits to meet your needs, install in minutes and are available in all of Integrity's exterior colors.

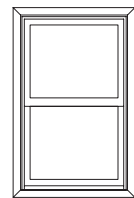

Brick Mould Casing

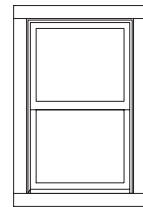

Flat Casing

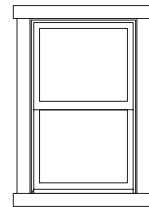

Flat Ranch

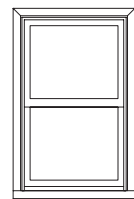

Brick Mould Casing with Sill Nose

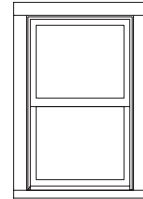

Flat Casing with Sill Nose

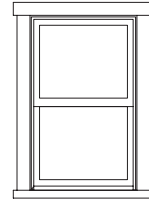

Flat Ranch with Sill Nose

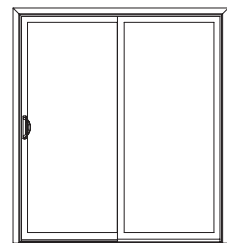

Brick Mould Casing*

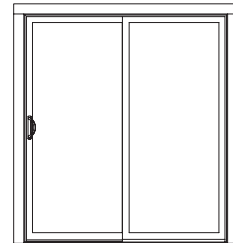

Flat Casing*

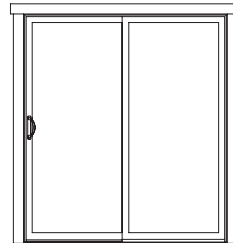

Flat Ranch*

NOTE: SDL available on Wood-Ultrex product only. Images shown with SDL are Wood-Ultrex product images.
* BMC, Flat and Flat Ranch profiles are available on doors. Sill profiles are not included for door trim sets.



Flat Casing

For a more contemporary look, select our 3.5" Flat Casing available in Flat, Flat Ranch, Flat with thick sill nosing and Flat Ranch with thick sill nosing.



Brick Mould Casing

Integrity® 2" Brick Mould Casing is available with or without a thick sill nosing. This style will enhance the look of the entire house.

Ultrex® Exterior Trim is now offered with all rectangular Wood-Ultrex and All Ultrex products. Which means the same durability, performance and look you get in your Integrity windows and doors can be extended to your trim.

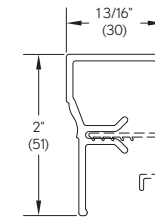

Brick Mould Casing

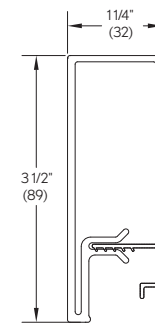

Flat Casing

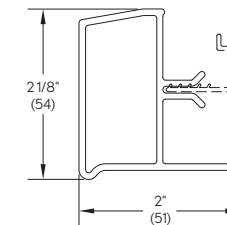

Sill Casing

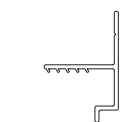

Connection Barb

Casement & Awning

BUILT FOR STRENGTH. DESIGNED FOR FLEXIBILITY.



Multi-point sequential locking system provides superior PG40 rated performance with single lever operation.

ENERGY STAR® qualified and available with Low E1, Low E2, Low E3, or Low E3/ERS insulated glass.

Folding handle provides easy operation and neatly stows out of the way of window treatments and blinds – available in five finishes; White, Almond Frost, Brass, Satin Nickel, and Oil Rubbed Bronze.

Interior screen features an extruded aluminum surround and concealed pressure mounting points for ease of operation and enhanced aesthetics.

Stationary, operating, transom and picture units available.

The amazing strength of Ultrex® fiberglass in a Casement and Awning. These dynamic windows deliver high end performance with the strength and sustainable characteristics of Ultrex. Dual-arm operating hardware and a single lever sequential locking system deliver PG40 performance. A clean design and measured sight lines provide visual depth and a modern classic feel. Six exterior finish colors, five hardware finishes, assorted lite cut configurations, special sizing to 1/64", and available picture and transom units allow for stunning and unique combinations.

A selection of hardware finishes, divided lites and lite cuts provide an abundance of design options.



Single Hung

DESIGNED FOR BEAUTY. ENGINEERED FOR LIFE.



The All Ultrex® Single Hung comes with a standard aluminum half screen; optional full screen is available.

Sash lock provides a positive detent, reassuring user that the window is either locked or unlocked.

Equal, Cottage, and Reverse Cottage sash provide a variety of looks and checkrail heights.

There is more than a single reason to like this beauty. The All Ultrex Single Hung offers PG50 performance on a majority of sizes. Innovative tilt latches, robust low profile sash lock, factory-applied installation accessories, and superior delivery combine with Ultrex fiberglass construction, Low E glass and ENERGY STAR® qualified performance to make the Single Hung a superior product in both looks and performance. Mull with picture units, transoms, Round Tops, other Single Hung or Polygon units to create unique multiple assemblies. Factory mulling, reinforced mulling and field mulling kits are available.

Removable lower sash easily removes with no tools and no strings or cords to detach.



Double Hung

STUNNING LOOKS, WITH SURPRISING DEPTH.



The Double Hung is equipped with a standard full screen: optional half screen is available.

Tilt latches are ergonomically designed and easy to operate making tilting and cleaning this window even easier.

Sash lock provides a positive detent, reassuring user that the window is either locked or unlocked.

Equal, Cottage, and Reverse Cottage sash provide a variety of looks and checkrail heights.

Bring traditional beauty where it hasn't been traditional. The All Ultrex® Double Hung window offers clean, even and measured sight lines that provide significant depth where historically only a flat vinyl facade has been present. Add superior PG50 performance on a majority of sizes, factory applied installation accessories and unparalleled delivery and this window not only looks great it performs great. Mull with picture units, transoms, Round Tops, other Double Hungs or Polygon units to create a myriad of assemblies. Factory mulling, reinforced mulling and field mulling kits are available.

Both sash tilt and remove easily, with no tools or strings to detach.



Glider

EFFORTLESS OPERATION. EASY CHOICE.



The Glider operating sash easily tilts and removes with no tools and no cords or strings to detach.

Tilt latches are ergonomically designed and easy to operate making tilting and cleaning this window even easier.

Discreet and ergonomic pull blends seamlessly with the interior while offering durable performance.

The Glider is available in a triple sash configuration for a more expansive view.

Say goodbye to sagging headers and painful operation of vinyl gliders forever. The All Ultrex® Glider offers Ultrex fiberglass construction that ensures smooth effortless operation for years to come thanks to the superior strength and minimal expansion/contraction properties of Ultrex. Choose an XO, OX or XOX (triple sash) configuration with the confidence that Ultrex construction eliminates sagging headers common to vinyl gliders. An innovative screen design makes removing and installing the screen of our Glider easier than ever. PG40 performance on a majority of sizes and the standard suite of All Ultrex Series options make ordering, delivery, installation and dependable performance effortless.

Triple sash option provides the appearance of a picture unit assembly.



Round Top

A DYNAMIC COMPLEMENT TO TOP OFF YOUR DESIGN.



- Glass reinforced composite material complements Ultrex's performance in a radius profile.
- Acrylic capping technology delivers consistent finish and durability in all six All Ultrex® Series exterior colors.
- Available nailing fin, installation bracket and through jamb installation.
- Perforated folding radius nailing fin provides for simple installation and proper water management.
- Available factory and field mulling options.

The All Ultrex Series Round Top is constructed of a glass reinforced composite capped with Integrity® Windows and Doors' acrylic finish technology. The dynamic windows are a great way to top off any project and are available as true half rounds, half rounds above springline and eyebrow above springline configurations. Choose from three installation options, six exterior colors and several glass options to create an individual unit or pair your Round Top with another All Ultrex product to create a unique assembly.

Integrity's Round Tops, used separately, or as part of a larger assembly, bring space and dimension to any room.

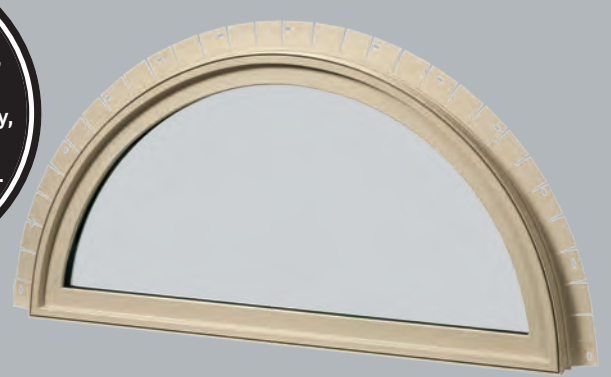

Polygon

A NEW ANGLE ON STYLE.

Standard jambs of 4 9/16" (116 mm) and 6 9/16" (167 mm) are available factory applied or as an extension kit.

Consistent, fast delivery applies to even the most unique products.

Enhance your windows by including the unique shapes and sizes of Integrity® All Ultrex® Polygons. Choose from eight popular shapes; including rectangles, triangles, pentagons, octagons and trapezoids. Integrity Polygons are available in sizes up to 49 square feet with a maximum span of 9 feet. So think big and imagine the possibilities – sidelites, transoms, flankers, unique assemblies or stand alone units. These windows offer WDMA Performance Grade 50 Hallmark Certification (PG50), and same service, delivery, energy efficiency, strength, durability and options as the rest of the All Ultrex series of products. So dare to dream with confidence, because unique just got a whole lot easier.

Big views beg for big windows. Polygons are available with lengths of 96" and overall dimension of 49 square feet.*

* Polygons maximum size is 72" x 96". When the longest leg exceeds 72" the shortest leg cannot exceed 72".



Trapezoid

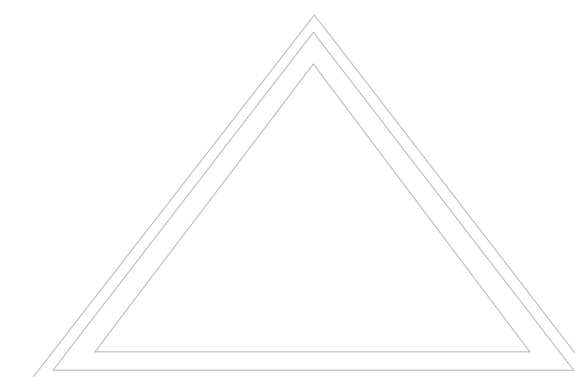

Isosceles Triangle

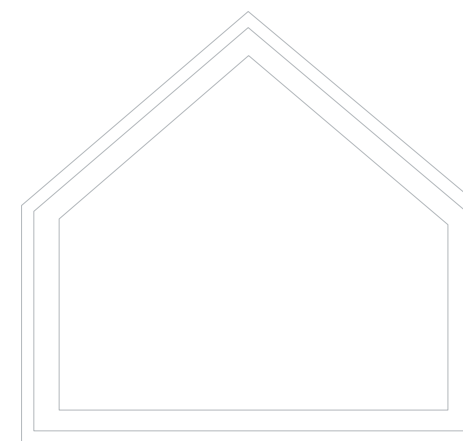

Pentagon

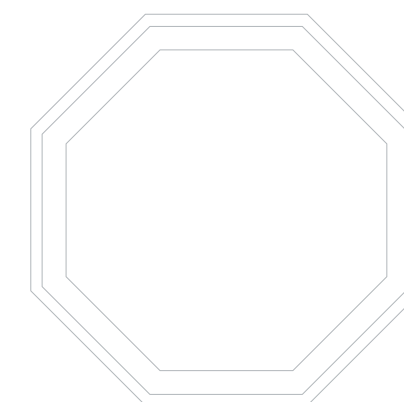

Octagon



Rectangle

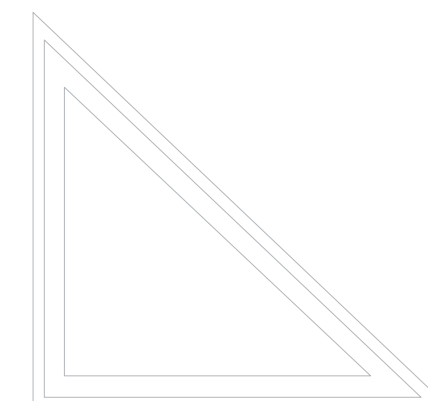

90° Triangle

Sliding Patio Door

IT WORKS, BEAUTIFULLY.



A top hung sliding screen operates smoothly free of dirt and debris. Matching handle set design provides style and security. Interior and exterior handle available in White, Pebble Gray, Cashmere, Bronze, Evergreen and Ebony. Optional 32" Handle provides 32" net clear opening on 3' panel configurations. Special sizing available on 2-panel configurations.

Welcome to consistent durable performance. The All Ultrex® Sliding Patio Door provides low maintenance PG30 performance that vinyl just can't match. Ultrex construction ensures this door has the strength, durability and resilience to stand the test of time. Always straight, square and true, so effortless operation is a constant. The All Ultrex Sliding Patio Door offers a large daylight opening, 2-panel and 3-panel configurations, and heights up to 8 feet high. A handle set with matching interior and exterior styling and a top hung screen further this door's amazing style, performance and dependability.

Our doors come with standard tempered Low E2 insulated glass with argon gas. Optional Low E1 Low E3 and Low E3/ERS meet diverse energy efficiency needs.



ORDERING INTEGRITY WINDOWS AND DOORS

Integrity® All Ultrex® Series products are sized with consistent nominal sizing to simplify specification and ordering.* Each product section offers product codes for ordering under each unit. Metric millimeter measurements are in parentheses.

You'll notice four measurements for each window or door: masonry opening, rough opening, frame size and day light opening size. The masonry opening is for a home built with brick or stone; rough openings are for houses with wood, vinyl or metal siding. Frame size measures from edge to edge of the unit; daylight opening indicates the dimension of total visible glass in a single sash.

MO (mm)	1' - 6" (457)	2' - 0" (610)	2' - 6" (762)	2' - 8" (914)	3' - 0" (914)	3' - 6" (1067)	4' - 0" (1219)
RO (mm)	1' - 6" (457)	2' - 0" (610)	2' - 6" (762)	2' - 8" (914)	3' - 0" (914)	3' - 6" (1067)	4' - 0" (1219)
FS (mm)	1' - 5 1/2" (445)	1' - 11 1/2" (597)	2' - 5 1/2" (749)	2' - 7 1/2" (902)	2' - 11 1/2" (902)	3' - 5 1/2" (1054)	3' - 11 1/2" (1207)
DLO (mm)	12 9/16" (319)	18 9/16" (471)	24 9/16" (624)	26 9/16" (675)	30 9/16" (776)	36 9/16" (929)	42 9/16" (1081)

3' - 11 3/4" (1213)							
4' - 0" (1219)	IFSH1640	IFSH2040	IFSH2640	IFSH2840	IFSH3040	IFSH3640	IFSH4040
3' - 11 1/2" (1207)							
20 5/16" (516)							

Mulling Options - A variety of standard factory mulled and reinforced factory mulled combinations are available.

All Ultrex Mulling Configurations	Maximum Overall Rough Opening not to exceed:	Maximum Units Wide by High
Casement / Awning Single Hung / Double Hung	114" (2896) X 78" (1981)	6 Wide X 1 High
Picture / Transom / Direct Glaze	96" (2438) X 96" (2438)	5 Wide X 5 High
Glider	114" (2896) X 60" (1524)	3 Wide X 1 High
Picture / Transom / Direct Glaze	72" (1829) X 78" (1981)	2 Wide X 2 High

Field mulling kits available to create your own unique multiple assemblies. Please contact your local Integrity from Marvin® representative for more information.

Examples of Possible Configurations

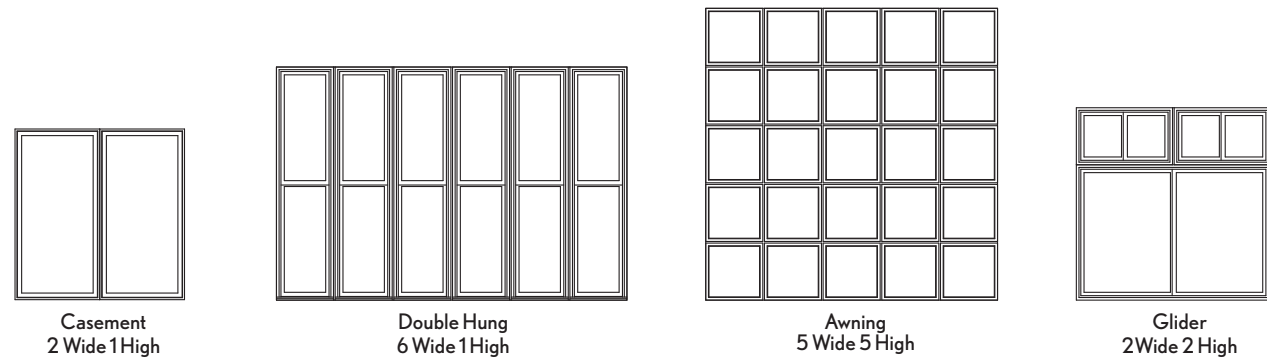

* Polygon units are specified according to guidelines on page 68.

INTEGRITY LITE CUTS

Windows

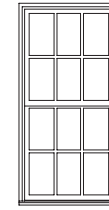

Rectangular
Available as GBG

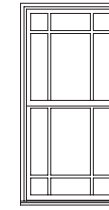

Prairie
Available as GBG

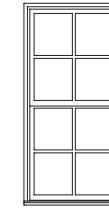

2w2h
Available as GBG

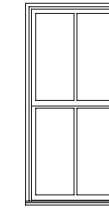

2w1h
Available as GBG

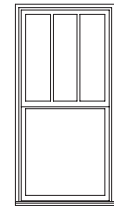

Equal Lite
Available as GBG

Doors

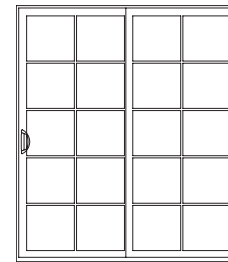

10/12 Lite
One vertical bar per panel
Available as GBG

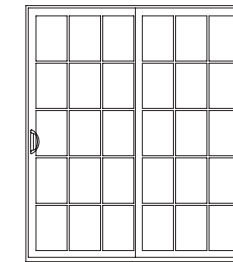

15/18 Lite
Two vertical bars per panel
Available as GBG

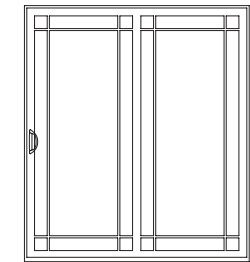

Prairie
Available as GBG

Equal lite allows for the number of horizontal and vertical lites to be specified for a custom appearance.

Lite cuts are dependent on product type and size. Please consult your local Integrity from Marvin representative for details and availability.

CASEMENT

Operator / Stationary Units

MO (mm)	1'-6" (457)	2'-0" (610)	2'-6" (762)	3'-0" (914)
RO (mm)	1'-6" (457)	2'-0" (610)	2'-6" (762)	3'-0" (914)
FS (mm)	1'-5 1/2" (445)	1'-11 1/2" (597)	2'-5 1/2" (749)	2'-11 1/2" (902)
DLO (mm)	1153/64" (300)	1753/64" (453)	2353/64" (605)	2953/64" (757)

1'-11 3/4" (603)				
2'-5 3/4" (756)				
2'-11 3/4" (908)				
3'-5 3/4" (1060)				
3'-11 3/4" (1213)				
4'-5 3/4" (1365)				
4'-11 3/4" (1518)				
5'-5 3/4" (1670)				
5'-11 3/4" (1822)				

Details and Elevations not to scale.

Special sized units available within product size matrix. See your Integrity® retailer.

E = These windows meet National Egress Codes for fire evacuation. Local codes may differ.

T = Standard Tempered

Obscure Glass option available on all units.

GBG available in standard Rectangular lite cut, shown above. Other GBG lite cuts shown on page 35.

* These units may optionally include a window opening control device tested to ASTM F2090-10, which can be released from the inside without the use of a key, tool, special knowledge, or force greater than that required for normal unit operation. See page 87 for specific PG Ratings.

CASEMENT

2 Wide Operator / Stationary Units

MO (mm)	3'-0" (914)	4'-0" (1219)	5'-0" (1524)	6'-0" (1829)
RO (mm)	3'-0" (914)	4'-0" (1219)	5'-0" (1524)	6'-0" (1829)
FS (mm)	2'-11 1/2" (902)	3'-11 1/2" (1207)	4'-11 1/2" (1511)	5'-11 1/2" (1816)

1'-11 3/4" (603)				
2'-5 3/4" (756)				
2'-11 3/4" (908)				
3'-5 3/4" (1060)				
3'-11 3/4" (1213)				
4'-5 3/4" (1365)				
4'-11 3/4" (1518)				
5'-5 3/4" (1670)				
5'-11 3/4" (1822)				

Multiple Assemblies

Multiple assemblies can be factory mullled.

MAXIMUM ROUGH OPENING not to exceed 114" X 78". Maximum up to 6 units wide by 1 unit high.

MAXIMUM ROUGH OPENING not to exceed 96" X 96". Maximum up to 5 units wide by 5 units high.



















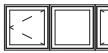







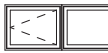



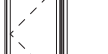

Field mull kits are available. Structural mullion reinforcement is required for some assemblies.

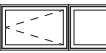
Please consult your local Integrity from Marvin representative for more information.

CASEMENT

3 Wide Operator / Stationary Units

MO (mm)	4'-6" (1372)	6'-0" (1829)	7'-6" (2286)	9'-0" (2743)
RO (mm)	4'-6" (1372)	6'-0" (1829)	7'-6" (2286)	9'-0" (2743)
FS (mm)	4'-5 1/2" (1359)	5'-11 1/2" (1816)	7'-5 1/2" (2273)	8'-11 1/2" (2731)

1'-11 3/4" (603) 2'-0" (610) 2'-5 3/4" (756) 2'-6" (762) 2'-11 3/4" (908) 3'-0" (914) 3'-5 3/4" (1060) 3'-6" (1067) 3'-11 3/4" (1213) 4'-0" (1219) 4'-5 3/4" (1365) 4'-6" (1372) 4'-11 3/4" (1518) 5'-0" (1524) 5'-5 3/4" (1670) 5'-6" (1676) 5'-11 3/4" (1822) 6'-0" (1829) 6'-11 1/2" (1816)	 IFCA1620  IFCA1626  IFCA1630  IFCA1636  IFCA1640  IFCA1646  IFCA1650  IFCA1656  IFCA1660T	 IFCA2020  IFCA2026  IFCA2030  IFCA2036  IFCA2040  IFCA2046  IFCA2050  IFCA2056  IFCA2060T	 IFCA2620*  IFCA2626*  IFCA2630*  IFCA2636*  IFCA2640 E*  IFCA2646 E*  IFCA2650 E*  IFCA2656 E*  IFCA2660 ET*	 IFCA3020*  IFCA3026*  IFCA3030*  IFCA3036 E*  IFCA3040 E*  IFCA3046 E*  IFCA3050 E*  IFCA3056 E*  IFCA3060 ET*
--	---	---	--	--

Details and Elevations not to scale.

Special sized units available within product size matrix. See your Integrity® retailer.

E = These windows meet National Egress Codes for fire evacuation. Local codes may differ.

T = Standard Tempered

Obscure Glass option available on all units.















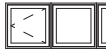

GBG available in standard Rectangular lite cut, shown above. Other GBG lite cuts shown on page 35.

* These units may optionally include a window opening control device tested to ASTM F2090-10, which can be released from the inside without the use of a key, tool, special knowledge, or force greater than that required for normal unit operation. See page 87 for specific PG Ratings.

CASEMENT

4 Wide Operator / Stationary Units

MO (mm)	6'-0" (1829)	8'-0" (2438)
RO (mm)	6'-0" (1829)	8'-0" (2438)
FS (mm)	5'-11 1/2" (1816)	7'-11 1/2" (2426)

1'-11 3/4" (603) 2'-0" (610) 2'-5 3/4" (756) 2'-6" (762) 2'-11 3/4" (908) 3'-0" (914) 3'-5 3/4" (1060) 3'-6" (1067) 3'-11 3/4" (1213) 4'-0" (1219) 4'-5 3/4" (1365) 4'-6" (1372) 4'-11 3/4" (1518) 5'-0" (1524) 5'-5 3/4" (1670) 5'-6" (1676) 5'-11 3/4" (1822) 6'-0" (1829) 6'-11 1/2" (1816)	 IFCA1620  IFCA1626  IFCA1630  IFCA1636  IFCA1640  IFCA1646  IFCA1650  IFCA1656  IFCA1660T	 IFCA2020  IFCA2026  IFCA2030  IFCA2036  IFCA2040  IFCA2046  IFCA2050  IFCA2056  IFCA2060T
--	---	---

Multiple Assemblies

Multiple assemblies can be factory mullled.

MAXIMUM ROUGH OPENING not to exceed 114" X 78". Maximum up to 6 units wide by 1 unit high.

MAXIMUM ROUGH OPENING not to exceed 96" X 96". Maximum up to 5 units wide by 5 units high.

Field mull kits are available. Structural mullion reinforcement is required for some assemblies.

Please consult your local Integrity from Marvin representative for more information.

Casement Flankers
with Picture Center Unit

MO (mm)	2'-0" (610)	4'-0" (1219)	2'-0" (610)
RO (mm)	2'-0" (610)	4'-0" (1219)	2'-0" (610)
FS (mm)	1'-11 1/2" (597)	3'-11 1/2" (1207)	1'-11 1/2" (597)
DLO (mm)	17 53/64" (453)	41 53/64" (1062)	17 53/64" (453)

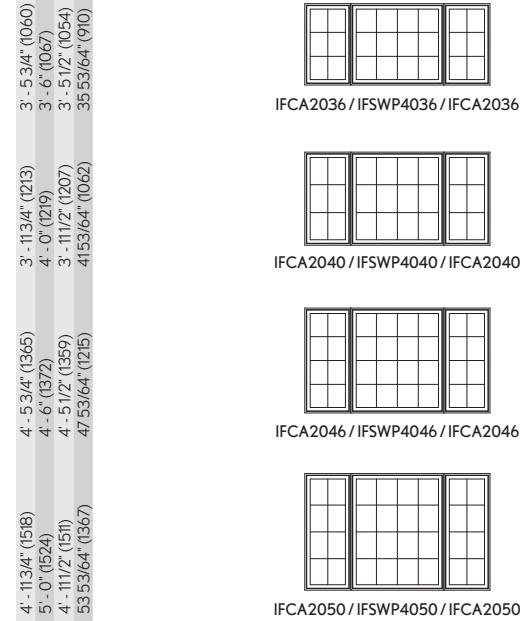

Casement Flankers
with Picture Center Unit

MO (mm)	2'-0" (610)	5'-0" (1524)	2'-0" (610)
RO (mm)	2'-0" (610)	5'-0" (1524)	2'-0" (610)
FS (mm)	1'-11 1/2" (597)	4'-11 1/2" (1511)	1'-11 1/2" (597)
DLO (mm)	17 53/64" (453)	41 53/64" (1062)	17 53/64" (453)

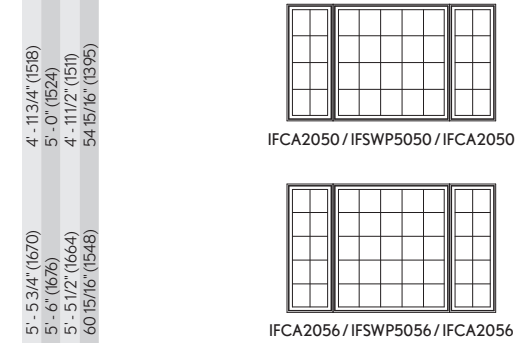

Details and Elevations not to scale.
Special sized units available within product size matrix. See your Integrity® retailer.
Obscure Glass option available on all units.
GBG available in standard Rectangular lite cut, shown above. Other GBG lite cuts shown on page 35.
See page 87 for specific PG Ratings.

Multiple Assemblies
Multiple assemblies can be factory mullied.
MAXIMUM ROUGH OPENING not to exceed 114" X 78". Maximum up to 6 units wide by 1 unit high.
MAXIMUM ROUGH OPENING not to exceed 96" X 96". Maximum up to 5 units wide by 5 units high.
Field mull kits are available. Structural mullion reinforcement is required for some assemblies.
Please consult your local Integrity from Marvin® representative for more information.

Construction Details

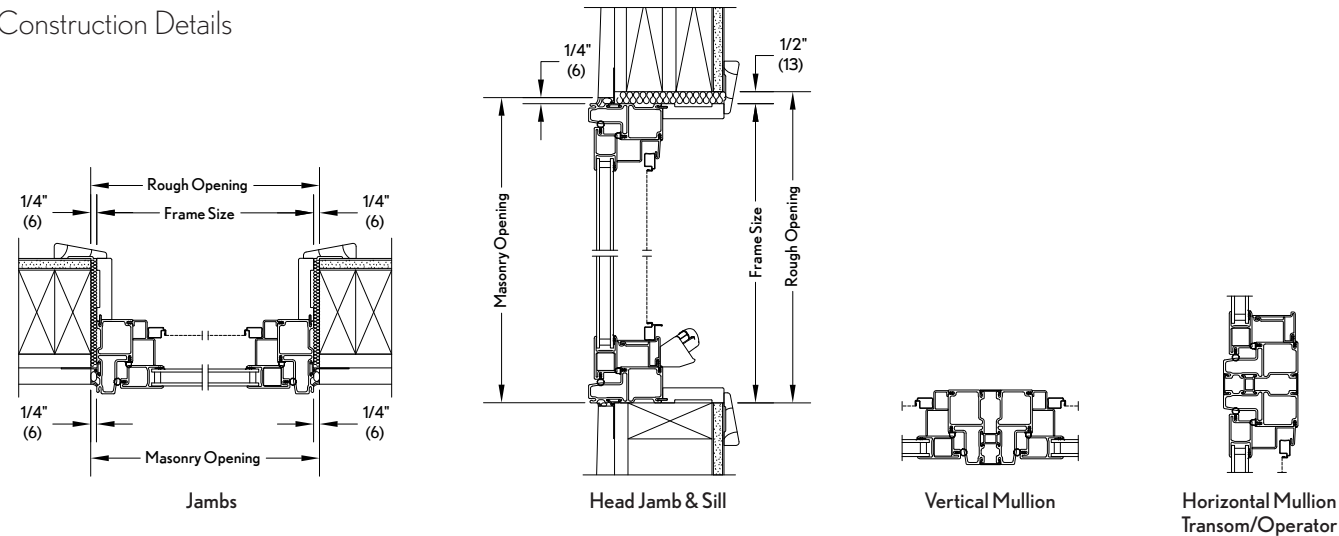

AWNING

Operator / Stationary Units



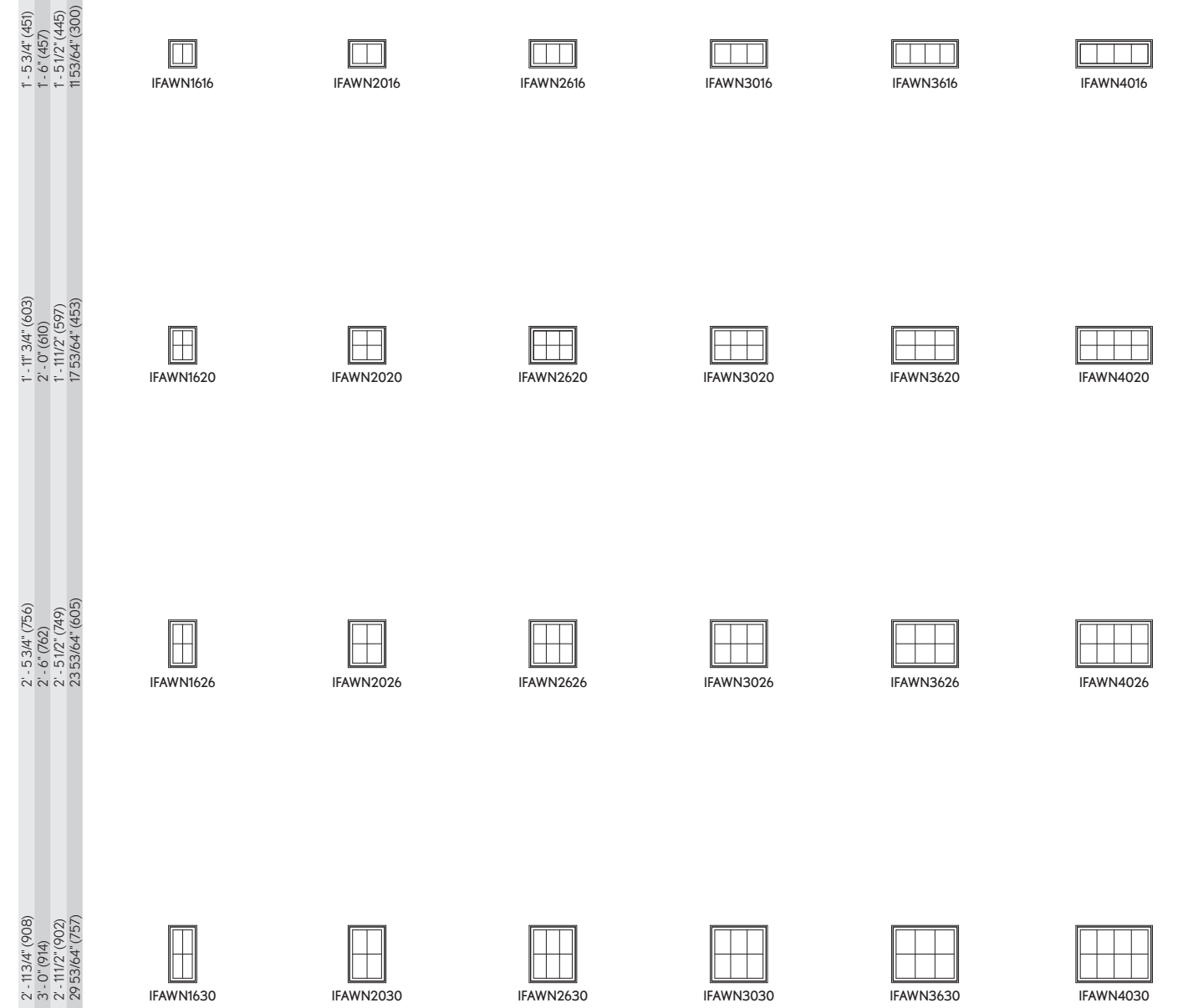



















MO (mm)	1'-6" (457)	2'-0" (610)	2'-6" (762)	3'-0" (914)	3'-6" (1067)	4'-0" (1219)
RO (mm)	1'-6" (457)	2'-0" (610)	2'-6" (762)	3'-0" (914)	3'-6" (1067)	4'-0" (1219)
FS (mm)	1'-5 1/2" (445)	1'-11 1/2" (597)	2'-5 1/2" (749)	2'-11 1/2" (902)	3'-5 1/2" (1054)	3'-11 1/2" (1207)
DLO (mm)	11 53/64" (300)	17 53/64" (453)	23 53/64" (605)	29 53/64" (757)	35 53/64" (910)	41 53/64" (1062)



AWNING

2 Wide Operator / Stationary Units

MO (mm)	3' - 0" (914)	4' - 0" (1219)	5' - 0" (1524)	6' - 0" (1829)	7' - 0" (2134)	8' - 0" (2438)
RO (mm)	3' - 0" (914)	4' - 0" (1219)	5' - 0" (1524)	6' - 0" (1829)	7' - 0" (2134)	8' - 0" (2438)
FS (mm)	2' - 11 1/2" (902)	3' - 11 1/2" (1207)	4' - 11 1/2" (1511)	5' - 11 1/2" (1816)	6' - 11 1/2" (2121)	7' - 11 1/2" (2426)

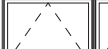















1' - 5 3/4" (451) 1' - 6" (457) 1' - 5 1/2" (445)	 IFAWN1616	 IFAWN2016	 IFAWN2616	 IFAWN3016	 IFAWN3616	 IFAWN4016
1' - 11 3/4" (603) 2' - 0" (610) 1' - 11 1/2" (597)	 IFAWN1620	 IFAWN2020	 IFAWN2620	 IFAWN3020	 IFAWN3620	 IFAWN4020
2' - 5 3/4" (756) 2' - 6" (762) 2' - 5 1/2" (749)	 IFAWN1626	 IFAWN2026	 IFAWN2626	 IFAWN3026	 IFAWN3626	 IFAWN4026
2' - 11 3/4" (908) 3' - 0" (914) 2' - 11 1/2" (902)	 IFAWN1630	 IFAWN2030	 IFAWN2630	 IFAWN3030	 IFAWN3630	 IFAWN4030

Details and Elevations not to scale.
Special sized units available within product size matrix. See your Integrity® retailer.
Obscure Glass option available on all units.
See page 87 for specific PG Ratings.

AWNING

3 Wide Operator / Stationary Units

MO (mm)	4' - 6" (1372)	6' - 0" (1829)	7' - 6" (2286)	9' - 0" (2743)
RO (mm)	4' - 6" (1372)	6' - 0" (1829)	7' - 6" (2286)	9' - 0" (2743)
FS (mm)	4' - 5 1/2" (1359)	5' - 11 1/2" (1816)	7' - 5 1/2" (2273)	8' - 11 1/2" (2731)









1' - 5 3/4" (451) 1' - 6" (457) 1' - 5 1/2" (445)	 IFAWN1616	 IFAWN2016	 IFAWN2616	 IFAWN3016
1' - 11 3/4" (603) 2' - 0" (610) 1' - 11 1/2" (597)	 IFAWN1620	 IFAWN2020	 IFAWN2620	 IFAWN3020
2' - 5 3/4" (756) 2' - 6" (762) 2' - 5 1/2" (749)	 IFAWN1626	 IFAWN2026	 IFAWN2626	 IFAWN3026
2' - 11 3/4" (908) 3' - 0" (914) 2' - 11 1/2" (902)	 IFAWN1630	 IFAWN2030	 IFAWN2630	 IFAWN3030

Multiple Assemblies
Multiple assemblies can be factory mullied.
MAXIMUM ROUGH OPENING not to exceed 114" X 78". Maximum up to 6 units wide by 1 unit high.
MAXIMUM ROUGH OPENING not to exceed 96" X 96". Maximum up to 5 units wide by 5 units high.
Field mull kits are available. Structural mullion reinforcement is required for some assemblies.
Please consult your local Integrity from Marvin® representative for more information.

AWNING

4 Wide Operator / Stationary Units

MO (mm)	6' - 0" (1829)	8' - 0" (2438)
RO (mm)	6' - 0" (1829)	8' - 0" (2438)
FS (mm)	5' - 11 1/2" (1816)	7' - 11 1/2" (2426)

1' - 5 3/4" (451) 1' - 6" (457) 1' - 5 1/2" (445)		
	IFAWN1616	IFAWN2016
1' - 11 3/4" (603) 2' - 0" (610) 1' - 11 1/2" (597)		
	IFAWN1620	IFAWN2020
2' - 5 3/4" (756) 2' - 6" (762) 2' - 5 1/2" (749)		
	IFAWN1626	IFAWN2026
2' - 11 3/4" (908) 3' - 0" (914) 2' - 11 1/2" (902)		
	IFAWN1630	IFAWN2030

Details and Elevations not to scale.
Special sized units available within product size matrix. See your Integrity® retailer.
Obscure Glass option available on all units.
See page 87 for specific PG Ratings.

AWNING

Construction Detail

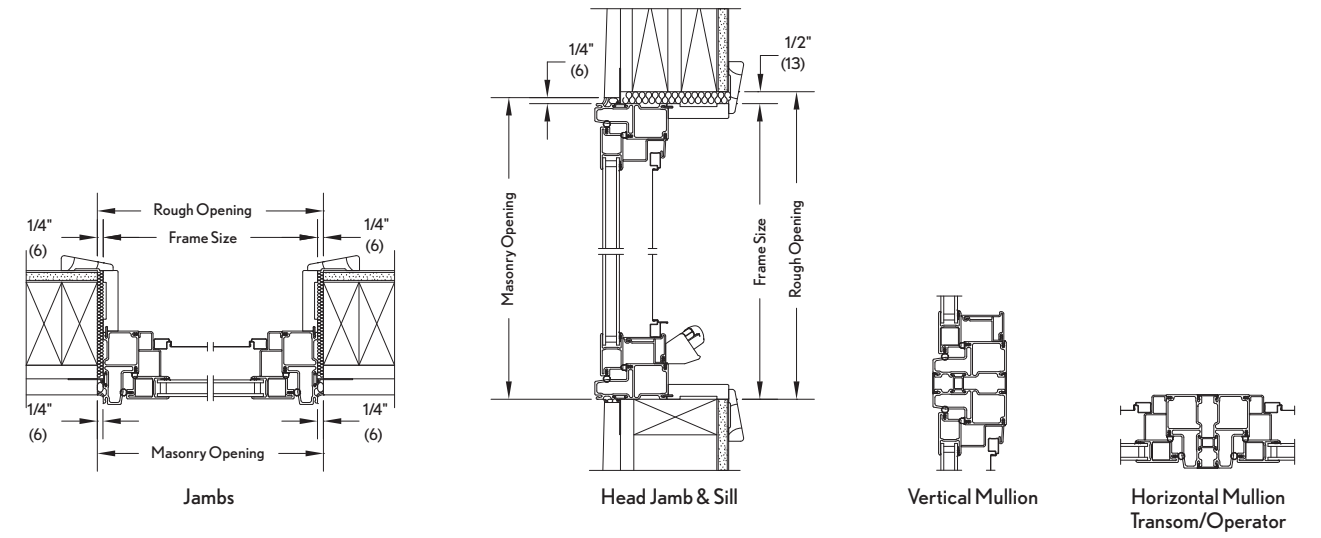

Multiple Assemblies
Multiple assemblies can be factory mullied.
MAXIMUM ROUGH OPENING not to exceed 14" X 78". Maximum up to 6 units wide by 1 unit high.
MAXIMUM ROUGH OPENING not to exceed 96" X 96". Maximum up to 5 units wide by 5 units high.
Field mull kits are available. Structural mullion reinforcement is required for some assemblies.
Please consult your local Integrity from Marvin® representative for more information.

SWINGING PICTURE AND TRANSOM UNITS

Picture Units

MO (mm)	1' - 6" (457)	2' - 0" (610)	2' - 6" (762)	3' - 0" (914)	3' - 6" (1067)	4' - 0" (1219)	5' - 0" (1524)	6' - 0" (1829)
RO (mm)	1' - 6" (457)	2' - 0" (610)	2' - 6" (762)	3' - 0" (914)	3' - 6" (1067)	4' - 0" (1219)	5' - 0" (1524)	6' - 0" (1829)
FS (mm)	1' - 5 1/2" (445)	1' - 11 1/2" (597)	2' - 5 1/2" (749)	2' - 11 1/2" (902)	3' - 5 1/2" (1054)	3' - 11 1/2" (1207)	4' - 11 1/2" (1511)	5' - 11 1/2" (1816)
DLO (mm)	1153/64" (300)	1753/64" (453)	2353/64" (605)	2953/64" (757)	3553/64" (910)	4153/64" (1062)	5353/64" (1367)	6553/64" (1672)

1' - 11 3/4" (603)								
2' - 5 3/4" (756)								
2' - 11 3/4" (908)								
3' - 5 3/4" (1060)								
3' - 11 3/4" (1213)								
4' - 5 3/4" (1365)								
4' - 11 3/4" (1518)								
5' - 5 3/4" (1670)								
5' - 11 3/4" (1822)								

Details and Elevations not to scale.
Special sized units available within product size matrix. See your Integrity® retailer.
T = Standard Tempered

Obscure Glass option available on all units.
GBG available in standard Rectangular lite cut, shown above. Other GBG lite cuts shown on page 35.
See page 87 for specific PG Ratings.

SWINGING PICTURE AND TRANSOM UNITS

In-Sash Transom

MO (mm)	1' - 6" (457)	2' - 0" (610)	2' - 6" (762)	3' - 0" (914)	3' - 6" (1067)	4' - 0" (1219)	5' - 0" (1524)	6' - 0" (1829)
RO (mm)	1' - 6" (457)	2' - 0" (610)	2' - 6" (762)	3' - 0" (914)	3' - 6" (1067)	4' - 0" (1219)	5' - 0" (1524)	6' - 0" (1829)
FS (mm)	1' - 5 1/2" (445)	1' - 11 1/2" (597)	2' - 5 1/2" (749)	2' - 11 1/2" (902)	3' - 5 1/2" (1054)	3' - 11 1/2" (1207)	4' - 11 1/2" (1511)	5' - 11 1/2" (1816)
DLO (mm)	1153/64" (300)	1753/64" (453)	2353/64" (605)	2953/64" (757)	3553/64" (910)	4153/64" (1062)	5353/64" (1367)	6553/64" (1672)

0' - 11 3/4" (298)								
1' - 5 3/4" (451)								
1' - 11 3/4" (603)								

Construction Details

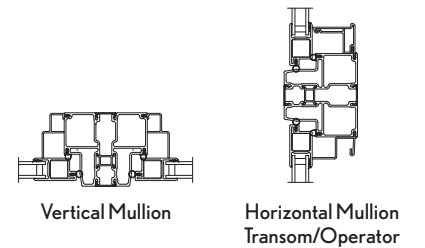
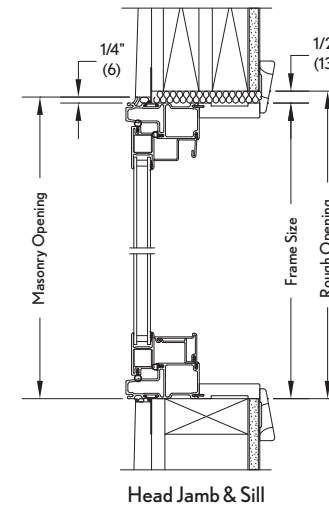
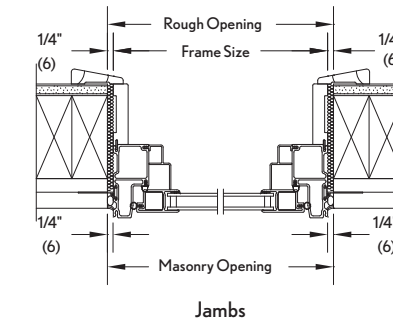







































































Multiple Assemblies
Multiple assemblies can be factory mullied.
MAXIMUM ROUGH OPENING not to exceed 114" X 78". Maximum up to 6 units wide by 1 unit high.
MAXIMUM ROUGH OPENING not to exceed 96" X 96". Maximum up to 5 units wide by 5 units high.
Field mull kits are available. Structural mullion reinforcement is required for some assemblies.
Please consult your local Integrity from Marvin representative for more information.

SINGLE HUNG

Operator Units







































































MO (mm)	1'-6" (457)	2'-0" (610)	2'-6" (762)	2'-8" (914)	3'-0" (914)	3'-6" (1067)	4'-0" (1219)
RO (mm)	1'-6" (457)	2'-0" (610)	2'-6" (762)	2'-8" (914)	3'-0" (914)	3'-6" (1067)	4'-0" (1219)
FS (mm)	1'-5 1/2" (445)	1'-11 1/2" (597)	2'-5 1/2" (749)	2'-7 1/2" (902)	2'-11 1/2" (902)	3'-5 1/2" (1054)	3'-11 1/2" (1207)
DLO (mm)	12 9/16" (319)	18 9/16" (471)	24 9/16" (624)	26 9/16" (675)	30 9/16" (776)	36 9/16" (929)	42 9/16" (1081)

1'-11 3/4" (603) 2'-0" (610) 1'-11 1/2" (597) 8 5/16" (211)							
2'-5 3/4" (756) 2'-6" (762) 2'-5 1/2" (749) 11 5/16" (287)							
2'-11 3/4" (908) 3'-0" (914) 2'-11 1/2" (902) 14 5/16" (363)							
3'-5 3/4" (1060) 3'-6" (1067) 3'-5 1/2" (1054) 17 5/16" (440)							
3'-11 3/4" (1213) 4'-0" (1219) 3'-11 1/2" (1207) 20 5/16" (516)							
4'-5 3/4" (1365) 4'-6" (1372) 4'-5 1/2" (1359) 23 5/16" (592)							
4'-11 3/4" (1518) 5'-0" (1524) 4'-11 1/2" (1511) 26 5/16" (668)							
5'-5 3/4" (1670) 5'-6" (1676) 5'-5 1/2" (1664) 29 5/16" (744)							
5'-11 3/4" (1822) 6'-0" (1829) 5'-11 1/2" (1816) 32 5/16" (821)							
6'-5 3/4" (1975) 6'-6" (1981) 6'-5 1/2" (1969) 35 5/16" (897)							

SINGLE HUNG

2 Wide Operator Units

MO (mm)	3'-0" (914)	4'-0" (1219)	5'-0" (1524)	5'-4" (1626)	6'-0" (1829)	7'-0" (2134)	8'-0" (2438)
RO (mm)	3'-0" (914)	4'-0" (1219)	5'-0" (1524)	5'-4" (1626)	6'-0" (1829)	7'-0" (2134)	8'-0" (2438)
FS (mm)	2'-11 1/2" (902)	3'-11 1/2" (1207)	4'-11 1/2" (1511)	5'-3 1/2" (1600)	5'-11 1/2" (1816)	6'-11 1/2" (2121)	7'-11 1/2" (2426)

1'-11 3/4" (603) 2'-0" (610) 1'-11 1/2" (597)							
2'-5 3/4" (756) 2'-6" (762) 2'-5 1/2" (749)							
2'-11 3/4" (908) 3'-0" (914) 2'-11 1/2" (902)							
3'-5 3/4" (1060) 3'-6" (1067) 3'-5 1/2" (1054)							
3'-11 3/4" (1213) 4'-0" (1219) 3'-11 1/2" (1207)							
4'-5 3/4" (1365) 4'-6" (1372) 4'-5 1/2" (1359)							
4'-11 3/4" (1518) 5'-0" (1524) 4'-11 1/2" (1511)							
5'-5 3/4" (1670) 5'-6" (1676) 5'-5 1/2" (1664)							
5'-11 3/4" (1822) 6'-0" (1829) 5'-11 1/2" (1816)							
6'-5 3/4" (1975) 6'-6" (1981) 6'-5 1/2" (1969)							

SINGLE HUNG

3 Wide Operator Units

MO (mm)	4' - 6" (1372)	6' - 0" (1829)	7' - 6" (2286)	8' - 0" (2438)	9' - 0" (2743)
RO (mm)	4' - 6" (1372)	6' - 0" (1829)	7' - 6" (2286)	8' - 0" (2438)	9' - 0" (2743)
FS (mm)	4' - 5 1/2" (1359)	5' - 11 1/2" (1816)	7' - 5 1/2" (2273)	7' - 11 1/2" (2413)	8' - 11 1/2" (2731)
1' - 11 3/4" (603)					
2' - 0" (610)					
2' - 5 3/4" (756)					
2' - 6" (762)					
2' - 11 3/4" (908)					
3' - 0" (914)					
3' - 5 3/4" (1060)					
3' - 6" (1067)					
3' - 11 3/4" (1213)					
4' - 0" (1219)					
4' - 5 3/4" (1365)					
4' - 6" (1372)					
4' - 11 3/4" (1518)					
5' - 0" (1524)					
5' - 5 3/4" (1670)					
5' - 6" (1676)					
5' - 11 3/4" (1822)					
6' - 0" (1829)					
6' - 5 3/4" (1975)					
6' - 6" (1981)					
6' - 5 1/2" (1969)					

SINGLE HUNG

4 Wide Operator Units

MO (mm)	6' - 0" (1829)	8' - 0" (2438)
RO (mm)	6' - 0" (1829)	8' - 0" (2438)
FS (mm)	5' - 11 1/2" (1816)	7' - 11 1/2" (2426)
1' - 11 3/4" (603)		
2' - 0" (610)		
2' - 5 3/4" (756)		
2' - 6" (762)		
2' - 11 3/4" (908)		
3' - 0" (914)		
3' - 5 3/4" (1060)		
3' - 6" (1067)		
3' - 11 3/4" (1213)		
4' - 0" (1219)		
4' - 5 3/4" (1365)		
4' - 6" (1372)		
4' - 11 3/4" (1518)		
5' - 0" (1524)		
5' - 5 3/4" (1670)		
5' - 6" (1676)		
5' - 11 3/4" (1822)		
6' - 0" (1829)		
6' - 5 3/4" (1975)		
6' - 6" (1981)		
6' - 5 1/2" (1969)		

GBG available in standard Rectangular lite cut, shown. Other GBG lite cuts shown on page 35.

E = These windows (in equal sash) meet National Egress Codes for fire evacuation. Local codes may differ.

Details and Elevations not to scale.

Available in equal, cottage and reverse cottage sash configurations. Cottage and reverse cottage sash configurations are not available on 20 call number heights.

Obscure Glass option available on all units.

Units may optionally include a window opening control device tested to ASTM F2090-10, which can be released from the inside without the use of a key, tool, special knowledge, or force greater than that required for normal unit operation.

Special sized units available within product size matrix. See your Integrity retailer.

See page 87 for specific PG Ratings.

Multiple Assemblies

Multiple assemblies can be factory mullled.

MAXIMUM ROUGH OPENING not to exceed 114" X 78". Maximum up to 6 units wide by 1 unit high.

MAXIMUM ROUGH OPENING not to exceed 96" X 96". Maximum up to 5 units wide by 5 units high.

Field mull kits are available. Structural mullion reinforcement is required for some assemblies.

Please consult your local Integrity from Marvin representative for more information.

SINGLE HUNG Transoms and Multiple Assemblies

In-Sash Transom Mullered Over Single Hung – Operator Unit

MO (mm)	2' - 6" (762)
RO (mm)	2' - 6" (762)
FS (mm)	2' - 5 1/2" (749)
DLO (mm)	24 9/16" (624)

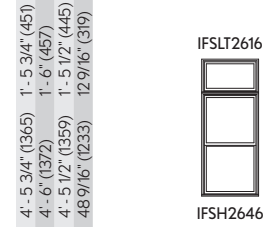

IFSLT2616

IFSH2646

In-Sash Transom Mullered Over Single Hung – 2 wide Operator Unit

MO (mm)	5' - 0" (1524)	2' - 6" (762)
RO (mm)	5' - 0" (1524)	2' - 6" (762)
FS (mm)	4' - 11 1/2" (1511)	2' - 5 1/2" (749)

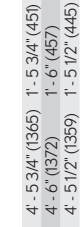

IFSLT5016

IFSH2646 / IFSH2646

Single Hung Flankers with Picture Center Unit *

MO (mm)	2' - 6" (762)	5' - 0" (1524)	2' - 6" (762)
RO (mm)	2' - 6" (762)	5' - 0" (1524)	2' - 6" (762)
FS (mm)	2' - 5 1/2" (749)	4' - 11 1/2" (1511)	2' - 5 1/2" (749)

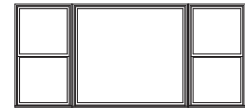

IFSH2646 / IFSLP5046 / IFSH2646

Single Hung Flankers with Operator Center Unit

MO (mm)	2' - 6" (762)	2' - 6" (762)	2' - 6" (762)
RO (mm)	2' - 6" (762)	2' - 6" (762)	2' - 6" (762)
FS (mm)	2' - 5 1/2" (749)	2' - 5 1/2" (749)	2' - 5 1/2" (749)

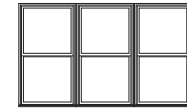
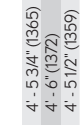

IFSH2646 / IFSH2646 / IFSH2646

Construction Details

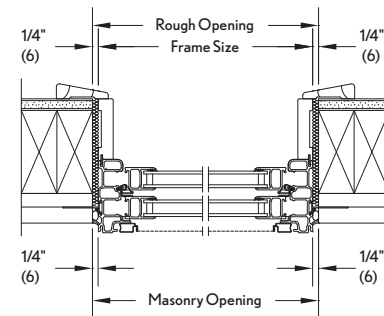

Head Jamb & Sill

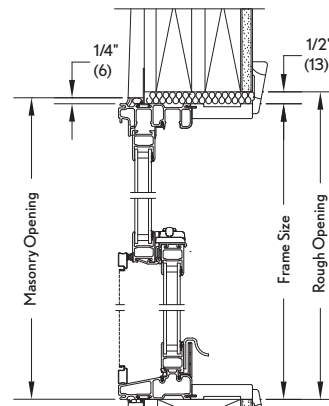

Jamb

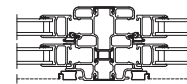

Vertical Mullion



Horizontal Mullion Transom/Operator

E = These windows (in equal sash) meet National Egress Codes for fire evacuation. Local codes may differ.

* This product is only available field mullered. Details and Elevations not to scale.

Available in equal, cottage and reverse cottage sash configurations. Cottage and reverse cottage sash configurations are not available on 20 and 66 call number heights.

Obscure Glass option available on all units.

Units may optionally include a window opening control device tested to ASTM F2090-10, which can be released from the inside without the use of a key, tool, special knowledge, or force greater than that required for normal unit operation.

Special sized units available within product size matrix. See your Integrity® retailer.

See page 87 for specific PG Ratings.

Multiple Assemblies

Multiple assemblies can be factory mullered.

MAXIMUM ROUGH OPENING not to exceed 114" X 78". Maximum up to 6 units wide by 1 unit high.

MAXIMUM ROUGH OPENING not to exceed 96" X 96". Maximum up to 5 units wide by 5 units high.

Field mull kits are available. Structural mullion reinforcement is required for some assemblies.

Please consult your local Integrity from Marvin® representative for more information.

DOUBLE HUNG

Operator Units

MO (mm)	1' - 6" (457)	2' - 0" (610)	2' - 6" (762)	2' - 8" (914)	3' - 0" (914)	3' - 6" (1067)	4' - 0" (1219)
RO (mm)	1' - 6" (457)	2' - 0" (610)	2' - 6" (762)	2' - 8" (914)	3' - 0" (914)	3' - 6" (1067)	4' - 0" (1219)
FS (mm)	1' - 5 1/2" (445)	1' - 11 1/2" (597)	2' - 5 1/2" (749)	2' - 7 1/2" (902)	2' - 11 1/2" (902)	3' - 5 1/2" (1054)	3' - 11 1/2" (1207)
DLO (mm)	12 9/16" (319)	18 9/16" (471)	24 9/16" (624)	26 9/16" (675)	30 9/16" (776)	36 9/16" (929)	42 9/16" (1081)

1' - 11 3/4" (603)							
2' - 0" (610)							
2' - 5 3/4" (756)							
2' - 6" (762)							
2' - 11 3/4" (908)							
3' - 0" (914)							
3' - 5 3/4" (1060)							
3' - 6" (1067)							
3' - 11 1/2" (1054)							
3' - 5 1/2" (892)							

DOUBLE HUNG

2 Wide Operator Units

MO (mm)	3' - 0" (914)	4' - 0" (1219)	5' - 0" (1524)	5' - 4" (1626)	6' - 0" (1829)	7' - 0" (2134)	8' - 0" (2438)
RO (mm)	3' - 0" (914)	4' - 0" (1219)	5' - 0" (1524)	5' - 4" (1626)	6' - 0" (1829)	7' - 0" (2134)	8' - 0" (2438)
FS (mm)	2' - 11 1/2" (902)	3' - 11 1/2" (1207)	4' - 11 1/2" (1511)	5' - 3 1/2" (1600)	5' - 11 1/2" (1816)	6' - 11 1/2" (2121)	7' - 11 1/2" (2426)

1' - 11 3/4" (603) 2' - 0" (610) 2' - 11 1/2" (597)							
2' - 5 3/4" (756) 2' - 6" (762) 2' - 5 1/2" (749)							
2' - 11 3/4" (908) 3' - 0" (914) 2' - 11 1/2" (902)							
3' - 5 3/4" (1060) 3' - 6" (1067) 3' - 5 1/2" (1054)							
3' - 11 3/4" (1213) 4' - 0" (1219) 3' - 11 1/2" (1207)							
4' - 5 3/4" (1365) 4' - 6" (1372) 4' - 5 1/2" (1359)							
4' - 11 3/4" (1518) 5' - 0" (1524) 4' - 11 1/2" (1511)							
5' - 5 3/4" (1670) 5' - 6" (1676) 5' - 5 1/2" (1664)							
5' - 11 3/4" (1822) 6' - 0" (1829) 5' - 11 1/2" (1816)							
6' - 5 3/4" (1975) 6' - 6" (1981) 6' - 5 1/2" (1969)							

DOUBLE HUNG

3 Wide Operator Units

MO (mm)	4' - 6" (1372)	6' - 0" (1829)	7' - 6" (2286)	8' - 0" (2438)	9' - 0" (2743)
RO (mm)	4' - 6" (1372)	6' - 0" (1829)	7' - 6" (2286)	8' - 0" (2438)	9' - 0" (2743)
FS (mm)	4' - 5 1/2" (1359)	5' - 11 1/2" (1816)	7' - 5 1/2" (2273)	7' 11 1/2" (2413)	8' - 11 1/2" (2731)

1' - 11 3/4" (603) 2' - 0" (610) 2' - 11 1/2" (597)					
2' - 5 3/4" (756) 2' - 6" (762) 2' - 5 1/2" (749)					
2' - 11 3/4" (908) 3' - 0" (914) 2' - 11 1/2" (902)					
3' - 5 3/4" (1060) 3' - 6" (1067) 3' - 5 1/2" (1054)					
3' - 11 3/4" (1213) 4' - 0" (1219) 3' - 11 1/2" (1207)					
4' - 5 3/4" (1365) 4' - 6" (1372) 4' - 5 1/2" (1359)					
4' - 11 3/4" (1518) 5' - 0" (1524) 4' - 11 1/2" (1511)					
5' - 5 3/4" (1670) 5' - 6" (1676) 5' - 5 1/2" (1664)					
5' - 11 3/4" (1822) 6' - 0" (1829) 5' - 11 1/2" (1816)					
6' - 5 3/4" (1975) 6' - 6" (1981) 6' - 5 1/2" (1969)					

DOUBLE HUNG

4 Wide Operator Units

MO (mm)	6' - 0" (1829)	8' - 0" (2438)
RO (mm)	6' - 0" (1829)	8' - 0" (2438)
FS (mm)	5' - 11 1/2" (1816)	7' - 11 1/2" (2426)

1' - 11 3/4" (603)		
2' - 5 3/4" (756)		
2' - 11 3/4" (908)		
3' - 5 3/4" (1060)		
3' - 11 3/4" (1213)		
4' - 5 3/4" (1365)		
4' - 11 3/4" (1518)		
5' - 5 3/4" (1670)		
5' - 11 3/4" (1822)		
6' - 5 3/4" (1975)		

GBG available in standard Rectangular lite cut, shown. Other GBG lite cuts shown on page 35.

E = These windows (in equal sash) meet National Egress Codes for fire evacuation. Local codes may differ.

Details and Elevations not to scale.

Available in equal, cottage and reverse cottage sash configurations. Cottage and reverse cottage sash configurations are not available on 20, 60 and 66 call number heights.

Obscure Glass option available on all units.

Units may optionally include a window opening control device tested to ASTM F2090-10, which can be released from the inside without the use of a key, tool, special knowledge, or force greater than that required for normal unit operation.

Special sized units available within product size matrix. See your Integrity® retailer.

See page 87 for specific PG Ratings.

Multiple Assemblies

Multiple assemblies can be factory mullled.

MAXIMUM ROUGH OPENING not to exceed 114" X 78". Maximum up to 6 units wide by 1 unit high.

MAXIMUM ROUGH OPENING not to exceed 96" X 96". Maximum up to 5 units wide by 5 units high.

Field mull kits are available. Structural mullion reinforcement is required for some assemblies.

Please consult your local Integrity from Marvin® representative for more information.

DOUBLE HUNG Transoms and Multiple Assemblies

INTEGRITY® FROM MARVIN®
ALL ULTREX® SERIES

In-Sash Transom Mullled Over Double Hung – Operator Unit

M.O. (mm)	2' - 6" (762)
R.O. (mm)	2' - 6" (762)
F.S. (mm)	2' - 5 1/2" (749)
DLO (mm)	24 9/16" (624)

4' - 5 3/4" (1365)	1' - 5 3/4" (451)	
4' - 6" (1372)	1' - 6" (457)	
4' - 5 1/2" (1359)	1' - 5 1/2" (445)	
48 9/16" (1233)	12 9/16" (319)	

In-Sash Transom Mullled Over Double Hung – 2 wide Operator Unit

MO (mm)	5' - 0" (1524)	2' - 6" (762)
RO (mm)	5' - 0" (1524)	2' - 6" (762)
FS (mm)	4' - 11 1/2" (1511)	2' - 5 1/2" (749)

4' - 5 3/4" (1365)	1' - 5 3/4" (451)	
4' - 6" (1372)	1' - 6" (457)	
4' - 5 1/2" (1359)	1' - 5 1/2" (445)	
48 9/16" (1233)	12 9/16" (319)	

Double Hung Flankers with Picture Center Unit*

M.O. (mm)	2' - 6" (762)	5' - 0" (1524)	2' - 6" (762)
R.O. (mm)	2' - 6" (762)	5' - 0" (1524)	2' - 6" (762)
F.S. (mm)	2' - 5 1/2" (749)	4' - 11 1/2" (1511)	2' - 5 1/2" (749)

4' - 5 3/4" (1365)	
4' - 6" (1372)	
4' - 5 1/2" (1359)	

Double Hung Flankers with Operator Center Unit

M.O. (mm)	2' - 6" (762)	2' - 6" (762)	2' - 6" (762)
R.O. (mm)	2' - 6" (762)	2' - 6" (762)	2' - 6" (762)
F.S. (mm)	2' - 5 1/2" (749)	2' - 5 1/2" (749)	2' - 5 1/2" (749)

4' - 5 3/4" (1365)	
4' - 6" (1372)	
4' - 5 1/2" (1359)	

Construction Details

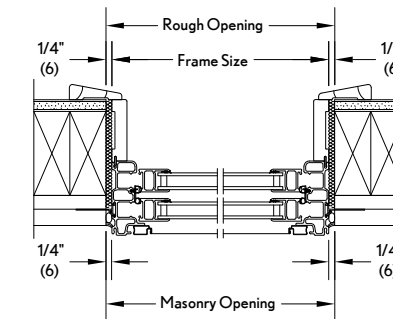

Jamb

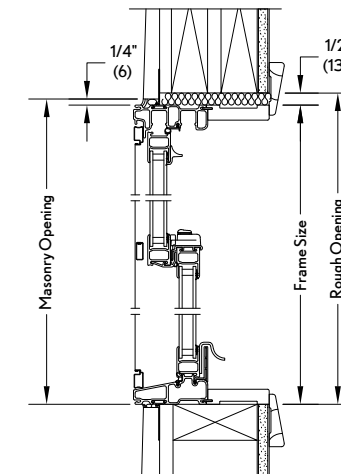

Head Jamb & Sill

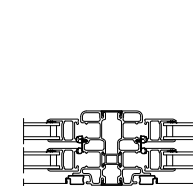

Vertical Mullion

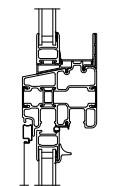

Horizontal Mullion Transom/Operator

*This product is only available field mullled.

Details and Elevations not to scale.

Available in equal, cottage and reverse cottage sash configurations. Cottage and reverse cottage sash configurations are not available on 20, 60 and 66 call number heights.

Obscure Glass option available on all units.

Units may optionally include a window opening control device tested to ASTM F2090-10, which can be released from the inside without the use of a key, tool, special knowledge, or force greater than that required for normal unit operation.

Special sized units available within product size matrix. See your Integrity retailer.

See page 87 for specific PG Ratings.

Multiple Assemblies

Multiple assemblies can be factory mullled.

MAXIMUM ROUGH OPENING not to exceed 114" X 78". Maximum up to 6 units wide by 1 unit high.

MAXIMUM ROUGH OPENING not to exceed 96" X 96". Maximum up to 5 units wide by 5 units high.

Field mull kits are available. Structural mullion reinforcement is required for some assemblies.

Please consult your local Integrity from Marvin® representative for more information.

GLIDER

Operator Units

MO (mm)	2'-6" (762)	3'-0" (914)	3'-6" (1067)	4'-0" (1219)	4'-6" (1372)	5'-0" (1524)	6'-0" (1829)
RO (mm)	2'-6" (762)	3'-0" (914)	3'-6" (1067)	4'-0" (1219)	4'-6" (1372)	5'-0" (1524)	6'-0" (1829)
FS (mm)	2'-5 1/2" (749)	2'-11 1/2" (902)	3'-5 1/2" (1054)	3'-11 1/2" (1207)	4'-5 1/2" (1359)	4'-11 1/2" (1511)	5'-11 1/2" (1816)
DLO (mm)	115/16" (287)	145/16" (363)	175/16" (440)	205/16" (516)	235/16" (592)	265/16" (668)	325/16" (821)
1'-5 3/4" (451)	IFGL2616	IFGL3016	IFGL3616	IFGL4016	IFGL4616	IFGL5016	IFGL6016
1'-6" (457)							
1'-5 1/2" (445)							
129/6" (319)							
1'-11 3/4" (603)	IFGL2620	IFGL3020	IFGL3620	IFGL4020	IFGL4620	IFGL5020	IFGL6020
2'-0" (610)							
1'-11 1/2" (597)							
189/6" (471)							
2'-5 3/4" (756)	IFGL2626	IFGL30126	IFGL36126	IFGL4026	IFGL4626	IFGL5026	IFGL6026 E
2'-6" (762)							
2'-5 1/2" (749)							
249/6" (624)							
2'-11 3/4" (908)	IFGL2630	IFGL3030	IFGL3630	IFGL4030	IFGL4630	IFGL5030 E	IFGL6030 E
3'-0" (914)							
2'-11 1/2" (902)							
309/6" (776)							
3'-5 3/4" (1060)	IFGL2636	IFGL3036	IFGL3636	IFGL4036	IFGL4636 E	IFGL5036 E	IFGL6036 E
3'-6" (1067)							
3'-5 1/2" (1054)							
369/6" (929)							
3'-11 3/4" (1213)	IFGL2640	IFGL3040	IFGL3640	IFGL4040 E	IFGL4640 E	IFGL5040 E	IFGL6040 E
4'-0" (1219)							
3'-11 1/2" (1207)							
429/6" (1081)							
4'-5 3/4" (1365)	IFGL2646	IFGL3046	IFGL3646	IFGL4046 E	IFGL4646 E	IFGL5046 E	IFGL6046 E
4'-6" (1372)							
4'-5 1/2" (1359)							
489/6" (1233)							
4'-11 3/4" (1518)	IFGL2650	IFGL3050	IFGL3650	IFGL4050 E	IFGL4650 E	IFGL5050 E	IFGL6050 E
5'-0" (1524)							
4'-11 1/2" (1511)							
549/6" (1386)							

GLIDER

Operator Units

MO (mm)	6'-0" (1829)	7'-0" (2134)	8'-0" (2438)
RO (mm)	6'-0" (1829)	7'-0" (2134)	8'-0" (2438)
FS (mm)	5'-11 1/2" (1816)	6'-11 1/2" (2121)	7'-11 1/2" (2426)
1'-5 3/4" (451)	IFGLTS6016	IFGLTS7016	IFGLTS8016
1'-6" (457)			
1'-5 1/2" (445)			
1'-11 3/4" (603)	IFGLTS6020	IFGLTS7020	IFGLTS8020
2'-0" (610)			
1'-11 1/2" (597)			
2'-5 3/4" (756)	IFGLTS6026	IFGLTS7026	IFGLTS8026
2'-6" (762)			
2'-5 1/2" (749)			
2'-11 3/4" (908)	IFGLTS6030	IFGLTS7030	IFGLTS8030
3'-0" (914)			
2'-11 1/2" (902)			
3'-5 3/4" (1060)	IFGLTS6036	IFGLTS7036	IFGLTS8036
3'-6" (1067)			
3'-5 1/2" (1054)			
3'-11 3/4" (1213)	IFGLTS6040	IFGLTS7040	IFGLTS8040 E
4'-0" (1219)			
3'-11 1/2" (1207)			
4'-5 3/4" (1365)	IFGLTS6046	IFGLTS7046	IFGLTS8046 E
4'-6" (1372)			
4'-5 1/2" (1359)			
4'-11 3/4" (1518)	IFGLTS6050	IFGLTS7050	IFGLTS8050 E
5'-0" (1524)			
4'-11 1/2" (1511)			

GBG available in standard Rectangular lite cut, shown. Other GBG lite cuts shown on page 35.

E = These windows meet National Egress Codes for fire evacuation. Local codes may differ.

Details and Elevations not to scale.

Obscure Glass option available on all units.

Units may optionally include a window opening control device tested to ASTM F2090-10, which can be released from the inside without the use of a key, tool, special knowledge, or force greater than that required for normal unit operation.

Special sized units available within productsize matrix. See your Integrity retailer.

See page 87 for specific PG Ratings.

Multiple Assemblies

Multiple assemblies can be factory mullied.

MAXIMUM ROUGH OPENING not to exceed

114" X 60". Maximum up to 3 units wide by 1 unit high.

MAXIMUM ROUGH OPENING not to exceed

72" X 78". Maximum up to 2 units wide by 2 units high.

Field mull kits are available. Structural mullion reinforcement is required for some assemblies.

Please consult your local Integrity from Marvin representative for more information.

Construction Details

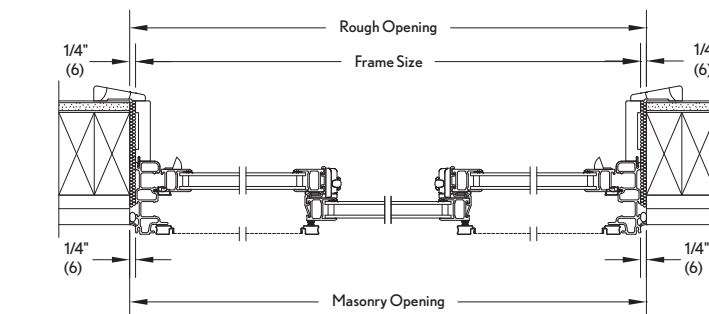
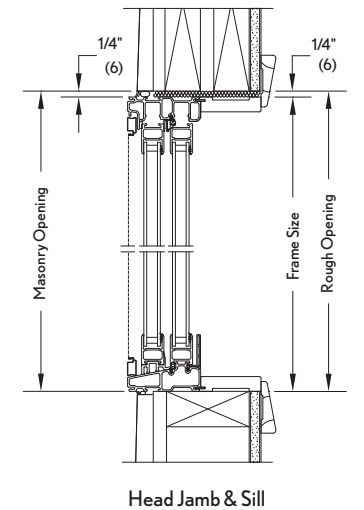

Triple Sash XOX Operator Jamb

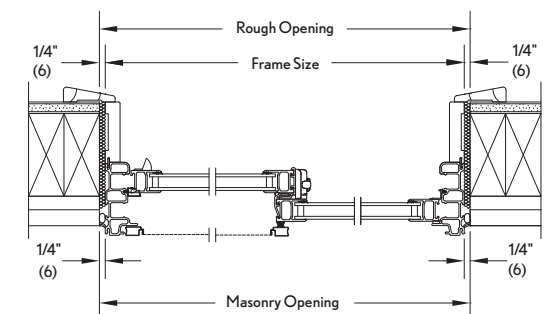

Jambs

GLIDER

2 Wide Operator Units

MO (mm)	5' - 0" (1524)	6' - 0" (1828)	7' - 0" (2134)	8' - 0" (2438)	9' - 0" (2744)
RO (mm)	5' - 0" (1524)	6' - 0" (1828)	7' - 0" (2134)	8' - 0" (2438)	9' - 0" (2744)
FS (mm)	4' - 11 1/2" (1511)	5' - 11 1/2" (1816)	6' - 11 1/2" (2121)	7' - 11 1/2" (2426)	8' - 11 1/2" (2734)
1' - 5 3/4" (451)	IFGL2616	IFGL3016	IFGL3616	IFGL4016	IFGL4616
1' - 11 3/4" (603)	IFGL2620	IFGL3020	IFGL3620	IFGL4020	IFGL4620
2' - 5 3/4" (756)	IFGL2626	IFGL30126	IFGL36126	IFGL4026	IFGL4626
2' - 11 3/4" (908)	IFGL2630	IFGL3030	IFGL3630	IFGL4030	IFGL4630
3' - 5 3/4" (1060)	IFGL2636	IFGL3036	IFGL3636	IFGL4036	IFGL4636 E
3' - 11 3/4" (1213)	IFGL2640	IFGL3040	IFGL3640	IFGL4040 E	IFGL4640 E
4' - 5 3/4" (1365)	IFGL2646	IFGL3046	IFGL3646	IFGL4046 E	IFGL4646 E
4' - 11 3/4" (1518)	IFGL2650	IFGL3050	IFGL3650	IFGL4050 E	IFGL4650 E

GBG available in standard Rectangular lite cut, shown above. Other GBG lite cuts shown on page 35.

E = These windows meet National Egress Codes for fire evacuation. Local codes may differ.

Details and Elevations not to scale.

Obscure Glass option available on all units.

Special sized units available within product size matrix. See your Integrity® retailer.

See page 87 for specific PG Ratings.

Multiple Assemblies

Multiple assemblies can be factory mullied.

MAXIMUM ROUGH OPENING not to exceed 114" X 60". Maximum up to 3 units wide by 1 unit high.

MAXIMUM ROUGH OPENING not to exceed 72" X 78". Maximum up to 2 units wide by 2 units high.

Field mull kits are available. Structural mullion reinforcement is required for some assemblies.

Please consult your local Integrity from Marvin® representative for more information.

Construction Details

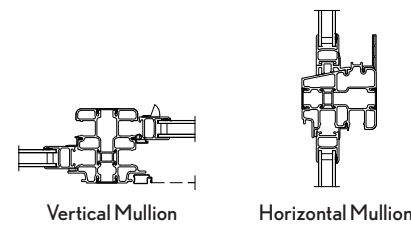

Vertical Mullion

Horizontal Mullion

SLIDING PICTURE UNITS

INTEGRITY® FROM MARVIN®
ALL ULTREX® SERIES

Picture Units

MO (mm)	1' - 6" (457)	2' - 0" (610)	2' - 6" (762)	2' - 8" (914)	3' - 0" (914)	3' - 6" (1067)	4' - 0" (1219)	5' - 0" (1524)
RO (mm)	1' - 6" (457)	2' - 0" (610)	2' - 6" (762)	2' - 8" (914)	3' - 0" (914)	3' - 6" (1067)	4' - 0" (1219)	5' - 0" (1524)
FS (mm)	1' - 5 1/2" (445)	1' - 11 1/2" (597)	2' - 5 1/2" (749)	2' - 7 1/2" (902)	2' - 11 1/2" (902)	3' - 5 1/2" (1054)	3' - 11 1/2" (1207)	4' - 11 1/2" (1511)
DLO (mm)	12 9/16" (319)	18 9/16" (471)	24 9/16" (624)	26 9/16" (675)	30 9/16" (776)	36 9/16" (929)	42 9/16" (1081)	54 9/16" (1381)
1' - 11 3/4" (603)	IFSLP1620	IFSLP2020	IFSLP2620	IFSLP2820	IFSLP3020	IFSLP3620	IFSLP4020	IFSLP5020
2' - 5 3/4" (756)	IFSLP1626	IFSLP2026	IFSLP2626	IFSLP2826	IFSLP3026	IFSLP3626	IFSLP4026	IFSLP5026
2' - 11 3/4" (908)	IFSLP1630	IFSLP2030	IFSLP2630	IFSLP2830	IFSLP3030	IFSLP3630	IFSLP4030	IFSLP5030
3' - 5 3/4" (1060)	IFSLP1636	IFSLP2036	IFSLP2636	IFSLP2836	IFSLP3036	IFSLP3636	IFSLP4036	IFSLP5036
3' - 11 3/4" (1213)	IFSLP1640	IFSLP2040	IFSLP2640	IFSLP2840	IFSLP3040	IFSLP3640	IFSLP4040	IFSLP5040
4' - 5 3/4" (1365)	IFSLP1646	IFSLP2046	IFSLP2646	IFSLP2846	IFSLP3046	IFSLP3646	IFSLP4046	IFSLP5046
4' - 11 3/4" (1518)	IFSLP1650	IFSLP2050	IFSLP2650	IFSLP2850	IFSLP3050	IFSLP3650	IFSLP4050	IFSLP5050
5' - 5 3/4" (1670)	IFSLP1656	IFSLP2056	IFSLP2656	IFSLP2856	IFSLP3056	IFSLP3656	IFSLP4056	IFSLP5056
5' - 11 3/4" (1822)	IFSLP1660	IFSLP2060	IFSLP2660	IFSLP2860	IFSLP3060	IFSLP3660	IFSLP4060	IFSLP5060 T

SLIDING PICTURE AND TRANSOM UNITS

In-Sash Transom

MO (mm)	1'-6" (457)	2'-0" (610)	2'-6" (762)	2'-8" (914)	3'-0" (914)	3'-6" (1067)	4'-0" (1219)	5'-0" (1524)
RO (mm)	1'-6" (457)	2'-0" (610)	2'-6" (762)	2'-8" (914)	3'-0" (914)	3'-6" (1067)	4'-0" (1219)	5'-0" (1524)
FS (mm)	1'-5 1/2" (445)	1'-11 1/2" (597)	2'-5 1/2" (749)	2'-7 1/2" (902)	2'-11 1/2" (902)	3'-5 1/2" (1054)	3'-11 1/2" (1207)	4'-11 1/2" (1511)
DLO (mm)	12 9/16" (319)	18 9/16" (471)	24 9/16" (624)	26 9/16" (675)	30 9/16" (776)	36 9/16" (929)	42 9/16" (1081)	54 9/16" (1381)

0'-11 3/4" (298)	IFSLT1610	IFSLT2010	IFSLT2610	IFSLT2810	IFSLT3010	IFSLT3610	IFSLT4010	IFSLT5010
1'-0" (305)								
1'-5 3/4" (451)	IFSLT1616	IFSLT2016	IFSLT2616	IFSLT2816	IFSLT3016	IFSLT3616	IFSLT4016	IFSLT5016
1'-6" (457)								
1'-5 1/2" (445)								
1'-11 1/2" (597)								
18 9/16" (471)								
1'-11 3/4" (603)	IFSLT1620	IFSLT2020	IFSLT2620	IFSLT2820	IFSLT3020	IFSLT3620	IFSLT4020	IFSLT5020
2'-0" (610)								

Construction Details

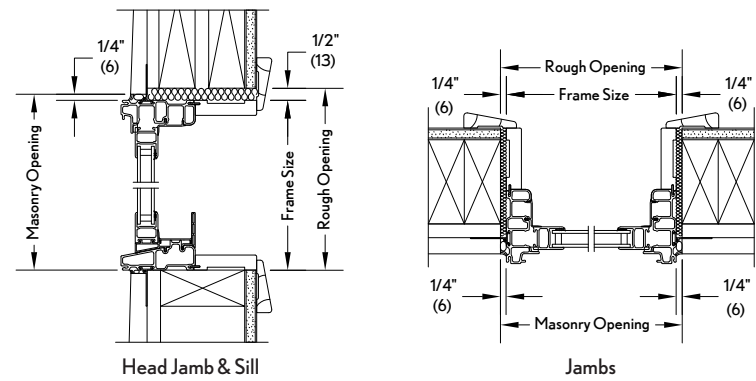

GBG available in standard Rectangular lite cut, shown above. Other GBG lite cuts shown on page 35. (Not available on In-Sash Transom units.)

Details and Elevations not to scale.

Special sized units available within product size matrix. See your Integrity® retailer.

See page 87 for specific PG Ratings.

Multiple Assemblies

Multiple assemblies can be factory mullied.

MAXIMUM ROUGH OPENING not to exceed 114" X 78". Maximum up to 6 units wide by 1 unit high.

MAXIMUM ROUGH OPENING not to exceed 96" X 96". Maximum up to 5 units wide by 5 units high.

Field mull kits are available. Structural mullion reinforcement is required for some assemblies.

Please consult your local Integrity from Marvin® representative for more information.

ROUND TOPS

True Half Round (RT)

MO (mm)	2'-6" (762)	MO (mm)	2'-8" (813)	MO (mm)	3'-0" (914)	MO (mm)	3'-6" (1067)
RO (mm)	2'-6" (762)	RO (mm)	2'-8" (813)	RO (mm)	3'-0" (914)	RO (mm)	3'-6" (1067)
FS (mm)	2'-5 1/2" (749)	FS (mm)	2'-7 1/2" (800)	FS (mm)	2'-11 1/2" (902)	FS (mm)	3'-5 1/2" (1054)
DLO (mm)	25 53/64" (656)	DLO (mm)	27 27/32" (707)	DLO (mm)	31 7/8" (810)	DLO (mm)	37 29/32" (963)

1'-3" (381)	IFRT2613	1'-4" (406)	IFRT2814	1'-6" (457)	IFRT3016	1'-9 1/4" (540)	IFRT3619
1'-3 1/4" (387)		1'-4 1/4" (413)		1'-6 1/4" (464)		1'-8 3/4" (527)	
1'-2 3/4" (451)		1'-3 3/4" (400)		1'-5 3/4" (451)		17 5/16" (440)	
11 5/16" (287)		12 5/16" (313)		14 5/16" (363)			

MO (mm)	4'-0" (1219)	MO (mm)	5'-0" (1524)	MO (mm)	5'-4" (1626)
RO (mm)	4'-0" (1219)	RO (mm)	5'-0" (1524)	RO (mm)	5'-4" (1626)
FS (mm)	3'-11 1/2" (1207)	FS (mm)	4'-11 1/2" (1511)	FS (mm)	5'-3 1/2" (1600)
DLO (mm)	43 59/64" (1116)	DLO (mm)	55 61/64" (1421)	DLO (mm)	59 61/64" (1523)

2'-0" (610)	IFRT4020	2'-6" (645)	IFRT5026	2'-8" (813)	IFRT5428
2'-0 1/4" (616)		2'-6 1/4" (788)		2'-8 1/4" (819)	
1'-11 3/4" (603)		2'-5 3/4" (756)		2'-7 3/4" (806)	
20 5/16" (516)		26 5/16" (668)		28 5/16" (719)	

MO (mm)	6'-0" (1829)	MO (mm)	7'-0" (2134)	MO (mm)	8'-0" (2438)
RO (mm)	6'-0" (1829)	RO (mm)	7'-0" (2134)	RO (mm)	8'-0" (2438)
FS (mm)	5'-11 1/2" (1816)	FS (mm)	6'-11 1/2" (2121)	FS (mm)	7'-11 1/2" (2426)
DLO (mm)	67 31/32" (1726)	DLO (mm)	79 63/64" (2032)	DLO (mm)	92 23/37" (2337)

3'-0" (914)	IFRT6030	3'-6" (1067)	IFRT7036	4'-0" (1219)	IFRT8040
3'-0 1/4" (921)		3'-6 1/4" (1073)		4'-0 1/4" (1226)	
2'-11 3/4" (908)		3'-5 3/4" (1060)		3'-11 3/4" (1213)	
32 5/16" (821)		38 5/16" (973)		44 5/16" (1125)	

Multiple Assemblies

MO (mm)	3'-0" (914)
RO (mm)	3'-0" (914)
FS (mm)	2'-11 1/2" (902)

6'-6" (1981)	IFRT3016 Over IFDH3050
6'-6 1/4" (1975)	
6'-5 3/4" (1986)	

MO (mm)	5'-0" (1524)
RO (mm)	5'-0" (1524)
FS (mm)	4'-11 1/2" (1511)

7'-0" (2134)	IFRT5026 Over IFCA2646
7'-0 1/4" (2140)	
6'-11 3/4" (2127)	

Construction Details

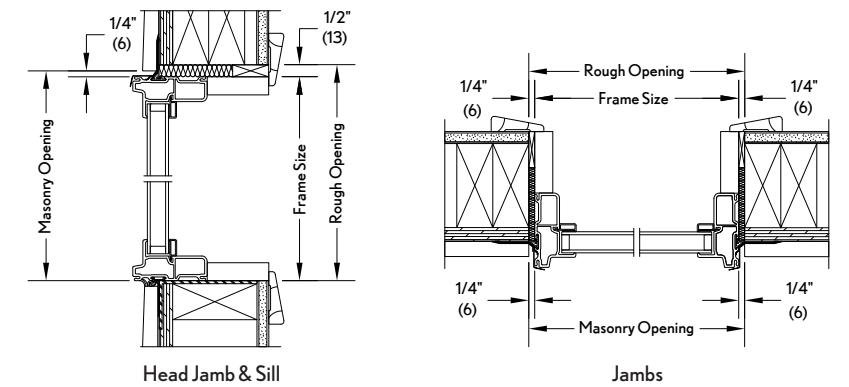

GBG only available in standard Round Top pattern, shown above.

Details and Elevations not to scale.

Sample multiples assemblies shown. Contact your Integrity from Marvin representative for more information.

Multiple Assemblies

MAXIMUM ROUGH OPENING - IFRT to IFCA, IFAWN, IFSWP, IFSH, IFDH, IFSLP, IFDGP (Rectangle), IFSLT, IFSWT not to exceed 96"x96" up to 5W2H.

MAXIMUM ROUGH OPENING - IFRT to IFGL not to exceed 72"x78" up to 2 wide 2 high.

Both horizontal and vertical field mull kits are available. Structural mullion reinforcement is required for some assemblies. Please consult your local Integrity from Marvin representative for more information.

ROUND TOPS

True Half Above Springline (RT2)

MO (mm)	2'-6" (762)	2'-8" (914)	3'-0" (914)	3'-6" (1067)
RO (mm)	2'-6" (762)	2'-8" (914)	3'-0" (914)	3'-6" (1067)
FS (mm)	2'-5 1/2" (749)	2'-7 1/2" (902)	2'-11 1/2" (902)	3'-5 1/2" (1054)
6'-2 1/2" (892)				
6'-2 3/4" (899)				
6'-2 1/4" (886)				
5'-8 1/2" (1740)				
5'-8 3/4" (1746)				
5'-8 1/4" (1734)				
5'-2 1/2" (1588)				
5'-2 3/4" (1594)				
5'-2 1/4" (1581)				
5'-9 1/2" (1765)				
5'-9 3/4" (1772)				
5'-9 1/4" (1759)				
5'-3 1/2" (1613)				
5'-3 3/4" (1619)				
5'-3 1/4" (1607)				
5'-5 1/2" (1664)				
5'-5 3/4" (1670)				
5'-5 1/4" (1657)				
5'-11 1/2" (1816)				
5'-11 3/4" (1822)				
5'-11 1/4" (1810)				
6'-2 1/2" (1892)				
6'-2 3/4" (1899)				
6'-2 1/4" (1886)				
6'-5 1/2" (1969)				
6'-5 3/4" (1975)				
6'-5 1/4" (1962)				
6'-11 1/2" (2045)				
6'-11 3/4" (2051)				
6'-11 1/4" (2038)				
2'-2 1/2" (673)				
2'-2 3/4" (679)				
2'-2 1/4" (671)				
2'-8 1/2" (826)				
2'-8 3/4" (832)				
2'-8 1/4" (819)				
3'-2 1/2" (978)				
3'-2 3/4" (984)				
3'-2 1/4" (972)				
3'-8 1/2" (1130)				
3'-8 3/4" (1137)				
3'-8 1/4" (1124)				
3'-11 1/2" (1207)				
3'-11 3/4" (1213)				
3'-11 1/4" (1200)				
4'-2 1/2" (1283)				
4'-2 3/4" (1289)				
4'-2 1/4" (1289)				
4'-5 1/2" (1359)				
4'-5 3/4" (1365)				
4'-5 1/4" (1353)				
4'-11 1/2" (1511)				
4'-11 3/4" (1518)				
4'-11 1/4" (1505)				
4'-3 1/2" (1308)				
4'-3 3/4" (1314)				
4'-3 1/4" (1302)				
4'-9 1/2" (1461)				
4'-9 3/4" (1467)				
4'-9 1/4" (1454)				
4'-11 1/2" (1435)				
4'-11 3/4" (1441)				
4'-11 1/4" (1429)				
3'-5 1/2" (1054)				
3'-5 3/4" (1060)				
3'-5 1/4" (1048)				
3'-11 1/2" (1207)				
3'-11 3/4" (1213)				
3'-11 1/4" (1200)				
3'-8 1/2" (1130)				
3'-8 3/4" (1137)				
3'-8 1/4" (1124)				
3'-5 1/2" (1054)				
3'-5 3/4" (1060)				
3'-5 1/4" (1048)				
3'-11 1/2" (1207)				
3'-11 3/4" (1213)				
3'-11 1/4" (1200)				
3'-9 1/2" (1156)				
3'-9 3/4" (1162)				
3'-9 1/4" (1149)				
3'-3 1/2" (1003)				
3'-3 3/4" (1010)				
3'-3 1/4" (997)				
2'-9 1/2" (851)				
2'-9 3/4" (857)				
2'-9 1/4" (845)				

ROUND TOPS

True Half Above Springline (RT2)

MO (mm)	4'-0" (1219)	5'-0" (1524)	5'-4" (1626)	6'-0" (1829)
RO (mm)	4'-0" (1219)	5'-0" (1524)	5'-4" (1626)	6'-0" (1829)
FS (mm)	3'-11 1/2" (1207)	4'-11 1/2" (1511)	5'-3 1/2" (1600)	5'-11 1/2" (1816)
6'-11 1/2" (2121)				
6'-11 3/4" (2127)				
6'-11 1/4" (2115)				
6'-5 1/2" (1969)				
6'-5 3/4" (1975)				
6'-5 1/4" (1962)				
6'-11 1/2" (2121)				
6'-11 3/4" (2127)				
6'-11 1/4" (2115)				
5'-11 1/2" (1816)				
5'-11 3/4" (1822)				
5'-11 1/4" (1810)				
5'-5 1/2" (1664)				
5'-5 3/4" (1670)				
5'-5 1/4" (1657)				
5'-11 1/2" (1816)				
5'-11 3/4" (1822)				
5'-11 1/4" (1810)				
5'-7 1/2" (1715)				
5'-7 3/4" (1721)				
5'-7 1/4" (1708)				
6'-7 1/2" (2019)				
6'-7 3/4" (2026)				
6'-7 1/4" (2013)				
4'-5 1/2" (1359)				
4'-5 3/4" (1365)				
4'-5 1/4" (1353)				
4'-11 1/2" (1511)				
4'-11 3/4" (1518)				
4'-11 1/4" (1505)				
4'-7 1/2" (1410)				
4'-7 3/4" (1416)				
4'-7 1/4" (1403)				
4'-11 1/2" (1511)				
4'-11 3/4" (1518)				
4'-11 1/4" (1505)				
4'-5 1/2" (1359)				
4'-5 3/4" (1365)				
4'-5 1/4" (1353)				
4'-11 1/2" (1511)				
4'-11 3/4" (1518)				
4'-11 1/4" (1505)				
4'-11 1/2" (1511)				
4'-11 3/4" (1518)				
4'-11 1/4" (1505)				
3'-11 1/2" (1207)				
3'-11 3/4" (1213)				
3'-11 1/4" (1200)				
3'-5 1/2" (1054)				
3'-5 3/4" (1060)				
3'-5 1/4" (1048)				
3'-11 1/2" (1207)				
3'-11 3/4" (1213)				
3'-11 1/4" (1200)				
3'-7 1/2" (1105)				
3'-7 3/4" (1111)				
3'-7 1/4" (1099)				
5'-11 1/2" (1816)				
5'-11 3/4" (1822)				
5'-11 1/4" (1810)				
5'-5 1/2" (1664)				
5'-5 3/4" (1670)				
5'-5 1/4" (1657)				
5'-11 1/2" (1816)				
5'-11 3/4" (1822)				
5'-11 1/4" (1810)				
5'-7 1/2" (1715)				
5'-7 3/4" (1721)				
5'-7 1/4" (1708)				
6'-11 1/2" (2121)				
6'-11 3/4" (2127)				
6'-11 1/4" (2115)				
6'-11 1/2" (2121)				
6'-11 3/4" (2127)				
6'-11 1/4" (2115)				
6'-8 1/2" (2045)				
6'-8 3/4" (2051)				
6'-8 1/4" (2038)				
6'-5 1/2" (1969)				
6'-5 3/4" (1975)				
6'-5 1/4" (1962)				
6'-11 1/2" (2121)				
6'-11 3/4" (2127)				
6'-11 1/4" (2115)				
3'-5 1/2" (1054)				
3'-5 3/4" (1060)				
3'-5 1/4" (1048)				
3'-11 1/2" (1207)				
3'-11 3/4" (1213)				
3'-11 1/4" (1200)				
3'-7 1/2" (1105)				
3'-7 3/4" (1111)				
3'-7 1/4" (1099)				
5'-11 1/2" (1816)				
5'-11 3/4" (1822)				
5'-11 1/4" (1810)				
5'-5 1/2" (1664)				
5'-5 3/4" (1670)				
5'-5 1/4" (1657)				
5'-11 1/2" (1816)				
5'-11 3/4" (1822)				
5'-11 1/4" (1810)				
5'-7 1/2" (1715)				
5'-7 3/4" (1721)				
5'-7 1/4" (1708)				
6'-11 1/2" (2121)				
6'-11 3/4" (2127)				
6'-11 1/4" (2115)				
6'-11 1/2" (2121)				
6'-11 3/4" (2127)				
6'-11 1/4" (2115)				
6'-8 1/2" (2045)				
6'-8 3/4" (2051)				
6'-8 1/4" (2038)				
6'-5 1/2" (1969)				
6'-5 3/4" (1975)				
6'-5 1/4" (1962)				
6'-11 1/2" (2121)				
6'-11 3/4" (2127)				
6'-11 1/4" (2115)				
6'-11 1/2" (2121)				
6'-11 3/4" (2127)				
6'-11 1/4" (2115)				
6'-8 1/2" (2045)				
6'-8 3/4" (2051)				
6'-8 1/4" (2038)				
6'-5 1/2" (1969)				
6'-5 3/4" (1975)				
6'-5 1/4" (1962)				
6'-11 1/2" (2121)				
6'-11 3/4" (2127)				
6'-11 1/4" (2115)				

ROUND TOPS

Eyebrow Above Springline (RT6)

MO (mm)	2'-6" (762)	2'-8" (914)	3'-0" (914)	3'-6" (1067)	4'-0" (1219)
RO (mm)	2'-6" (762)	2'-8" (914)	3'-0" (914)	3'-6" (1067)	4'-0" (1219)
FS (mm)	2'-5 1/2" (749)	2'-7 1/2" (902)	2'-11 1/2" (902)	3'-5 1/2" (1054)	3'-11 1/2" (1207)
6'-2 15/16" (1904)					
6'-3 3/16" (1910)					
6'-2 11/16" (1898)					
IFRT2660					
5'-8 15/16" (1752)					
5'-9 3/16" (1758)					
5'-8 11/16" (1745)					
IFRT2656					
5'-2 15/16" (1599)					
5'-3 3/16" (1606)					
5'-2 11/16" (1593)					
IFRT2650					
4'-8 15/16" (1447)					
4'-9 3/16" (1453)					
4'-8 11/16" (1440)					
IFRT2646					
4'-2 15/16" (1294)					
4'-3 3/16" (1301)					
4'-2 11/16" (1288)					
IFRT2640					
3'-8 15/16" (1142)					
3'-9 3/16" (1148)					
3'-8 11/16" (1136)					
IFRT2636					
3'-2 15/16" (990)					
3'-3 3/16" (996)					
3'-2 11/16" (983)					
IFRT2630					
2'-8 15/16" (837)					
2'-9 3/16" (844)					
2'-8 11/16" (831)					
IFRT2626					
2'-2 15/16" (685)					
2'-3 3/16" (691)					
2'-2 11/16" (678)					
IFRT2620					
2'-9 7/16" (697)					
2'-3 7/16" (697)					
2'-9 7/16" (697)					
IFRT2616					
1'-2 15/16" (380)					
1'-3 3/16" (386)					
1'-2 11/16" (374)					
IFRT2610					

ROUND TOPS

Eyebrow Above Springline (RT6)

MO (mm)	5'-0" (1524)	5'-4" (1626)	6'-0" (1829)	7'-0" (2134)	8'-0" (2438)
RO (mm)	5'-0" (1524)	5'-4" (1626)	6'-0" (1829)	7'-0" (2134)	8'-0" (2438)
FS (mm)	4'-11 1/2" (1511)	5'-3 1/2" (1600)	5'-11 1/2" (1816)	6'-11 1/2" (2121)	7'-11 1/2" (2426)
6'-7 3/4" (2025)					
6'-8" (2031)					
6'-7 1/2" (2019)					
IFRT5060					
6'-13/16" (1873)					
6'-2" (1879)					
6'-11/2" (1866)					
IFRT5056					
6'-7 3/16" (1859)					
6'-7 7/16" (1865)					
6'-0 15/16" (1853)					
IFRT5460					
5'-7 3/16" (1707)					
5'-7 7/16" (1713)					
5'-6 15/16" (1700)					
IFRT5450					
5'-13/16" (1554)					
5'-17/16" (1560)					
5'-0 5/16" (1548)					
IFRT5446					
4'-7 3/16" (1402)					
4'-7 7/16" (1408)					
4'-6 15/16" (1395)					
IFRT5440					
4'-9 5/16" (1456)					
4'-9 9/16" (1463)					
4'-9 1/16" (1450)					
IFRT6040					
4'-3 5/16" (1304)					
4'-3 9/16" (1310)					
4'-3 1/16" (1297)					
IFRT6036					
3'-9 5/16" (1151)					
3'-9 9/16" (1158)					
3'-9 1/16" (1145)					
IFRT6030					
3'-13/16" (1097)					
3'-7 7/16" (1103)					
3'-0 15/16" (938)					
IFRT5430					
3'-13/16" (945)					
3'-17/16" (951)					
3'-0 15/16" (938)					
IFRT5426					
2'-7 3/16" (847)					
2'-7 7/16" (853)					
2'-6 15/16" (840)					
IFRT5420					
2'-13/16" (640)					
2'-13/16" (640)					
2'-13/16" (640)					
IFRT5410					
5'-0" (1524)					
5'-0" (1524)					
4'-11 1/2" (1511)					
IFRT5010					

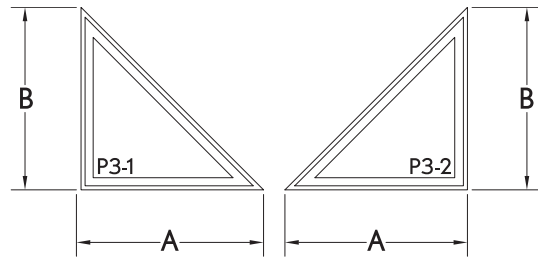

90° TRIANGLE

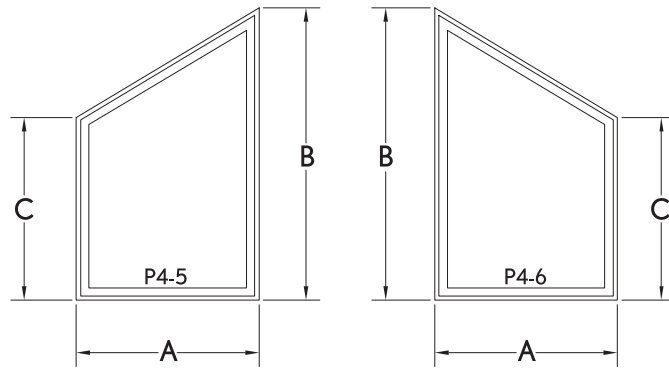

TRAPEZOID

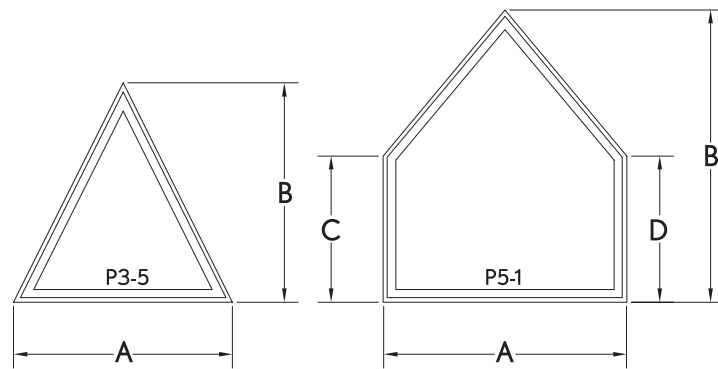

ISOSCELES TRIANGLE

PENTAGON

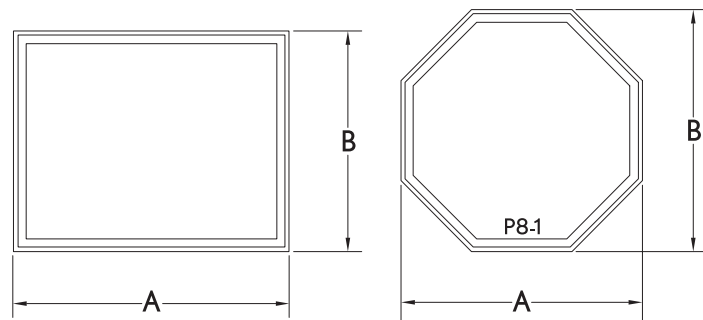

90° RECTANGLE

OCTAGON

How to Specify

When ordering a Trapezoid, Triangle, or Rectangle window, provide a sketch of the unit as viewed from the exterior, also include key Rough Opening dimensions.

Example: To order a window of a Trapezoid opening provide the measurements of A, B, and C as indicated. For other shapes, give the dimensions shown.

SPECIFICATION NOTES:

All units are subject to validation.

Maximum/Minimum Guidelines

Maximum Square Footage: 49 sq. ft. of Rough Opening

Maximum Width: 114" Rough Opening

Maximum Height: 114" Rough Opening

Minimum (RECT, P3, P4, P5): 12" x 12" Rough Opening

Minimum (P8): 18" x 18" Rough Opening

Minimum Short Leg (P4, P5): 8" Rough Opening

P3 Pitch: 3/12 to 36/12 Pitch Available

P4 Pitch: 36/12 Maximum Pitch Available

P5 Pitch: 36/12 Maximum Pitch Available

MULTIPLE ASSEMBLIES

Multiple assemblies can be factory mullied.

MAXIMUM ROUGH OPENING: not to exceed 114" x 78".

Maximum up to 6 units wide by 1 unit high.

MAXIMUM ROUGH OPENING: not to exceed 96" x 96".

Maximum up to 5 units wide by 5 units high.

NOTE: Units with Rough Opening larger than 37.75 sq. ft. will be standard tempered.

Construction Details

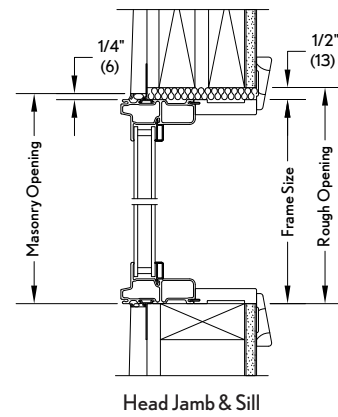

Head Jamb & Sill

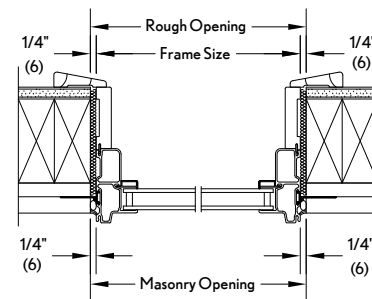

Jambs

2 Panel Sliding Patio Door

MO (mm)	5' - 0" (1524)	5' - 0" (1524)	5' - 10 1/2" (1791)	5' - 10 1/2" (1791)	6' - 0" (1829)	6' - 0" (1829)
RO (mm)	5' - 0" (1524)	5' - 0" (1524)	5' - 10 1/2" (1791)	5' - 10 1/2" (1791)	6' - 0" (1829)	6' - 0" (1829)
FS (mm)	4' - 11 1/2" (1511)	4' - 11 1/2" (1511)	5' - 10" (1778)	5' - 10" (1778)	5' - 11 1/2" (1816)	5' - 11 1/2" (1816)
DLO (mm)	26 1/4" (667)	26 1/4" (667)	31 1/4" (794)	31 1/4" (794)	32 1/4" (819)	32 1/4" (819)

6' - 7 3/4" (2026)						
6' - 8" (2032)						
6' - 7 1/2" (2019)						
73 3/4" (1873)						
6' - 9 3/4" (2076)						
6' - 10" (2083)						
6' - 9 1/2" (2070)						
75 3/4" (1924)						
7' - 11 3/4" (2432)						
8' - 0" (2438)						
7' - 11 1/2" (2426)						
89 3/4" (2280)						

Multiple Assemblies

Multiple assembly units can be factory mullied up to 1 unit wide by 2 units high.

MAXIMUM ROUGH OPENING: not to exceed 72" x 100 1/2". Field mull kits available for up to 3 units wide by 2 units high not to exceed 110" x 112". Structural mullion reinforcement is required for some assemblies.

Please consult your local Integrity representative for more information.

GBG available in standard Rectangular lite cut, shown above. Other GBG lite cuts shown on page 35. (Not available on In-Sash Transom units.)

Details and Elevations not to scale.

Special sized units available within two panel product size matrix. See your Integrity retailer.

See page 87 for specific PG Ratings.

SLIDING PATIO DOOR

3 Panel Sliding Patio Door

MO (mm)	9' - 0" (2743)	9' - 0" (2743)	9' - 0" (2743)	9' - 0" (2743)
RO (mm)	9' - 0" (2743)	9' - 0" (2743)	9' - 0" (2743)	9' - 0" (2743)
FS (mm)	8' - 11 1/2" (2731)	8' - 11 1/2" (2731)	8' - 11 1/2" (2731)	8' - 11 1/2" (2731)
DLO (mm)	32 1/4" (819)	32 1/4" (819)	32 1/4" (819)	32 1/4" (819)

<p>6' - 7 3/4" (2026) 6' - 8" (2032) 6' - 7 1/2" (2019) 73 3/4" (1873)</p>	 IFSPD9068 - XOO	 IFSPD9068 - OOX	 IFSPD9068 - OXORH	 IFSPD9068 - OXOLH
<p>6' - 9 3/4" (2076) 6' - 10" (2083) 6' - 9 1/2" (2070) 75 3/4" (1924)</p>	 IFSPD90610 - XOO	 IFSPD90610 - OOX	 IFSPD90610 - OXORH	 IFSPD90610 - OXOLH
<p>7' - 11 3/4" (2432) 8' - 0" (2436) 7' - 11 1/2" (2426) 89 3/4" (2280)</p>	 IFSPD9080 - XOO	 IFSPD9080 - OOX	 IFSPD9080 - OXORH	 IFSPD9080 - OXOLH

Direct Glaze Transom Over Sliding Patio Door

M.O. (mm)	6' - 0" (1829)
R.O. (mm)	6' - 0" (1829)
F.S. (mm)	5' - 11 1/2" (1816)

<p>8' - 3 3/4" (2534) 8' - 4" (2540) 8' - 3 1/2" (2527)</p>	 IFSPDDG6016/IFSPD60610
---	----------------------------

Sliding Patio Door Direct Glaze Transom

M.O. (mm)	5' - 0" (1524)	5' - 10 1/2" (1791)	6' - 0" (1829)	9' - 0" (2743)
R.O. (mm)	5' - 0" (1524)	5' - 10 1/2" (1791)	6' - 0" (1829)	9' - 0" (2743)
F.S. (mm)	4' - 11 1/2" (1511)	5' - 10" (1778)	5' - 11 1/2" (1816)	8' - 11 1/2" (2731)
D.L.O. (mm)	57 1/4" (1454)	67 1/4" (1708)	69 1/4" (1759)	105 1/4" (2673)

<p>0' - 11 3/4" (298) 1' - 0" (305) 0' - 11 1/2" (292) 9 1/4" (235)</p>	 IFSPDDG5010	 IFSPDDG51010	 IFSPDDG6010	 IFSPDDG9010
<p>1' - 5 3/4" (451) 1' - 6" (457) 1' - 5 1/2" (445) 15 1/4" (387)</p>	 IFSPDDG5016	 IFSPDDG51016	 IFSPDDG6016	 IFSPDDG9016

SLIDING PATIO DOOR

Construction Details

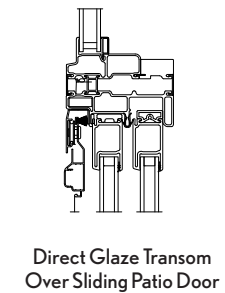
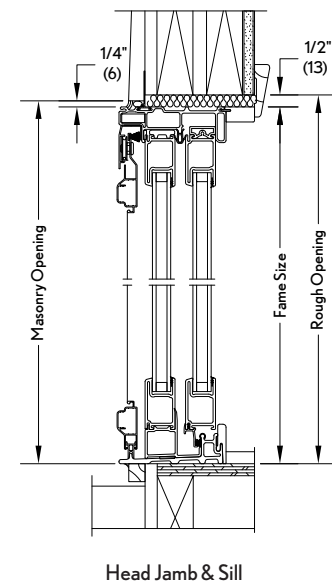
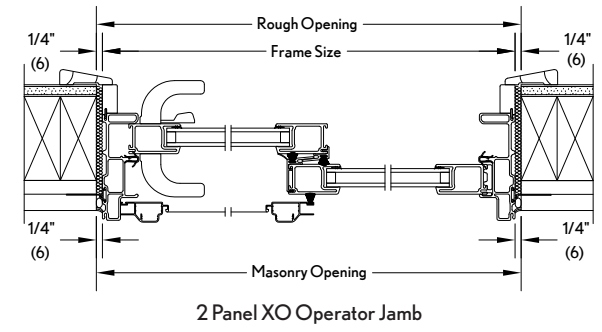
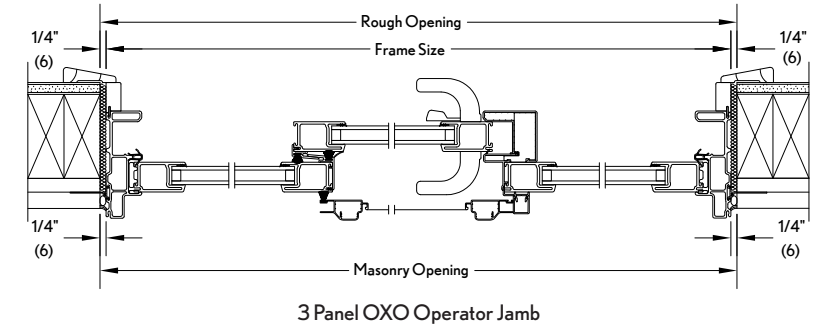

GBG available in standard Rectangular lite cut, shown above. Other GBG lite cuts shown on page 35. (Not available on In-Sash Transom units.)
Details and Elevations not to scale.
Special sized units available within product size matrix. See your Integrity retailer.
See page 87 for specific PG Ratings.
XO operation shown, OX operation optional.

Multiple Assemblies
Multiple assembly units can be factory mulled up to 1 unit wide by 2 units high.
MAXIMUM ROUGH OPENING: not to exceed 72" x 100 1/2". Field mull kits available for up to 3 units wide by 2 units high not to exceed 110" x 112". Structural mullion reinforcement is required for some assemblies.
Please consult your local Integrity representative for more information.

EGRESS OPENINGS

Integrity® All Ultrex® Standard Casement Operator

EGRESS OPENING													
Unit #	Egress Width		Egress Height		Egress Clear Opening		Floor To Clear Opening*		Vent		DLO		
	Inches	(mm)	Inches	(mm)	Sq. Ft.	(cm ²)	Sq. Ft.	(cm ²)	Sq. Ft.	(cm ²)	Sq. Ft.	(cm ²)	
1620	8 43/64	(220)	18 5/16	(465)	1.10	(1025)	60 41/64	(1540)	1.10	(1025)	1.46	(1359)	
1626	8 43/64	(220)	24 5/16	(618)	1.46	(1360)	54 41/64	(1388)	1.46	(1360)	1.96	(1817)	
1630	8 43/64	(220)	30 5/16	(770)	1.83	(1696)	48 41/64	(1236)	1.83	(1696)	2.45	(2275)	
1636	8 43/64	(220)	36 5/16	(923)	2.19	(2032)	42 41/64	(1083)	2.19	(2032)	2.94	(2732)	
1640	8 43/64	(220)	42 5/16	(1075)	2.55	(2367)	36 41/64	(931)	2.55	(2367)	3.43	(3190)	
1646	8 43/64	(220)	48 5/16	(1227)	2.91	(2703)	30 41/64	(778)	2.91	(2703)	3.93	(3647)	
1650	8 43/64	(220)	54 5/16	(1380)	3.27	(3038)	24 41/64	(626)	3.27	(3038)	4.42	(4105)	
1656	8 43/64	(220)	60 5/16	(1532)	3.63	(3374)	18 41/64	(474)	3.63	(3374)	4.91	(4563)	
1660	8 43/64	(220)	66 5/16	(1685)	3.99	(3710)	12 41/64	(321)	3.99	(3710)	5.40	(5020)	
2020	14 43/64	(373)	18 5/16	(465)	1.87	(1734)	60 41/64	(1540)	1.87	(1734)	2.21	(2049)	
2026	14 43/64	(373)	24 5/16	(618)	2.48	(2302)	54 41/64	(1388)	2.48	(2302)	2.95	(2739)	
2030	14 43/64	(373)	30 5/16	(770)	3.09	(2870)	48 41/64	(1236)	3.09	(2870)	3.69	(3429)	
2036	14 43/64	(373)	36 5/16	(923)	3.70	(3438)	42 41/64	(1083)	3.70	(3438)	4.43	(4119)	
2040	14 43/64	(373)	42 5/16	(1075)	4.31	(4005)	36 41/64	(931)	4.31	(4005)	5.18	(4809)	
2046	14 43/64	(373)	48 5/16	(1227)	4.92	(4573)	30 41/64	(778)	4.92	(4573)	5.92	(5499)	
2050	14 43/64	(373)	54 5/16	(1380)	5.53	(5141)	24 41/64	(626)	5.53	(5141)	6.66	(6188)	
2056	14 43/64	(373)	60 5/16	(1532)	6.15	(5709)	18 41/64	(474)	6.15	(5709)	7.40	(6878)	
2060	14 43/64	(373)	66 5/16	(1685)	6.76	(6277)	12 41/64	(321)	6.76	(6277)	8.15	(7568)	
2620	**	20 43/64	(525)	18 5/16	(465)	2.63	(2443)	60 41/64	(1540)	2.63	(2443)	2.95	(2739)
2626	**	20 43/64	(525)	24 5/16	(618)	3.49	(3243)	54 41/64	(1388)	3.49	(3243)	3.94	(3661)
2630	**	20 43/64	(525)	30 5/16	(770)	4.35	(4043)	48 41/64	(1236)	4.35	(4043)	4.93	(4583)
2636	**	20 43/64	(525)	36 5/16	(923)	5.21	(4843)	42 41/64	(1083)	5.21	(4843)	5.93	(5505)
2640	E **	20 43/64	(525)	42 5/16	(1075)	6.07	(5644)	36 41/64	(931)	6.07	(5644)	6.92	(6428)
2646	E **	20 43/64	(525)	48 5/16	(1227)	6.94	(6444)	30 41/64	(778)	6.94	(6444)	7.91	(7350)
2650	E **	20 43/64	(525)	54 5/16	(1380)	7.80	(7244)	24 41/64	(626)	7.80	(7244)	8.90	(8272)
2656	E **	20 43/64	(525)	60 5/16	(1532)	8.66	(8044)	18 41/64	(474)	8.66	(8044)	9.90	(9194)
2660	E **	20 43/64	(525)	66 5/16	(1685)	9.52	(8844)	12 41/64	(321)	9.52	(8844)	10.89	(10116)
3020	**	26 43/64	(677)	18 5/16	(465)	3.39	(3152)	60 41/64	(1540)	3.39	(3152)	3.69	(3429)
3026	**	26 43/64	(677)	24 5/16	(618)	4.50	(4185)	54 41/64	(1388)	4.50	(4185)	4.93	(4583)
3030	**	26 43/64	(677)	30 5/16	(770)	5.62	(5217)	48 41/64	(1236)	5.62	(5217)	6.18	(5738)
3036	E **	26 43/64	(677)	36 5/16	(923)	6.73	(6249)	42 41/64	(1083)	6.73	(6249)	7.42	(6892)
3040	E **	26 43/64	(677)	42 5/16	(1075)	7.84	(7282)	36 41/64	(931)	7.84	(7282)	8.66	(8047)
3046	E **	26 43/64	(677)	48 5/16	(1227)	8.95	(8314)	30 41/64	(778)	8.95	(8314)	9.90	(9201)
3050	E **	26 43/64	(677)	54 5/16	(1380)	10.06	(9347)	24 41/64	(626)	10.06	(9347)	11.15	(10355)
3056	E **	26 43/64	(677)	60 5/16	(1532)	11.17	(10379)	18 41/64	(474)	11.17	(10379)	12.39	(11510)
3060	E **	26 43/64	(677)	66 5/16	(1685)	12.28	(11411)	12 41/64	(321)	12.28	(11411)	13.63	(12664)

Integrity All Ultrex Standard Awning Operator

VENT OPENING				
Unit #	Vent		DLO	
	Sq. Ft.	(cm ²)	Sq. Ft.	(cm ²)
1616	0.74	(689)	0.97	(902)
1620	1.10	(1025)	1.46	(1359)
1626	1.46	(1361)	1.96	(1817)
1630	1.83	(1696)	2.45	(2275)
2016	1.25	(1166)	1.46	(1359)
2020	1.87	(1734)	2.21	(2049)
2026	2.48	(2302)	2.95	(2739)
2030	3.09	(2870)	3.69	(3429)
2616	1.77	(1643)	1.96	(1817)
2620	2.63	(2443)	2.95	(2739)
2626	3.49	(3243)	3.94	(3661)
2630	4.35	(4043)	4.93	(4583)
3016	2.28	(2119)	2.45	(2275)
3020	3.39	(3152)	3.69	(3429)
3026	4.50	(4184)	4.93	(4583)
3030	5.62	(5217)	6.18	(5738)
3616	2.79	(2596)	2.94	(2732)
3620	4.16	(3861)	4.43	(4119)
3626	5.52	(5126)	5.93	(5505)
3630	6.88	(6390)	7.42	(6892)
4016	3.31	(3073)	3.43	(3190)
4020	4.92	(4570)	5.18	(4809)
4026	6.53	(6067)	6.92	(6428)
4030	8.14	(7564)	8.66	(8047)

E These units meet National Egress Codes requiring 5.7 SF clear opening, 20" clear width, and 24" clear height, not to exceed a floor to sill height of 44". Code restrictions may vary depending on local building codes.

* Floor to clear opening is calculated using 6'-10 1/4" from finished floor to rough opening header.

** These units may optionally include a window opening control device tested to ASTM F2090-10, which can be released from the inside without the use of a key, tool, special knowledge, or force greater than that required for normal unit operation.

EGRESS OPENINGS

Integrity All Ultrex Single Hung Equal Sash

EGRESS OPENING													
Unit #	Egress Width		Egress Height		Egress Clear Opening		Floor To Clear Opening*		Vent		DLO		
	Inches	(mm)	Inches	(mm)	Sq. Ft.	(cm ²)	Sq. Ft.	(cm ²)	Sq. Ft.	(cm ²)	Sq. Ft.	(cm ²)	
1620	14 9/16	(370)	7 13/64	(183)	0.73	(677)	60 41/64	(1540)	0.73	(677)	1.45	(1347)	
1626	14 9/16	(370)	10 13/64	(259)	1.03	(959)	54 41/64	(1388)	1.03	(959)	1.97	(1833)	
1630	14 9/16	(370)	13 13/64	(336)	1.34	(1241)	48 41/64	(1236)	1.34	(1241)	2.50	(2319)	
1636	14 9/16	(370)	16 13/64	(412)	1.64	(1523)	42 41/64	(1083)	1.64	(1523)	3.02	(2805)	
1640	14 9/16	(370)	19 13/64	(488)	1.94	(1804)	36 41/64	(931)	1.94	(1804)	3.54	(3292)	
1646	14 9/16	(370)	22 13/64	(564)	2.25	(2086)	30 41/64	(778)	2.25	(2086)	4.07	(3778)	
1650	14 9/16	(370)	25 13/64	(640)	2.55	(2368)	24 41/64	(626)	2.55	(2368)	4.59	(4264)	
1656	14 9/16	(370)	28 13/64	(717)	2.85	(2650)	18 41/64	(474)	2.85	(2650)	5.11	(4750)	
1660	14 9/16	(370)	31 13/64	(793)	3.16	(2932)	12 41/64	(321)	3.16	(2932)	5.64	(5236)	
1666	14 9/16	(370)	34 13/64	(869)	3.46	(3214)	6 41/64	(169)	3.46	(3214)	6.16	(5722)	
2020	20 9/16	(522)	7 13/64	(183)	1.03	(956)	60 41/64	(1540)	1.03	(956)	2.14	(1990)	
2026	20 9/16	(522)	10 13/64	(259)	1.46	(1354)	54 41/64	(1388)	1.46	(1354)	2.92	(2709)	
2030	20 9/16	(522)	13 13/64	(336)	1.89	(1752)	48 41/64	(1236)	1.89	(1752)	3.69	(3427)	
2036	20 9/16	(522)	16 13/64	(412)	2.31	(2150)	42 41/64	(1083)	2.31	(2150)	4.46	(4145)	
2040	20 9/16	(522)	19 13/64	(488)	2.74	(2548)	36 41/64	(931)	2.74	(2548)	5.24	(4864)	
2046	20 9/16	(522)	22 13/64	(564)	3.17	(2946)	30 41/64	(778)	3.17	(2946)	6.01	(5582)	
2050	20 9/16	(522)	25 13/64	(640)	3.60	(3344)	24 41/64	(626)	3.60	(3344)	6.78	(6301)	
2056	20 9/16	(522)	28 13/64	(717)	4.03	(3742)	18 41/64	(474)	4.03	(3742)	7.56	(7019)	
2060	20 9/16	(522)	31 13/64	(793)	4.46	(4140)	12 41/64	(321)	4.46	(4140)	8.33	(7738)	
2066	20 9/16	(522)	34 13/64	(869)	4.88	(4538)	6 41/64	(169)	4.88	(4538)	9.10	(8456)	
2620	26 9/16	(675)	7 13/64	(183)	1.33	(1235)	60 41/64	(1540)	1.33	(1235)	2.83	(2633)	
2626	26 9/16	(675)	10 13/64	(259)	1.88	(1750)	54 41/64	(1388)	1.88	(1750)	3.86	(3584)	
2630	26 9/16	(675)	13 13/64	(336)	2.44	(2264)	48 41/64	(1236)	2.44	(2264)	4.88	(4535)	
2636	26 9/16	(675)	16 13/64	(412)	2.99	(2778)	42 41/64	(1083)	2.99	(2778)	5.90	(5486)	
2640	26 9/16	(675)	19 13/64	(488)	3.54	(3292)	36 41/64	(931)	3.54	(3292)	6.93	(6436)	
2646	26 9/16	(675)	22 13/64	(564)	4.10	(3806)	30 41/64	(778)	4.10	(3806)	7.95	(7387)	
2650	26 9/16	(675)	25 13/64	(640)	4.65	(4320)	24 41/64	(626)	4.65	(4320)	8.97	(8338)	
2656	26 9/16	(675)	28 13/64	(717)	5.20	(4834)	18 41/64	(474)	5.20	(4834)	10.00	(9288)	
2660	E	26 9/16	(675)	31 13/64	(793)	5.76	(5348)	12 41/64	(321)	5.76	(5348)	11.02	(10239)
2666	E	26 9/16	(675)	34 13/64	(869)	6.31	(5862)	6 41/64	(169)	6.31	(5862)	12.04	(11190)
2820	E	28 9/16	(725)	7 13/64	(183)	1.43	(1328)	60 41/64	(1540)	1.43	(1328)	3.07	(2848)
2826	E	28 9/16	(725)	10 13/64	(259)	2.02	(1881)	54 41/64	(1388)	2.02	(1881)	4.17	(3876)
2830	E	28 9/16	(725)	13 13/64	(336)	2.62	(2434)	48 41/64	(1236)	2.62	(2434)	5.28	(4904)
2836	E	28 9/16	(725)	16 13/64	(412)	3.21	(2987)	42 41/64	(1083)	3.21	(2987)	6.39	(5932)
2840	E	28 9/16	(725)	19 13/64	(488)	3.81	(3540)	36 41/64	(931)	3.81	(3540)	7.49	(6960)
2846	E	28 9/16	(725)	22 13/64	(564)	4.40	(4092)	30 41/64	(778)	4.40	(4092)	8.60	(7989)
2850	E	28 9/16	(725)	25 13/64	(640)	5.00	(4645)	24 41/64	(626)	5.00	(4645)	9.71	(9017)
2856	E	28 9/16	(725)	28 13/64	(717)	5.59	(5198)	18 41/64	(474)	5.59	(5198)	10.81	(10045)
2860	E	28 9/16	(725)	31 13/64	(793)	6.							

EGRESS OPENINGS

Integrity® All Ultrex® Single Hung Cottage

EGRESS OPENING														
Unit #	Egress Width		Egress Height		Egress Clear Opening		Floor To Clear Opening*		Vent		DLO		Check Rail Height	
	Inches	(mm)	Inches	(mm)	Sq. Ft.	(cm ²)	Inches	(mm)	Sq. Ft.	(cm ²)	Sq. Ft.	(cm ²)	Inches	(mm)
1626	14 9/16	(370)	7 23/32	(196)	0.78	(725)	54 41/64	(1388)	0.78	(725)	2.41	(2235)	17 11/16	(449)
1630	14 9/16	(370)	10 1/8	(257)	1.02	(951)	48 41/64	(1236)	1.02	(951)	3.03	(2818)	21 9/32	(541)
1636	14 9/16	(370)	12 33/64	(318)	1.27	(1176)	42 41/64	(1083)	1.27	(1176)	3.66	(3402)	24 7/8	(632)
1640	14 9/16	(370)	14 59/64	(379)	1.51	(1402)	36 41/64	(931)	1.51	(1402)	4.29	(3985)	28 31/64	(723)
1646	14 9/16	(370)	17 5/16	(440)	1.75	(1627)	30 41/64	(778)	1.75	(1627)	4.92	(4569)	32 5/64	(815)
1650	14 9/16	(370)	19 23/32	(501)	1.99	(1852)	24 41/64	(626)	1.99	(1852)	5.55	(5152)	35 11/16	(906)
1656	14 9/16	(370)	22 13/64	(564)	2.25	(2086)	18 41/64	(474)	2.25	(2086)	6.16	(5722)	39 3/16	(995)
1660	14 9/16	(370)	24 33/64	(623)	2.48	(2304)	12 41/64	(321)	2.48	(2304)	6.80	(6320)	42 7/8	(1089)
1666	14 9/16	(370)	26 59/64	(684)	2.72	(2529)	6 41/64	(169)	2.72	(2529)	7.43	(6903)	46 31/64	(1181)
2026	20 9/16	(522)	7 23/32	(196)	1.10	(1024)	54 41/64	(1388)	1.10	(1024)	3.55	(3302)	17 11/16	(449)
2030	20 9/16	(522)	10 1/8	(257)	1.44	(1342)	48 41/64	(1236)	1.44	(1342)	4.48	(4165)	21 9/32	(541)
2036	20 9/16	(522)	12 33/64	(318)	1.79	(1661)	42 41/64	(1083)	1.79	(1661)	5.41	(5027)	24 7/8	(632)
2040	20 9/16	(522)	14 59/64	(379)	2.13	(1979)	36 41/64	(931)	2.13	(1979)	6.34	(5889)	28 31/64	(723)
2046	20 9/16	(522)	17 5/16	(440)	2.47	(2297)	30 41/64	(778)	2.47	(2297)	7.27	(6751)	32 5/64	(815)
2050	20 9/16	(522)	19 23/32	(501)	2.82	(2616)	24 41/64	(626)	2.82	(2616)	8.19	(7613)	35 11/16	(906)
2056	20 9/16	(522)	22 13/64	(564)	3.17	(2946)	18 41/64	(474)	3.17	(2946)	9.10	(8456)	39 3/16	(995)
2060	20 9/16	(522)	24 33/64	(623)	3.50	(3253)	12 41/64	(321)	3.50	(3253)	10.05	(9338)	42 7/8	(1089)
2066	20 9/16	(522)	26 59/64	(684)	3.84	(3571)	6 41/64	(169)	3.84	(3571)	10.98	(10201)	46 31/64	(1181)
2626	26 9/16	(675)	7 23/32	(196)	1.42	(1323)	54 41/64	(1388)	1.42	(1323)	4.70	(4370)	17 11/16	(449)
2630	26 9/16	(675)	10 1/8	(257)	1.87	(1734)	48 41/64	(1236)	1.87	(1734)	5.93	(5511)	21 9/32	(541)
2636	26 9/16	(675)	12 33/64	(318)	2.31	(2145)	42 41/64	(1083)	2.31	(2145)	7.16	(6652)	24 7/8	(632)
2640	26 9/16	(675)	14 59/64	(379)	2.75	(2557)	36 41/64	(931)	2.75	(2557)	8.39	(7793)	28 31/64	(723)
2646	26 9/16	(675)	17 5/16	(440)	3.19	(2968)	30 41/64	(778)	3.19	(2968)	9.62	(8933)	32 5/64	(815)
2650	26 9/16	(675)	19 23/32	(501)	3.64	(3379)	24 41/64	(626)	3.64	(3379)	10.84	(10074)	35 11/16	(906)
2656	26 9/16	(675)	22 13/64	(564)	4.10	(3806)	18 41/64	(474)	4.10	(3806)	12.04	(11190)	39 3/16	(995)
2660	26 9/16	(675)	24 33/64	(623)	4.52	(4202)	12 41/64	(321)	4.52	(4202)	13.30	(12357)	42 7/8	(1089)
2666	26 9/16	(675)	26 59/64	(684)	4.97	(4613)	6 41/64	(169)	4.97	(4613)	14.53	(13498)	46 31/64	(1181)
2826	28 9/16	(725)	7 23/32	(196)	1.53	(1422)	54 41/64	(1388)	1.53	(1422)	5.09	(4726)	17 11/16	(449)
2830	28 9/16	(725)	10 1/8	(257)	2.01	(1865)	48 41/64	(1236)	2.01	(1865)	6.41	(5960)	21 9/32	(541)
2836	28 9/16	(725)	12 33/64	(318)	2.48	(2307)	42 41/64	(1083)	2.48	(2307)	7.74	(7193)	24 7/8	(632)
2840	28 9/16	(725)	14 59/64	(379)	2.96	(2749)	36 41/64	(931)	2.96	(2749)	9.07	(8427)	28 31/64	(723)
2846	28 9/16	(725)	17 5/16	(440)	3.44	(3191)	30 41/64	(778)	3.44	(3191)	10.40	(9661)	32 5/64	(815)
2850	28 9/16	(725)	19 23/32	(501)	3.91	(3634)	24 41/64	(626)	3.91	(3634)	11.73	(10895)	35 11/16	(906)
2856	28 9/16	(725)	22 13/64	(564)	4.40	(4092)	18 41/64	(474)	4.40	(4092)	13.03	(12101)	39 3/16	(995)
2860	28 9/16	(725)	24 33/64	(623)	4.86	(4519)	12 41/64	(321)	4.86	(4519)	14.38	(13364)	42 7/8	(1089)
2866	28 9/16	(725)	26 59/64	(684)	5.34	(4961)	6 41/64	(169)	5.34	(4961)	15.71	(14597)	46 31/64	(1181)
3026	32 9/16	(827)	7 23/32	(196)	1.75	(1622)	54 41/64	(1388)	1.75	(1622)	5.85	(5438)	17 11/16	(449)
3030	32 9/16	(827)	10 1/8	(257)	2.29	(2126)	48 41/64	(1236)	2.29	(2126)	7.38	(6857)	21 9/32	(541)
3036	32 9/16	(827)	12 33/64	(318)	2.83	(2630)	42 41/64	(1083)	2.83	(2630)	8.91	(8277)	24 7/8	(632)
3040	32 9/16	(827)	14 59/64	(379)	3.37	(3134)	36 41/64	(931)	3.37	(3134)	10.44	(9696)	28 31/64	(723)
3046	32 9/16	(827)	17 5/16	(440)	3.92	(3638)	30 41/64	(778)	3.92	(3638)	11.97	(11116)	32 5/64	(815)
3050	32 9/16	(827)	19 23/32	(501)	4.46	(4142)	24 41/64	(626)	4.46	(4142)	13.49	(12535)	35 11/16	(906)
3056	32 9/16	(827)	22 13/64	(564)	5.02	(4666)	18 41/64	(474)	5.02	(4666)	14.99	(13924)	39 3/16	(995)
3060	32 9/16	(827)	24 33/64	(623)	5.54	(5151)	12 41/64	(321)	5.54	(5151)	16.55	(15376)	42 7/8	(1089)
3066	E 32 9/16	(827)	26 59/64	(684)	6.09	(5656)	6 41/64	(169)	6.09	(5656)	18.08	(16796)	46 31/64	(1181)
3626	38 9/16	(979)	7 23/32	(196)	2.07	(1921)	54 41/64	(1388)	2.07	(1921)	7.00	(6505)	17 11/16	(449)
3630	38 9/16	(979)	10 1/8	(257)	2.71	(2518)	48 41/64	(1236)	2.71	(2518)	8.83	(8204)	21 9/32	(541)
3636	38 9/16	(979)	12 33/64	(318)	3.35	(3115)	42 41/64	(1083)	3.35	(3115)	10.66	(9902)	24 7/8	(632)
3640	38 9/16	(979)	14 59/64	(379)	4.00	(3712)	36 41/64	(931)	4.00	(3712)	12.49	(11600)	28 31/64	(723)
3646	38 9/16	(979)	17 5/16	(440)	4.64	(4309)	30 41/64	(778)	4.64	(4309)	14.31	(13298)	32 5/64	(815)
3650	38 9/16	(979)	19 23/32	(501)	5.28	(4906)	24 41/64	(626)	5.28	(4906)	16.14	(14997)	35 11/16	(906)
3656	38 9/16	(979)	22 13/64	(564)	5.95	(5525)	18 41/64	(474)	5.95	(5525)	17.93	(16657)	39 3/16	(995)
3660	E 38 9/16	(979)	24 33/64	(623)	6.57	(6101)	12 41/64	(321)	6.57	(6101)	19.80	(18395)	42 7/8	(1089)
3666	E 38 9/16	(979)	26 59/64	(684)	7.21	(6698)	6 41/64	(169)	7.21	(6698)	21.63	(20093)	46 31/64	(1181)
4026	44 9/16	(1132)	7 23/32	(196)	2.39	(2219)	54 41/64	(1388)	2.39	(2219)	8.15	(7573)	17 11/16	(449)
4030	44 9/16	(1132)	10 1/8	(257)	3.13	(2909)	48 41/64	(1236)	3.13	(2909)	10.28	(9550)	21 9/32	(541)
4036	44 9/16	(1132)	12 33/64	(318)	3.87	(3599)	42 41/64	(1083)	3.87	(3599)	12.41	(11527)	24 7/8	(632)
4040	44 9/16	(1132)	14 59/64	(379)	4.62	(4289)	36 41/64	(931)	4.62	(4289)	14.54	(13504)	28 31/64	(723)
4046	44 9/16	(1132)	17 5/16	(440)	5.36	(4979)	30 41/64	(778)	5.36	(4979)	16.66	(15481)	32 5/64	(815)
4050	44 9/16	(1132)	19 23/32	(501)	6.10	(5669)	24 41/64	(626)	6.10	(5669)	18.79	(17458)	35 11/16	(906)
4056	44 9/16	(1132)	22 13/64	(564)	6.87	(6385)	18 41/64	(474)	6.87	(6385)	20.87	(19391)	39 3/16	(995)
4060	E 44 9/16	(1132)	24 33/64	(623)	7.59	(7050)	12 41/64	(321)	7.59	(7050)	23.05	(21414)	42 7/8	(1089)
4066	E 44 9/16	(1132)	26 59/64	(684)	8.33	(7740)	6 41/64	(169)	8.33	(7740)	25.18	(23391)	46 31/64	(1181)

E These units meet National Egress Codes requiring 5.7 SF clear opening, 20" clear width, and 24" clear height, not to exceed a floor to sill height of 44". Code restrictions may vary depending on local building codes.

* Floor to clear opening is calculated using 6'-10 1/4" from finished floor to rough opening header.

Units may optionally include a window opening control device tested to ASTM F2090-10, which can be released from the inside without the use of a key, tool, special knowledge, or force greater than that required for normal unit operation.

EGRESS OPENINGS

Integrity All Ultrex Single Hung Reverse Cottage

EGRESS OPENING														
Unit #	Egress Width		Egress Height		Egress Clear Opening		Floor To Clear Opening*		Vent		DLO		Check Rail Height	
	Inches	(mm)	Inches	(mm)	Sq. Ft.	(cm ²)	Inches	(mm)	Sq. Ft.	(cm ²)	Sq. Ft.	(cm ²)	Inches	(mm)
1626	14 9/16	(370)	7 23/32	(196)	0.78	(725)	54 41/64	(1388)	0.78	(725)	1.54	(1431)	12 45/64	(323)
1630	14 9/16	(370)	10 1/8	(257)	1.02	(951)	48 41/64	(1236)	1.02	(951)	1.96	(1820)	15 7/64	(384)
1636	14 9/16	(370)	12 33/64	(318)	1.27	(1176)	42 41/64	(1083)	1.27	(1176)	2.38	(2209)	17 33/64	(445)
1640	14 9/16	(370)	14 59/64	(379)	1.51	(1402)	36 41/64	(931)	1.51	(1402)	2.80	(2598)	19 29/32	(506)
1646	14 9/16	(370)	17 5/16	(440)	1.75	(1627)	30 41/64	(778)	1.75	(1627)	3.22	(2987)	22 5/16	(567)
1650	14 9/16	(370)	19 23/32	(501)	1.99	(1852)	24 41/64	(626)	1.99	(1852)	3.63	(3376)	24 45/64	(628)
1656	14 9/16	(370)	22 13/64	(564)	2.25	(2086)	18 41/64	(474)	2.25	(2086)	4.07	(3778)	27 3/16	(691)
1660	14 9/16	(370)	24 33/64	(623)	2.48	(2304)	12 41/64	(321)	2.48	(2304)	4.47	(4153)	29 33/64	(750)
1666	14 9/16	(370)	26 59/64	(684)	2.72	(2529)	6 41/64	(169)	2.72	(2529)	4.89	(4542)	31 29/32	(810)
2026	20 9/16	(522)	7 23/32	(196)	1.10	(1024)	54 41/64	(1388)	1.10	(1024)	2.28	(2115)	12 45/64	(323)
2030	20 9/16	(522)	10 1/8	(257)	1.44	(1342)	48 41/64	(1236)	1.44	(1342)	2.89	(2689)	15 7/64	(384)
2036	20 9/16	(522)	12 33/64	(318)	1.79	(1661)	42 41/64	(1083)	1.79	(1661)	3.51	(3264)	17 33/64</	

EGRESS OPENINGS

Integrity® All Ultrex® Double Hung Equal Sash

EGRESS OPENING													
Unit #	Egress Width		Egress Height		Egress Clear Opening		Floor To Clear Opening*		Vent		DLO		Check Rail Height
	Inches	(mm)	Inches	(mm)	Sq. Ft.	(cm ²)	Sq. Ft.	(cm ²)	Sq. Ft.	(cm ²)	Sq. Ft.	(cm ²)	
1620	14 9/16	(370)	7 13/64	(183)	0.73	(677)	60 41/64	(1540)	0.73	(677)	1.45	(1347)	
1626	14 9/16	(370)	10 13/64	(259)	1.03	(959)	54 41/64	(1388)	1.03	(959)	1.97	(1833)	
1630	14 9/16	(370)	13 13/64	(336)	1.34	(1241)	48 41/64	(1236)	1.34	(1241)	2.50	(2319)	
1636	14 9/16	(370)	16 13/64	(412)	1.64	(1523)	42 41/64	(1083)	1.64	(1523)	3.02	(2805)	
1640	14 9/16	(370)	19 13/64	(488)	1.94	(1804)	36 41/64	(931)	1.94	(1804)	3.54	(3292)	
1646	14 9/16	(370)	22 13/64	(564)	2.25	(2086)	30 41/64	(778)	2.25	(2086)	4.07	(3778)	
1650	14 9/16	(370)	25 13/64	(640)	2.55	(2368)	24 41/64	(626)	2.55	(2368)	4.59	(4264)	
1656	14 9/16	(370)	28 13/64	(717)	2.85	(2650)	18 41/64	(474)	2.85	(2650)	5.11	(4750)	
1660	14 9/16	(370)	31 13/64	(793)	3.16	(2932)	12 41/64	(321)	3.16	(2932)	5.64	(5236)	
1666	14 9/16	(370)	34 13/64	(869)	3.46	(3214)	6 41/64	(169)	3.46	(3214)	6.16	(5722)	
2020	20 9/16	(522)	7 13/64	(183)	1.03	(956)	60 41/64	(1540)	1.03	(956)	2.14	(1990)	
2026	20 9/16	(522)	10 13/64	(259)	1.46	(1354)	54 41/64	(1388)	1.46	(1354)	2.92	(2709)	
2030	20 9/16	(522)	13 13/64	(336)	1.89	(1752)	48 41/64	(1236)	1.89	(1752)	3.69	(3427)	
2036	20 9/16	(522)	16 13/64	(412)	2.31	(2150)	42 41/64	(1083)	2.31	(2150)	4.46	(4145)	
2040	20 9/16	(522)	19 13/64	(488)	2.74	(2548)	36 41/64	(931)	2.74	(2548)	5.24	(4864)	
2046	20 9/16	(522)	22 13/64	(564)	3.17	(2946)	30 41/64	(778)	3.17	(2946)	6.01	(5582)	
2050	20 9/16	(522)	25 13/64	(640)	3.60	(3344)	24 41/64	(626)	3.60	(3344)	6.78	(6301)	
2056	20 9/16	(522)	28 13/64	(717)	4.03	(3742)	18 41/64	(474)	4.03	(3742)	7.56	(7019)	
2060	20 9/16	(522)	31 13/64	(793)	4.46	(4140)	12 41/64	(321)	4.46	(4140)	8.33	(7738)	
2066	20 9/16	(522)	34 13/64	(869)	4.88	(4538)	6 41/64	(169)	4.88	(4538)	9.10	(8456)	
2620	26 9/16	(675)	7 13/64	(183)	1.33	(1235)	60 41/64	(1540)	1.33	(1235)	2.83	(2633)	
2626	26 9/16	(675)	10 13/64	(259)	1.88	(1750)	54 41/64	(1388)	1.88	(1750)	3.86	(3584)	
2630	26 9/16	(675)	13 13/64	(336)	2.44	(2264)	48 41/64	(1236)	2.44	(2264)	4.88	(4535)	
2636	26 9/16	(675)	16 13/64	(412)	2.99	(2778)	42 41/64	(1083)	2.99	(2778)	5.90	(5486)	
2640	26 9/16	(675)	19 13/64	(488)	3.54	(3292)	36 41/64	(931)	3.54	(3292)	6.93	(6436)	
2646	26 9/16	(675)	22 13/64	(564)	4.10	(3806)	30 41/64	(778)	4.10	(3806)	7.95	(7387)	
2650	26 9/16	(675)	25 13/64	(640)	4.65	(4320)	24 41/64	(626)	4.65	(4320)	8.97	(8338)	
2656	26 9/16	(675)	28 13/64	(717)	5.20	(4834)	18 41/64	(474)	5.20	(4834)	10.00	(9288)	
2660	E 26 9/16	(675)	31 13/64	(793)	5.76	(5348)	12 41/64	(321)	5.76	(5348)	11.02	(10239)	
2666	E 26 9/16	(675)	34 13/64	(869)	6.31	(5862)	6 41/64	(169)	6.31	(5862)	12.04	(11190)	
2820	28 9/16	(725)	7 13/64	(183)	1.43	(1328)	60 41/64	(1540)	1.43	(1328)	3.07	(2848)	
2826	28 9/16	(725)	10 13/64	(259)	2.02	(1881)	54 41/64	(1388)	2.02	(1881)	4.17	(3876)	
2830	28 9/16	(725)	13 13/64	(336)	2.62	(2434)	48 41/64	(1236)	2.62	(2434)	5.28	(4904)	
2836	28 9/16	(725)	16 13/64	(412)	3.21	(2987)	42 41/64	(1083)	3.21	(2987)	6.39	(5932)	
2840	28 9/16	(725)	19 13/64	(488)	3.81	(3540)	36 41/64	(931)	3.81	(3540)	7.49	(6960)	
2846	28 9/16	(725)	22 13/64	(564)	4.40	(4092)	30 41/64	(778)	4.40	(4092)	8.60	(7989)	
2850	28 9/16	(725)	25 13/64	(640)	5.00	(4645)	24 41/64	(626)	5.00	(4645)	9.71	(9017)	
2856	28 9/16	(725)	28 13/64	(717)	5.59	(5198)	18 41/64	(474)	5.59	(5198)	10.81	(10045)	
2860	E 28 9/16	(725)	31 13/64	(793)	6.19	(5751)	12 41/64	(321)	6.19	(5751)	11.92	(11073)	
2866	E 28 9/16	(725)	34 13/64	(869)	6.78	(6303)	6 41/64	(169)	6.78	(6303)	13.03	(12101)	
3020	32 9/16	(827)	7 13/64	(183)	1.63	(1515)	60 41/64	(1540)	1.63	(1515)	3.53	(3277)	
3026	32 9/16	(827)	10 13/64	(259)	2.31	(2145)	54 41/64	(1388)	2.31	(2145)	4.80	(4460)	
3030	32 9/16	(827)	13 13/64	(336)	2.99	(2775)	48 41/64	(1236)	2.99	(2775)	6.07	(5643)	
3036	32 9/16	(827)	16 13/64	(412)	3.67	(3405)	42 41/64	(1083)	3.67	(3405)	7.35	(6826)	
3040	32 9/16	(827)	19 13/64	(488)	4.34	(4035)	36 41/64	(931)	4.34	(4035)	8.62	(8009)	
3046	32 9/16	(827)	22 13/64	(564)	5.02	(4666)	30 41/64	(778)	5.02	(4666)	9.89	(9192)	
3050	E 32 9/16	(827)	25 13/64	(640)	5.70	(5296)	24 41/64	(626)	5.70	(5296)	11.17	(10375)	
3056	E 32 9/16	(827)	28 13/64	(717)	6.38	(5926)	18 41/64	(474)	6.38	(5926)	12.44	(11558)	
3060	E 32 9/16	(827)	31 13/64	(793)	7.06	(6556)	12 41/64	(321)	7.06	(6556)	13.71	(12741)	
3066	E 32 9/16	(827)	34 13/64	(869)	7.74	(7186)	6 41/64	(169)	7.74	(7186)	14.99	(13924)	
3620	38 9/16	(979)	7 13/64	(183)	1.93	(1794)	60 41/64	(1540)	1.93	(1794)	4.22	(3920)	
3626	38 9/16	(979)	10 13/64	(259)	2.73	(2540)	54 41/64	(1388)	2.73	(2540)	5.74	(5335)	
3630	38 9/16	(979)	13 13/64	(336)	3.54	(3286)	48 41/64	(1236)	3.54	(3286)	7.27	(6751)	
3636	38 9/16	(979)	16 13/64	(412)	4.34	(4033)	42 41/64	(1083)	4.34	(4033)	8.79	(8166)	
3640	38 9/16	(979)	19 13/64	(488)	5.14	(4779)	36 41/64	(931)	5.14	(4779)	10.31	(9581)	
3646	38 9/16	(979)	22 13/64	(564)	5.95	(5525)	30 41/64	(778)	5.95	(5525)	11.84	(10996)	
3650	E 38 9/16	(979)	25 13/64	(640)	6.75	(6272)	24 41/64	(626)	6.75	(6272)	13.36	(12412)	
3656	E 38 9/16	(979)	28 13/64	(717)	7.55	(7018)	18 41/64	(474)	7.55	(7018)	14.88	(13827)	
3660	E 38 9/16	(979)	31 13/64	(793)	8.36	(7764)	12 41/64	(321)	8.36	(7764)	16.41	(15242)	
3666	E 38 9/16	(979)	34 13/64	(869)	9.16	(8511)	6 41/64	(169)	9.16	(8511)	17.93	(16657)	
4020	44 9/16	(1132)	7 13/64	(183)	2.23	(2073)	60 41/64	(1540)	2.23	(2073)	4.91	(4564)	
4026	44 9/16	(1132)	10 13/64	(259)	3.16	(2935)	54 41/64	(1388)	3.16	(2935)	6.69	(6211)	
4030	44 9/16	(1132)	13 13/64	(336)	4.09	(3798)	48 41/64	(1236)	4.09	(3798)	8.46	(7858)	
4036	44 9/16	(1132)	16 13/64	(412)	5.02	(4660)	42 41/64	(1083)	5.02	(4660)	10.23	(9506)	
4040	44 9/16	(1132)	19 13/64	(488)	5.94	(5523)	36 41/64	(931)	5.94	(5523)	12.01	(11153)	
4046	44 9/16	(1132)	22 13/64	(564)	6.87	(6385)	30 41/64	(778)	6.87	(6385)	13.78	(12801)	
4050	E 44 9/16	(1132)	25 13/64	(640)	7.80	(7247)	24 41/64	(626)	7.80	(7247)	15.55	(14448)	
4056	E 44 9/16	(1132)	28 13/64	(717)	8.73	(8110)	18 41/64	(474)	8.73	(8110)	17.33	(16096)	
4060	E 44 9/16	(1132)	31 13/64	(793)	9.66	(8972)	12 41/64	(321)	9.66	(8972)	19.10	(17743)	
4066	E 44 9/16	(1132)	34 13/64	(869)	10.59	(9835)	6 41/64	(169)	10.59	(9835)	20.87	(19391)	

E These units meet National Egress Codes requiring 5.7 SF clear opening, 20" clear width, and 24" clear height, not to exceed a floor to sill height of 44". Code restrictions may vary depending on local building codes.

* Floor to clear opening is calculated using 6'-10 1/4" from finished floor to rough opening header.

Units may optionally include a window opening control device tested to ASTM F2090-10, which can be released from the inside without the use of a key, tool, special knowledge, or force greater than that required for normal unit operation.

EGRESS OPENINGS

Integrity All Ultrex Double Hung Cottage

EGRESS OPENING													
Unit #	Egress Width		Egress Height		Egress Clear Opening		Floor To Clear Opening*		Vent		DLO		Check Rail Height
	Inches	(mm)	Inches	(mm)	Sq. Ft.	(cm ²)	Inches	(mm)	Sq. Ft.	(cm ²)	Sq. Ft.	(cm ²)	
1626	14 9/16	(370)	7 23/32	(196)	0.78	(725)	54 41/64	(1388)	0.78	(725)	2.41	(2235)	(449)
1630	14 9/16	(370)	10 1/8	(257)	1.02	(951)	48 41/64	(1236)	1.02	(951)	3.03	(2818)	(541)
1636	14 9/16	(370)	12 33/64	(318)	1.27	(1176)	42 41/64	(1083)	1.27	(1176)	3.66	(3402)	(632)
1640	14 9/16	(370)	14 59/64	(379)	1.51	(1402)	36 41/64	(931)	1.51	(1402)	4.29	(3985)	(723)
1646	14 9/16	(370)	17 5/16	(440)	1.75	(1627)	30 41/64	(778)	1.75	(1627)	4.92	(4569)	(815)
1650	14 9/16	(370)	19 23/32	(501)	1.99	(1852)	24 41/64	(626)	1.99	(1852)	5.55	(5152)	(906)
1656	14 9/16	(370)	22 13/64	(564)	2.25	(2086)	18 41/64	(474)	2.25	(2086)	6.16	(5722)	(995)
2026	20 9/16	(522)	7 23/32	(196)	1.10	(1024)	54 41/64	(1388)	1.10	(1024)	3.55	(3302)	(449)
2030	20 9/16	(522)	10 1/8	(257)	1.44	(1342)	48 41/64	(1236)	1.44	(1342)	4.48	(4165)	(541)
2036	20 9/16	(522)	12 33/64	(318)	1.79	(1661)	42 41/64	(1083)	1.79	(1661)	5.41	(5027)	(632)
2040	20 9/16	(522)	14 59/64	(379)	2.13	(1979)	36 41/64	(931)	2.13	(1979)	6.34	(5889)	(723)
2046	20 9/16	(522)	17 5/16	(440)	2.47	(2297)	30 41/64	(778)	2.47	(2297)	7.27	(6751)	(815)
2050	20 9/16	(522)	19 23/32	(501)	2.82	(2616)	24 41/64	(626)	2.82	(2616)	8.19	(7613)	(906)
2056	20 9/16	(522)	22 13/64	(564)	3.17	(2946)	18 41						

EGRESS OPENINGS

Integrity® All Ultrex® Double Hung Reverse Cottage

EGRESS OPENING														
Unit #	Egress Width		Egress Height		Egress Clear Opening		Floor To Clear Opening*		Vent		DLO		Check Rail Height	
	Inches	(mm)	Inches	(mm)	Sq. Ft.	(cm ²)	Inches	(mm)	Sq. Ft.	(cm ²)	Sq. Ft.	(cm ²)	Inches	(mm)
1626	14 9/16	(370)	7 23/32	(196)	0.78	(725)	54 41/64	(1388)	0.78	(725)	1.54	(1431)	12 45/64	(323)
1630	14 9/16	(370)	10 1/8	(257)	1.02	(951)	48 41/64	(1236)	1.02	(951)	1.96	(1820)	15 7/64	(384)
1636	14 9/16	(370)	12 33/64	(318)	1.27	(1176)	42 41/64	(1083)	1.27	(1176)	2.38	(2209)	17 33/64	(445)
1640	14 9/16	(370)	14 59/64	(379)	1.51	(1402)	36 41/64	(931)	1.51	(1402)	2.80	(2598)	19 29/32	(506)
1646	14 9/16	(370)	17 5/16	(440)	1.75	(1627)	30 41/64	(778)	1.75	(1627)	3.22	(2987)	22 5/16	(567)
1650	14 9/16	(370)	19 23/32	(501)	1.99	(1852)	24 41/64	(626)	1.99	(1852)	3.63	(3376)	24 45/64	(628)
1656	14 9/16	(370)	22 13/64	(564)	2.25	(2086)	18 41/64	(474)	2.25	(2086)	4.07	(3778)	27 3/16	(691)
2026	20 9/16	(522)	7 23/32	(196)	1.10	(1024)	54 41/64	(1388)	1.10	(1024)	2.28	(2115)	12 45/64	(323)
2030	20 9/16	(522)	10 1/8	(257)	1.44	(1342)	48 41/64	(1236)	1.44	(1342)	2.89	(2689)	15 7/64	(384)
2036	20 9/16	(522)	12 33/64	(318)	1.79	(1661)	42 41/64	(1083)	1.79	(1661)	3.51	(3264)	17 33/64	(445)
2040	20 9/16	(522)	14 59/64	(379)	2.13	(1979)	36 41/64	(931)	2.13	(1979)	4.13	(3839)	19 29/32	(506)
2046	20 9/16	(522)	17 5/16	(440)	2.47	(2297)	30 41/64	(778)	2.47	(2297)	4.75	(4414)	22 5/16	(567)
2050	20 9/16	(522)	19 23/32	(501)	2.82	(2616)	24 41/64	(626)	2.82	(2616)	5.37	(4988)	24 45/64	(628)
2056	20 9/16	(522)	22 13/64	(564)	3.17	(2946)	18 41/64	(474)	3.17	(2946)	6.01	(5582)	27 3/16	(691)
2626	26 9/16	(675)	7 23/32	(196)	1.42	(1323)	54 41/64	(1388)	1.42	(1323)	3.01	(2798)	12 45/64	(323)
2630	26 9/16	(675)	10 1/8	(257)	1.87	(1734)	48 41/64	(1236)	1.87	(1734)	3.83	(3559)	15 7/64	(384)
2636	26 9/16	(675)	12 33/64	(318)	2.31	(2145)	42 41/64	(1083)	2.31	(2145)	4.65	(4319)	17 33/64	(445)
2640	26 9/16	(675)	14 59/64	(379)	2.75	(2557)	36 41/64	(931)	2.75	(2557)	5.47	(5080)	19 29/32	(506)
2646	26 9/16	(675)	17 5/16	(440)	3.19	(2968)	30 41/64	(778)	3.19	(2968)	6.29	(5841)	22 5/16	(567)
2650	26 9/16	(675)	19 23/32	(501)	3.64	(3379)	24 41/64	(626)	3.64	(3379)	7.11	(6601)	24 45/64	(628)
2656	26 9/16	(675)	22 13/64	(564)	4.10	(3806)	18 41/64	(474)	4.10	(3806)	7.95	(7387)	27 3/16	(691)
2826	28 9/16	(725)	7 23/32	(196)	1.53	(1422)	54 41/64	(1388)	1.53	(1422)	3.26	(3026)	12 45/64	(323)
2830	28 9/16	(725)	10 1/8	(257)	2.01	(1865)	48 41/64	(1236)	2.01	(1865)	4.14	(3849)	15 7/64	(384)
2836	28 9/16	(725)	12 33/64	(318)	2.48	(2307)	42 41/64	(1083)	2.48	(2307)	5.03	(4671)	17 33/64	(445)
2840	28 9/16	(725)	14 59/64	(379)	2.96	(2749)	36 41/64	(931)	2.96	(2749)	5.91	(5494)	19 29/32	(506)
2846	28 9/16	(725)	17 5/16	(440)	3.44	(3191)	30 41/64	(778)	3.44	(3191)	6.80	(6316)	22 5/16	(567)
2850	28 9/16	(725)	19 23/32	(501)	3.91	(3634)	24 41/64	(626)	3.91	(3634)	7.68	(7139)	24 45/64	(628)
2856	28 9/16	(725)	22 13/64	(564)	4.40	(4092)	18 41/64	(474)	4.40	(4092)	8.60	(7989)	27 3/16	(691)
3026	32 9/16	(827)	7 23/32	(196)	1.75	(1622)	54 41/64	(1388)	1.75	(1622)	3.75	(3482)	12 45/64	(323)
3030	32 9/16	(827)	10 1/8	(257)	2.29	(2126)	48 41/64	(1236)	2.29	(2126)	4.77	(4428)	15 7/64	(384)
3036	32 9/16	(827)	12 33/64	(318)	2.83	(2630)	42 41/64	(1083)	2.83	(2630)	5.79	(5375)	17 33/64	(445)
3040	32 9/16	(827)	14 59/64	(379)	3.37	(3134)	36 41/64	(931)	3.37	(3134)	6.80	(6321)	19 29/32	(506)
3046	32 9/16	(827)	17 5/16	(440)	3.92	(3638)	30 41/64	(778)	3.92	(3638)	7.82	(7267)	22 5/16	(567)
3050	32 9/16	(827)	19 23/32	(501)	4.46	(4142)	24 41/64	(626)	4.46	(4142)	8.84	(8214)	24 45/64	(628)
3056	32 9/16	(827)	22 13/64	(564)	5.02	(4666)	18 41/64	(474)	5.02	(4666)	9.89	(9192)	27 3/16	(691)
3626	38 9/16	(979)	7 23/32	(196)	2.07	(1921)	54 41/64	(1388)	2.07	(1921)	4.48	(4165)	12 45/64	(323)
3630	38 9/16	(979)	10 1/8	(257)	2.71	(2518)	48 41/64	(1236)	2.71	(2518)	5.70	(5298)	15 7/64	(384)
3636	38 9/16	(979)	12 33/64	(318)	3.35	(3115)	42 41/64	(1083)	3.35	(3115)	6.92	(6430)	17 33/64	(445)
3640	38 9/16	(979)	14 59/64	(379)	4.00	(3712)	36 41/64	(931)	4.00	(3712)	8.14	(7562)	19 29/32	(506)
3646	38 9/16	(979)	17 5/16	(440)	4.64	(4309)	30 41/64	(778)	4.64	(4309)	9.36	(8694)	22 5/16	(567)
3650	38 9/16	(979)	19 23/32	(501)	5.28	(4906)	24 41/64	(626)	5.28	(4906)	10.58	(9826)	24 45/64	(628)
3656	38 9/16	(979)	22 13/64	(564)	5.95	(5525)	18 41/64	(474)	5.95	(5525)	11.84	(10996)	27 3/16	(691)
4026	44 9/16	(1132)	7 23/32	(196)	2.39	(2219)	54 41/64	(1388)	2.39	(2219)	5.22	(4849)	12 45/64	(323)
4030	44 9/16	(1132)	10 1/8	(257)	3.13	(2909)	48 41/64	(1236)	3.13	(2909)	6.64	(6167)	15 7/64	(384)
4036	44 9/16	(1132)	12 33/64	(318)	3.87	(3599)	42 41/64	(1083)	3.87	(3599)	8.06	(7485)	17 33/64	(445)
4040	44 9/16	(1132)	14 59/64	(379)	4.62	(4289)	36 41/64	(931)	4.62	(4289)	9.48	(8803)	19 29/32	(506)
4046	44 9/16	(1132)	17 5/16	(440)	5.36	(4979)	30 41/64	(778)	5.36	(4979)	10.89	(10121)	22 5/16	(567)
4050	44 9/16	(1132)	19 23/32	(501)	6.10	(5669)	24 41/64	(626)	6.10	(5669)	12.31	(11439)	24 45/64	(628)
4056	44 9/16	(1132)	22 13/64	(564)	6.87	(6385)	18 41/64	(474)	6.87	(6385)	13.78	(12801)	27 3/16	(691)

Integrity® All Ultrex® Sliding Patio Door

EGRESS OPENING										
Unit #	Egress Width		Egress Height		Egress Clear Opening		Vent		DLO	
	Inches	(mm)	Inches	(mm)	Sq. Ft.	(cm ²)	Sq. Ft.	(cm ²)	Sq. Ft.	(cm ²)
5068	24 1/16	(611)	75 17/64	(1912)	12.58	(11688)	12.58	(11688)	25.16	(23376)
50610	24 1/16	(611)	77 17/64	(1963)	12.92	(11999)	12.92	(11999)	25.86	(24021)
5080	24 1/16	(611)	91 17/64	(2318)	15.26	(14173)	15.26	(14173)	30.72	(28536)
51068	29 5/16	(745)	75 17/64	(1912)	15.33	(14238)	15.33	(14238)	30.45	(28287)
6068	30 1/16	(764)	75 17/64	(1912)	15.72	(14602)	15.72	(14602)	31.20	(28989)
60610	30 1/16	(764)	77 17/64	(1963)	16.14	(14990)	16.14	(14990)	32.06	(29789)
6080	30 1/16	(764)	91 17/64	(2318)	19.06	(17706)	19.06	(17706)	38.09	(35387)
9068	32 5/32	(817)	75 17/64	(1912)	16.81	(15616)	16.81	(15616)	31.20	(28989)
90610	32 5/32	(817)	77 17/64	(1963)	17.26	(16031)	17.26	(16031)	32.06	(29789)
9080	32 5/32	(817)	91 17/64	(2318)	20.38	(18935)	20.38	(18935)	38.09	(35387)
9068	30 1/16	(764)	75 17/64	(1912)	15.72	(14602)	15.72	(14602)	31.20	(28989)
90610	30 1/16	(764)	77 17/64	(1963)	16.14	(14990)	16.14	(14990)	32.06	(29789)
9080	30 1/16	(764)	91 17/64	(2318)	19.06	(17706)	19.06	(17706)	38.09	(35387)

E These units meet National Egress Codes requiring 5.7 SF clear opening, 20" clear width, and 24" clear height, not to exceed a floor to sill height of 44". Code restrictions may vary depending on local building codes.

* Floor to clear opening is calculated using 6'-10 1/4" from finished floor to rough opening header.

Units may optionally include a window opening control device tested to ASTM F2090-10, which can be released from the inside without the use of a key, tool, special knowledge, or force greater than that required for normal unit operation.

EGRESS OPENINGS

INTEGRITY® FROM MARVIN®
ALL ULTREX® SERIES

Integrity All Ultrex Glider

EGRESS OPENING													
Unit #	Egress Width		Egress Height		Egress Clear Opening		Floor To Clear Opening*		Venting		DLO		
	Inches	(mm)	Inches	(mm)	Sq. Ft.	(cm ²)	Sq. Ft.	(cm ²)	Sq. Ft.	(cm ²)	Sq. Ft.	(cm ²)	
2616	11 13/16	(300)	13 41/64	(346)	1.10	(1024)	66 41/64	(1693)	1.10	(1024)	1.97	(1833)	
2620	11 13/16	(300)	19 41/64	(499)	1.59	(1482)	60 41/64	(1540)	1.59	(1482)	2.92	(2709)	
2626	11 13/16	(300)	25 41/64	(651)	2.09	(1939)	54 41/64	(1388)	2.09	(1939)	3.86	(3584)	
2630	11 13/16	(300)	31 41/64	(804)	2.58	(2396)	48 41/64	(1236)	2.58	(2396)	4.80	(4460)	
2636	11 13/16	(300)	37 41/64	(956)	3.07	(2853)	42 41/64	(1083)	3.07	(2853)	5.74	(5335)	
2640	11 13/16	(300)	43 41/64	(1108)	3.56	(3310)	36 41/64	(931)	3.56	(3310)	6.69	(6211)	
2646	11 13/16	(300)	49 41/64	(1261)	4.05	(3767)	30 41/64	(778)	4.05	(3767)	7.63	(7087)	
2650	11 13/16	(300)	55 41/64	(1413)	4.55	(4224)	24 41/64	(626)	4.55	(4224)	8.57	(7962)	
3016	14 13/16	(376)	13 41/64	(346)	1.39	(1288)	66 41/64	(1693)	1.39	(1288)	2.50	(2319)	
3020	14 13/16	(376)	19 41/64	(499)	2.00	(1862)	60 41/64	(1540)	2.00	(1862)	3.69	(3427)	
3026	14 13/16	(376)	25 41/64	(651)	2.62	(2435)	54 41/64	(1388)	2.62	(2435)	4.88	(4535)	
3030	14 13/16	(376)	31 41/64	(804)	3.24	(3008)	48 41/64	(1236)	3.24	(3008)	6.07	(5643)	
3036	14 13/16	(376)	37 41/64	(956)	3.85	(3581)	42 41/64	(1083)	3.85	(3581)	7.27	(6751)	
3040	14 13/16	(376)	43 41/64	(1108)	4.47	(4154)	36 41/64	(931)	4.47	(4154)	8.46	(7858)	
3046	14 13/16	(376)	49 41/64	(1261)	5.09	(4728)	30 41/64	(778)	5.09	(4728)	9.65	(8966)	
3050	14 13/16	(376)	55 41/64	(1413)	5.71	(5301)	24 41/64	(626)	5.71	(5301)	10.84	(10074)	

ALTITUDE GUIDELINE

Integrity® recommends the maximum altitude limitation for its seal insulated glass units. These limits do not account for glass deflection which may take on a pillowed appearance below these elevations. The limits may be affected by site, location, temperature and/or divided lites. Integrity does not recommend the use of IG units in excess of these specified guidelines. These limitations apply to Integrity units and should not be interpreted as an industry standard.

ALL-ULTREX®

Casement

ALTITUDE LIMITS (FEET)

UNIT SIZE		1-6	2-0	2-6	3-0
2-0	Annealed	4000	5000	6000	6000
	Tempered	6000	8000	10000	10000
2-6	Annealed	4000	6000	7000	8000
	Tempered	7000	10000	10000	10000
3-0	Annealed	4000	6000	8000	9000
	Tempered	8000	10000	10000	10000
3-6	Annealed	4000	6000	8000	10000
	Tempered	9000	10000	10000	10000
4-0	Annealed	4000	6000	8000	10000
	Tempered	9000	10000	10000	10000
4-6	Annealed	4000	6000	8000	10000
	Tempered	10000	10000	10000	10000
5-0	Annealed	4000	6000	8000	10000
	Tempered	10000	10000	10000	10000
5-6	Annealed	4000	6000	8000	10000
	Tempered	10000	10000	10000	10000
6-0	Annealed	4000	6000	9000	10000
	Tempered	10000	10000	10000	10000

ALL-ULTREX

Awning

ALTITUDE LIMITS (FEET)

UNIT SIZE		1-6	2-0	2-6	3-0	3-6	4-0
1-6	Annealed	4000	4000	4000	4000	4000	4000
	Tempered	5000	6000	7000	8000	9000	9000
2-0	Annealed	4000	5000	6000	6000	6000	6000
	Tempered	6000	8000	10000	10000	10000	10000
2-6	Annealed	4000	6000	7000	8000	8000	8000
	Tempered	7000	10000	10000	10000	10000	10000
3-0	Annealed	4000	6000	8000	9000	10000	10000
	Tempered	8000	10000	10000	10000	10000	10000

Integrity Windows and Doors provides these elevation guidelines as a convenience to our customers. Integrity does not recommend installation above the elevation guidelines, and products installed above such elevations are not warranted. A variety of factors, including ambient temperature, altitude, and other conditions outside Integrity's control may cause glass deflection, distortion, or an increase in convexity of the insulating glass units. Deflection, distortion, and increased convexity are not considered product defects and are not covered under Integrity's general warranty; capillary tubes may minimize these effects. Integrity does not warrant the amount or percentage of argon or other inert gas present in insulating glass at any time after manufacture. Inert gas dissipates over time, and may be ineffective in products manufactured with capillary tubes. Thermal efficiencies vary with the application of the product. Integrity does not warrant that a specific level of thermal efficiency will be achieved by inert gas, low emissivity coatings, or other product features. Determining the suitability and compliance with local or other applicable building codes or standards, of all building components, including the use of any Integrity product, and the design and installation of any flashing or sealing system, is the responsibility of the buyer, user, architect, contractor, installer, and/or other construction professional. Integrity will not be liable for any problem or damage relating to inappropriate or faulty building design or construction, maintenance, installation, or selection of products. Integrity does not warrant any product's compliance with local or other applicable building codes or standards, or its suitability for use in connection with a project seeking third party certification to any standard.

ALTITUDE GUIDELINE

ALL-ULTREX

Swinging Picture

ALTITUDE LIMITS (FEET)

UNIT SIZE		1-6	2-0	2-6	3-0	3-6	4-0	5-0	6-0
1-0	Annealed	4000	4000	4000	4000	4000	4000	N/A	N/A
	Tempered	4000	4000	5000	5000	5000	5000	N/A	N/A
1-6	Annealed	4000	4000	4000	4000	4000	4000	N/A	N/A
	Tempered	5000	6000	7000	8000	9000	9000	N/A	N/A
2-0	Annealed	4000	5000	6000	6000	6000	6000	6000	6000
	Tempered	6000	8000	10000	10000	10000	10000	10000	10000
2-6	Annealed	4000	6000	7000	8000	8000	8000	8000	9000
	Tempered	7000	10000	10000	10000	10000	10000	10000	10000
3-0	Annealed	4000	6000	8000	9000	10000	10000	10000	10000
	Tempered	8000	10000	10000	10000	10000	10000	10000	10000
3-6	Annealed	4000	6000	8000	10000	10000	10000	10000	10000
	Tempered	9000	10000	10000	10000	10000	10000	10000	10000
4-0	Annealed	4000	6000	8000	10000	10000	10000	10000	10000
	Tempered	9000	10000	10000	10000	10000	10000	10000	10000
4-6	Annealed	4000	6000	8000	10000	10000	10000	10000	10000
	Tempered	10000	10000	10000	10000	10000	10000	10000	10000
5-0	Annealed	4000	6000	8000	10000	10000	10000	10000	10000
	Tempered	10000	10000	10000	10000	10000	10000	10000	10000
5-6	Annealed	4000	6000	8000	10000	10000	10000	10000	10000
	Tempered	10000	10000	10000	10000	10000	10000	10000	10000
6-0	Annealed	4000	6000	9000	10000	10000	10000	10000	10000
	Tempered	10000	10000	10000	10000	10000	10000	10000	10000

ALL-ULTREX

Swinging Transom

ALTITUDE LIMITS (FEET)

UNIT SIZE		1-6	2-0	2-6	3-0	3-6	4-0	5-0	6-0
1-0	Annealed	4000	4000	4000	4000	4000	4000	N/A	N/A
	Tempered	4000	4000	5000	5000	5000	5000	N/A	N/A
1-6	Annealed	4000	4000	4000	4000	4000	4000	N/A	N/A
	Tempered	5000	6000	7000	8000	9000	9000	N/A	N/A
2-0	Annealed	4000	5000	6000	6000	6000	6000	6000	6000
	Tempered	6000	8000	10000	10000	10000	10000	10000	10000
2-6	Annealed	N/A	N/A	N/A	N/A	N/A	N/A	8000	9000
	Tempered	N/A	N/A	N/A	N/A	N/A	N/A	10000	10000
3-0	Annealed	N/A	N/A	N/A	N/A	N/A	N/A	10000	10000
	Tempered	N/A	N/A	N/A	N/A	N/A	N/A	10000	10000

Integrity Windows and Doors provides these elevation guidelines as a convenience to our customers. Integrity does not recommend installation above the elevation guidelines, and products installed above such elevations are not warranted. A variety of factors, including ambient temperature, altitude, and other conditions outside Integrity's control may cause glass deflection, distortion, or an increase in convexity of the insulating glass units. Deflection, distortion, and increased convexity are not considered product defects and are not covered under Integrity's general warranty; capillary tubes may minimize these effects. Integrity does not warrant the amount or percentage of argon or other inert gas present in insulating glass at any time after manufacture. Inert gas dissipates over time, and may be ineffective in products manufactured with capillary tubes. Thermal efficiencies vary with the application of the product. Integrity does not warrant that a specific level of thermal efficiency will be achieved by inert gas, low emissivity coatings, or other product features. Determining the suitability and compliance with local or other applicable building codes or standards, of all building components, including the use of any Integrity product, and the design and installation of any flashing or sealing system, is the responsibility of the buyer, user, architect, contractor, installer, and/or other construction professional. Integrity will not be liable for any problem or damage relating to inappropriate or faulty building design or construction, maintenance, installation, or selection of products. Integrity does not warrant any product's compliance with local or other applicable building codes or standards, or its suitability for use in connection with a project seeking third party certification to any standard.

ALL-ULTREX

Swinging Picture STC/OITC

ALTITUDE LIMITS (FEET)

UNIT SIZE		1-6	2-0	2-6	3-0	3-6	4-0	5-0	6-0
1-0	Annealed	N/A	N/A	N/A	N/A	N/A	N/A	N/A	N/A
	Tempered	N/A	N/A	N/A	N/A	N/A	N/A	N/A	N/A
1-6	Annealed	N/A	N/A	N/A	N/A	N/A	N/A	N/A	N/A
	Tempered	N/A	N/A	N/A	N/A	N/A	N/A	N/A	N/A
2-0	Annealed	3000	4000	4000	5000	5000	5000	5000	5000
	Tempered	5000	7000	8000	10000	10000	10000	10000	10000
2-6	Annealed	3000	4000	6000	6000	6000	7000	7000	7000
	Tempered	6000	8000	10000	10000	10000	10000	10000	10000
3-0	Annealed	3000	5000	6000	8000	8000	8000	9000	9000
	Tempered	7000	10000	10000	10000	10000	10000	10000	10000
3-6	Annealed	3000	5000	6000	8000	10000	10000	10000	10000
	Tempered	7000	10000	10000	10000	10000	10000	10000	10000
4-0	Annealed	3000	5000	7000	8000	10000	10000	10000	N/A
	Tempered	8000	10000	10000	10000	10000	10000	10000	N/A
4-6	Annealed	3000	5000	7000	9000	10000	10000	N/A	N/A
	Tempered	8000	10000	10000	10000	10000	10000	N/A	N/A
5-0	Annealed	3000	5000	7000	9000	10000	10000	N/A	N/A
	Tempered	8000	10000	10000	10000	10000	10000	N/A	N/A
5-6	Annealed	3000	5000	7000	9000	10000	10000	N/A	N/A
	Tempered	9000	10000	10000	10000	10000	10000	N/A	N/A
6-0	Annealed	3000	5000	7000	9000	10000	N/A	N/A	N/A
	Tempered	9000	10000	10000	10000	10000	N/A	N/A	N/A

ALL-ULTREX

Swinging Transom STC/OITC

ALTITUDE LIMITS (FEET)

UNIT SIZE		1-6	2-0	2-6	3-0	3-6	4-0	5-0	6-0
1-0	Annealed	3000	3000	3000	3000	3000	3000	N/A	N/A
	Tempered	4000	4000	4000	4000	4000	4000	N/A	N/A
1-6	Annealed	3000	3000	3000	3000	3000	3000	N/A	N/A
	Tempered	4000	5000	6000	7000	7000	8000	N/A	N/A
2-0	Annealed	3000	4000	4000	5000	5000	5000	5000	5000
	Tempered	5000	7000	8000	10000	10000	10000	10000	10000
2-6	Annealed	N/A	N/A	N/A	N/A	N/A	N/A	7000	7000
	Tempered	N/A	N/A	N/A	N/A	N/A	N/A	10000	10000
3-0	Annealed	N/A	N/A	N/A	N/A	N/A	N/A	9000	9000
	Tempered	N/A	N/A	N/A	N/A	N/A	N/A	10000	10000

Integrity Windows and Doors provides these elevation guidelines as a convenience to our customers. Integrity does not recommend installation above the elevation guidelines, and products installed above such elevations are not warranted. A variety of factors, including ambient temperature, altitude, and other conditions outside Integrity's control may cause glass deflection, distortion, or an increase in convexity of the insulating glass units. Deflection, distortion, and increased convexity are not considered product defects and are not covered under Integrity's general warranty; capillary tubes may minimize these effects. Integrity does not warrant the amount or percentage of argon or other inert gas present in insulating glass at any time after manufacture. Inert gas dissipates over time, and may be ineffective in products manufactured with capillary tubes. Thermal efficiencies vary with the application of the product. Integrity does not warrant that a specific level of thermal efficiency will be achieved by inert gas, low emissivity coatings, or other product features. Determining the suitability and compliance with local or other applicable building codes or standards, of all building components, including the use of any Integrity product, and the design and installation of any flashing or sealing system, is the responsibility of the buyer, user, architect, contractor, installer, and/or other construction professional. Integrity will not be liable for any problem or damage relating to inappropriate or faulty building design or construction, maintenance, installation, or selection of products. Integrity does not warrant any product's compliance with local or other applicable building codes or standards, or its suitability for use in connection with a project seeking third party certification to any standard.

ALTITUDE GUIDELINE

ALL-ULTREX®

Single Hung/Double Hung

ALTITUDE LIMITS (FEET)

UNIT SIZE	1-6	2-0	2-6	2-8	3-0	3-6	4-0
2-0	Annealed	4000	4000	4000	4000	4000	4000
	Tempered	4000	5000	5000	6000	6000	6000
2-6	Annealed	4000	4000	4000	4000	4000	4000
	Tempered	5000	6000	7000	7000	8000	9000
3-0	Annealed	4000	5000	5000	5000	5000	5000
	Tempered	6000	7000	9000	9000	10000	10000
3-6	Annealed	4000	5000	5000	6000	6000	6000
	Tempered	6000	8000	10000	10000	10000	10000
4-0	Annealed	4000	6000	6000	6000	7000	7000
	Tempered	7000	9000	10000	10000	10000	10000
4-6	Annealed	4000	6000	7000	7000	8000	8000
	Tempered	7000	10000	10000	10000	10000	10000
5-0	Annealed	4000	6000	8000	8000	8000	9000
	Tempered	8000	10000	10000	10000	10000	10000
5-6	Annealed	4000	6000	8000	8000	9000	10000
	Tempered	8000	10000	10000	10000	10000	10000
6-0	Annealed	4000	6000	8000	8000	9000	10000
	Tempered	9000	10000	10000	10000	10000	10000
6-6	Annealed	4000	6000	8000	8000	10000	10000
	Tempered	9000	10000	10000	10000	10000	10000

ALL-ULTREX

Sliding Picture

ALTITUDE LIMITS (FEET)

UNIT SIZE	1-6	2-0	2-6	2-8	3-0	3-6	4-0	5-0	6-0
2-0	Annealed	4000	5000	6000	6000	6000	6000	6000	6000
	Tempered	7000	9000	10000	10000	10000	10000	10000	10000
2-6	Annealed	4000	6000	7000	8000	8000	8000	9000	8000
	Tempered	8000	10000	10000	10000	10000	10000	10000	10000
3-0	Annealed	4000	6000	8000	8000	9000	10000	10000	10000
	Tempered	8000	10000	10000	10000	10000	10000	10000	10000
3-6	Annealed	4000	6000	8000	9000	10000	10000	10000	10000
	Tempered	9000	10000	10000	10000	10000	10000	10000	10000
4-0	Annealed	4000	6000	8000	9000	10000	10000	10000	10000
	Tempered	10000	10000	10000	10000	10000	10000	10000	10000
4-6	Annealed	4000	6000	8000	9000	10000	10000	10000	10000
	Tempered	10000	10000	10000	10000	10000	10000	10000	10000
5-0	Annealed	4000	6000	9000	9000	10000	10000	10000	10000
	Tempered	10000	10000	10000	10000	10000	10000	10000	10000
5-6	Annealed	4000	6000	8000	9000	10000	10000	10000	10000
	Tempered	10000	10000	10000	10000	10000	10000	10000	10000
6-0	Annealed	4000	6000	8000	9000	10000	10000	10000	10000
	Tempered	10000	10000	10000	10000	10000	10000	10000	10000
6-6	Annealed	4000	6000	8000	9000	10000	10000	10000	10000
	Tempered	10000	10000	10000	10000	10000	10000	10000	10000

Integrity® Windows and Doors provides these elevation guidelines as a convenience to our customers. Integrity does not recommend installation above the elevation guidelines, and products installed above such elevations are not warranted. A variety of factors, including ambient temperature, altitude, and other conditions outside Integrity's control may cause glass deflection, distortion, or an increase in convexity of the insulating glass units. Deflection, distortion, and increased convexity are not considered product defects and are not covered under Integrity's general warranty; capillary tubes may minimize these effects. Integrity does not warrant the amount or percentage of argon or other inert gas present in insulating glass at any time after manufacture. Inert gas dissipates over time, and may be ineffective in products manufactured with capillary tubes. Thermal efficiencies vary with the application of the product. Integrity does not warrant that a specific level of thermal efficiency will be achieved by inert gas, low emissivity coatings, or other product features. Determining the suitability and compliance with local or other applicable building codes or standards, of all building components, including the use of any Integrity product, and the design and installation of any flashing or sealing system, is the responsibility of the buyer, user, architect, contractor, installer, and/or other construction professional. Integrity will not be liable for any problem or damage relating to inappropriate or faulty building design or construction, maintenance, installation, or selection of products. Integrity does not warrant any product's compliance with local or other applicable building codes or standards, or its suitability for use in connection with a project seeking third party certification to any standard.

ALTITUDE GUIDELINE

ALL-ULTREX

Glider

ALTITUDE LIMITS (FEET)

UNIT SIZE	2-6	3-0	3-6	4-0	4-6	5-0	6-0
1-6	Annealed	4000	4000	4000	4000	4000	4000
	Tempered	5000	6000	6000	7000	7000	8000
2-0	Annealed	4000	5000	5000	6000	6000	6000
	Tempered	6000	7000	8000	9000	10000	10000
2-6	Annealed	4000	5000	5000	6000	7000	8000
	Tempered	7000	9000	10000	10000	10000	10000
3-0	Annealed	4000	5000	6000	7000	7000	8000
	Tempered	8000	10000	10000	10000	10000	10000
3-6	Annealed	4000	5000	6000	7000	8000	9000
	Tempered	8000	10000	10000	10000	10000	10000
4-0	Annealed	4000	5000	6000	7000	8000	9000
	Tempered	9000	10000	10000	10000	10000	10000
4-6	Annealed	4000	5000	6000	7000	8000	9000
	Tempered	9000	10000	10000	10000	10000	10000
5-0	Annealed	4000	5000	6000	7000	8000	9000
	Tempered	9000	10000	10000	10000	10000	10000

ALL-ULTREX

Glider STC/OITC

ALTITUDE LIMITS (FEET)

UNIT SIZE	2-6	3-0	3-6	4-0	4-6	5-0	6-0
1-6	Annealed	3000	3000	3000	3000	3000	3000
	Tempered	4000	5000	6000	6000	7000	7000
2-0	Annealed	3000	4000	4000	4000	5000	5000
	Tempered	5000	6000	7000	8000	9000	10000
2-6	Annealed	3000	4000	4000	5000	6000	7000
	Tempered	6000	7000	8000	10000	10000	10000
3-0	Annealed	3000	4000	5000	5000	6000	8000
	Tempered	6000	8000	10000	10000	10000	10000
3-6	Annealed	3000	4000	5000	6000	7000	9000
	Tempered	7000	9000	10000	10000	10000	10000
4-0	Annealed	3000	4000	5000	6000	7000	9000
	Tempered	7000	10000	10000	10000	10000	10000
4-6	Annealed	3000	4000	5000	6000	7000	8000
	Tempered	8000	10000	10000	10000	10000	10000
5-0	Annealed	3000	4000	5000	6000	7000	8000
	Tempered	8000	10000	10000	10000	10000	10000

ALL-ULTREX

Glider Triple Sash Stationary

ALTITUDE LIMITS (FEET)

UNIT SIZE	6-0	7-0	8-0
1-6	Annealed	4000	4000
	Tempered	9000	10000
2-0	Annealed	6000	6000
	Tempered	10000	10000
2-6	Annealed	8000	8000
	Tempered	10000	10000
3-0	Annealed	10000	10000
	Tempered	10000	10000
3-6	Annealed	10000	10000
	Tempered	10000	10000
4-0	Annealed	10000	10000
	Tempered	10000	10000
4-6	Annealed	10000	10000
	Tempered	10000	10000
5-0	Annealed	10000	10000
	Tempered	10000	10000

ALL-ULTREX

Sliding Transom

ALTITUDE LIMITS (FEET)

UNIT SIZE	1-6	2-0	2-6	2-8	3-0	3-6	4-0	5-0	6-0
1-0	Annealed	4000	4000	4000	4000	4000	4000	4000	4000
	Tempered	4000	5000	5000	5000	5000	5000	5000	5000
1-6	Annealed	4000	4000	4000	4000	4000	4000	4000	4000
	Tempered	5000	7000	8000	8000	8000	9000	10000	10000
2-0	Annealed	N/A	5000	6000	6000	6000	6000	6000	6000
	Tempered	N/A	9000	10000	10000	10000	10000	10000	10000

ALL-ULTREX

Glider Transom

ALTITUDE LIMITS (FEET)

UNIT SIZE	6-0	7-0	8-0
1-6	Annealed	4000	4000
	Tempered	6000	7000
2-0	Annealed	5000	5000
	Tempered	7000	8000
2-6	Annealed	5000	6000
	Tempered	9000	10000
3-0	Annealed	5000	6000
	Tempered	10000	10000
3-6	Annealed	5000	6000
	Tempered	10000	10000
4-0	Annealed	5000	6000
	Tempered	10000	10000
4-6	Annealed	5000	6000
	Tempered	10000	10000
5-0	Annealed	5000	6000
	Tempered	10000	10000

ALL-ULTREX

Glider Transom STC/OITC

ALTITUDE LIMITS (FEET)

UNIT SIZE	6-0	7-0	8-0
1-6	Annealed	3000	3000
	Tempered	5000	5000
2-0	Annealed	4000	4000
	Tempered	6000	7000
2-6	Annealed	4000	5000
	Tempered	7000	8000
3-0	Annealed	4000	5000
	Tempered	8000	10000
3-6	Annealed	4000	5000
	Tempered	9000	10000
4-0	Annealed	4000	5000
	Tempered	10000	10000
4-6	Annealed	4000	5000
	Tempered	10000	10000
5-0	Annealed	4000	5000
	Tempered	10000	10000

ALL-ULTREX

Glider Triple Sash Stationary STC/OITC

ALTITUDE LIMITS (FEET)

UNIT SIZE	6-0	7-0	8-0
1-6	Annealed	3000	3000
	Tempered	7000	8000
2-0	Annealed	5000	4000
	Tempered	10000	10000
2-6	Annealed	7000	6000
	Tempered	10000	10000
3-0	Annealed	8000	9000
	Tempered	10000	10000
3-6	Annealed	9000	10000
	Tempered	10000	10000
4-0	Annealed	10000	10000
	Tempered	10000	10000

ALTITUDE GUIDELINE

ALL-ULTREX®

Sliding Patio Door

ALTITUDE LIMITS (FEET)

UNIT SIZE	5-0	5-10	6-0	9-0
6-8	Annealed	N/A	N/A	N/A
	Tempered	10000	10000	10000
6-10	Annealed	N/A	N/A	N/A
	Tempered	10000	10000	10000
8-0	Annealed	N/A	N/A	N/A
	Tempered	10000	10000	10000

ALL-ULTREX

Sliding Patio Door Direct Glaze Transom

ALTITUDE LIMITS (FEET)

UNIT SIZE	5-0	5-10	6-0
1-0	Annealed	3000	3000
	Tempered	N/A	N/A
1-6	Annealed	4000	4000
	Tempered	N/A	N/A

ALL-ULTREX

Sliding Patio Door STC/OITC

ALTITUDE LIMITS (FEET)

UNIT SIZE	5-0	5-10	6-0	9-0
6-8	Annealed	N/A	N/A	N/A
	Tempered	10000	10000	10000
6-10	Annealed	N/A	N/A	N/A
	Tempered	10000	10000	10000
8-0	Annealed	N/A	N/A	N/A
	Tempered	N/A	N/A	N/A

ALL-ULTREX

Sliding Patio Door Direct Glaze Transom STC/OITC

ALTITUDE LIMITS (FEET)

UNIT SIZE	5-0	5-10	6-0
1-0	Annealed	3000	3000
	Tempered	N/A	N/A
1-6	Annealed	3000	3000
	Tempered	N/A	N/A

ALTITUDE GUIDELINE

ALL-ULTREX

Round Top - RT1

ALTITUDE LIMITS (FEET)

UNIT SIZE	2613	2814	3016	3619	4020	4623	5026	5428	6030	7036	8040
Annealed	3000	3000	4000	5000	5000	6000	7000	8000	9000	10000	N/A
Tempered	N/A	N/A	N/A	N/A	N/A	N/A	N/A	N/A	N/A	N/A	10000

ALL-ULTREX

Round Top - RT2

ALTITUDE LIMITS (FEET)

UNIT SIZE	26	28	30	36	40	50	54	60
10	Annealed	5000	6000	6000	7500	8500	10000	9500
	Tempered	9000	10000	10000	10000	10000	10000	10000
16	Annealed	6000	7000	8000	9000	9000	10000	10000
	Tempered	10000	10000	10000	10000	10000	10000	10000
20	Annealed	6500	7500	8000	9000	10000	10000	10000
	Tempered	10000	10000	10000	10000	10000	10000	10000
26	Annealed	6500	7500	8500	9000	10000	9000	10000
	Tempered	10000	10000	10000	10000	10000	10000	10000
30	Annealed	7000	7500	8500	9500	10000	9000	N/A
	Tempered	10000	10000	10000	10000	10000	10000	N/A
36	Annealed	7000	8000	8500	9500	10000	10000	N/A
	Tempered	10000	10000	10000	10000	10000	10000	N/A
40	Annealed	6000	7000	9000	9500	10000	10000	N/A
	Tempered	10000	10000	10000	10000	10000	10000	N/A
46	Annealed	6000	7000	10000	10000	10000	N/A	N/A
	Tempered	10000	10000	10000	10000	10000	N/A	N/A
50	Annealed	6000	7000	10000	10000	10000	N/A	N/A
	Tempered	10000	10000	10000	10000	10000	N/A	N/A

ALL-ULTREX

Round Top - RT6

ALTITUDE LIMITS (FEET)

UNIT SIZE	26	28	30	36	40	50	54	60	70	80
10	Annealed	4000	4000	4000	4000	4000	4000	4000	4000	5000
	Tempered	5000	5000	7000	7000	7000	9000	8000	10000	8000
16	Annealed	4000	4000	4500	5000	5000	6000	6000	6000	7000
	Tempered	8000	8000	8500	10000	10000	10000	10000	10000	10000
20	Annealed	5000	5000	6500	6500	6500	8000	7000	7000	8000
	Tempered	9000	9000	10000	10000	10000	10000	10000	10000	10000
26	Annealed	6000	7000	8000	8000	8500	9000	10000	9000	9000
	Tempered	10000	10000	10000	10000	10000	10000	10000	10000	10000
30	Annealed	6500	7500	8000	9000	9000	9500	9500	10000	N/A
	Tempered	10000	10000	10000	10000	10000	10000	10000	10000	10000
36	Annealed	6500	7500	8500	9000	10000	10000	10000	10000	N/A
	Tempered	10000	10000	10000	10000	10000	10000	10000	10000	N/A
40	Annealed	7000	7500	8500	9500	10000	10000	10000	10000	N/A
	Tempered	10000	10000	10000	10000	10000	10000	10000	10000	N/A
46	Annealed	7000	8000	8500	9500	10000	10000	10000	N/A	N/A
	Tempered	10000	10000	10000	10000	10000	10000	10000	N/A	N/A
50	Annealed	6000	7000	9000	9500	10000	10000	10000	N/A	N/A
	Tempered	10000	10000	10000	10000	10000	10000	10000	N/A	N/A
56	Annealed	6000	7000	8000	9500	10000	10000	10000	N/A	N/A
	Tempered	10000	10000	10000	10000	10000	10000	10000	N/A	N/A
60	Annealed	6000	7000	8000	10000	10000	10000	10000	N/A	N/A
	Tempered	10000	10000	10000	10000	10000	10000	10000	N/A	N/A

ALL-ULTREX

Round Top - RT1 STC/OITC

ALTITUDE LIMITS (FEET)

UNIT SIZE	2613	2814	3016	3619	4020	4623
Annealed	3000	3000	3000	3000	4000	5000
Tempered	NA	NA	NA	NA	NA	NA

ALL-ULTREX

Round Top - RT2 STC/OITC

ALTITUDE LIMITS (FEET)

UNIT SIZE	26	28	30	36	40
10	Annealed	4000	4000	5000	6500
	Tempered	8000	8000	9000	10000
16	Annealed	5000	5000	6000	7000
	Tempered	9000	10000	10000	N/A
20	Annealed	5500	5500	6000	8000
	Tempered	9500	10000	10000	N/A
26	Annealed	5500	5500	6500	8000
	Tempered	9500	10000	10000	N/A
30	Annealed	6000	5500	6500	8500
	Tempered	10000	10000	10000	N/A
36	Annealed	6000	6000	6500	N/A
	Tempered	10000	10000	10000	N/A
40	Annealed	N/A	N/A	7000	N/A
	Tempered	10000	10000	10000	N/A
46	Annealed	N/A	N/A	N/A	N/A
	Tempered	10000	10000	10000	N/A
50	Annealed	N/A	N/A	N/A	N/A
	Tempered	10000	10000	10000	N/A

ALL-ULTREX

Round Top - RT6 STC/OITC

ALTITUDE LIMITS (FEET)

UNIT SIZE	26	28	30	36	40	50	54	60
10	Annealed	3000	3000	3000	3000	3000	3000	3000
	Tempered	4000	4000	5000	5000	6000	7000	8000
16	Annealed	3000	3000	3000	4000	4000	4000	N/A
	Tempered	6500	8000	6500	9000	10000	10000	10000
20	Annealed	4000	4000	5000	5000	6000	6000	N/A
	Tempered	8000	8000	9500	9500	10000	10000	10000
26	Annealed	5000	5000	6000	6000	6500	7500	N/A
	Tempered	9000	10000	10000	10000	10000	10000	N/A
30	Annealed	5500	5500	6000	8000	8000	N/A	N/A
	Tempered	9500	10000	10000	N/A	N/A	N/A	N/A
36	Annealed	5500	5500	6500	8000	9000	N/A	N/A
	Tempered	9500	10000	10000	N/A	N/A	N/A	N/A
40	Annealed	6000	5500	6500	8000	N/A	N/A	N/A
	Tempered	10000	10000	10000	N/A	N/A	N/A	N/A
46	Annealed	6000	6000	6500	N/A	N/A	N/A	N/A
	Tempered	10000	10000	10000	N/A	N/A	N/A	N/A
50	Annealed	N/A	N/A	7000	N/A	N/A	N/A	N/A
	Tempered	10000	10000	10000	N/A	N/A	N/A	N/A
56	Annealed	N/A	N/A	N/A	N/A	N/A	N/A	N/A
	Tempered	10000	10000	10000	N/A	N/A	N/A	N/A
60	Annealed	N/A	N/A	N/A	N/A	N/A	N/A	N/A
	Tempered	10000	10000	10000	N/A	N/A	N/A	N/A

SOUND TRANSMISSION

PRODUCT TYPE	EXTERIOR GLAZING	AIR SPACE	INTERIOR GLAZING OR CENTER GLAZING	AIRSPACE	INTERIOR GLAZING	STC	OITC
All Ultrex® Casement/Awning							
IFCA	1/8" (3.1)	15/32" (11.5)	1/8" (3.1)	--	--	28	24
	1/8" (3.1)	13/32" (9.8)	3/16" (4.7)	--	--	31	26
IFAWN	1/8" (3.1)	15/32" (11.5)	1/8" (3.1)	--	--	28	24
	1/8" (3.1)	13/32" (9.8)	3/16" (4.7)	--	--	33	28
IFCAP	1/8" (3.1)	15/32" (11.5)	1/8" (3.1)	--	--	28	23
	1/8" (3.1)	13/32" (9.8)	3/16" (4.7)	--	--	33	28
All Ultrex Swinging Picture							
IFSWP	1/8" (3.1)	15/32" (11.5)	1/8" (3.1)	--	--	28	23
	1/8" (3.1)	13/32" (9.8)	3/16" (4.7)	--	--	33	28
All Ultrex Swinging Single Hung/Double Hung							
IFDH	1/8" (3.1)	15/32" (11.5)	1/8" (3.1)	--	--	27	22
	1/8" (3.1)	13/32" (9.8)	3/16" (4.7)	--	--	32	27
IFSH	1/8" (3.1)	15/32" (11.5)	1/8" (3.1)	--	--	27	23
	1/8" (3.1)	13/32" (9.8)	3/16" (4.7)	--	--	28	25
All Ultrex Sliding Picture							
IFSLP	1/8" (3.1)	15/32" (11.5)	1/8" (3.1)	--	--	29	25
	1/8" (3.1)	13/32" (9.8)	3/16" (4.7)	--	--	30	25
All Ultrex Glider							
IFGL	1/8" (3.1)	15/32" (11.5)	1/8" (3.1)	--	--	27	24
	1/8" (3.1)	13/32" (9.8)	3/16" (4.7)	--	--	29	26
All Ultrex Sliding Picture							
IFSLP	1/8" (3.1)	15/32" (11.5)	1/8" (3.1)	--	--	29	25
	1/8" (3.1)	13/32" (9.8)	3/16" (4.7)	--	--	30	25
All Ultrex Series Round Top							
IFRT	1/8" (3.1)	5/8" (16.0)	1/8" (3.1)	--	--	27	22
	1/8" (3.1)	19/32" (14.5)	3/16" (4.7)	--	--	32	26
All Ultrex Sliding Patio Door							
IFSPD	1/8" (3.1)	17/32" (13.0)	1/8" (3.1)	--	--	27	23
	1/8" (3.1)	15/32" (11.5)	3/16" (4.7)	--	--	28	25
All Ultrex Direct Glaze							
IFDGP	1/8" (3.1)	5/8" (16.0)	1/8" (3.1)	--	--	26	21
	1/8" (3.1)	19/32" (14.5)	3/16" (4.7)	--	--	32	27

PERFORMANCE GRADE (PG)

A performance grade rating, as created by AAMA/WDMA/CSA Standards, is a measure of the overall tested performance of a window or door that addresses all of the applicable requirements of the Standards. A product receives a PG rating if it meets all performance requirements, including: air infiltration resistance, water penetration resistance, structural performance, ease of operation, durability, weatherability, and resistance to forced entry. The higher a PG number a product has, the better the performance. As a frame of reference: PG 40 means that a product is tested structurally to a minimum 60 pounds per square foot (psf) and must withstand water penetration under conditions equal to 8 inches of rain per hour driven by a minimum of 50 mph winds.

All Ultrex Single Hung/Double Hung Equal Sash

CN	16	20	26	28	30	36	40
20	LC-PG50-H	LC-PG50-H	LC-PG50-H	LC-PG50-H	LC-PG50-H	LC-PG50-H	LC-PG50-H
26	LC-PG50-H	LC-PG50-H	LC-PG50-H	LC-PG50-H	LC-PG50-H	LC-PG50-H	LC-PG50-H
30	LC-PG50-H	LC-PG50-H	LC-PG50-H	LC-PG50-H	LC-PG50-H	LC-PG50-H	LC-PG50-H
36	LC-PG50-H	LC-PG50-H	LC-PG50-H	LC-PG50-H	LC-PG50-H	LC-PG50-H	LC-PG50-H
40	LC-PG50-H	LC-PG50-H	LC-PG50-H	LC-PG50-H	LC-PG50-H	LC-PG50-H	LC-PG50-H
46	LC-PG50-H	LC-PG50-H	LC-PG50-H	LC-PG50-H	LC-PG50-H	LC-PG40-H	LC-PG40-H
50	LC-PG50-H	LC-PG50-H	LC-PG50-H	LC-PG50-H	LC-PG50-H	LC-PG40-H	LC-PG40-H
56	LC-PG40-H	LC-PG40-H	LC-PG40-H	LC-PG40-H	LC-PG40-H	LC-PG40-H	LC-PG30-H
60	LC-PG40-H	LC-PG40-H	LC-PG40-H	LC-PG40-H	LC-PG40-H	LC-PG30-H	LC-PG30-H
66	LC-PG40-H	LC-PG40-H	LC-PG40-H	LC-PG40-H	LC-PG40-H	LC-PG30-H	LC-PG30-H

Integrity All Ultrex Single Hung Cottage/Reverse Cottage

CN	16	20	26	28	30	36	40
26	LC-PG50-H	LC-PG50-H	LC-PG50-H	LC-PG50-H	LC-PG50-H	LC-PG50-H	LC-PG50-H
30	LC-PG50-H	LC-PG50-H	LC-PG50-H	LC-PG50-H	LC-PG50-H	LC-PG50-H	LC-PG50-H
36	LC-PG50-H	LC-PG50-H	LC-PG50-H	LC-PG50-H	LC-PG50-H	LC-PG40-H	LC-PG40-H
40	LC-PG50-H	LC-PG50-H	LC-PG50-H	LC-PG50-H	LC-PG50-H	LC-PG40-H	LC-PG40-H
46	LC-PG40-H	LC-PG40-H	LC-PG40-H	LC-PG40-H	LC-PG40-H	LC-PG40-H	LC-PG30-H
50	LC-PG40-H	LC-PG40-H	LC-PG40-H	LC-PG40-H	LC-PG40-H	LC-PG30-H	LC-PG30-H
56	LC-PG40-H	LC-PG40-H	LC-PG40-H	LC-PG40-H	LC-PG40-H	LC-PG30-H	LC-PG30-H
60	LC-PG30-H	LC-PG30-H	LC-PG30-H	LC-PG30-H	LC-PG30-H	LC-PG20-H	LC-PG20-H
66	LC-PG20-H	LC-PG20-H	LC-PG20-H	LC-PG20-H	LC-PG20-H	LC-PG20-H	LC-PG20-H

Integrity All Ultrex Double Hung Cottage/Reverse Cottage

CN	16	20	26	28	30	36	40
26	LC-PG50-H	LC-PG50-H	LC-PG50-H	LC-PG50-H	LC-PG50-H	LC-PG50-H	LC-PG50-H
30	LC-PG50-H	LC-PG50-H	LC-PG50-H	LC-PG50-H	LC-PG50-H	LC-PG50-H	LC-PG50-H
36	LC-PG50-H	LC-PG50-H	LC-PG50-H	LC-PG50-H	LC-PG50-H	LC-PG40-H	LC-PG40-H
40	LC-PG50-H	LC-PG50-H	LC-PG50-H	LC-PG50-H	LC-PG50-H	LC-PG40-H	LC-PG40-H
46	LC-PG40-H	LC-PG40-H	LC-PG40-H	LC-PG40-H	LC-PG40-H	LC-PG40-H	LC-PG30-H
50	LC-PG40-H	LC-PG40-H	LC-PG40-H	LC-PG40-H	LC-PG40-H	LC-PG30-H	LC-PG30-H
56	LC-PG40-H	LC-PG40-H	LC-PG40-H	LC-PG40-H	LC-PG40-H	LC-PG30-H	LC-PG30-H

Integrity All Ultrex Glider - XO / OX

CN	26	30	36	40	46	50	60
16	LC-PG40-HS	LC-PG40-HS	LC-PG40-HS	LC-PG40-HS	LC-PG40-HS	LC-PG40-HS	LC-PG40-HS
20	LC-PG40-HS	LC-PG40-HS	LC-PG40-HS	LC-PG40-HS	LC-PG40-HS	LC-PG40-HS	LC-PG40-HS
26	LC-PG40-HS	LC-PG40-HS	LC-PG40-HS	LC-PG40-HS	LC-PG40-HS	LC-PG40-HS	LC-PG40-HS
30	LC-PG40-HS	LC-PG40-HS	LC-PG40-HS	LC-PG40-HS	LC-PG40-HS	LC-PG40-HS	LC-PG40-HS
36	LC-PG40-HS	LC-PG40-HS	LC-PG40-HS	LC-PG40-HS	LC-PG40-HS	LC-PG40-HS	LC-PG40-HS
40	LC-PG40-HS	LC-PG40-HS	LC-PG40-HS	LC-PG40-HS	LC-PG40-HS	LC-PG30-HS	LC-PG30-HS
46	LC-PG40-HS	LC-PG40-HS	LC-PG40-HS	LC-PG40-HS	LC-PG40-HS	LC-PG30-HS	LC-PG30-HS
50	LC-PG40-HS	LC-PG40-HS	LC-PG40-HS	LC-PG40-HS	LC-PG40-HS	LC-PG30-HS	LC-PG30-HS

Integrity All Ultrex Glider - XOx

CN	60	70	80
16	LC-PG25-HS	LC-PG25-HS	LC-PG25-HS
20	LC-PG25-HS	LC-PG25-HS	LC-PG25-HS
26	LC-PG25-HS	LC-PG25-HS	LC-PG25-HS
30	LC-PG25-HS	LC-PG25-HS	LC-PG25-HS
36	LC-PG25-HS	LC-PG25-HS	LC-PG25-HS
40	LC-PG25-HS	LC-PG25-HS	LC-PG25-HS
46	LC-PG25-HS	LC-PG25-HS	LC-PG25-HS
50	LC-PG25-HS	LC-PG25-HS	LC-PG25-HS

Integrity All Ultrex Awning	LC-PG40-AP
Integrity All Ultrex Casement	LC-PG40-C
Integrity All Ultrex Round Top	CW-PG50-FW
Integrity All Ultrex Polygons	LC-PG50-FW
Integrity All Ultrex Sliding Patio Doors	R-PG30-SD
Integrity All Ultrex Sliding Picture/Transom	LC-PG50-FW
Integrity All Ultrex Swinging Picture/Transom	LC-PG40-FW

WDMA STANDARDS

The Window and Door Manufacturers Association (WDMA), in conjunction with other organizations in the industry, has developed standards that make it easy to compare windows from different manufacturers, testing product performance regarding air and water infiltration, as well as physical loads on the exterior and interior (very important when you consider the pressure differentials that can occur in coastal areas, as well as forced entry resistance). Integrity® products are rated in accordance with the North American Fenestration Standard (AAMA/WDMA CSA 101/I.S.2/A440) and are certified in compliance with the WDMA Hallmark program.



FIND YOUR LOCAL INTEGRITY DEALER AT [INTEGRITYWINDOWS.COM](https://www.integritywindows.com).



Call 1-888-419-0076 for the Integrity dealer
nearest you, or visit integritywindows.com



MADE IN AMERICA. 

©2016 Marvin® Windows and Doors. All rights reserved. ©Registered trademark of Marvin Windows and Doors. ENERGY STAR® and the ENERGY STAR mark are registered U.S. marks. Part #19981180.

