



2026-2027

---



# CATALOG AND SPECS

# TABLE OF CONTENTS

<b>ABOUT US</b> .....	<b>03</b>
<b>COLLECTIONS</b> .....	<b>04</b>
<b>CABINETS FEATURES</b> .....	<b>19</b>
<b>HOW TO ORDER</b> .....	<b>20/21</b>
<b>WALL CABINETS</b> .....	<b>22</b>
<b>BASE CABINETS</b> .....	<b>26</b>
<b>TALL CABINETS</b> .....	<b>29</b>
<b>VANITY CABINETS</b> .....	<b>31</b>
<b>ACESSORIES AND MOLDING</b> .....	<b>34</b>
<b>WEBSITE</b> .....	<b>45</b>

# ABOUT US

## Our history

Founded in 2015, Spirits Cabinetry built a strong history in the kitchen and bathroom cabinetry business. Our journey began with a passion for great-quality products at a fair price, and a commitment to delivering excellence.

Over the years, we've grown from a small startup into a thriving cabinetry leader. We've overcome challenges, adapted to changing market dynamics, and expanded our offerings to meet the evolving needs of our valued customers.

In 2026, our brand evolved into HomePro, a new name that reflects where we're headed, while keeping the same essence that brought us here. The same team, the same standards, and the same dedication to innovation, quality, and customer satisfaction, now with even more possibilities to support every project.

Today, we stand as a trusted and respected name in the cabinetry landscape, serving a diverse range of clients across Florida. As we look to the future, our commitment to excellence remains unwavering. We're excited to continue this journey as HomePro, Your Partner in Every Project.



 HOMEPRO

# REGULAR SHAKER

SHAKER

PREMIUM **LINE**

# Cabinet Construction Premium Grade

- XSW - XSB - XLT SE
- XSG - XSP - XLT GR



- 05 Full overlay five-piece doors and drawer fronts.
- 06 6 way stainless-steel adjustable door hinges and door bumpers included.
- 07 Solid Wood painted face frame.

- 01  Solid wood drawer box with dovetail construction.
- 02  Soft close, undermounted full extension drawer slides.
- 03  UV-coated natural interiors.
- 04  1/2" plywood boxes with finished exteriors.

**A** Door & Drawer Front: Full overlay, 5-pieces door & drawer, solid wood with MDF center panel.

**B** Face Frame: 3/4" solid wood frame

**C** Cabinet Box: 1/2" cabinet grade plywood box.

**D** Drawer Box: Solid wood, dovetail construction, 2 1/2 depth

**E** Drawer Glides: Concealed undermount full extension glides with soft-close feature.

**F** Hinges: 6-way adjustable with soft-close feature

**G** Exterior Finish: Matching color exterior.

**H** Interior Finish: Clear UV coated natural plywood.

**I** Shelves: 3/4" thick plywood with front edge banding.

**J** Accessories: Door bumper, metal shelf pin, metal clips, L bracket for base cabinet.

**K** Package: One box per cabinet.

**L** Certification: TSCA VI, KCMA, CARB2, NGBS Green.

# WHITE SHAKER

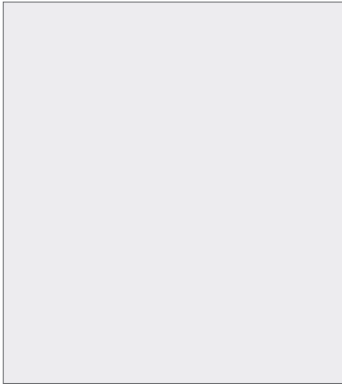

White Shaker / XSW



# LIGHT GRAY SHAKER

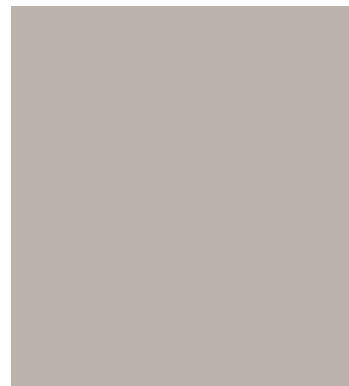

Light Gray Shaker / XSG



# BLACK SHAKER

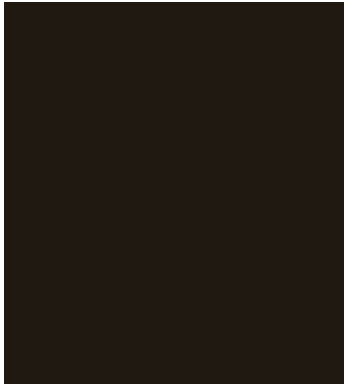

Black Shaker / XSB



# PERL SHAKER

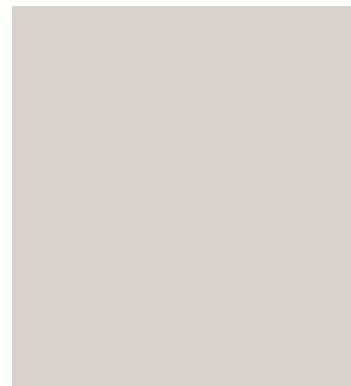

Pearl Shaker (Off White) / XSP



# GRAY SHAKER

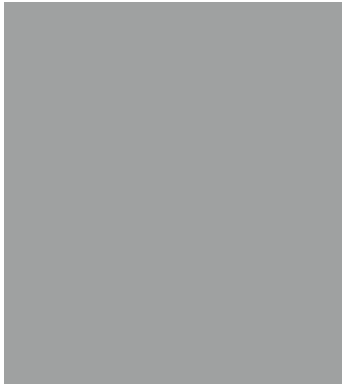

Gray Shaker / XLT-GR



# EXPRESSO SHAKER

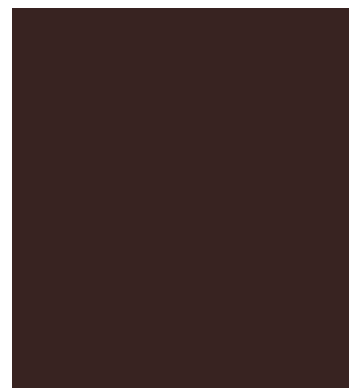

Espresso Shaker / XLT-SE



# Cabinet Construction Universal Box

- XLT NB - XLT SA
- XLT AG - XLT TC



- 05 Shelf 3/4" thick plywood with front edge banding.
- 06 Full overlay, 5-pieces door & drawer, solid wood with MDF center panel.
- 07 6-way adjustable with soft-close feature
- 08 3/4" solid wood frame.

- 01  Solid wood, dovetail construction, 3 1/8" depth.
- 02  Concealed undermount full extensions glides with soft-close feature.
- 03  Interior and Exterior: Clear UV coated natural plywood.
- 04  1/2" cabinet grade plywood box.

**A** Door & Drawer Front: Full overlay, 5-pieces door & drawer, solid wood with MDF center panel.

**B** Face Frame: 3/4" solid wood frame

**C** Cabinet Box: 1/2" cabinet grade plywood box.

**D** Drawer Box: Solid wood, dovetail construction, 3 1/8" depth

**E** Drawer Glides: Concealed undermount full extension glides with soft-close feature.

**F** Hinges: 6-way adjustable with soft-close feature

**G** Exterior Finish: Clear UV coated natural plywood.  
Need to add BSV, WSV, USV for the expose part.

**H** Interior Finish: Clear UV coated natural plywood.

**I** Shelves: 3/4" thick plywood with front edge banding.

**J** Accessories: Door bumper, metal shelf pin, metal clips, L bracket for base cabinet.

**K** Package: 2 packages, universal box & front set.

**L** Certification: TSCA VI, KCMA, CARB2, NGBS Green.

# NAVY BLUE SHAKER



Navy Blue Shaker / XLT-NB



# TRUE CARAMEL SHAKER



True Caramel Shaker / XLT-TC



# FOREST GREEN SHAKER

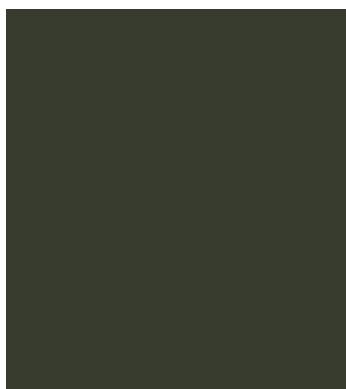

Forest Green Shaker / XLT-AG



# PEPPER SHAKER

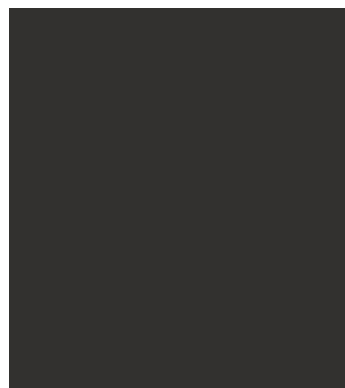

Pepper Shaker / XLT-SA





 HOMEPRO

# SLIM SHAKER

SHAKER





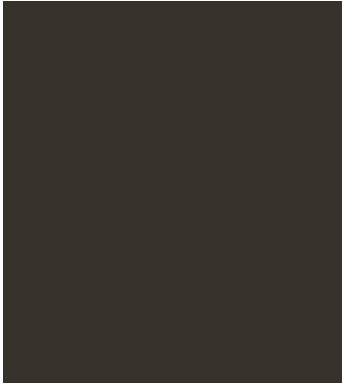

# FOREST GREEN SLIM



Forest Green Slim / XLT-SAG



- 05** Shelf 3/4" thick plywood with front edge banding.
- 06** Full overlay, 5-pieces door & drawer, solid wood with MDF center panel.
- 07** 6-way adjustable with soft-close feature
- 08** 3/4" solid wood frame.

- 01**  Solid wood, dovetail construction, 3 1/8" depth.
- 02**  Concealed undermount full extensions glides with soft-close feature.
- 03**  Interior and Exterior: Clear UV coated natural plywood.
- 04**  1/2" cabinet grade plywood box.

## Cabinet Construction Universal Box

▪ XLT-SAG

EDITION  
2026  
2027

- A** Door & Drawer Front: Full overlay, 5-pieces door & drawer, solid wood with MDF center panel.
- B** Face Frame: 3/4" solid wood frame
- C** Cabinet Box: 1/2" cabinet grade plywood box.
- D** Drawer Box: Solid wood, dovetail construction, 3 1/8" depth
- E** Drawer Glides: Concealed undermount full extension glides with soft-close feature.
- F** Hinges: 6-way adjustable with soft-close feature
- G** Exterior Finish: Clear UV coated natural plywood.  
[Need to add BSV, WSV, USV for the expose part.](#)
- H** Interior Finish: Clear UV coated natural plywood.
- I** Shelves: 3/4" thick plywood with front edge banding.
- J** Accessories: Door bumper, metal shelf pin, metal clips, L bracket for base cabinet.
- K** Package: 2 packages, universal box & front set.
- L** Certification: TSCA VI, KCMA, CARB2, NGBS Green.

# Cabinet Construction Slim Shaker

- XLT-SWO
- XLT-SDW



- 05** Full overlay five-piece doors and drawer fronts.
- 06** 6 way stainless-steel adjustable door hinges and door bumpers included.
- 07** Solid Wood painted face frame.

- 01**  Solid wood drawer box with dovetail construction.
- 02**  Soft close, undermounted full extension drawer slides.
- 03**  UV-coated natural interiors.
- 04**  1/2" plywood boxes with finished exteriors.

**A** Door & Drawer Front: Full overlay, 5-pieces door & drawer, solid wood with MDF center panel.

**B** Face Frame: 3/4" solid wood frame

**C** Cabinet Box: 1/2" cabinet grade plywood box.

**D** Drawer Box: Solid wood, dovetail construction, 3 1/8 depth

**E** Drawer Glides: Concealed undermount full extension glides with soft-close feature.

**F** Hinges: 6-way adjustable with soft-close feature

**G** Exterior Finish: Matching color exterior.

**H** Interior Finish: Clear UV coated natural plywood.

**I** Shelves: 3/4" thick plywood with front edge banding.

**J** Accessories: Door bumper, metal shelf pin, metal clips, L bracket for base cabinet.

**K** Package: One box per cabinet.

**L** Certification: TSCA VI, KCMA, CARB2, NGBS Green.

# WHITE OAK SLIM

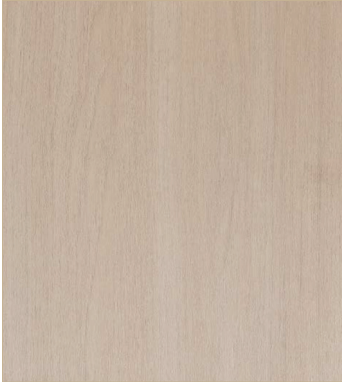

White Oak Slim / XLT-SWO



# WHITE SLIM

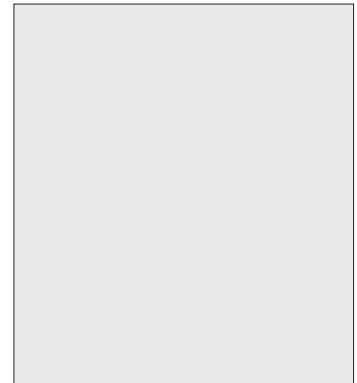

White Slim / XLT-SDW





 HOMEPRO

# DOUBLE SHAKER

# SHAKER



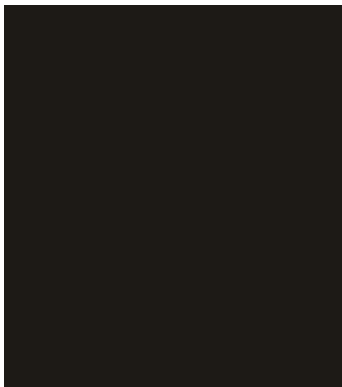

# PEPPER DOUBLE SHAKER



Pepper Double Shaker  
/ XLT-DSG

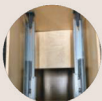

- 05** Shelf 3/4" thick plywood with front edge banding.
- 06** Full overlay, 5-pieces door & drawer, solid wood with MDF center panel.
- 07** 6-way adjustable with soft-close feature
- 08** 3/4" solid wood frame.

- 01**  Solid wood, dovetail construction, 3 1/8" depth.
- 02**  Concealed undermount full extensions glides with soft-close feature.
- 03**  Interior and Exterior: Clear UV coated natural plywood.
- 04**  1/2" cabinet grade plywood box.

## Cabinet Construction Universal Box

▪ XLT-DSG

EDITION  
2026  
2027

- A** Door & Drawer Front: Full overlay, 5-pieces door & drawer, solid wood with MDF center panel.
- B** Face Frame: 3/4" solid wood frame
- C** Cabinet Box: 1/2" cabinet grade plywood box.
- D** Drawer Box: Solid wood, dovetail construction, 3 1/8" depth
- E** Drawer Glides: Concealed undermount full extension glides with soft-close feature.
- F** Hinges: 6-way adjustable with soft-close feature
- G** Exterior Finish: Clear UV coated natural plywood.  
[Need to add BSV, WSV, USV for the expose part.](#)
- H** Interior Finish: Clear UV coated natural plywood.
- I** Shelves: 3/4" thick plywood with front edge banding.
- J** Accessories: Door bumper, metal shelf pin, metal clips, L bracket for base cabinet.
- K** Package: 2 packages, universal box & front set.
- L** Certification: TSCA VI, KCMA, CARB2, NGBS Green.



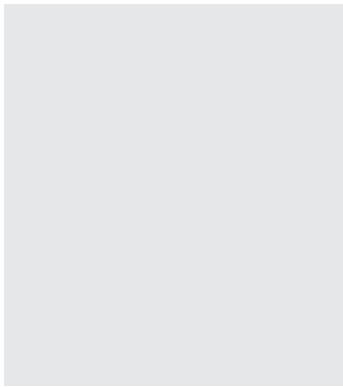

# DOVE WHITE DOUBLE SHAKER



Dove White Double Shaker  
/ XLT-DDW

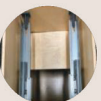

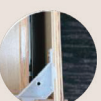
- 01  Solid wood, dovetail construction, 3 1/8" depth.
- 02  Concealed undermount full extensions glides with soft-close feature.
- 03  Interior and Exterior: Clear UV coated natural plywood.
- 04  1/2" cabinet grade plywood box.

- 05 Shelf 3/4" thick plywood with front edge banding.
- 06 Full overlay, 5-pieces door & drawer, solid wood with MDF center panel.
- 07 6-way adjustable with soft-close feature
- 08 3/4" solid wood frame.

## Cabinet Construction Universal Box

▪ XLT-DDW

EDITION  
2026  
2027

- A Door & Drawer Front: Full overlay, 5-pieces door & drawer, solid wood with MDF center panel.
- B Face Frame: 3/4" solid wood frame
- C Cabinet Box: 1/2" cabinet grade plywood box.
- D Drawer Box: Solid wood, dovetail construction, 3 1/8" depth
- E Drawer Glides: Concealed undermount full extension glides with soft-close feature.
- F Hinges: 6-way adjustable with soft-close feature
- G Exterior Finish: Clear UV coated natural plywood.  
Need to add BSV, WSV, USV for the expose part.
- H Interior Finish: Clear UV coated natural plywood.
- I Shelves: 3/4" thick plywood with front edge banding.
- J Accessories: Door bumper, metal shelf pin, metal clips, L bracket for base cabinet.
- K Package: 2 packages, universal box & front set.
- L Certification: TSCA VI, KCMA, CARB2, NGBS Green.

# Cabinet Feature



"L" Bracket reinforced base cabinets with 1/2" thick plywood for heavy counters.

Full extension, under-mounted, soft-close steel concealed drawer glides.

3/4 inch thick stretchers applied to the back of the cabinets.

Adjustable 3/4 inch depth metal shelf rest.

1/2 inch thick cabinet-grade plywood.

Clear-coat UV finish throughout

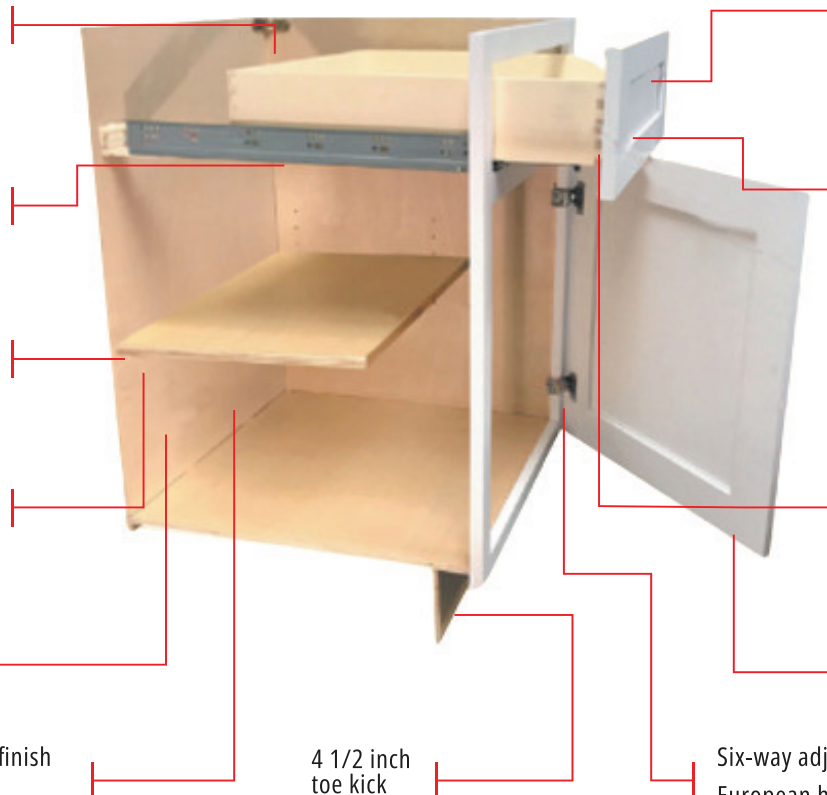

5-Piece wood door fronts

Simple removable drawers for easy cleaning

Ask your Sales Consultant about our latest accessories

Dovetail drawers with 1/2 inch thick solid wood sides

3/4 inch thick full overlay of birch wood door style

4 1/2 inch toe kick

Six-way adjustable European hidden metal hinges

1. Full overlay panel, 3/4 inch solid wood
2. 6-way adjustable European-style hinge with soft-close feature
3. Shelving is 3/4 inch thick cabinet-grade plywood with front edge banding.
4. Dovetail drawers with solid wood on all sides, full extension
5. Concealed under-mount full extension drawer glides with soft-close feature

6. 1/2 inch cabinet-grade plywood box, UV coated natural plywood on interior
7. Bracket reinforcements for base cabinet
8. Double-doweled face frame joint
9. Hardwood face frame
10. Door bumpers



# HOW TO ORDER

## TO ORDER:

Specify the 2 letter door style, followed by the product number for the cabinet.

## Example:

SW-W0930 Should be the product number used to order a Shaker White (SW) Wall Cabinet (W), 09" wide, 30" high.

## Wall Cabinets

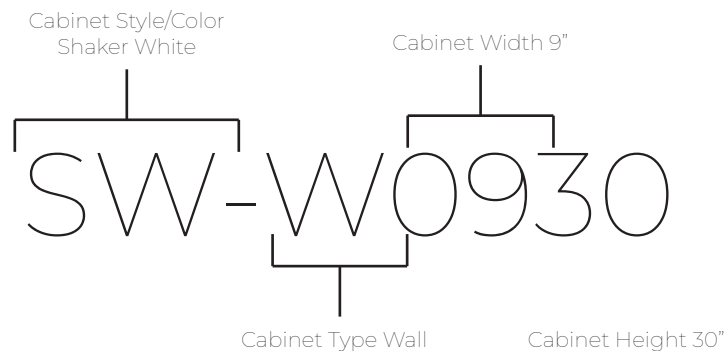

## Base Cabinets

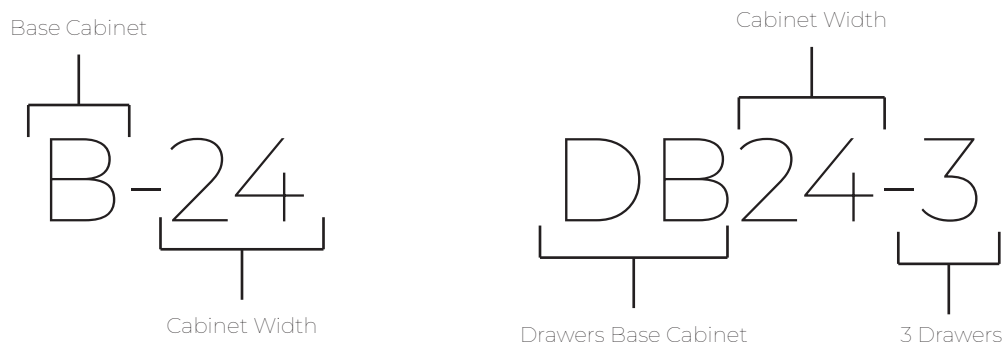

# HOW TO ORDER

## TO ORDER:

Specify the 2 letter door style, followed by the product number for the cabinet.

## Example:

SW-3-VDB12 Would be the product number used to order a Shaker White (SW) Vanity, 12" wide, 3 drawers.

## Vanity Cabinets

Vanity Sink Base Cabinet

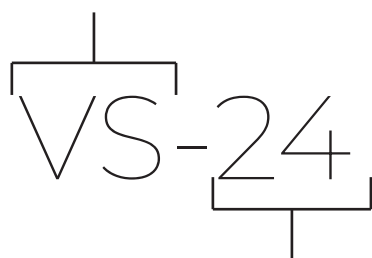

Cabinet Width

Cabinet Width

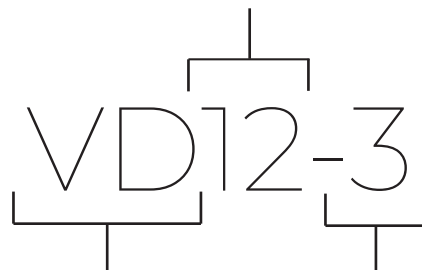

Vanity Drawer Base Cabinet

3 Drawers

## Tall Cabinets

Unity Pantry

Cabinet Height

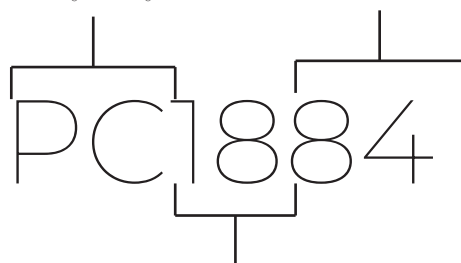

Cabinet Width



# WALL CABINETS

---

### 12" H Wall Cabinet Double Doors (Bridge)

Item Code		W	H	D
W3012	Cabinet Door	30	12	12
W3312	Cabinet Door	33	12	12
W3612	Cabinet Door	36	12	12

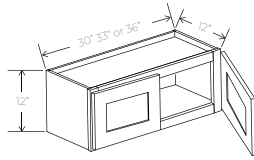

No shelves

### 30" H Wall Cabinet Single Door

Item Code		W	H	D
W0930	Cabinet Door	9	30	12
W1230	Cabinet Door	12	30	12
W1530	Cabinet Door	15	30	12
W1830	Cabinet Door	18	30	12
W2130	Cabinet Door	21	30	12

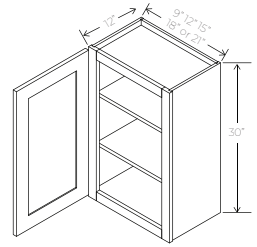

Two Adjustable Shelves

### 15" H Wall Cabinet Double Doors (Bridge)

Item Code		W	H	D
W3015	Cabinet Door	30	15	12
W3315	Cabinet Door	33	15	12
W3615	Cabinet Door	36	15	12

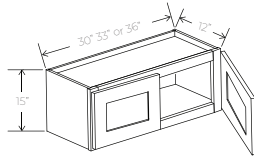

No shelves

### 30" H Wall Cabinet Double Doors

Item Code		W	H	D
W2430	Cabinet Door	24	30	12
W2730	Cabinet Door	27	30	12
W3030	Cabinet Door	30	30	12
W3330	Cabinet Door	33	30	12
W3630	Cabinet Door	36	30	12
W3930	Cabinet Door	39	30	12

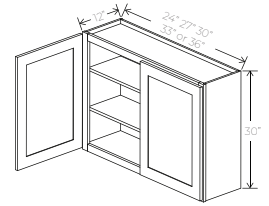

Two Adjustable Shelves **W3930 - only available in XLT collection**

### 18" H Wall Cabinet Double Doors (Bridge)

Item Code		W	H	D
W2418	Cabinet Door	28	18	12
W3018	Cabinet Door	30	18	12
W3318	Cabinet Door	33	18	12
W3618	Cabinet Door	36	18	12

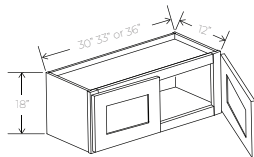

No shelves **W2418 - only available in XLT collection**

### 36" H Wall Cabinet Single Door

Item Code		W	H	D
W0936	Cabinet Door	9	36	12
W1236	Cabinet Door	12	36	12
W1536	Cabinet Door	15	36	12
W1836	Cabinet Door	18	36	12
W2136	Cabinet Door	21	36	12

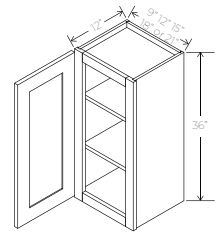

Two Adjustable Shelves

### 21" H Wall Cabinet Double Doors (Bridge)

Item Code		W	H	D
W3021	Cabinet Door	30	21	12
W3321	Cabinet Door	33	21	12
W3621	Cabinet Door	36	21	12

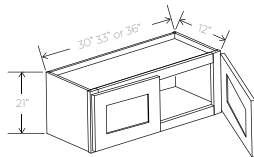

**\*\*SPECIAL ORDER\*\***

No shelves **Not available in XLT collection**

### 36" H Wall Cabinet Double Doors

Item Code		W	H	D
W2436	Cabinet Door	24	36	12
W2736	Cabinet Door	27	36	12
W3036	Cabinet Door	30	36	12
W3336	Cabinet Door	33	36	12
W3636	Cabinet Door	36	36	12

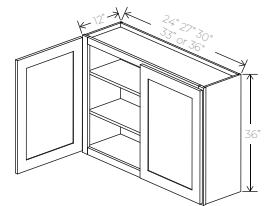

Two Adjustable Shelves

### 24" H Wall Cabinet Double Doors (Bridge)

Item Code		W	H	D
W3024	Cabinet Door	30	24	12
W3324	Cabinet Door	33	24	12
W3624	Cabinet Door	36	24	12

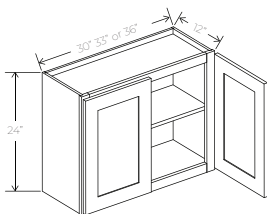

One adjustable shelf

### 42" H Wall Cabinet Single Door

Item Code		W	H	D
W0942	Cabinet Door	9	42	12
W1242	Cabinet Door	12	42	12
W1542	Cabinet Door	15	42	12
W1842	Cabinet Door	18	42	12
W2142	Cabinet Door	21	42	12

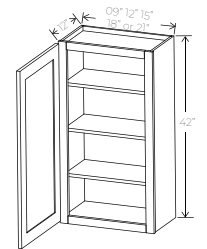

Three Adjustable Shelves

### 42" H Wall Cabinet Double Doors

Item Code		W	H	D
W2442	Cabinet Door	24	42	12
W2742	Cabinet Door	27	42	12
W3042	Cabinet Door	30	42	12
W3342	Cabinet Door	33	42	12
W3642	Cabinet Door	36	42	12

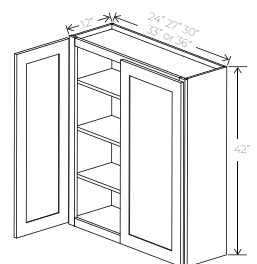

Three Adjustable Shelves

### 36" W Refrigerator Wall Cabinet Double Doors

Item Code		W	H	D
W301224	Cabinet Door	30	12	24
W301524	Cabinet Door	30	15	24
W301824	Cabinet Door	30	18	24
Only available in XLT collection				

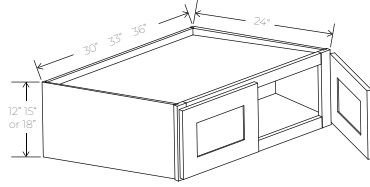

Item Code		W	H	D
W331224	Cabinet Door	33	12	24
W331524	Cabinet Door	33	15	24
W331824	Cabinet Door	33	18	24
Only available in XLT collection				

Item Code		W	H	D
W361224	Cabinet Door	36	12	24
W361524	Cabinet Door	36	15	24
W361824	Cabinet Door	36	18	24

No shelves

### 12" W Angle Wall Cabinet

Item Code		W	H	D
AW1230	Cabinet Door	12	30	12
AW1236	Cabinet Door	12	36	12
AW1242	Cabinet Door	12	42	12

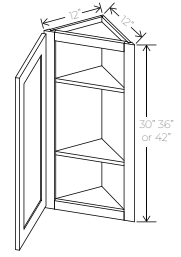

\*\*SPECIAL ORDER\*\*

Two Adjustable Shelves  
Three Adjustable Shelves  
Not available in slim collection

### 30" W Microwave Wall Cabinet

Item Code		W	H	D
WMC3030	Cabinet Door	30	30	12
WMC3036	Cabinet Door	30	36	12
WMC3042	Cabinet Door	30	42	12

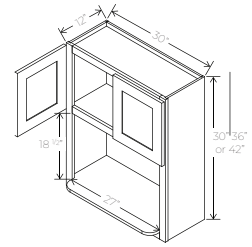

Opening Dimensions: 27W x 18"H  
Not available in slim collection

### 36" W Refrigerator Wall Cabinet Double Doors

Item Code		W	H	D
W362124	Cabinet Door	36	21	24
W362424	Cabinet Door	36	24	24

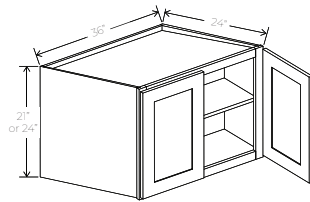

One Adjustable Shelf  
W362124 - not available in XLT collection

### 12" W Open End Shelf

Item Code		W	H	D
WES1230	Cabinet Door	12	30	12
WES1236	Cabinet Door	12	36	12
WES1242	Cabinet Door	12	42	12

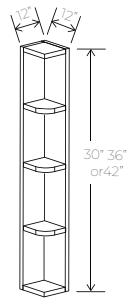

Item Code		W	H	D
WES630	Cabinet Door	6	30	12
WES636	Cabinet Door	6	36	12
WES642	Cabinet Door	6	42	12
Only available in XLT collection				

\*\*SPECIAL ORDER\*\*

Two Adjustable Shelves (30")  
Three Adjustable Shelves (36" or 42")  
Matching Color Interior  
Not available in slim collection

### 24" W Wall Diagonal Corner

Item Code		W	H	D
WDC2412	Cabinet Door	24	12	12
WDC2415	Cabinet Door	24	12	15
WDC2418	Cabinet Door	24	12	18

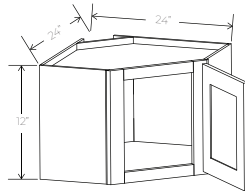

No shelves  
WDC2415 - not available in XLT collection

### 24" W Wall Diagonal Corner

Item Code		W	H	D
WDC2430	Cabinet Door	24	30	12
WDC2436	Cabinet Door	24	36	12
WDC2442	Cabinet Door	24	42	12

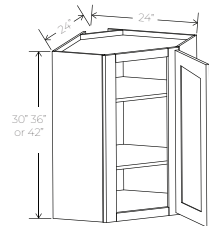

Color Matched Interior  
Two Adjustable Shelves (30" - 36")  
Two Adjustable Shelves (42")

### 18" H Wall Cabinet Double Doors

Item Code		W	H	D
WRC3018	Cabinet Door	30	18	12
WRC3618	Cabinet Door	36	18	12

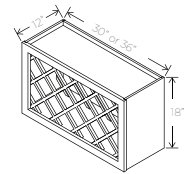

Can Install Vertically or Horizontally  
More options available per request

### 27" W Wall Blind Corner Cabinet

Item Code		W	H	D
WBC2730	Cabinet Door	27	30	12
WBC2736	Cabinet Door	27	36	12
WBC2742	Cabinet Door	27	42	12

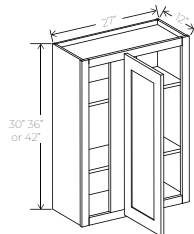

Two Adjustable Shelves (30" - 36")  
Three Adjustable Shelves (42")  
Can be Pulled for Exact Fit.

### 24" W Wall Easy Reach Corner Cabinet

Item Code		W	H	D
WER2430	Cabinet Door	24	30	12
WER2436	Cabinet Door	24	36	12
WER2442	Cabinet Door	24	42	12

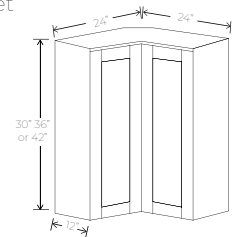

### 12" H Wall Cabinet Single Glass Door

Item Code		W	H	D
W1212GD	Cabinet Door	12	12	12
W1512GD	Cabinet Door	12	15	12
W1812GD	Cabinet Door	12	18	12
W2112GD	Cabinet Door	12	21	12

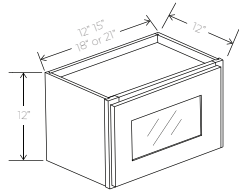

Clear Glass Included  
Color Matcher Interior

Request availability

### 36" H Wall Cabinet Single Glass Door

Item Code		W	H	D
W0936GD	Cabinet Door	9	36	12
W1236GD	Cabinet Door	12	36	12
W1536GD	Cabinet Door	15	36	12
W1836GD	Cabinet Door	18	36	12
W2136GD	Cabinet Door	21	36	12

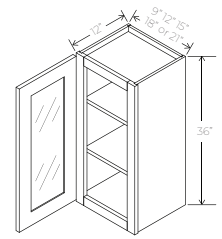

Clear Glass Included  
Two Adjustable Shelves

Request availability  
Not available in slim collection

### 12" H Wall Cabinet Double Glass Doors

Item Code		W	H	D
W2412GD	Cabinet Door	24	12	12
W2712GD	Cabinet Door	27	12	12
W3012GD	Cabinet Door	30	12	12
W3312GD	Cabinet Door	33	12	12
W3612GD	Cabinet Door	36	12	12

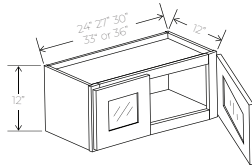

Clear Glass Included  
Color Matcher Interior

Request availability

### 36" H Wall Cabinet Double Glass Doors

Item Code		W	H	D
W2436GD	Cabinet Door	24	36	12
W2736GD	Cabinet Door	27	36	12
W3036GD	Cabinet Door	30	36	12
W3336GD	Cabinet Door	33	36	12
W3636GD	Cabinet Door	36	36	12

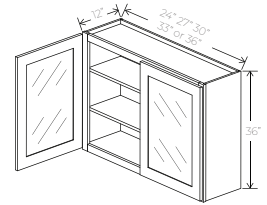

Clear Glass Included  
Two Adjustable Shelves

Request availability  
Not available in slim collection

### 18" H Wall Cabinet Single Glass Door

Item Code		W	H	D
W1218GD	Cabinet Door	12	18	12
W1518GD	Cabinet Door	15	18	12
W1818GD	Cabinet Door	18	18	12
W2118GD	Cabinet Door	21	18	12

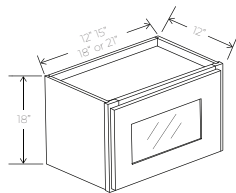

Clear Glass Included  
Color Matcher Interior

Request availability

### 42" H Wall Cabinet Single Glass Door

Item Code		W	H	D
W0942GD	Cabinet Door	9	42	12
W1242GD	Cabinet Door	12	42	12
W1542GD	Cabinet Door	15	42	12
W1842GD	Cabinet Door	18	42	12
W2142GD	Cabinet Door	21	42	12

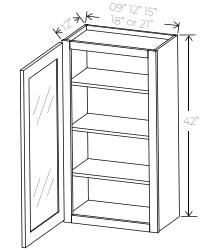

Clear Glass Included  
Three Adjustable Shelves

Request availability  
Not available in slim collection

### 18" H Wall Cabinet Double Glass Doors

Item Code		W	H	D
W2418GD	Cabinet Door	24	18	12
W2718GD	Cabinet Door	27	18	12
W3018GD	Cabinet Door	30	18	12
W3318GD	Cabinet Door	33	18	12
W3618GD	Cabinet Door	36	18	12

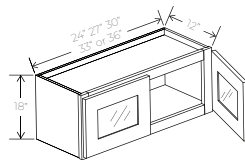

Clear Glass Included  
Color Matcher Interior

Request availability

**\*\*SPECIAL ORDER\*\***

### 42" H Wall Cabinet Double Glass Doors

Item Code		W	H	D
W2442GD	Cabinet Door	24	42	12
W2742GD	Cabinet Door	27	42	12
W3042GD	Cabinet Door	30	42	12
W3342GD	Cabinet Door	33	42	12
W3642GD	Cabinet Door	36	42	12

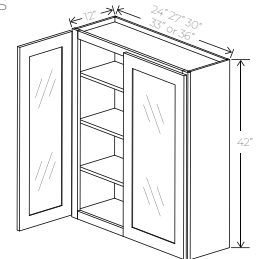

Clear Glass Included  
Three Adjustable Shelves

Request availability  
Not available in slim collection

### 30" H Wall Cabinet Single Glass Door

Item Code		W	H	D
W0930GD	Cabinet Door	9	30	12
W1230GD	Cabinet Door	12	30	12
W1530GD	Cabinet Door	15	30	12
W1830GD	Cabinet Door	18	30	12
W2130GD	Cabinet Door	21	30	12

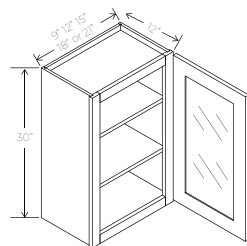

Clear Glass Included  
Two Adjustable Shelves

Request availability  
Not available in slim collection

### 24" W Wall Diagonal Corner Glass Door

Item Code		W	H	D
WDC2412GD	Cabinet Door	24	12	24
WDC2415GD	Cabinet Door	24	15	24
WDC2418GD	Cabinet Door	24	18	24

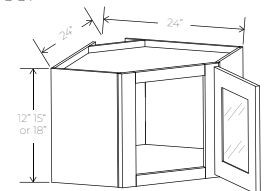

Clear Glass Included  
Color Matched Interior  
No Shelf

Request availability

### 30" H Wall Cabinet Double Glass Doors

Item Code		W	H	D
W2430GD	Cabinet Door	24	30	12
W2730GD	Cabinet Door	27	30	12
W3030GD	Cabinet Door	30	30	12
W3330GD	Cabinet Door	33	30	12
W3630GD	Cabinet Door	36	30	12

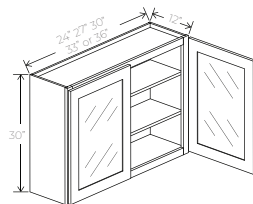

Clear Glass Included  
Two Adjustable Shelves

Request availability  
Not available in slim collection

### 24" W Wall Diagonal Corner Glass Door

Item Code		W	H	D
WDC2430GD	Cabinet Door	24	30	24
WDC2436GD	Cabinet Door	24	36	24
WDC2442GD	Cabinet Door	24	42	24

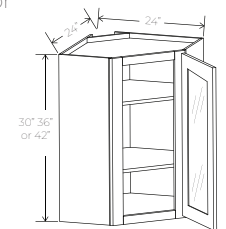

Clear Glass Included  
Color Matched Interior  
Two Adjustable Shelves (30" - 36")  
Two Adjustable Shelves (42")

Request availability  
Not available in slim collection



# BASE CABINETS

---

### Base Cabinet Single Door

Item Code	W	H	D
B09	09	34 1/2	24
B12	12	34 1/2	24
B15	15	34 1/2	24
B18	18	34 1/2	24
B21	21	34 1/2	24

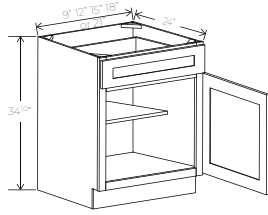

One Drawer B09 - not available in XLT collection

### Three Drawer Base

Item Code	W	H	D
DB12-3	12	34 1/2	24
DB15-3	15	34 1/2	24
DB18-3	18	34 1/2	24
DB21-3	21	34 1/2	24
DB24-3	24	34 1/2	24
DB27-3	27	34 1/2	24
DB30-3	30	34 1/2	24
DB33-3	33	34 1/2	24
DB36-3	36	34 1/2	24

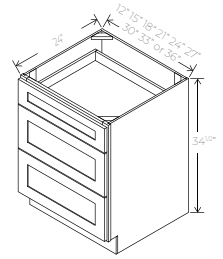

### Base Cabinet Double Doors

Item Code	W	H	D
B24	24	34 1/2	24
B27	27	34 1/2	24
B30	30	34 1/2	24

Double Drawer available in the XLT collection

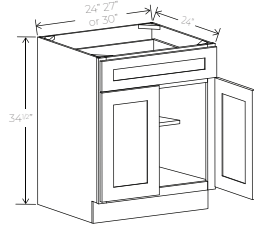

One Drawer

### Base Tray

Item Code	W	H	D
BT09	9	34 1/2	24
BT12	12	34 1/2	24

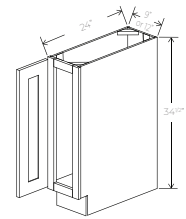

### Base Cabinet Double Doors

Item Code	W	H	D
B33	33	34 1/2	24
B36	36	34 1/2	24
B39	39	34 1/2	24
B42	42	34 1/2	24

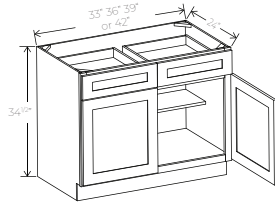

Two Drawers B39 - not available in XLT collection

Item Code	W	H	D
BFH12	12	34 1/2	24
BFH15	15	34 1/2	24
BFH18	18	34 1/2	24
BFH21	21	34 1/2	24
BFH24	24	34 1/2	24
BFH27	27	34 1/2	24
BFH30	30	34 1/2	24
BFH33	33	34 1/2	24
BFH36	36	34 1/2	24

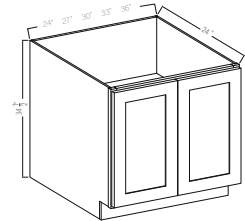

BFH - Only available in XLT collection

### Blind Corner Base Cabinet

Item Code	W	H	D
BBC36-39	36	34 1/2	24
BBC42-45	42	34 1/2	24

Install Range: 36" - 39"  
Install Range: 42" - 45"

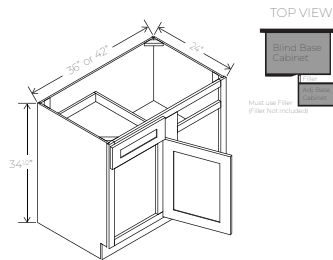

### Base End Shelf

Item Code	W	H	D
BES12	12	34 1/2	24

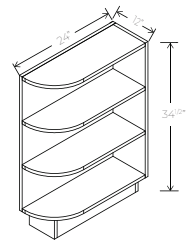

Not available in slim collection

### Easy Reach Base Cabinet

Item Code	W	H	D
LSB33	33	34 1/2	24
LSB36	36	34 1/2	24

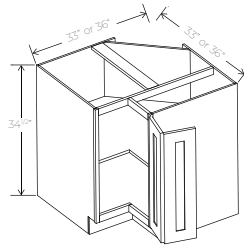

One Bi-Fold Door ERB - XLT collection code

### Sink Base

Item Code	W	H	D
SB30	30	34 1/2	24
SB33	33	34 1/2	24
SB36	36	34 1/2	24
SB42	42	34 1/2	24

Not available in XLT collection

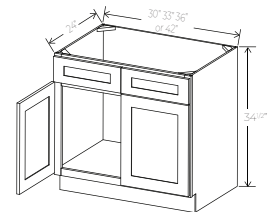

Two Dummy Drawers

### Two Drawer Base

Item Code	W	H	D
DB24-2	24	34 1/2	24
DB30-2	30	34 1/2	24
DB36-2	36	34 1/2	24

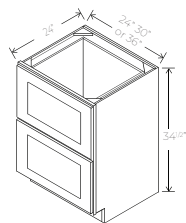

\*\*SPECIAL ORDER\*\*

### Famhouse Sink Base

Item Code	W	H	D
FSB36	36	34 1/2	24

Sink Trimout: 30"W x 7 1/2"H

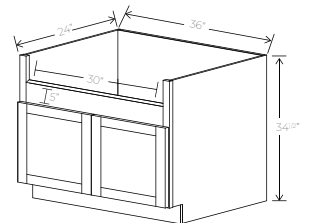



# Tall Cabinets

Utility pantry &  
Oven Cabinets



## 18" W Unity Pantry

Item Code		W	H	D
PC188424	Cabinet Top Door Bottom Door	18	84	24
PC189024	Cabinet Top Door Bottom Door	18	90	24
PC189624	Cabinet Top Door Bottom Door	18	96	24

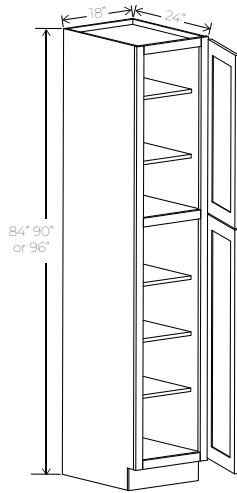

Two Doors  
Two Adjustable Top Shelves  
Three Bottom Shelves  
Note: Roll Out Shelf Kits Available

## 30" W Oven Pantry

Item Code		W	H	D
OC308424	Cabinet Door Drawer	30	84	24
Open Dimensions: 36W x 24H				
OC309024	Cabinet Door Drawer	30	90	24
Open Dimensions: 24W x 36H				
OC309624	Cabinet Door Drawer	30	96	24
Open Dimensions: 24W x 36H				

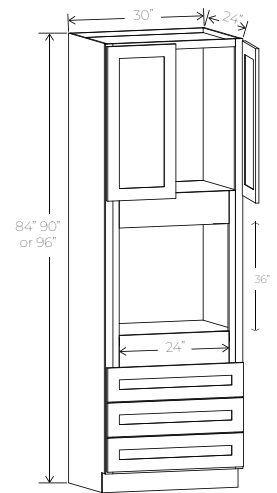

Two Doors  
One Large Open Shelf  
Three Bottom Drawers  
Note: Drawers May Be Removed to Accommodate Double Ovens

Not available in slim collection

## 24" W Unity Pantry

Item Code		W	H	D
PC248424	Cabinet Top Door Bottom Door	24	84	24
PC249024	Cabinet Top Door Bottom Door	24	90	24
PC249624	Cabinet Top Door Bottom Door	24	96	24

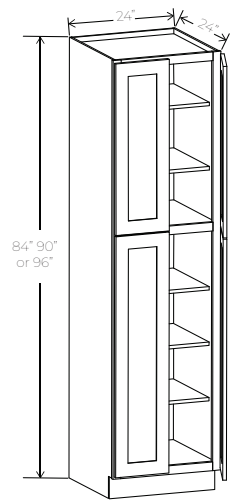

Four Doors  
Two Adjustable Top Shelves  
Three Bottom Shelves  
Note: Roll Out Shelf Kits Available

## 33" W Oven Pantry

Item Code		W	H	D
OC338424	Cabinet Door Drawer	30	84	24
Open Dimensions: 27W x 36H				
OC339024	Cabinet Door Drawer	30	90	24
Open Dimensions: 27W x 36H				
OC339624	Cabinet Door Drawer	30	96	24
Open Dimensions: 27W x 36H				

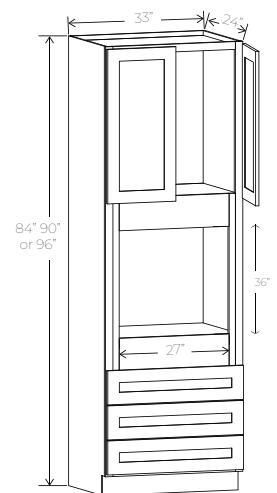

Two Doors  
One Large Open Shelf  
Three Bottom Drawers  
Note: Drawers May Be Removed to Accommodate Double Ovens

## 30" W Utility Pantry

Item Code		W	H	D
PC308424	Cabinet Top Door Bottom Door	30	84	24
PC309024	Cabinet Top Door Bottom Door	30	90	24
PC309624	Cabinet Top Door Bottom Door	30	96	24



Four Doors  
Two Adjustable Top Shelves  
Three Bottom Shelves  
Note: Roll Out Shelf Kits Available

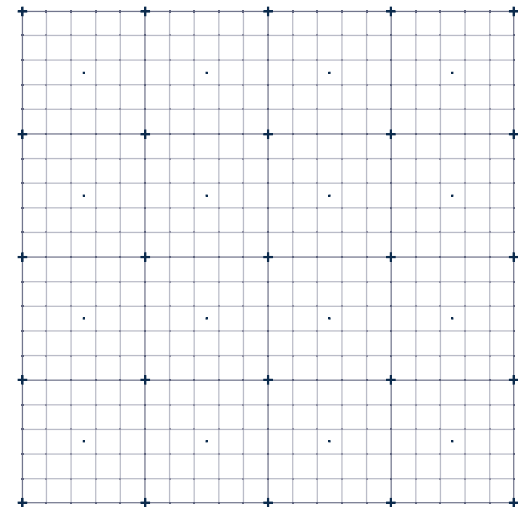

# Vanity & Cabinets





### Vanity Combo

Item Code		W	H	D
VSD36	Cabinet	36	34 1/2	21
	Door	17 3/4	22 1/2	3/4
	Outside Drawer	10 1/4	6 1/4	3/4
	Center Drawer	14 1/2	6 1/4	3/4
VSD42	Cabinet	42	34 1/2	21
	Door	20 3/4	22 1/2	3/4
	Outside Drawer	11 1/2	6 1/4	3/4
	Center Drawer	18	6 1/4	3/4
VSD48	Cabinet	48	34 1/2	21
	Door	23 3/4	22 1/2	3/4
	Outside Drawer	14 1/2	6 1/4	3/4
	Center Drawer	18	6 1/4	3/4

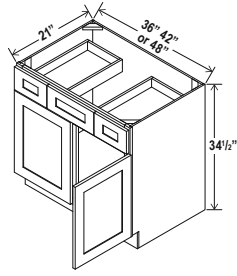

Only available in the XLT regular shaker and in the Pearl color

### Vanity Combo

Item Code		W	H	D
V3021DL	Cabinet	30	34 1/2	21
	Door	17 1/2	22 1/2	3/4
	Long Drawer	17 1/2	6 1/4	3/4
	Top Drawer	11 1/2	6 1/4	3/4
	Bottom Drawer	11 1/2	11 1/8	3/4
V3021DR	Cabinet	30	34 1/2	21
	Door	17 1/2	22 1/2	3/4
	Long Drawer	17 1/2	6 1/4	3/4
	Top Drawer	11 1/2	6 1/4	3/4
	Bottom Drawer	11 1/2	11 1/8	3/4

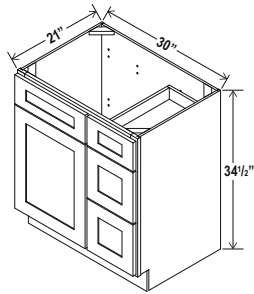
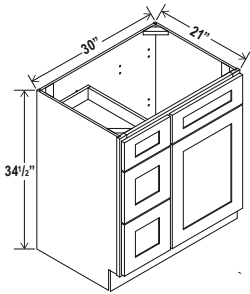

V3021 DL: 30" combo with drawers on left  
V3021 DR: 30" combo with drawers on right

Only available in the XLT regular shaker and in the Pearl color

### Vanity Combo

Item Code		W	H	D
V3321DL	Cabinet	33	34 1/2	21
	Door	20 1/2	22 1/2	3/4
	Long Drawer	20 1/2	6 1/4	3/4
	Top Drawer	11 3/4	6 1/4	3/4
	Bottom Drawer	11 3/4	11 1/8	3/4
V3321DR	Cabinet	33	34 1/2	21
	Door	20 1/2	22 1/2	3/4
	Long Drawer	20 1/2	6 1/4	3/4
	Top Drawer	11 3/4	6 1/4	3/4
	Bottom Drawer	11 3/4	11 1/8	3/4

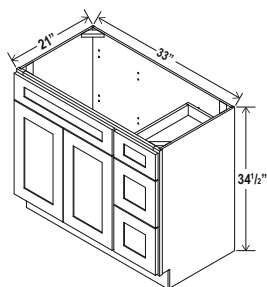
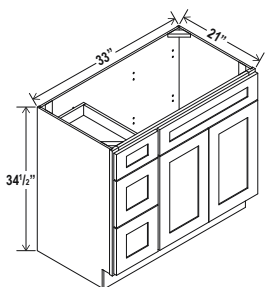

V3321 DL: 33" combo with drawers on left  
V3321 DR: 33" combo with drawers on right

Only available in the XLT regular shaker and in the Pearl color

### Vanity Combo

Item Code		W	H	D
V3621DL	Cabinet	36	34 1/2	21
	Door	11 3/4	22 1/2	3/4
	Long Drawer	23 1/2	6 1/4	3/4
	Top Drawer	11 1/2	6 1/4	3/4
V3621DR	Cabinet	36	34 1/2	21
	Door	11 3/4	22 1/2	3/4
	Long Drawer	23 1/2	6 1/4	3/4
	Top Drawer	11 1/2	6 1/4	3/4
	Bottom Drawer	11 1/2	11 1/8	3/4

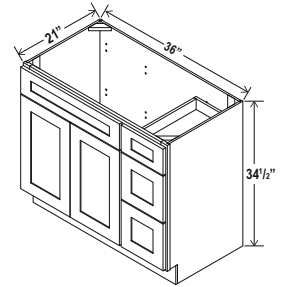
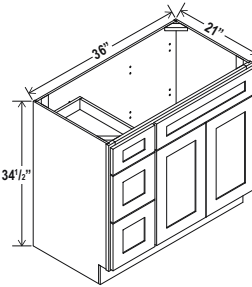

V3621 DL: 36" combo with drawers on left  
V3621 DR: 36" combo with drawers on right

Only available in the XLT regular shaker and in the Pearl color

# Accessories & Molding



Furniture Base

Item Code	L
FBM	96

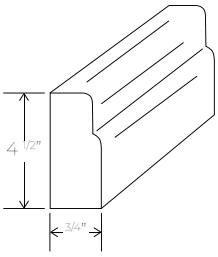

Cover Crown Moulding

Item Code	L
CM4	96

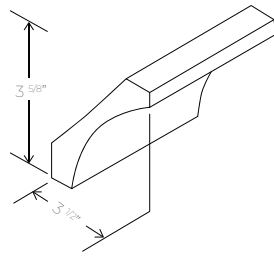

Angle Light Rail Moulding

Item Code	L
ALRMS	96

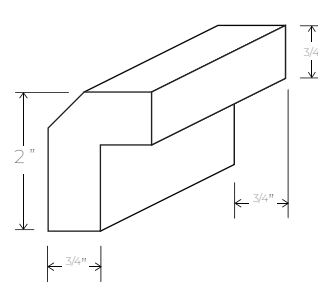

Light Rail Moulding

Item Code	L
LRM8	96

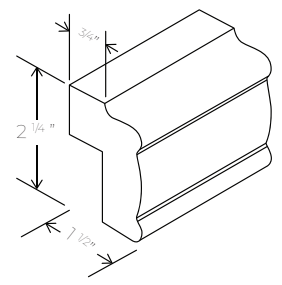

Decorative Moulding

Item Code	L
CM4R	96

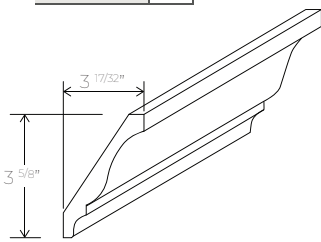

Crown Moulding

Item Code	L
CM2R	96

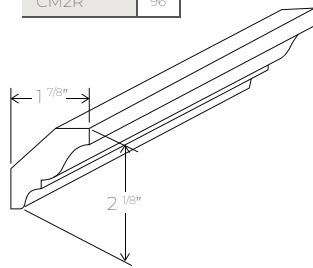

\*\*SPECIAL ORDER\*\*

Outside Corner Moulding

Item Code	L
OCM8	96

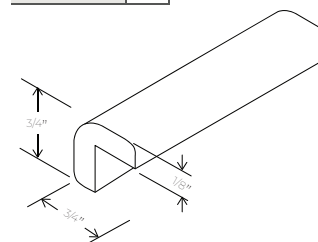

Shoe Moulding

Item Code	L
QRM	96

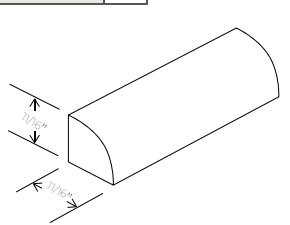

Scribe Moulding

Item Code	L
SMB(SCR)	96

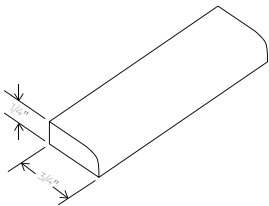

Batten Moulding

Item Code	L
BAM	96

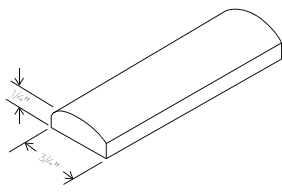

\*\*SPECIAL ORDER\*\*

Tail Filler

Item Code	L
F396	96
F696	96

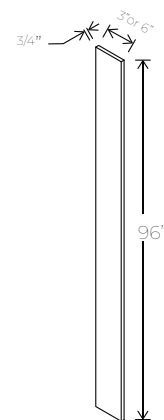

Toe Kick

Item Code	L
TKC	96

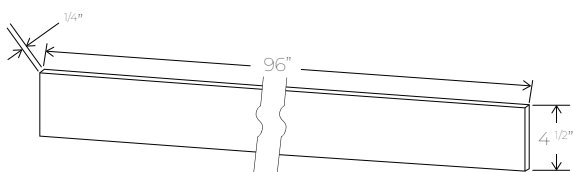

Filler

Item Code	L
F342	42
F642	42

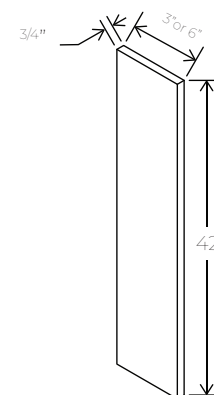





 HOMEPRO

# FRAMELESS EUROPEAN STYLE

EUROPEAN



# ROMA CLAY



Roma Clay / XHC-RC



# OXFORD WHITE



Oxford White Glossy / XHC-OW



# COSMO SAND



Cosmo Sand / XHC-CS



# PIANO GRAY



Piano Gray Glossy / XHC-PG



# FRAMELESS CABINETS

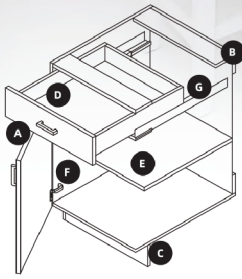

- A. 3/4" flat full overlay door and drawer panel\*
- B. 3/4" plywood construction with white-finish interior and exterior
- C. 3/4" toe kick board
- D. 3/4" white-finished plywood drawer box
- E. 3/4" Solid plywood laminated in white with adjustable pegs
- F. Adjustable soft-close concealed hinges
- G. Soft-close undermount drawer glide

\* Materials vary across different door styles.



## BASE FULL DOOR CABINET / DOOR & DRAWER CABINET

	Model	W	H	D
	B09F	9	34 1/2	24
	B12	12	34 1/2	24
	B15	15	34 1/2	24
	B18	18	34 1/2	24
	B21	21	34 1/2	24
	B24	24	34 1/2	24
	B27	27	34 1/2	24
	B30	30	34 1/2	24
	B33	33	34 1/2	24
	B36	36	34 1/2	24

## FULL DOOR CABINET/BLIND CORNER BASE CABINET

	Model	W	H	D
	DB12	12	34 1/2	24
	DB15	15	34 1/2	24
	DB18	18	34 1/2	24
	DB21	21	34 1/2	24
	DB24	24	34 1/2	24
	DB27	27	34 1/2	24
	DB30	30	34 1/2	24
	DB24-2	24	34 1/2	24
	DB27-2	27	34 1/2	24
	DB30-2	30	34 1/2	24
	DB33-2	33	34 1/2	24
	DB36-2	36	34 1/2	24

## FULL DOOR / BLIND CORNER BASE CABINET

	Model	W	H	D
	BBC36	36	34 1/2	24
	BBC39	39	34 1/2	24

## SINK BASE/ FARMHOUSE SINK BASE

	Model	W	H	D
	SB33	33	34 1/2	24
	SB36	36	34 1/2	24

## VANITY SINK BASE WITH DOUBLE DOORS

	Model	W	H	D
	V2421	24	34 1/2	21
	V3021	30	34 1/2	21
	V3621	36	34 1/2	21

## VANITY 3-DRAWERS BASE

	Model	W	H	D
	VDB1221	12	34 1/2	21
	VDB1521	15	34 1/2	21
	VDB1821	18	34 1/2	21
	VDB2421	24	34 1/2	21

## Frameless Cabinets with European Box

### BLIND CORNER WALL CABINET

	Model	W	H	D
	WBC2730	27	30	12
	WBC2736	27	36	12
	WBC2740	27	40	12

### DIAGONAL CORNER WALL CABINET

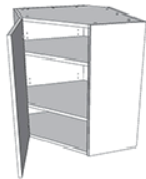
	Model	W	H	D
	WDC2430	24	30	12
	WDC2436	24	36	12
	WDC2440	24	40	12

### TALL SINGLE DOOR PANTRY CABINET BASE & TOP

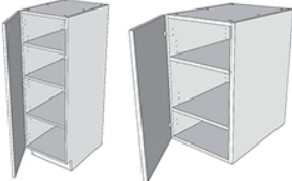
	Model	W	H	D
	PC1830T	12	34 1/2	21
	PC1836T	15	34 1/2	21
	PC1840T	18	34 1/2	21
	PC1854B	24	34 1/2	21

### OVEN CABINET BASE & TOP

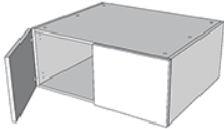
	Model	W	H	D
	OVD3012T	30	12	24
	OVD3018T	30	18	24
	OVD3022T	30	22	24
	OVD3072B	30	72	24

### TALL DOUBLE DOOR PANTRY CABINET BASE & TOP

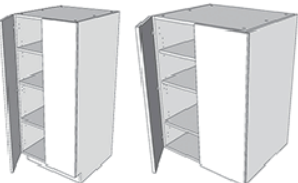
	Model	W	H	D
	PC2430T	24	30	24
	PC2436T	24	36	24
	PC2440T	24	40	24
	PC2454B	24	54	24
	PC3030T	30	30	24
	PC3036T	30	36	24
	PC3040T	30	40	24
	PC3054B	30	54	24

### EASY REACH WALL CABINET

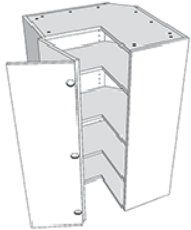
	Model	W	H	D
	WER2430	24	30	12
	WER2436	24	36	12
	WER2440	24	40	12

## Cabinet Glass Doors



GD-W1230	GD-W2130	GD-W3015	GD-W3615
GD-W1236	GD-W2136	GD-W3018	GD-W3618
GD-W1240	GD-W2140	GD-W3021	GD-W3621
GD-W1530	GD-W2430	GD-W3024	GD-W3624
GD-W1536	GD-W2436	GD-W3030	GD-W3630
GD-W1540	GD-W2440	GD-W3036	GD-W3636
GD-W1830	GD-W2730	GD-W3040	GD-W3640
GD-W1836	GD-W2736	GD-W3330	GD-WDC2430
GD-W1840	GD-W2740	GD-W3336	GD-WDC2436
		GD-W3340	GD-WDC2440

# Frameless Cabinets with European Box

## WALL DOUBLE DOORS CABINET (ABOVE REFRIGERATOR)

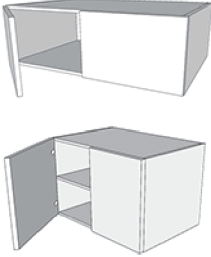
	Model	W	H	D
	W361224	36	12	24
	W361524	36	15	24
	W361824	36	18	24
	W362124	36	21	24
	W362424	36	24	24

## WALL MICROWAVE CABINET

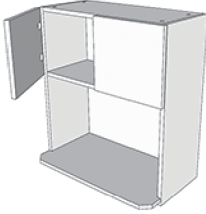
	Model	W	H	D
	WMC2730	27	30	12
	WMC2736	27	36	12
	WMC2740	27	42	12

## 30" H SINGLE DOOR/ DOUBLE DOOR WALL CABINET

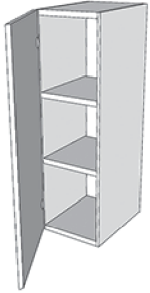
	Model	W	H	D
	W0930	9	30	12
	W1230	12	30	12
	W1530	15	30	12
	W1830	18	30	12
	W2130	21	30	12
	W2430	24	30	12
	W2730	27	30	12
	W3030	30	30	12
	W3330	33	30	12
	W3630	36	30	12

## 36" H SINGLE DOOR/ DOUBLE DOOR WALL CABINET

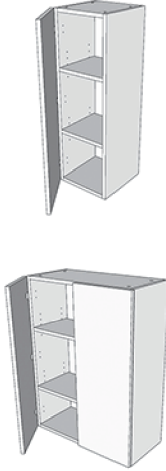
	Model	W	H	D
	W0936	9	36	12
	W1236	12	36	12
	W1536	15	36	12
	W1836	18	36	12
	W2136	21	36	12
	W2436	24	36	12
	W2736	27	36	12
	W3036	30	36	12
	W3336	33	36	12
	W3636	36	36	12



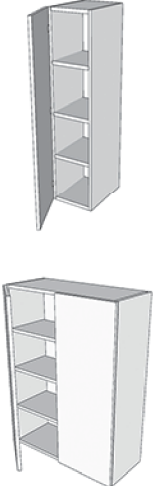

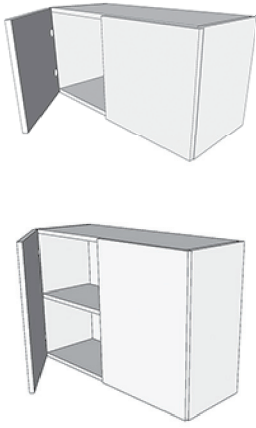

## 40" H SINGLE DOOR/ DOUBLE DOOR WALL CABINET







	Model	W	H	D
	W0940	9	40	12
	W1240	12	40	12
	W1540	15	40	12
	W1840	18	40	12
	W2140	21	40	12
	W2440	24	40	12
	W2740	27	40	12
	W3040	30	40	12
	W3340	33	40	12
	W3640	36	40	12

## DOUBLE DOOR WALL CABINET (ABOVE RANGE/ REFRIGERATOR)

	Model	W	H	D
	W3012	30	12	12
	W3015	30	15	12
	W3018	30	18	12
	W3021	30	21	12
	W3024	30	24	12
	W3612	36	12	12
	W3615	36	15	12
	W3618	36	18	12
	W3621	36	21	12
	W3624	36	24	12

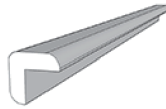
# Cabinets Accessories

	Model	Descriptions
	WF330	Wall Base Filler 3" x 30"
	WF336	Wall Base Filler 3" x 36"
	WF340	Wall Base Filler 3" x 40"
	WF640	Wall Base Filler 6" x 40"
	TF296	Tall Filler 2" x 96"
	TF396	Tall Filler 3" x 96"
	TF696	Tall Filler 6" x 96"
	EB-ROT18	Roll Out Tray w/Soft-Close Slides Apply to 18"W-36"W Frameless Cabinets
	EB-ROT21	
	EB-ROT24	
	EB-ROT27	
	EB-ROT30	
	EB-ROT33	
	EB-ROT36	
	TK	Toe Kick 4 1/2" x 1/2" x 8"
	SM	Scribe Moulding 3/4" x 1/8" x 8"
	Refrigerator Panel PNL 34.5x96x3/4"	Refrigerator Panel 24" x 96" x 3/4 "
		Island Skin Panel Thick 34.5" x 96" x 3/4 "
	BDP 25 3/4" x 34.5" x 3/4" Base Decorative Panel	Base Decorative Panel 25 3/4" x 34.5" x 3/4"
	BIP 26 1/2" x 34.5" x 3/4" 26 1/2" x 34.5" x 3/4" Island Decorative Panel	Base Decorative Island Panel 26 1/2" x 34.5" x 3/4" 26 1/2" x 34.5" x 3/4"
	WFP1230	Wall Finish Panel 12" x 30"
	WFP1236	Wall Finish Panel 12" x 36"
	WFP1240	Wall Finish Panel 12" x 40"
	WDP30	Wall Decorative Panel 12" X 30"
	WDP36	Wall Decorative Panel 12" X 36"
	WDP40	Wall Decorative Panel 12" X 40"

	Model	Descriptions
	LAZ33	Two Shelf Metal Wire Lazy Susan Set
	LAZ36	Apply to Cabinet BLS33/BLS36
	B09TR	Spice Rack Kit works with B09F
	OCM	Outside Corner Moulding 3/4" x 1/8" x 8"
	FP24	Skin Panel 24" x 96" x 1/8"
	FP34.5	Island Skin Panel 34.5" x 96" x 1/8"
	LM8	Light Moulding 1 3/8" x 7/8" x 8"
	OS36	Open Shelf 36" Long
	OS60	Open Shelf 60" Long
	BTB15	Trash can Apply to Frameless Cabinet
	BTB18	

# OUR WEBSITE

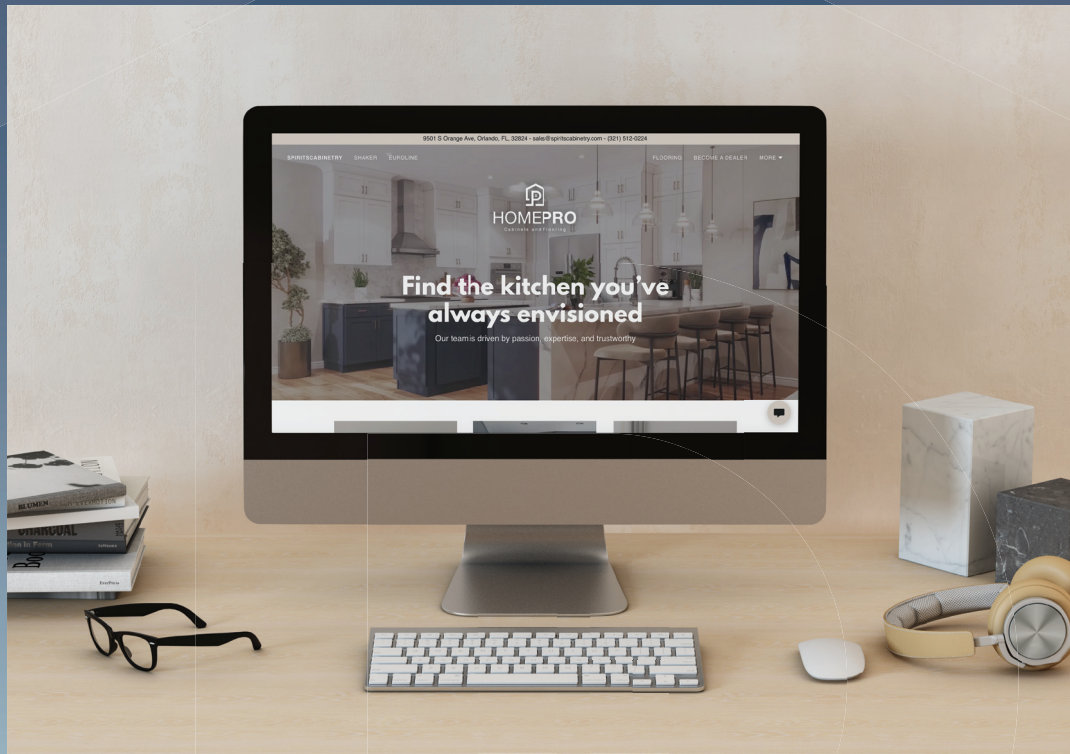

On our website, you can find all of our forms conveniently located in the “Library” section.

Additionally, you can explore our extensive collections and discover a wealth of resources tailored to your needs.

If you require assistance, you can also find “Contact” information for your Sales Representative or reach out to us directly through our office number.

# SALES POLICY



## SALES POLICY - PAYMENT, WARRANTY AND RETURN

V08.09252024

### PAYMENT

- We accept cash, ZELLE to [zelle@homeproonline.com](mailto:zelle@homeproonline.com) and all credit cards with additional charge.

### WARRANTY

- We provide 12 (twelve) months warranty for our manufactured products.
- As soon you open the box and notice any problem, notify by email your sales representative.
- Please check the list and items before signing on packing slips when you pick up.
- Once the Packing Slip is signed showing that you received all items, you are responsible for any missing items afterward.
- Claim for concealed damage must be reported along with pictures within 72 hours upon receiving time.
- For factory defects or missing parts, we need quality pictures before assembly.
- Provide the sales order number or invoice number, which cabinet SKU and what specific part is damaged.
- A small scratch can potentially be fixed with a touch up kit. If you are unable to repair, then we can replace.
- We do not replace the full cabinet. We only replace the damaged part, please be sure to provide complete information to expedite your claim process.
- If we have not provided a floor plan layout for your order, we will not accept responsibility or liability for the accuracy of the items on the invoice.

### SPECIAL ORDERS AND ITEMS

- Every item other than Shaker White Cabinets (regular Base and Wall), will be considered Special Order.
- Items out of stock, special orders and accessories will be available to pick up or delivery up to 21 (twenty-one) days after order confirmation, upon availability.
- All special orders must be paid upfront and the payment itself does not reflect product availability or order confirmation.
- Pick up after 7 days of the scheduled pickup date, there will be a \$50 daily storage fee charged after.

### RETURNS

- Absolutely no returns on all assembled/installed and special-order cabinets.
- Absolutely no returns on Fillers, Moldings, Refrigerator panels, Shelf boards, Toe kicks and Back panels.
- We only issue store credit towards your account instead of monetary refunds.
- There will be a cancelation fee of \$50 on canceling orders and changing more than 5 items per order.
- We will charge 30% restocking fee for every return or refund.
- We will only accept returned items prior to 14 (fourteen) days after the delivery.
- We will not accept return of items that have been damaged by the transportation, assembled, or installed prior to the item's return.
- All returns must be on the original package.

### DELIVERY

- We prefer to have you picking up your items at our warehouse.
- We charge \$150,00 to deliver items in Orlando. Out of Orlando, please ask.
- We only deliver on Wednesdays and Fridays, and we are free to move our schedule to better fit our need.







We are HomePro.  
Your Partner in Every Project.



## Get In Touch ---



OFFICE: 321-512-0224



HOMEPROONLINE.COM



cs@homeproonline.com



9501 S ORANGE AVE,  
ORLANDO, FL 32824